

# **DURA** **FIT**<sup>TM</sup>

# **DIESEL** **TECH**<sup>TM</sup>

**ENGINEERED TO LAST**



MUFFLERS · PIPES · ACCESSORIES · DOCs · DPFs  
SILENCIEUX · TUYAUX · ACCESSOIRES  
SILENCIADORES · TUBOS · ACCESORIOS

## **Heavy Duty Exhaust Catalog**

# TABLE OF CONTENTS:

## Heavy Duty DPF & DOC



DuraFit Catalog .....	2
DPF (Class 7-8) .....	4
DOC (Class 7-8) .....	8
Clamps .....	10
Gaskets .....	12
DPF/DOC OE Interchange: .....	14
Warranty: .....	28

## Heavy Duty Exhaust Catalog: Including Light/Medium Duty DPF & DOC



DieselTech Catalog.....	29
DPF and DOC (Class 3-6).....	30
Clamps.....	32
Flex Tubing.....	39
Connectors, Adapters & Reducers.....	42
Elbows, Splitter T & Y-Pipes .....	46
Straight Tubing .....	50
Stacks.....	51
Tailspouts & Stack Brackets .....	53
Shields, Clamp Kits & Rain Caps .....	54
Brackets & Hangers .....	56
Flanges & Gaskets.....	60
Rubber Intake Parts .....	61
Mufflers, Resonators & Spark Arrestors .....	64
Universal Catalytic Converters.....	72
OEM Pipes .....	74
Medium/Heavy Duty Truck Applications .....	84
School Bus Applications.....	120
Farm Tractor Applications.....	169
OE Interchange .....	190
Aftermarket Interchange .....	200
Farm Tractor Interchange .....	235
<b>Appendix:</b> .....	
General Information .....	236
Footnotes.....	250
Abbreviations.....	251



**DESIGNED TO FIT. BUILT TO LAST.™**

*OEM Replacement Emission Technologies*

# Diesel Particulate Filters & Oxidation Catalysts

Reference Guide / Mini Catalog



**HD CLASS 7 & 8**

# Diesel Particulate Filters (DPF) & Oxidation Catalysts (DOC)

WHETHER IT'S FOR OVER-THE-ROAD LONG HAUL TRUCKS, route trucks, school or municipal buses, refuse trucks or construction vehicles, DuraFit™ is dedicated to providing you with replacement diesel particulate filters (DPFs) and Diesel Oxidation Catalysts (DOCs) that provide exceptional durability and service life.



We offer exact-fit replacement DPFs and DOCs for almost every major diesel OEM. And DuraFit units meet or exceed all requirements and are engineered to fit precisely and come with required gaskets – getting your equipment back working faster.

Included gaskets reduce installation time and cost

Precision-crafted flanges help guard against leakage

Exact fit for easy installation

Genuine OEM substrates enhance durability

Upgraded stainless steel canisters improve durability and resist corrosion



- 100% new units and no core required
- Stringent field testing for durability and extended service life
- Emission compliant for 2007 and newer models
- Quick delivery (typically 1-2 business days)
- 3 year Nationwide unlimited mileage warranty



# DPFs HD CLASS 7 & 8

## Diesel Particulate Filters Cross Reference Guide

### Diesel Particulate Filters

OEM	Engine Model	OEM P/N	DuraFit P/N	Gasket P/N	Clamp P/N
<b>Caterpillar</b>	C7	305-4565 / 305-6294 / 10R-6084	C17-0069	E30-0119	E27-0087
	C7	291-8513/ 294-8690/ 10R-6085/ 290-7307/ 0117438/ A-CPXH-CH1408	C17-0122	TBD	TBD
	C7/C9/C13	291-8515 / 10R-6087 / 294-8692 / 309-6991 / C0032-SA / A-CPXH-CN1505	C17-0052	E30-0123	TBD
	C7/C15	304-7579 / 304-7578 / 10R-6082 / A-CPXH-CK1406	C17-0033	E30-0119	TBD
	C9	220-6054 / 250-0630 / 261-2318 / 264-1556 / C0011-SA	C17-0050	E30-0121	TBD
	C9/C13/C15	304-7502 / 304-7519 / 10R-7056 / C0037-SA / ACPXH-CQ1501	C17-0034	E30-0120	TBD
	C9/C13/C15	290-0045 / 301-7856 / 10R-6088 / C0013-SA / A-CPXH-CQ1702-K	C17-0040	E30-0123	TBD
	C13/C15	293-9990 / 1733481 / 291-8519 / 294-8694 / 10R-6089 / C0012-SA / A-CPXH-CQ1704-K	C17-0051	E30-0120	TBD
<b>Cummins</b>	ISB	Q621386 / Q621386A / 4965287NX / C0023-SA / A-CEXH-BG1101-K	C17-0029	E30-0116	E27-0087
	ISB	4965227NX / Q621376 / C0024-SA / A-CEXH-BG1102-K	C17-0058	E30-0116	E27-0087
	ISB	2871461NX / Q629355 / C0128-SA / A-CEXH-BG1104-K	C17-0081	E30-0116	E27-0087
	ISB	529560300 / 5295603NX / A040M135 / (EPN A040M135)/ C0161-SA / A-CEXH-BGF006	C17-0091	E30-0116	E27-0087
	ISC	4965229NX / 4965286NX / 4969838NX / Q621371 / Q623316 / Q623804 / Q621377 / 674-2006 / C0003-SA / A-CEXH-CJ1203-K	C17-0042	E30-0117	E27-0084
	ISC	061794A0A / 619733 / 619496 / 3103617NX / 3976606NX / 3978026NX / 3999661NX / 3999662NX / Q619725A / Q617940 / Q619496 / Q619733 / Q619495 / Q619725 / Q617940A / Q165338 / Q619495A / Q619725A / Q619733A / C0026-SA / A-CEXH-CJ1202-K	C17-0054	E30-0117	E27-0084
	ISC	5295606NX / 5295606RX / A041D445 / C0136-SA / A-CEXH-LJ1207-K	C17-0086	E30-0117	E27-0084
	ISC/ISL	2871459NX / Q629361 / C0125-SA / A-CEXH-CJ1205-K	C17-0074	E30-0117	E27-0084
	ISL	2871463NX / Q629362 / C0062-SA / C-CEXH-LJ1204-K	C17-0030	E30-0117	E27-0084
	ISL/ISM	4965244NX / Q621378 / 4352923NX / 4352921NX / 2880169NX / 2880281NX / A029C896 / A29J952 / A047B789 / A047B792 / C0004-SA / A-CEXH-MN1002-K	C17-0031	E30-0118	E27-0083
	ISM	4352989NX / 4965224NX / A046F194 / Q621402 / C0022-SA / A-CEXH-MN1003-K	C17-0043	E30-0118	E27-0083
	ISM	4965218NX / 4352922NX / A047B790 / Q621375 / C0045-SA / A-CEXH-MN1004-K	C17-0047	E30-0118	E27-0083
	ISM	2888231NX / 5289769NX / 5289769RX / 6303922NX / 9303922RX / 2871838NX / 2888231NX / 5289769NX / 5303922NX / A030S045 / A035N640 / A042U501 / Q629289 / C0145-SA	C17-0087	E30-0156	E27-0091
	ISM	5273093NX / A030K896 / 5273093 / C0090-SA	C17-0088	E30-0118	E27-0083
	ISM/ISL	3817962C91 / 4936737NX / 4352920NX / 4965055NX / A047B793 / Q165489 / Q620940 / C0018-SA / A-CEXH-MN1001-K	C17-0038	E30-0118	E27-0083
	ISX	4388409RX / 4969702NX / 5283669NX / 5297522NX / 5283778NX / 5297990NX / 4965129NX / 4965226NX / 5969700NX / 4969701NX / 4388410NX / A029C893 / A034X191 / A034X329 / A041M783 / A041L187 / A051G2701 / A051G271 / Q165573 / Q621334 / Q621405 / Q621936 / Q621937 / 674-2000 / C0001-SA / A-CEXH-XN1101-K / A-CEXH-XN1105-K	C17-0032	E30-0118	E27-0083
	ISX	2871578NX / Q629458 / C0066-SA / A-CEXH-XN1104-K	C17-0037	E30-0118	E27-0083

\*Not legal for sale or use in the state of California or areas where California emissions compliance is required.

# DPFs **HD CLASS 7 & 8**

## Diesel Particulate Filters Cross Reference Guide

### Diesel Particulate Filters

OEM	Engine Model	OEM P/N	DuraFit P/N	Gasket P/N	Clamp P/N
Cummins	ISX	4388409RX / 4969702NX / 5283669NX / 5297522NX / 5283778NX / 5297990NX / 4965129NX / 4965226NX / 5969700NX / 4969701NX / 4388410NX / A029C893 / A034X191 / A034X329 / A041M783 / A041L187 / A051G2701 / A051G271 / Q165573 / Q621334 / Q621405 / Q621936 / Q621937 / 674-2000 / C0001-SA / A-CEXH-XN1101-K / A-CEXH-XN1105-K	C17-0032	E30-0118	E27-0083
	ISX	2871578NX / Q629458 / C0066-SA / A-CEXH-XN1104-K	C17-0037	E30-0118	E27-0083
	ISX	4969703NX / 5283799NX / 5297989NX / 4965322NX / 20970295 / 5965305NX / 4388411RX / 4965129D / A0034X344 / A041M795 / A051G272 / Q621320 / Q621938 / 674-2002 / C0021-SA / A-CEXH-XN1102-K / A-VPTH-VN1203-K	C17-0044	E30-0118	E27-0083
	ISX	Q629477 / 2871581NX / C0033-SA / A-CEXH-XN1103-K	C17-0068	E30-0118	E27-0083
	ISX	5295605NX / A040M139 / C0153-SA / A-CEXH-LJ1206-K	C17-0073	E30-0117	E27-0084
	ISX	5295609NX / A041D448 / C0107-SA / A-CEXH-XN1107-K	C17-0079	E30-0118	E27-0083
	ISX	5295604RX / 5295604NX / A034H646 / A040M143 / C0134-SA / A-CEXH-XN1106-K	C17-0084	E30-0118	E27-0083
Detroit / Diesel / Mercedes	MB OM926	A6804904392 / A6804905792 / A6804910094 / A6804906192 / R23537521 / RA6804908792 / RA6804910097 / 23537521 / A6804910097 / A6804908792	C17-0039	E30-0137	E27-0096
	SERIES 50	23535827	C17-0066	E30-0117	E27-0084
	SERIES 60	A6804910594 / A6804908692 / A6804910294	C17-0036	E30-0129	E27-0089
	DD13/DD15	EA6804910794 / A6804910794 /	C17-0067	E30-0140	E27-0085
	DD13/DD15/ DD16	A6804910894 / EA6804910894 / A6804903792 / RA6804903792 / A0004903792 / RA0004903792 / A0014903492 / RA0014903492 / A0004903692 / A0014903592 / A6804913494 / A6804913594 / EA0014903492	C17-0076	E30-0147	E27-0088 / E27-0092
	Mack / Volvo	MP7	85003793 / 20231111 / 21048577 / 85000899 / 21817835 / 85125682 / 20992181 / 21804785 / 21395825 / 85124613 /	C17-0035	E30-0129
MP7/D11		20853859 / 21850651 / 85001366 / 5283799NX / 4965305NX / 5297989NX / 4969703NX / 20970295 / 4965322NX / 2388411RX / 44965129D / 20863859 / 20970295 / 85001352 /	C17-0044	E30-0118	E27-0083
D11/D13/D16		20864127 / 21850658 / 85000726	C17-0045	E30-0127	E27-0085
MP7/MP8/ D11/D13		21905492 / 20864558 / 85001367 / 20864558	C17-0046	E30-0118	E27-0083
MP8		20864316 / 21851879 / 85000725 / 21905428	C17-0048	E30-0127	E27-0084
MP8/D13		21756506 / 22810503 / 22413832 / 21756429 / 21755606 / 22806823 / 85126281 / 21415912 / 21212428 / 21212431 / 21212426 / 22810502 / 21756429	C17-0057	E30-0130	E27-0090
MP7		21395825 / 21395826	C17-0075	E30-0129	E27-0089
MP7/MP8/ D11/D13		21471269 / 21395827 / 22761989 / 22342601 / 85124653 / 21393279 / 21082068 / 22342601 / 22761989	C17-0089	E30-0129	E27-0089

\*Not legal for sale or use in the state of California or areas where California emissions compliance is required.

# DPFs HD CLASS 7 & 8

## Diesel Particulate Filters Cross Reference Guide

### Diesel Particulate Filters

OEM	Engine Model	OEM P/N	DuraFit P/N	Gasket P/N	Clamp P/N
<b>Navistar / MaxxForce / International</b>	7/DT	2594131R91 / 2010832R91 / 2594131C91 / A00574039	C17-0041	E30-0124	E27-0086
	7/DT	2594165R91 / 5010830R91 / 2594165C91	C17-0053	E30-0124	E27-0086
	7/DT	2605123C1 / 5010847R1 / 2593981R91 / 5010836R91 / 2604873C91 / 2605123C91 / 5010847R91 / 2594022C91 / A00383921 / 2593981C91 / 2594022C91 / 2604873C91 / 82003341	C17-0060	E30-0125 E30-0126	NOT REQUIRED
	7/DT	2594356C91 / 2594356R91 / 5010834R91	C17-0061	E30-0125 E30-0126	NOT REQUIRED
	7/DT	2605837C1 / 2605124C1 / 5010850R1 / 2605124C1	C17-0082	E30-0124	E27-0086
	9	2604870C91 / 2605796C91 / 2611630C91 / 5010852R1 / 2604870R91 / 5010846R1 / A00317258 / A00317258	C17-0062	E30-0125 E30-0126	NOT REQUIRED
	9/10/DT	5010853R1 / 2604430R91 / 5010843R1 / A00420195 / 2613113C91 / 82002806 / 3712647C91 / 2604430C91 / 2605039C91 / 2612521C91 /	C17-0064	E30-0124	E27-0086
	11/13	Q622369 / 2596665R91 / 5010851R1	C17-0055	E30-0118	E27-0083
	13	201229C91 / Q621944 / 2601229R91 / 5010848R1	C17-0032	E30-0118	E27-0083
	13	3859691C94 / CP232717 / 2604830C91 / 2604046C91 / 2604830R91 / 5010845R1	C17-0056	E30-0118	E27-0094
	13	2604823R91 / 5010844R1 / 2604823C91 / 2603961C91 / 3859549C93 / 2603961C91	C17-0059	E30-0118	E27-0084
	13	2510616C91 / 5011031R91 / 2511460C1	C17-0079	E30-0118	E27-0083
OEM	Engine Model	OEM P/N	DuraFit P/N	Gasket P/N	Clamp P/N
<b>PACCAR</b>	ISB	2871462NX / Q629356	C17-0080	E30-0116	E27-0087
	MX	1906311PEX	C17-0093	TBD	TBD
	MX-13	1827739PEX	C17-0037	E30-0118	E27-0083
	MX-13	1827310PEX / 2871581NX	C17-0068	E30-0118	E27-0083
	PX8	4969838NX / Q649206	C17-0042	E30-0117	E27-0084
OEM	Engine Model	OEM P/N	DuraFit P/N	Gasket P/N	Clamp P/N
<b>Isuzu</b>	4HK1-TC	898155142 / 8981551420 / 898155142-0 / 897608056	C17-0070	E30-0152/ E30-0153	NOT REQUIRED
	4HK1-TC	8981470660 / 8981470660RX	C17-0071	E30-0151 / E30-0152	NOT REQUIRED
	6HK1	897608057 / 8-97608-057-3 / 8-97608057-0 / 8976080573 /	C17-0072	E30-0153	NOT REQUIRED
OEM	Engine Model	OEM P/N	DuraFit P/N	Gasket P/N	Clamp P/N
<b>Hino</b>	J08E (Combined DPF and DOC)	S1805E0270 / S1850E0281	C17-0083	E30-0158	NOT REQUIRED
	J08E	S1850E0B00 / S1850E0580 / S1805E0B5	C17-0092	TBD	NOT REQUIRED
OEM	Engine Model	OEM P/N	DuraFit P/N	Gasket P/N	Clamp P/N
<b>Nova Bus</b>	Nova Bus	N8894071	C17-0031	E30-0118	E27-0083

\*Not legal for sale or use in the state of California or areas where California emissions compliance is required.

## DPF Styles **HD CLASS 7 & 8**

Diesel Particulate Filters  
Reference Purposes Only



## How To Assemble DPF, DOC, Gaskets, and Clamps

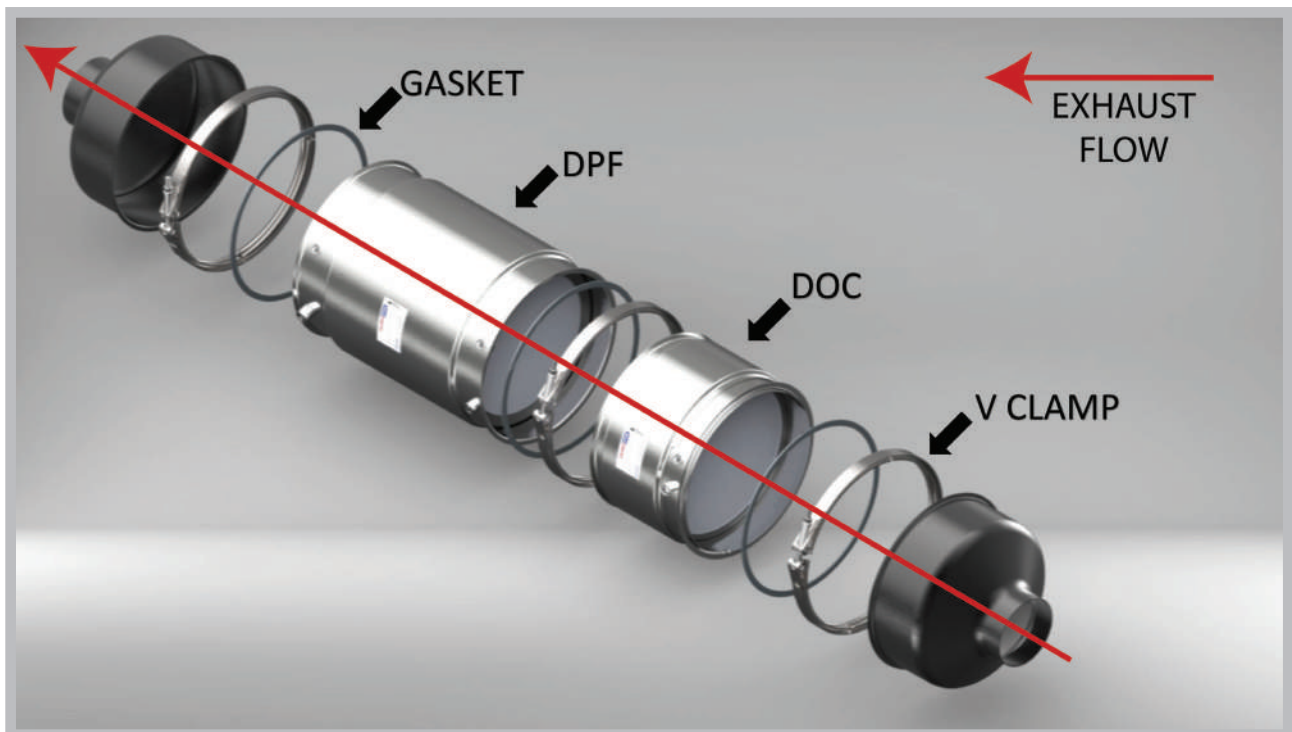

\*Not legal for sale or use in the state of California or areas where California emissions compliance is required.



# DOCs HD CLASS 7 & 8

## Diesel Oxidation Catalysts Cross Reference Guide

### Diesel Oxidation Catalysts

OEM	Engine Model	OEM P/N	DuraFit P/N	Gasket P/N	Clamp P/N
<b>Cummins</b>	ISB	5287480NX / 4965285NX / A035H236 / Q621385	C20-0001	E30-0116	E27-0087
	ISC	4965284NX / 5287496NX / A035H295 / Q621275	C20-0002	E30-0117	E27-0084
	ISC	4965352NX / 5287491NX / 4965352RX / 5287491RX / A035H299 / Q621560	C20-0016	E30-0117	TBD
	ISC/ISL	CPN2871923 / EPN A029B190 / 26326120259	C20-0011	E30-0117	E27-0084
	ISL	A029S790 / 2880589NX / 26266120055	C20-0012	E30-0117	TBD
	ISL/ISM	4936736NX / 4969719NX / 5287519NX / 4965243NX / A035H544 / 5287191NX	C20-0017	E30-0118	E27-0083
	ISM	4965243NX / 5287191NX / A035G674 / Q621301	C20-0003	E30-0118	E27-0083
	ISM	4965223NX / A035H536 / Q621401	C20-0004	E30-0118	E27-0083
	ISX	2888249NX / 4969542NX / 4965317NX / A030W858 / Q620970 / Q621430 / Q621503	C20-0005	E30-0118	E27-0083
	ISX	2888248NX / 4965225NX / A030W857 / 4330064NX / A047B275 / Q621404	C20-0006	E30-0118	E27-0083
	ISX	4965304NX / 2888247NX / A035W856 / Q621319	C20-0007	E30-0118	E27-0083
	ISX	CPN 2880165NX / A029A324 / 2880165NX	C20-0014	E30-0118	TBD
	ISX	2880506NX / 2880385NX	C20-0015	E30-0118/ E30-0144	E27-0083
	ISX	2888261NX / 4969718NX / 4965053NX	C20-0018	E30-0118/ E30-0144	E27-0083
	ISX	2888250NX / 2871496NX / A030W859	C20-0019	E30-0118/ E30-0144	E27-0083
ISX	4969721NX / 2888262NX / 2880259NX / 4969719NX / A030X734 / Q622230 / 4936734NX	C20-0020	E30-0118	E27-0083	
ISX	2885941NX / 2888263NX	C20-0028	E30-0118/ E30-0144	E27-0083	
OEM	Engine Model	OEM P/N	DuraFit P/N	Gasket P/N	Clamp P/N
<b>Detroit Diesel</b>	DD15	RA6804901214 / A6804901592 / A6804901692	C20-0010	E30-0129	TBD
OEM	Engine Model	OEM P/N	DuraFit P/N	Gasket P/N	Clamp P/N
<b>Mack / Volvo</b>	MP7	20863840 / 21850643 / 85001356 / 85000777	C20-0008	E30-0118	E27-0083
	MP7/MP8/D11/ D13	21756505 / 21212405	C20-0037	TBD	TBD
	D11/D13	20864129 / 21850645 / 85001355 / 85013895 /	C20-0009	E30-0127	TBD

# DOCs HD CLASS 7 & 8

## Diesel Oxidation Catalysts Cross Reference Guide

### Diesel Oxidation Catalysts

OEM	Engine Model	OEM P/N	DuraFit P/N	Gasket P/N	Clamp P/N
Navistar / MaxxForce / International	7	2594200C91	C20-0036	TBD	TBD
	13	2604039C91 / 3865483C93 / 3869133C93 / IP23265 / 5010811R91	C20-0023	E30-0146	NOT REQUIRED
	13	2603960C91 / 5010812R91	C20-0024	E30-0146	NOT REQUIRED
	11/13	2596690C91	C20-0022	TBD	TBD
	7/DT	2597007C91 / 2594454C91	C20-0021	TBD	TBD
	9/DT	2605802C1 / 2605128C1 /	C20-0027	TBD	TBD
	DT	2596407C92	C20-0026	TBD	TBD
	DT	2605332C91	C20-0029	TBD	TBD
	ISX	2888249NX / 4969542NX / 4965317NX / A030W858 / Q620970 / Q621430 / Q621503	C20-0005	E30-0118	E27-0083
OEM	Engine Model	OEM P/N	DuraFit P/N	Gasket P/N	Clamp P/N
PACCAR	MX	2871577NX / 18373013PE / 26222150600	C20-0013	E30-0118	TBD
OEM	Engine Model	OEM P/N	DuraFit P/N	Gasket P/N	Clamp P/N
Hino	J08E (Combined DPF and DOC)	S1805E0270 / S1850E0281	C17-0083	E30-0158	NOT REQUIRED

# Clamps

## HD CLASS 7 & 8

### For the DuraFit DPFs and DOCs

### Cross Reference Guide

#### V-Band Clamps

OEM	Engine Model	OE Clamp P/N	Description	DuraFit P/N	Fits DPF	Fits DOC
<b>Caterpillar</b>	C7	2871857 / 2871861	Caterpillar 10.35" V Clamp	E27-0087	C17-0069	
<b>Cummins</b>	ISL / ISM / ISX	2871863 / 4965098 / 21445455	Cummins 13.38" V Clamp	E27-0083	C17-0031/C17-0032/ C17-0037/C17-0038/ C17-0043/C17-0047/ C17-0055/C17-0063/ C17-0068/C17-0079/ C17-0084/C17-0088	C20-0003/C20-0004/ C20-0005/C20-0006/ C20-0007/C20-0015/ C20-0017/C20-0018/ C20-0019/C20-0020/ C20-0028
	ISC / ISL / ISX	4965086 / 4965097 / 2871862 / 4965072	Cummins 11.88" V Clamp	E27-0084	C17-0030/C17-0042/ C17-0048/C17-0054/ C17-0066/C17-0073/ C17-0074/C17-0085/ C17-0086	C20-0002/C20-0011
	ISB	4965063 / 2793260	Cummins 10.35" V Clamp	E27-0087	C17-0029/C17-0058/ C17-0080/C17-0081	C20-0001
<b>Detroit Diesel / Mercedes</b>	DD13 / DD15	A4709950002/ A0019959802	Detroit Diesel 14.52" V Clamp	E27-0085	C17-0067	
	DD13 / DD15 (One-box)	A6809950202	Detroit 10.55" V Clamp (One Box)	E27-0088	C17-0076	
	Series 60	A4709950002	Detroit 14.13" V Clamp	E27-0089	C17-0036	
	DD13 / DD15 (One-box)	A6809950302	Detroit 10.55" Flat Band Clamp (One Box)	E27-0092	C17-0076	
	MB 0926	A6809950102	Detroit Diesel 10.5" ID V Band Clamp	E27-0096	C17-0039	

\*Not legal for sale or use in the state of California or areas where California emissions compliance is required.

# Clamps

**HD CLASS 7 & 8**

## For the DuraFit DPFs and DOCs

### Cross Reference Guide

#### V-Band Clamps

OEM	Engine Model	OE Clamp P/N	Description	DuraFit P/N	Fits DPF	Fits DOC
Mack / Volvo	MP7/MP8	2871863 / 4965098	Mack/Volvo 13.38" V Clamp	E27-0083	C17-0044/C17-0046	C20-0008
	D11/D13/ D16	21445458/21048521	Mack/Volvo 14.52" V Clamp	E27-0085	C17-0045	
	MP7 / MP8 / D11 / D13	2104852/21048521	Mack/Volvo 14.13" V Clamp	E27-0089	C17-0035/C17-0075/ C17-0089	
	MP8 / D13	21212520/85124753	Mack/Volvo 14 in. V Clamp	E27-0091	C17-0057/C17-0087	
OEM	Engine Model	OE Clamp P/N	Description	DuraFit P/N	Fits DPF	Fits DOC
Navistar / International	7/DT	2594128C1/100123-1	Navistar 9.37" V Clamp	E27-0086	C17-0041/C17-0053/ C17-0064/C17-0082	C20-0029/C20-0031
	MaxxForce 11/13	2604049C91	Navistar Tape 3/4" x 108'	E27-0094	C17-0056/C17-0059	

# Gaskets

**HD CLASS 7 & 8**

## For the DuraFit DPFs and DOCs

### Cross Reference Guide

#### Gaskets

OEM	OE Gasket P/N	Description	DuraFit P/N	Fits DPF	Fits DOC
<b>Caterpillar</b>	2793259	Caterpillar 11"	E30-0119	C17-0033/C17-0069	
	2785711	Caterpillar 14"	E30-0120	C17-0034/C17-0051	
	2471899	Caterpillar ID 11.9" x OD 12.66" x .062"	E30-0121	C17-0050	
	2792123	Caterpillar 13.5"	E30-0123	C17-0040/C17-0052	
OEM	OE Gasket P/N	Description	DuraFit P/N	Fits DPF	Fits DOC
<b>Cummins</b>	2871453 / 21371338 / 2601233C1	Cummins 13 5/16" x 12 7/16"	E30-0118	C17-0031/C17-0032/C17-0037/ C17-0038/C17-0043/C17-0044/ C17-0046/C17-0047/C17-0048? C17-0055/C17-0063/C17-0068/ C17-0079/C17-0084/C17-0088	C20-0003/C20-0004/ C20-0005/C20-0006/ C20-0007/C20-0008/ C20-0013/C20-0014/ C20-0015/C20-0017/ C20-0018/C20-0019/ C20-0020/C20-0028/ C20-0030/C20-0032/ C20-0034/E30-0035/ C20-0038/C20-0039
	21371339	Cummins 14 5/16" x 131/2"	E30-0127	C17-0045/C17-0048?	C20-0009
	21371340 / 2866337	Cummins 5" ID x 6" OD	E30-0144		C20-0015/C20-0018/ C20-0039
	2866636 / Q312526	Cummins 4" x 4-3/4"	E30-0146		
	2871827	Cummins 13 5/16" x 12 7/16"	E30-0156	C17-0087	
OEM	OE Gasket P/N	Description	DuraFit P/N	Fits DPF	Fits DOC
<b>Detroit Diesel</b>	21048511	Detroit 13.375" x 13.687	E30-0129	C17-0035 / C17-0036 / C17-0075 / C17-0089	C20-0010
	A6804910180	Detroit 10.5"x11.25"	E30-0137	C17-0039	
	A4709970045	Spiral Wnd 14 1/4 X 13 5/16	E30-0140	C17-0067	
	A6804910480	Detroit 9.75 X 10.125	E30-0147	C17-0076	
	A4709971145	Detroit 13.32" x 13.64"	E30-0148		
OEM	OE Gasket P/N	Description	DuraFit P/N	Fits DPF	Fits DOC
<b>Hino</b>	S171041930	10 Hole Gasket 8.25" ID	E30-0158	C17-0083	

\*Not legal for sale or use in the state of California or areas where California emissions compliance is required.

# Gaskets

**HD CLASS 7 & 8**

## For the DuraFit DPFs and DOCs

### Cross Reference Guide

#### Gaskets

OEM	OE Gasket P/N	Description	DuraFit P/N	Fits DPF	Fits DOC
<b>Isuzu</b>	8-97628257-0	8 1/4 ID x 9 11/16OD	E30-0151	C17-0071	
	8-97611080-0	Isuzu 8" ID X 9.5"OD	E30-0152	C17-0070	
	897611080 / 897628257	Isuzu 10.53"OD	E30-0153	C17-0072	
OEM	OE Gasket P/N	Description	DuraFit P/N	Fits DPF	Fits DOC
<b>Mack / Volvo</b>	21371339	Mack/Volvo 14 5/16" x 131/2"	E30-0127	C17-0045/C17-0048?	C20-0009
	21212522	Mack/Volvo 13"ID x 14"OD	E30-0130	C17-0057	
	21371340 / 2866337	Mack/Volvo 5" ID x 6" OD	E30-0144		C20-0015 / C20-0018 / C20-0039
	2866636 / Q312526	Mack/Volvo 4" x 4-3/4"	E30-0146		
	21095726	Mack/Volvo Gasket 5 1/4"	E30-0150		
OEM	OE Gasket P/N	Description	DuraFit P/N	Fits DPF	Fits DOC
<b>Navistar / International</b>	2594129C1	International 8" x 9- 5/16"	E30-0124	C17-0041/C17-0053/C17-0064/ C17-0082	
	2593998C1	International Flange Round Gasket 5"	E30-0125	C17-0060/C17-0061/C17-0062	
	2593986C1	International Flange Flat Gasket 5"	E30-0126	C17-0060/C17-0061/C17-0062	
	2604051C91	International Gasket Tape 3/4" X 108'	E30-0143	C17-0056/C17-0059	

# DPF/DOC OE Interchange

Caterpillar			
OEM P/N	DuraFit P/N	Gasket P/N	Clamp P/N
1733481	C17-0051	E30-0120	TBD
1733481	C17-0051	E30-0120	TBD
2500630	C17-0050	E30-0121	TBD
2612318	C17-0050	E30-0121	TBD
2641556	C17-0050	E30-0121	TBD
2900045	C17-0040	E30-0123	TBD
2900045	C17-0040	E30-0123	TBD
2900045	C17-0040	E30-0123	TBD
2918515	C17-0052	E30-0123	TBD
2918515	C17-0052	E30-0123	TBD
2918515	C17-0052	E30-0123	TBD
2918519	C17-0051	E30-0120	TBD
2918519	C17-0051	E30-0120	TBD
2939990	C17-0051	E30-0120	TBD
2939990	C17-0051	E30-0120	TBD
2948692	C17-0052	E30-0123	TBD
2948692	C17-0052	E30-0123	TBD
2948692	C17-0052	E30-0123	TBD
2948694	C17-0051	E30-0120	TBD
2948694	C17-0051	E30-0120	TBD
2948694	C17-0051	E30-0120	TBD
2948694	C17-0051	E30-0120	TBD
2948694	C17-0051	E30-0120	TBD
3017856	C17-0040	E30-0123	TBD
3017856	C17-0040	E30-0123	TBD
3017856	C17-0040	E30-0123	TBD
3047502	C17-0034	E30-0120	TBD
3047502	C17-0034	E30-0120	TBD
3047502	C17-0034	E30-0120	TBD
3047519	C17-0034	E30-0120	TBD
3047519	C17-0034	E30-0120	TBD
3047519	C17-0034	E30-0120	TBD
3047578	C17-0033	E30-0119	TBD
3047579	C17-0033	E30-0119	TBD
3054565	C17-0069	E30-0119	E27-0087
3056294	C17-0069	E30-0119	E27-0087
3096991	C17-0052	E30-0123	TBD
3096991	C17-0052	E30-0123	TBD
3096991	C17-0052	E30-0123	TBD
10R6082	C17-0033	E30-0119	TBD

Caterpillar			
OEM P/N	DuraFit P/N	Gasket P/N	Clamp P/N
10R6084	C17-0069	E30-0119	E27-0087
10R-6087	C17-0052	E30-0123	TBD
10R6088	C17-0040	E30-0123	TBD
10R6088	C17-0040	E30-0123	TBD
10R6088	C17-0040	E30-0123	TBD
10R7056	C17-0034	E30-0120	TBD
10R7056	C17-0034	E30-0120	TBD
10R7056	C17-0034	E30-0120	TBD
10R-6082	C17-0033	E30-0119	TBD
10R-6084	C17-0069	E30-0119	E27-0087
10R-6087	C17-0052	E30-0123	TBD
10R-6087	C17-0052	E30-0123	TBD
10R-6088	C17-0040	E30-0123	TBD
10R-6088	C17-0040	E30-0123	TBD
10R-6088	C17-0040	E30-0123	TBD
10R-6089	C17-0051	E30-0120	TBD
10R-6089	C17-0051	E30-0120	TBD
10R-7056	C17-0034	E30-0120	TBD
10R-7056	C17-0034	E30-0120	TBD
220-6054	C17-0050	E30-0121	TBD
250-0630	C17-0050	E30-0121	TBD
261-2318	C17-0050	E30-0121	TBD
264-1556	C17-0050	E30-0121	TBD
290-0045	C17-0040	E30-0123	TBD
290-0045	C17-0040	E30-0123	TBD
290-0045	C17-0040	E30-0123	TBD
291-8515	C17-0052	E30-0123	TBD
291-8515	C17-0052	E30-0123	TBD
291-8515	C17-0052	E30-0123	TBD
291-8519	C17-0051	E30-0120	TBD
291-8519	C17-0051	E30-0120	TBD
293-9990	C17-0051	E30-0120	TBD
293-9990	C17-0051	E30-0120	TBD
294-8692	C17-0052	E30-0123	TBD
294-8692	C17-0052	E30-0123	TBD
294-8692	C17-0052	E30-0123	TBD
294-8694	C17-0051	E30-0120	TBD
294-8694	C17-0051	E30-0120	TBD

\*Not legal for sale or use in the state of California or areas where California emissions compliance is required.

Caterpillar			
OEM P/N	DuraFit P/N	Gasket P/N	Clamp P/N
301-7856	C17-0040	E30-0123	TBD
301-7856	C17-0040	E30-0123	TBD
301-7856	C17-0040	E30-0123	TBD
301-7856	C17-0040	E30-0123	TBD
301-7856	C17-0040	E30-0123	TBD
301-7856	C17-0040	E30-0123	TBD
304-7502	C17-0034	E30-0120	TBD
304-7502	C17-0034	E30-0120	TBD
304-7502	C17-0034	E30-0120	TBD
304-7519	C17-0034	E30-0120	TBD
304-7519	C17-0034	E30-0120	TBD
304-7519	C17-0034	E30-0120	TBD
304-7519	C17-0034	E30-0120	TBD
304-7578	C17-0033	E30-0119	TBD
304-7579	C17-0033	E30-0119	TBD
305-4565	C17-0069	E30-0119	E27-0087
305-6294	C17-0069	E30-0119	E27-0087
309-6991	C17-0052	E30-0123	TBD
309-6991	C17-0052	E30-0123	TBD
309-6991	C17-0052	E30-0123	TBD

Cummins			
OEM P/N	DuraFit P/N	Gasket P/N	Clamp P/N
619496	C17-0054	E30-0117	E27-0084
619733	C17-0054	E30-0117	E27-0084
649206	C17-0042	E30-0117	E27-0084
649402	C17-0044	E30-0118	E27-0083
694200	C17-0032	E30-0118	E27-0083
2871459	C17-0074	E30-0117	E27-0084
2871459	C17-0074	E30-0117	E27-0084
2871461	C17-0081	E30-0116	E27-0087
2871462	C17-0080	E30-0116	E27-0087
2871463	C17-0030	E30-0117	E27-0084
2871578	C17-0037	E30-0118	E27-0083
2871838	C17-0087	E30-0156	E27-0091
2880168	C17-0032	E30-0118	E27-0083
2880169	C17-0031	E30-0118	E27-0083

Cummins			
OEM P/N	DuraFit P/N	Gasket P/N	Clamp P/N
2880169	C17-0031	E30-0118	E27-0083
2880259	C20-0040	TBD	TBD
2880259	C20-0040	TBD	TBD
2880281	C17-0031	E30-0118	E27-0083
2880281	C17-0031	E30-0118	E27-0083
2880385	C20-0015	E30-0118/ E30-0144	E27-0083
2880385	C20-0015	E30-0118/ E30-0144	E27-0083
2885941	C20-0028	E30-0118	E27-0083
2888231	C17-0087	E30-0156	E27-0091
2888247	C20-0007	E30-0118	E27-0083
2888248	C20-0006	E30-0118	E27-0083
2888249	C20-0005	E30-0118	E27-0083
2888263	C20-0028	E30-0118	E27-0083
3103617	C17-0054	E30-0117	E27-0084
3976606	C17-0054	E30-0117	E27-0084
3978026	C17-0054	E30-0117	E27-0084
3999661	C17-0054	E30-0117	E27-0084
3999662	C17-0054	E30-0117	E27-0084
4330064	C20-0006	E30-0118	E27-0083
4352920	C17-0038	E30-0118	E27-0083
4352920	C17-0038	E30-0118	E27-0083
4352921	C17-0031	E30-0118	E27-0083
4352922	C17-0047	E30-0118	E27-0083
4352923	C17-0031	E30-0118	E27-0083
4352923	C17-0031	E30-0118	E27-0083
4352989	C17-0043	E30-0118	E27-0083
4353249	C20-0039	E30-0118/ E30-0144	E27-0083
4388409	C17-0032	E30-0118	E27-0083
4388410	C17-0032	E30-0118	E27-0083
4388411	C17-0044	E30-0118	E27-0083
4388411	C17-0044	E30-0118	E27-0083
4394580	C17-0095	TBD	TBD
4936734	C20-0020	E30-0118	E27-0083
4936734	C20-0020	E30-0118	E27-0083
4936734	C20-0040	TBD	TBD
4936737	C17-0038	E30-0118	E27-0083

\*Not legal for sale or use in the state of California or areas where California emissions compliance is required.



Cummins			
OEM P/N	DuraFit P/N	Gasket P/N	Clamp P/N
4936737	C17-0038	E30-0118	E27-0083
4965030	C20-0005	E30-0118	E27-0083
4965053	C20-0018	E30-0118/ E30-0144	E27-0083
4965055	C17-0038	E30-0118	E27-0083
4965055	C17-0038	E30-0118	E27-0083
4965129	C17-0032	E30-0118	E27-0083
4965218	C17-0047	E30-0118	E27-0083
4965222	C20-0033	E30-0116	E27-0087
4965223	C20-0004	E30-0118	E27-0083
4965224	C17-0043	E30-0118	E27-0083
4965225	C20-0006	E30-0118	E27-0083
4965226	C17-0032	E30-0118	E27-0083
4965229	C17-0042	E30-0117	E27-0084
4965243	C20-0003	E30-0118	E27-0083
4965244	C17-0031	E30-0118	E27-0083
4965284	C20-0002	E30-0117	E27-0084
4965285	C20-0001	E30-0116	E27-0087
4965286	C17-0042	E30-0117	E27-0084
4965286	C17-0042	E30-0117	E27-0084
4965287	C17-0029	E30-0116	E27-0087
4965304	C20-0007	E30-0118	E27-0083
4965305	C17-0044	E30-0118	E27-0083
4965317	C20-0005	E30-0118	E27-0083
4965322	C17-0044	E30-0118	E27-0083
4965322	C17-0044	E30-0118	E27-0083
4965352	C20-0016	E30-0117	TBD
4969542	C20-0005	E30-0118	E27-0083
4969700	C17-0032	E30-0118	E27-0083
4969701	C17-0032	E30-0118	E27-0083
4969701	C17-0032	E30-0118	E27-0083
4969702	C17-0032	E30-0118	E27-0083
4969703	C17-0044	E30-0118	E27-0083
4969703	C17-0044	E30-0118	E27-0083
4969721	C20-0020	E30-0118	E27-0083
4969721	C20-0020	E30-0118	E27-0083
4969770	C20-0042	E30-0117	E27-0084
4969771	C20-0042	E30-0117	E27-0084
4969838	C17-0042	E30-0117	E27-0084

Cummins			
OEM P/N	DuraFit P/N	Gasket P/N	Clamp P/N
4969839	C17-0042	E30-0117	E27-0084
5273093	C17-0088	E30-0118	E27-0083
5283283	C17-0084	E30-0118	E27-0083
5283669	C17-0032	E30-0118	E27-0083
5283669	C17-0032	E30-0118	E27-0083
5283778	C17-0032	E30-0118	E27-0083
5283778	C17-0032	E30-0118	E27-0083
5283799	C17-0044	E30-0118	E27-0083
5284780	C20-0001	E30-0116	E27-0087
5286910	C20-0039	E30-0118/ E30-0144	E27-0083
5287191	C20-0003	E30-0118	E27-0083
5287231	C20-0034	E30-0118	E27-0083
5287491	C20-0016	E30-0117	TBD
5287496	C20-0002	E30-0117	E27-0084
5287521	C20-0004	E30-0118	E27-0083
5289769	C17-0087	E30-0156	E27-0091
5295603	C17-0091	E30-0116	E27-0087
5295604	C17-0084	E30-0118	E27-0083
5295605	C17-0073	E30-0117	E27-0084
5295606	C17-0086	E30-0117	E27-0084
5295609	C17-0079	E30-0118	E27-0083
5297522	C17-0032	E30-0118	E27-0083
5297989	C17-0044	E30-0118	E27-0083
5297990	C17-0032	E30-0118	E27-0083
5298340	C20-0039	E30-0118/ E30-0144	E27-0083
5298349	C20-0034	E30-0118	E27-0083
5303922	C17-0087	E30-0156	E27-0091
5309560	C20-0030	E30-0118	E27-0083
20864129	C20-0020	E30-0118	E27-0083
20864129	C20-0020	E30-0118	E27-0083
20970295	C17-0044	E30-0118	E27-0083
20970295	C17-0044	E30-0118	E27-0083
529560300	C17-0091	E30-0116	E27-0087
529560300	C17-0091	E30-0116	E27-0087
26222150600	C20-0013	E30-0118	TBD
26266120055	C20-0012	E30-0117	TBD
26326120259	C20-0011	E30-0117	E27-0084

\*Not legal for sale or use in the state of California or areas where California emissions compliance is required.

Cummins			
OEM P/N	DuraFit P/N	Gasket P/N	Clamp P/N
26326120259	C20-0011	E30-0117	E27-0084
203223A	C17-0044	E30-0118	E27-0083
4965286NX	C17-0042	E30-0117	E27-0084
4969838NX	C17-0042	E30-0117	E27-0084
5295603NX	C17-0091	E30-0116	E27-0087
5295603NX	C17-0091	E30-0116	E27-0087
A0034X344	C17-0044	E30-0118	E27-0083
A029C893	C17-0032	E30-0118	E27-0083
A030K896	C17-0088	E30-0118	E27-0083
A030S045	C17-0087	E30-0156	E27-0091
A030W857	C20-0006	E30-0118	E27-0083
A030W858	C20-0005	E30-0118	E27-0083
A034H646	C17-0084	E30-0118	E27-0083
A034X191	C17-0032	E30-0118	E27-0083
A034X329	C17-0032	E30-0118	E27-0083
A035G674	C20-0003	E30-0118	E27-0083
A035H236	C20-0001	E30-0116	E27-0087
A035H295	C20-0002	E30-0117	E27-0084
A035H536	C20-0004	E30-0118	E27-0083
A035N640	C17-0087	E30-0156	E27-0091
A035W856	C20-0007	E30-0118	E27-0083
A040M135	C17-0091	E30-0116	E27-0087
A040M135	C17-0091	E30-0116	E27-0087
A040M139	C17-0073	E30-0117	E27-0084
A040M143	C17-0084	E30-0118	E27-0083
A041D445	C17-0086	E30-0117	E27-0084
A041D448	C17-0079	E30-0118	E27-0083
A041L187	C17-0032	E30-0118	E27-0083
A041M783	C17-0032	E30-0118	E27-0083
A041M795	C17-0044	E30-0118	E27-0083
A042U501	C17-0087	E30-0156	E27-0091
A046F194	C17-0043	E30-0118	E27-0083
A047B275	C20-0006	E30-0118	E27-0083
A047B789	C17-0031	E30-0118	E27-0083
A047B789	C17-0031	E30-0118	E27-0083
A047B790	C17-0047	E30-0118	E27-0083
A047B792	C17-0031	E30-0118	E27-0083
A047B792	C17-0031	E30-0118	E27-0083
A047B793	C17-0038	E30-0118	E27-0083

Cummins			
OEM P/N	DuraFit P/N	Gasket P/N	Clamp P/N
A047B793	C17-0038	E30-0118	E27-0083
A051G270	C17-0032	E30-0118	E27-0083
A051G271	C17-0032	E30-0118	E27-0083
A051G272	C17-0044	E30-0118	E27-0083
A29J952	C17-0031	E30-0118	E27-0083
A29J952	C17-0031	E30-0118	E27-0083
C0101-ID	C20-0042	E30-0117	E27-0084
EPN A040M135	C17-0091	E30-0116	E27-0087
Q165338	C17-0054	E30-0117	E27-0084
Q165489	C17-0038	E30-0118	E27-0083
Q165489	C17-0038	E30-0118	E27-0083
Q165573	C17-0032	E30-0118	E27-0083
Q619495A	C17-0054	E30-0117	E27-0084
Q619725A	C17-0054	E30-0117	E27-0084
Q619733A	C17-0054	E30-0117	E27-0084
Q620940	C17-0038	E30-0118	E27-0083
Q620940	C17-0038	E30-0118	E27-0083
Q620970	C20-0005	E30-0118	E27-0083
Q621275	C20-0002	E30-0117	E27-0084
Q621301	C20-0003	E30-0118	E27-0083
Q621319	C20-0007	E30-0118	E27-0083
Q621320	C17-0044	E30-0118	E27-0083
Q621334	C17-0032	E30-0118	E27-0083
Q621371	C17-0042	E30-0117	E27-0084
Q621375	C17-0047	E30-0118	E27-0083
Q621376	C17-0058	E30-0116	E27-0087
Q621377	C17-0042	E30-0117	E27-0084
Q621378	C17-0031	E30-0118	E27-0083
Q621378	C17-0031	E30-0118	E27-0083
Q621385	C20-0001	E30-0116	E27-0087
Q621386	C17-0029	E30-0116	E27-0087
Q621401	C20-0004	E30-0118	E27-0083
Q621402	C17-0043	E30-0118	E27-0083
Q621404	C20-0006	E30-0118	E27-0083
Q621405	C17-0032	E30-0118	E27-0083
Q621430	C20-0005	E30-0118	E27-0083
Q621503	C20-0005	E30-0118	E27-0083
Q621936	C17-0032	E30-0118	E27-0083

\*Not legal for sale or use in the state of California or areas where California emissions compliance is required.

Cummins			
OEM P/N	DuraFit P/N	Gasket P/N	Clamp P/N
Q621937	C17-0032	E30-0118	E27-0083
Q621938	C17-0044	E30-0118	E27-0083
Q623316	C17-0042	E30-0117	E27-0084
Q623804	C17-0042	E30-0117	E27-0084
Q629289	C17-0087	E30-0156	E27-0091
Q629355	C17-0081	E30-0116	E27-0087
Q629356	C17-0080	E30-0116	E27-0087
Q629361	C17-0074	E30-0117	E27-0084
Q629361	C17-0074	E30-0117	E27-0084
Q629362	C17-0030	E30-0117	E27-0084
Q629458	C17-0037	E30-0118	E27-0083
Q629477	C17-0068	E30-0118	E27-0083
061794A0A	C17-0054	E30-0117	E27-0084
1837303PE	C20-0013	E30-0118	TBD
2594140C91	C20-0031	NOT APPLICABLE	E27-0086
2594140C91	C20-0031	NOT APPLICABLE	E27-0086
2871459NX	C17-0074	E30-0117	E27-0084
2871461NX	C17-0081	E30-0116	E27-0087
2871462NX	C17-0080	E30-0116	E27-0087
2871463NX	C17-0030	E30-0117	E27-0084
2871496NX	C20-0019		E27-0083
2871577NX	C20-0013	E30-0118	TBD
2871578NX	C17-0037	E30-0118	E27-0083
2871581NX	C17-0068	E30-0118	E27-0083
2871581NX	C17-0068	E30-0118	E27-0083
2880165NX	C20-0014	E30-0118	TBD
2880165NX	C20-0014	E30-0118	TBD
2880168NX	C17-0032	E30-0118	E27-0083
2880169NX	C17-0031	E30-0118	E27-0083
2880259NX	C20-0020	E30-0118	E27-0083
2880259NX	C20-0020	E30-0118	E27-0083
2880259NX	C20-0040	TBD	TBD
2880259RX	C20-0040	TBD	TBD
2880281NX	C17-0031	E30-0118	E27-0083
2880501NX	C20-0038	E30-0118	E27-0083
2880505NX	C20-0035	E30-0118	E27-0083
2880506NX	C20-0015	E30-0118/ E30-0144	E27-0083

Cummins			
OEM P/N	DuraFit P/N	Gasket P/N	Clamp P/N
2880506NX	C20-0015	E30-0118/ E30-0144	E27-0083
2880582NX	C20-0032	E30-0118	E27-0083
2880589NX	C20-0012	E30-0117	
2888231NX	C17-0087	E30-0156	E27-0091
2888247NX	C20-0007	E30-0118	E27-0083
2888249NX	C20-0005	E30-0118	E27-0083
2888250NX	C20-0019		E27-0083
2888261NX	C20-0018	E30-0118/ E30-0144	E27-0083
2888262NX	C20-0020	E30-0118	E27-0083
2888262NX	C20-0020	E30-0118	E27-0083
3817962C91	C17-0038	E30-0118	E27-0083
4352920NX	C17-0038	E30-0118	E27-0083
4352921NX	C17-0031	E30-0118	E27-0083
4352922NX	C17-0047	E30-0118	E27-0083
4352923NX	C17-0031	E30-0118	E27-0083
4352989NX	C17-0043	E30-0118	E27-0083
4353221NX	C20-0034	E30-0118	E27-0083
4353249NX	C20-0039	E30-0118/ E30-0144	E27-0083
4353249RX	C20-0039	E30-0118/ E30-0144	E27-0083
4353264NX	C20-0030	E30-0118	E27-0083
4388409RX	C17-0032	E30-0118	E27-0083
4388410RX	C17-0032	E30-0118	E27-0083
4388411RX	C17-0044	E30-0118	E27-0083
4936734NX	C20-0040	TBD	TBD
4936734RX	C20-0040	TBD	TBD
4936736NX	C20-0017	E30-0118	E27-0083
4936736NX	C20-0017	E30-0118	E27-0083
4936737NX	C17-0038	E30-0118	E27-0083
4936737NX	C17-0038	E30-0118	E27-0083
4965055NX	C17-0038	E30-0118	E27-0083
4965129D	C17-0044	E30-0118	E27-0083
4965129NX	C17-0032	E30-0118	E27-0083
4965218NX	C17-0047	E30-0118	E27-0083
4965222NX	C20-0033	E30-0116	E27-0087
4965222NX	C20-0033	E30-0116	E27-0087
4965223NX	C20-0004	E30-0118	E27-0083

\*Not legal for sale or use in the state of California or areas where California emissions compliance is required.

Cummins			
OEM P/N	DuraFit P/N	Gasket P/N	Clamp P/N
4965224NX	C17-0043	E30-0118	E27-0083
4965225NX	C20-0006	E30-0118	E27-0083
4965226NX	C17-0032	E30-0118	E27-0083
4965227NX	C17-0058	E30-0116	E27-0087
4965227NX	C17-0058	E30-0116	E27-0087
4965243NX	C20-0003	E30-0118	E27-0083
4965243NX	C20-0017	E30-0118	E27-0083
4965243NX	C20-0017	E30-0118	E27-0083
4965244NX	C17-0031	E30-0118	E27-0083
4965284NX	C20-0002	E30-0117	E27-0084
4965285NX	C20-0001	E30-0116	E27-0087
4965286NX	C17-0042	E30-0117	E27-0084
4965287NX	C17-0029	E30-0116	E27-0087
4965304NX	C20-0007	E30-0118	E27-0083
4965305NX	C17-0044	E30-0118	E27-0083
4965317NX	C20-0005	E30-0118	E27-0083
4965352NX	C20-0016	E30-0117	TBD
4965352RX	C20-0016	E30-0117	TBD
4969542NX	C20-0005	E30-0118	E27-0083
4969700NX	C17-0032	E30-0118	E27-0083
4969701NX	C17-0032	E30-0118	E27-0083
4969702NX	C17-0032	E30-0118	E27-0083
4969703NX	C17-0044	E30-0118	E27-0083
4969718NX	C20-0018	E30-0118/ E30-0144	E27-0083
4969719NX	C20-0017	E30-0118	E27-0083
4969719NX	C20-0017	E30-0118	E27-0083
4969719NX	C20-0020	E30-0118	E27-0083
4969719NX	C20-0020	E30-0118	E27-0083
4969721NX	C20-0020	E30-0118	E27-0083
4969721NX	C20-0020	E30-0118	E27-0083
4969770NX	C20-0042	E30-0117	E27-0084
4969770RX	C20-0042	E30-0117	E27-0084
4969771NX	C20-0042	E30-0117	E27-0084
4969771RX	C20-0042	E30-0117	E27-0084
4969838NX	C17-0042	E30-0117	E27-0084
4969839NX	C17-0042	E30-0117	E27-0084
5273093NX	C17-0088	E30-0118	E27-0083
5273093NX	C17-0088	E30-0118	E27-0083

Cummins			
OEM P/N	DuraFit P/N	Gasket P/N	Clamp P/N
5283669NX	C17-0032	E30-0118	E27-0083
5283778NX	C17-0032	E30-0118	E27-0083
5283799NX	C17-0044	E30-0118	E27-0083
5286910NX	C20-0039	E30-0118/ E30-0144	E27-0083
5286910RX	C20-0039	E30-0118/ E30-0144	E27-0083
5287191NX	C20-0003	E30-0118	E27-0083
5287191NX	C20-0017	E30-0118	E27-0083
5287191NX	C20-0017	E30-0118	E27-0083
5287480NX	C20-0001	E30-0116	E27-0087
5287491NX	C20-0016	E30-0117	TBD
5287491RX	C20-0016	E30-0117	TBD
5287496NX	C20-0002	E30-0117	E27-0084
5287519NX	C20-0017	E30-0118	E27-0083
5287519NX	C20-0017	E30-0118	E27-0083
5289769NX	C17-0087	E30-0156	E27-0091
5289769RX	C17-0087	E30-0156	E27-0091
5295604NX	C17-0084	E30-0118	E27-0083
5295604RX	C17-0084	E30-0158	E30-0158
5295605NX	C17-0073	E30-0117	E27-0084
5295606NX	C17-0086	E30-0117	E27-0084
5295606RX	C17-0086	E30-0117	E27-0084
5295609NX	C17-0079	E30-0118	E27-0083
5297522NX	C17-0032	E30-0118	E27-0083
5297989NX	C17-0044	E30-0118	E27-0083
5297990NX	C17-0032	E30-0118	E27-0083
5298340NX	C20-0039	E30-0118/ E30-0144	E27-0083
5298340RX	C20-0039	E30-0118/ E30-0144	E27-0083
5303922NX	C17-0087	E30-0156	E27-0091
5303922RX	C17-0087	E30-0156	E27-0091
674-2000	C17-0032	E30-0118	E27-0083
674-2002	C17-0044	E30-0118	E27-0083
674-2006	C17-0042	E30-0117	E27-0084
A029A324	C20-0014	E30-0118	TBD
A029C896	C17-0031	E30-0118	E27-0083
A029C896	C17-0031	E30-0118	E27-0083
A029D892	C20-0040	TBD	TBD

\*Not legal for sale or use in the state of California or areas where California emissions compliance is required.

Cummins			
OEM P/N	DuraFit P/N	Gasket P/N	Clamp P/N
A029S790	C20-0012	E30-0117	TBD
A030W857	C20-0006	E30-0118	E27-0083
A030W858	C20-0005	E30-0118	E27-0083
A030W859	C20-0019		E27-0083
A030X734	C20-0020	E30-0118	E27-0083
A030X734	C20-0020	E30-0118	E27-0083
A035E403	C20-0039	E30-0118/ E30-0144	E27-0083
A035G674	C20-0003	E30-0118	E27-0083
A035H236	C20-0001	E30-0116	E27-0087
A035H295	C20-0002	E30-0117	E27-0084
A035H299	C20-0016	E30-0117	TBD
A035H536	C20-0004	E30-0118	E27-0083
A035H544	C20-0017	E30-0118	E27-0083
A035H544	C20-0017	E30-0118	E27-0083
A035W856	C20-0007	E30-0118	E27-0083
A040M135	C17-0091	E30-0116	E27-0087
A041P368	C20-0039	E30-0118/ E30-0144	E27-0083
A047V447	C20-0039	E30-0118/ E30-0144	E27-0083
CPN 2880165NX	C20-0014	E30-0118	TBD
CPN2871923	C20-0011	E30-0117	E27-0084
CPN2871923	C20-0011	E30-0117	E27-0084
EPN A029A324	C20-0014	E30-0118	TBD
EPN A029B190	C20-0011	E30-0117	E27-0084
EPN A029B190	C20-0011	E30-0117	E27-0084
EPN A040M135	C17-0091	E30-0116	E27-0087
Q617940	C17-0054	E30-0117	E27-0084
Q617940A	C17-0054	E30-0117	E27-0084
Q619495	C17-0054	E30-0117	E27-0084
Q619496	C17-0054	E30-0117	E27-0084
Q619725	C17-0054	E30-0117	E27-0084
Q619725A	C17-0054	E30-0117	E27-0084
Q619733	C17-0054	E30-0117	E27-0084
Q621371	C17-0042	E30-0117	E27-0084

Cummins			
OEM P/N	DuraFit P/N	Gasket P/N	Clamp P/N
Q621378	C17-0031	E30-0118	E27-0083
Q621386	C17-0029	E30-0116	E27-0087
Q621386A	C17-0029	E30-0116	E27-0087
Q621560	C20-0016	E30-0117	TBD
Q621799	C20-0042	E30-0117	E27-0084
Q62230	C20-0020	E30-0118	E27-0083
Q62230	C20-0020	E30-0118	E27-0083
Q622913	C20-0042	E30-0117	E27-0084
Q623316	C17-0042	E30-0117	E27-0084
Q623804	C17-0042	E30-0117	E27-0084
Q629361	C17-0074	E30-0117	E27-0084
Q629362	C17-0030	E30-0117	E27-0084
Q629458	C17-0037	E30-0118	E27-0083
Q629477	C17-0068	E30-0118	E27-0083

Detroit Diesel / Mercedes / Daimler			
OEM P/N	DuraFit P/N	Gasket P/N	Clamp P/N
23535827	C17-0066	E30-0117	E27-0084
23535827	C17-0066	E30-0117	E27-0084
23537521	C17-0039	E30-0137	E27-0096
6804908692	C17-0036	E30-0129	E27-0089
6804910294	C17-0036	E30-0129	E27-0089
6804910594	C17-0036	E30-0129	E27-0089
A0014903592	C17-0076	E30-0147	E27-0088 & E27-0092
A0014903592	C17-0076	E30-0147	E27-0088 & E27-0092
A680413594	C17-0076	E30-0147	E27-0088 & E27-0092
A680413594	C17-0076	E30-0147	E27-0088 & E27-0092
A6804901592	C20-0010	E30-0129	TBD
A6804901692	C20-0010	E30-0129	TBD
A6804904392	C17-0039	E30-0137	E27-0096
A6804905792	C17-0039	E30-0137	E27-0096
A6804906192	C17-0039	E30-0137	E27-0096
A6804908692	C17-0036	E30-0129	E27-0089
A6804908792	C17-0039	E30-0137	E27-0096
A6804910094	C17-0039	E30-0137	E27-0096
A6804910097	C17-0039	E30-0137	E27-0096

\*Not legal for sale or use in the state of California or areas where California emissions compliance is required.

**Detroit Diesel / Mercedes / Daimler**

OEM P/N	DuraFit P/N	Gasket P/N	Clamp P/N
A6804910294	C17-0036	E30-0129	E27-0089
A6804910494	C17-0076	E30-0147	E27-0088 & E27-0092
A6804910494	C17-0076	E30-0147	E27-0088 & E27-0092
A6804910594	C17-0036	E30-0129	E27-0089
A6804910894	C17-0076	E30-0147	E27-0088 & E27-0092
A6804910894	C17-0076	E30-0147	E27-0088 & E27-0092
A6804913494	C17-0076	E30-0147	E27-0088 & E27-0092
A6804913494	C17-0076	E30-0147	E27-0088 & E27-0092
EA0014903492	C17-0076	E30-0147	E27-0088 & E27-0092
EA0014903492	C17-0076	E30-0147	E27-0088 & E27-0092
RA0004903792	C17-0076	E30-0147	E27-0088 & E27-0092
RA0004903792	C17-0076	E30-0147	E27-0088 & E27-0092
RA0014903492	C17-0076	E30-0147	E27-0088 & E27-0092
RA0014903492	C17-0076	E30-0147	E27-0088 & E27-0092
68011959AA	C17-0065	E30-0006	TBD
A0004903692	C17-0076	E30-0147	E27-0088 & E27-0092
A0004903692	C17-0076	E30-0147	E27-0088 & E27-0092
A0004903692	C17-0076	E30-0147	E27-0088 & E27-0092
A0004903792	C17-0076	E30-0147	E27-0088 / E27-0092
A0004903792	C17-0076	E30-0147	E27-0088 / E27-0092
A0004903792	C17-0076	E30-0147	E27-0088 / E27-0092
A0014903492	C17-0076	E30-0147	E27-0088 / E27-0092
A0014903492	C17-0076	E30-0147	E27-0088 / E27-0092
A0014903492	C17-0076	E30-0147	E27-0088 / E27-0092

**Detroit Diesel / Mercedes / Daimler**

OEM P/N	DuraFit P/N	Gasket P/N	Clamp P/N
A6804901592	C20-0010	E30-0129	TBD
A6804901692	C20-0010	E30-0129	TBD
A6804903792	C17-0076	E30-0147	E27-0088 / E27-0092
A6804903792	C17-0076	E30-0147	E27-0088 / E27-0092
A6804903792	C17-0076	E30-0147	E27-0088 / E27-0092
A6804904392	C17-0039	E30-0137	E27-0096
A6804905792	C17-0039	E30-0137	E27-0096
A6804906192	C17-0039	E30-0137	E27-0096
A6804908692	C17-0036	E30-0129	E27-0089
A6804910094	C17-0039	E30-0137	E27-0096
A6804910294	C17-0036	E30-0129	E27-0089
A6804910594	C17-0036	E30-0129	E27-0089
A6804910794	C17-0067	E30-0140	E27-0085
A6804910794	C17-0067	E30-0140	E27-0085
A6804910794	C17-0067	E30-0140	E27-0085
A6804910794	C17-0067	E30-0140	E27-0085
A6804910794	C17-0067	E30-0140	E27-0085
A6804910794	C17-0067	E30-0140	E27-0085
A6804910794	C17-0067	E30-0140	E27-0085
A6804910794	C17-0067	E30-0140	E27-0085
A6804910794	C17-0067	E30-0140	E27-0085
A6804910794	C17-0067	E30-0140	E27-0085
A6804910894	C17-0076	E30-0147	E27-0088 / E27-0092
A6804910894	C17-0076	E30-0147	E27-0088 / E27-0092
A6804910894	C17-0076	E30-0147	E27-0088 / E27-0092
A6804913494	C17-0076	E30-0147	E27-0088 / E27-0092
A6804913494	C17-0076	E30-0147	E27-0088 / E27-0092
A6804913494	C17-0076	E30-0147	E27-0088 / E27-0092
A9064901592	C17-0065	E30-0006	TBD
EA6804910794	C17-0067	E30-0140	E27-0085
EA6804910794	C17-0067	E30-0140	E27-0085
EA6804910794	C17-0067	E30-0140	E27-0085
EA6804910794	C17-0067	E30-0140	E27-0085
EA6804910794	C17-0067	E30-0140	E27-0085
EA6804910794	C17-0067	E30-0140	E27-0085
EA6804910794	C17-0067	E30-0140	E27-0085

\*Not legal for sale or use in the state of California or areas where California emissions compliance is required.

### Detroit Diesel / Mercedes / Daimler

OEM P/N	DuraFit P/N	Gasket P/N	Clamp P/N
EA6804910794	C17-0067	E30-0140	E27-0085
EA6804910794	C17-0067	E30-0140	E27-0085
EA6804910794	C17-0067	E30-0140	E27-0085
EA6804910894	C17-0076	E30-0147	E27-0088 / E27-0092
EA6804910894	C17-0076	E30-0147	E27-0088 / E27-0092
EA6804910894	C17-0076	E30-0147	E27-0088 / E27-0092
R23537521	C17-0039	E30-0137	E27-0096
RA0004903792	C17-0076	E30-0147	E27-0088 / E27-0092
RA0004903792	C17-0076	E30-0147	E27-0088 / E27-0092
RA0004903792	C17-0076	E30-0147	E27-0088 / E27-0092
RA0014903492	C17-0076	E30-0147	E27-0088 / E27-0092
RA0014903492	C17-0076	E30-0147	E27-0088 / E27-0092
RA0014903492	C17-0076	E30-0147	E27-0088 / E27-0092
RA6804901214	C20-0010	E30-0129	TBD
RA6804901214	C20-0010	E30-0129	TBD
RA6804903792	C17-0076	E30-0147	E27-0088 / E27-0092
RA6804903792	C17-0076	E30-0147	E27-0088 / E27-0092
RA6804903792	C17-0076	E30-0147	E27-0088 / E27-0092
RA6804908792	C17-0039	E30-0137	E27-0096
RA6804910097	C17-0039	E30-0137	E27-0096

### Mack / Volvo

OEM P/N	DuraFit P/N	Gasket P/N	Clamp P/N
649402	C17-0044	E30-0118	E27-0083
694101	C17-0035	E30-0129	E27-0089
20231111	C17-0035	E30-0129	E27-0089
20231111	C17-0035	E30-0129	E27-0089
20863840	C20-0008	E30-0118	E27-0083
20863859	C17-0044	E30-0118	E27-0083

### Mack / Volvo

OEM P/N	DuraFit P/N	Gasket P/N	Clamp P/N
20863859	C17-0044	E30-0118	E27-0083
20863859	C17-0044	E30-0118	E27-0083
20864127	C17-0045	E30-0127	E27-0085
20864127	C17-0045	E30-0127	E27-0085
20864127	C17-0045	E30-0127	E27-0085
20864129	C20-0009	E30-0127	TBD
20864129	C20-0009	E30-0127	TBD
20864316	C17-0048	E30-0127	E27-0084
20864558	C17-0046	E30-0118	E27-0083
20864558	C17-0046	E30-0118	E27-0083
20864558	C17-0046	E30-0118	E27-0083
20864558	C17-0046	E30-0118	E27-0083
20970295	C17-0044	E30-0118	E27-0083
20970295	C17-0044	E30-0118	E27-0083
20970295	C17-0044	E30-0118	E27-0083
20992181	C17-0035	E30-0129	E27-0089
20992181	C17-0035	E30-0129	E27-0089
20992181	C17-0035	E30-0129	E27-0089
21048577	C17-0035	E30-0129	E27-0089
21048577	C17-0035	E30-0129	E27-0089
21082068	C17-0089	E30-0129	E27-0089
21082068	C17-0089	E30-0129	E27-0089
21212405	C20-0037	TBD	TBD
21212405	C20-0037	TBD	TBD
21212405	C20-0037	TBD	TBD
21212405	C20-0037	TBD	TBD
21212426	C17-0057	E30-0130	E27-0090
21212426	C17-0057	E30-0130	E27-0090
21212428	C17-0057	E30-0130	E27-0090
21212429	C17-0057	E30-0130	E27-0090
21212429	C17-0057	E30-0130	E27-0090
21212431	C17-0057	E30-0130	E27-0090
21393279	C17-0089	E30-0129	E27-0089
21395825	C17-0075	E30-0129	E27-0089
21395825	C17-0075	E30-0129	E27-0089
21395825	C17-0035	E30-0129	E27-0089
21395826	C17-0075	E30-0129	E27-0089
21395826	C17-0075	E30-0129	E27-0089
21395826	C17-0075	E30-0129	E27-0089
21395827	C17-0089	E30-0129	E27-0089
21395827	C17-0089	E30-0129	E27-0089

\*Not legal for sale or use in the state of California or areas where California emissions compliance is required.

Mack / Volvo			
OEM P/N	DuraFit P/N	Gasket P/N	Clamp P/N
21395827	C17-0089	E30-0129	E27-0089
21415912	C17-0057	E30-0130	E27-0090
21471269	C17-0089	E30-0129	E27-0089
21471269	C17-0089	E30-0129	E27-0089
21471269	C17-0089	E30-0129	E27-0089
21471269	C17-0089	E30-0129	E27-0089
21755606	C17-0057	E30-0130	E27-0090
21755606	C17-0057	E30-0130	E27-0090
21756429	C17-0057	E30-0130	E27-0090
21756429	C17-0057	E30-0130	E27-0091
21756429	C17-0057	E30-0130	E27-0091
21756429	C17-0057	E30-0130	E27-0091
21756429	C17-0057	E30-0130	E27-0091
21756429	C17-0057	E30-0130	E27-0091
21756429	C17-0057	E30-0130	E27-0091
21756429	C17-0057	E30-0130	E27-0091
21756429	C17-0057	E30-0130	E27-0091
21756429	C17-0057	E30-0130	E27-0091
21756505	C20-0037	TBD	TBD
21756505	C20-0037	TBD	TBD
21756505	C20-0037	TBD	TBD
21756505	C20-0037	TBD	TBD
21804785	C17-0035	E30-0129	E27-0089
21804785	C17-0035	E30-0129	E27-0089
21804785	C17-0035	E30-0129	E27-0089
21817835	C17-0035	E30-0129	E27-0089
21817835	C17-0035	E30-0129	E27-0089
21850643	C20-0008	E30-0118	E27-0083
21850645	C20-0009	E30-0127	TBD
21850645	C20-0009	E30-0127	TBD
21850651	C17-0044	E30-0118	E27-0083
21850651	C17-0044	E30-0118	E27-0083
21850651	C17-0044	E30-0118	E27-0083
21850658	C17-0045	E30-0127	E27-0085
21850658	C17-0045	E30-0127	E27-0085
21851879	C17-0048	E30-0127	E27-0084
21851879	C17-0048	E30-0127	E27-0084
21905428	C17-0048	E30-0127	E27-0084
21905428	C17-0048	E30-0127	E27-0084

Mack / Volvo			
OEM P/N	DuraFit P/N	Gasket P/N	Clamp P/N
21905492	C17-0046	E30-0118	E27-0083
21905492	C17-0046	E30-0118	E27-0083
21905492	C17-0046	E30-0118	E27-0083
21905492	C17-0046	E30-0118	E27-0083
22342601	C17-0089	E30-0129	E27-0089
22342601	C17-0089	E30-0129	E27-0089
22342601	C17-0089	E30-0129	E27-0089
22342601	C17-0089	E30-0129	E27-0089
22342601	C17-0089	E30-0129	E27-0089
22342601	C17-0089	E30-0129	E27-0089
22413832	C17-0057	E30-0130	E27-0090
22413832	C17-0057	E30-0130	E27-0090
22761989	C17-0089	E30-0129	E27-0089
22761989	C17-0089	E30-0129	E27-0089
22761989	C17-0089	E30-0129	E27-0089
22761989	C17-0089	E30-0129	E27-0089
22761989	C17-0089	E30-0129	E27-0089
22761989	C17-0089	E30-0129	E27-0089
22761989	C17-0089	E30-0129	E27-0089
22761989	C17-0089	E30-0129	E27-0089
22761989	C17-0089	E30-0129	E27-0089
22776213	C17-0094	TBD	TBD
22806823	C17-0057	E30-0130	E27-0090
22806823	C17-0057	E30-0130	E27-0090
22810502	C17-0057	E30-0130	E27-0090
22810503	C17-0057	E30-0130	E27-0090
22810503	C17-0057	E30-0130	E27-0090
85000725	C17-0048	E30-0127	E27-0084
85000726	C17-0045	E30-0127	E27-0085
85000777	C20-0008	E30-0118	E27-0083
85000899	C17-0035	E30-0129	E27-0089
85001352	C17-0044	E30-0118	E27-0083
85001352	C17-0044	E30-0118	E27-0083
85001355	C20-0009	E30-0127	TBD
85001355	C20-0009	E30-0127	TBD
85001356	C20-0008	E30-0118	E27-0083
85001366	C17-0044	E30-0118	E27-0083
85001367	C17-0046	E30-0118	E27-0083
85003793	C17-0035	E30-0129	E27-0089
85013895	C20-0009	E30-0127	TBD

\*Not legal for sale or use in the state of California or areas where California emissions compliance is required.



**Mack / Volvo**

OEM P/N	DuraFit P/N	Gasket P/N	Clamp P/N
85013895	C20-0009	E30-0127	TBD
85124613	C17-0035	E30-0129	E27-0089
85124653	C17-0089	E30-0129	E27-0089
85125682	C17-0035	E30-0129	E27-0089
85126281	C17-0057	E30-0130	E27-0090
4965305NX	C17-0044	E30-0118	E27-0083
4965322388411RX	C17-0044	E30-0118	E27-0083
4969703NX	C17-0044	E30-0118	E27-0083
5283799NX	C17-0044	E30-0118	E27-0083
5297989NX	C17-0044	E30-0118	E27-0083
44965129D	C17-0044	E30-0118	E27-0083

**Navistar / International / MaxxForce**

OEM P/N	DuraFit P/N	Gasket P/N	Clamp P/N
2605123C91	C17-0060	E30-0125 & E30-0126	Not Required
2605796C91	C17-0062	E30-0125 & E30-0126	Not Required
2605837C1	C17-0082	E30-0124	E27-0086
2605837C1	C17-0082	E30-0124	E27-0086
2611630C91	C17-0062	E30-0125 & E30-0126	Not Required
2612521C91	C17-0064	E30-0124	E27-0086
2612521C91	C17-0064	E30-0124	E27-0086
2613113C91	C17-0064	E30-0124	E27-0086
2613113C91	C17-0064	E30-0124	E27-0086
3712647C91	C17-0064	E30-0124	E27-0086
3712647C91	C17-0064	E30-0124	E27-0086
3859691C94	C17-0056	E30-0118	E27-0094
5010812R91	C20-0024	TBD	TBD
5010830R91	C17-0053	E30-0124	E27-0086
5010830R91	C17-0053	E30-0124	E27-0086
5010832R91	C17-0041	E30-0124	E27-0086
5010832R91	C17-0041	E30-0124	E27-0086
5010834R91	C17-0061	E30-0125 & E30-0126	Not Required
5010834R91	C17-0061	E30-0125 & E30-0126	Not Required
5010836R91	C17-0060	E30-0125 & E30-0126	Not Required
5010836R91	C17-0060	E30-0125 & E30-0126	Not Required
5010843R1	C17-0064	E30-0124	E27-0086
5010843R1	C17-0064	E30-0124	E27-0086
5010844R1	C17-0059	E30-0118	E27-0094
5010845R1	C17-0056	E30-0118	E27-0094
5010846R1	C17-0062	E30-0125 & E30-0126	Not Required
5010847R91	C17-0060	E30-0125 & E30-0126	Not Required
5010847R91	C17-0060	E30-0125 & E30-0126	Not Required
5010848R1	C17-0032	E30-0118	E27-0083
5010850R1	C17-0082	E30-0124	E27-0086
5010850R1	C17-0082	E30-0124	E27-0086

**Navistar / International / MaxxForce**

OEM P/N	DuraFit P/N	Gasket P/N	Clamp P/N
82002806	C17-0064	E30-0124	E27-0086
82003341	C17-0060	E30-0125/ E30-0126	Not Required
A00383921	C17-0060	E30-0125 & E30-0126	Not Required
A00383921	C17-0060	E30-0125 & E30-0126	Not Required
2593981C91	C17-0060	E30-0125 & E30-0126	Not Required
2593981C91	C17-0060	E30-0125 & E30-0126	Not Required
2594022C91	C17-0060	E30-0125 & E30-0126	Not Required
2594022C91	C17-0060	E30-0125 & E30-0126	Not Required
2604823C91	C17-0059	E30-0118	E27-0094
2604830C91	C17-0056	E30-0118	E27-0094
2604873C91	C17-0060	E30-0125 & E30-0126	Not Required
2604873C91	C17-0060	E30-0125 & E30-0126	Not Required
2605039C91	C17-0064	E30-0124	E27-0086
2605039C91	C17-0064	E30-0124	E27-0086
2605123C91	C17-0060	E30-0125 & E30-0126	Not Required

\*Not legal for sale or use in the state of California or areas where California emissions compliance is required.

**Navistar / International / MaxxForce**

OEM P/N	DuraFit P/N	Gasket P/N	Clamp P/N
5010851R1	C17-0055	E30-0118	E27-0083
5010851R1	C17-0055	E30-0118	E27-0083
5010852R1	C17-0062	E30-0125 & E30-0126	Not Required
A00317258	C17-0062	E30-0125 & E30-0126	Not Required
A00420195	C17-0064	E30-0124	E27-0086
A00420195	C17-0064	E30-0124	E27-0086
A00574039	C17-0041	E30-0124	E27-0086
A00574039	C17-0041	E30-0124	E27-0086
A00574039	C17-0041	E30-0124	E27-0086
Q621944	C17-0032	E30-0118	E27-0083
Q622369	C17-0055	E30-0118	E27-0083
Q622369	C17-0055	E30-0118	E27-0083
2510616C91	C17-0079	E30-0118	E27-0083
2593981C91	C17-0060	E30-0125/ E30-0126	Not Required
2593981R91	C17-0060	E30-0125/ E30-0126	Not Required
2594022C91	C17-0060	E30-0125/ E30-0126	Not Required
2594131C91	C17-0041	E30-0124	E27-0086
2594131C91	C17-0041	E30-0124	E27-0086
2594131C91	C17-0041	E30-0124	E27-0086
2594131C91	C17-0041	E30-0124	E27-0086
2594131C91	C17-0041	E30-0124	E27-0086
2594131C91	C17-0041	E30-0124	E27-0086
2594131R91	C17-0041	E30-0124	E27-0086
2594131R91	C17-0041	E30-0124	E27-0086
2594131R91	C17-0041	E30-0124	E27-0086
2594131R91	C17-0041	E30-0124	E27-0086
2594165C91	C17-0053	E30-0124	E27-0086
2594165C91	C17-0053	E30-0124	E27-0086
2594165C91	C17-0053	E30-0124	E27-0086
2594165C91	C17-0053	E30-0124	E27-0086
2594165R91	C17-0053	E30-0124	E27-0086
2594165R91	C17-0053	E30-0124	E27-0086
2594200C91	C20-0036	TBD	TBD
2594356C91	C17-0061	E30-0125/ E30-0126	Not Required
2594356C91	C17-0061	E30-0125/ E30-0126	Not Required

**Navistar / International / MaxxForce**

OEM P/N	DuraFit P/N	Gasket P/N	Clamp P/N
2594356C91	C17-0061	E30-0125/ E30-0126	Not Required
2594356C91	C17-0061	E30-0125 & E30-0126	Not Required
2594356C91	C17-0061	E30-0125 & E30-0126	Not Required
2594356R91	C17-0061	E30-0125/ E30-0126	Not Required
2594454C91	C20-0021	TBD	TBD
2594454C91	C20-0021	TBD	TBD
2595714C91	C20-0025	TBD	TBD
2596407C92	C20-0026	TBD	TBD
2596407C92	C20-0026	TBD	TBD
2596665C91	C17-0055	E30-0118	E27-0083
2596665C91	C17-0055	E30-0118	E27-0083
2596665C91	C17-0055	E30-0118	E27-0083
2596665R91	C17-0055	E30-0118	E27-0083
2596690C91	C20-0022	TBD	TBD
2596690C91	C20-0022	TBD	TBD
2597007C91	C20-0021	TBD	TBD
2597007C91	C20-0021	TBD	TBD
2601229C91	C17-0032	E30-0118	E27-0083
2601229C91	C17-0032	E30-0118	E27-0083
2601229R91	C17-0032	E30-0118	E27-0083
2603960C91	C20-0024	TBD	TBD
2603961C91	C17-0059	E30-0118	E27-0084
2603961C91	C17-0059	E30-0118	E27-0094
2604039C91	C20-0023	TBD	TBD
2604046C91	C17-0056	E30-0118	E27-0094
2604046C91	C17-0056	E30-0118	E27-0094
2604430C91	C17-0064	E30-0124	E27-0086
2604430C91	C17-0064	E30-0124	E27-0086
2604430C91	C17-0064	E30-0124	E27-0086
2604430R91	C17-0064	E30-0124	E27-0086
2604430R91	C17-0064	E30-0124	E27-0086
2604823C91	C17-0059	E30-0118	E27-0084
2604823R91	C17-0059	E30-0118	E27-0084
2604830C91	C17-0056	E30-0118	E27-0094
2604830R91	C17-0056	E30-0118	E27-0094
2604870C91	C17-0062	E30-0125/ E30-0126	Not Required

\*Not legal for sale or use in the state of California or areas where California emissions compliance is required.

**Navistar / International / MaxxForce**

OEM P/N	DuraFit P/N	Gasket P/N	Clamp P/N
2604870C91	C17-0062	E30-0125 & E30-0126	Not Required
2604870R91	C17-0062	E30-0125/ E30-0126	Not Required
2604873C91	C17-0060	E30-0125/ E30-0126	Not Required
2605039C91	C17-0064	E30-0124	E27-0086
2605039C91	C17-0064	E30-0124	E27-0086
2605123C1	C17-0060	E30-0125/ E30-0126	Not Required
2605123C1	C17-0060	E30-0125/ E30-0126	Not Required
2605123C91	C17-0060	E30-0125/ E30-0126	Not Required
2605123C91	C17-0060	E30-0125/ E30-0126	Not Required
2605124C1	C17-0082	E30-0124	E27-0086
2605124C1	C17-0082	E30-0124	E27-0086
2605124C1	C17-0082	E30-0124	E27-0086
2605124C1	C17-0082	E30-0124	E27-0086
2605128C1	C20-0027	TBD	TBD
2605128C1	C20-0027	TBD	TBD
2605332C91	C20-0029	TBD	E27-0086
2605332C91	C20-0029	TBD	E27-0086
2605796C91	C17-0062	E30-0125/ E30-0126	Not Required
2605802C1	C20-0027	TBD	TBD
2605802C1	C20-0027	TBD	TBD
2605837C1	C17-0082	E30-0124	E27-0086
2605837C1	C17-0082	E30-0124	E27-0086
2611630C91	C17-0062	E30-0125/ E30-0126	Not Required
2612521C91	C17-0064	E30-0124	E27-0086
2613113C91	C17-0064	E30-0124	E27-0086
3712647C91	C17-0064	E30-0124	E27-0086
3859549C93	C17-0059	E30-0118	E27-0084
3859691C93	C17-0056	E30-0118	E27-0094
3859691C94	C17-0056	E30-0118	E27-0094
3865483C93	C20-0023	TBD	TBD
3869133C93	C20-0023	TBD	TBD
5010811R91	C20-0023	TBD	TBD
5010830R91	C17-0053	E30-0124	E27-0086

**Navistar / International / MaxxForce**

OEM P/N	DuraFit P/N	Gasket P/N	Clamp P/N
5010830R91	C17-0053	E30-0124	E27-0086
5010832R91	C17-0041	E30-0124	E27-0086
5010832R91	C17-0041	E30-0124	E27-0086
5010832R91	C17-0041	E30-0124	E27-0086
5010834R91	C17-0061	E30-0125/ E30-0126	Not Required
5010834R91	C17-0061	E30-0125/ E30-0126	Not Required
5010836R91	C17-0060	E30-0125/ E30-0126	Not Required
5010843R1	C17-0064	E30-0124	E27-0086
5010844R1	C17-0059	E30-0118	E27-0084
5010845R1	C17-0056	E30-0118	E27-0094
5010846R1	C17-0062	E30-0125/ E30-0126	Not Required
5010847R1	C17-0060	E30-0125/ E30-0126	Not Required
5010847R1	C17-0060	E30-0125/ E30-0126	Not Required
5010847R91	C17-0060	E30-0125/ E30-0126	Not Required
5010847R91	C17-0060	E30-0125/ E30-0126	Not Required
5010848R1	C17-0032	E30-0118	E27-0083
5010850R1	C17-0082	E30-0124	E27-0086
5010851R1	C17-0055	E30-0118	E27-0083
5010852R1	C17-0062	E30-0125/ E30-0126	Not Required
5010853R1	C17-0064	E30-0124	E27-0086
5010853R1	C17-0064	E30-0124	E27-0086
5010853R1	C17-0064	E30-0124	E27-0086
5010853R1	C17-0064	E30-0124	E27-0086
5010853R1	C17-0064	E30-0124	E27-0086
5010853R1	C17-0064	E30-0124	E27-0086
5010853R1	C17-0064	E30-0124	E27-0086
5010853R1	C17-0064	E30-0124	E27-0086
5010853R1	C17-0064	E30-0124	E27-0086
5010853R1	C17-0064	E30-0124	E27-0086
5010853R1	C17-0064	E30-0124	E27-0086
5010853R1	C17-0064	E30-0124	E27-0086
5010853R1	C17-0064	E30-0124	E27-0086
5010853R1	C17-0064	E30-0124	E27-0086
5010853R1	C17-0064	E30-0124	E27-0086
5011031R91	C17-0079	E30-0118	E27-0083

### Navistar / International / MaxxForce

OEM P/N	DuraFit P/N	Gasket P/N	Clamp P/N
A00317258	C17-0062	E30-0125/ E30-0126	Not Required
A00383921	C17-0060	E30-0125/ E30-0126	Not Required
A00420195	C17-0064	E30-0124	E27-0086
A00574039	C17-0041	E30-0124	E27-0086
A00574039	C17-0041	E30-0124	E27-0086
A00574039	C17-0041	E30-0124	E27-0086
IP23265	C20-0023	TBD	TBD
Q621944	C17-0032	E30-0118	E27-0083
Q622369	C17-0055	E30-0117	E27-0084

### PACCAR

OEM P/N	DuraFit P/N	Gasket P/N	Clamp P/N
649206	C17-0042	E30-0117	E27-0084
2871581	C17-0068	E30-0118	E27-0083
4969838	C17-0042	E30-0117	E27-0084
1827310PEX	C17-0068	E30-0118	E27-0083
1827739PEX	C17-0037	E30-0118	E27-0083
1906311PEX	C17-0093	TBD	TBD

### Hino

OEM P/N	DuraFit P/N	Gasket P/N	Clamp P/N
S1805E0270	C17-0083	E30-0158	Not Required
S1805E0270	C17-0083	E30-0158	Not Required
S1805E0B5	C17-0092	TBD	Not Required
S1850E0281	C17-0083	E30-0158	Not Required
S1850E0281	C17-0083	E30-0158	Not Required
S1850E0580	C17-0092	TBD	Not Required
S1850E0B00	C17-0092	TBD	Not Required

### Isuzu

OEM P/N	DuraFit P/N	Gasket P/N	Clamp P/N
897608056	C17-0070	TBD	Not Required
897608057	C17-0072	E30-0153	Not Required
897608057	C17-0072	E30-0153	Not Required
898155142	C17-0070	E30-0152 & E30-0153	Not Required
8976080573	C17-0072	E30-0153	Not Required
8981470660	C17-0071	TBD	Not Required
8981551420	C17-0070	E30-0152 & E30-0153	Not Required
8981551420	C17-0070	TBD	Not Required
8-97608-057 -3	C17-0072	E30-0153	Not Required
8-97608-057 -3	C17-0072	E30-0153	Not Required
8-97608057-0	C17-0072	E30-0153	Not Required
8-97608057-0	C17-0072	E30-0153	Not Required
8-97608-057-3	C17-0072	E30-0153	Not Required
8981470660RX	C17-0071	TBD	Not Required
898155142 -0	C17-0070	TBD	Not Required

### Nova Bus

OEM P/N	DuraFit P/N	Gasket P/N	Clamp P/N
N8894071	C17-0031	E30-0118	E27-0083

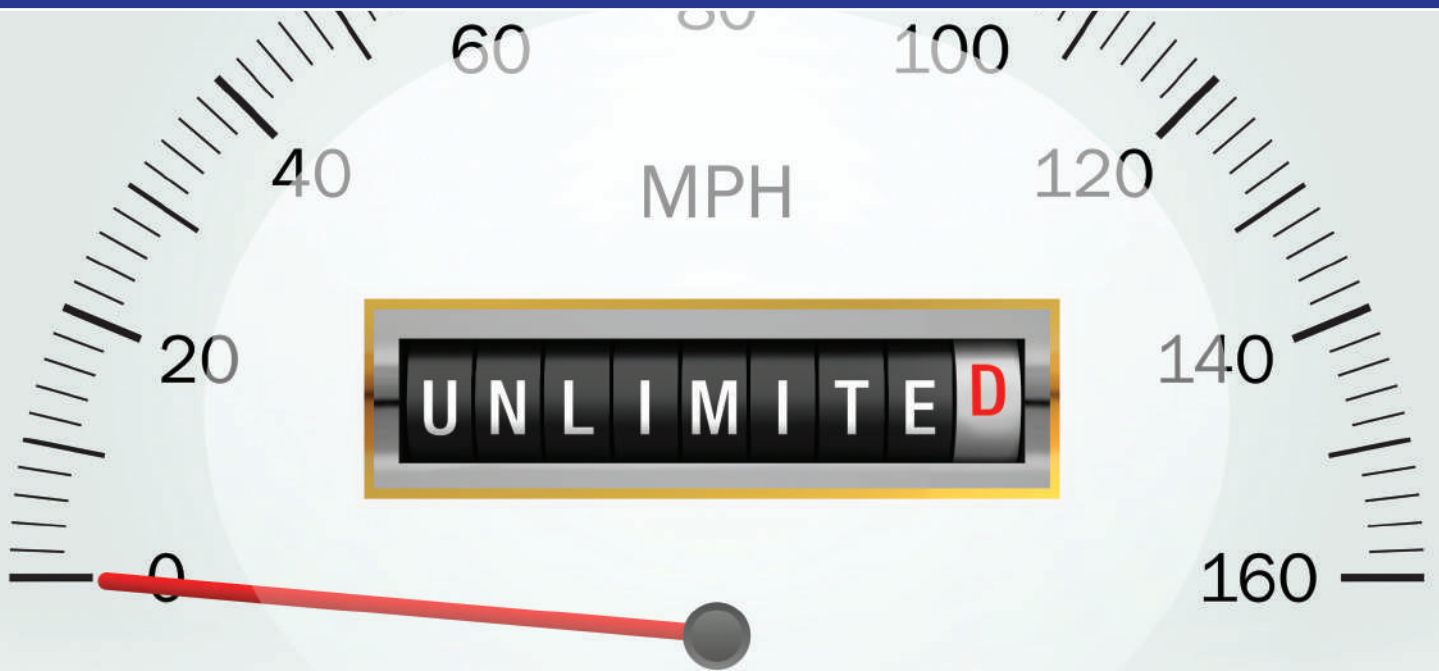

## NATIONWIDE WARRANTY COVERAGE FOR UNLIMITED MILES...

DuraFit DPFs and DOCs are so durable they come with a nationwide 3-year, unlimited mileage warranty.



DuraFit™ heavy duty truck replacement diesel particulate filters (DPFs) and diesel oxidation catalysts (DOCs) pay large dividends in long-term equipment performance and reliability.

DuraFit replacement units are newly-built, exact-fit OEM replacements - engineered and manufactured in the USA for maximum service life. Using improved materials, rugged designs and stringent testing, DuraFit replacement units provide in-field performance that meets or exceeds OEM units.

DuraFit is now part of APC Automotive Technologies' line of leading emissions, aftertreatment and brake products. To learn more about DuraFit's improvements over OEM replacements, or our unlimited mileage warranty, call us at 833-299-3288 or visit our website.

**DURAFIT™**

*OEM Replacement Emission Technologies*

**DESIGNED TO FIT. BUILT TO LAST.™**

# **DIESELTECH™**

**ENGINEERED TO LAST**

## **Heavy Duty Exhaust Catalog**

*including Light/Medium Duty DPFs and DOCs*



LIGHT/MEDIUM DUTY CLASS 3 - 6

## DIESEL PARTICULATE FILTERS & DIESEL OXIDATION CATALYSTS

Available for:  
Ford, GM, Sprinter and  
Dodge / RAM Trucks

- Newly-Manufactured Units with No Required Core Charge
- Warranty Coverage for 2 years or 36,000 Miles on medium duty trucks
- Exact-Fit Replacement Units that Include Gaskets and Retainer Nuts for Quick and Easy Installation
- Flow Performance Equal to or Better than OEM Units to Reduce Backpressure
- Upgraded Stainless Steel Components that Resist Corrosion and Enhance Durability
- Complies with All Current EPA Emissions Standards

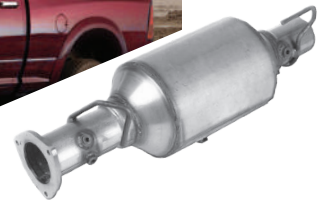

Intelligent Catalyst Technology® by:  ARISTO  
INTELLIGENT CATALYST TECHNOLOGY™

Not legal for sale or use in the state of California or areas where California emissions compliance is required.

## DPF & DOC Cross Reference

## LIGHT/MEDIUM DUTY CLASS 3 - 6

### Chevrolet / GMC

YEAR	APPLICATION	ENGINE	OEM DPF	DT DPF P/N	OEM DOC	DT DOC P/N
2007-2009	Silverado C/K 2500HD / Sierra C/K 2500HD Crew Cab Short Bed (6'6"); 153" Wheelbase Only	Duramax 6.6L	15876232 25928420	649004	15283013	649052
2008-2010	Express 3500 / Savana 3500 - Cutaway Van 139" Wheelbase Only; 2010, VIN #6 Diesel Only	Duramax 6.6L	25784982	649006	15231895	649053
2009-2010	Chevrolet Silverado 3500 STD CAB, GMC Sierra 3500 STD CAB, GMC Sierra Base	Duramax 6.6L	25928415	649008	TBD	TBD

### Dodge / Freightliner

YEAR	APPLICATION	ENGINE	OEM DPF	DT DPF P/N	OEM DOC	DT DOC P/N
2007-2012	Dodge & Ram 2500 - Pickup	Cummins 6.7L	68035060AA 68035060AC	649002	TBD	TBD
2007-2008	Dodge & Ram 3500 - Pickup	Cummins 6.7L	68035060AA 68035060AC	649002	TBD	TBD
2007-2009	Sprinter 2500/3500	Sprinter 3.0L	68011959AA A9064901592	649005	A9064902381	649055
2009-2012	Dodge & RAM 3500 -Pickup	Cummins 6.7L	68035061AA 68035061AB	649003	TBD	TBD
2010-2013	Sprinter - Ram, Dodge & Freightliner COMBO DPF + DOC	Sprinter 3.0L	A906490060080	649010* 649011**	A906490060080	649010* 649011**
2007-2010	2500/3500 CHASSIS CAB - COMBO DPF + DOC	Cummins 6.7L	52121891AG 52121891AC 52121891AD 52121891AE 52121891AF	649009	52121891AG 52121891AC 52121891AD 52121891AE 52121891AF	649009
2013	2500/3500 Pickup	Cummins 6.7L	68087105AG	649012	68087105AG	649012

\*Indicates without integrated elbow

\*\*Indicates with integrated elbow

### Ford

YEAR	APPLICATION	ENGINE	OEM DPF	DT DPF P/N	OEM DOC	DT DOC P/N
2008-2010	F250SD / F350SD / F450SD / Pickup	Powerstroke 6.4L	9C3Z5H221B	649001	9C3Z5H267B	649051
2008-2010	F350SD / F450SD / F550SD Cab & Chassis	Powerstroke 6.4L	9C3Z5H221A	649007	9C3Z5H267A	649057

Not legal for sale or use in the state of California or areas where California emissions compliance is required.



## CLAMPS

### HEAVY DUTY 3/8" U-BOLT TRUCK CLAMPS

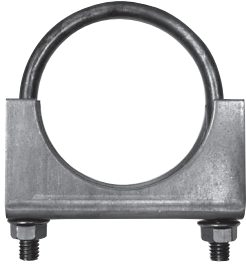

P/N	P/N ZINC	SIZE	BOX QTY
H234P	—	2 3/4"	1
M300	H300PZ	3"	1
H312P	H312PZ	3 1/2"	1
H400P	H400PZ	4"	1
H412P	H412PZ	4 1/2"	1
H500P	H500PZ	5"	1

### HEAVY DUTY GUILLOTINE CLAMPS



P/N	P/N ZINC	P/N CHROME	SIZE	BOX QTY
T234	—	—	2 3/4"	1
T300	T300Z	—	3"	1
T314	—	—	3 1/2"	1
T312	T312Z	—	3 1/2"	1
T400	T400Z	9486	4"	1
—	T412Z	—	4 1/2"	1
T500	T500Z	9487	5"	1
—	T512Z	—	5 1/2"	1
T600	T600Z	9734	6"	1

### EXTRA HEAVY DUTY 3/8" U-BOLT 11 GAUGE SADDLE

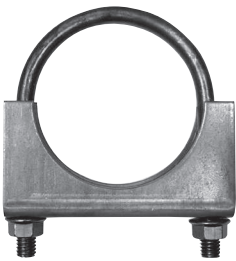

P/N	P/N ZINC	SIZE	BOX QTY
H200	—	2"	1
H218	—	2 1/8"	1
H214	—	2 1/4"	1
H238	—	2 3/8"	1
H212	—	2 1/2"	1
H258*	—	2 5/8"	1
H234*	—	2 3/4"	1

P/N	P/N ZINC	SIZE	BOX QTY
H300*	H300Z	3"	1
H314*	—	3 1/4"	1
H312*	—	3 1/2"	1
H400*	H400Z	4"	1
H412*	—	4 1/2"	1
H500*	H500Z	5"	1
H600*	H600Z	6"	1

\*Welded Saddle

### FLAT 3/8" U-BOLT CLAMPS, WELDED SADDLE

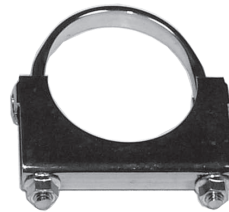

P/N ZINC	P/N CHROME	SIZE	BOX QTY
9501	9490	3"	1
9502	—	3 1/2"	1
9503	9492	4"	1
9504	9493	5"	1
9736	—	5 1/2"	1
9506	9495	6"	1

## BAND CLAMPS



### TorcTite™ PREFORMED CLAMPS w/ GASKET - LAP JOINT



P/N	SIZE	MATERIAL
9700	3"	ALUMINIZED STEEL
9701	3½"	ALUMINIZED STEEL
9702	4"	ALUMINIZED STEEL
9703	5"	ALUMINIZED STEEL
9730	3"	BRIGHT 304 STAINLESS STEEL
9731	3½"	BRIGHT 304 STAINLESS STEEL
9732	4"	BRIGHT 304 STAINLESS STEEL
9733	5"	BRIGHT 304 STAINLESS STEEL

MUFFLERS, PIPES,  
& ACCESSORIES



### TorcTite™ PREFORMED CLAMPS - LAP JOINT



SIZE	ALUMINIZED STEEL	BRIGHT 304 STAINLESS STEEL
2"	9660	9664
2¼"	9661	9665
2½"	9662	9666
2¾"	9663	9667
3"	9604	9668
3½"	9605	9669
4"	9606	9623
4½"	9607	9670
5"	9607	9624
6"	—	9671



### TorcTite™ PREFORMED CLAMPS - BUTT JOINT



SIZE	ALUMINIZED STEEL	BRIGHT 304 STAINLESS STEEL
2"	—	9684
2¼"	—	9685
2½"	—	9686
2¾"	—	9687
3"	9676	9688
3½"	9678	9690
4"	9680	9692
4½"	—	9693
5"	9682	9694
6"	9683	9695

## BAND CLAMPS



### TorcTite™ FLATBAND EXHAUST CLAMP

SIZE	ALUMINIZED STEEL	BRIGHT 304 STAINLESS STEEL
2"	AS200	SAS200
2¼"	AS214	SAS214
2½"	AS212	SAS212
2¾"	AS234	SAS234
3"	AS300	SAS300
3½"	AS312	SAS312
4"	AS400	SAS400
5"	AS500	SAS500
6"	—	SAS600

MUFFLERS, PIPES,  
& ACCESSORIES

### FLATBAND EXHAUST CLAMPS



P/N	SIZE	MATERIAL
B200	2"	BRIGHT 304 STAINLESS STEEL
B214	2¼"	BRIGHT 304 STAINLESS STEEL
B212	2½"	BRIGHT 304 STAINLESS STEEL
B234	2¾"	BRIGHT 304 STAINLESS STEEL
B300	3"	BRIGHT 304 STAINLESS STEEL
B314	3¼"	BRIGHT 304 STAINLESS STEEL
B312	3½"	BRIGHT 304 STAINLESS STEEL
B400	4"	BRIGHT 304 STAINLESS STEEL
B412	4½"	BRIGHT 304 STAINLESS STEEL
B500	5"	BRIGHT 304 STAINLESS STEEL
B600	6"	BRIGHT 304 STAINLESS STEEL
B800	8"	BRIGHT 304 STAINLESS STEEL
B1000	10"	BRIGHT 304 STAINLESS STEEL

## V-BAND CLAMPS

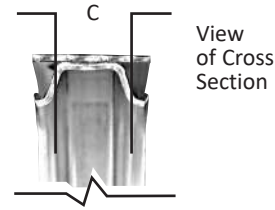
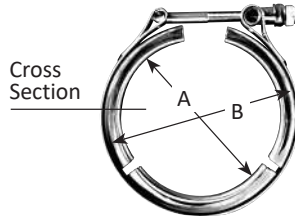

Manufacturer	P/N	TUBE DIA.	A	B	C	APPLICATION
<b>UNIVERSAL</b>						
	9398	3.00"	3.26"	4.06"	0.21"	Fits - OEM MUFFLERS.
	9399	4.00"	4.25"	4.81"	0.21"	Fits - FLARED CONNECTORS
	9616	5.00"	4.97"	5.25"	0.26"	Fits - FLARED CONNECTORS
<b>AIRESEARCH</b>						
	9614	4.00"	4.17"	4.61"	0.16"	TEO-699
	9616	5.00"	5.97"	5.25"	0.21"	T-1899, TH08A64
<b>BLUE BIRD</b>						
	9618	2.75"	2.80"	3.20"	0.26"	REPLACES BLUEBIRD #1334226
	9618	2.75"	2.80"	3.20"	0.26"	94-98 BLUEBIRD TC2000 SCHOOL BUS W/5.9L
	9651	4.00"	4.13"	4.69"	0.40"	REPLACES BLUEBIRD #125046
	9651	4.00"	4.13"	4.69"	0.40"	BLUEBIRD ALL AMERICAN W/CAT3116 /TURBO
	9399	4.00"	4.25"	4.81"	0.21"	REPLACES BLUEBIRD #0997791
	9399	4.00"	4.25"	4.81"	0.21"	1980-90 BLUEBIRD SCHOOL BUS W/8.2LT
<b>CATERPILLAR</b>						
	9622	3.50"	3.63"	4.19"	0.40"	3208T
	9396	3.50"	3.94"	4.50"	0.21"	3208T
	9651	4.00"	4.13"	4.69"	0.40"	3208T
	9652	4.00"	4.12"	4.81"	0.40"	3176T
	9653	4.00"	4.19"	4.75"	0.40"	3176T
	9615	5.00"	5.32"	5.88"	0.40"	3406, 3406B, 3176
<b>CUMMINS</b>						
	9618	2.75"	2.80"	3.20"	0.26"	6BT5.9L, 6BTA5.9L
	9612	3.00"	3.32"	3.88"	0.40"	V555, V902, V903
	9627	3.50"	3.69"	4.25"	0.40"	VT555, VT-555 MANIFOLD
	9396	3.50"	3.94"	4.50"	0.21"	VT555, VT-555 MANIFOLD
	9652	4.00"	4.12"	4.81"	0.40"	L10
	9653	4.00"	4.19"	4.75"	0.40"	L10
	9615	5.00"	5.32"	5.88"	0.40"	750, N, 88NT, NTC, VT
<b>DETROIT DIESEL</b>						
	9395	3.00"	3.26"	3.82"	0.21"	6V53, 6V71
	9656	3.50"	3.76"	4.04"	0.26"	
	9613	3.50"	3.77"	4.33"	0.21"	
	9396	3.50"	3.94"	4.50"	0.21"	4-53, 8V71, 8V92
	9617	4.00"	4.13"	4.75"	0.16"	8.2LT
	9399	4.00"	4.25"	4.81"	0.21"	6-71T, 8.2N, 8.2T, 12V71
	9647	4.00"	4.32"	4.91"	0.29"	6-71N
	9735	4.00"	4.97"	5.25"	0.26"	8V-71T, 16V-71, 6V-92T, 8V-92, 8V-92T, 16V-92T
	9616	5.00"	4.97"	5.25"	0.26"	8V-71T
	9397	5.00"	5.32"	5.92"	0.28"	6V-92
	9397	5.00"	5.32"	5.92"	0.28"	8V-71T (END AWAY FROM TURBO)
	9397	5.00"	5.32"	5.92"	0.28"	
	9615	5.00"	5.32"	5.88"	0.40"	SERIES 60, 6-71T

MUFFLERS, PIPES,  
& ACCESSORIES

## V-BAND CLAMPS (CONT.)

Manufacturer	P/N	TUBE DIA.	A	B	C	APPLICATION
<b>FORD</b>						
	9610	3.00"	3.25"	3.87"	0.43"	FORD #E5HZ5A231B
	9618	2.75"	2.80"	3.20"	0.26"	93-95 B600/700 W/5.9LT
	9618	2.75"	2.80"	3.20"	0.26"	REPLACES FORD #F3HZ5A281A
	9656	2.50"	3.76"	4.04"	0.26"	FORD #E0HZ5A231B
	9625	3.00"	3.05"	3.62"	0.28"	REPLACES FORD #F1HZ5C210A, E9HZ5A231B
	9625	3.00"	3.05"	3.62"	0.28"	89-95 MED/TRUCK,BUS W/370, 429 GAS
	9395	3.00"	3.26"	3.82"	0.21"	ALL MODELS W/DD 6V53, 6V71
	9395	3.00"	3.26"	3.82"	0.21"	ALL MODELS W/CUMMINS V555, V902
	9626	3.00"	3.17"	3.88"	0.40"	FORD D9HT-51210-DA
	9626	3.00"	3.17"	3.88"	0.40"	79-88 FORD MED TRUCK/BUS W/370, 429 GAS
	9611	3.00"	3.47"	4.06"	0.24"	8.2L NA
	9622	3.50"	3.50"	4.19"	0.40"	REPLACES FORD #E2HZ5A231A
	9622	3.50"	3.63"	4.19"	0.40"	87-90 B600/700 SCHOOL BUS CF600/800 W/6.6LT
	9622	3.50"	3.63"	4.19"	0.40"	REPLACES FORD #E8HZ5A231E
	9627	3.50"	3.69"	4.25"	0.40"	87-94 CF600/800, F600/800 W/7.8LT
	9627	3.50"	3.69"	4.25"	0.40"	REPLACES FORD #E7HZ5A231C
	9617	4.00"	4.13"	4.75"	0.16"	REPLACES FORD #E0HZ5A231C
	9399	4.00"	4.25"	4.81"	0.21"	ALL MODELS W/DD 6-71T, 8.2N, 8.2T, 12V71
<b>FREIGHTLINER</b>						
	9601	3.50"	3.38"	3.75"	0.75"	02-06 FREIGHTLINER BUS W/MERCEDES ENG. OE#A04-19184-000
	9609	4.00"	4.19"	4.75"	0.40"	FREIGHTLINER BUS W/MERCEDES 6 CYL. ENG.
	9615	5.00"	5.32"	5.88"	0.40"	FLD MODELS W/DD SERIES 60, CAT 3406
	9615	5.00"	5.32"	5.88"	0.40"	FLD MODELS W/CUMMINS NTC, VT DIESEL
	9615	5.00"	5.32"	5.88"	0.40"	REPLACES FREIGHTLINER #0114596000
<b>GM</b>						
	9656	3.50"	3.76"	4.04"	0.26"	
	9611	3.00"	3.50"	4.06"	0.24"	80-90-GM MED TRUCK/BUS W/8.2L NA
	9611	3.00"	3.50"	4.06"	0.24"	REPLACES GM #2069773
	9652	4.00"	4.12"	4.81"	0.40"	TOPKICK/KODIAK W/6.6L
	9652	4.00"	4.12"	4.81"	0.40"	REPLACES GM #15647159
	9399	4.00"	4.25"	4.81"	0.21"	ALL MODELS W/DD6-71T, 8.2N, 8.2T, 12V71
<b>INTERNATIONAL</b>						
	9627	3.50"	3.69"	4.25"	0.40"	86-89 SERIES S TRUCK/BUS W/DT360
	9627	3.50"	3.69"	4.25"	0.40"	REPLACES INTERNATIONAL #893944R92
	9613	3.50"	3.77"	4.33"	0.21"	REPLACES INTERNATIONAL #338614C1
	9613	3.50"	3.77"	4.33"	0.21"	88-94 SERIES S TRUCK BUS W/DT466
	9396	3.50"	3.94"	4.50"	0.21"	REPLACES INTERNATIONAL #434252R91
	9396	3.50"	3.94"	4.50"	0.21"	ALL MODELS W/DD 4-53, 8V71, 8V92, CAT 3208T
	9396	3.50"	3.94"	4.50"	0.21"	ALL MODELS W/CUMMINS VT-555
	9737	3.00"	3.28"	3.84"	0.40"	T444E 1994-2000 INTERNATIONAL BUS
	9653	4.00"	4.19"	4.75"	0.40"	REPLACES INTERNATIONAL #893945R92
	9653	4.00"	4.19"	4.75"	0.40"	7.3L, DT-DTA 360, DT-DTA 466
	9647	4.00"	4.32"	4.91"	0.29"	REPLACES INTERNATIONAL #433192R91
	9647	4.00"	4.32"	4.91"	0.29"	ALL MODELS W/6-71N
	9735	4.00"	4.97"	5.25"	0.26"	9300 SERIES W/DD 8V71, 8V92
	9735	4.00"	4.97"	5.25"	0.26"	REPLACES INTERNATIONAL #5132650
	9735	4.00"	4.97"	5.25"	0.26"	REPLACES INTERNATIONAL # 780067C91
	9615	5.00"	5.32"	5.88"	0.40"	REPLACES INTERNATIONAL #390226C91
	9615	5.00"	5.32"	5.88"	0.40"	INTERNATIONAL #1672105C91

## V-BAND CLAMPS (CONT.)

Manufacturer	P/N	TUBE DIA.	A	B	C	APPLICATION
<b>MACK</b>						
	9396	3.50"	3.94"	4.50"	0.21"	ALL MODELS W/DD 4-53, 8V71, 8V92, CAT 3208T
	9396	3.50"	3.94"	4.50"	0.21"	ALL MODELS W/CUMMINS VT-555
	9614	4.00"	4.17"	4.61"	0.16"	REPLACES MACK #48RU2341
	9614	4.00"	4.17"	4.61"	0.16"	DM/MR MODELS
	9399	4.00"	4.25"	4.81"	0.21"	ALL MODELS W/DD6-71T, 8.2N, 8.2T, 12V71
	9619	4.00"	4.38"	4.94"	0.18"	REPLACES MACK #11ME29
	9615	5.00"	5.32"	5.88"	0.40"	REPLACES MACK #11ME241
<b>PETERBILT</b>						
	9616	5.00"	4.97"	5.25"	0.26"	PETERBILT #14-11039
<b>THOMAS</b>						
	9622	3.50"	3.63"	4.19"	0.40"	84-90 SAF-T-LINER MODELS W/3208T
	9622	3.50"	3.63"	4.19"	0.40"	REPLACES THOMAS #61240207
	9651	4.00"	4.13"	4.69"	0.40"	84-89 THOMAS SCHOOL BUS W/ 3208T
	9651	4.00"	4.13"	4.69"	0.40"	REPLACES THOMAS #61240208
	9397	5.00"	5.32"	5.92"	0.28"	90-93 THOMAS SCHOOL BUS W/6V92
	9397	5.00"	5.32"	5.92"	0.28"	REPLACES THOMAS #61240715

MUFFLERS, PIPES,  
& ACCESSORIES

## MUFFLER CEMENT

### Part No. T27-16oz.

This high-performance muffler cement applies like putty but dries metal hard. Available in cases of 12 only.



## MINI-SAW CUTTING BLADES

### Part No. UP1150

(Three replacement cutting wheels)

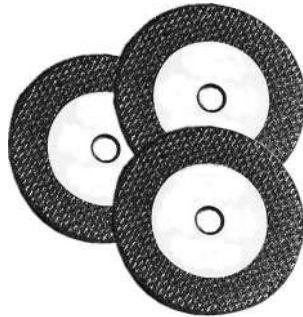

## PIPE HOOKS

50 PER PACKAGE

### Part No.

**FPH51** – (1½" to 2½" Dia.)  
Foreign car pipe hooks.

**PH450** – (2¾" to 4" Dia.)  
H.D. pipe hooks.

**PH50** – (1½" to 2½" Dia.)  
Pipe hooks.

**PH550** – (5" to 6" Dia.)  
H.D. pipe hooks.

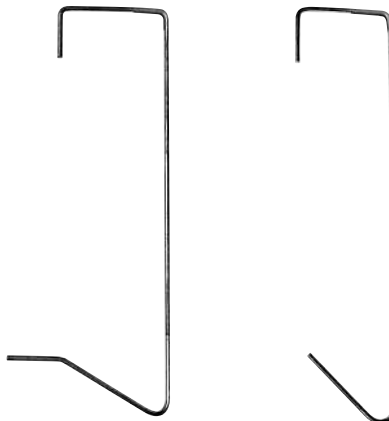

## FLEX TUBING

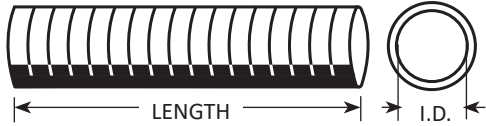

### HOW TO ORDER

Determine your usage needs. Flex pipe is sold in a variety of lengths including pre-cut lengths. All lengths range from 1" to 6" in diameter. Refer to the chart on the pages 24 - 25 to determine your desired part number.

**Order by the part number, not by the foot.**

### HOW TO MEASURE

When you are ready to put Flex Pipe to use, follow these instructions for determining length to cut the Flex pipe. **Note:** All flexible metal tubing is measured fully extended.

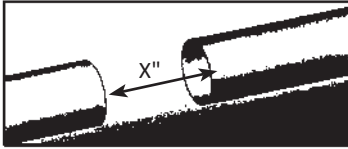

Determine the length (x") of pipe needed for your application by measuring the gap between the two pipes you wish to connect.

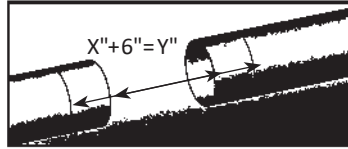

Allow a 3" overlap for each end (add 6" to the original measurement) This is the length (y") of Flex Pipe needed.

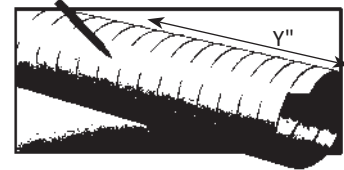

Measure distance needed from the far right side inward. Wrap area to be cut with duct tape. Use a marker to draw a cut guide on the tape. Flex Pipe is now ready to be cut. Cut through the tape. Remove tape from Flex Pipe before using.

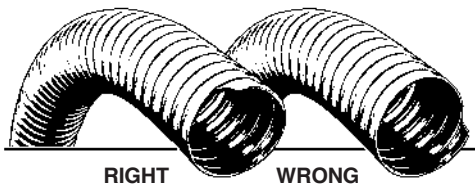

**IMPORTANT:** When **Measuring & Cutting**, keep the open side of the Flex Pipe to your right. To determine the open end, turn the end of the pipe toward you and look for the rings to wrap **ON TOP** of each other.

### HOW TO CUT

There are three ways to cut Flex Pipe. Select one that suits your equipment.

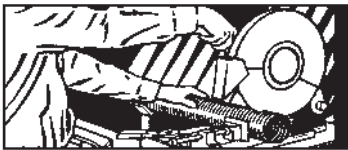

**CHOP SAW:** For best results use 1/16" wide blade. Make sure Flex Pipe has the open side to the right. Align and secure pipe so cut guide lines up with Chop Saw blade, and cut.

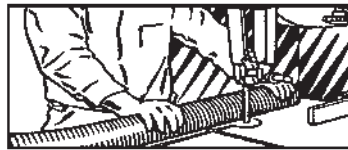

**BAND SAW:** For best results use a no-set blade with 24-32 teeth/inch. Make sure Flex Pipe has the open side to the right. Align and secure pipe so cut guide lines up with band saw blade, and cut.



**HACK SAW:** For best results use a no-set blade with 24-32 teeth/inch. Make sure Flex Pipe has the open side to the right. Align and secure pipe and cut on guide line.



## FLEX TUBING

### FLEX TUBING 10 FOOT LENGTHS



P/N STAINLESS STANDARD THICKNESS	P/N ALUMINIZED HEAVY DUTY THICKNESS	P/N GALVANIZED HEAVY DUTY THICKNESS	ID
8883	—	8984	2"
8855	—	—	2¼"
8884	8858	8985	2½"
8885	8859	8986	3"
8886	8876	8987	3½"
8887	8856	8988	4"
8888	8857	8989	5"
8895	—	8990	6"
—	—	8893	8"
—	—	8894	10"

### PRE-CUT FLEX HOSE STYLE ID-OD



P/N STAINLESS	P/N GALVANIZED	LGTH.
<b>3" DIA</b>		
—	24674	18"
<b>3½" DIA</b>		
—	24935	18"
<b>4" DIA</b>		
—	24654	18"
<b>5" DIA</b>		
—	24936	18"

### FLEX TUBING 25 FOOT LENGTHS



P/N STAINLESS STANDARD THICKNESS	P/N GALVANIZED STANDARD THICKNESS	P/N GALVANIZED HEAVY DUTY THICKNESS	ID
—	8860	—	1"
—	8861	—	1¼"
—	8862	—	1½"
—	8863	—	1¾"
—	8864	—	2"
—	8865	—	2¼"
—	8866	—	2½"
—	8867	—	2¾"
—	8868	—	3"
—	8869	—	3¼"
—	8870	—	3½"
—	8872	—	4"
8982	8875	8880	5"
8983	—	8881	6"
8878	—	8882	8"
8879	—	8877	10"
8899	—	8898	12"

### STAINLESS STEEL BELLOWS PIPE

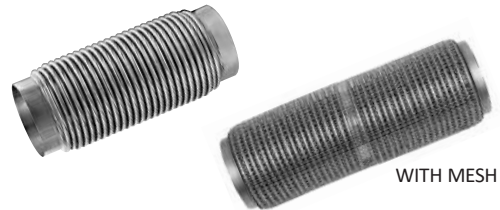

P/N	DIA	LGTH.
9726	3"	12"
9727	3½"	12"
9728	4"	12"
*28819	4"	14½"
9729	5"	12"

\* WITH S.S. OUTER MESH

## FLEX TUBING

### PRE-CUT FLEX HOSE STYLE ID-ID

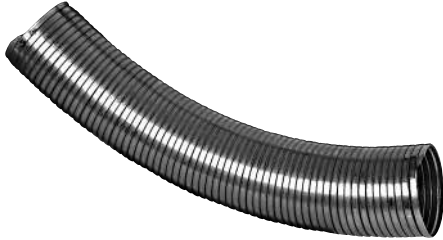

P/N STAINLESS	P/N ALUMINIZED	P/N GALVANIZED	LGTH.
<b>3" DIA</b>			
24675	—	24752	18"
—	—	24930	24"
—	—	34826	36"
<b>3½" DIA</b>			
24676	—	24753	18"
—	—	24849	24"
—	—	34785	36"
<b>4" DIA</b>			
14739	—	14738	12"
24677	24931	24754	18"
24836	—	24835	24"
34673	—	34743	36"
—	—	44786	48"
64791	—	64793	72"
<b>5" DIA</b>			
14737	—	14740	12"
24678	24933	24755	18"
24838	—	24837	24"
34674	—	34744	36"
44867	—	54831	48"
64792	—	64794	72"
<b>6" DIA</b>			
—	—	44915	48"

### STAINLESS STEEL O. E. REPLACEMENT BELLOWS

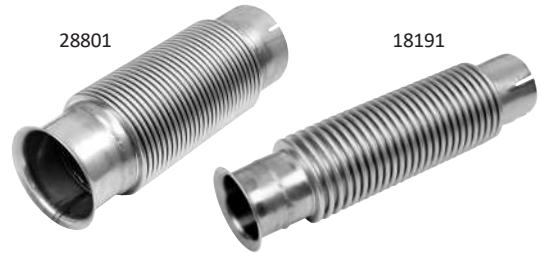

P/N	APPLICATION	O.E.#	INLET/OUTLET/ LENGTH
<b>28801</b>	2007 & Up; Bluebird All- American School Bus, C7 Caterpillar w/ PDF	0109851	Flared x 4" ID x 13 <sup>11</sup> / <sub>16</sub> " Located after Turbo Pipe
<b>18191</b>	2007 & Up; Bluebird All- American School Bus, C7 Caterpillar w/ PDF	0118999	Flared x 2½" ID x 12¾" Located after DPF

MUFFLERS, PIPES,  
& ACCESSORIES

## CONNECTORS & ADAPTERS

### FLARED ADAPTERS

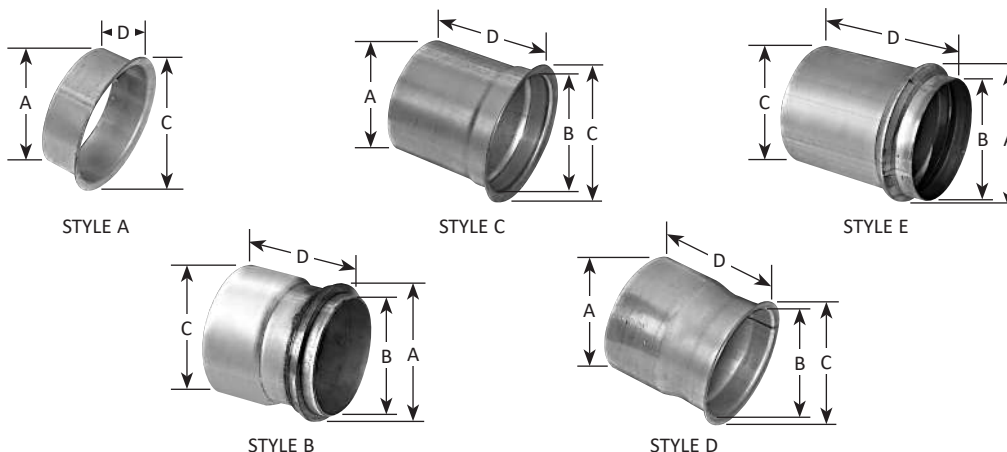

P/N	STYLE	A (O.D.)	B (I.D.)	C (O.D.)	D (LGTH.)	FLARE IN DEG.	APPLICATION	USE W/ V-BAND CLAMP
9706	D	3.977	2.836	3.970	3.482	20		9398
9707	A	2.500	3.345	3.695	1.532	20		9395
9390	A	NA	NA	NA	NA	20	FORD MOTOR CO, DETROIT DIESEL 6V71, 7V73, CUMMINS V555, V902	NA
9470	C	3.005	3.028	3.618	4.181	22	DETROIT DIESEL 6V71	9395
9708	A	3.005	2.869	3.541	3.568	45		NA
9471	C	3.005	3.040	3.775	4.522	45		9395
9479	A	3.183	3.015	3.915	2.200	20	GMC TRUCK/BUS W/ 8.2N	9611
9709	A	3.512	3.385	4.071	4.176	22	CAT 3208T	9611
9710	A	3.350	3.373	4.025	5.018	45	DETROIT DIESEL 6V71	9622
9392	C	3.525	3.505	4.320	6.095	45		9396
9473	C	3.490	3.630	4.165	4.035	22	DETROIT DIESEL 8V-71	9613
9711	C	3.520	3.620	4.270	4.100	22	DETROIT DIESEL 8V-72	9396
9712	C	3.480	3.670	4.212	4.140	22	DETROIT DIESEL 8V-73	9613
9391	A	3.010	2.865	3.905	1.310	20	DETROIT DIESEL 8V92, 4-53	9611
9713	D	3.990	3.605	4.260	4.050	22	DETROIT DIESEL 8V-71	9613
9476	C	NA	NA	NA	NA	22	DETROIT DIESEL 12V71	NA
9472	D	3.960	3.550	4.305	3.868	22	DETROIT DIESEL 8.2N, CUMMINS VT225	9396
9714	C	4.005	3.975	4.500	5.922	45		NA
9474	A	3.950	3.850	4.535	1.810	22	DETROIT DIESEL 6-71, 8.2N, 8.2T, MACK	NA
9475	C	3.985	3.875	4.540	5.170	45	CUMMINS	NA
♣9715	B	5.13	4.250	4.800	1.940	20	DETROIT DIESEL 8V-71T, 16V-71T, 6V-92T, 8V-92T	NA
9393	A	5.005	4.880	5.475	6.275	45	CUMMINS	NA
9478	A	5.035	4.870	5.720	3.025	22	CATERPILLAR TURBO, CUMMINS TURBO, INTERNATIONAL	9615
9716	A	4.990	4.825	5.572	5.608	20	INTERNATIONAL	NA
9717	A	5.010	4.885	5.845	6.287	20	T-50 TURBO CHARGER	9616
9394	C	NA	NA	NA	NA	45	T-50 TURBO CHARGER	NA
9718	B	5.150	4.215	4.780	2.045	20	DETROIT DIESEL 8V-71T, 16V-71, 6V-92T, 8B-92T, 16V-92T	NA
9719	E	5.658	4.825	4.998	6.168	NA	CUMMINS ENGINES	9615

♣ WITH MACHINED RING

## ALUMINIZED REDUCERS

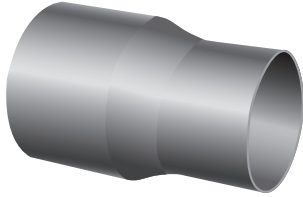

### OD - ID

Reduces larger I.D. pipe to smaller O.D. pipe.

P/N	OD - ID	LENGTH
8663	1 <sup>5</sup> / <sub>8</sub> " - 1 <sup>1</sup> / <sub>2</sub> "	4"
8661	1 <sup>7</sup> / <sub>8</sub> " - 1 <sup>3</sup> / <sub>4</sub> "	4 <sup>1</sup> / <sub>2</sub> "
8650	2" - 1 <sup>1</sup> / <sub>2</sub> "	4 <sup>1</sup> / <sub>2</sub> "
8651	2" - 1 <sup>5</sup> / <sub>8</sub> "	4"
8902	2" - 1 <sup>3</sup> / <sub>4</sub> "	5 <sup>3</sup> / <sub>4</sub> "
8652	2" - 1 <sup>7</sup> / <sub>8</sub> "	5 <sup>1</sup> / <sub>8</sub> "
8653	2 <sup>1</sup> / <sub>4</sub> " - 1 <sup>3</sup> / <sub>4</sub> "	5"
8938	2 <sup>1</sup> / <sub>4</sub> " - 2"	4"
8941	2 <sup>1</sup> / <sub>2</sub> " - 2"	4"
8654	2 <sup>1</sup> / <sub>2</sub> " - 2"	9 <sup>1</sup> / <sub>2</sub> "
8942	2 <sup>1</sup> / <sub>2</sub> " - 2 <sup>1</sup> / <sub>4</sub> "	4"
8655	2 <sup>1</sup> / <sub>2</sub> " - 2 <sup>1</sup> / <sub>4</sub> "	9 <sup>1</sup> / <sub>2</sub> "
9600	3" - 2 <sup>1</sup> / <sub>2</sub> "	6 <sup>1</sup> / <sub>4</sub> "
9334	3" - 2 <sup>3</sup> / <sub>4</sub> "	6"
9333	3 <sup>1</sup> / <sub>2</sub> " - 3"	6"
9722	4" - 3"	6"
9332	4" - 3 <sup>1</sup> / <sub>2</sub> "	6"
9331	5" - 4"	6"
9723	5" - 4 <sup>1</sup> / <sub>2</sub> "	6"
8969	6" - 5"	6"

### ID - ID

Reduces O.D. pipes of different sizes.

P/N	ID - ID	LENGTH
8920	1 <sup>5</sup> / <sub>8</sub> " - 1 <sup>1</sup> / <sub>2</sub> "	4"
8921	1 <sup>3</sup> / <sub>4</sub> " - 1 <sup>1</sup> / <sub>2</sub> "	4"
8922	2" - 1 <sup>1</sup> / <sub>2</sub> "	4"
8923	2" - 1 <sup>5</sup> / <sub>8</sub> "	4"
8944	2" - 1 <sup>3</sup> / <sub>4</sub> "	4 <sup>1</sup> / <sub>2</sub> "
8945	2" - 1 <sup>7</sup> / <sub>8</sub> "	4 <sup>1</sup> / <sub>2</sub> "
8924	2 <sup>1</sup> / <sub>8</sub> " - 2"	4"
8946	2 <sup>1</sup> / <sub>4</sub> " - 2"	4 <sup>1</sup> / <sub>2</sub> "
8947	2 <sup>1</sup> / <sub>2</sub> " - 2"	4 <sup>1</sup> / <sub>2</sub> "
8948	2 <sup>1</sup> / <sub>2</sub> " - 2 <sup>1</sup> / <sub>4</sub> "	4 <sup>1</sup> / <sub>2</sub> "
8952	2 <sup>3</sup> / <sub>4</sub> " - 2 <sup>1</sup> / <sub>2</sub> "	6"
8953	3" - 2 <sup>1</sup> / <sub>2</sub> "	6"
8954	3" - 2 <sup>3</sup> / <sub>4</sub> "	6"
8955	3 <sup>1</sup> / <sub>2</sub> " - 3"	6"
8956	4" - 3"	6"
8957	4" - 3 <sup>1</sup> / <sub>2</sub> "	8"
8958	5" - 4"	8"
9721	5" - 4 <sup>1</sup> / <sub>2</sub> "	6"
9335	6" - 5"	8"

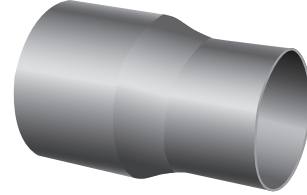

### ID - OD

Reduces larger O.D. pipe to smaller I.D. pipe.

P/N	ID - OD	LENGTH
8925	1 <sup>1</sup> / <sub>2</sub> " - 1 <sup>3</sup> / <sub>8</sub> "	4"
8926	1 <sup>5</sup> / <sub>8</sub> " - 1 <sup>1</sup> / <sub>2</sub> "	4"
8927	1 <sup>3</sup> / <sub>4</sub> " - 1 <sup>1</sup> / <sub>2</sub> "	4"
8928	1 <sup>3</sup> / <sub>4</sub> " - 1 <sup>5</sup> / <sub>8</sub> "	4"
8929	1 <sup>7</sup> / <sub>8</sub> " - 1 <sup>1</sup> / <sub>2</sub> "	4"
8935	1 <sup>7</sup> / <sub>8</sub> " - 1 <sup>3</sup> / <sub>4</sub> "	4 <sup>1</sup> / <sub>2</sub> "
8936	2" - 1 <sup>3</sup> / <sub>4</sub> "	4 <sup>1</sup> / <sub>2</sub> "
8930	2" - 1 <sup>13</sup> / <sub>16</sub> "	4"
8660	2" - 1 <sup>7</sup> / <sub>8</sub> "	4"
8909	2 <sup>1</sup> / <sub>8</sub> " - 2"	5 <sup>3</sup> / <sub>4</sub> "
8931	2 <sup>1</sup> / <sub>4</sub> " - 1 <sup>7</sup> / <sub>8</sub> "	4"
8911	2 <sup>1</sup> / <sub>4</sub> " - 2"	5 <sup>3</sup> / <sub>4</sub> "
8932	2 <sup>1</sup> / <sub>4</sub> " - 2 <sup>1</sup> / <sub>8</sub> "	4"
8913	2 <sup>1</sup> / <sub>2</sub> " - 2"	5 <sup>3</sup> / <sub>4</sub> "
8940	2 <sup>1</sup> / <sub>2</sub> " - 2 <sup>1</sup> / <sub>4</sub> "	4 <sup>1</sup> / <sub>2</sub> "
8959	2 <sup>3</sup> / <sub>4</sub> " - 2 <sup>1</sup> / <sub>2</sub> "	6"
8960	3" - 2 <sup>1</sup> / <sub>2</sub> "	6"
8961	3" - 2 <sup>3</sup> / <sub>4</sub> "	6"
8962	3 <sup>1</sup> / <sub>2</sub> " - 3"	6"
8963	4" - 3"	6"
8964	4" - 3 <sup>1</sup> / <sub>2</sub> "	6"
8965	5" - 4"	6"
9336	6" - 5"	6"

### OD - OD

Reduces larger O.D. pipe to smaller I.D. pipe.

P/N	OD - OD	LENGTH
8904	2" - 1 <sup>13</sup> / <sub>16</sub> "	5 <sup>3</sup> / <sub>4</sub> "
8908	2 <sup>1</sup> / <sub>8</sub> " - 2"	7 <sup>1</sup> / <sub>4</sub> "
8657	2 <sup>1</sup> / <sub>4</sub> " - 2"	4"
8912	2 <sup>1</sup> / <sub>4</sub> " - 2"	5 <sup>3</sup> / <sub>4</sub> "
8658	2 <sup>1</sup> / <sub>2</sub> " - 2"	9 <sup>1</sup> / <sub>2</sub> "
8659	2 <sup>1</sup> / <sub>2</sub> " - 2 <sup>1</sup> / <sub>4</sub> "	9 <sup>1</sup> / <sub>2</sub> "
9648	4" - 3"	8"
9649	5" - 4"	8"
9720	6" - 4"	6"
9650	6" - 5"	8"

## ALUMINIZED CONNECTORS



### ID - OD

Connects I.D. and O.D. pipes of the same size.

P/N	ID - OD	LENGTH
8975	3" - 3"	6"
8976	3½" - 3½"	6"
8991	4" - 4"	6"
8978	5" - 5"	6"
8979	6" - 6"	6"

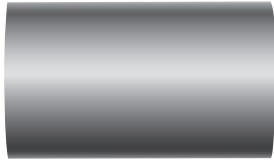

### OD - OD

Connects I.D. pipes of the same size.

P/N	OD - OD	LENGTH
8970	3" - 3"	6"
8971	3½" - 3½"	6"
8972	4" - 4"	8"
8973	5" - 5"	8"

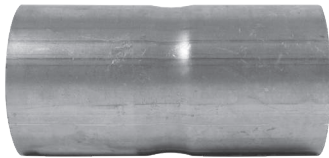

### ID - ID

Connects O.D. pipes of the same size.

P/N	ID - ID	LENGTH
14337	2" - 2"	4"
14338	2½" - 2½"	4"
8980	2¾" - 2¾"	4"
14339	3" - 3"	4"
14601	3" - 3"	6"
14340	3½" - 3½"	4"
14602	3½" - 3½"	6"
14603	4" - 4"	6"
14341	4" - 4"	4"
14605	5" - 5"	6"
8974	6" - 6"	6"

## ALUMINIZED CONNECTORS

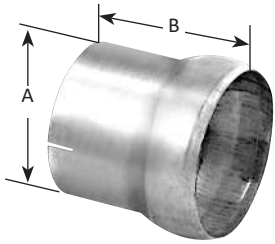

**TILT CAB BOTTOM**

P/N	A	B
9343	4" ID	4½"
9344	5" ID	5¾"

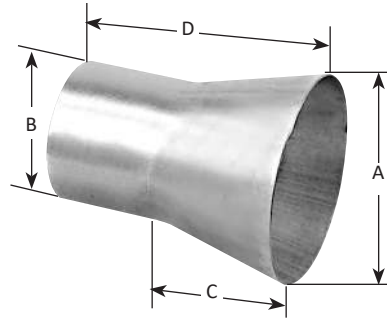

**TILT CAB TOP**

P/N	A	B	C	D
9341	5¾" OD	4" OD	2½"	7"
9342	6¾" OD	5" OD	2½"	7⅝"

MUFFLERS, PIPES,  
& ACCESSORIES



## THREADED ADAPTERS

P/N	OD SIZE	THREAD(NPT)	LENGTH
9514	3"	3"	6"
9516	3½"	3½"	6"
9518	4"	4"	6"

NPT – National Pipe Thread

## ELBOWS, SPLITTER T, Y PIPES

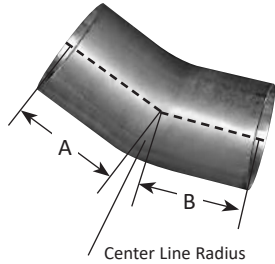

### ALUMINIZED 15° ELBOWS

P/N	DIAMETER	LENGTH A-B	CENTERLINE RADIUS
10684	4"	2"-2"	4½"
10685	5"	4"-4"	8"

### ALUMINIZED & CHROME 45° ELBOWS

#### ID-OD

P/N ALUMINIZED	P/N CHROME	DIAMETER	LENGTH A-B	CENTERLINE RADIUS
10311	—	2"	6"-6"	5"
10320	—	2¼"	6"-6"	4½"
10312	—	2½"	6"-6"	4"
10725	—	2½"	6"-6"	5"
10318	—	2¾"	6"-6"	5"
10313	—	3"	7"-7"	6"
10314	—	3½"	8"-8"	7"
10736	—	4"	5"-5"	4"
10726	—	4"	6"-6"	6"
10315	—	4"	9¼"-9¼"	8"
10727	—	4"	12"-12"	6"
10729	—	5"	7"-7"	8"
10730	809738	5"	8"-8"	10"
10317	—	5"	12"-12"	8"
10731	—	5"	12"-12"	10"
10732	—	5"	15"-15"	8"

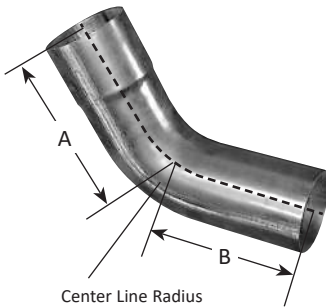

#### OD-OD

P/N ALUMINIZED	P/N CHROME	DIAMETER	LENGTH A-B	CENTERLINE RADIUS
10562	—	2½"	6"-6"	5"
10742	—	3"	4"-4"	3"
10564	—	3"	7"-7"	6"
10565	—	3½"	8"-8"	7"
10743	—	4"	6"-6"	6"
10566	—	4"	8"-8"	4½"
10745	—	4"	12"-12"	6"
10567	—	5"	8"-8"	5½"
10746	809752	5"	8"-8"	8"
10747	809753	5"	15"-15"	8"
10748	—	6"	7"-7"	10"

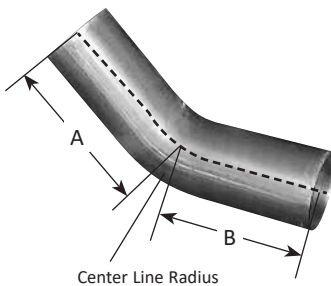

## ELBOWS, SPLITTER T, Y PIPES

### ALUMINIZED 30° ELBOWS

ID-OD

P/N	DIAMETER	LENGTH A-B	CENTERLINE RADIUS
10631	3½"	4"-4"	5"
10632	4"	4"-4"	5"
10633	5"	4"-4"	6"

OD-OD

P/N	DIAMETER	LENGTH A-B	CENTERLINE RADIUS
10636	4"	4"-4"	5"
10637	5"	4"-4"	6"

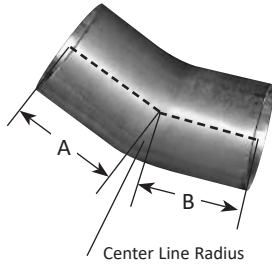
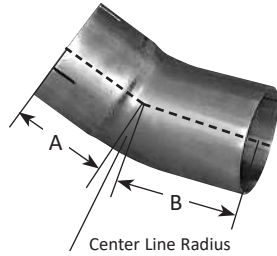

### ALUMINIZED 60° ELBOWS

ID-OD

P/N	DIAMETER	LENGTH A-B	CENTERLINE RADIUS
10639	3½"	8"-8"	5"
10640	4"	8"-8"	5"
10641	5"	8"-8"	6"

OD-OD

P/N	DIAMETER	LENGTH A-B	CENTERLINE RADIUS
10644	4"	8"-8"	5"
10645	5"	8"-8"	6"

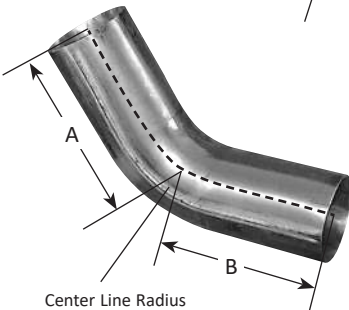
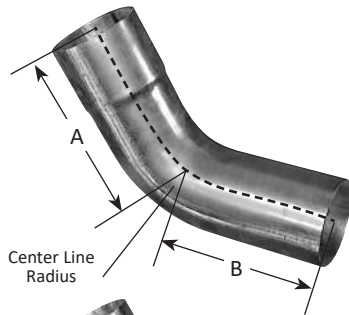

MUFFLERS, PIPES,  
& ACCESSORIES



## ELBOWS, SPLITTER T, Y PIPES

### ALUMINIZED & CHROME 90° ELBOWS

ID-OD

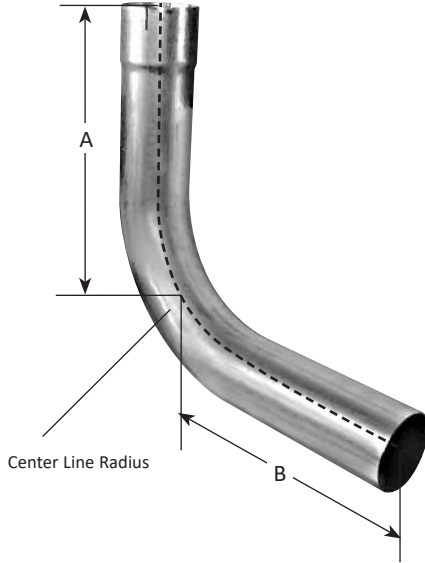

P/N ALUMINIZED	P/N CHROME	DIAMETER	LENGTH A-B	CENTERLINE RADIUS
10922	—	1½"	6½"-6½"	4"
10670	—	1¾"	6¼"-6¼"	4"
10301	—	2"	11"-11"	5"
10671	—	2"	6⅜"-6⅜"	4"
10673	—	2¼"	6⅜"-6⅜"	4½"
10302	—	2¼"	10⅞"-10⅞"	5"
10672	—	2½"	6⅜"-6⅜"	4½"
10303	—	2½"	12"-12"	5"
10674	—	2¾"	6⅜"-6⅜"	5"
10675	—	3"	8"-8¼"	6"
10756	—	3"	8½"-8½"	5"
10757	—	3"	10"-12"	5"
10758	—	3"	12"-12"	5"
10304	—	3"	14"-14"	6"
10795	—	3½"	6¼"-6¼"	3½"
10759	—	3½"	9½"-9¾"	5"
10676	—	3½"	9"-9"	4½"
10305	—	3½"	16"-16"	7"
10681	—	4"	8"-8"	4½"
—	809621	4"	10"-10"	5"
10678	—	4"	10"-10"	4½"
10761	809770	4"	12"-12"	6"
10762	—	4"	16"-16"	8"
10306	809406	4"	18"-18"	8"
10764	—	5"	8½"-8½"	6"
10557	809771	5"	11"-11"	5½"
10680	809547	5"	11"-11"	7½"
10765	—	5"	15"-15"	8"
10554	809546	5"	15"-15"	10"
10766	—	5"	16½"-16½"	10"
10308	809408	5"	18"-18"	10"
10556	—	6"	15"-15"	10"

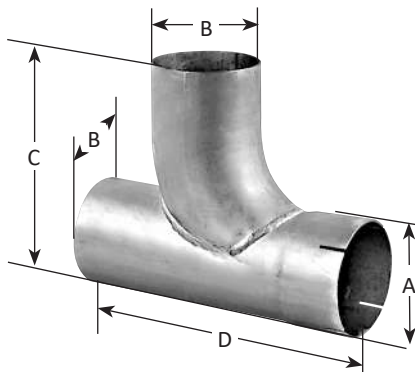

### CONVENTIONAL "Y" PIPE

P/N	A	B	C	D
92698	4" ID	3" OD	8½"	14"
92678	4" ID	3½" OD	11"	15"
92679	4" ID	4" OD	9"	11"
92689	5" ID	5" OD	10½"	15"

## ELBOWS, SPLITTER T, Y PIPES

### ALUMINIZED & CHROME 90° ELBOWS

OD-OD

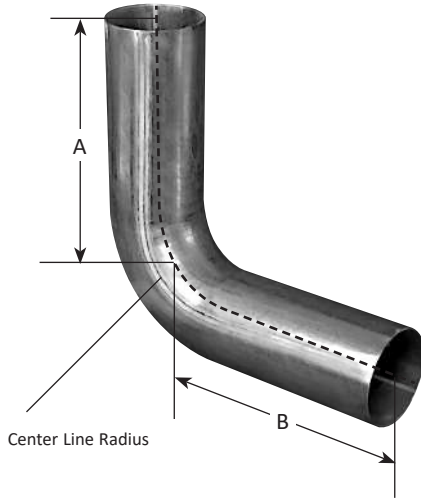

P/N ALUMINIZED	P/N CHROME	DIAMETER	LENGTH A-B	CENTERLINE RADIUS
10773	—	2"	9"-9"	5"
10774	—	2½"	12"-12"	5"
10337	—	3"	3"-3"	3½"
10776	—	3"	6"-6"	3"
10777	—	3"	7"-7"	3"
10534	—	3"	10"-10"	6"
10778	—	3"	14"-14"	8"
10794	—	3½"	6"-6"	3½"
10338	—	3½"	4"-4"	4"
10329	—	3½"	8"-8"	4"
10535	—	3½"	12"-12"	7"
10536	—	3½"	16"-16"	7"
10339	—	4"	4½"-4½"	4½"
10780	—	4"	7"-7"	5"
10781	—	4"	8"-8"	4"
10538	—	4"	9"-15"	4½"
10783	—	4"	10"-10"	6"
10539	—	4"	12"-12"	5½"
10797	—	4"	16"-16"	8"
10537	—	4"	18"-18"	8"
10340	—	5"	5½"-5½"	5½"
10784	—	5"	7½"-7½"	6"
10785	809795	5"	8½"-8½"	6"
10786	—	5"	9"-11½"	5½"
10787	—	5"	8½"-12½"	6"
10788	—	5"	8¾"-14¼"	5½"
10789	—	5"	9½"-9½"	6"
10541	—	5"	11"-16"	5½"
10791	—	5"	12"-12"	6"
—	809796	5"	12"-12"	8"
10796	—	5"	15"-15"	5½"
10540	—	5"	15"-15"	8"
10309	—	5"	20"-20"	8"

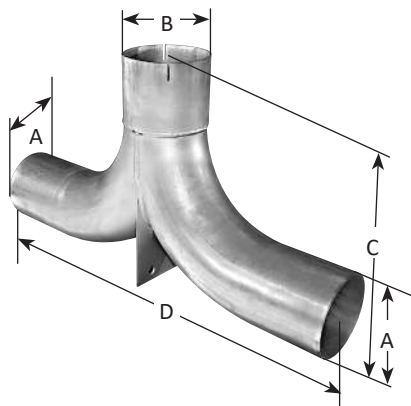

### SPLITTER "T" ADAPTER PIPE

P/N WITHOUT BRACKET	P/N WITH BRACKET	A	B	C	D
92695	—	4" OD	4" ID	12"	20"
—	92673	4" OD	4" ID	11¼"	16"
—	92674	5" OD	5" ID	14"	25"
92696	—	5" OD	5" OD	11"	19"
92697	—	5" OD	5" ID	10½"	15"

MUFFLERS, PIPES, & ACCESSORIES

## STRAIGHT TUBING

- Manufactured from Aluminum Killed Deep Drawing Quality Steel - Prevents Splits and Wrinkles
- Re-aluminized Weld Seam - Better Appearance and Helps Prevent Corrosion
- All the Necessary Diameters, Lengths and Gauges For Your Bending Needs



MUFFLERS, PIPES,  
& ACCESSORIES

## STRAIGHT TUBING

PART NO.	O.D.	GAUGE	LENGTH
<b>BENDABLE ALUMINIZED TUBING</b>			
112A1016	1 ½"	16	10'
112A7516	1 ½"	16	7.5'
134A1016	1 ¾"	16	10'
134A7516	1 ¾"	16	7.5'
178A1016	1 7/8"	16	10'
200A1014	2"	14	10'
200A1016	2"	16	10'
200A7514	2"	14	7.5'
200A7516	2"	16	7.5'
212A1014	2 ½"	14	10'
212A7514	2 ½"	14	7.5'
214A1014	2 ¼"	14	10'
214A7514	2 ¼"	14	7.5'
234A1014	2 ¾"	14	10'
300A1014	3"	14	10'

PART NO.	O.D.	GAUGE	LENGTH
<b>BENDABLE ALUMINIZED TUBING</b>			
300A7514	3"	14	7.5'
312A1014	3 ½"	14	10'
312A1016	3 ½"	16	10'
312A7516	3 ½"	16	7.5'
400A1014	4"	14	10'
400A1016	4"	16	10'
400A7516	4"	16	7.5'
400A1414	4"	14	14'
412A1016	4 ½"	16	10'
500A1016	5"	16	10'
512A1016	5 ½"	16	10'
600A1016	6"	16	10'
800A1016	8"	16	10'
<b>BENDABLE 409 STAINLESS TUBING</b>			
200S1016	2"	16	10'
214S1014	2 ¼"	14	10'
212S1014	2 ½"	14	10'
300S1014	3"	14	10'
600S1016	6"	16	10'

PART NO.	O.D.	GAUGE	LENGTH
<b>304 STAINLESS STEEL TUBING (NON-BENDABLE)</b>			
312S1016	3 ½"	16	10'
400S1016	4"	16	10'
500S1016	5"	16	10'

PART NO.	O.D.	GAUGE	LENGTH
<b>COLD ROLLED STEEL</b>			
400C1016	4"	16	10'
500C1016	5"	16	10'
600C1016	6"	16	10'

PART NO.	SIZE	LENGTH
<b>ALUMINIZED STEEL TUBING (ONE END SWAGED &amp; SLOTTED, OTHER END-O.D.)</b>		
923120	3"	10'
924120	4"	10'
925120	5"	10'

# - No Longer Available When Inventory is Sold Out.

## STACK PIPES

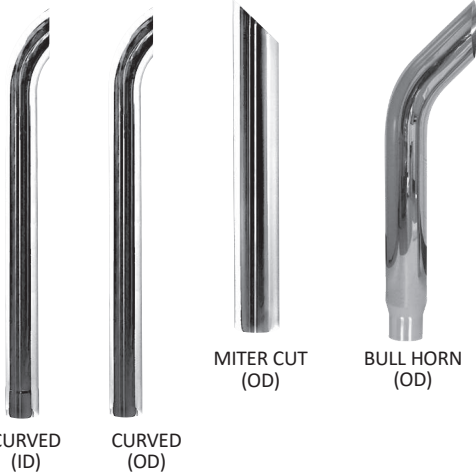

### CURVED (ID)

P/N ALUMINIZED	P/N CHROME	INLET DIA	LENGTH
14618	814621	3" ID	12"
—	824000	3" ID	18"
24744	—	3" ID	24"
—	844733	3" ID	48"
—	854000	3" ID	60"
14619	814622	3½" ID	12"
24938	824001	3½" ID	18"
34827	834000	3½" ID	36"
14620	814620	4" ID	12"
24713	824718	4" ID	18"
24746	824756	4" ID	24"
34719	834749	4" ID	36"
44664	844667	4" ID	48"
54721	854722	4" ID	60"
—	864670	4" ID	72"
—	874607	4" ID	84"
—	884547	4" ID	96"
24714	824717	5" ID	18"
24672	824673	5" ID	20"
24747	824759	5" ID	24"
34720	834748	5" ID	36"
44666	844672	5" ID	48"
54722	854725	5" ID	60"
—	864673	5" ID	72"
—	874610	5" ID	84"
—	884551	5" ID	96"
—	883001	5" ID	108"
—	883012	6"-5" ID*	108"
—	864650	6"-5" ID*	72"
—	884564	6"-5" ID*	96"
24696	—	6" ID	20"

\* 6" Reduced to 5" ID

### MITER CUT (OD)

P/N ALUMINIZED	P/N CHROME	INLET DIA	LENGTH
—	834002	4" OD	36"
—	834780	5" OD	36"
—	844005	5" OD	48"
—	854008	5" OD	60"
—	844601	6"-5" OD*	48"
—	854501	6"-5" OD*	60"

\* 6" Reduced to 5" OD

### MITER CUT (ID)

P/N ALUMINIZED	P/N CHROME	INLET DIA	LENGTH
—	XAC4124	4" ID	12"
—	XAC4184	4" ID	18"
—	864550	5" ID	72"
—	884501	5" ID	96"
—	884521	6"-5" ID	96"
—	883021	6"-5" ID	108"

\* 6" Reduced to 5" OD

### BULL HORN (OD)

P/N ALUMINIZED	P/N CHROME	INLET DIA	LENGTH
—	834897	6"-5" OD*	36"
—	844887	6"-5" OD*	48"
—	854152	6"-5" OD*	60"

\* 6" Reduced to 5" OD

### CURVED (OD)

P/N ALUMINIZED	P/N CHROME	INLET DIA	LENGTH
—	834724	3" OD	36"
34828	—	3" OD	48"
24346	—	4" OD	12"
24717	824720	4" OD	18"
24748	824748	4" OD	24"
34723	834726	4" OD	36"
44665	844674	4" OD	48"
54725	854730	4" OD	60"
—	864003	4" OD	72"
—	884003	4" OD	96"
24718	824723	5" OD	18"
24347	—	5" OD	20"
24750	824752	5" OD	24"
34724	834729	5" OD	36"
44667	844673	5" OD	48"
54726	854729	5" OD	60"
—	864002	5" OD	72"
—	884401	5" OD	96"
—	844501	6"-5" OD*	48"
—	854601	6"-5" OD*	60"

\* 6" Reduced to 5" OD

## STACK PIPES



### PIG EAR STACK (ID)

P/N	P/N	INLET	LENGTH
ALUMINIZED	CHROME	DIA	
—	<b>824510</b>	5"ID*	24"
—	<b>854510</b>	5"ID*	60"
—	<b>883510</b>	6"-5"ID*	108"

\* 6" Reduced to 5" OD

### PIG EAR STACK (OD)

P/N	P/N	INLET	LENGTH
ALUMINIZED	CHROME	DIA	
—	<b>824501</b>	5"OD*	24"
—	<b>854701</b>	5"OD*	60"
—	<b>844701</b>	6"-5"OD*	48"

\* 6" Reduced to 5" OD



### STRAIGHT CUT (ID)

P/N	P/N	INLET	LGTH.
ALUMINIZED	CHROME	DIA	
<b>24731</b>	—	3" ID	18"
<b>24941</b>	—	3" ID	24"
<b>34713</b>	—	3" ID	36"
<b>44854</b>	<b>844002</b>	3" ID	48"
<b>24735</b>	—	3½" ID	24"
<b>34714</b>	—	3½" ID	36"
—	<b>XPT4124</b>	4" ID	12"
—	<b>XPT4184</b>	4" ID	18"
—	<b>834004</b>	4" ID	36"
<b>44656</b>	—	4" ID	48"
<b>54991</b>	—	4" ID	60"
—	<b>834008</b>	5" ID	36"
<b>44658</b>	—	5" ID	48"
<b>54720</b>	<b>854009</b>	5" ID	60"

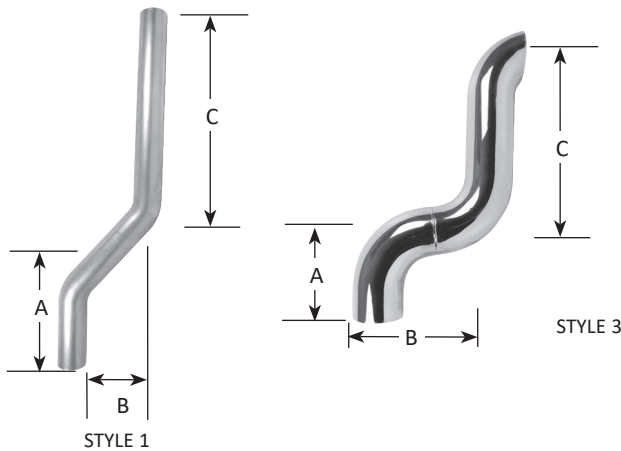

### SPECIALTY STACK PIPES

P/N	P/N	INLET	LGTH.	STYLE	A	B	C
ALUMINIZED	CHROME	DIA					
<b>54827</b>	—	4" OD	51"	1	11"	10"	29"
—	<b>834007</b>	5" OD	29½"	3	8"	11"	21½"



### STRAIGHT CUT (OD)

P/N	P/N	INLET	LGTH.
ALUMINIZED	CHROME	DIA	
<b>44657</b>	—	4" OD	48"
<b>54984</b>	—	4" OD	60"
—	<b>834709</b>	5" OD	36"
<b>44659</b>	<b>844664</b>	5" OD	48"
<b>54985</b>	<b>854717</b>	5" OD	60"

## BRACKETS & TAIL SPOUTS



XAC Style



XPT Style

### CHROME TIPS

P/N	INLET ID	DIMENSIONS	BOX QTY.
XAC4124	4" ID	4"x12"	1
XAC4184	4" ID	4"x18"	1
XPT4124	4" ID	4"x12"	1
XPT4184	4" ID	4"x18"	1



STYLE A



STYLE B

### TAIL PIPE SPOUTS

P/N		P/N	DIA	LGTH.
ALUMINIZED	CHROME			
STYLE A(OD)	STYLE B(ID)			
10921	—	—	2"	7 <sup>7</sup> / <sub>8</sub> "
14642	—	—	2 <sup>1</sup> / <sub>4</sub> "	12 <sup>1</sup> / <sub>8</sub> "
14643	—	—	2 <sup>1</sup> / <sub>2</sub> "	10"
14634	—	—	2 <sup>3</sup> / <sub>4</sub> "	12"
24344	14618	814621	3"	12"
—	—	824000	3"	18"
24345	14619	814622	3 <sup>1</sup> / <sub>2</sub> "	12"
—	—	824001	3 <sup>1</sup> / <sub>2</sub> "	18"
24346	14620	814620	4"	12"
24717	24713	824718	4"	18"
24718	24714	824717	5"	18"
24347	24672	824673	5"	20"
—	24696	—	6"	20"

### O.E. FLARED DIFFUSER TIP



Freightliner O.E. #04-24971-000  
Thomas O.E. #135779

P/N	DIA	LGTH.
24011	4" ID	14 <sup>1</sup> / <sub>2</sub> "



### CHROME HEAVY DUTY EXHAUST STACK MOUNTING BRACKET

P/N	SIZE
SB400	4"
SB500	5"
SB600	6"



### UNIVERSAL STACK BRACKETS FLAT BOTTOM CHROME

P/N	SIZE
SBF 400	4"
SBF 500	5"
SBF 600	6"



### UNIVERSAL STACK BRACKETS CURVED BOTTOM CHROME

P/N	SIZE
SBC 400	4"
SBC 500	5"
SBC 600	6"

## PIPE SHIELDS, CLAMP KITS & RAIN CAPS



### 180 DEG. PIPE SHIELD CLAMP KITS

P/N	SPECIFICATIONS
9456*	CHROME PLATED CLAMP KIT FOR 4" DIAMETER PIPE
9457*	CHROME PLATED CLAMP KIT FOR 5" DIAMETER PIPE
9801*	ZINC PLATED CLAMP KIT FOR 4" DIAMETER PIPE
9803*	ZINC PLATED CLAMP KIT FOR 5" DIAMETER PIPE
9810*	CHROME PLATED CLAMP KIT FOR 6" DIAMETER PIPE

\* Box Quantity 2

### 180 DEG. MUFFLER SHIELD CLAMP KIT

P/N	SPECIFICATIONS
9804*	CHROME PLATED CLAMP KIT FOR 8" DIAMETER MUFFLER
9451*	CHROME PLATED CLAMP KIT FOR 8½" DIAMETER MUFFLER
9805*	ZINC PLATED CLAMP KIT FOR 8½" DIAMETER MUFFLER
9452*	CHROME CLAMP KIT FOR 9" DIAMETER MUFFLER
9806*	ZINC PLATED CLAMP KIT FOR 9" DIAMETER MUFFLER
9453*	CHROME CLAMP KIT FOR 10" DIAMETER MUFFLER
9807*	ZINC PLATED CLAMP KIT FOR 10" DIAMETER MUFFLER

\* Box Quantity 2



### RAIN CAPS

P/N	MATERIAL FINISH	MIN. O.D. SIZE	MAX. O.D. SIZE
9367	POWDER COATING	1¼"	17/16"
9896	POWDER COATING	1½"	111/16"
9897	POWDER COATING	1¾"	115/16"
9371	POWDER COATING	2"	23/16"
9370	POWDER COATING	2¼"	27/8"
9372	POWDER COATING	2½"	211/16"
9378	POWDER COATING	2¾"	215/16"
9373	POWDER COATING	3"	33/16"
9374	POWDER COATING	3½"	311/16"
9375	POWDER COATING	4"	43/16"
9376	POWDER COATING	4½"	411/16"
9377	POWDER COATING	5"	53/16"
9704	POWDER COATING	5½"	511/16"
9369	POWDER COATING	6"	63/8"
9571	CHROME	3"	33/16"
9573	CHROME	4"	43/16"
9575	CHROME	5"	53/16"

### FORD MUFFLER HANGERS ORIGINAL EQUIPMENT FIT



9758

Fits All Diesel  
Mufflers 83-UP  
11" Round



### CHROME GRAB HANDLE

P/N	SPECIFICATIONS
9430	18" LENGTH
9811	24" LENGTH

## MUFFLER, PIPE SHIELDS AND CLAMP KITS



### 180 DEG. PIPE SHIELDS

P/N	SPECIFICATIONS
<b>809458</b>	STAINLESS STEEL 4"- 5"x48" PIPE SHIELD W/O MTNG. CLAMPS, ROUND HOLES
<b>809307</b>	STAINLESS STEEL 6"x48" PIPE SHIELD W/O MTNG. CLAMPS, ROUND HOLES
<b>809308</b>	ALUMINIZED 4"- 5"x48" PIPE SHIELD W/O MTNG. CLAMPS, ROUND HOLES
<b>809312</b>	STAINLESS STEEL 4"x48" PIPE SHIELD WITH 4" CLAMP KIT
<b>809313</b>	STAINLESS STEEL 5"x48" PIPE SHIELD WITH 5" CLAMP KIT

### 270 DEG. PIPE SHIELD AND CLAMP KIT

P/N	SPECIFICATIONS
<b>809301</b>	ALUMINIZED 4"- 5"x36" PIPE SHIELD ROUND HOLES
<b>9456*</b>	CHROME PLATED CLAMP KIT FOR 4" DIAMETER PIPE
<b>9801*</b>	ZINC PLATED CLAMP KIT FOR 4" DIAMETER PIPE
<b>9457*</b>	CHROME PLATED CLAMP KIT FOR 5" DIAMETER PIPE
<b>9803*</b>	ZINC PLATED CLAMP KIT FOR 5" DIAMETER PIPE

\* Box Quantity 2

MUFFLERS, PIPES,  
& ACCESSORIES

### 180 DEG. MUFFLER SHIELDS

P/N	SPECIFICATIONS
<b>809302</b>	STAINLESS STEEL 8"- 10"x42" MUFF. SHIELD W/O MTNG. CLAMPS, ROUND HOLES
<b>809429</b>	STAINLESS STEEL 8½"- 10"x51" MUFF. SHIELD W/O MTNG. CLAMPS, ROUND HOLES
<b>809303</b>	ALUMINIZED 8"- 10"x42" MUFF. SHIELD W/O MTNG. CLAMPS, ROUND HOLES
<b>809304</b>	ALUMINIZED 8"- 10"x51" MUFF. SHIELD W/O MTNG. CLAMPS, ROUND HOLES

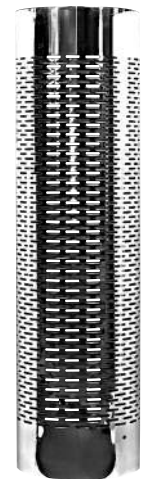

### 270 DEG. MUFFLER SHIELD AND CLAMP KIT

P/N	SPECIFICATIONS
<b>809300</b>	STAINLESS STEEL 8½"- 10½"x48" MUFF. SHIELD W/O MTNG. CLAMPS, ROUND HOLES
<b>809500</b>	STAINLESS STEEL 9"- 10"x51" MUFF. SHIELD W/O MTNG. CLAMPS, ROUND HOLES
<b>9798*</b>	CHROME CLAMP KIT FOR 9" DIAMETER MUFFLER
<b>9799*</b>	CHROME CLAMP KIT FOR 10" DIAMETER MUFFLER
<b>9724*</b>	ZINC PLATED CLAMP KIT FOR 10" DIAMETER MUFFLER
<b>9725*</b>	ZINC PLATED CLAMP KIT FOR 9" DIAMETER MUFFLER

\* Box Quantity 2



## BRACKETS & HANGERS

### 4" FORD DIESEL TAIL PIPE HANGER



9130

### FREIGHTLINER HANGERS



9348  
Muffler Hanger  
04 & Newer  
OE# A04-20919-000



8323  
Rubber Mount  
04 & Newer  
OE# 04-19919

### MUFFLER HANGERS

P/N	STYLE	FITS BODY DIAMETER
8445	B	7"-8¾"
9354	A	6"
9355	A	7"
9580	A	8"
9356	A	8½"
9357	A	9"
9358	A	10"
9360	A	8¼"x11½"
9359	A	10"x15"
9628	C	11¼"



STYLE A



STYLE B



STYLE C

### PIPE HANGERS

P/N	FITS BODY DIAMETER
9361	2½"
9363	3"
9364	3½"
9365	4"
9366	5"



## BRACKETS & HANGERS

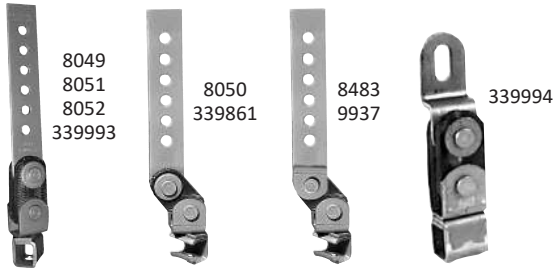

### SWIVEL HANGERS

P/N	TYPE	LENGTH	BOX QTY
<b>8049</b>	REG. CLOSED	9½"	1
<b>8050</b>	REG. OPEN	9¾"	1
<b>8052</b>	MED. CLOSED	13¾"	1
<b>8051</b>	LONG CLOSED	17¾"	1
<b>8483</b>	REG. OPEN	9½"	1
<b>9937</b>	REG. OPEN	9½"	50
<b>339861</b>	REG. OPEN	9¾"	50
<b>339993</b>	REG. CLOSED	9½"	50
<b>339994</b>	SHORT CLOSED	5⅝"	50

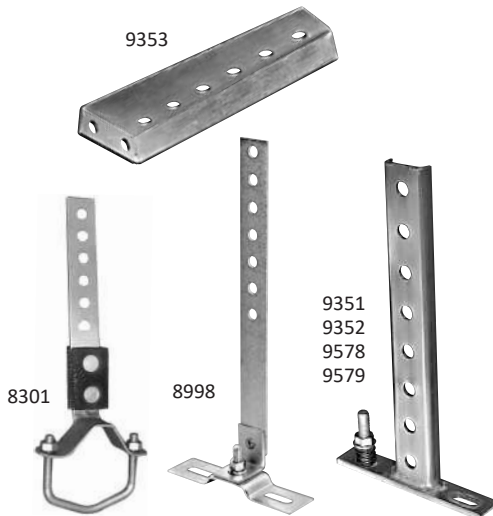

### UNIVERSAL HEAVY DUTY HANGER AND BRACKET

P/N	LENGTH	PIPE DIA
<b>9578</b>	9¼"	
<b>9351</b>	10"	2"-2¾"
<b>9352</b>	10"	3"-4"
<b>9579</b>	14"	
<b>9353</b>	10"	
<b>8301</b>	9"	
<b>8998</b>	12"	

### BLUEBIRD TAILPIPE HANGERS

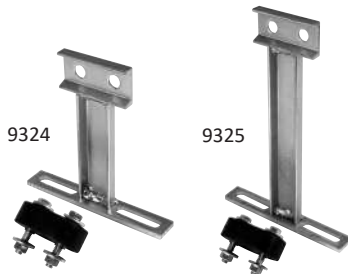

P/N	LENGTH	U-BOLT
<b>9324</b>	5⅝"	4" & 5"
<b>9325</b>	9¼"	4" & 5"

### CHEVROLET/GMC FRAME BRACKET



9328  
1989 & NEWER 366 GAS ENG.

## BRACKETS & HANGERS

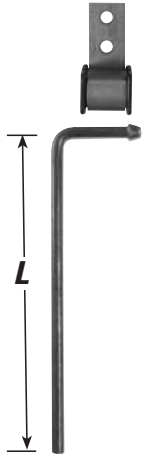

### UNIVERSAL HANGER

BULK P/N	BOX QTY	SINGLE PACK P/N	LGTH.	ROD DIA
339820	25	339820S	10"	½"

### CHEVROLET/GMC DIESEL MUFFLER STRAP

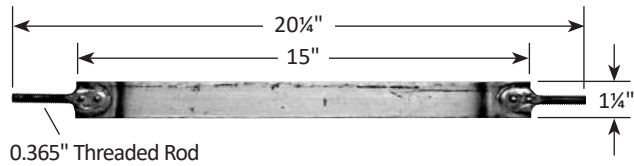

9762

### CHEVROLET/GMC OVERAXLE HANGER ASSEMBLY



9132  
FRAME BRACKET



9761  
U-SHAPED HANGER

### CHEVROLET/GMC MANIFOLD PIPE ACCESSORIES



8038

MUFFLERS, PIPES,  
& ACCESSORIES

## BRACKETS & HANGERS

### INTERNATIONAL BRACKETS (Extra Heavy Duty Reinforced)



9776  
OVERAXLE BRACKET  
(not included in complete set)

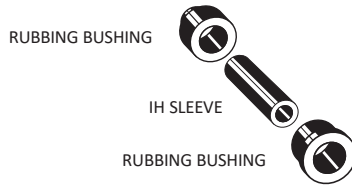

9779  
COMPLETE SET  
(tailpipe bracket, bushings, IH sleeve)



9738 (3")  
9740 (4")  
PIPE HANGERS



9753 (7.3L)  
9755 (Forward Control)  
MUFFLER HANGERS (88-UP)



9321 (96-UP)  
T444E ENG. (FORWARD)  
REAR MUFFLER HANGER



9322 (96-UP)  
T444E ENG. (FORWARD)  
FRONT MUFFLER HANGER

MUFFLERS, PIPES,  
& ACCESSORIES

## FLANGES AND GASKETS



9524 Tube  
9569 Flange (Sold Separately)



9586

### CONVERSION FLANGE AND TUBE

P/N	SIZE	DESCRIPTION
9524	2 3/4"	TUBE
9569	3"	FLANGE
9586	4"	FLANGE 4" NH CUMMINS

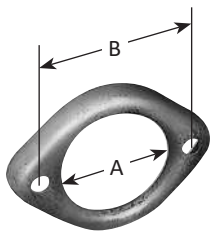

FIG 1

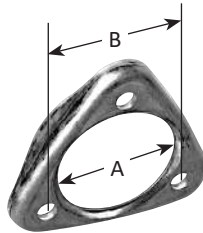

FIG 2

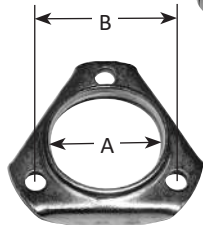

FIG 3

### FLANGE IDENTIFICATION CHARTS

P/N	FIG	A	B
8775	2	2 3/8"	3 3/8"
8780	3	2 5/32"	3 1/8"
8792	1	2 11/16"	3 3/4"
9569	1	2 29/32"	4 3/32"
8775	2	2 5/16"	2 7/8"
9146	2	2 5/8"	3 1/2"
9149	2	2 9/16"	4 1/2"



8699



9259

### SINGLE PIECE INSERTS WITH GASKET

P/N	DESCRIPTION
9260	CHEV/GMC MED TRUCK/BUS w/366, 427 ENGINE
8698	INTERNATIONAL MED TRUCK/BUS w/V392 ENGINE
8699	INTERNATIONAL MED TRUCK/BUS w/V304, V345 ENGINE
9259	CHEV/GMC MED TRUCK BUS w/350 ENGINE

## RUBBER GOODS / AIR INTAKE



### 90 DEG. ELBOWS

P/N	ID SIZE		OD SIZE		DIMENSIONS				
	(EACH END)	(EACH END)	A	B	C	D	R	T	
924003	3.00	3.50	5.25	5.25	1.50	2.00	2.00	0.25	
924004	4.00	4.50	5.75	5.75	1.50	1.50	2.00	0.25	
924005	5.00	5.50	6.00	6.00	1.62	1.62	1.75	0.25	
925506	5.50	6.00	6.50	6.50	1.75	1.75	1.75	0.25	
926006*	6.00	6.50	7.00	7.00	2.25	2.25	1.75	0.25	
927006*	7.00	7.62	7.56	7.56	2.25	2.25	1.75	0.31	
926101*	6.00	6.50	5.00	5.00	1.50	1.50	1.00	0.25	

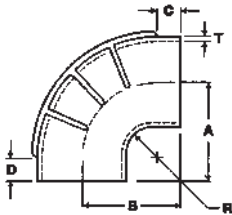

\*RIBBED ELBOW

MUFFLERS, PIPES, & ACCESSORIES



### 90 DEG. REDUCER ELBOWS

P/N	ID SIZE		ID SIZE		DIMENSIONS				
	(ID <sub>1</sub> )	(ID <sub>2</sub> )	A	B	C	D	R	T	
926557*	5.50 (ID <sub>1</sub> )	6.00 (ID <sub>2</sub> )	6.75	6.75	1.75	2.00	1.75	0.25	
927557*	5.50 (ID <sub>1</sub> )	7.00 (ID <sub>2</sub> )	5.75	6.25	1.50	1.50	0.62	0.31	

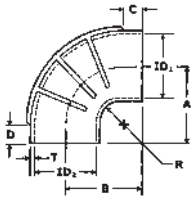

\*RIBBED ELBOW



### 45 DEG. ELBOWS

P/N	ID SIZE		OD SIZE		DIMENSIONS				
	(EACH END)	(EACH END)	A	B	C	R	T		
924105	4.00	4.50	1.50	1.50	5.50	2.00	0.25		
925005	5.00	5.50	1.62	1.62	5.25	1.75	0.25		
925505	5.50	6.00	1.75	1.75	6.25	1.75	0.25		
926005*	6.00	6.50	2.00	2.00	6.50	1.75	0.25		
927005	7.00	7.62	2.00	2.00	8.00	1.75	0.31		

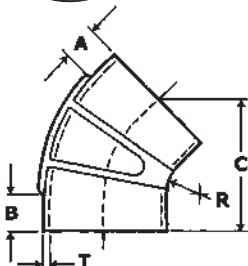

\*RIBBED ELBOW

## RUBBER GOODS / AIR INTAKE

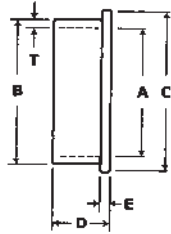

### REDUCER INSERTS

P/N	DIMENSIONS					
	A	B	C	D	E	T
925458	4.50	5.00	5.50	1.50	0.25	0.25
925558	5.00	5.50	6.00	1.50	0.25	0.25
926508	5.00	6.00	6.50	1.75	0.25	0.50
926658	5.50	6.00	6.50	1.75	0.25	0.25



### REDUCER HUMP HOSES

P/N	ID <sub>1</sub> SIZE	ID <sub>2</sub> SIZE	DIMENSIONS				
			A	B	C	T	
925543	5.50	4.00	6.00	7.00	1.87	2.00	0.25
925553	5.50	5.00	6.00	7.00	1.87	2.00	0.25
926503	6.00	5.00	6.00	7.50	2.12	2.12	0.25
926553	6.00	5.50	6.00	7.50	2.00	2.00	0.25

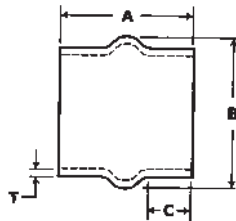
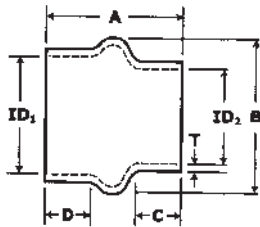

### HUMP HOSES

P/N	ID SIZE	DIMENSIONS			
		A	B	C	T
924104	4.00	5.25	5.50	2.00	0.25
925105	5.00	6.00	6.50	2.25	0.25
925504	5.50	6.00	7.00	2.25	0.25
926004	6.00	7.00	7.50	2.75	0.25
927004	7.00	7.00	8.50	2.50	0.31



### AIR LINE CLAMPS

P/N	SIZE
9589	3"
9590	3½"
9591	4"
9592	5"
9593	5½"
9594	6"
9595	7"
9596	8"



**DIESELTECH™**  
ENGINEERED TO LAST

# DieselTech: Exhaust & Emissions Components

**Durability forged from over 90 years of field experience.**

Keep your fleet working and hauling longer with extended service life from DieselTech replacement parts. DieselTech parts are direct-fit replacements that provide equivalent performance to first-fit OEM parts.

DieselTech provides “turbo-to-tailpipe” coverage for popular Class 2-8 diesel applications that are manufactured for durability – maximizing your fleet equipment uptime and providing exceptional service life.

## **Emissions:**

- Catalytic Converters
- DPFs and DOCs for Class 2-6 vehicles
- Exhaust Gas Recirculation (EGR) Coolers and Valves
- Selective Catalytic Reduction (SCR) Units
- System Sensors

## **Exhaust:**

- Mufflers, Resonators and Spark Arrestors
- Pipes (standard, flex and chrome)
- Installation Hardware (gaskets, clamps, brackets, connectors and more)
- Accessories (chrome heat shields, rain covers, brackets and more)

Born from over 90 years of experience from AP Emissions, DieselTech leverages extensive field application knowledge and benchmarking to improve designs and materials – providing a line of exceptionally durable exhaust and emissions parts.

All DieselTech parts are designed, built and tested to stringent standards in the USA and meet all applicable EPA standards.\*





## GENERAL SERVICE MUFFLER SPECIFICATIONS

### STYLE 1 - CENTER TO CENTER



\* NPT: National Pipe Thread;  
<sup>1</sup> Engine Brake Silencer Single

<sup>2</sup> Engine Brake Silencer Duals  
 Engine Brake Silencers perform by using a combination of absorptive and reactive silence techniques that are used to produce a more pleasant sound to the human ear. Using sound analysis, DIESELTECH has been able to reduce medium and high frequency noise levels and smooth out the sound spectrum eliminating the harsh staccato "bark" of an engine break.

MUFFLER P/N	INLET ID	OUTLET ID	CROSS SECTION	SHELL LENGTH	OVERALL LENGTH
4223	1½"	1½" OD	4¼"	3½"	5 <sup>29</sup> / <sub>32</sub> "
45	2"	2"	5"	10"	13½"
3690	2"	2" OD	5 <sup>5</sup> / <sub>8</sub> "	6 <sup>13</sup> / <sub>32</sub> "	11"
3878	2"*NPT	2"*NPT	6"	14 ½"	20"
3881	FLANGE	2 ¼"	9"	22"	28"
3651	2½"	2½"	6"	29"	36"
3691	2½"	2½"	6 <sup>39</sup> / <sub>64</sub> "	6 ¼"	13"
3880	2½"	2½"	6"	20"	26"
3882	2½"	2½"	7"	30"	36"
3721	3"	3"	6"	21"	30"
3692	3"	3"	7"	7 <sup>9</sup> / <sub>16</sub> "	14 <sup>5</sup> / <sub>8</sub> "
3683	3"*NPT	3"*NPT	7"	14"	19¼"
3883	3"	3"	7"	30"	36"
3652	3"	3"	7½"	30"	36"
3875	3"	3"	9"	11½"	16"
3687	3"	3½" OD	8"	12 <sup>3</sup> / <sub>16</sub> "	17"
3884	3"	3½" OD	8½"	12½"	17"
3726	3 <sup>3</sup> / <sub>16</sub> "	3 <sup>3</sup> / <sub>16</sub> "	10½"	23½"	28 <sup>5</sup> / <sub>8</sub> "
3885	3½"	3½"	11½"	22 ¾"	28 ¾"
3720	3½"	3½"	7½"	30"	38"
3693	3½"	3½"	7"	9"	16½"
3618	3½"	3½"	7"	14"	19¾"
3685	3½"*NPT	3½"*NPT	7"	15"	20"
3679	3½"	3½"	9"	44½"	51"
4233	3½"	4"	8½"	29½"	36"
3871	4"	4"	7"	22"	28"
4251	4"	4"	11"	36"	43"
4227	4"	4"	10"	36"	43"
3653	4"	4"	7"	38"	44"
3887	4"	4"	7½"	28"	36"
3694	4"	4"	8"	10 <sup>5</sup> / <sub>8</sub> "	18 <sup>3</sup> / <sub>16</sub> "
3625	4"	4"	8½"	34½"	40¼"
3891	4"	4"	8½"	44"	51"
3894	4"	4"	7"	17½"	22"
3684	4"*NPT	4"*NPT	9"	20"	26"
3888	4"	4"	9"	20"	26½"
3889	4"	4"	9"	24"	34"
3666	4"	4"	9"	43½"	51"
3681	4"	4"	9"	10½"	16"
3714	4"	4"	10"	43 ½"	51"
4218	4"	4"	10¼"	34"	41½"
3890	4"	5"	9"	43½"	51"
3712	4"	5"	9"	44½"	51"
3893	4"	5"	10"	44"	51"
3715	4"	5"	10"	44 <sup>7</sup> / <sub>16</sub> "	51"
3682	5"	5"	9"	10"	16½"
3695	5"	5"	9"	11¾"	20¾"
3895	5"	5"	9"	20"	26½"
3872	5"	5"	9"	33"	40"
3897	5"	5"	9"	43½"	51"
3699	5"	5"	10½"	44"	51"
3667	5"	5"	9"	44½"	51"
3640	5"	5"	10"	44½"	51"
3699	5"	5"	10"	44"	51"
3873	5"	5"	10"	59 <sup>15</sup> / <sub>16</sub> "	66½"
3722	5"	5"	10½"	44½"	51"

## TRUCK MUFFLER SPECIFICATIONS



**STYLE 2 - OFFSET TO OFFSET**

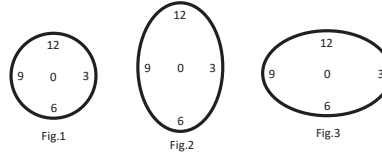

INLET/OUTLET POSITION

**NOTE:** Muffler Offsets and Positions should be measured and viewed from the Inlet end.

P/N	INLET ID	OUTLET ID	INLET POSITION	OUTLET POSITION	FIG.	INLET OFFSET	OUTLET OFFSET	CROSS SECTION	SHELL LENGTH	OVERALL LENGTH
3906	2½"	2¼"	12	6	1	1¾"	1¾"	6"	26½"	34"
3624	2½"	2½"	6	12	1	1½"	1½"	6½"	18 <sup>13</sup> / <sub>16</sub> "	23"
3654	2½"	2½"	12	6	1	1 <sup>13</sup> / <sub>32</sub> "	1 <sup>13</sup> / <sub>32</sub> "	6 <sup>5</sup> / <sub>8</sub> "	28"	35"
3908	2½"	2½"	6	12	1	2½"	2½"	8½"	26½"	33¼"
687	2½"	2"	12	6	1	1¾"	1¾"	6"	29"	34"
609	2¾"	2¾"	12	6	1	1½"	1½"	7"	31¼"	36¼"
3613	2¾"	2¾" OD	12	6	1	1½"	1½"	7 <sup>1</sup> / <sub>8</sub> "	35"	40"
2958	2¾"	2½" OD	11	7	1	1¾"	1¾"	7"	26"	33"
3607	2¾"	SPOUT	12	6	1	2"	2"	7"	35"	44¾"
2704	3"	3"	12	6	1	2"	2"	8½"	31¼"	36¼"
3627	3"	3"	6	12	1	3¼"	2"	8½"	20½"	25"
3655	3"	3"	6	6	1	2"	2"	8½"	31½"	36"
4228	3"	3" OD	6	12	1	2"	2"	8½"	24½"	36"
4224	3"	4"	6	12	1	3"	4"	11"	36"	42"
3689	3½"	3½"	6	12	2	2½"	2½"	8¼" x 11½"	26"	33"
3662	3½"	3"	6	12	1	1¾"	2"	8½"	37¾"	43"
3611	3½"	4"	6	12	2	2½"	2½"	8¼" x 11½"	26"	32¾"
4242	3½"	4"	12	6	2	2¾"	2¾"	8¼" x 11½"	26½"	33"
3716	3½"	4"	12	6	2	2½"	2½"	8½" x 11"	30"	36 <sup>3</sup> / <sub>8</sub> "
3668	4"	3½"	6	12	2	2½"	2½"	8¼" x 11½"	26"	32¾"
3669	4"	4"	6	12	1	2 <sup>7</sup> / <sub>16</sub> "	2 <sup>7</sup> / <sub>16</sub> "	10"	27 <sup>1</sup> / <sub>8</sub> "	33½"
3614	4"	4"	12	6	2	4¼"	4¼"	10" x 15"	26"	33"
3911	4"	4"	12	6	1	2½"	2½"	10 <sup>1</sup> / <sub>8</sub> "	36"	43"
3713	4"	4"	12	6	1	2½"	2½"	11 <sup>1</sup> / <sub>8</sub> "	36"	42¼"
3700	4"	4"	6	12	1	2½"	2½"	11"	36"	41¼"
3711	4"	4"	6	12	1	2½"	2½"	11"	30"	36"
4225	4"	4"	12	6	1	2½"	2½"	11"	36"	43"
3710	4"	4"	6	12	2	2¾"	2¾"	8¼" x 11½"	32"	39½"
3632	4"	4"	12	6	2	2½"	2½"	8 <sup>5</sup> / <sub>16</sub> " x 11½"	27"	32¾"
4240	4"	5"	12	6	2	3 <sup>1</sup> / <sub>8</sub> "	3 <sup>1</sup> / <sub>8</sub> "	10" x 15"	44"	50½"
3647	5"	5"	6	12	2	3 <sup>1</sup> / <sub>8</sub> "	3 <sup>1</sup> / <sub>8</sub> "	10" x 15"	26"	32 <sup>29</sup> / <sub>32</sub> "
3676	5"	5"	6	12	2	3 <sup>1</sup> / <sub>8</sub> "	3 <sup>1</sup> / <sub>8</sub> "	10" x 15"	36"	42½"
3912	5"	5"	12	3	2	3 <sup>19</sup> / <sub>32</sub> "	3 <sup>19</sup> / <sub>32</sub> "	10" x 15"	44"	50"
3913	6"	6"	12	6	2	3 <sup>19</sup> / <sub>32</sub> "	3 <sup>19</sup> / <sub>32</sub> "	10" x 15"	31½"	42½"

MUFFLERS, PIPES, & ACCESSORIES

## TRUCK MUFFLER SPECIFICATIONS

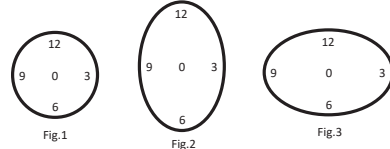
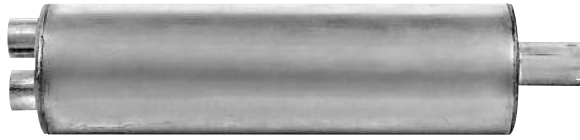

INLET/OUTLET POSITION

**NOTE:** Muffler Offsets and Positions should be measured and viewed from the Inlet end.

### STYLE 2A - DUAL INLET TO SINGLE OUTLET

P/N	INLET ID	OUTLET ID	INLET POSITION	OUTLET POSITION	FIG.	INLET OFFSET	OUTLET OFFSET	CROSS SECTION	SHELL LENGTH	OVERALL LENGTH
3697	2½"-2½"	2¾"	6-6	6	1	1¼"-1¼"	2"	8½"	30"	39"
3725#	2½"-2½"	2¾"	1:30-10:30	12	1	1¼"-1¼"	2"	8½"	30"	39"
3150	2½"-2½"	3"	6-6	12	1	1⅝"-1⅝"	2"	8½"	31¼"	36¼"
3663	2½"-2½"	3"	5-7	12	1	1¼"	2⅛"	8½"	37"	44½"
3719#	2½"-2½" (@-@)	3"OD	6-6	12	1	1⅝"-1⅝"	2"	8¾"	30"	38⅞"
4237	2½"-2½"	3"	6-12	0	1	3"-3"	0"	10"	28"	38½"
3914	2½"-2½"	3½"	5-7	6	1	1¼"	2½"	8½"	29½"	39"
3708	2½"-2½" FLANGE	4"	1:30-10:30	6	1	1¼"-1¼"	2"	9 <sup>29</sup> / <sub>32</sub> "	40"	50"
3610	2¾"-2¾"	4"	0-6	6	2	5 <sup>32</sup> / <sub>32</sub> " - 4"	2½"	8¾"x11½"	27"	32¾"

@ Spherical Flare # Wrapped Muffler Center Inlet

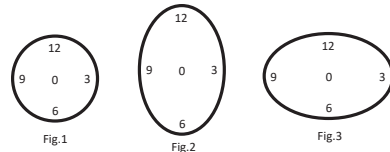
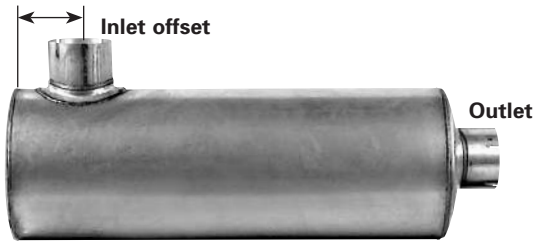

INLET/OUTLET POSITION

**NOTE:** Muffler Offsets and Positions should be measured and viewed from the Inlet end.

### STYLE 3 - SIDE INLET, END OULET

P/N	INLET ID	OUTLET ID	INLET POSITION	OUTLET POSITION	FIG.	INLET OFFSET	OUTLET OFFSET	CROSS SECTION	SHELL LENGTH	OVERALL LENGTH
3617	1⅝"	1⅝"	12	0	1	2¾"	0	4⅜"	13 <sup>25</sup> / <sub>32</sub> "	15 <sup>25</sup> / <sub>32</sub> "
3925	2½"	2½"	6	9	1	3½"	1⅝"	6⅝"	20 <sup>13</sup> / <sub>16</sub> "	23½"
3636	3½"	3½"	6	3	3	3½"	2½"	8 <sup>5</sup> / <sub>16</sub> "x11½"	26⅞"	29¼"
3626	3"	3"	6	9	1	4½"	2"	8½"	27"	29½"
3678	4"	3 <sup>13</sup> / <sub>16</sub> " OD	12	12	2	3⅞"	4 <sup>13</sup> / <sub>32</sub> "	10"x15"	16"	20⅞"
3637	4"	4"	6	3	1	4½"	2 <sup>7</sup> / <sub>16</sub> "	10⅞"	28"	32¼"
3927	4"	4"	6	9	1	4½"	2½"	11"	36"	39"
3928	4"	4"	3	12	1	4½"	2½"	11"	36"	40"
3930	4"	4"	5:30	12	2	24¼"	2½"	8¾"x11½"	28½"	31⅞"
4246	4"	4"	12	0	1	3¾"	0	11"	33½"	36½"
3931	4"	5"	6	6	2	2⅞"	4¼"	10"x15"	21"	25¼"
3926	4"	5"	6	0	1	3 <sup>51</sup> / <sub>64</sub> "	0	9"	44½"	48"
3702	5"	5"	12	0	1	5½"	0	10"	44"	48"
3645	5"	5"	9	12	3	5⅞"	3⅞"	10"x15"	35⅞"	39⅞"
3932	5"	5"	6	12	2	4"	3½"	10"x15"	16½"	20½"
3933	5"	5"	1	6	2	21¼"	4"	10"x15"	26"	30"

## TRUCK MUFFLER SPECIFICATIONS

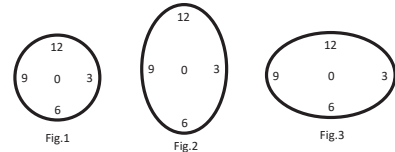
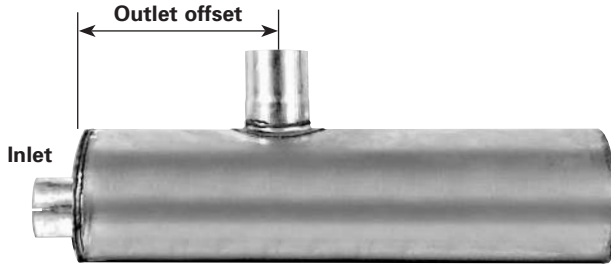

INLET/OUTLET POSITION

**NOTE:** Muffler Offsets and Positions should be measured and viewed from the Inlet end.

### STYLE 4 - END INLET, SIDE OUTLET

P/N	INLET ID	OUTLET ID	INLET POSITION	OUTLET POSITION	FIG.	INLET OFFSET	OUTLET OFFSET	CROSS SECTION	SHELL LENGTH	OVERALL LENGTH
3915	3½"	4"	6	3	2	2¼"	11½"	8¼" x 11½"	26½"	30¾"
3703	3½"	4"	3	11:30	2	2½"	12 <sup>9</sup> / <sub>16</sub> "	8¼" x 11½"	32 <sup>9</sup> / <sub>16</sub> "	35 <sup>5</sup> / <sub>32</sub> "
3704	3½"	4" OD	9	11:30	2	2½"	12 <sup>9</sup> / <sub>16</sub> "	8¼" x 11½"	32 <sup>9</sup> / <sub>16</sub> "	35 <sup>5</sup> / <sub>32</sub> "
3916	3½"	4" OD	6	3	2	2½"	12"	8¼" x 11½"	32"	35"
3917	3½"	4" OD	12	3:30	2	2½"	21"	8¼" x 11½"	26½"	30"
3707	4"	4"	12	6	1	2 <sup>13</sup> / <sub>32</sub> "	5½"	10 <sup>1</sup> / <sub>8</sub> "	36"	38 <sup>29</sup> / <sub>32</sub> "
3677	4"	4"	10	6	1	2 <sup>7</sup> / <sub>16</sub> "	4"	10"	28"	31"
3918	4"	4"	6	11	1	3"	19½"	10"	26½"	30½"
3706	4"	4"	6	12	2	3¼"	7"	10" x 15"	36"	40½"
3921	4"	4"	6	12	2	4¼"	7 <sup>3</sup> / <sub>8</sub> "	10" x 15"	30 <sup>3</sup> / <sub>8</sub> "	34"
3730	4"	4"	10	12	1	2½"	3 <sup>7</sup> / <sub>8</sub> "	11 <sup>1</sup> / <sub>8</sub> "	36"	39"
3920	4"	4"	2	12	1	2½"	3 <sup>7</sup> / <sub>8</sub> "	11 <sup>1</sup> / <sub>8</sub> "	36"	39"
3919	4"	4"	6	12	1	1½"	4"	11"	36"	39½"
3705	4"	4"	12	8	2	4½"	11½"	8¼" x 11½"	26"	31"
3698	5"	5"	6	12	2	3 <sup>1</sup> / <sub>8</sub> "	7¾"	10" x 15"	36"	39¼"
3923	5"	5"	6	12	1	2¼"	7½"	11"	36"	39½"
3924	5" OD	5" OD	0	12	1	0"	14½"	12 <sup>1</sup> / <sub>8</sub> "	36"	40"

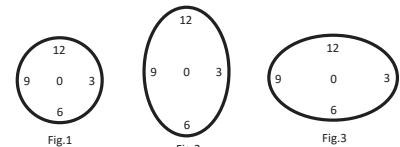

INLET/OUTLET POSITION

**NOTE:** Muffler Offsets and Positions should be measured and viewed from the Inlet end.

### STYLE 5 - INLET/OUTLET SAME END

P/N	INLET ID	OUTLET ID	INLET POSITION	OUTLET POSITION	FIG.	INLET OFFSET	OUTLET OFFSET	CROSS SECTION	SHELL LENGTH	OVERALL LENGTH
3851	3½"	4"	12	6	2	2 <sup>5</sup> / <sub>8</sub> "	2 <sup>5</sup> / <sub>8</sub> "	8¼" x 11½"	30½"	34"
3670	4"	4"	12	6	1	2 <sup>7</sup> / <sub>16</sub> "	2 <sup>7</sup> / <sub>16</sub> "	10"	27¾"	30 <sup>7</sup> / <sub>8</sub> "
4211	4"	4"	6	12	1	3"	3"	10"	26½"	31"
3898	4"	4"	12	6	2	4 ¼"	4 ¼"	10" x 15"	26"	28 <sup>3</sup> / <sub>8</sub> "
3900	5"	5"	12	6	2	3 <sup>1</sup> / <sub>8</sub> "	3 <sup>1</sup> / <sub>8</sub> "	10" x 15"	26"	29 <sup>23</sup> / <sub>64</sub> "
4205	5"	5"	12	6	2	3 <sup>19</sup> / <sub>32</sub> "	3 <sup>19</sup> / <sub>32</sub> "	10" x 15"	44"	47 <sup>3</sup> / <sub>8</sub> "

MUFFLERS, PIPES, & ACCESSORIES

## TRUCK MUFFLER SPECIFICATIONS

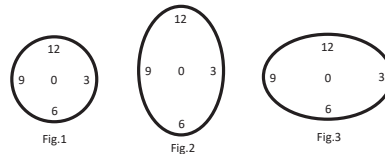

INLET/OUTLET POSITION

**NOTE:** Style 6 Inlet and Outlet Offsets are measured from each end. Style 6 Inlet and Outlet Positions are viewed from the Inlet end. On all other style mufflers, the Offsets and Positions should be measured and viewed from the Inlet end.

### STYLE 6 - SIDE INLET, SIDE OUTLET

P/N	INLET ID	OUTLET ID	INLET POSITION	OUTLET POSITION	FIG.	INLET OFFSET	OUTLET OFFSET	CROSS SECTION	SHELL LENGTH	OVERALL LENGTH
3937	4"	4"	6	12	1	4½"	4½"	10⅞"	28"	30⅝"
3938	4"	4"	12	9	1	4¼"	6¾"	11⅜"	36"	36"
3939	4"	4"	12	10:30	1	4½"	17½"	11"	36"	36"
3940	4"	4"OD	12	2	1	4"	13½"	11"	36"	36"
3941	5"	5"	6	12	3	5"	5"	10" X 15"	28"	28¾"

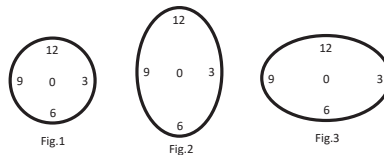

INLET/OUTLET POSITION

**NOTE:** Muffler Offsets and Positions should be measured and viewed from the Inlet end.

### STYLE 8 - SINGLE INLET, DUAL OUTLET

P/N	INLET ID	OUTLET ID	INLET POSITION	OUTLET POSITION	FIG.	INLET OFFSET	OUTLET OFFSET	CROSS SECTION	SHELL LENGTH	OVERALL LENGTH
2328	3"	2"-2"	3	9	1	1¾"	7⁄8"-7⁄8"	7"	26"	32¾"

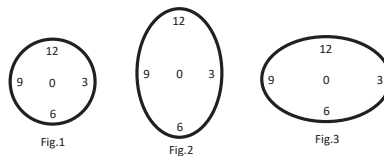

INLET/OUTLET POSITION

**NOTE:** Muffler Offsets and Positions should be measured and viewed from the Inlet end.

### STYLE 10 - OFFSET TO OFFSET

P/N	INLET ID	OUTLET ID	INLET POSITION	OUTLET POSITION	FIG.	INLET OFFSET	OUTLET OFFSET	CROSS SECTION	SHELL LENGTH	OVERALL LENGTH
3616	3"	3"	6	6	2	2½"	2½"	8⁵⁄₁₆" x 11½"	26"	33¾"

## UNIVERSAL ALL WELDED TRUCK MUFFLERS

- 100% Aluminized
- All Welded Construction
- Light Truck & Medium Duty Truck Applications

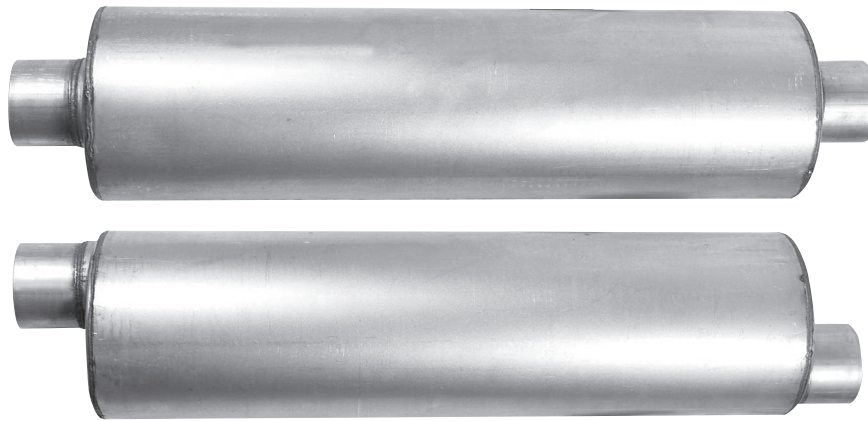

MUFFLERS, PIPES,  
& ACCESSORIES

P/N	DIAMETER	SHELL LENGTH	OVERALL LENGTH	INLET/OUTLET	NECKS
4267	7" Round	26"	32"	Center/Center	2 ¼"
4268	7" Round	26"	32"	Center/Center	2 ½"
4269	7" Round	26"	32"	Center/Center	3"
4270	7" Round	26"	32"	Center/Center	3 ½"
4271	7" Round	26"	32"	Offset/Offset	2 ¼"
4272	7" Round	26"	32"	Offset/Offset	2 ½"
4273	7" Round	26"	32"	Offset/Offset	3"
4274	7" Round	26"	32"	Offset/Offset	3 ½"

NOTE: For Stationary Equipment

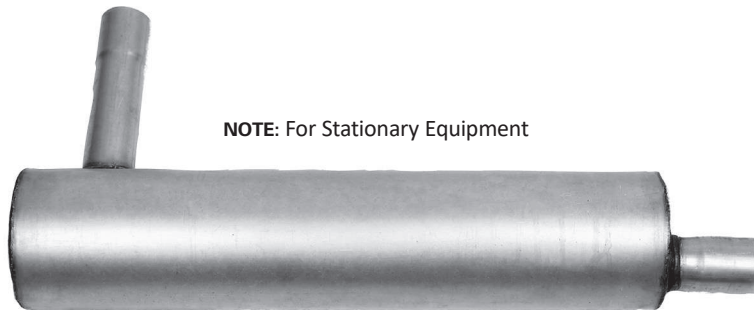

P/N	DIAMETER	SHELL LENGTH	OVERALL LENGTH	INLET LENGTH	INLET/OUTLET	NECKS
4290	4" Round	18"	21"	6"	Side/Offset	1 ½"

## GENERAL SERVICE MUFFLER, RESONATORS & SPARK ARRESTOR

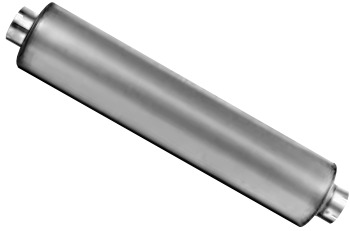

### GENERAL SERVICE MUFFLER SPECIFICATIONS

MUFFLER P/N	INLET ID	OUTLET ID	SHELL DIAMETER	SHELL LENGTH	OVERALL LENGTH
3651	2½"	2½"	6"	29"	36"
3721	3"	3"	6"	21"	30"
3720	3½"	3½"	7½"	30"	38"
3871	4"	4"	7"	22"	28"
3887	4"	4"	7½"	28"	36"
3712	4"	5"	9"	44½"	51"
3872	5"	5"	9"	33"	40"
3873	5"	5"	10"	59 <sup>15</sup> / <sub>16</sub> "	66½"
3699	5"	5"	10"	44"	51"



### UNIVERSAL TYPE RESONATORS

MUFFLER P/N	INLET ID	OUTLET ID	SHELL DIAMETER	SHELL LENGTH	OVERALL LENGTH
3875	3"	3"	9"	11½"	16"
3884	3"	3½" OD	3½"	12¼"	17"
3618	3½"	3½"	7"	14"	19¾"
3681	4"	4"	9"	10½"	16"
3682	5"	5"	10"	10"	16½"

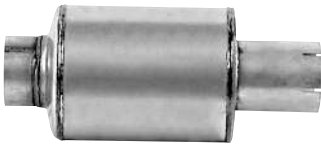

Over 90% effective. Can be used on all internal combustion engines. Qualified and rated by U.S. Dept. of Agriculture - Forestry Service.

### SPARK ARRESTORS

MUFFLER P/N	INLET ID	OUTLET ID	CROSS SECTION	SHELL LENGTH	OVERALL LENGTH
4223	1½"	2½" OD	4¼"	3½"	5 <sup>29</sup> / <sub>32</sub> "
3690	2"	2" OD	5 <sup>5</sup> / <sub>8</sub> "	6 <sup>13</sup> / <sub>32</sub> "	11"
3691	2½"	2½"	6 <sup>39</sup> / <sub>64</sub> "	6¼"	13"
3692	3"	3"	7"	7 <sup>9</sup> / <sub>16</sub> "	14 <sup>5</sup> / <sub>8</sub> "
3693	3½"	3½"	7"	9"	16½"
3694	4"	4"	8"	10 <sup>5</sup> / <sub>8</sub> "	18 <sup>3</sup> / <sub>16</sub> "
3695	5"	5"	9"	11¾"	20¾"



### MUFFLER SPARK ARRESTOR

MUFFLER P/N	INLET ID	OUTLET ID	INLET POSITION	INLET OFFSET	CROSS SECTION	SHELL LENGTH	OVERALL LENGTH
4222#	1½" OD	1¾" OD	12	2"	4¼"	18½"	21"
4238*	2"	2½" OD	6	2"	4 <sup>5</sup> / <sub>8</sub> "	13¼"	18½"

# Onan Generator Motor Home

\* 230 IH Tractor

## ORIGINAL EQUIPMENT vs ECONOMY

### MUFFLER OPTIONS

O.E.

ECONOMY

Original Equipment mufflers reduce exhaust noise to level required to meet EPA truck noise limits.

Original Equipment mufflers can be quieter (Up to 3 dba) than economy versions, depending on make of engine.

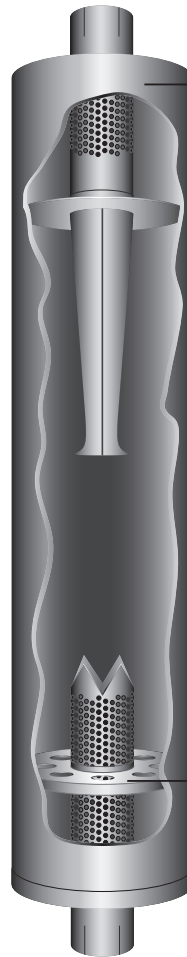
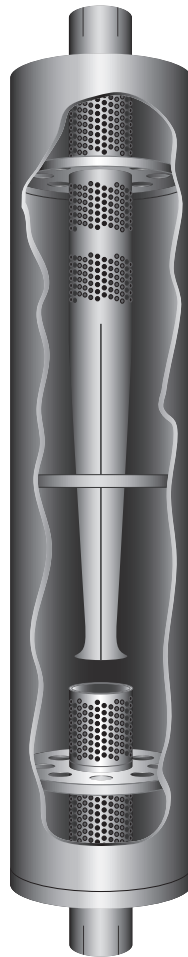

16 Gauge End Flange (Some competitors are lighter).

Local noise laws should be checked before using Economy version.

Internal support flange (Some competitors do not).

OEM PIPE  
REPLACEMENT

### ALL ALUMINIZED STEEL CONSTRUCTION

DIESELTECH	O.E. NO.	ECONOMY NO.
4" INLET & OUTLET VERTICAL 9" BODY	3666	3891
5" INLET & OUTLET VERTICAL 10 $\frac{1}{2}$ " BODY	3640	3699
5" INLET & OUTLET VERTICAL 9" BODY	3897	3667
4" INLET & 5" OUTLET VERTICAL 9" BODY	3890	3712
4" INLET & 5" OUTLET VERTICAL 10" BODY	3715	3893



## 606000 SERIES SUPER DUTY UNIVERSAL CONVERTERS

The **606\*\*\* Series Universal Converter** is an extra large capacity, without air tube, 2-way or 3-way converter.

Easy to read emissions ratings for both the EPA and CARB. The **606\*\*\* SERIES** is designed to fit light and medium duty trucks to 12,000 lbs., G.V.W.-EPA Rating, 11,620 lbs., CARB Rating.

High quality, stainless steel shell and end bushings will provide years of worry free service.

Insure maximum engine capacities and maximum test weight capacities for both the EPA and CARB standards and dimensional information for the **606\*\*\* Series Universal Converters**.



## 606000 SERIES HEAVY DUTY - WITHOUT AIR

Can be used as a 2-way converter on vehicles where the engine size is 7.5L or smaller and with a test weight of 9,000 lbs. or less or as a 3-way where the engine size is 7.5L or smaller and a test weight of 9,000 lbs. or less. G.V.W. of 12,500 lbs. approx., or less.

In California, can be used as a 2-way converter on vehicles where the engine size is 7.4L or smaller and with a test weight of 9,000 lbs. or less or a 3-way where the engine size is 7.4L or smaller and a test weight of 9,000 lbs. or less G.V.W. of 11,620 lbs., or less.



## 2-WAY OR 3-WAY CONVERTER

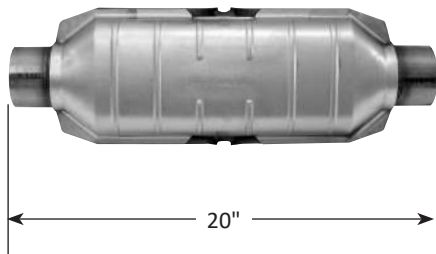

### SUPER DUTY CONFIGURATION

Converter Type	EPA Engine Size	EPA Test Weight	CARB Engine Size	CARB Test Weight
2-Way	460/7.5L	9,000 lbs.	454/7.4L	9,000 lbs.
3-Way	460/7.5L	9,000 lbs.	454/7.4L	9,000 lbs.

### 2-WAY OR 3-WAY

P/N	INLET I.D.	OUTLET I.D.
606005	2¼"	2¼"
606006	2½"	2½"
606007	3"	3"

## 607000 SERIES SUPER DUTY UNIVERSAL CONVERTERS

The **607\*\*\* Series Universal Converter** is a extra large capacity, with air tube, 2-way, 3-way or 3-way with air converter.

Easy to read emissions ratings for both the EPA and CARB. The **607\*\*\* Series** is designed to fit light and medium duty trucks to 12,000 lbs., G.V.W.-EPA Rating, 11,620 lbs., CARB RATING.

High quality, stainless steel shell and end bushings will provide years of worry free service.

Insure maximum engine capacities and maximum test weight capacities for both the EPA and CARB standards and dimensional information for the **607\*\*\* Series Universal Converters**.



## 607000 SERIES HEAVY DUTY - WITH AIR

Can be used as a 2-way converter on vehicles where the engine size is 7.5L or smaller and with a test weight of 9,000 lbs. or less or as a 3-way w/air where the engine size is 7.5L or smaller and a test weight of 9,000 lbs. or less G.V.W. of 12,500 lbs. approx., or less.

In California, can be used as a 2-way converter on vehicles where the engine size is 7.4L or smaller and with a test weight of 9,000 lbs. or less or a 3-way where the engine size is 7.4L or smaller and a test weight of 9,000 lbs. or less B.V.W. of 11, 620 lbs. or less. 3-way w/air - NA. Please see below for details.



OEM PIPE  
REPLACEMENT

### 2-WAY, 3-WAY AND 3-WAY WITH AIR TUBE CONVERTER

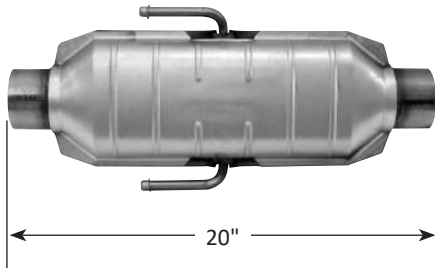

SUPER DUTY CONFIGURATION				
Converter Type	EPA Engine Size	EPA Test Weight	CARB Engine Size	CARB Test Weight
2-WAY	460/7.5L	9,000 lbs.	454/7.4L	9,000 lbs.
3-WAY	460/7.5L	9,000 lbs.	454/7.4L	9,000 lbs.
3-WAY w/air	460/7.5L	9,000 lbs.	NA	NA

### 2-WAY, 3-WAY AND 3-WAY WITH AIR TUBE

P/N	INLET I.D.	OUTLET I.D.
607005	2¼"	2¼"
607006	2½"	2½"
607007	3"	3"

## REAR CONVERTER CUT-OFF INSTRUCTIONS

### 88-89 8 Cyl., C3500, K3500

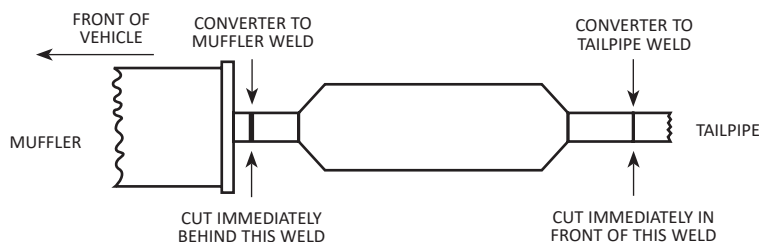

## ALUMINIZED EXHAUST COMPONENTS - FORD



### 18109

Replaces FORD  
Part No. **D8HZ-5246AC**  
Inlet Pipe RH  
L, LN, LNT, LT, LTS 9000 Series with Cummins NTC  
Engines.

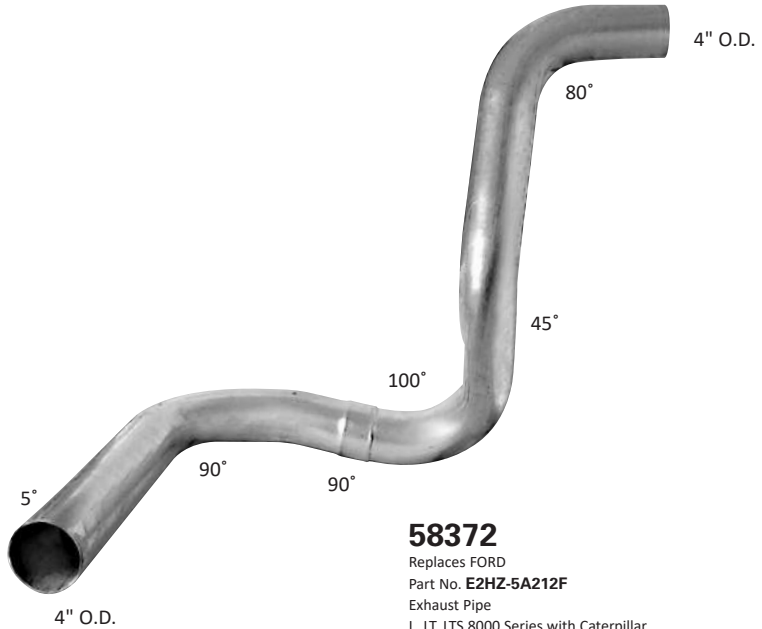

### 58372

Replaces FORD  
Part No. **E2HZ-5A212F**  
Exhaust Pipe  
L, LT, LTS 8000 Series with Caterpillar  
3208T Engines.

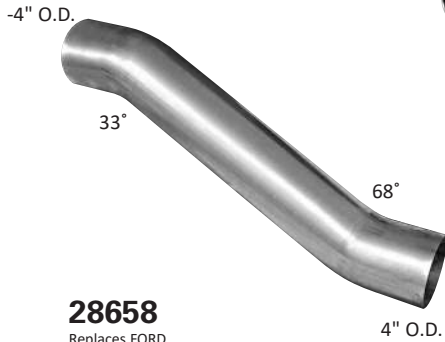

### 28658

Replaces FORD  
Part No. **E7HZ-5255D**  
Extension Pipe  
Requires 14739 Flex on  
outlet End to replace OE

## ALUMINIZED EXHAUST COMPONENTS - FREIGHTLINER



### 38762

Replaces FREIGHTLINER  
Part No. **A04-12399-000**  
Exhaust Pipe

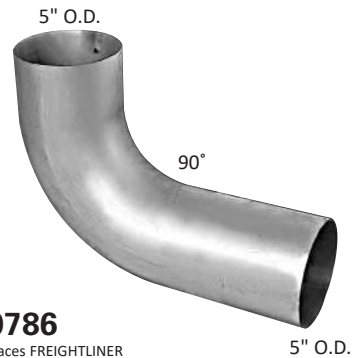

### 10786

Replaces FREIGHTLINER  
Part No. **A04-09586-013**  
Elbow

## ALUMINIZED EXHAUST COMPONENTS - FREIGHTLINER



**10787**  
Replaces FREIGHTLINER  
Part No. **A04-09586-015**  
Elbow



**10788**  
Replaces FREIGHTLINER  
Part No. **A04-09586-017**  
Elbow

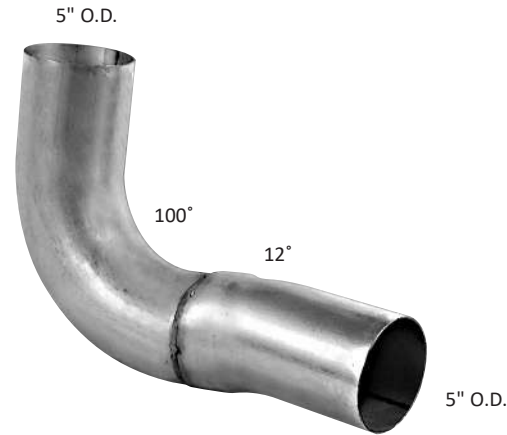

**28655**  
Replaces FREIGHTLINER  
Part No. **A04-15652-000**  
Extension Pipe

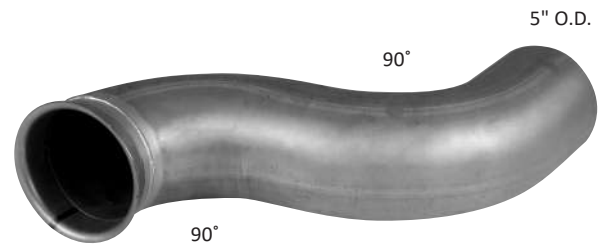

**28698**  
Replaces FREIGHTLINER  
Part No. **A04-17094-012**  
Flared Turbo Pipe

OEM PIPE  
REPLACEMENT

## ALUMINIZED EXHAUST COMPONENTS - FREIGHTLINER

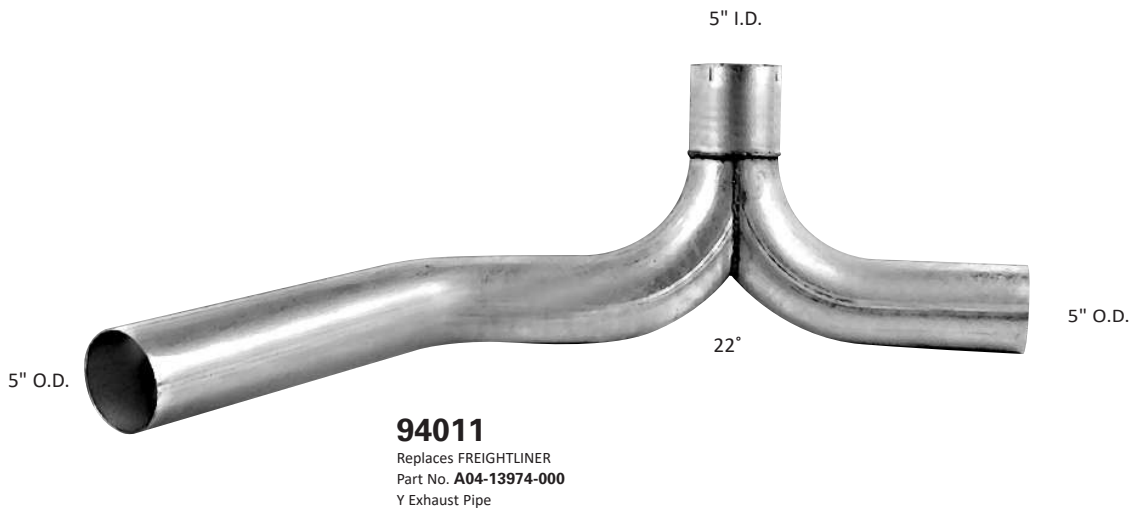
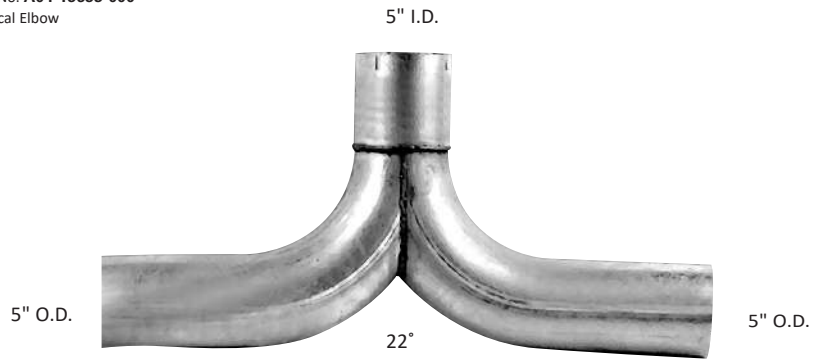
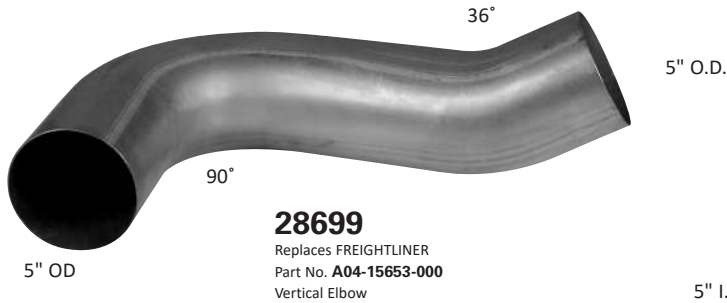

OEM PIPE  
REPLACEMENT

## ALUMINIZED EXHAUST COMPONENTS - GMC



**24346**  
Replaces GMC  
Part No.2353719  
Tail Pipe

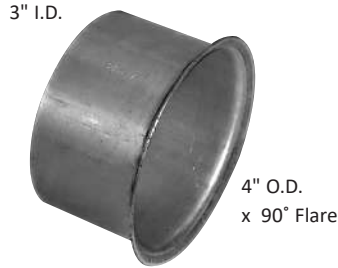

**9479**  
Replaces GMC  
Part No.2046594  
Extension  
Requires 9611 V-Clamp

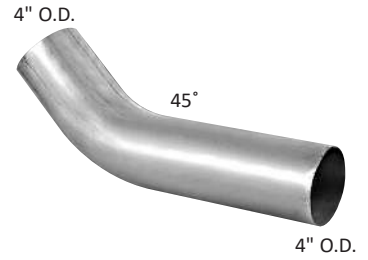

**28310**  
Replaces GMC  
Part No.2064499  
Elbow

OEM PIPE  
REPLACEMENT

## ALUMINIZED EXHAUST COMPONENTS - INT'L / NAVISTAR



**28661**  
Replaces INTERNATIONAL / NAVISTAR  
Exhaust Pipe

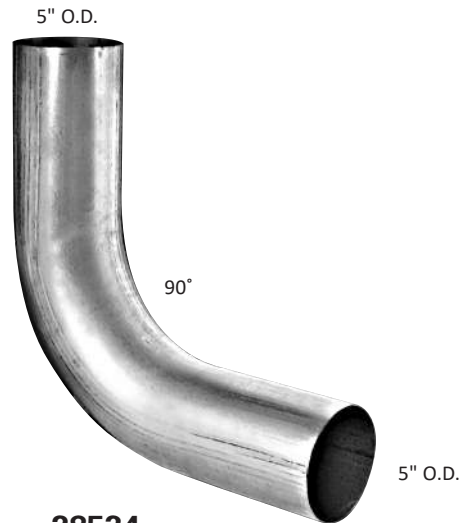

**28534**  
Replaces INTERNATIONAL / NAVISTAR  
Exhaust Pipe Part No. 503-841-C1  
Intermediate Pipe

## ALUMINIZED EXHAUST COMPONENTS - INT'L / NAVISTAR

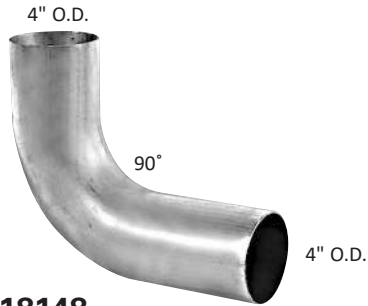

**18148**  
Replaces INTERNATIONAL / NAVISTAR  
Part No. **598-276-C1**  
Elbow



**18149**  
Replaces INTERNATIONAL / NAVISTAR  
Part No. **165-293-7C1**  
Turbo Elbow



**38608**  
Replaces INTERNATIONAL / NAVISTAR  
Part No. **582-167-C1**

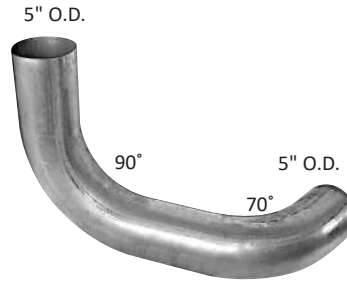

**38607**  
Replaces INTERNATIONAL / NAVISTAR  
Part No. **503-845-C1**  
89" Cab



**9716**  
Replaces INTERNATIONAL  
Part No. **449-814-C1**  
Turbo Connector

OEM PIPE  
REPLACEMENT

## ALUMINIZED EXHAUST COMPONENTS - KENWORTH

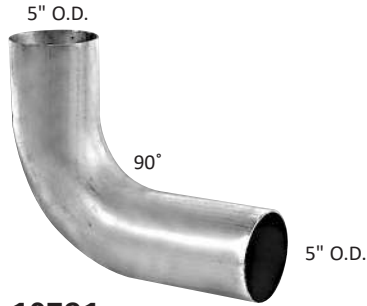

**10791**  
Replaces KENWORTH  
Part No. **K180-15593**  
Elbow



**68185**  
Replaces KENWORTH  
Part No. **K180B-10742-R**  
Right Side Elbow with Offset  
**868186 - Chrome**

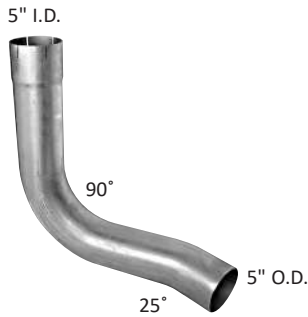

**68183**  
Replaces KENWORTH  
Part No. **180B-10742-L**  
Left Side Elbow with Offset  
**868184 - Chrome**

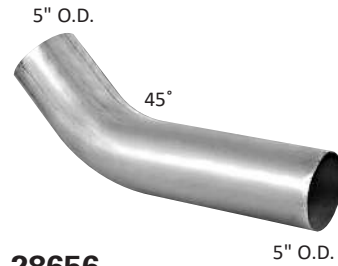

**28656**  
Replaces KENWORTH  
Part No. **K180-14765**  
Extension Pipe

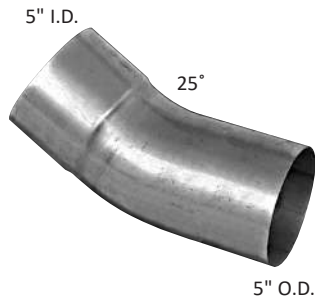

**18110**  
Replaces KENWORTH  
Part No. **K180-5419**



**38612**  
Replaces KENWORTH  
Part No. **K180-14764R**  
RH Extension Pipe

OEM PIPE  
REPLACEMENT



## ALUMINIZED EXHAUST COMPONENTS - KENWORTH

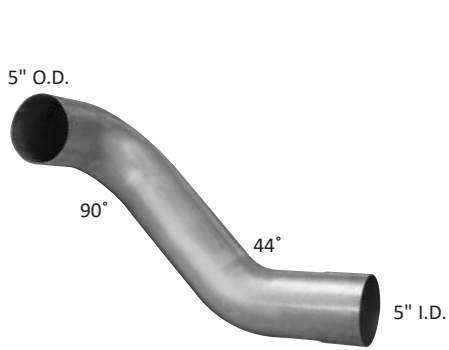

**38611**  
Replaces KENWORTH  
Part No. **K180-14764L**  
(See Kmex)

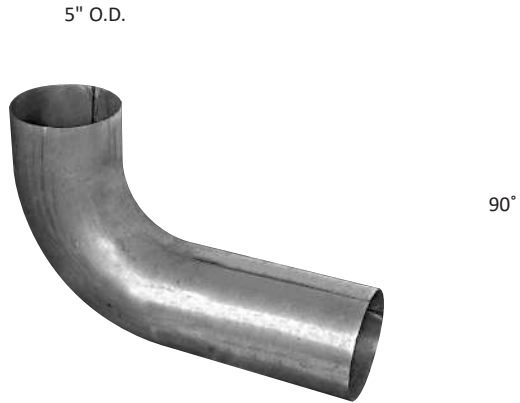

**10788**  
Replaces KENWORTH  
Part No. **K16948-012**

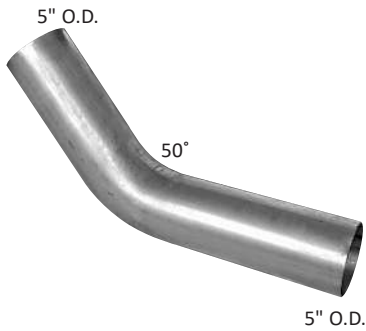

**38614**  
Replaces KENWORTH  
Part No. **K180-8049**

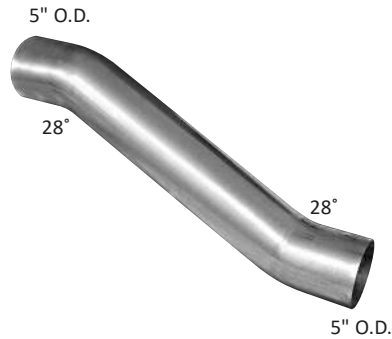

**38610**  
Replaces KENWORTH  
Part No. **K180-14122, K180-14967**  
Fits Model T-800  
Exhaust Pipe



**38613**  
Replaces KENWORTH  
Part No. **K180-6326**  
Extension Pipe

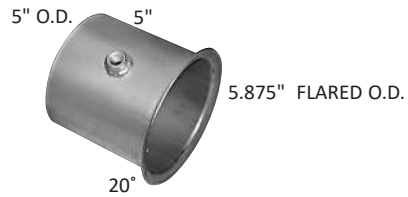

**9629**  
Replaces KENWORTH  
Flared Adapter w/ Thermo Coupler

OEM PIPE  
REPLACEMENT

## ALUMINIZED EXHAUST COMPONENTS - KENWORTH

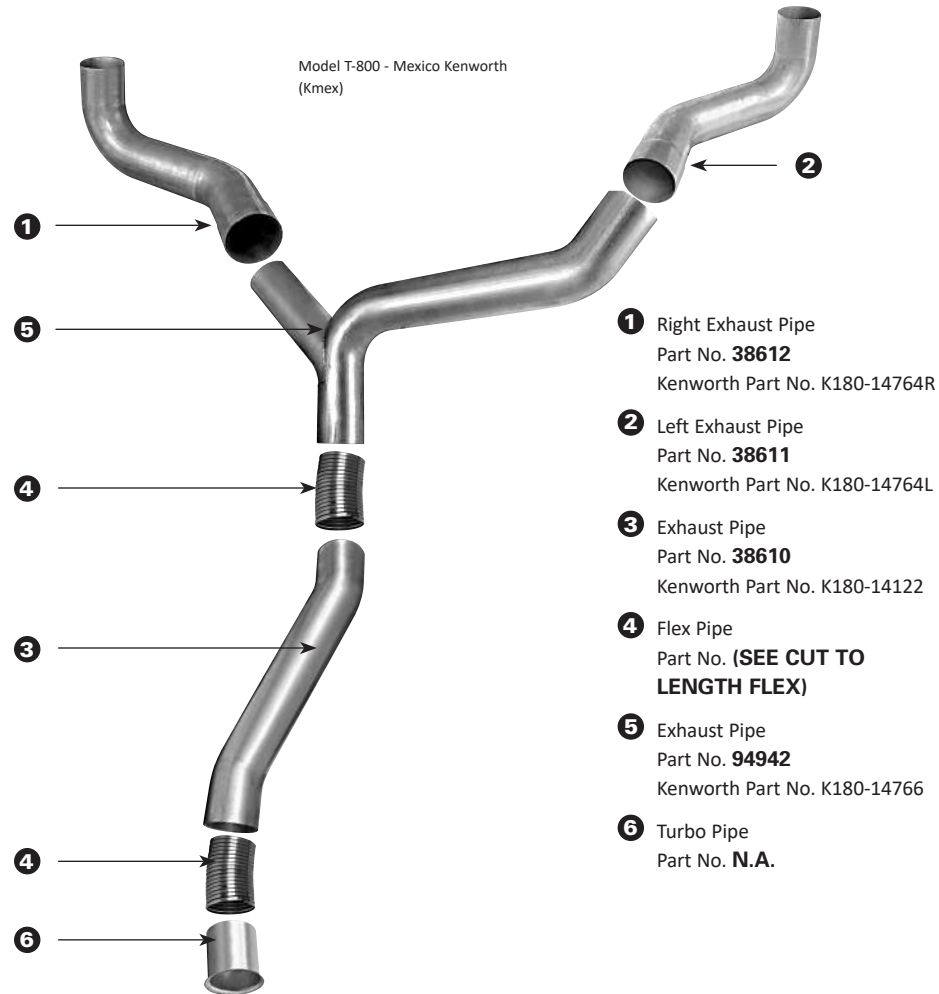

OEM PIPE  
REPLACEMENT

## ALUMINIZED EXHAUST COMPONENTS - MACK

4.437" O.D.  
x 90° Flare

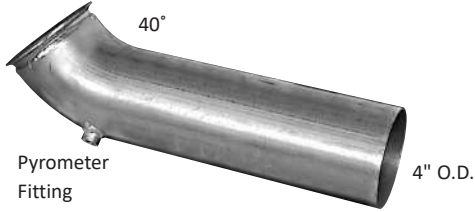

Pyrometer  
Fitting

**28528**

Replaces MACK  
Part No. **4ME21698**  
R Model - Front Pipe

R & RD models EM6-237, EM6-237R, ENDT675, END864  
Engines with Frame mounted Muffler

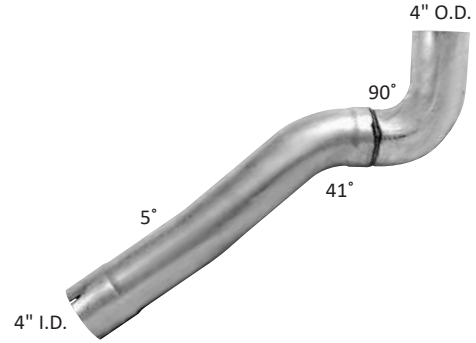

**38761**

Replaces MACK  
Part No. **4ME32618**  
Exhaust Pipe

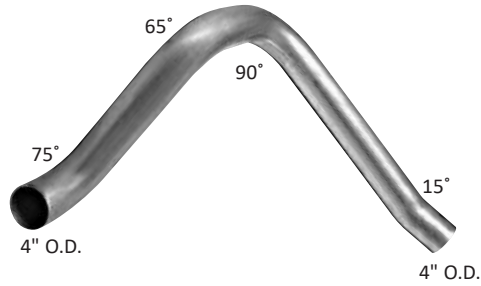

**68182**

Replaces MACK  
Part No. **4ME32612**  
R Model - Round Fuel Tanks

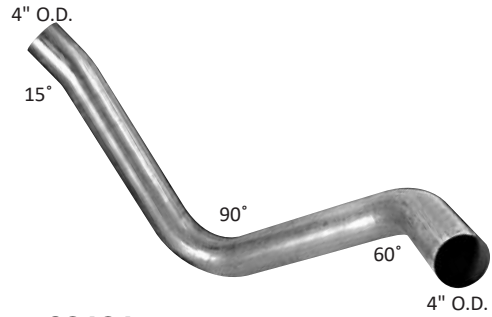

**68181**

Replaces MACK  
Part No. **4ME32611**  
R Model - Front Pipe

R & RD models EM6-237, EM6-237R, ENDT675, END864  
Engines with Frame mounted Muffler

## ALUMINIZED EXHAUST COMPONENTS - PETERBILT

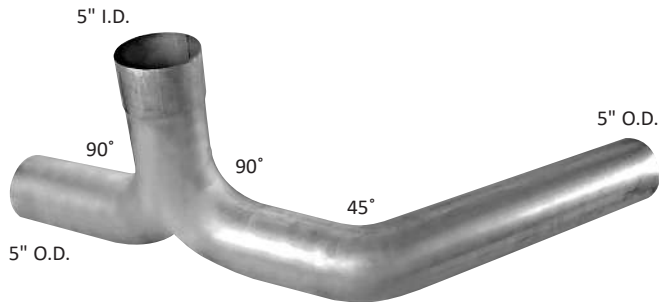

**94941**

Replaces PETERBILT  
Part No. **14-04055**



**10560**

Replaces PETERBILT  
Part No. **14-10726**

**809530 - Chrome**

## ALUMINIZED EXHAUST COMPONENTS - PETERBILT

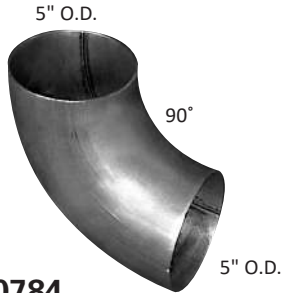

**10784**  
Replaces PETERBILT  
Part No. 14-08525

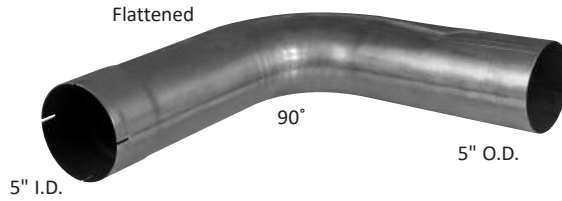

**10799**  
Replaces PETERBILT  
Part No. 14-13394-202  
Lower Elbow

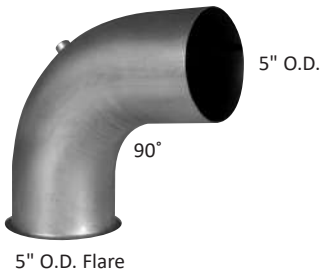

**18166**  
Replaces PETERBILT  
Part No. 14-13022  
Turbo Elbow

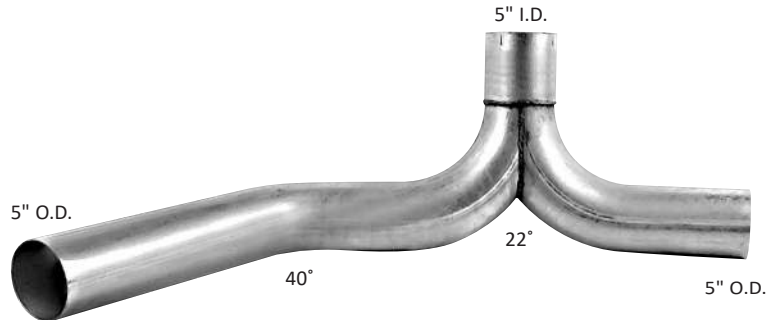

**94011**  
Replaces PETERBILT  
Part No. 14-13055  
Y-Pipe

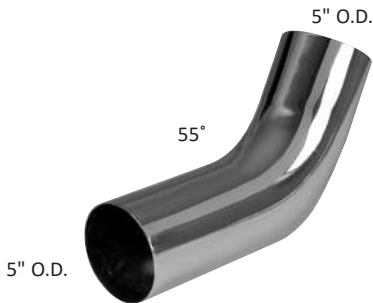

**809519 - Chrome**  
Replaces PETERBILT  
Part No. 14-13056CP  
Muffler Inlet Elbow

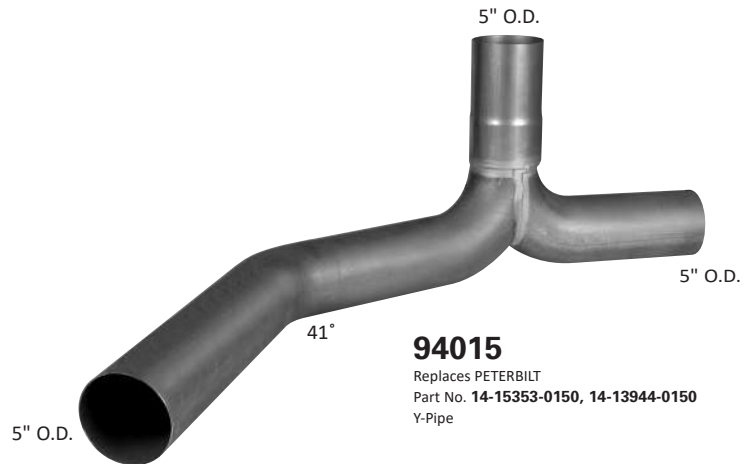

**94015**  
Replaces PETERBILT  
Part No. 14-15353-0150, 14-13944-0150  
Y-Pipe

OEM PIPE  
REPLACEMENT

## SERIES C20/2500, C30/3500

## CHEV./GMC TRUCK

01-04 8 Cyl. Silverado/Sierra 2500 HD/3500 6.6L Diesel Engine; 133" W.B.;  
2 WD/4 WD

(200111)

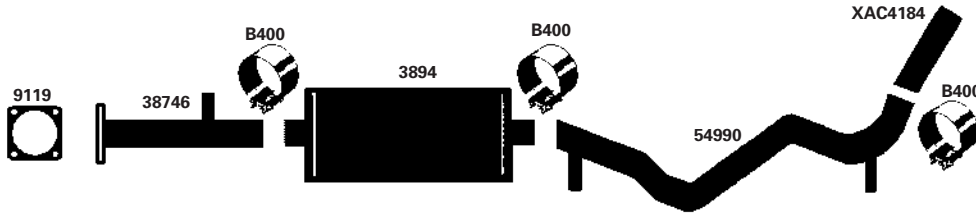

01-04 8 Cyl. Silverado/Sierra 2500 HD/3500 6.6L Diesel Engine; 143.5" W.B.;  
2 WD/4 WD

(200112)

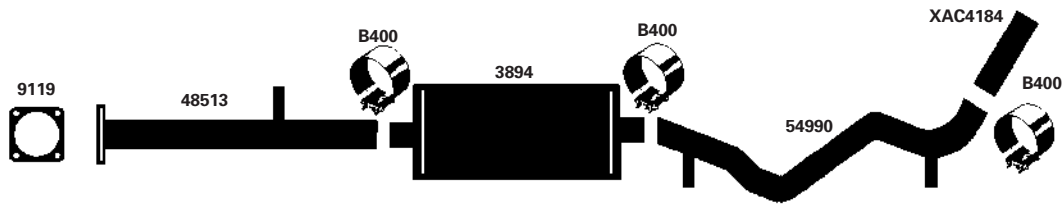

01-04 8 Cyl. Silverado/Sierra 2500 HD/3500 6.6L Diesel Engine; 157.5" W.B.;  
2 WD/4 WD

(200113)

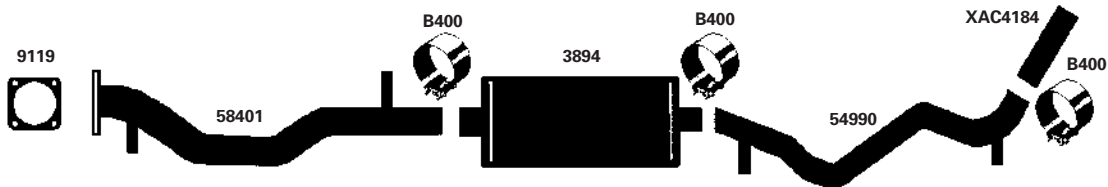

## SERIES C30/3500, R30/3500

## CHEV./GMC TRUCK

94-95 8 Cyl. All models w/ 6.5L Turbo Diesel Engine; 155.5", 168.5" W.B.

(200114)

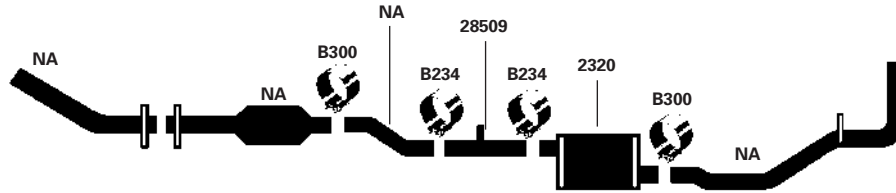

1993 8 Cyl. All models w/ 6.5L Turbo Diesel Engine; 155.5", 168.5" W.B.

(200115)

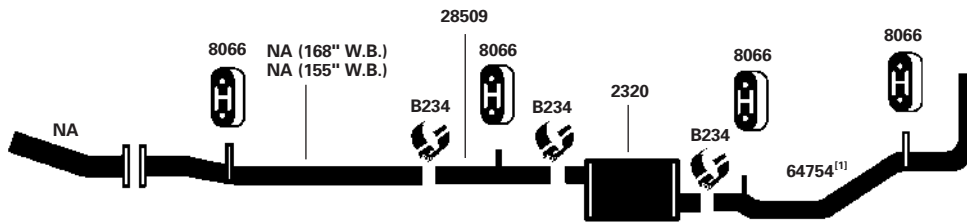

## G30/G3500

## CHEV./GMC TRUCK

1991 6 Cyl. G30/G3500; 125" W.B., 262(4.3L) Engine; Over 8500 lbs. G.V.W.; 1 Ton

(200100)

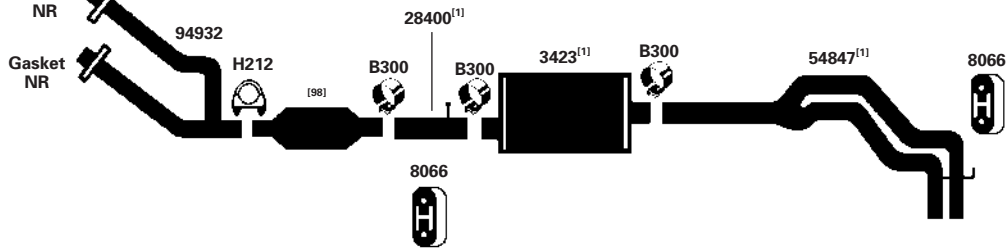

ADAPTER MAY BE REQUIRED FOR OUTLET.  
UNIVERSAL CONVERTER...606006

## SERIES K20/2500, K30/3500

## CHEV./GMC TRUCK

01-04 8 Cyl. Silverado/Sierra 2500 HD/3500 6.6L Diesel Engine; 133" W.B.; 2 WD/4 WD

(200122)

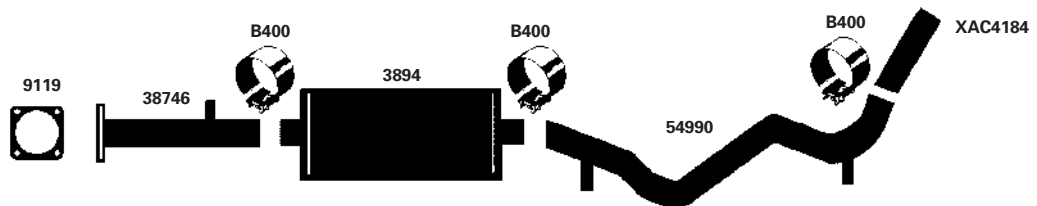

## SERIES K20/2500, K30/3500

## CHEV./GMC TRUCK

01-04 8 Cyl. Silverado/Sierra 2500 HD/3500 6.6L Diesel Engine; 143.5" W.B.; 2 WD/4 WD

(200123)

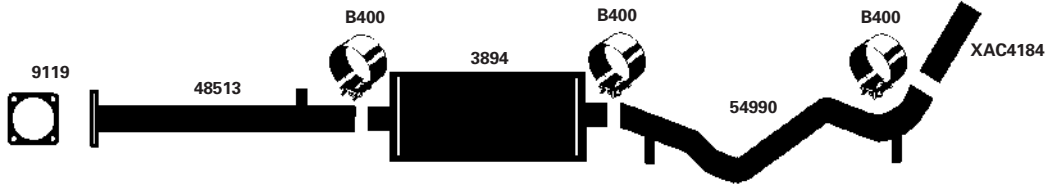

01-04 8 Cyl. Silverado/Sierra 2500 HD/3500 6.6L Diesel Engine; 157.5" W.B.; 2 WD/4 WD

(200124)

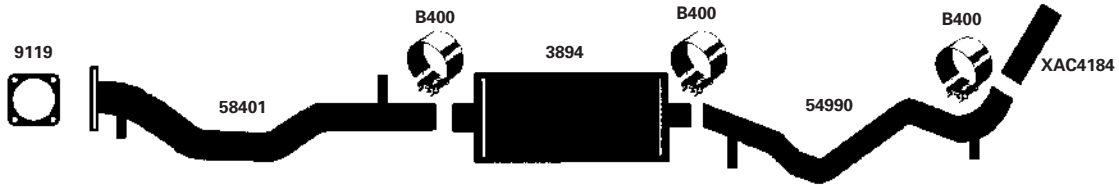

## SERIES K30/3500, V30/3500

## CHEV./GMC TRUCK

1994 8 Cyl. All models w/ 6.5L Turbo Diesel Engine; 155.5", 168.5" W.B.

(200125)

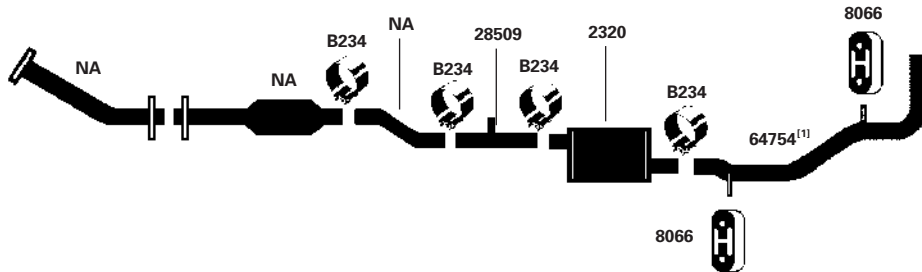

1993 8 Cyl. All models w/ 6.5L Turbo Diesel Engine; 155.5", 168.5" W.B.

(200126)

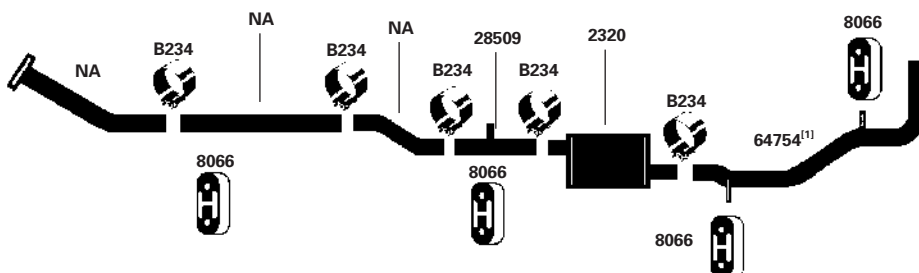

MEDIUM & H.D. APPLICATIONS

## T-SERIES TILT CAB

## CHEV./GMC TRUCK

97-98 6 Cyl. T-Series Tilt Cab w/3116 CAT(6.6L), 3126 CAT(7.2L) Turbo Diesel Engine (200132)



97-98 8 Cyl. T-Series Tilt Cab w/366 C.I.D.(6.0L) Gas Engine (200133)

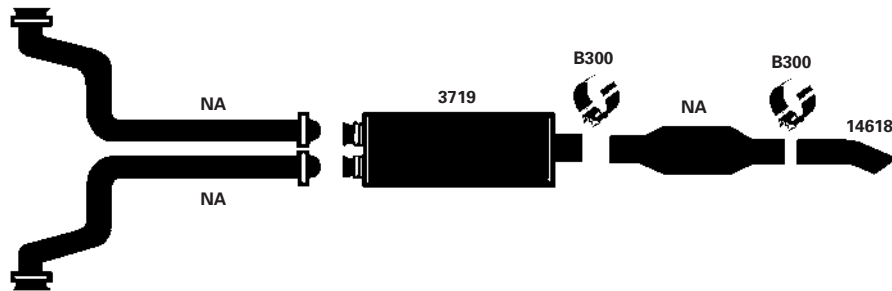

## SERIES W5 TILTMASTER FORWARD CONTROL CHEV./GMC TRUCK

1993 6 Cyl. W5 Tiltmaster (Forward Control); All models; 6.5L Turbo diesel Engine; 113", 177" W.B. (200134)



## SERIES 50, 60, 70, 5000, 6000, 7000

## CHEV./GMC TRUCK

90-00 6 Cyl. C7H, C6H w/ 3116 CAT.(6.6L) Turbo Diesel Engine (200135)

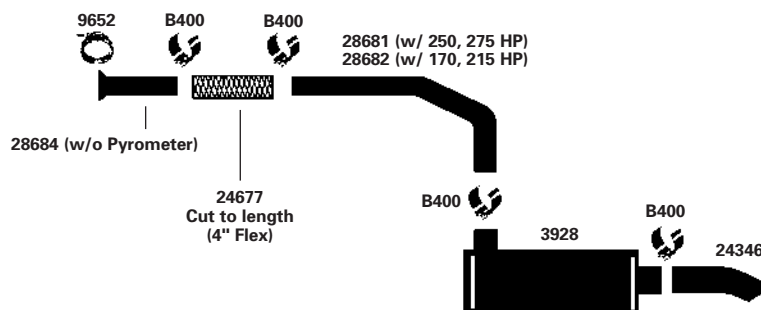



## SERIES 50, 60, 70, 5000, 6000, 7000

## CHEV./GMC TRUCK

90-98 6 Cyl. C7H, C6H w/ 3116 CAT. 403 C.I.D.(6.6L) Turbo Diesel Engine;  
With Vertical Cab Mounted Tailpipe

(200136)

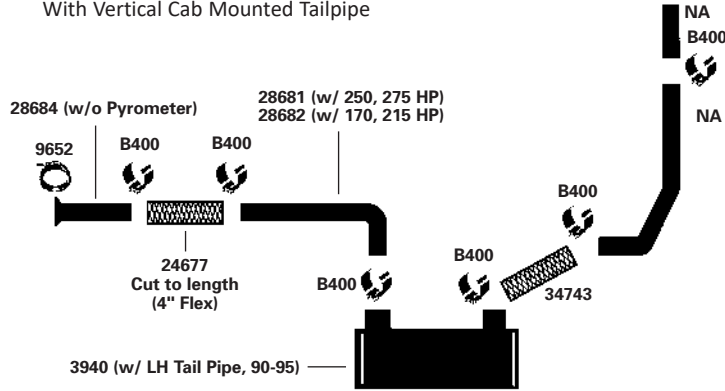

88-98 8 Cyl. C6D, C6H, C7D, C7H w/ 366 C.I.D.(6.0L), 427 C.I.D.(7.0L) T.B.I. Engine;  
Ball & Socket Joint without Converter

(200137)

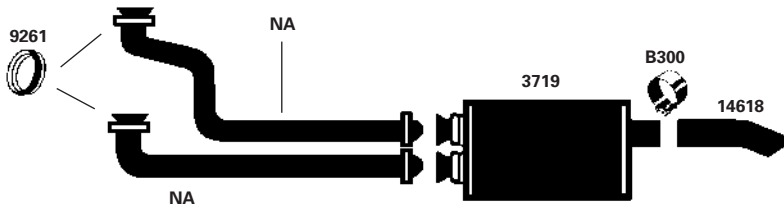

88-90 8 Cyl. C6D, C7D; 8.2N Detroit Diesel Engine; With Vertical Tailpipe

(200138)

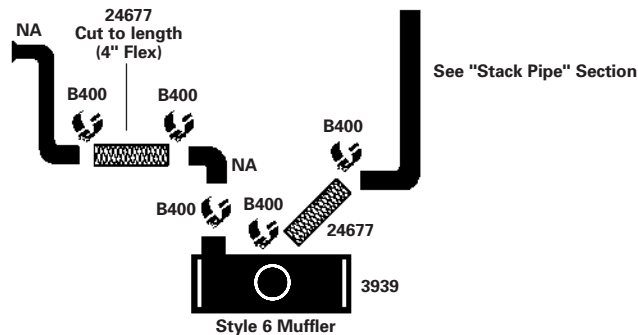

83-84 8 Cyl. C6D w/ Caterpillar 3208N Diesel Engine (Non-Turbo)

(200139)

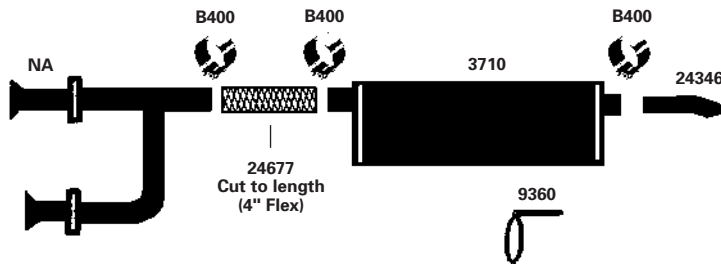

## SERIES 50, 60, 70, 5000, 6000, 7000

## CHEV./GMC TRUCK

1978 4 Cyl. C55, C60, C65 w/ 4-53T Diesel Engine; Conv. Cab (200143)

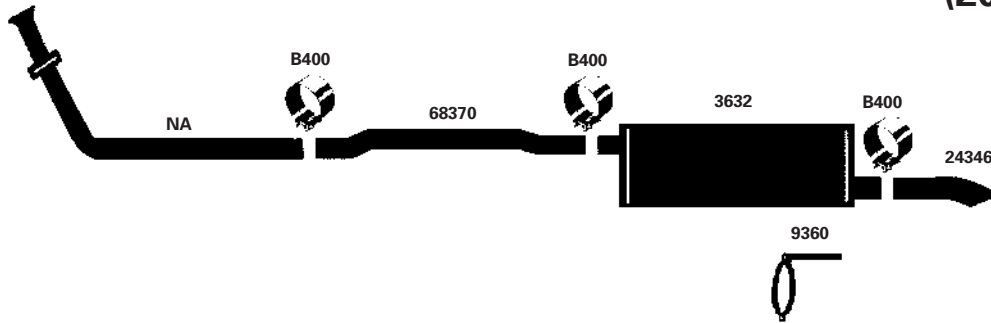

75-78 8 Cyl. C50, C60 w/ 350 C.I.D. (200145)

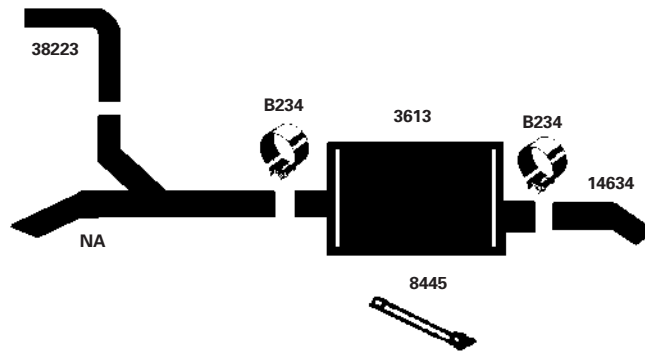

75-78 8 Cyl. Series 65 w/ 366, 427 C.I.D. (Except Stainless Steel Exhaust) (200146)

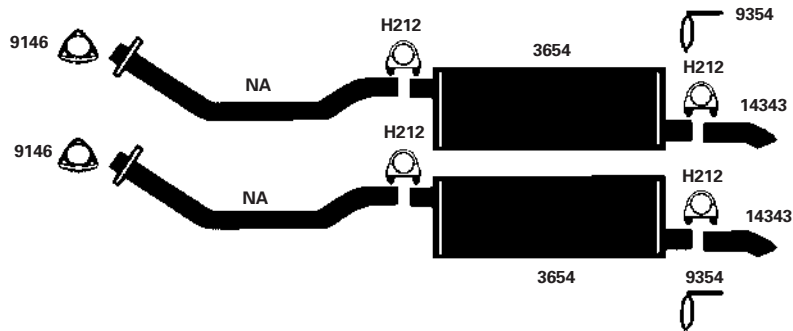

1978 8 Cyl. T60 w/ 366 C.I.D. (200147)

69-78 8 Cyl. C50, C60, C65, M50, M60 w/ 366, 427 C.I.D.

1969 8 Cyl. Series 6500 Tandem w/ 366, 427 C.I.D.

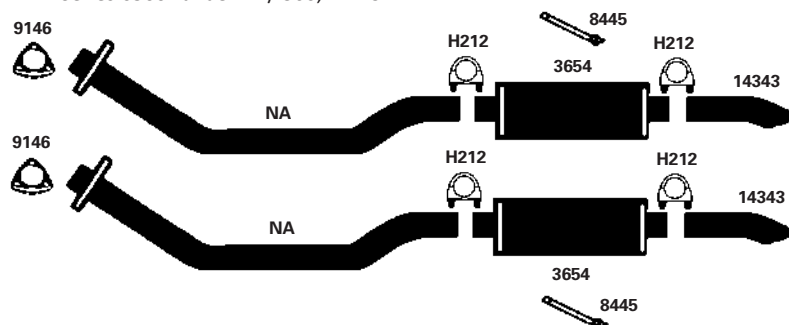

## CHEVROLET/GMC

YEAR	CYL.	TONS	MAKE & MODEL	EXH. PIPE	MUFFLER	TAIL PIPE
<b>CHEV/GMC Series 30-35</b>						
89-91	4		P30, P35 w/239 C.I.D.(3.9L) Diesel Engine		2704	NA
92-93	8		K30, K35, V30, V35 w/6.5L Turbo Diesel Engine; 135.5", 159.5" W.B. (Exc. 15,000 G.V.W.)		2062	NA

YEAR	CYL.	TONS	MAKE & MODEL	EXH. PIPE	MUFFLER	TAIL PIPE
<b>CHEV/GMC Series 40-66</b>						
67-81	8		C50, C5D, C60, C6d w/ 292 C.I.D.; Clamp Joint		3654	14343
1978	8		C50, C60, M60 w/ 366 C.I.D.		3613	14634
75-77	8		T60 w/ 350, 366 C.I.D.		3613	14634
1975	6		C50, C60 w/ COWL w/ 292 C.I.D.		3654	14343
73-74	8		Series 50, 60 w/ 350 C.I.D.		3613	14634
73-74	8		C65 (3 Ton), T65 (3 Ton), M65 (6 Ton) w/ 366, 427 C.I.D.		3654	14343
1972	6		CM5500, CM6500 w/ 351 C.I.D. Gas Engine		609	14342
1972	8		CE4500, CE5500 w/ 350 C.I.D. Gas Engine		609	14342
70-72	6		CS4500, CS5500 w/ 250 C.I.D. Gas Engine			10921
70-72	6		CS4500, CS5500 w/ 292 C.I.D. Gas Engine		3654	14343
70-71	6		CM5500, TM5500 w/ 305 C.I.D. Gas Engine		3654	14343
70-71	6		CM5500, TM5500 w/ 351, 401 C.I.D. Gas Engine		2704	24344
69-74	8		T50, T60 w/366. 427 C.I.D.		3654	14343
69-72	8		Series 40, 50 w/ 350 C.I.D.		609	14342
67-72	6		Series 40 w/ 292 C.I.D.		3654	14343
67-68	6	1.5	PS4500 Series step Van w/292 CID		3654	14343
67-68	8		Series 50, 60 w/307, 366, 427 CID; 125"-218" W.B.		3654	14343
67-68	8		Series 40 w/307, 327 CID 125"-175" W.B.		3654	14343
1967	8		Series 50, 60 (EXC. Conv. Cab w/Sngl. Rear Axle, 288L ES6500; 127"-217" W.B.		3654	14343
67-69	6		EG4500, EM4500, ES4500, EG5500, EM5500, ES5500, EG6500, EM6500, ES6500; 127"-217" W.B.		3654	14343
1967	8		C50, C60; 2BBL. Carb. Sngl. Rear Axle w/366 CID		609	14343
60-68	6		Series 50, 60		3654	14343
63-66	6		Series 50, 60; w/ 292 CID		3654	14343
60-66	6		Series 3500, 4000, 5000, 6000, 6500		3654	14343
63-65	6		B3500, L3500, B4000, BH4000, H4000, KV4000, L4000, LH4000, S4000, B5000, H5000, L5000		3654	14343
56-59	8		500-600 Models		2704	24344
50-53	8		520, 600, 620, 630, 650; w/318, 360 CID		2704	24344
55-59	6		300-500 Models		3654	14343
55-56	8		300-500 Models		3654	14343
1954	6		300-24, 350-24, 350-27, M350-24, M350-27, F350-24, F350-27, 400-24, 400-27, M400-27, 450-30, F450-30, M450-30, W450-30, 470-30, F470-30, M470-30		3654	14343

MEDIUM & H.D.  
APPLICATIONS

## CHEVROLET/GMC

YEAR	CYL.	TONS	MAKE & MODEL	EXH. PIPE	MUFFLER	TAIL PIPE
<b>CHEV/GMC Series 40-66</b>						
55-59	6		W620-W670 Models		3662	24344
50-53	6		620, 630, 640; w/426 503 CID		3662	24344

YEAR	CYL.	TONS	MAKE & MODEL	EXH. PIPE	MUFFLER	TAIL PIPE
<b>CHEV/GMC Series 70-95</b>						
1973	6		Series70, 80 w/ 432, 478 C.I.D.		2704	24344
1973	6		HM7000, JM7000, TM7000, WM7000 HM8000, Jm8000, TM8000, WM8000 w/ 432, 478 C.I.D. Gas Engine		2704	24344
1972	6		Series 80; w/ 401, 478 CID		2704	24344
1972	8		HE9500, JE9500, TE9500 w/ 637 C.I.D. Gas Engine; With horizontal muffler and tailpipe		2704	24344
1972	6		HM7500, TM7500, JM7500, WM7500 w/ 401, 478 C.I.D. Gas Engine		3654	14343
1972	6		HM7500, TM7500, JM7500, WM7500 w/ 401, 478 C.I.D. Gas Engine		2704	24344
1971	6		Series 80 (Exc. Tilt Tandem) w/ 401, 478 C.I.D.		2704	24344
70-71	6		TS5500 w/ 292 C.I.D. Gas Engine		3654	14343
70-71	6		HM7500, TM7500, TM7500, WM7500 w/ 351, 401 C.I.D. Gas Engine		2704	24344
70-71	8		HJ7500, HJ7500A, JJ7500, JJ7500A, HE9500A, JE9500, JE9500A, TE9500 w/ 637 C.I.D. Gas Engine; With horizontal exhaust and tailpipe		2704	24344
1968	8		Series 80; w/ 366, 427 CID		3654	14343
66-69	6		Series 70, 80; (Muffler w/2-1/2" ID Outlet) w/ 401, 478 CID		3654	14343
67-68	6		Series 40 Dubl. Duty w/ 292 C.I.D.; 149", 175" W.B.		3654	14343
66-67	8		HJ7500, JE7500, JJ7500, TJ7500, CE9500, CJ9500, HE9500, HJ9500, TJ9500, WE9500, WJ9500, w/637 CID Gas Engine; With horizontal Exhaust & Tail Pipe		2704	28344
60-65	V12		7000 Series (exc. D)		2704	28344
63-66	8		Series 80		3654	14343
60-62	8		Series 70, 80"		3654	14343
50-53	6		700, 770; w/318, 360 CID		2704	28344
50-53	6		720, 740, 750, 760, 850, 870, 890; w/426, 503 CID		3662	28344

## DIVCO

YEAR	CYL.	TONS	MAKE & MODEL	EXH. PIPE	MUFFLER	TAIL PIPE
<b>DIVCO</b>						
62-64	6		40D, 40E, 43, 50E, 50F, 53, 70C, 70D, 73, 75, 76, 200C		2704	24344

## RAM PICKUP - 2 WD/4 WD

## DODGE/PLYM. TRUCK

94-02 6 Cyl. Ram 2500/ 3500 w/ 5.9L Cummins Turbo Diesel Engine; All wheel bases **(200165)**

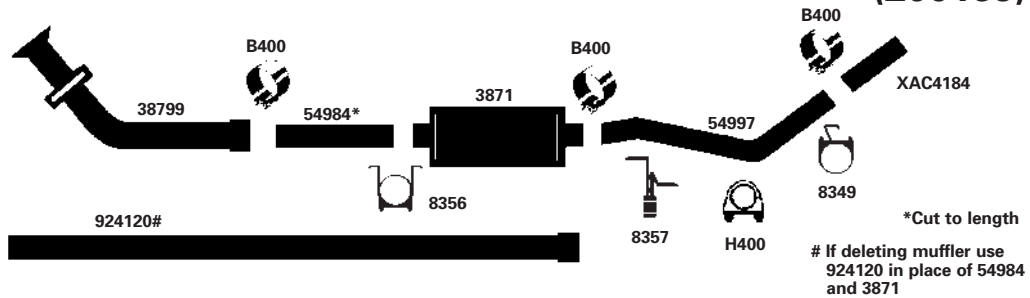

## SERIES R3500

## DODGE/PLYM. TRUCK

1994 6 Cyl. R3500; 360 C.I.D.(5.9L) Cummins Turbo Diesel Engine; Built before 01-03-94; Without Converter **(200163)**

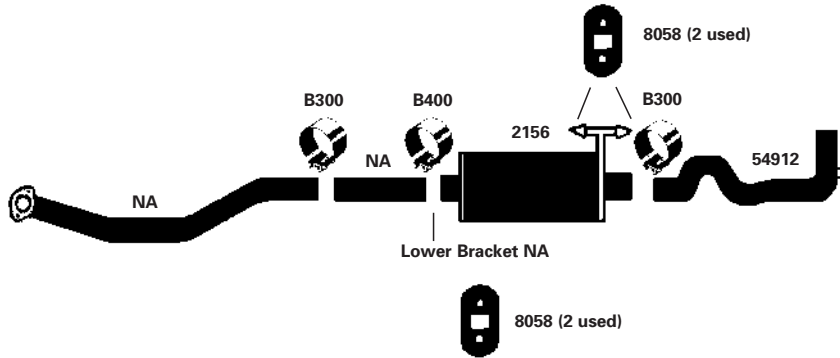

## F SERIES - SUPER DUTY PICK-UP - DIESEL

## FORD TRUCK

99-03 8 Cyl. F250/350 Super Duty; 7.3L Power Stroke Turbo Diesel Engine; Exits on Passenger Side; 4" Single Inlet/4" Single Tail Pipe **(200172)**

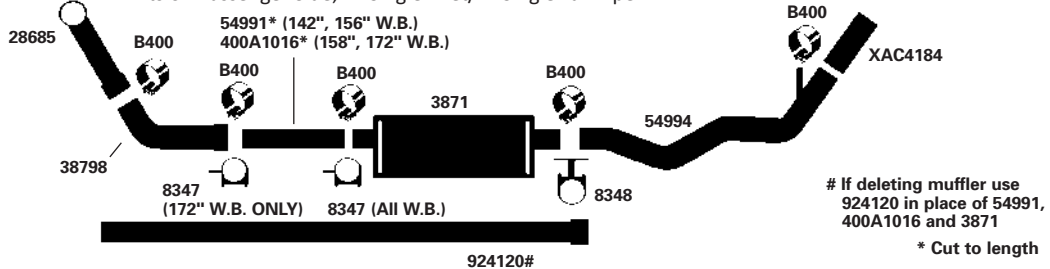

MEDIUM & H.D. APPLICATIONS

## F350 SERIES

## FORD TRUCK

**96-97** 8 Cyl. F350 Series; 351 C.I.D.(5.8L) Engine; 133" W.B.; 4 WD; 1 Ton **(200173)**  
**96-97** 8 Cyl. F350 Series; 351 C.I.D.(5.8L) Engine; 133", 155" W.B.; 2 WD; 1 Ton

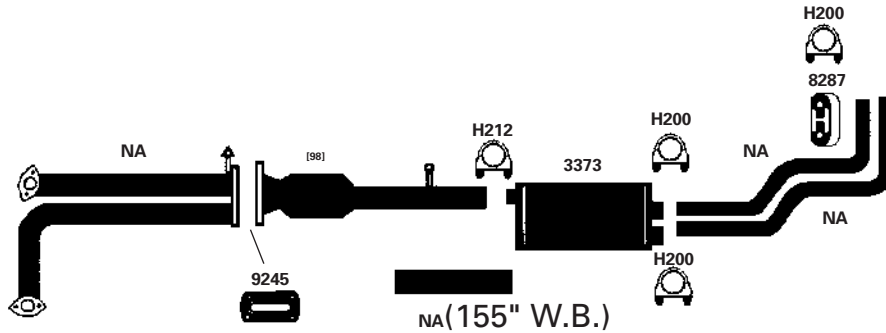

**1996** 6 Cyl. F350 w/ 300 C.I.D.; 133" W.B.; 4.9L Engine **(200170)**

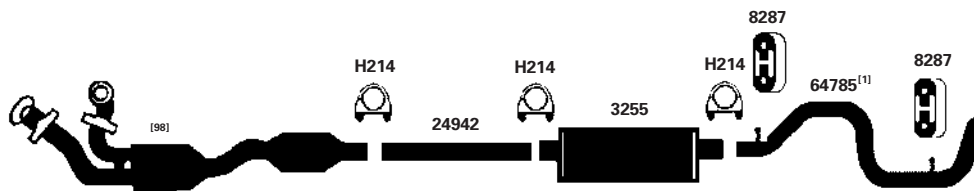

**95-96** 8 Cyl. F350 Series; 7.3L Turbo Diesel Engine; 168" W.B.; 1 Ton; w/ Converter **(200174)**

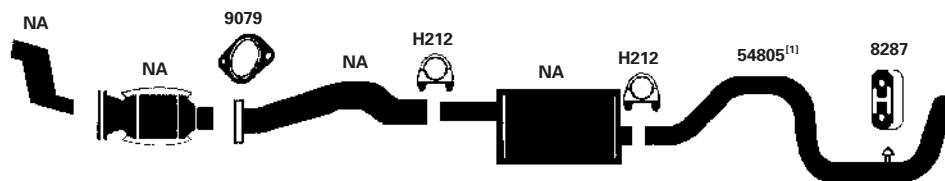

**88-95** 6 Cyl. F350 w/ 300 C.I.D.; 133" W.B.; 4.9L Engine **(200171)**

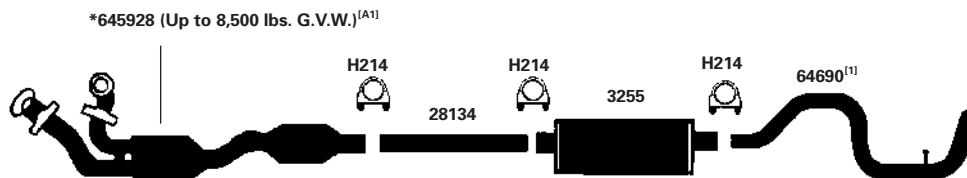

<sup>(A1)</sup> Combination Front and Rear Converter, 2 To 1 Replacement Only Defective Converters May Legally Be Replaced.

UNIVERSAL CONVERTER...<sup>[98]</sup>

## F350 SERIES

## FORD TRUCK

93-95 8 Cyl. F350 Series; 460 C.I.D.(7.5L) EFI Engine; 136", 160" W.B.

(200289)

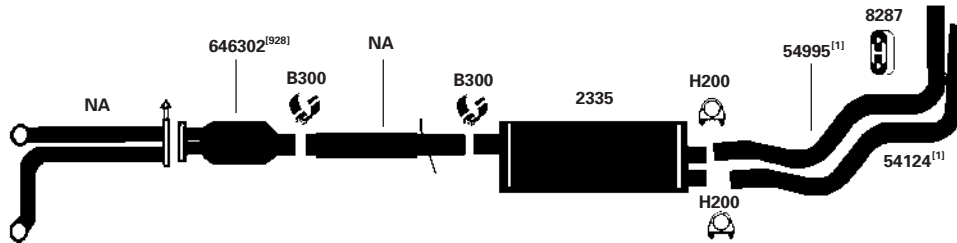

88-95 8 Cyl. F350 Series; 136", 160" W.B.; 351, 460 C.I.D. EFI Engine;  
Electronic 4 Speed Automatic Overdrive Transmission (E4OD)  
(Exc. 93-95 460 C.I.D.)

(200176)

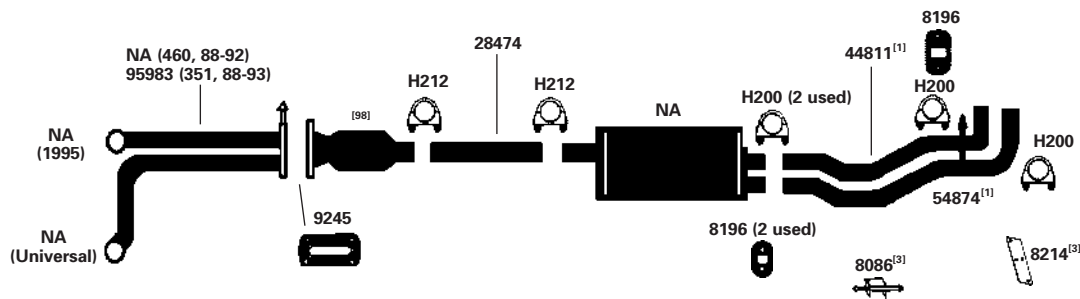

88-95 8 Cyl. F350 Series; 133", 168" W.B.; 351 C.I.D.(5.8L) Engine; (After 2-88)  
88-92 8 Cyl. F350 Series; 133", 168" W.B.; 460 C.I.D.(7.5L) Engine; (After 2-88)

(200177)

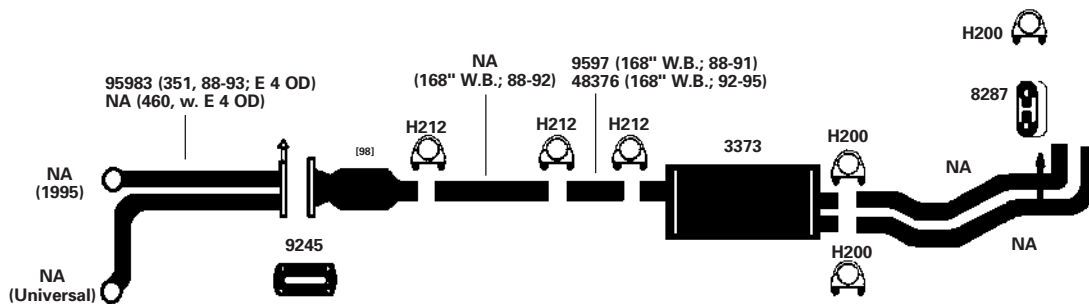

## F450 SERIES

## FORD TRUCK

1997 8 Cyl. F450 Series; 137", 161", 178", 185" W.B.; Regular Cab; Pickup;  
7.3L Turbo Diesel Engine

**(200180)**

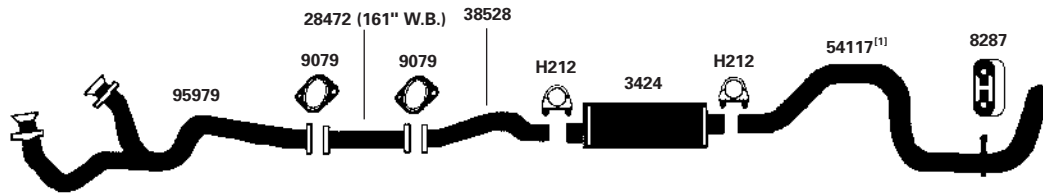

1997 8 Cyl. F450 Series; 178", 190", 208", 228" W.B.; Stripped Pickup;  
7.3L Turbo Diesel Engine

**(200181)**

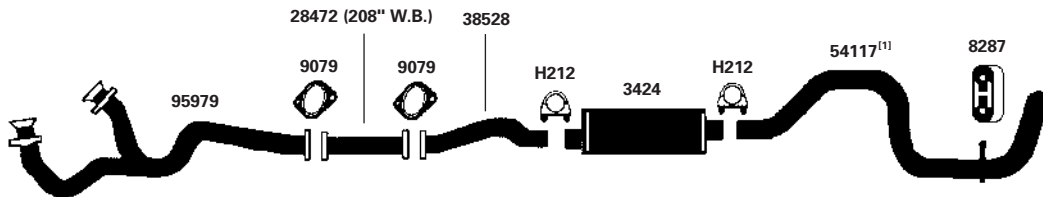

96-97 8 Cyl. F450 Series; 137", 161", 185" W.B.; Super Duty; Chassis Cab;  
460 C.I.D.(7.5L) Engine

**(200182)**

1997 8 Cyl. F450 Series Motorhome; 178", 190", 208" W.B.

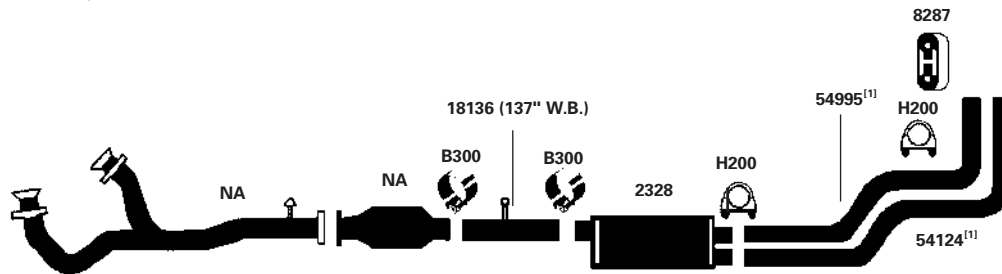

NOTE: FRONT BRACKET ON MUFFLER NOT REQUIRED ON ALL MODELS – CUT OFF IF IT INTERFERES.

93-95 8 Cyl. F450; 460 C.I.D.(7.5L) Engine; 136", 160", 185" W.B.; With Converter

**(200294)**

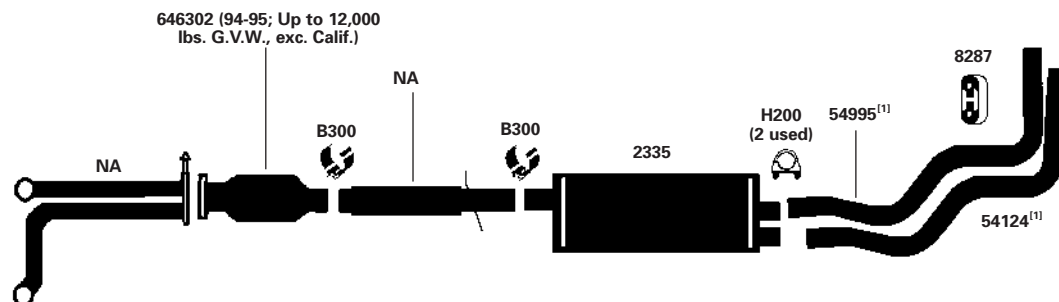

UNIVERSAL CONVERTER (94-95; Up to 12,000 lbs. G.V.W., exc. Calif.)...607007



## F450 SERIES

## FORD TRUCK

93-95 8 Cyl. F450; 460 C.I.D.(7.5L) Engine; 136", 160" W.B.; Without Converter

(200295)

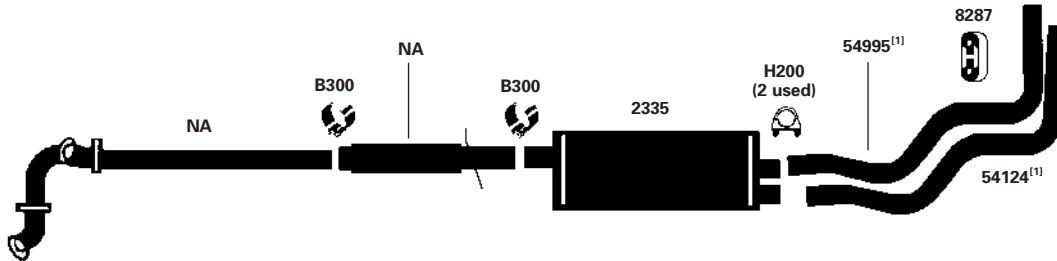

88-92 8 Cyl. F450 Series; 136", 160", 185" W.B.; 460 C.I.D.(7.5L) Engine; With Converter

(200183)

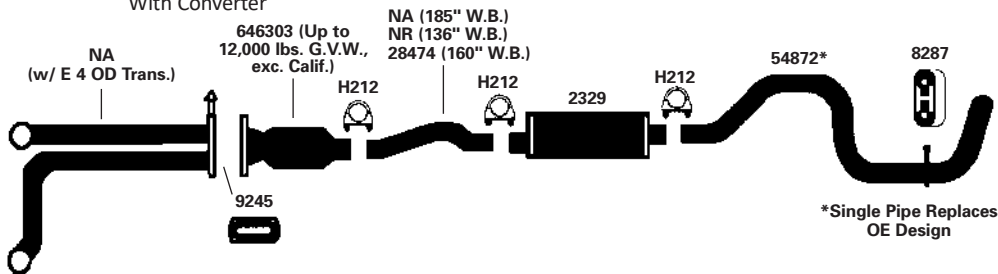

UNIVERSAL CONVERTER (Up to 12,000 lbs. G.V.W., exc. Calif.)...607007

## C600, C700, C750, C800 SERIES

## FORD TRUCK

93-94 6 Cyl. CF700; Cummins FD1060(5.9L) Diesel Engine; Without Converter; (Before 11-93)

(200184)

93-94 6 Cyl. CF800; Cummins FD1060(5.9L) Diesel Engine; Without Converter; (Before 11-93)

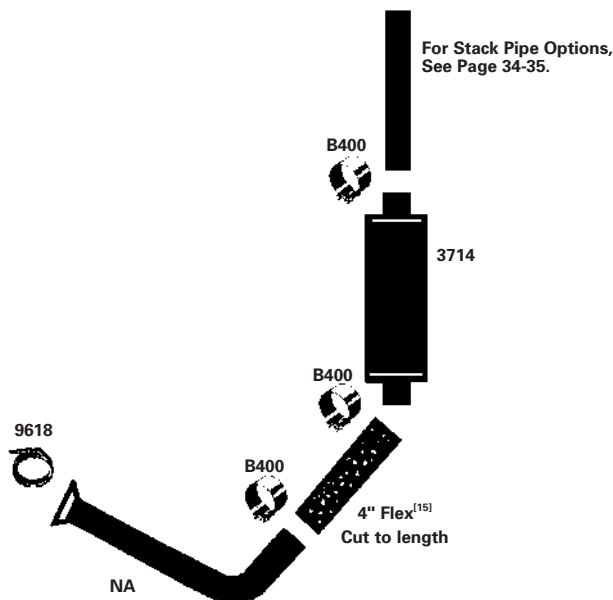

## C600, C700, C750, C800 SERIES

## FORD TRUCK

93-94	6 Cyl.	CF700; Cummins FD1460(8.3L) Diesel Engine; Without Converter; (Before 11-93)	<b>(200185)</b>
93-94	6 Cyl.	CF800; Cummins FD1460(8.3L) Diesel Engine; Without Converter; (Before 11-93)	

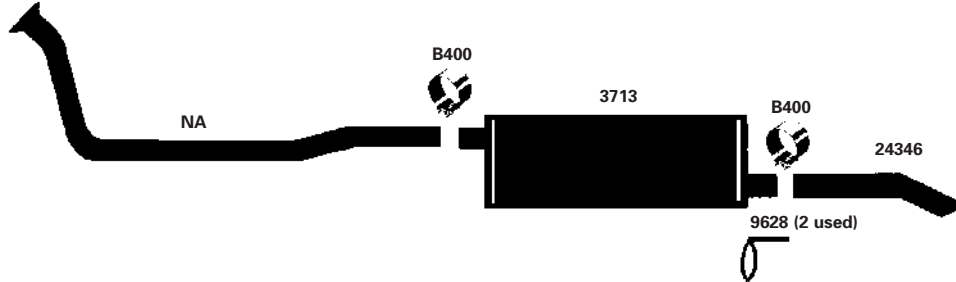

## C900, CT900 SERIES

## FORD TRUCK

79-80	8 Cyl.	CT900; 370, 429 C.I.D.	<b>(200202)</b>
-------	--------	------------------------	-----------------

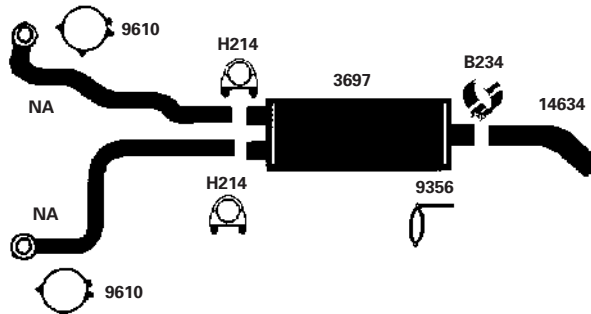

## F600, F700, F800 SERIES

## FORD TRUCK

92-98	6 Cyl.	F600; Cummins FD1060(5.9L) Diesel Engine; Exc. Low Profile; (Before 11-93)	<b>(200205)</b>
92-98	6 Cyl.	F700; Cummins FD1060(5.9L) Diesel Engine; Exc. Low Profile; (Before 11-93); Without Converter	
92-98	6 Cyl.	F, FT800; Cummins FD1060(5.9L) Diesel Engine; Without Converter	

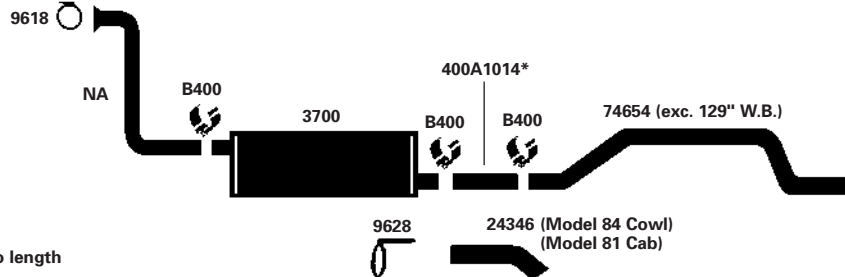

\* Cut to length

MEDIUM & H.D. APPLICATIONS

## F600, F700, F800 SERIES

## FORD TRUCK

- 90-92 6 Cyl. F700; 401(6.6L) Diesel Engine; Model 81(Cab); Left Side Exhaust; Low Profile
- 90-92 6 Cyl. F600; 401(6.6L) Diesel Engine; Model 81(Cab); Left Side Exhaust; Low Profile

(200206)

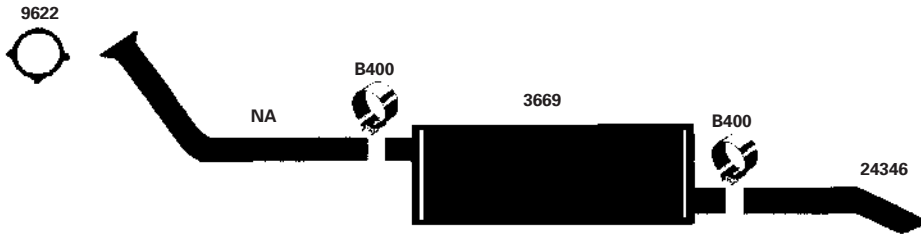

- 80-83 8 Cyl. F600; 501(8.2L) C.I.D. Turbo Diesel Engine; All Wheel Bases
- 80-83 8 Cyl. F700; 501(8.2L) C.I.D. Turbo Diesel Engine; All Wheel Bases
- 80-83 8 Cyl. F800, FT800; 501(8.2L) C.I.D. Turbo Diesel Engine; All Wheel Bases

(200209)

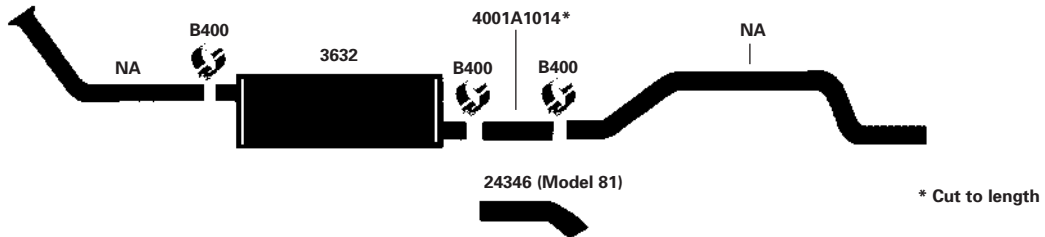

## SERIES LN700, LN750

## FORD TRUCK

(200231)

- 93-94 6 Cyl. All models w/ Cummins FD1060 (5.9L) Diesel Engine; (Before 11-93); Without Converter
- 93-94 6 Cyl. All models w/ Cummins FD1460 (8.3L) Diesel Engine; (Before 11-93); Without Converter

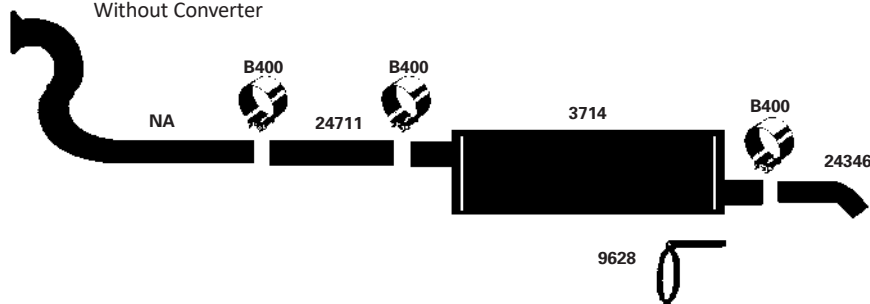

## FORD

YEAR	CYL.	TONS	MAKE & MODEL	EXH. PIPE	MUFFLER	TAIL PIPE
<b>FORD-Series C500, C550</b>						<b>1-1.5 TON</b>
65-72	6		C500, C550		3654	14343
61-72	8		C500, C550		3654	14634
1969	8		C500, C550		3654	14343
1956	8		C500		3654	10921
<b>FORD-Series F500, F550</b>						<b>1-1.5 TON</b>
69-75	8		F500; (Model 84, 85 Cowl Only)		3654	14343
67-75	8		F500; (Model 81 Cab Only) Before Ser. Q80,001		3654	14343
1969	8		F500		3654	14343
65-69	6		F500; w/2-1/2" Muffler Connections		3654	14343
64-69	8		F500		3654	14343
<b>FORD-Series L500, L550</b>						<b>1-1.5 TON</b>
70-72	8		LN500		3654	14343
<b>FORD-Series N500, N550</b>						<b>1-1.5 TON</b>
67-69	8		N500		3654	14343
65-66	6		N500; w/2-1/2" Muffler Connections		3654	14343
65-66	6		N500		3654	14343
<b>FORD-Series C600</b>						<b>1.5-2.5 TON</b>
75-78	6		C600; (From SER. V20,001)		2958	24344
75-78	8		C600; 330, 361 C.I.D. (From V20,001 to SER. BC5,001)		2958	24344
74-78	8		C600 Diesel Engine (p to SER. BC5,001)		3611	24346
69-78	8		C600		3654	14343
65-75	6		C600; (Up to SER. V20,001)		3654	14343
65-73	8		C600; 330, 361 C.I.D. (Before SER. V20,001)		3654	14343
1973	8		C600 Diesel Engine (After SER. Q80,001)		3611	24345
1970	6		C600; 363 C.I.D. Diesel Engine		3654	14343
1964	8		C600; w/330 CID, 2-1/2" Muffler Connections		3654	14343
55-56	8		C600		3654	14343
<b>FORD-Series F600</b>						<b>1.5-2.5 TON</b>
1987	6		F600; 401 (6.6L), 476 (7.8L) Diesel Engine; Model 81 (Cab); Left Side Mounted Vertical Tail Pipe		3920	NA
74-79	8		F600 Diesel Engine; (Up to SER. V20,001) Exc. Models equipped w/ PTO (Power Take Off)		3611	24345
76-78			F600; Gas Engine; 4 WD; (Up to SER. BC5,001)		2958	14343
75-78	6		F600; (Up to SER. BC5,001)		2958	14343
75-78	8		F600; 330, 361 C.I.D. Model 81346 CAB			14342
75-78	8		F600; Gas Engine; 2 WD		2958	14343
73-75	8		F600; 330, 361 C.I.D. (Before SER. V80,001)		3654	14343
69-75	8		F600; Model 81346 CAB (Before SER. V80,001)		3654	14343
1975	8		F600; (From SER. W40,001)		2958	14343
1974	8		F600; 330 C.I.D. Model 81346 CAB		3654	14343
73-74	8		F600 Diesel Engine; (After SER. Q80,001)		3611	24346
71-73	8		F600; (Before SER. Q80,001); 4 WD		3654	14343
70-72	6		F600; 300 C.I.D.		3654	14343
1970	6		F600with 363 C.I.D. Diesel Engine		3654	14343
67-73	8		F600; Model 84(Cowl) Only; 2 WD		3654	14343
67-73	8		F600; Model 81(Cab); 2 WD		3654	14343
65-69	6		F600; w/2-1/2" Muffler Connections		3654	14343
64-66	8		F600, F650	48335	3654	14343
1956	8		F600		3654	14343

See page 230 for footnote explanations

## FORD

YEAR	CYL.	TONS	MAKE & MODEL	EXH. PIPE	MUFFLER	TAIL PIPE
<b>FORD-Series LN600</b>			<b>1.5-2.5 TON</b>			
75-78	6		LN600 (From SER. V20,001)		2958	14343
75-78	8		LN600 (From SER. V20,001 to BC5,001)		2958	14343
70-75	6		LN600		3654	14343
70-75	8		LN600		3654	14343
73-75	8		LN600; 330, 361 C.I.D. (From SER. V20,001)		3654	14343
70-73	8		LN600		3654	14343
<b>FORD-Series N600</b>			<b>1.5-2.5 TON</b>			
1969	8		N600		3654	14343
67-69	8		N600		3654	14343
65-69	8		N600; w/2-1/2" Muffler Connections		3654	14343
64-66	8		N600; w/2-1/2" Muffler Inlet	48335	3654	14343
<b>FORD-Series C700, C750</b>			<b>2-3.5 TON</b>			
73-79	8		C700 Diesel Engine (Up to SER. BC5,001)		3611	24346
69-78	8		C700, C750		3654	14343
75-78	8		C700, C750; 361, 389, 391 C.I.D. (From SER. V20,001 to BC5,001)		2958	14343
1978	8		C700; 361, 389, 391 C.I.D. (From SER. BC5,001)		2958	24344
64-75	8		C700, C750; 361, 389, 391 C.I.D. (Before SER. V20,001)		3654	14343
1970	6		C700; 363(5.9L) C.I.D. Diesel Engine		3654	14343
61-69	8		C700, C750, CT750		3654	14343
56-60	8		Series C700, C750		3654	14343
<b>FORD-Series F700, F750</b>			<b>2-3.5 TON</b>			
1987	6		F700; 401 (6.6L), 476 (7.8L) Diesel Engine; Model 81 (CAB); Left Side Mounted Vertical Tail Pipe		3920	NA
73-79	8		F700 Diesel Engine; (UP to SER. BC5,001)		3611	24345
75-77	8		C750; 361, 389, 391 C.I.D.; With Muffler Strap (From SER. V20,001)		2958	14343
73-75	8		C750; 361, 389, 391 C.I.D.; Without Muffler Strap (Before SER. V20,001)		3654	14343
73-75	8		F700, F750 (Up to SER. V20,001); F750 (Up to SER. V80,001)		3654	14343
67-73	8		F700, F750; Model 81(Cab) Only		3654	14343
1973	8		F700; 361 C.I.D.; Model 84(Cowl) Only		3654	14343
69-72	8		F700, F750		3654	14343
69-72	8		F700, F750; Model 84 (Cowl) Only		3654	14343
1970	6		F700 with 363 C.I.D. Diesel Engine		3654	14343
61-66	8		F700, F750		3654	14343
57-60	8		F750; w/2-1/2" Muffler Inlet		3654	14343
1956	8		Series F700, F750		3654	14343
<b>FORD-Series LN700, LN750</b>			<b>2-3.5 TON</b>			
93-94	6		All models w/ Cummins FD1460 (8.3L) Diesel Engine; (Before 11-93); Vertical Muffler; Without Converter		3714	NA
93-94	6		LN700 w/ Cummins FD1060 (5.9L) Diesel Engine; (Before 11-93); Vertical Muffler; Without Converter		3714	NA
75-78	8		LN700; 361, 389, 391 C.I.D. (From SER. V20,001 to BC5,001)		2958	14343
73-78	8		LN700; Diesel Engine		3611	24345
73-75	8		LN700; 361, 389, 391 C.I.D. (Before SER. V20,001)		3654	14343

MEDIUM & H.D. APPLICATIONS

## FORD

YEAR	CYL.	TONS	MAKE & MODEL	EXH. PIPE	MUFFLER	TAIL PIPE
<b>FORD-Series LN700, LN750 (Con't)</b>						<b>2-3.5 TON</b>
70-75	8		LN700, LN750		3654	14343
70-73	8		LN700, LN750		3654	14343
<b>FORD-Series N700, N750</b>						<b>2-3.5 TON</b>
1969	8		N700, N750		3654	14343
67-69	8		N700, N750		3654	14343
61-66	8		N700, N750		3654	14343
1959	8		Series N700, N750		3654	14343
1956	8		Series N700, N750		3654	14343
<b>FORD-Series P700, P750</b>						<b>2-3.5 TON</b>
1956	8		Series P700, P750		3654	14343
<b>FORD-Series T700, T750</b>						<b>2-3.5 TON</b>
61-66	8		T700, T750		3654	14343
57-60	8		T700 w/302 CID, T750 w/2-1/2" Muffler Inlet		3654	14343
1956	8		Series T700, T750		3654	14343
<b>FORD-Series C800, C850</b>						<b>2.5-3.5 TON</b>
78-82	8		C800, CT800; 573, 636 C.I.D.; Diesel Engine (Up to 12-01-81); (Exc. Turbo)		3611	24346
1980	8		C800; 475 C.I.D. (From SER. BC5,001)		3611	24346
75-79	8		C800, CT800; 475 C.I.D.; Gas		3611	24346
70-78	8		C800, CT800		3654	14343
75-78	8		C800, CT800; 361, 389, 391 C.I.D. (Up to SER. BC5,001)		2958	24344
1978	8		C800, CT800; 361, 389, 391 C.I.D. (From SER. BC5,001)		2958	24344
64-74	8		C800, C850, CT800		3654	14343
1969	8		C800, CT800, C850; w/361, 391 CID		3654	14343
61-69	8		C800, CT800, C850		3654	14343
58-60	8		C800, C850; w/2-1/2" Muffler Inlet		3654	14343
1956	8		Series C800, C850		3654	14343
<b>FORD-Series F800, F850, F880</b>						<b>2.5-3.5 TON</b>
1987	6		F800; FT800; 401 (6.6L), 476 (7.8L) Diesel Engine, Model 81 (Cab); Left Side Mounted Vertical Tail Pipe		3920	NA
75-79	8		F800, F880; 475 C.I.D.; Gas Engine		3611	24345
61-69	8		F800		3654	14343
56-60	8		F800, F850		3654	14343
<b>FORD-Series L800, L850</b>						<b>2.5-3.5 TON</b>
75-78	8		L800, LN800, LNT800, LTS800; 361, 389, 391 C.I.D.		2958	14343
70-74	8		L800, LN800, LT800, LNT800, LTS800		3654	14343
1956	8		Series L800, L850		3654	14343
<b>FORD-Series N800, N850</b>						<b>2.5-3.5 TON</b>
1956	8		Series N800, N850		3654	14343
<b>FORD-Series P800, P850</b>						<b>2.5-3.5 TON</b>
1956	8		Series P800, P850		3654	14343
<b>FORD-Series T800, T850</b>						<b>2.5-3.5 TON</b>
61-69	8		T800		3654	14343
56-57	8		Series T800, T850		3654	14343
<b>FORD-Series C900, C950</b>						<b>2.5-5 TON</b>
73-78	8		C900, CT900; (From SER. V20,001 to BC5,001); 401, 477, 534 C.I.D.; Single Exhaust		3611	24345
56-60	8		Series C900		3654	14343
56-60	8		F900		3654	14343

## FORD

YEAR	CYL.	TONS	MAKE & MODEL	EXH. PIPE	MUFFLER	TAIL PIPE
<b>FORD-Series L900, L950</b>						
1956	8		Series L900		3654	14343
<b>FORD-Series N900, N950</b>						
1956	8		N900		3654	14343
<b>FORD-Series P900, P950</b>						
1956	8		Series P900		3654	14343
<b>FORD-Series T900, T950</b>						
1956	8		Series T900		3654	14343

## FREIGHTLINER

1998-01      Freightliner B-Series Cummins Engine      **(200339)**

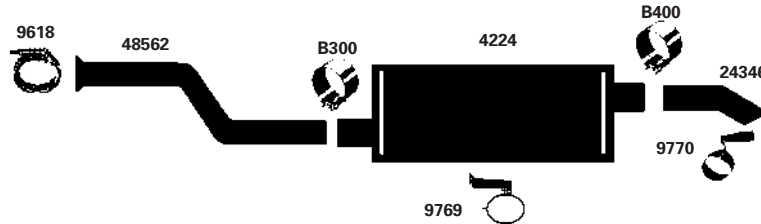

1998-01      Freightliner 3126 Caterpillar Engine      **(200340)**

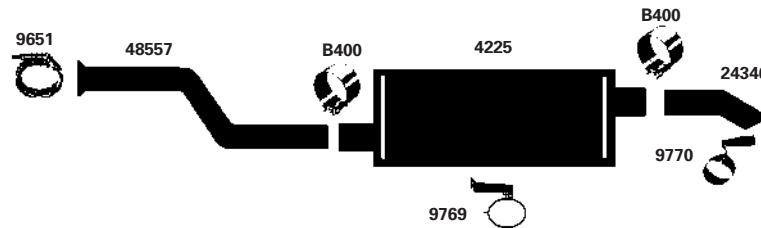

### 1000 SERIES CHASSIS - 1 1/2 TON & OVER

### NAVISTAR/INT'L

91-93      6 Cyl.      1652SC, DT360 Diesel Engine; Stripped Chassis; Long Tail Pipe; RH Mounting Front of Rear Wheel      **(200248)**

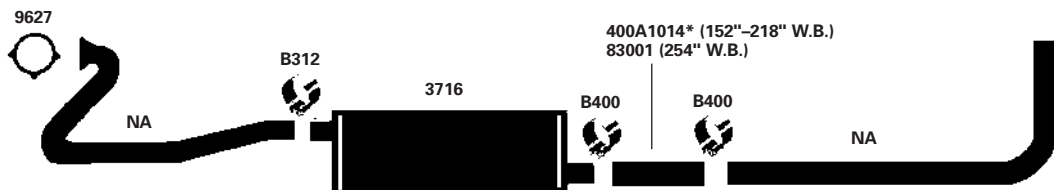

\* Cut to length

91-93      8 Cyl.      1452SC, 1652SC, 7.3L Diesel Engine; Stripped Chassis; Long Tail Pipe; Exits Front of Rear Wheel; Right Hand Mounting      **(200355)**

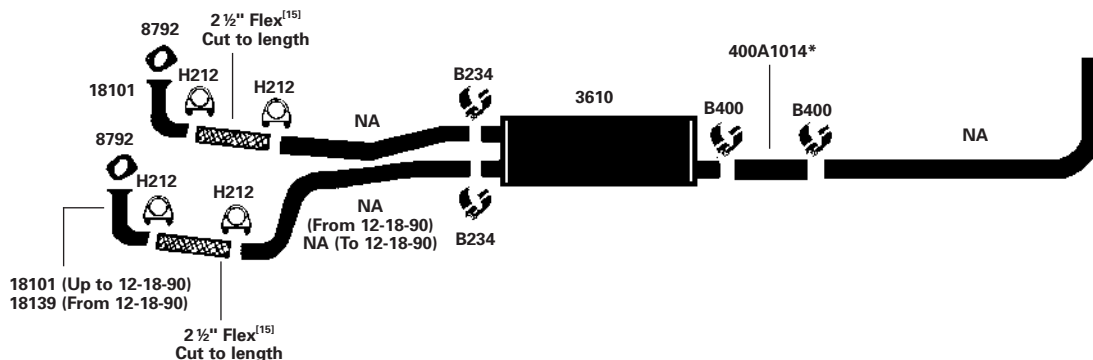

\* Cut to length



## 1000 SERIES CHASSIS - 1 1/2 TON & OVER

## NAVISTAR/INT'L

91-93 8 Cyl. 1652SC, 7.3L Diesel Engine; Stripped Chassis; Long Tail Pipe; Left Hand Mounting **(200249)**

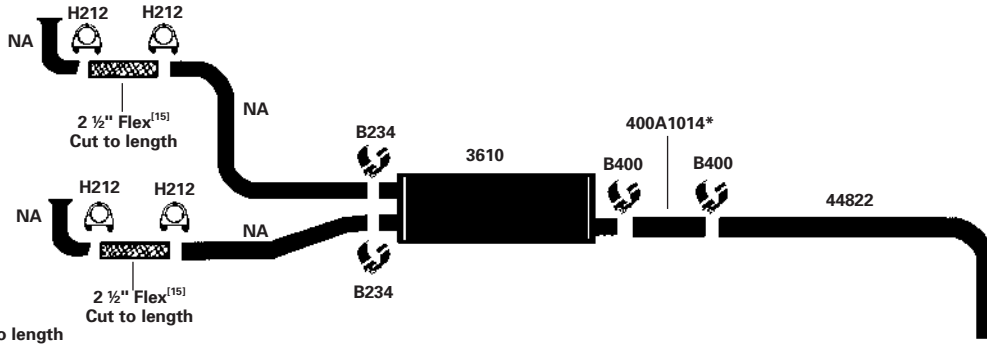

91-93 8 Cyl. 1652SC, 7.3L Diesel Engine; Left Hand Mounting; Tail Pipe Exits Front of Rear Wheel **(200250)**

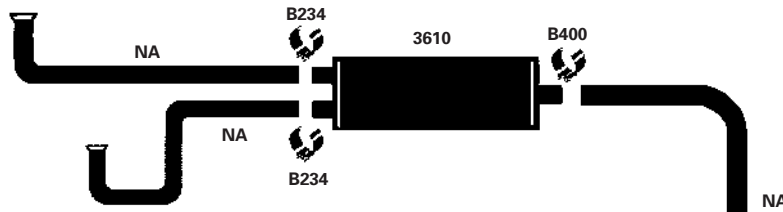

## 4000 SERIES CHASSIS - 1 1/2 TON & OVER

## NAVISTAR/INT'L

94-99 8 Cyl. 4500, 4700, T444E Diesel Engine; L.H. Frame Mounted Short Tail Pipe; Code 07AAZ **(200251)**

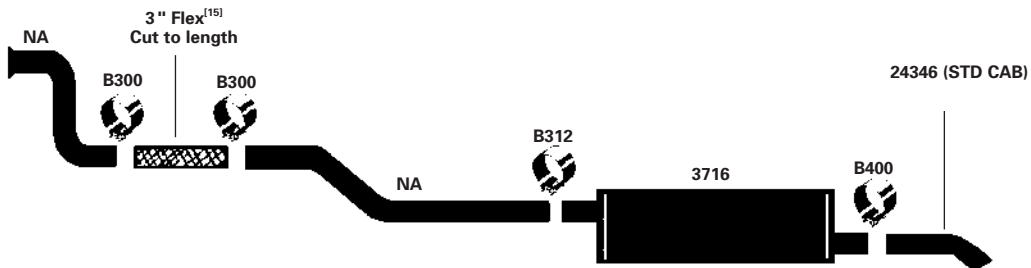

94-99 8 Cyl. 4700, T444E Diesel Engine; R.H. Mounted Muffler Long Tail Pipe; Code 07AAX **(200252)**

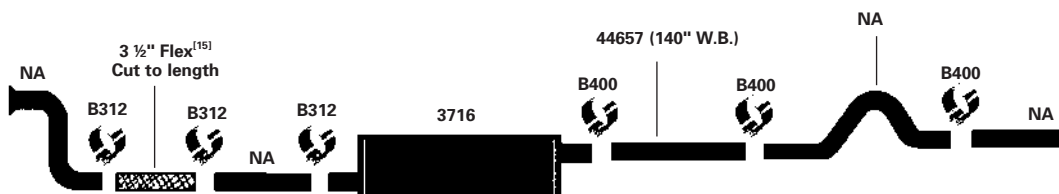

## 4000 SERIES CHASSIS - 1 1/2 TON & OVER

## NAVISTAR/INT'L

**94-99** 6 Cyl. 4000, DT408, DT466 NGD, 530 Diesel Engine; RH Frame Mounted without Beverage & Utility Body; Code 07AAY

**(200256)**

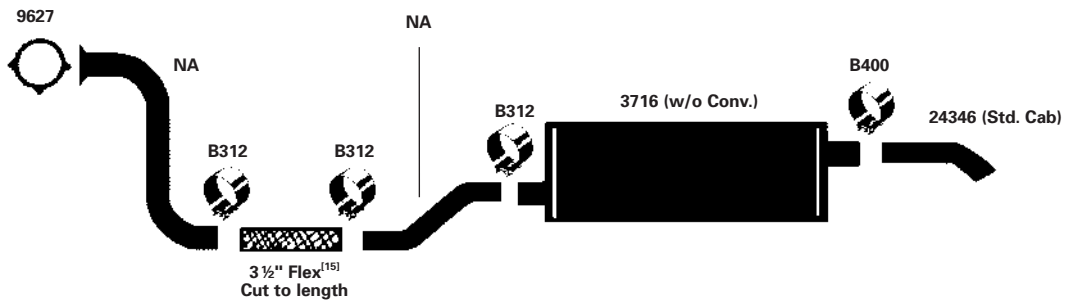

**94-99** 6 Cyl. 4000, DT408, DT466E, 530 Diesel Engine; L.H. Frame Mounted Muffler; With Short Tail Pipe

**(200258)**

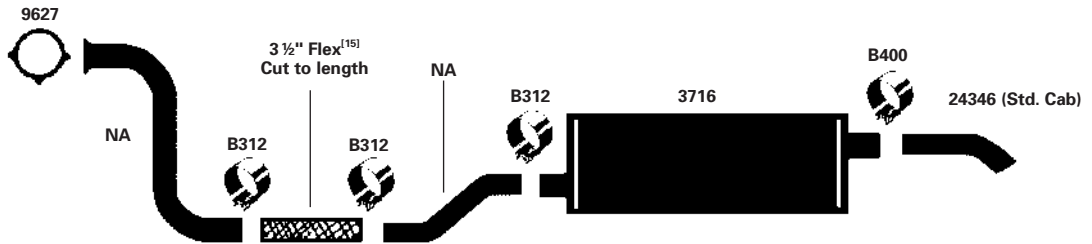

MEDIUM & H.D.  
APPLICATIONS

## 4000 SERIES CHASSIS - 1 1/2 TON & OVER

## NAVISTAR/INT'L

94-99 6 Cyl. 4000, DT408, DT466E, 530 Diesel Engine; R.H. Vertical Muffler & Tail Pipe;  
Code 07AWB

(200259)

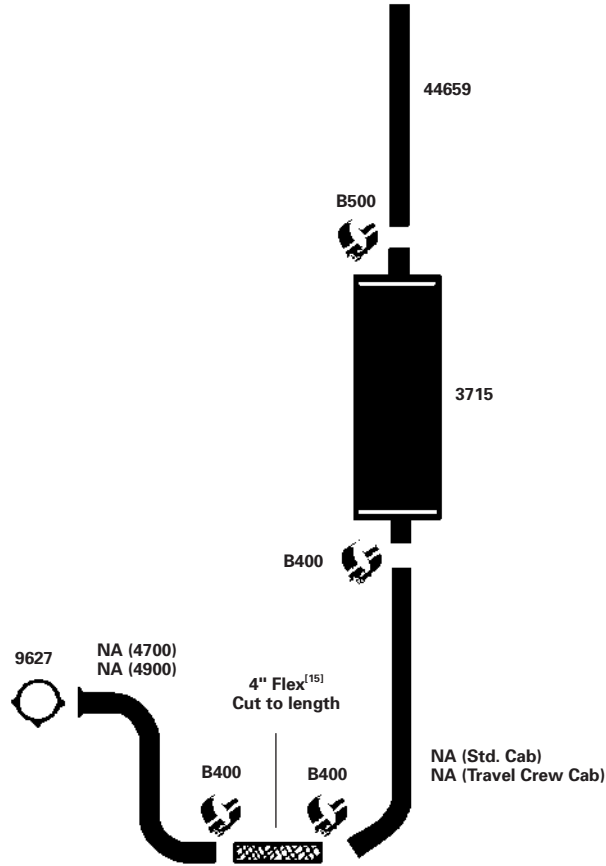

94-99 6 Cyl. 4000, DT408, DT466E, 530 Diesel Engine; R.H. Mounted Muffler;  
Short Tail Pipe; Codes 07BAG, 07AAY with Beverage Body

(200260)

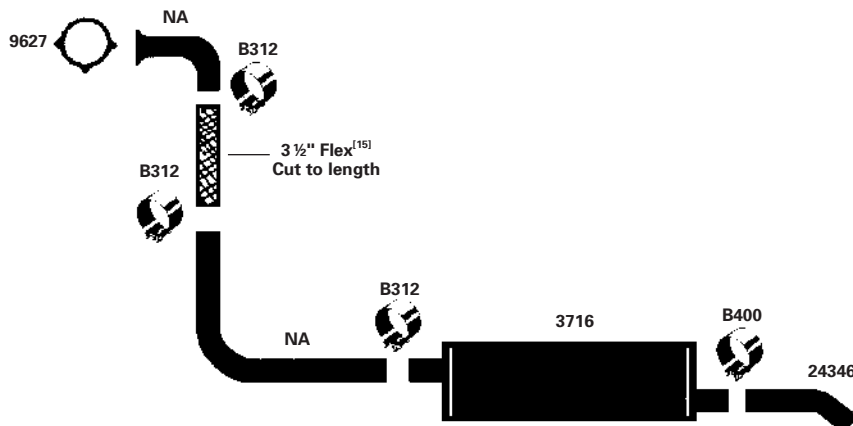

MEDIUM & H.D.  
APPLICATIONS

## 4000 SERIES CHASSIS - 1 1/2 TON & OVER

## NAVISTAR/INT'L

**94-99** 6 Cyl. 4000, DT408, DT466E, 530 Diesel Engine; R.H. Mounted Muffler; Short Tail Pipe; Code 07AAL with Beverage Body

**(200261)**

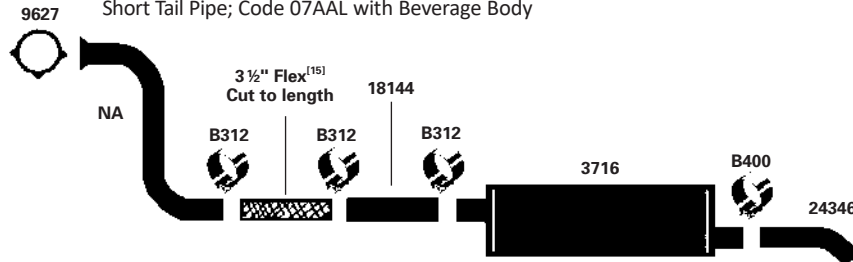

**94-99** 6 Cyl. 4000, DT408, DT466E, 530 Diesel Engine; R.H. Cab Mounted Vertical Tail Pipe; (Exc. Allison MT653DR & MT643 Auto. Trans.); Codes 07ACX, 07ACY

**(200262)**

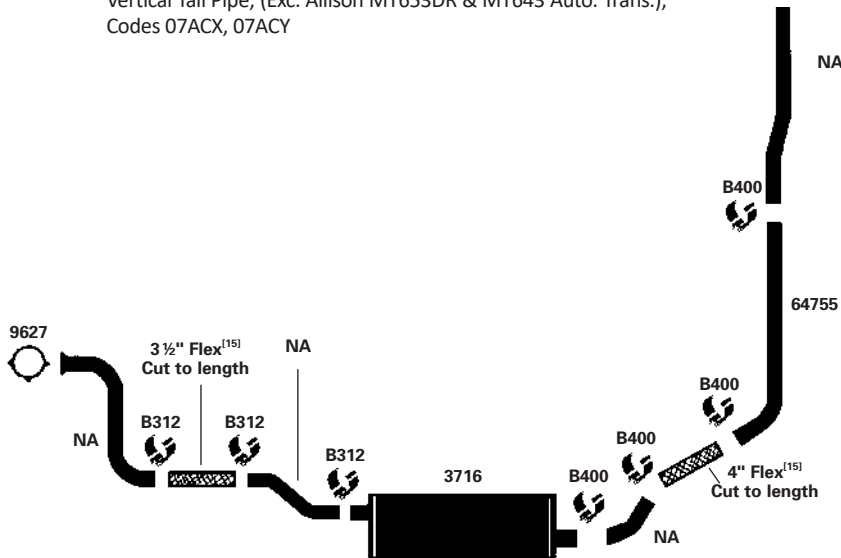

**94-99** 6 Cyl. 4000, DT408, DT466E, 530 Diesel Engine; Travelcrew Cab with L.H. Frame Mounted Muffler; Vertical Tail Pipe

**(200263)**

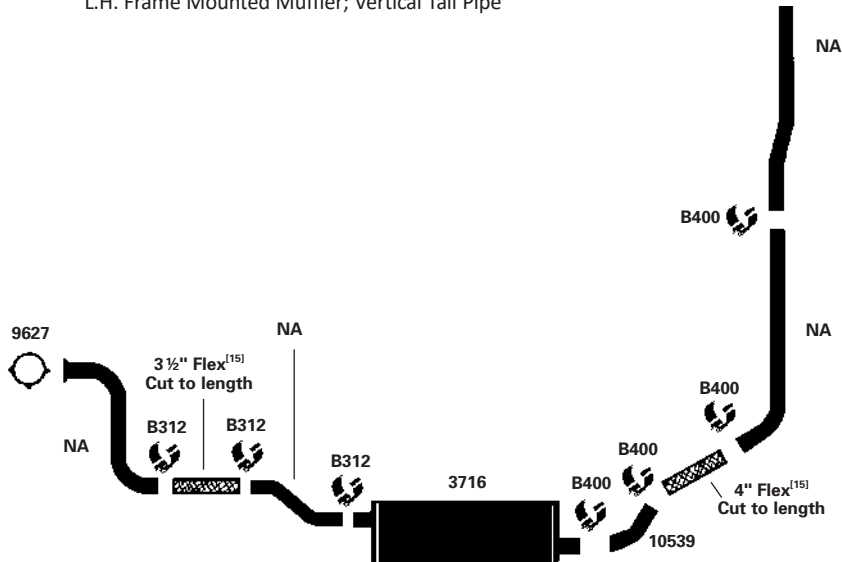

## 4000 SERIES CHASSIS - 1 1/2 TON & OVER

## NAVISTAR/INT'L

88-99 6 Cyl. 4000, DT408, 530, DT466 Diesel Engine; L.H. Mounted Muffler; Canada & Export Only; Code 07AAP

(200270)

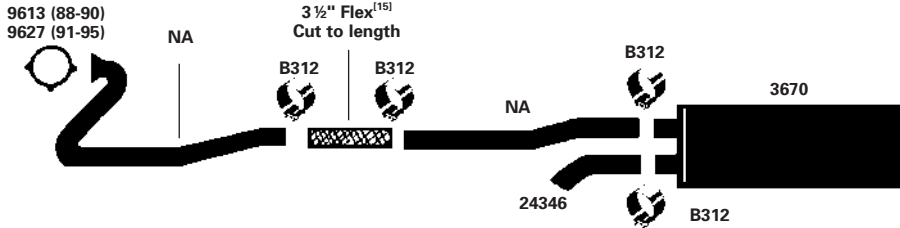

91-99 6 Cyl. 4700, 4900; DT360, DT408, DT/DTA466 Diesel Engine; R.H. Mounted Muffler; Long Tail Pipe; Code 07AAX

(200271)



\* Cut to length

93-99 6 Cyl. 4000, DT408/DT/DTA466 Diesel Engine; Temporarily Mounted R.H. Side Muffler; Code 07AAH

(200272)

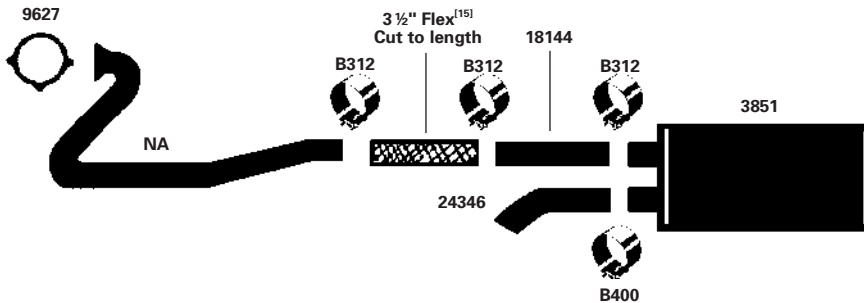

## 4000 SERIES CHASSIS - 1 1/2 TON & OVER

## NAVISTAR/INT'L

1993 8 Cyl. 4000, 7.3L Diesel Engine; R.H. Cab Mounted Vertical Tail Pipe (200274)

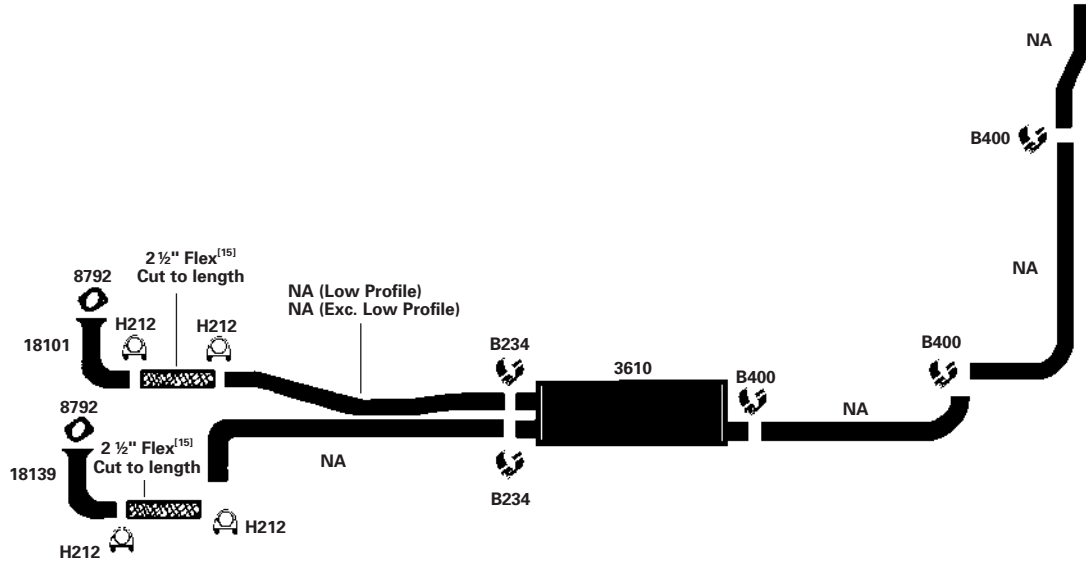

1993 6 Cyl. 4700 w/ DT 360 Diesel Engine; R.H. Side Mounting (Exc. Beverage Body) (200276)  
 90-92 6 Cyl. 4700 w/ DT/DTA 360 Diesel Engine; R.H. Side Mounting (Exc. Beverage Body)

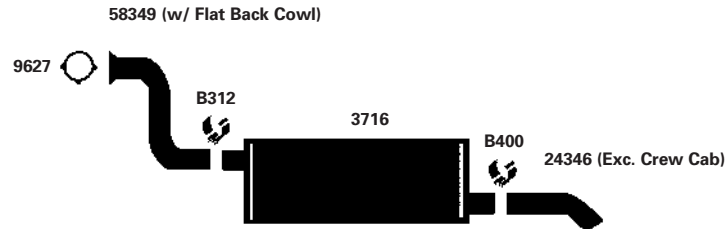

91-93 8 Cyl. 4000, 7.3L Diesel Engine; Long Tail Pipe; R.H. Mounting (Exc. Low profile) (200277)  
 Code 07AAX

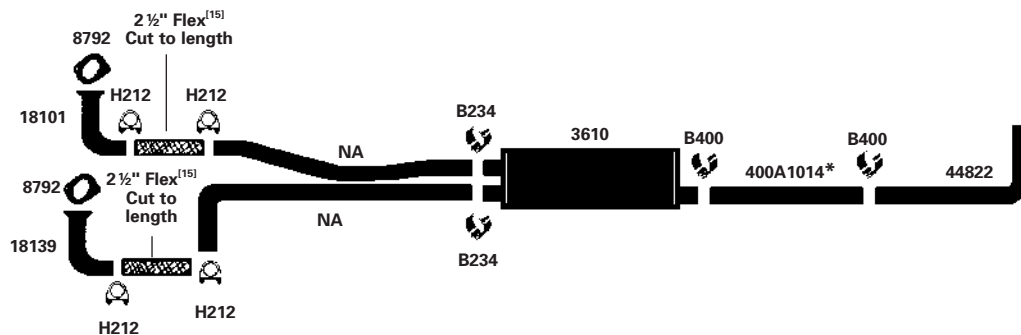

\* Cut to length

See page 230 for footnote explanations

MEDIUM & H.D. APPLICATIONS

## 4000 SERIES CHASSIS - 1 1/2 TON & OVER

## NAVISTAR/INT'L

91-93 8 Cyl. 4600LP, 4600UH, 7.3L Diesel Engine; Long Tail Pipe; R.H. Mounting;  
Low Profile

(200278)

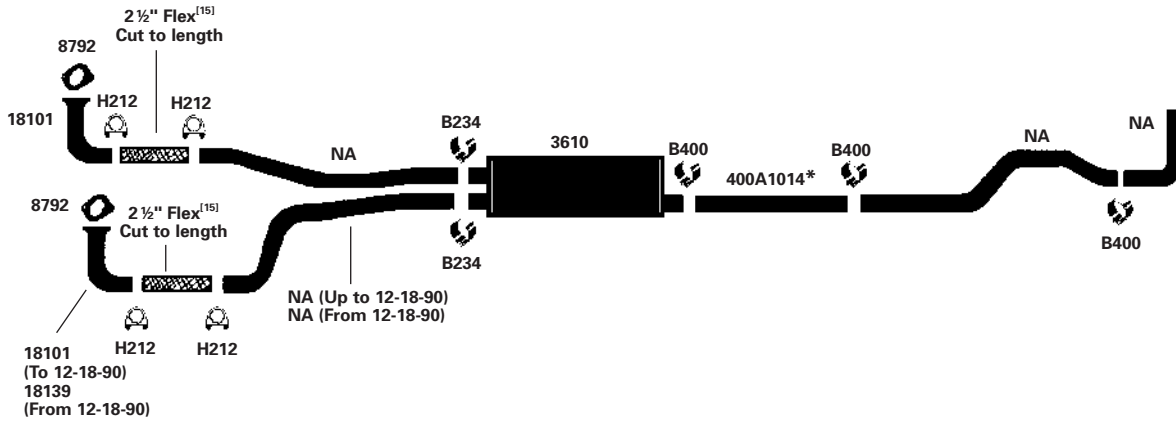

\* Cut to length

91-93 6 Cyl. 4000, DT/DTA360 Diesel Engine; Travelcrew Cab; R.H. Cab Mounted  
Tail Pipe; Code 07ACY

(200351)

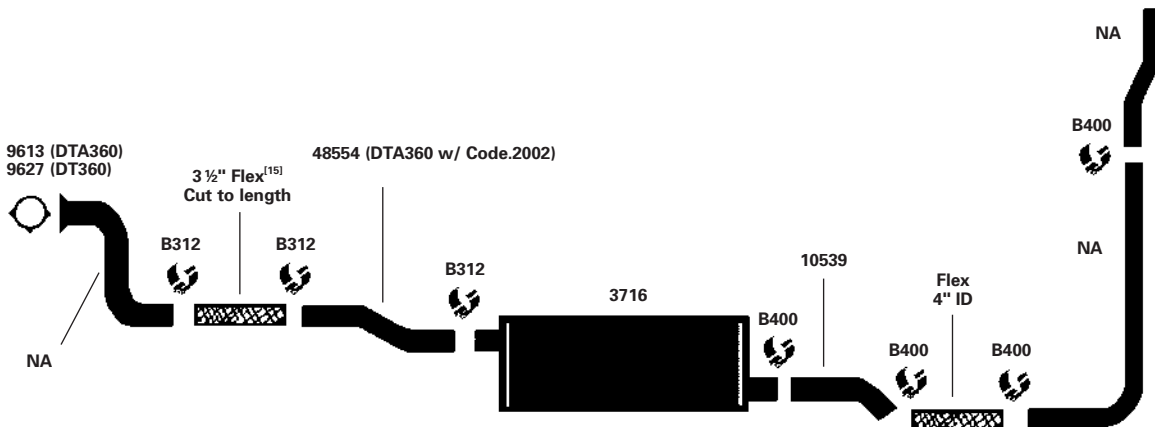

MEDIUM & H.D.  
APPLICATIONS

## 4000 SERIES CHASSIS - 1 1/2 TON & OVER

## NAVISTAR/INT'L

1993 6 Cyl. 4000, DTA360 Diesel Engine; R.H. Frame Mount (Exc. Beverage Body)

(200279)

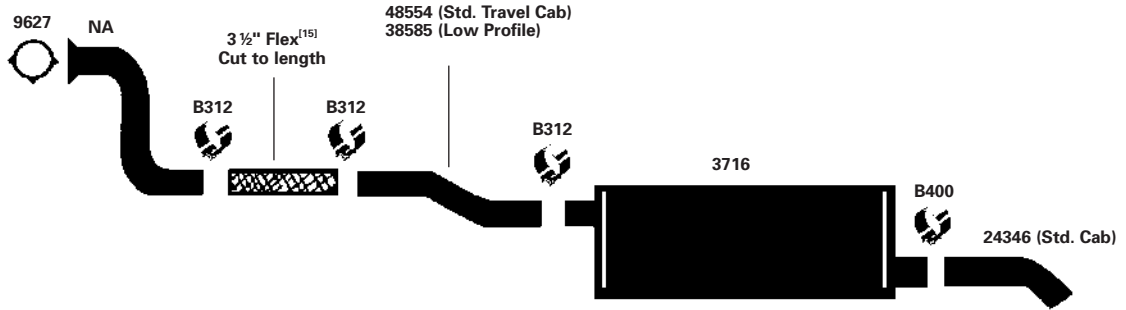

91-93 6 Cyl. 4000, DT/DTA466 Diesel Engine; Std. Cab; L.H. Cab Mounted Vertical Tail Pipe

(200282)

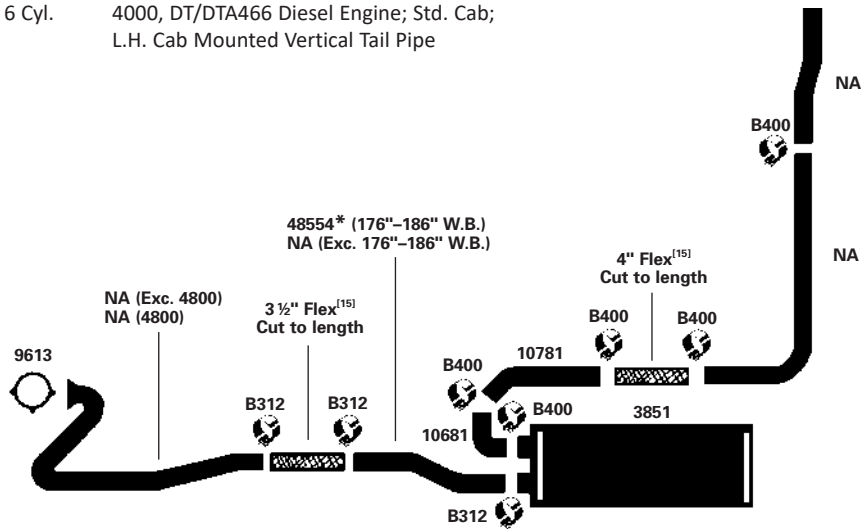

\* Cut to length

91-93 8 Cyl. 4900, DT/DTA466 Diesel Engine; R.H. Cab Mount Tail Pipe; Codes 07ACY.2003, 2019, 2022, 2030, 2052, 2054

(200283)

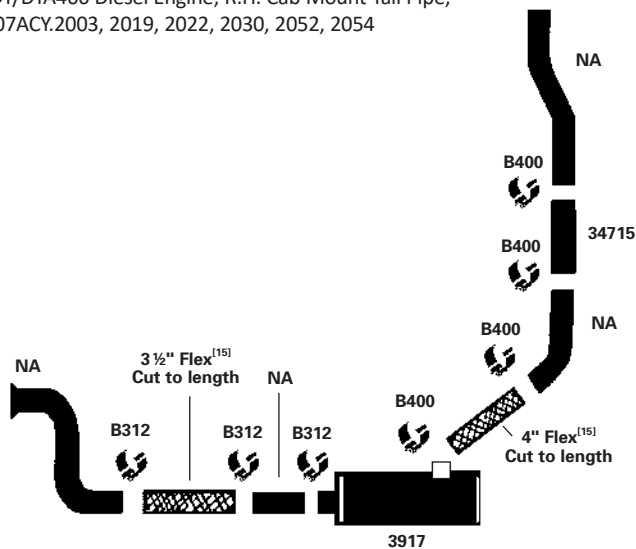



## 4000 SERIES CHASSIS - 1 1/2 TON & OVER

## NAVISTAR/INT'L

91-93 6 Cyl. 4000, DT/DTA466 Diesel Engine; Travelcrew Cab; L.H. Cab Mount Tail Pipe

(200284)

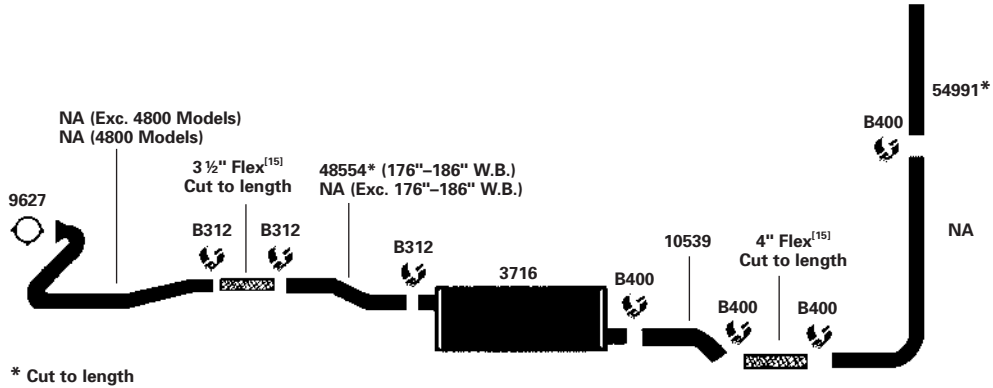

88-93 8 Cyl. 4600; 7.3L Diesel Engine; L.H. Side Mounting

(200285)

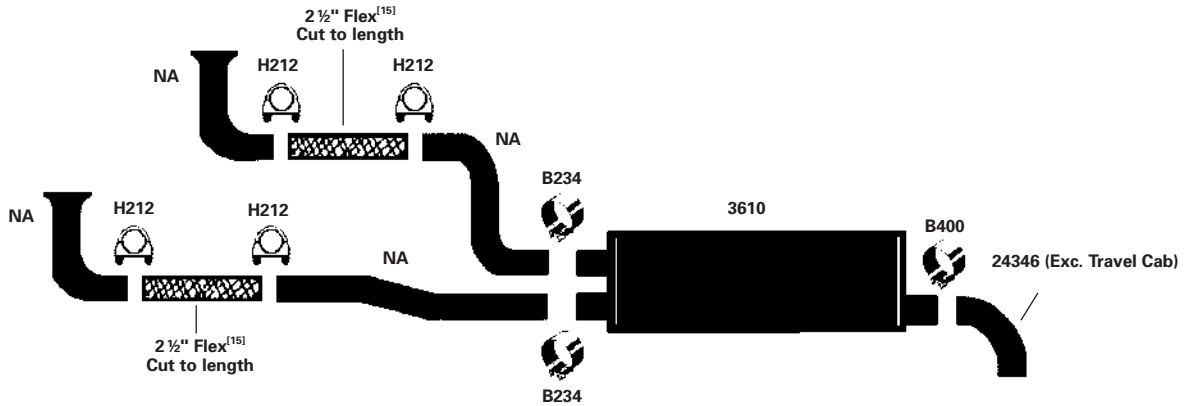

88-93 6 Cyl. 4000, DT/DTA360 Diesel Engine; L.H. Frame Mount;  
Codes 07AAZ.2003, .2003, .2010, .2011, .2012

(200286)

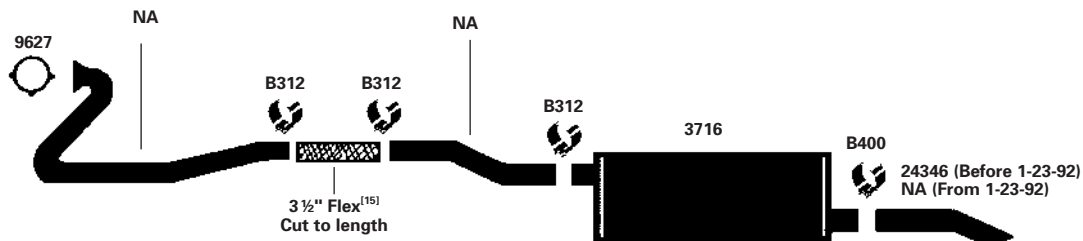

## 4000 SERIES CHASSIS - 1 1/2 TON & OVER

## NAVISTAR/INT'L

**88-93** 6 Cyl. 4700, 4900, DT/DTA360, DT/DTA466 Diesel Engine; R.H. Cab Mount Tail Pipe; Codes 07ACR, 07ACY.2001, 2016, 2053, (1991 and later)

**(200287)**

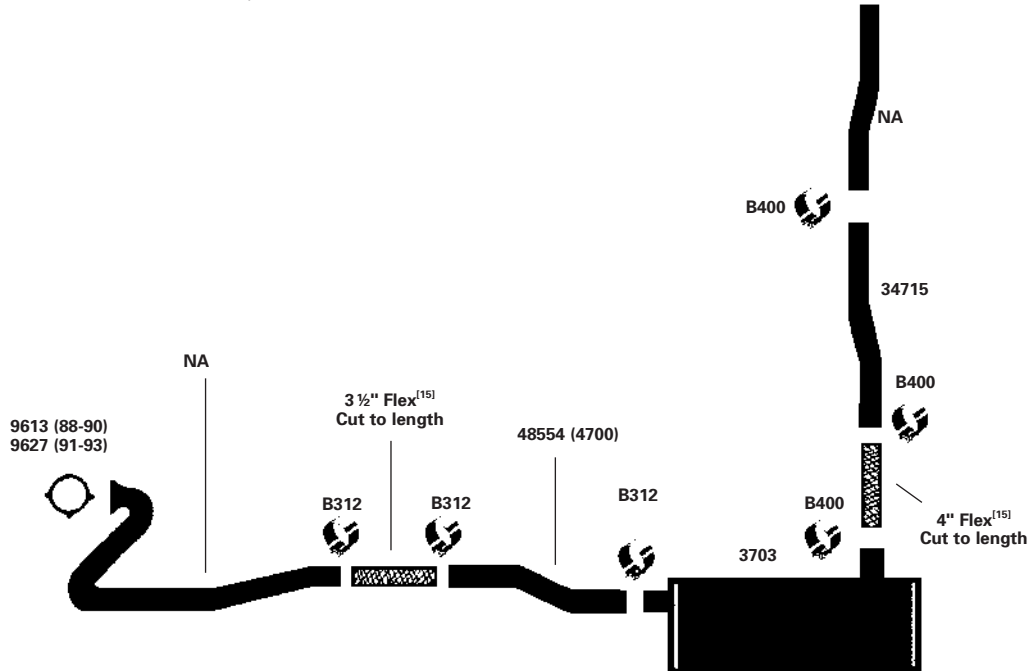

**88-93** 6 Cyl. 4700, 4900, DT/DTA360, DT/DTA466 Diesel Engine; R.H. Cab Mount Tail Pipe; Codes 07ACS, 07ACT, 07ACX, 07ACY.2014, 2025, 2026, 2038, 2041, 2048, 2050, 2051, 2056, 2057

**(200296)**

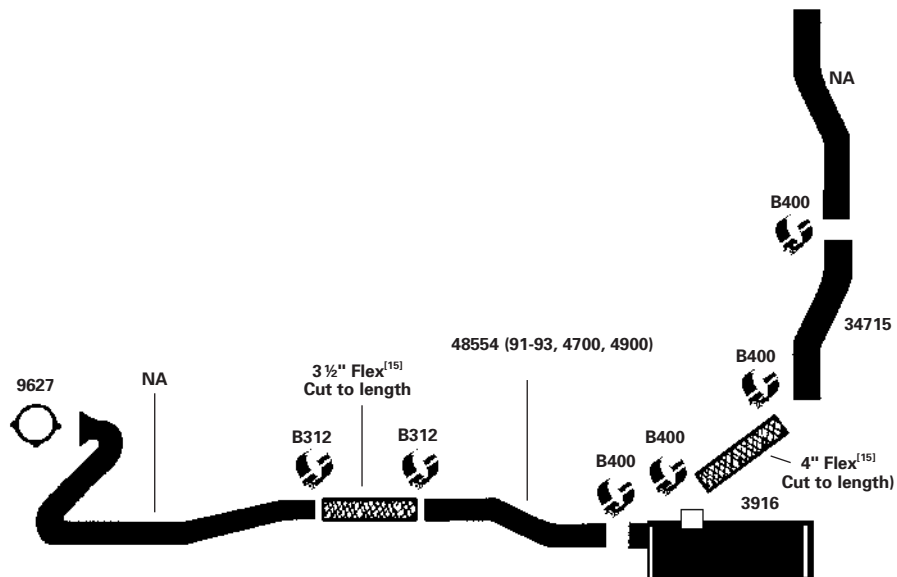

MEDIUM & H.D. APPLICATIONS

## 4000 SERIES CHASSIS - 1 1/2 TON & OVER

## NAVISTAR/INT'L

88-93 6 Cyl. 4000 Series; DT/DTA 466 Diesel Engine; L.H. Side Mount;  
Codes 07AAZ.2006, .2007

(200297)

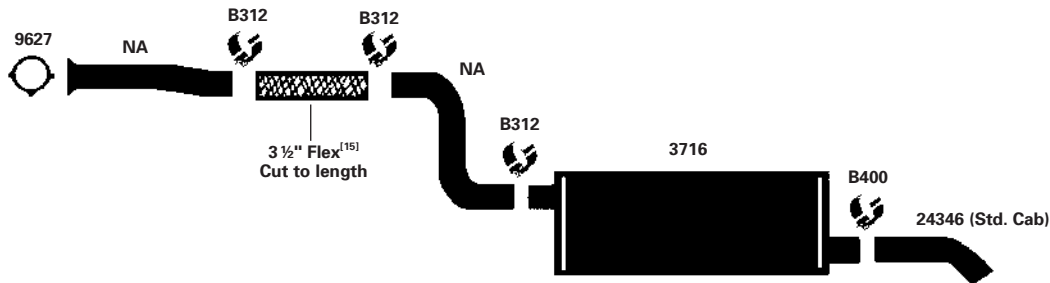

88-93 6 Cyl. 4000 Series; DT/DTA 466 Diesel Engine; L.H. Side Mount;  
Codes 07AAZ.2002, .2003, .2010, .2011, .2012

(200298)

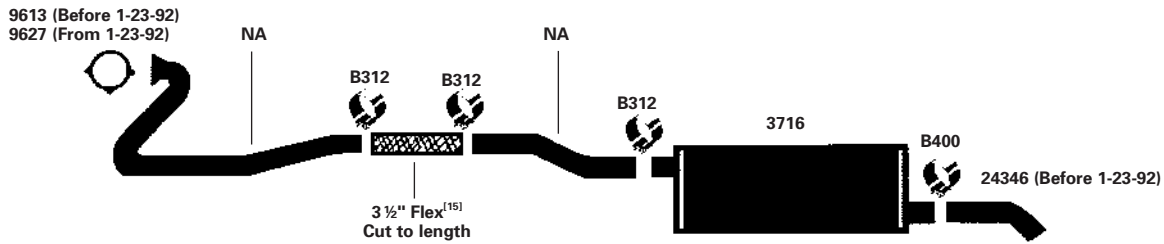

88-93 6 Cyl. 4000 Series; DT/DTA 466 Diesel Engine; (After 01-01-1988);  
L.H. Side Mount; Codes 07AAZ.2001, .2008, .2009

(200299)

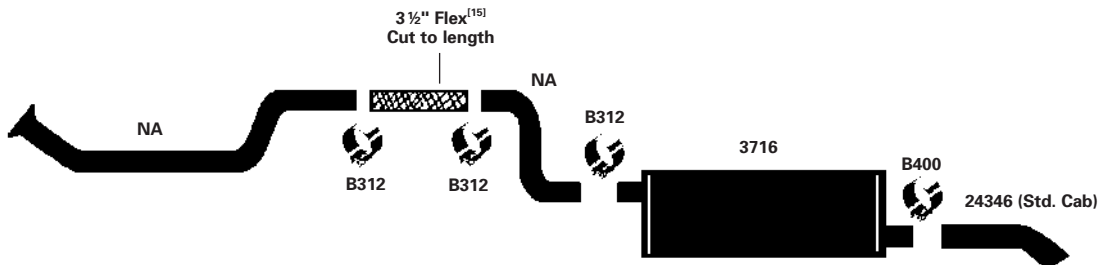

## 7000 SERIES CHASSIS - 1 1/2 TON & OVER

## NAVISTAR/INT'L

88-93    6 Cyl.    4700, 4900; DT360, DT/DTA466 Diesel Engine; R.H. Frame Mount  
Vertical Muffler; Codes 07AWB, 07AWC.07554

(200300)

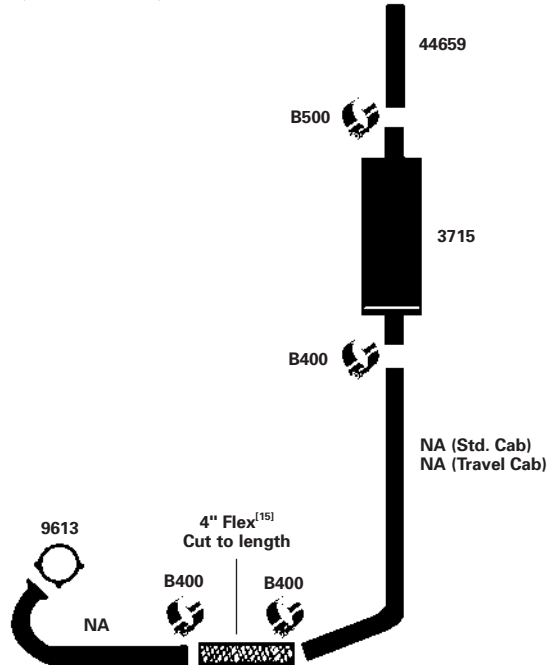

## 7000 SERIES CHASSIS - 1 1/2 TON & OVER

## INT'L/NAVISTAR

89-92    6 Cyl.    7100, DT/DTA466 Diesel Engine; R.H. Mount; Code 07AAY

(200301)

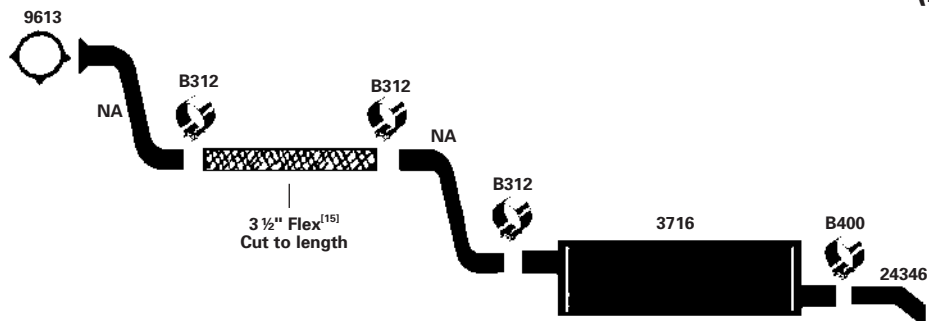

MEDIUM & H.D.  
APPLICATIONS

## NAVISTAR/INTERNATIONAL HARVESTER

YEAR	CYL.	TONS	MAKE & MODEL	EXH. PIPE	MUFFLER	TAIL PIPE
<b>IH-4000 Series</b>			<b>1.5 TON &amp; OVER</b>			
94-99	6		4700, 4900, DT408, DT466 NGD, 530 Diesel Engine; R.H. Muffler & Vertical Tail Pipe; Codes 07ABG, 07BGB		3851	NA
94-99	6		4000, DT408, DT466 NGD, 530 Diesel Engine; RH Cab Mounted, Vertical Tail Pipe; Codes 07ACS, 07ACT w/o conv.		3916	NA
94-99	6		4000, DT408, DT466E, 530 Diesel Engine; RH Mounted Muffler Vertical Tail Pipe; Codes 07ACX, 07ACY; Beverage & Utility Body		3917	NA
94-99	6		4000, DT408, DT466E, 530 Diesel Engine; RH Frame Mounted Muffler; Cab Mounted Vertical Tail Pipe; Code 07BAG (Exc. Beverage Body) w/o conv.		3716	NA
94-99	6		4000, DT408, DT466E, 530 Diesel Engine; R.H. Muffler Mounted 8" Back of Cab; Codes 07AMA, 07AAE w/ Short Tail Pipe		3716	NA
94-99	6		4000, DT408, DT466E, 530 Diesel Engine; R.H. Muffler Mounted 30" Back of Cab; Codes 07AMB, 07AAK w/ Short Tail Pipe		3716	NA
94-99	8		4000, T444E Diesel Engine; R.H. Muffler & Vertical Tail Pipe; Code 07BAC w/o conv.		3851	NA
94-99	8		4000, T444E Diesel Engine; L.H. Frame Mounted Muffler; Vertical Tail Pipe; Codes 07ACU, 07ACW w/o conv.		3716	NA
94-99	8		4000 Travelcrew Cab, T444E Diesel Engine; R.H. Frame Mounted Muffler; Cab Mounted Vertical Tail Pipe; Code 07ACY w/o conv.		3716	NA
94-99	8		4000, T444E Diesel Engine; L.H. Mounted with Long Tail Pipe; Codes 07AAS, 07AAV, 07AAX w/o conv.		3716	NA
1993	6		4000, DT/DTA360; L.H. Frame Mounted; Long Tail Pipe; Side Exit; Code 07AAV		3716	NA
1993	6		4000, DT/DTA466 Diesel Engine; L.H. Cab Mounted Vertical Tail Pipe; Codes 07ACW, 2004 & 2006		3716	NA
91-93	6		4000, DT/DTA466 Diesel Engine; R.H. Muffler Mounted 30" Back of Cab; Code 07AAK		3716	NA
91-93	6		4000, DT/DTA466 Diesel Engine; R.H. Muffler Mounted 8" Back of Cab; Code 07AAE		3716	NA
88-93	6		4000; DT/DTA360 Diesel Engine; STD. Cab; L.H. Cab Mounted Vertical Pipe		3704	NA
<b>IH-Metro Series (Step Van)</b>			<b>1.5 TON &amp; OVER</b>			
65-72	6		M1600, M1700, MC1600, MC1700; Metro		2704	24344
65-72	8		M1600, M1700, MC1600, MC1700; Metro		2704	24344
59-64	6		AM160, AMC160		3654	14343
59-64	8		AM160, AMC160		3654	14343
57-59	6		A160, A160 - 4X4, AC160; (exc. Low Frame)		2704	
<b>IH-Fleetstar, Cargostar, Loadstar, Series "S"</b>			<b>1.5 TON &amp; OVER</b>			
86-88	6		Series "S"; DT/DTA466 Diesel Engine; (Before 01-01-1988); STD. Cab; R.H. Cab Mount Vertical Tail Pipe		3703	NA
83-88	8		Series "S"; 6.9L Diesel Engine; All W.B.; Flex Tubing		3610	24346
81-88	6-8		Series "S"; 2500, 2600 Models; 3406 CAT, 6V-92 & 8V71T Detroit Diesel, Turbo Diesel Engines		3933	
79-86	6		Series "S"; DT466 Diesel Engine; Vertical Tail Pipe		3703	
79-86	8		Series "S"; 3208 Turbo Diesel Engine; Vertical Tail Pipe		3703	

MEDIUM & H.D. APPLICATIONS

## NAVISTAR/INTERNATIONAL HARVESTER

IH-Fleetstar, Cargostar, Loadstar, Series "S" (Cont.)				1.5 TON & OVER		
YEAR	CYL.	TONS	MAKE & MODEL	EXH. PIPE	MUFFLER	TAIL PIPE
79-86	8		Series "S"; DT466, 466B Diesel Engine; 4x2, 6x4 (Exc. Aux. Trans. Code 13552)		3704	24346
79-83	8		Cargostar; V555 Diesel Engine; Vertical Tail Pipe		3670	
72-83	6		Cargostar; RD406, RD450, RD502 Engine		3663	24344
71-83	8		Cargostar; MV404 C.I.D.; Gas Engine		2704	24344
1981	8		Series "S"; D150, 170, 190 Diesel Engine; 4x2, 4x4, 6x4, 6x6 Models for Aux. Trans.; Code 13552		3610	24346
73-80	8		CO1610, CO1710, CO1810 C Cab over Cargostar Models; Tilt with 266, V304, V345, V392 C.I.D.; Gas Engine		609	14342
77-78	8		Fleetstar 2050 Vertical Tail pipe; 3208 Diesel Engine		3705	
77-78	8		Fleetstar 2050, 2070; 3208 Diesel Engine; Horizontal Tailpipe		3632	24346
75-78	8		Loadstar; MV404, 466 C.I.D., Single		2704	24344
75-78	8		Loadstar; MV404, 466 C.I.D., Dual		3908	14343
73-78	8		1600, 1700, 1800, F1800, 1890 Loadstar; V345, V392 Gas Engine (Exc. 4 W.D. & Tilt)		2704	24344
73-78	8		1600, 1700 Loadstar; 4 W.D.		2704	14342
73-78	8		CO190, COF190, CO200, CO220, VCO190, VCO200, VCO220, VCOF190, COF1910A, CO1910A; Dual Inlet & Single Outlet; 401, 478, 549 C.I.D. Gas Engine		3663	24344
73-78	8		2110A, 1910A, 2010A, F2010A, CO190, CO200, COF190, CO220, CO1910A, COF1910A; 401, 478, 549 C.I.D. Gas Engine		609	14342
73-78	8		1600, 1700, F1700, F1800; Loadstar; V304 Gas Engine (Exc. 4 W.D. Tilt)		609	14342
71-78	8		Cargostar/Loadstar; 304, 345 C.I.D.		3906	14342
75-76	8		Fleetstar 2050; Vertical Tail Pipe; 3208 Diesel Engine (Caterpillar Engine); (After 02-24-75)		3705	
75-76	8		Fleetstar 2050, 2070; Horizontal Tail Pipe; 3208 Diesel Engine; (After 02-24-75)		3632	24346
72-76	8		Loadstar; VS401, 478 C.I.D.		3614	24346
72-76	6		Loadstar; RD406, RD450 C.I.D.		3663	24344
1975	8		Fleetstar 2050; Vertical Tail Pipe; 1160 Diesel Engine; (Before 02-24-75)		3705	
1975	8		Fleetstar Cab 2050, 2070; Horizontal Tail Pipe; 1160 Diesel Engine; (Before 02-24-75)		3632	24346
73-75	6		CO190, COF190, CO200, 210, F210, CO220, F230, M-412-10, M-623-10, 1910A, F1910A, 2010A, F2010A, 2070A, F2070A, 2110A, M-6123-10; 406, 450, 501 C.I.D. Gas Engine		3663	24344
72-73	8		2050A, F2050A, COF1950, M412-50, M623-50, M6123-50; 549 C.I.D.; (DV-550) Diesel Engine		3614	24346
70-73	8		M623-10, M6123-10, 210, F210, F230, M412-10; 401, 478, 549 C.I.D.; Gas Engine		3662	24344
71-72	8		CO190, COF190, CO200, 210, F210, CO220, VC190, VCO200, F230, M-412-10, M-623-10, VC220, VCOF190, 1910A, F1910A, 2010A, F2010A, 2070A, F2070A, 2110A, M-6123-10; 406, 450, 501 C.I.D. Gas Engine		3663	24344

## NAVISTAR/INTERNATIONAL HARVESTER

IH-Fleetstar, Cargostar, Loadstar, Series "S" (Cont.)			1.5 TON & OVER			
YEAR	CYL.	TONS	MAKE & MODEL	EXH. PIPE	MUFFLER	TAIL PIPE
71-72	8		2110A, 1910A, 2010A, F2010A, CO190, COF190, CO200, 210, F210, CO220, VCO190, VCOF190, VCO200, VCO220, CO1910A, M623-10, M6123-10, 210, F210, F230, M412-10, COF1910A; 401, 549, 478 C.I.D.; Gas Engine		609	14342
70-72	6		1700, F1700, 1800, F1800, 1890; Loadstar; BD282, BD308 Gas Engine		609	14342
70-72	8		1600, 1700, 1800, F1800, 1890; Loadstar; V345, V392 Gas Engine (Exc. 4 WD & Tilt)		2704	24344
70-72	8		1600, 1700 Loadstar; 4 WD		2704	24344
70-72	8		CO1610, CO1710, CO1810; Cab over Cargostar Models; Tilt; V266, V304, V345, V392 Gas Engine		609	14342
1970	6		M412, M623, M6123, M8234; 406, 450 C.I.D. Gas Engine		3662	24344
1970	8		Cargostar; 550B Diesel Engine; Vertical Tail Pipe		3670	
68-69	6		R185, R190, RF190, CO190, COT195, R200, RF200, CO200, R210, RF210, R220, RF220, CO220		3662	24344
68-69	8		2010A, F2010A, 2110A; w/104, 478, 549 CID		609(2)	14342(2)
66-69	8		1900, 2000, COF4000, COT4000, F1900, M623 CBE, T1900; w/401, 478, 549 CID		3663	24344
66-69	6		1900, 2000, F1900, T1900, 2010A, F2010A, 2110A, M263 CBE; w/406, 450 or 501 CID		3663	24344
66-69	8		V-190, VF-190, V-200, VF210, V-220, VF-230, VT-195, VCO-190, VCOF-190, VCOT-195, VCO-200, VCO-220, CO8190; w/401, 478 or 549 CID		3662	24344
63-69	6		1600, 1700, CO1600 Loadstar w/BD264, BG265 Gas Eng.		3906	14342
63-69	6		1700, F1700, 1800, F1800, 1890 Loadstar w/BD282, BD308 Gas Eng.		609	14342
63-69	8		1600, 1700, F1700, F1800 Loadstar w/V266, V304 Gas Eng. (exc. 4WD & Tilt)		609	14342
63-69	8		1700, 1800, F1800, 1890 Loadstar w/V345, V392 Gas Eng., (exc. 4WD & Tilt)		2704	24344
63-69	8		CO1600, CO1700, CO1800, Loadstar-Tilt w/V266, V304, V345, V392 Gas Eng.		2704	24344
63-69	8		1600, 1700 Loadstar w/V266, V304, V345 Gas Eng.-4WD		2704	24344
66-67	6		R185, R190, RF190, CO190, COT195, R200, RF200, CO200, R210, RF210, R220, RF230, CO220; After Chassis No. 32953		3662	24344
63-69	8		1600 Loadstar w/V266 Gas Eng. (exc. 4WD & Tilt)		609	14342
1965	6-8		CO-4000D, COF-4000D, COT-4000D		3897	24750
1965	8		CO-4000, COF-4000, COT-4000		3662(2)	24344(2)
62-65	6		1900, 2000, F1900, T1900		3663	24344
62-65	8		1900, 2000, F1900, T1900		3662	24344
61-65	8		210D, F-210-D, F-230-D, D-400, DF-400, DT-400, D-405, DF-405, DT-405, DC-400, DCF-400, DCT-400, DC-405, DCF-405, DCT-405		3891	24346

MEDIUM & H.D. APPLICATIONS

## NAVISTAR/INTERNATIONAL HARVESTER

IH-Fleetstar, Cargostar, Loadstar, Series "S" (Cont.)				1.5 TON & OVER		
YEAR	CYL.	TONS	MAKE & MODEL	EXH. PIPE	MUFFLER	TAIL PIPE
58-65	8		ACO-220, ACOF-190, ACOF-200, CO-190, CO-200, 210, F-210, F-230, CO-220, COF-190, COF-200, R-190 (4x4), R-210 (4x4), VF-190, VF-200, VF-210, VCOF-190, VCOF-200, VCO-190, VCO-200, VCO-220, VCO-400, VCO-405		3662	24344
56-65	6		R185, R190, RF190, CO190, COF190, RT195, R200, RF200, CO200, COF200, R210, RF210, R220, CO220; After Chassis No. 32953		3662	24344
56-65	6		DCO-190, RD-190, RDF-190, RDT-190, DCO-195-H, RD-195, RDF-195, RDT-195, DCO-200, RD-200, RDF-200, RDT-200, DCO-205-HRD-205, RDF-205, RDT-205, RD-210, RDF-210, RDT-210, DCO-220, RD-220, RDF-220, RDT-220, RD-400, RDT-405		3662	24344
55-65	6		DCO-405, DCOF-405, DCO-405		3891	24346
59-61	6		B140 (4x4), B150, B160, B160 (4x4), BC150, BC160, B170, B-180, BC-170, BC-180, BC-1890, BC-170 (4x4), BC-180 (4x4), BC-170, BCF-180, BCF-170 (6x6), BCF-180 (6x6)		609	14342
59-61	8		BC150, BC160 (4x4), BC160, B-170, BC-170, B-180, BC-180, BC-1890, BC-170 (4x4), BC-180 (4x4), BCF-170, BCF-180, BCF-170 (6x6) x/V266, V-304 Eng.		609	14342
57-59	6		AC160 w/Low Frame, A170, AC170, ACF170, AC170 (4x4), ACF170 (6x6), A180, AC180, ACF180, AC1890, AC180 (4x4), ACF180 (6x6)		609	14342
1956	6		R185, R190, RF190, CO190, COF190, R200, RF200, CO200, COF200, R210, RF210, R220, CO220; up to Serial 32953		3662	24344
53-55	6		R185, R190, RF190, RC190, R195, R200, RC200, R205, R210, RF210, R212, R220, R225, R230, CO190, CO200, CO220; All 3-1/2" Exh. Pipes w/RD372 Eng. After Ser. No. 24669, RD406 Eng. After Ser. No. 42781, RD450 Eng. After Ser. No. 36607		3662	24344
50-52	6		LM150, L160, L165, LC160		3654	
47-49	6		KB6, KBS6, KBS6T, KB6F, KBS6B, KB7, KBS7 Also COE Models		609	14342
41-46	6		K6, KS6, K7, KS7, K6T, KS6T, K6F, K6B, KS6B, K7 COE, KS7 COE w/FAC259A Eng. After Ser. No. 751; All BLD-269A Eng.		609	14342

MEDIUM & H.D. APPLICATIONS

## MERCEDES-BENZ

YEAR	CYL.	TONS	MAKE & MODEL	EXH. PIPE	MUFFLER	TAIL PIPE
1993	6		NPR; 6.5L Turbo Diesel Engine; 113", 177" W.B.		3726	
79-84	6		Models L1013, L1113; OM352NA Diesel Engine (Exc. Turbo)		2704	24344
78-84	6		Models L1116, L1316; OM352A Turbo Diesel Engine		2704	24344
78-84	5		Models L1418, LS1418; OM355/5 Diesel Engine		2704	24344



## SCHOOL BUS CONVERSION CHART

WHEEL BASE TO PASSENGER SEATING CAPACITY\*



### BLUEBIRD

WHEEL BASES	PASSENGER CAPACITIES
125"	19, 20, 21
149"	54
179", 186.5"	60
194", 201.5"	66
209", 216.5"	72
224", 231.5"	78
239", 246.5"	84
254"	

90

### FORD

WHEEL BASES	PASSENGER CAPACITIES
151", 156"	36
192", 198"	48
216", 222"	54
237", 242"	60
255", 260"	66
275", 280"	72

### CHEVROLET/GMC

WHEEL BASES	PASSENGER CAPACITIES
125"	17, 18, 19
149.5"	36
189", 189.5"	42, 48
218"	54
235", 235.5"	60
254"	66
274"	72

### INTERNATIONAL

WHEEL BASES	PASSENGER CAPACITIES
151", 152"	36, 39
168", 169", 170"	42, 45
187", 193"	48, 51
205", 217", 218"	54, 57, 63
236"	60
254"	66
275", 276"	72

\* Excluding State of Texas.

Referring to and measurement of wheel base is the most reliable method of specifying exhaust system requirements.

## BLUEBIRD SCHOOL BUS

05-07 6 Cyl. All-American Puller, CAT. 3126 & C7, w/o Pac Brake

(200500)

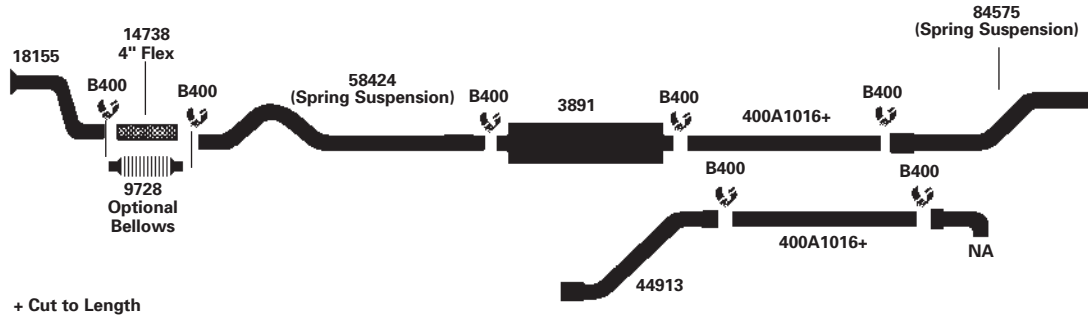

04-07 6 Cyl. All-American Pusher 3126 & C7 Caterpillar Pusher

(200501)

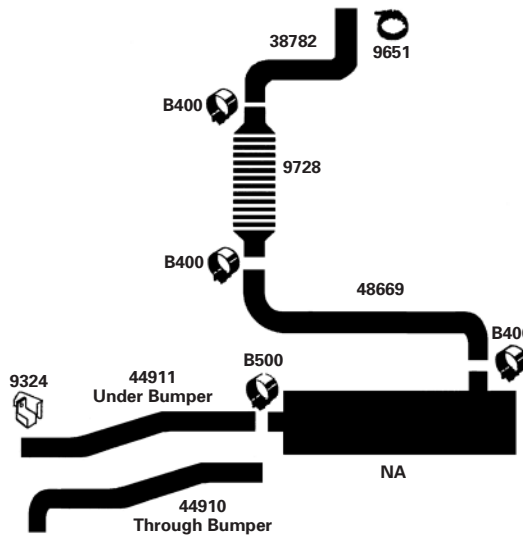

04-06 6 Cyl. Vision w/ 3126-C7 Caterpillar Engine

(200479)

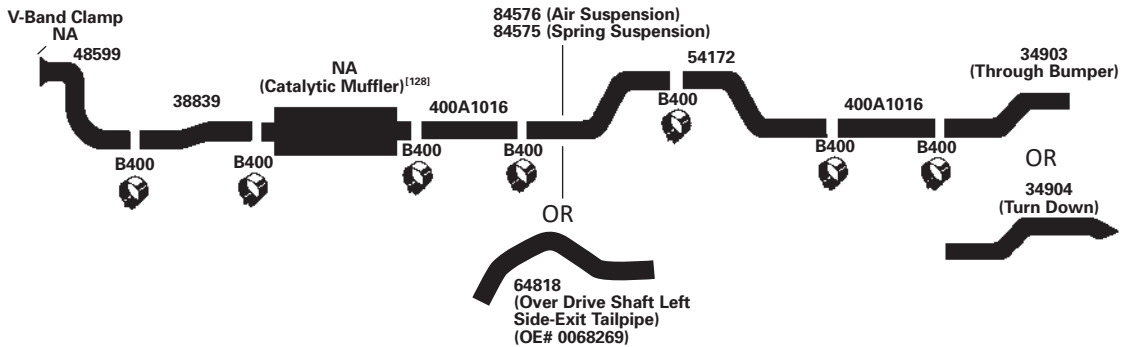

## BLUEBIRD SCHOOL BUS

00-02 6 Cyl. B-Series All-American Pusher w/ 5.9L ISB Rear Engine

(200482)

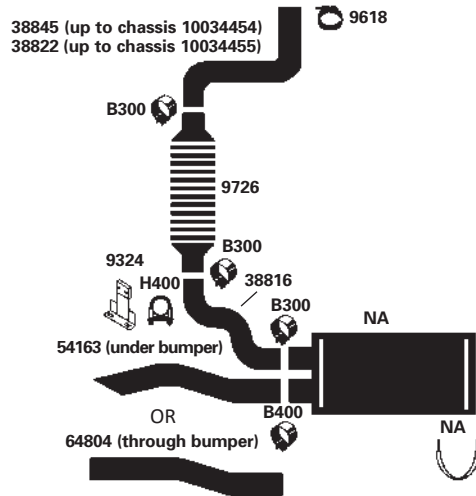

99-02 6 Cyl. TC2000 Pusher w/ 3126 Caterpillar Engine

(200480)

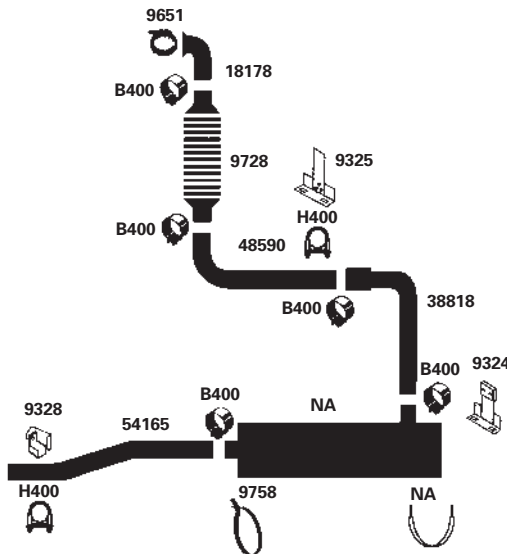

98-02 8 Cyl. CV200 GMC B7 Conventional Chassis w/ 454-502 Engine

(200485)

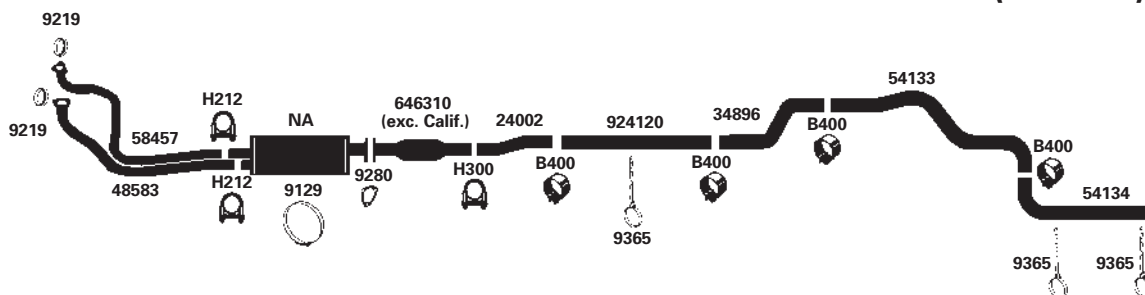

SCHOOL BUS APPLICATIONS

## BLUEBIRD SCHOOL BUS

99-01    6 Cyl.    All-American & 8.3 Cummins ISC w/ Left Hand 4" Tailpipe

**(200502)**

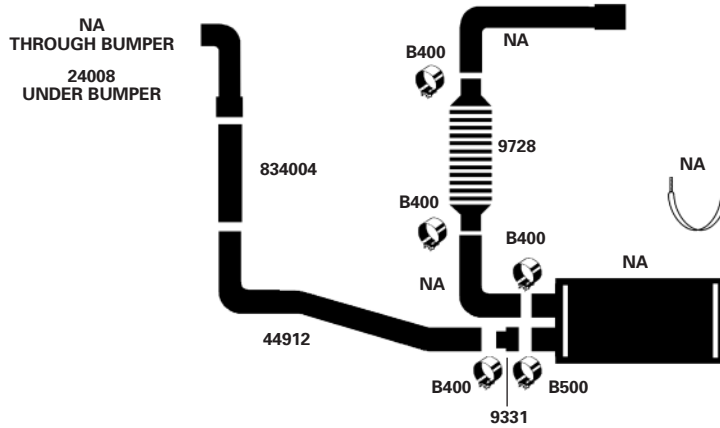

99-01    6 Cyl.    All-American 3126 Caterpillar Pusher

**(200346)**

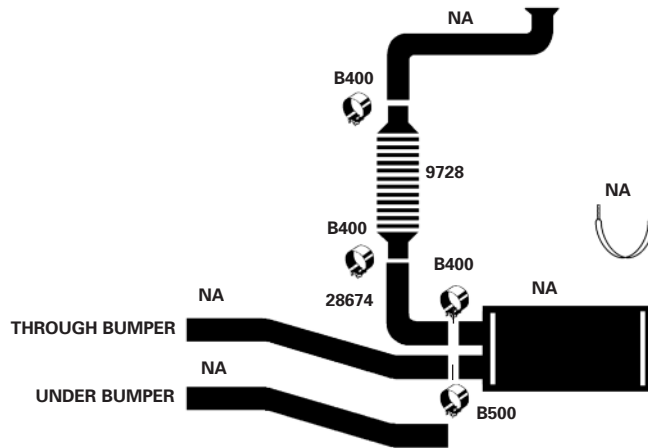

## BLUEBIRD SCHOOL BUS

99-00 6 Cyl. All-American B-Series w/ Cummins Engine; 4" System

(200481)

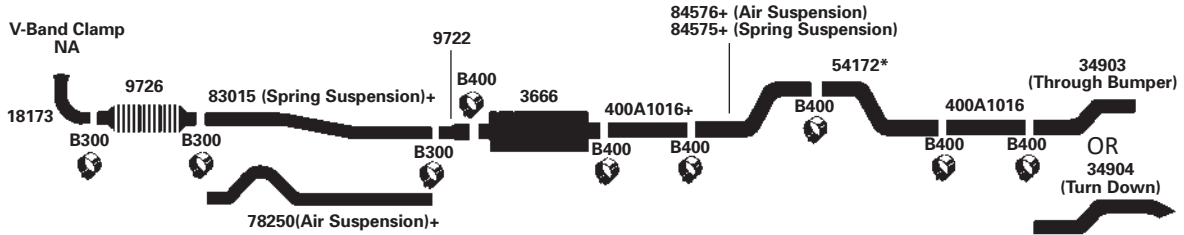

+ Cut to Length

98-01 6 Cyl. All-American Puller, Cat. 3126 & Cummins 8.3 ISC Engines

(200347)

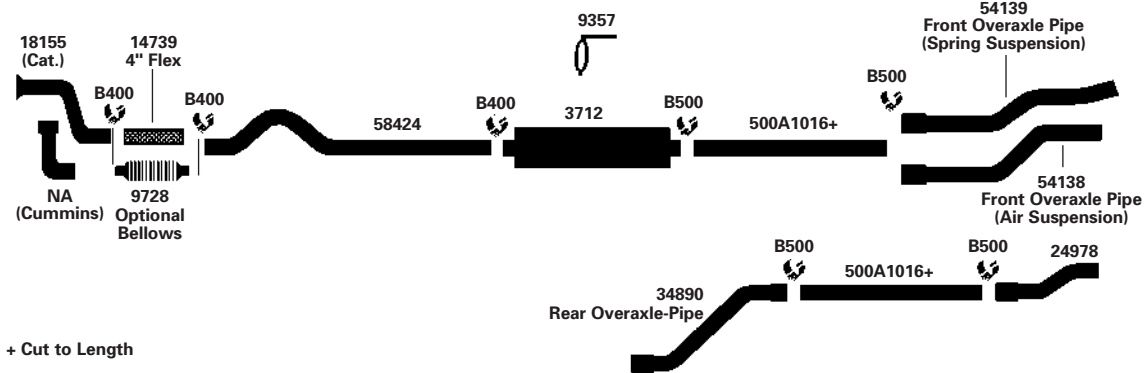

+ Cut to Length

98-01 6 Cyl. 3126 Cat Bluebird CV200; GMC B7 Conventional Chassis

(200348)

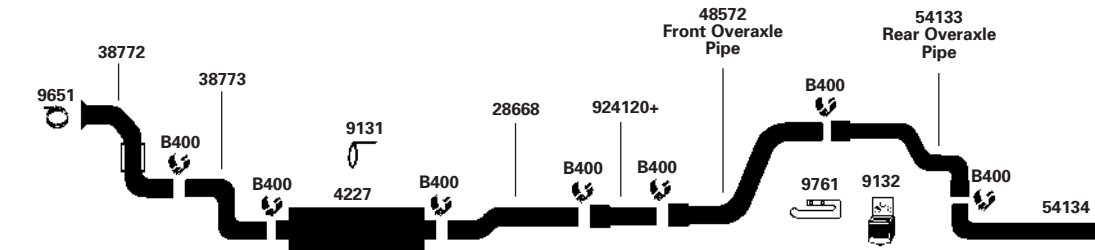

+ Cut to Length

SCHOOL BUS APPLICATIONS

## BLUEBIRD SCHOOL BUS

97-00 6 Cyl. TC1000, 5.9L B-Series Cummins Engine; 132" Wheel Base

(200349)

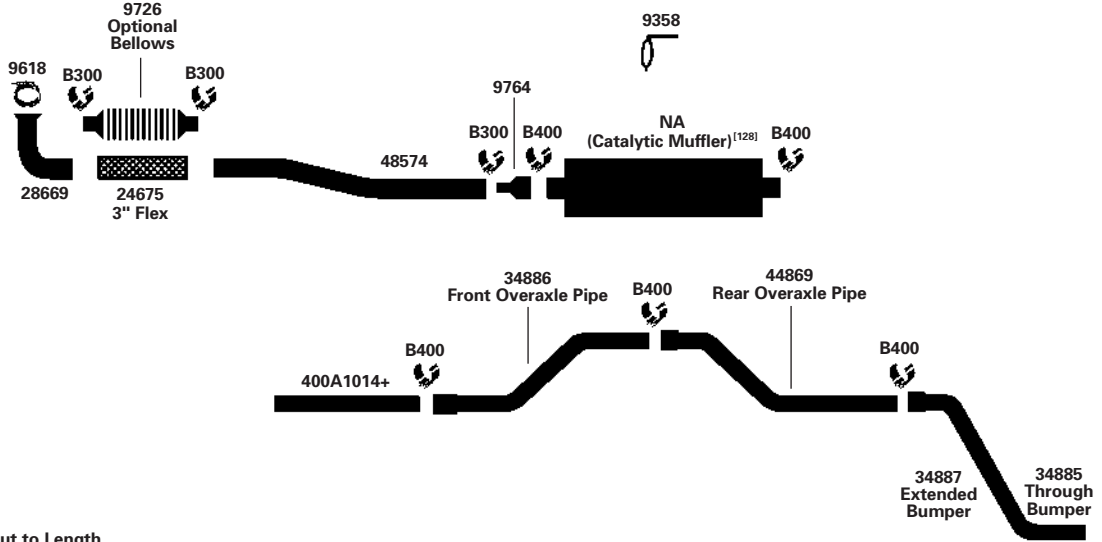

+ Cut to Length

95-98 6 Cyl. TC2000 w/ 6BTA; 5.9L Turbo Diesel; Rear Exit Tail Pipe; Side Mounted Fuel Tank; w/ Converter; 132", 146"-195", 216"-237" W.B.

(200353)

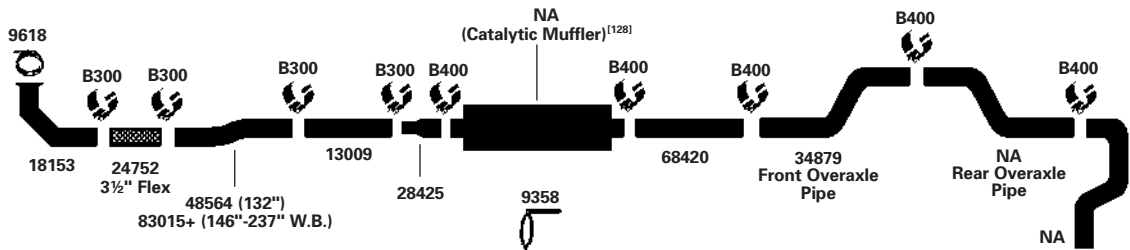

+ Cut to Length

94-98 6 Cyl. 3116 Cat Bluebird CV200; GMC B7 Conventional Chassis

(200350)

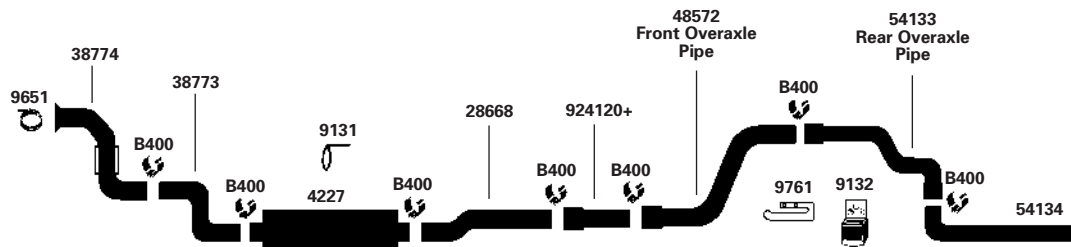

+ Cut to Length

## BLUEBIRD SCHOOL BUS

94-98 6 Cyl. All-American w/ 3116 Caterpillar Rear Engine

(200483)

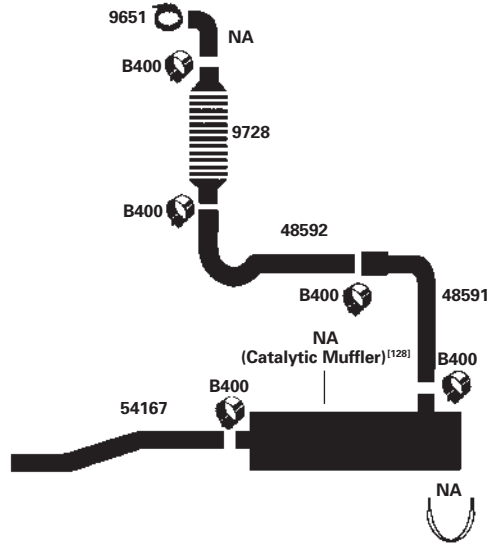

94-98 6 Cyl. TC2000, 5.9L B-Series Cummins Engine; w/ Air Ride Suspension; 174"-216" W.B., 237" W.B.

(200352)

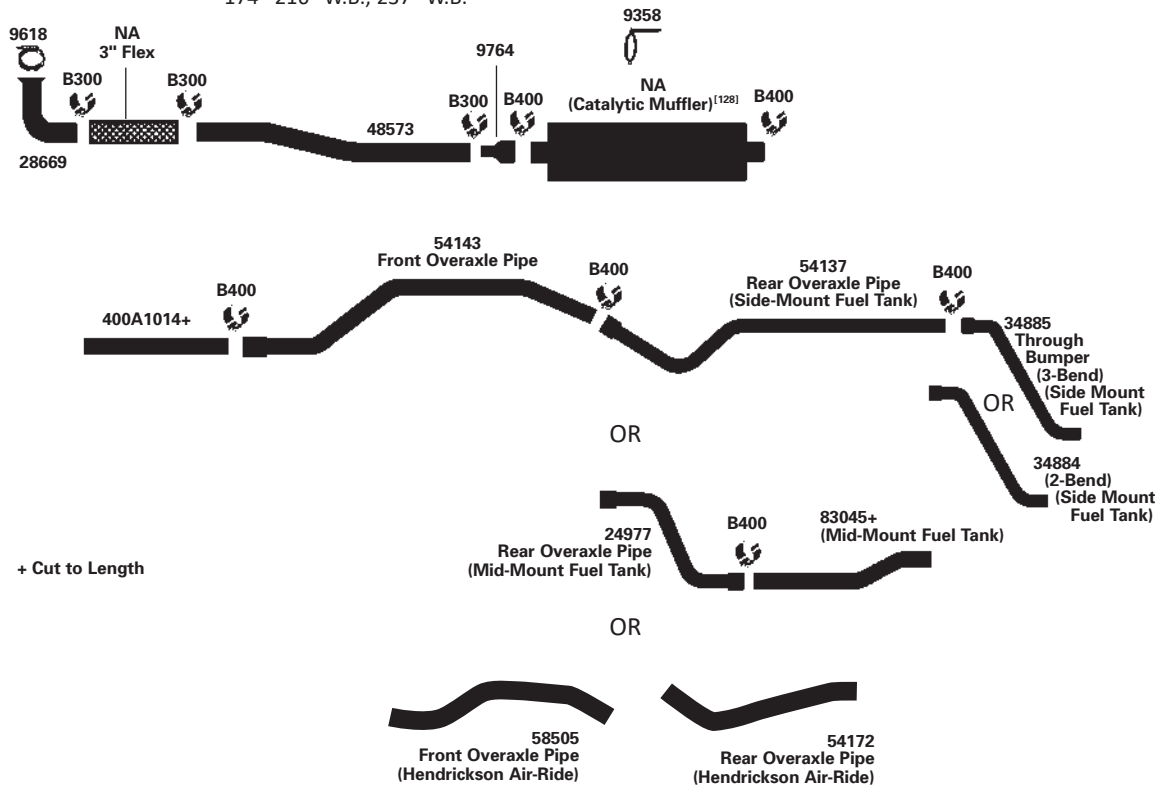

SCHOOL BUS APPLICATIONS

## BLUEBIRD SCHOOL BUS

**92-98**    6 Cyl.    All American w/ Cummins 8.3L Turbo Diesel;    **(200354)**  
 Spring Front Suspension; Mid Mounted Fuel Tank  
 (From Chassis No. 977611); 5" Tail Pipe Through Rear Bumper;  
 175"-190", 197½"-227½", 235"-242½" W.B.

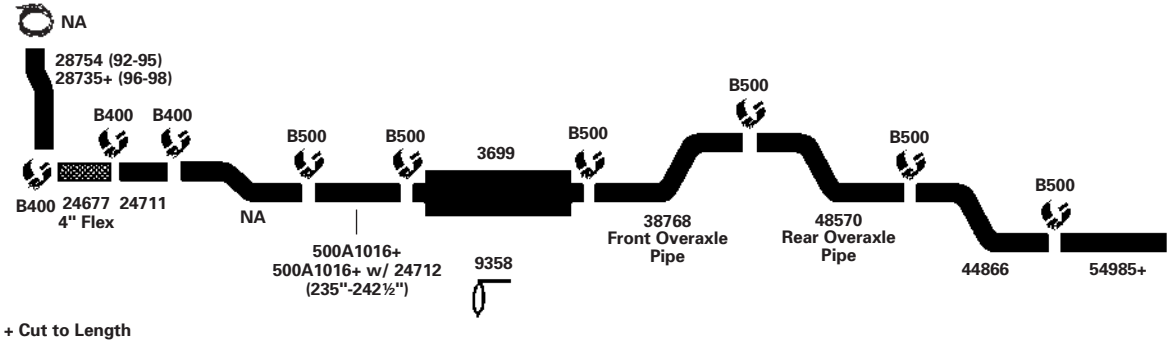

**92-98**    6 Cyl.    All American w/ Cummins 8.3L Turbo Diesel;    **(200355)**  
 Spring Front Suspension; Side Mounted Fuel Tank  
 (From Chassis No. 977611); 5" Tail Pipe; 175", 190", 197½"-227½", 235"-242½" W.B.

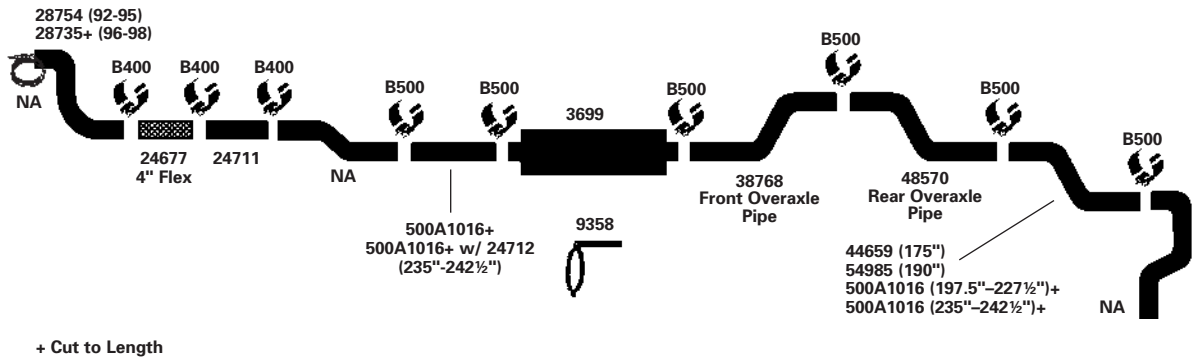

SCHOOL BUS APPLICATIONS



## BLUEBIRD SCHOOL BUS

**92-98**    6 Cyl.    All American w/ Caterpillar 3116 (6.6L) Diesel;    **(200356)**  
 Mid-Mounted Fuel Tank (From Chassis No. 977303);  
 5" Tail Pipe Through Rear Bumper; 175", 190"-227½", 235"-242½" W.B.

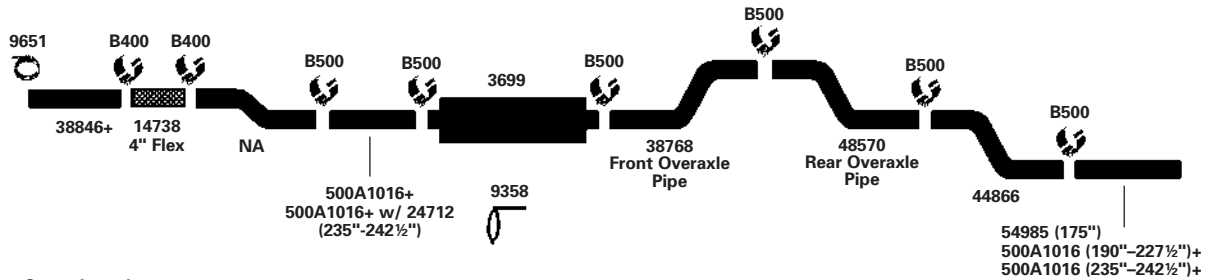

+ Cut to Length

**92-98**    6 Cyl.    All American w/ Caterpillar 3116 (6.6L) Diesel;    **(200496)**  
 Side-Mounted Fuel Tank (From Chassis No. 977303);  
 5" Tailpipe; 175", 190", 197½"-227½", 235"-242½" W.B.

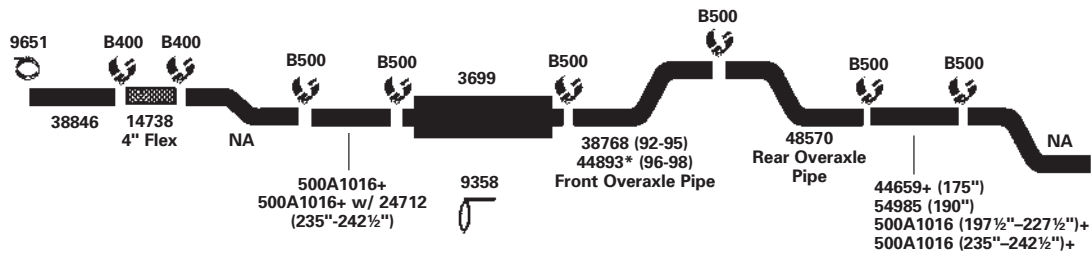

+ Cut to Length

**92-98**    6 Cyl.    All American w/ Caterpillar 3116 (6.6L) Diesel;    **(200373)**  
 Side Mounted Fuel Tank; 5" Tail Pipe (From Chassis No. 977303);  
 175", 190", 197½"-227½", 235"-242½" W.B.

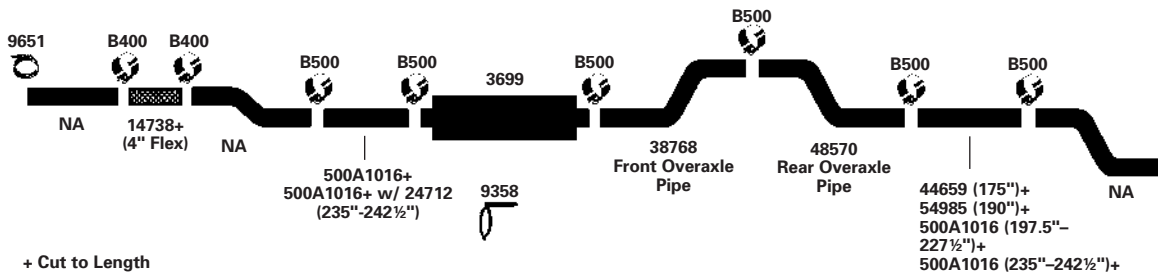

+ Cut to Length

## BLUEBIRD SCHOOL BUS

**88-97**    6 Cyl.    TC2000 w/ 6BTA; 5.9L Turbo Diesel; Rear Exit Tail Pipe; **(200367)**  
 Mid-Mounted Fuel Tank; w/ Codes 4452, 4453, 4513, 4514;  
 132", 146"-174", 195"-216", 237" W.B.

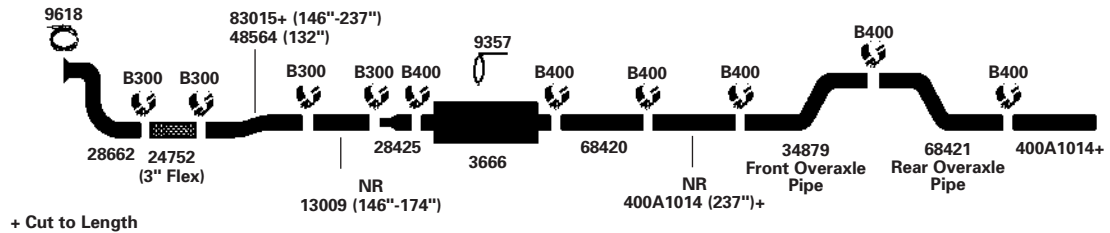

**92-95**    8 Cyl.    CV200 w/ 366, 427 C.I.D. gas Engine w/ Converter; **(200366)**  
 Tail Pipe Exits at the Rear of Bus; 145", 157"-193", 209"-261" W.B.

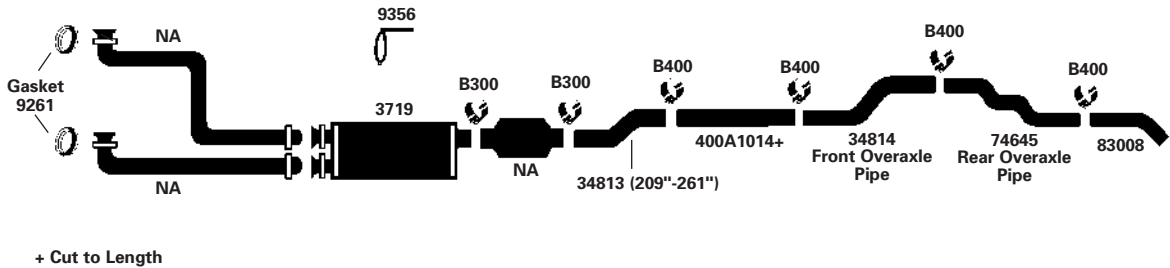

**92-95**    8 Cyl.    CV200; 366, 427 (6.0, 7.0) TBI Eng.; With Converter; **(200369)**  
 Tail Pipe Exits Side of Bus in Front of Rear Wheel; 145", 209", 261" W.B.

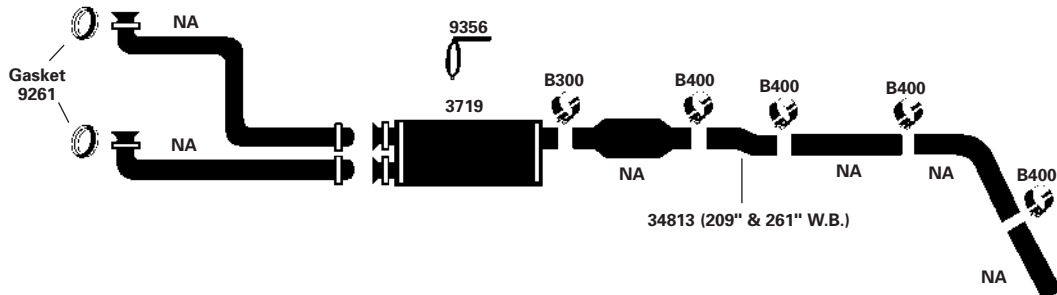

SCHOOL BUS APPLICATIONS

## BLUEBIRD SCHOOL BUS

**92-95** 8 Cyl. CV200; 366, 427 (6.0, 7.0) TBI Eng.; With Converter; **(200370)**  
 Tail Pipe Exits Side of Bus Behind Rear Wheel; 145", 209", 261" W.B.

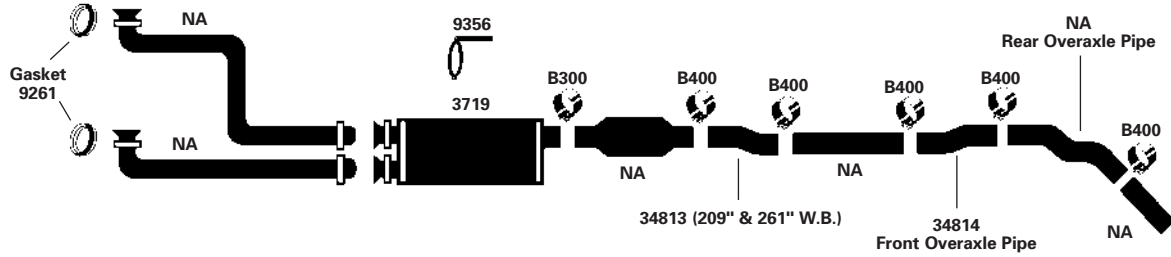

**92-95** 8 Cyl. CV200; 366, 427 (6.0, 7.0) TBI Eng.; With Converter; **(200371)**  
 Tail Pipe Exits at Rear of Bus; 145", 209", 261" W.B.

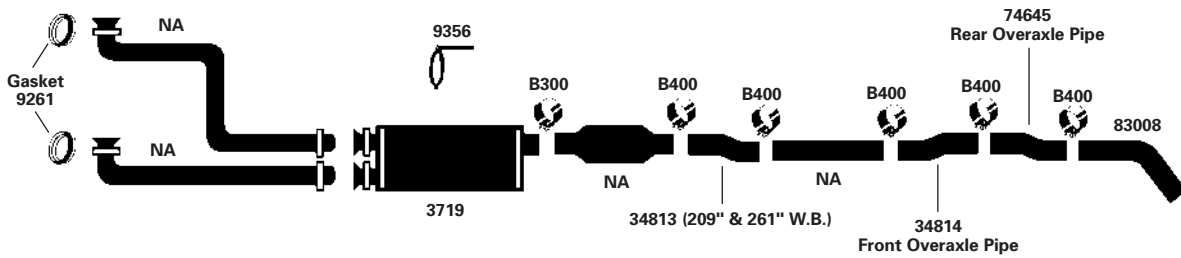

**87-95** 6 Cyl. Models with standard exhaust (Side Exit in Front of Rear Tire) TC2000; 5.9L Cummins Diesel Engine **(200363)**

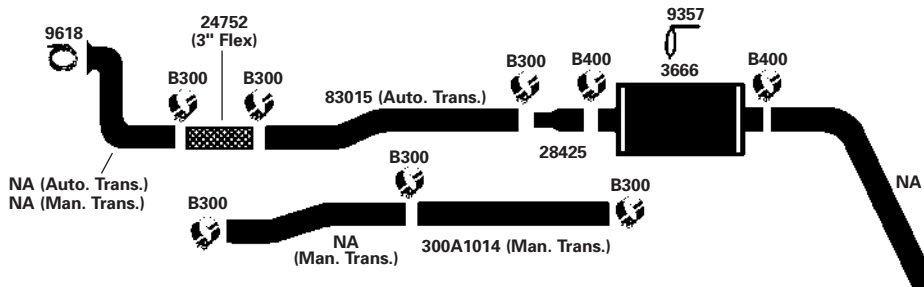

SCHOOL BUS APPLICATIONS

## BLUEBIRD SCHOOL BUS

**87-95**    6 Cyl.    Models with Extended Tailpipe (Rear Outlet) **(200364)**  
 TC2000; 5.9L Cummins Diesel Engine; 132", 160"-216" W.B.

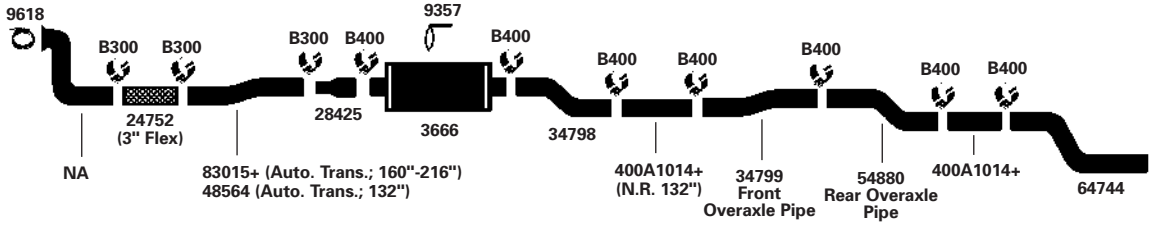

+ Cut to Length

**88-94**    6 Cyl.    TC2000 w/ 6BTA; 5.9L Turbo Diesel; Rear Exit Tail Pipe; **(200365)**  
 Side Mounted Fuel Tank; 132", 146"-195", 216"-237" W.B.

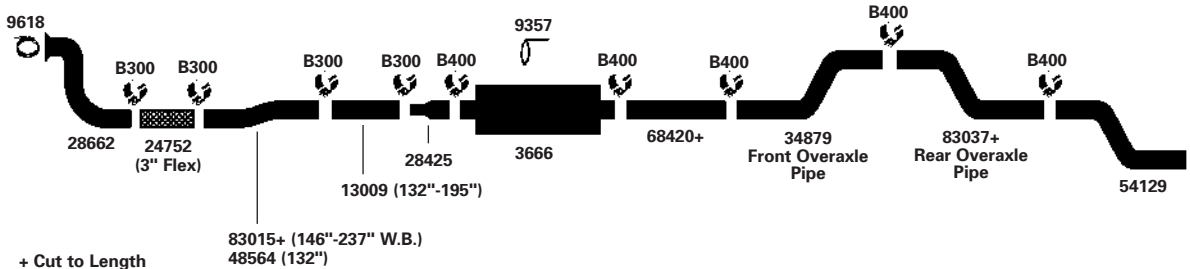

+ Cut to Length

**92-93**    6 Cyl.    GMC-Bluebird 3116 Caterpillar Engine **(200351)**

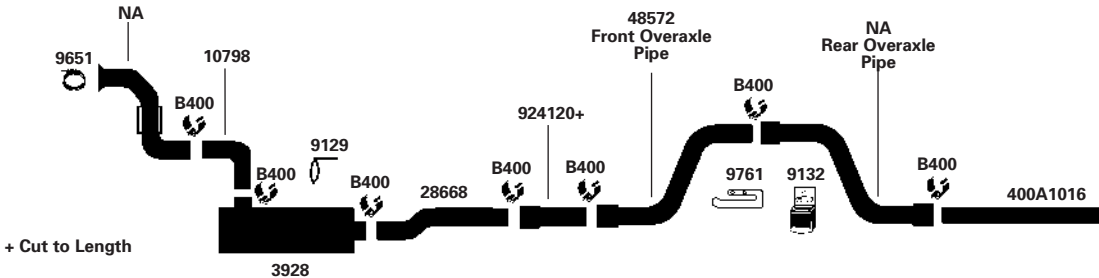

+ Cut to Length

**91-92**    6 Cyl.    All American w/ Caterpillar 3116 Turbo Diesel; **(200374)**  
 4" Rear Exit Tail Pipe; (Before Chassis No. 977303);  
 175"-197½", 205"-242½" W.B.

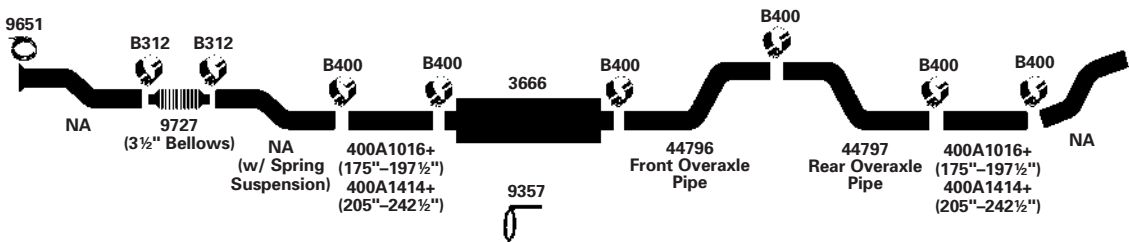

+ Cut to Length

## BLUEBIRD SCHOOL BUS

88-92 8 Cyl. All American w/ 8.2LT, 8.2LTA Front Engine Models; Rear Exit Tail Pipe; 175"-242½" W.B. **(200474)**

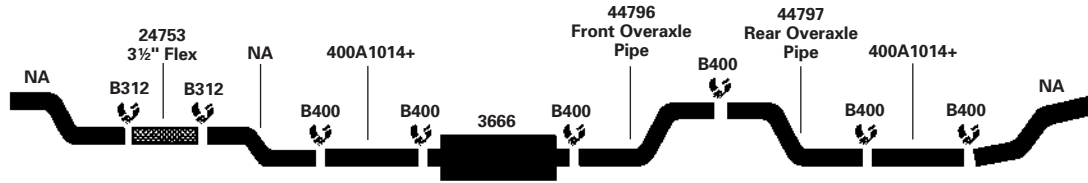

+ Cut to Length

88-92 8 Cyl. All American w/ Cummins 8.3L Front Engine Models; w/ 4" Exhaust (Before Chassis No. 977611); 175"-242½" W.B. **(200475)**

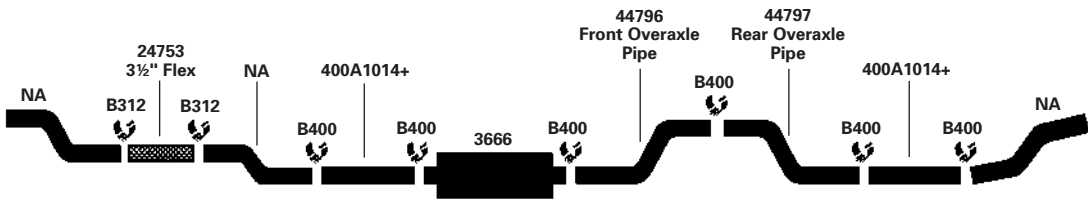

+ Cut to Length

89-91 8 Cyl. All models w/366 C.I.D. Engine w/ Converter; 254", 274" W.B. **(200476)**

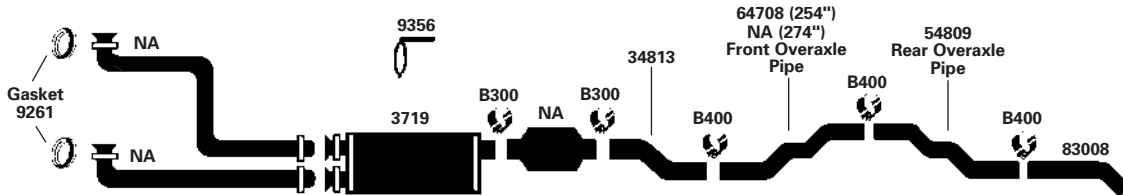

82-87 8 Cyl. All American; Caterpillar 3208 Diesel Eng.; All W.B. **(200376)**

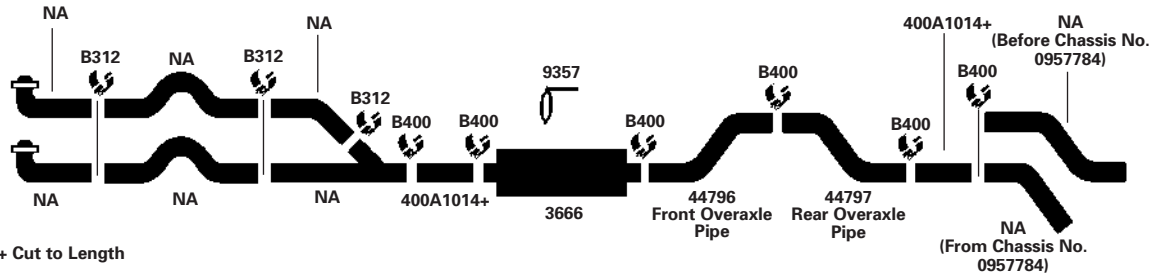

+ Cut to Length

SCHOOL BUS APPLICATIONS

## BLUEBIRD SCHOOL BUS

**80-87**    8 Cyl.    All American w/ 8.2L Turbo Diesel Front Engine Models;  
Rear Exit Tail Pipe; 175"-242½" W.B.

**(200477)**

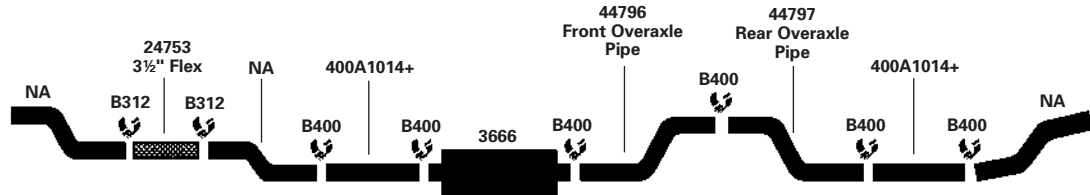

+ Cut to Length

**80-87**    8 Cyl.    All American; Cummins 504, 555 Diesel Eng.; All W.B.

**(200375)**

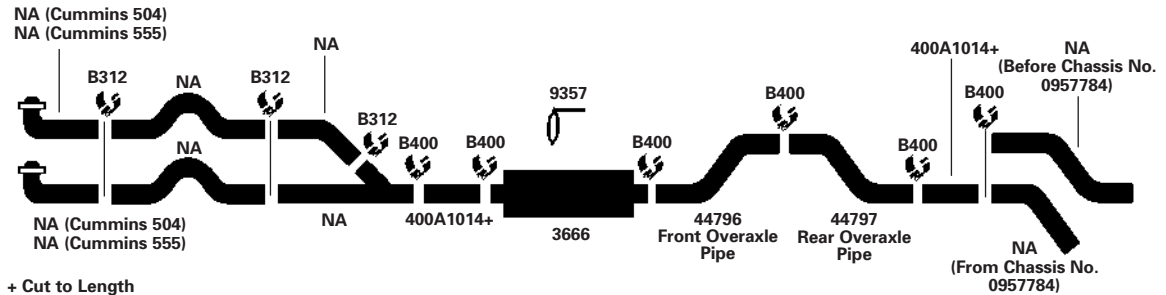

+ Cut to Length

## BLUEBIRD SCHOOL BUS

YEAR	CYL.	MAKE & MODEL	EXH. PIPE	MUFFLER	TAIL PIPE
	6	All American 8.3 Cummins; Turbo Rear Engine Pusher		3898	NA
	6	3208-3116 Caterpillar; Turbo Rear Engine Pusher		3898	NA

## CHEVROLET/GMC G10, G20, G30/G1500, G2500, G3500 SERIES VANS

1991 6 Cyl. G30/G3500; 125" W.B., 262(4.3L) Engine; Over 8500 lbs. G.V.W.; 1 Ton

(200100)

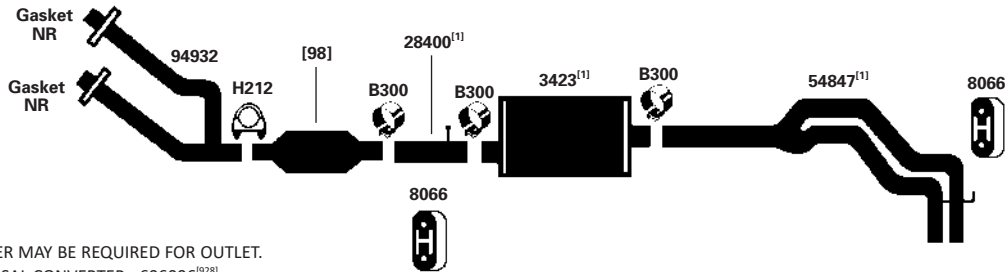

## CHEVROLET/GMC SCHOOL BUS P10, P20, P30/P1500, P2500, P3500

91-96 8 Cyl. P30/P3500 w/454 C.I.D. (7.4L) Engine; 125", 146" W.B.; With Converter

(200107)

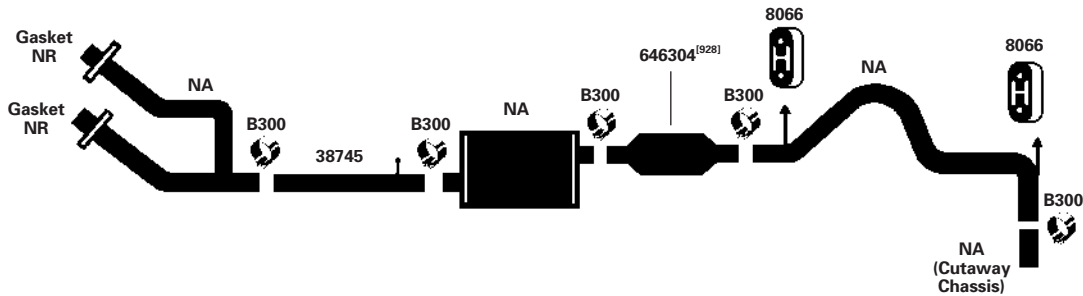

## CHEVROLET/GMC SCHOOL BUS

98-02 8 Cyl. CV200 GMC B7 Conventional Chassis w/ 454-502 Engine

(200485)

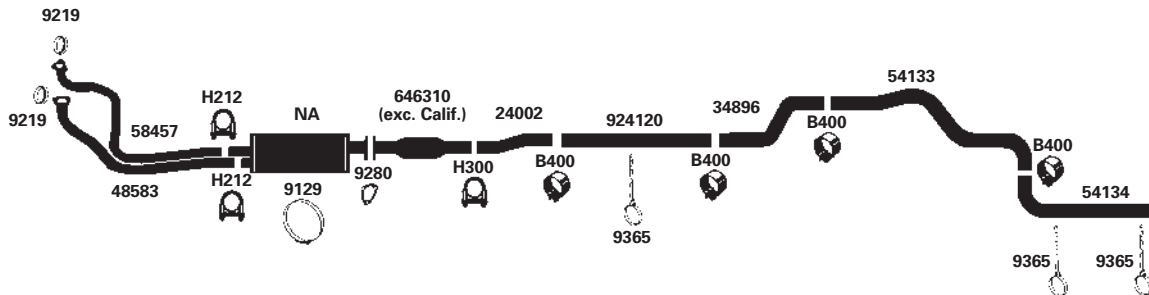

## CHEVROLET/GMC SCHOOL BUS

97-02 8 Cyl. GMC Kodiak Topkick Chassis w/ 6.5L Turbo Diesel Engine

(200487)

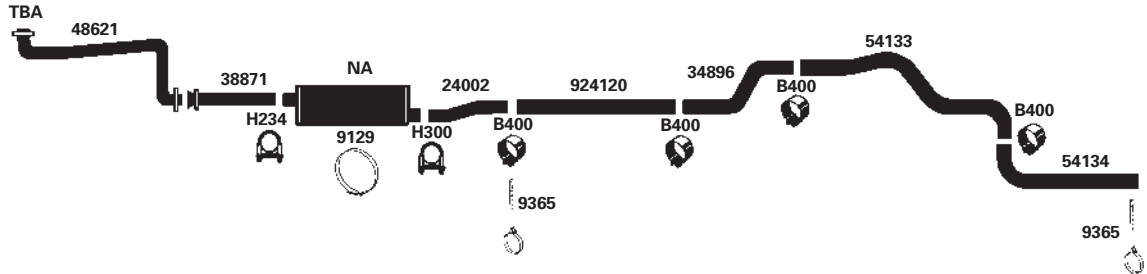

98-01 6 Cyl. 3126 Cat., CV200; GMC B7 Conventional Chassis

(200379)

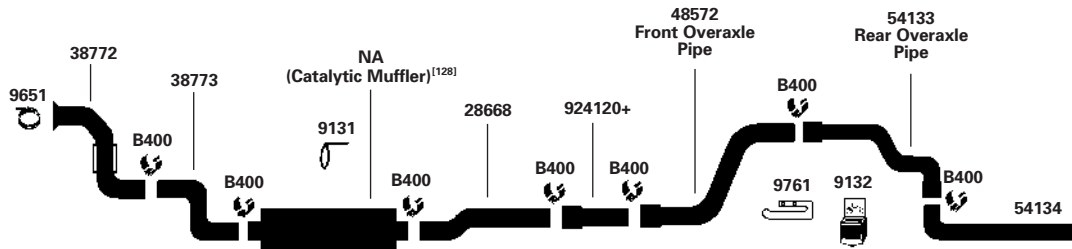

+ Cut to Length

94-98 6 Cyl. 3116 Cat., CV200; GMC B7 Conventional Chassis

(200380)

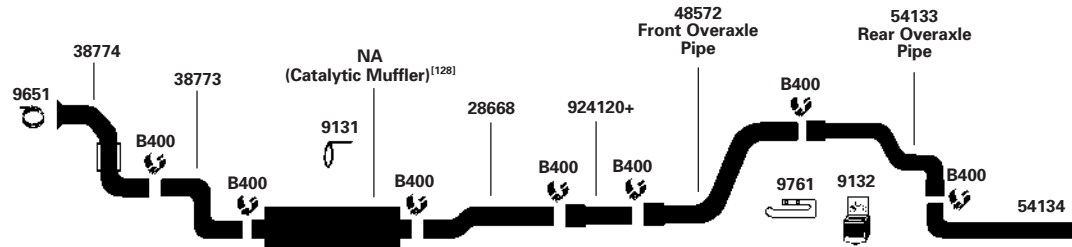

+ Cut to Length



## CHEVROLET/GMC SCHOOL BUS

**92-95** 8 Cyl. B7; 366, 427 (6.0, 7.0) TBI Eng.; With Converter; **(200382)**  
Tail Pipe Exits Side of Bus Behind Rear Wheel; 145", 209" & 261" W.B.

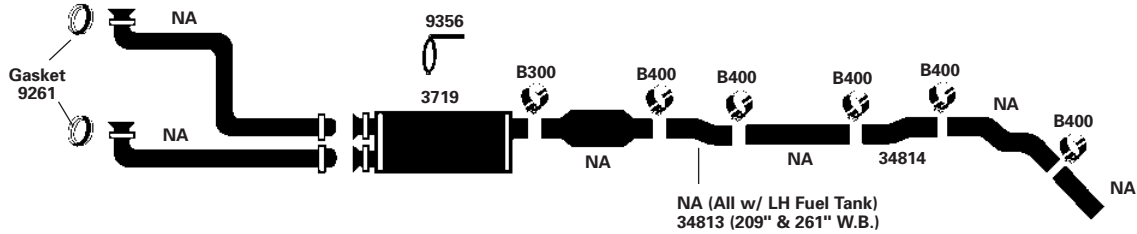

**92-95** 8 Cyl. B7; 366, 427 (6.0, 7.0) TBI Eng.; With Converter; **(200383)**  
Tail Pipe Exits Side of Bus in Front of Rear Wheel; 145", 209" & 261" W.B.

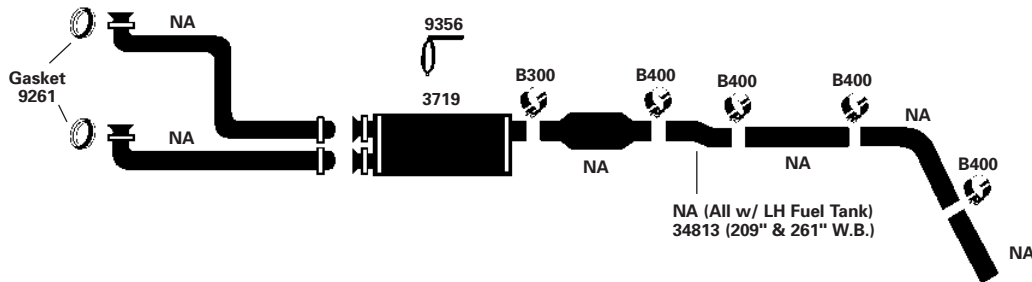

**92-95** 8 Cyl. B7; 366, 427 (6.0, 7.0) TBI Eng.; With Converter; All W.B.; **(200384)**  
Tail Pipe Exits at Rear of Bus; 145", 209" & 261" W.B.

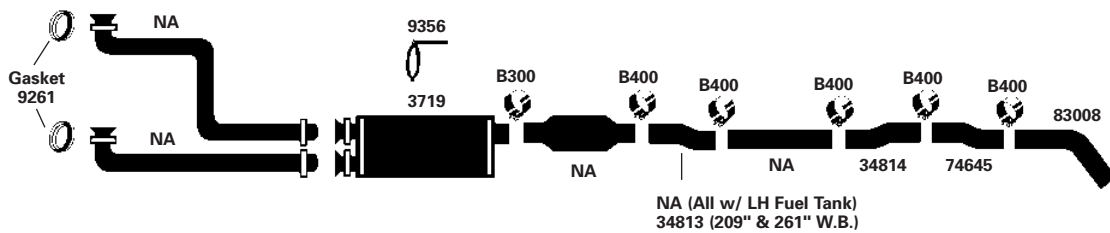

**92-93** 6 Cyl. GMC 3116 Caterpillar Engine **(200381)**

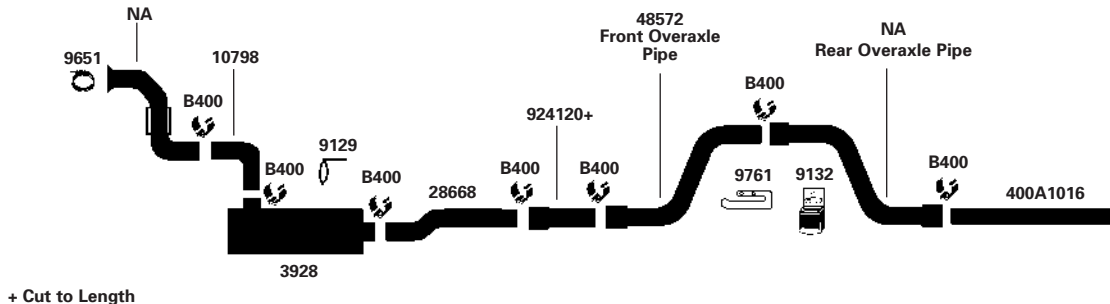

## CHEVROLET/GMC SCHOOL BUS

**85-91**    8 Cyl.    High Temperature Exhaust System B6PO42; 366 TBI Engine; 254", 274" W.B. **(200385)**

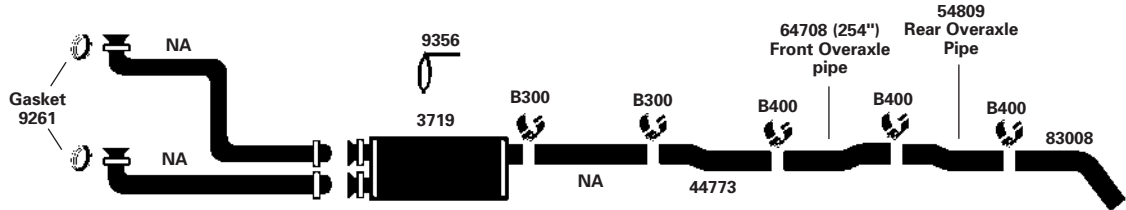

**80-91**    8 Cyl.    B6, S7; 8.2N Eng.; Auto Trans; 189", 218", 235", 254" & 274" W.B. **(200386)**

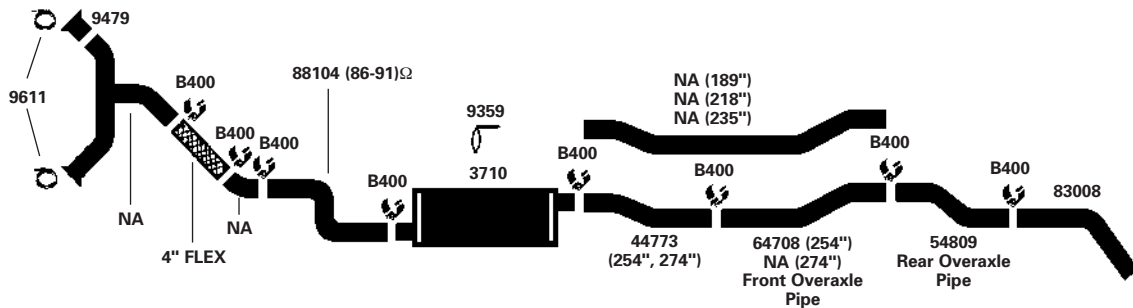

Ω Trim 3" Off Outlet End

**80-91**    8 Cyl.    B6, S7; 8.2T Eng. (Turbocharged); Auto Trans; 189", 218", 235", 254" & 274" W.B. **(200387)**

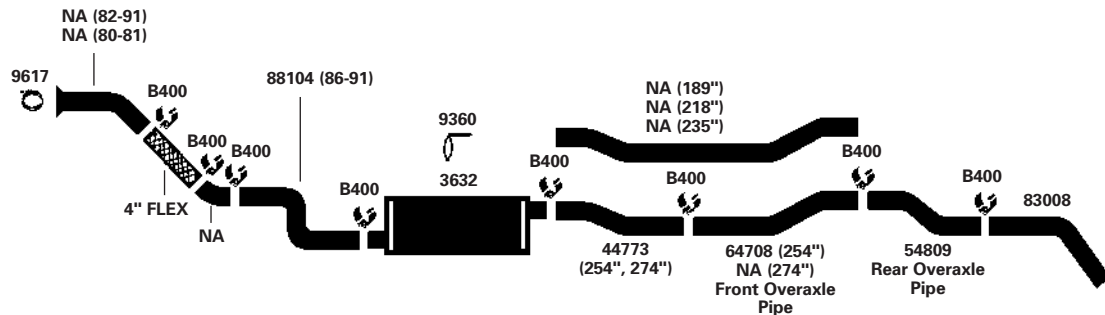

**89-91**    8 Cyl.    All models w/366 C.I.D. Engine w/ Converter; 254", 274" W.B. **(200478)**

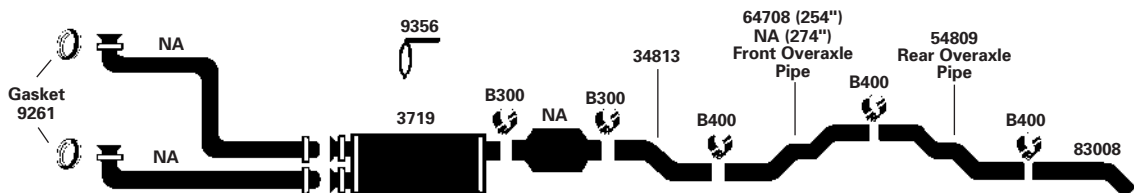

## CHEVROLET/GMC SCHOOL BUS

85-90 8 Cyl. High Temperature Exhaust System B6PO42; 366 Eng.; Man. Trans.;  
Single Muffler; 189", 218", 235", 254" & 274" W.B.

(200389)

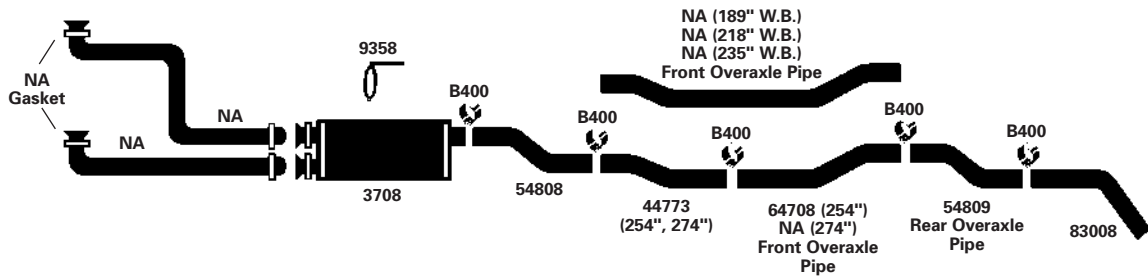

75-90 8 Cyl. Series 50, 60; 350 Eng.; Std. Trans. and FEO;  
189", 218", 235", 254" & 274" W.B.

(200391)

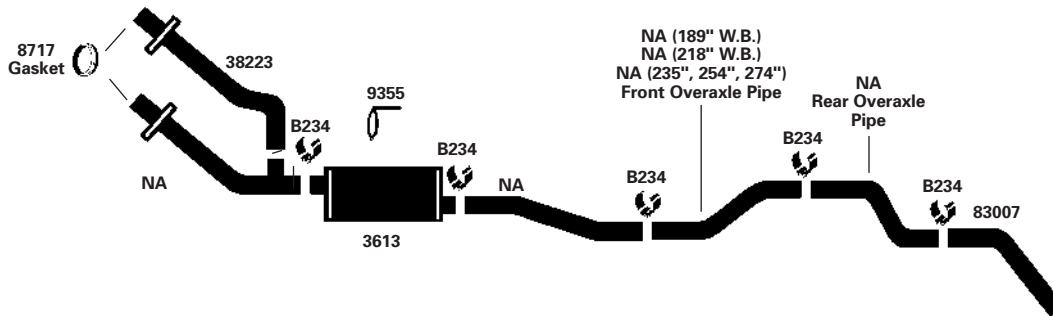

85-87 8 Cyl. High Temperature Exhaust System B6PO42; 366 Eng.; Man. Trans.;  
Dual Mufflers; 189", 218", 235", 254" & 274" W.B.

(200390)

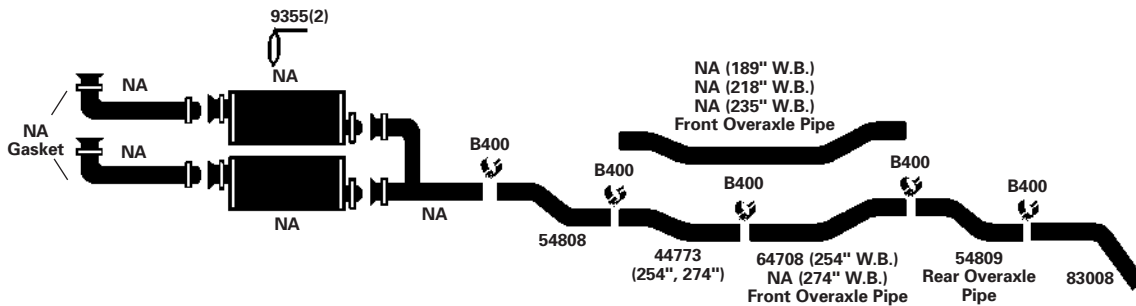

## CHEVROLET/GMC SCHOOL BUS

**73-85** 8 Cyl. Series 50, 60; 366 Eng.; Std. Trans.; 189", 218", 235", 254" & 274" W.B. **(200393)**

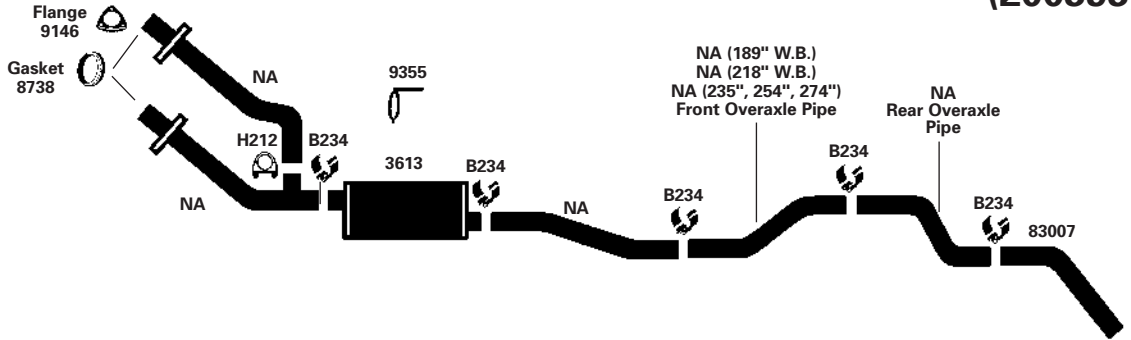

**73-78** 8 Cyl. Series 50, 60; 366 Eng.; AT475 Auto. Trans.; 189", 218", 235", 254" & 274" W.B. **(200394)**

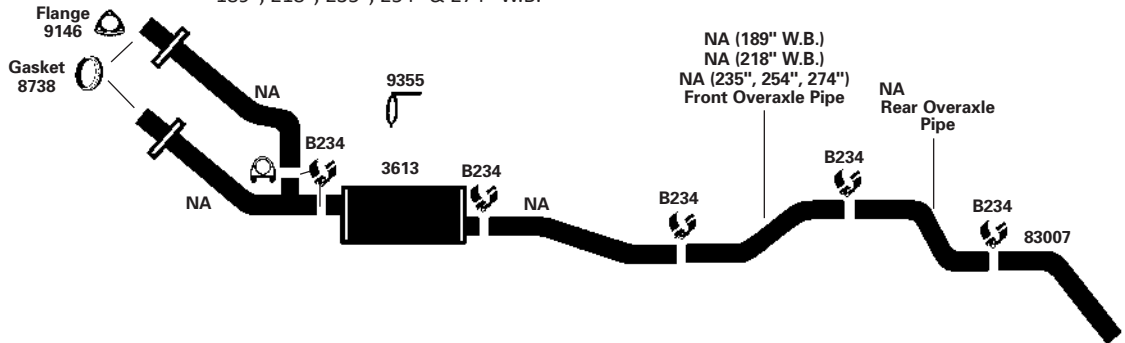

## CHEVROLET/GMC SCHOOL BUS

YEAR	CYL.	MAKE & MODEL	EXH. PIPE	MUFFLER	TAIL PIPE
89-91	4	P30/P3500 w/239 C.I.D. (3.9L); Diesel Engine		2704	NA
75-90	8	Series 50, 60; 366, 427 Eng.; AT540 Auto. Trans. and FEO; 189", 218", 254" & 274" W.B.		3613	NA
67-74	6	Series 40, 50, 60 All Models w/292 C.I.D. - Gas Eng.; 149", 189", 218", 235" & 254" W.B.		3654	NA

## FORD SCHOOL BUS E-SERIES

**95-99** 6 Cyl. B800, FD1060 w/ 5.9L Cummins Diesel; w/ Converter; Air Suspension; (200402)  
151"-275" W.B.

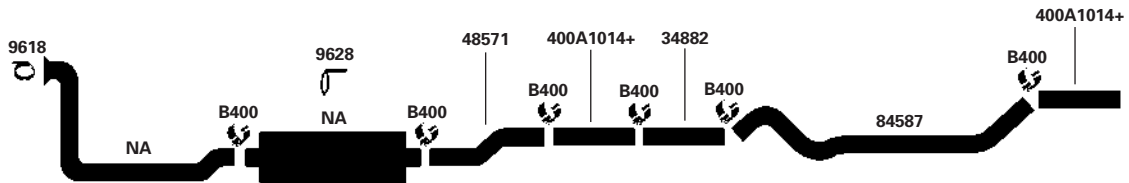

+ Cut to Length

**92-98** 6 Cyl. B600, B700, FD1060 Diesel Eng.; 5.9L; (200403)  
216" W.B. and Shorter; 237" W.B. and Longer

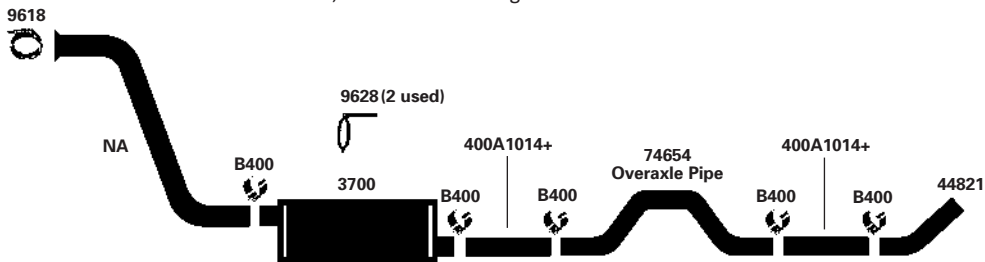

+ Cut to Length

**87-95** 8 Cyl. Cut Away Van E350 7.3L Diesel; 138", 158", 176" W.B. (200401)

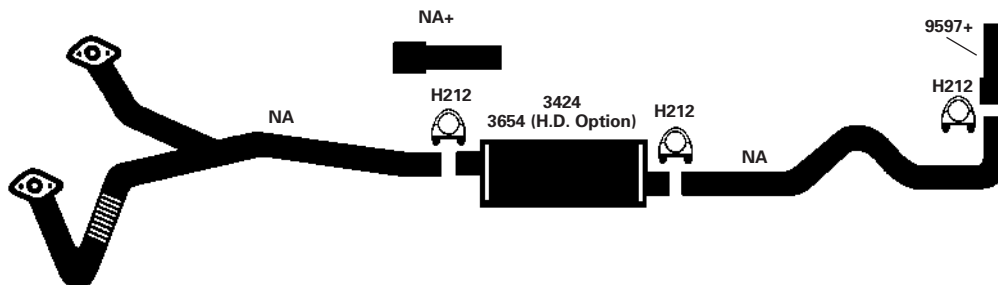

+ Cut to Length

**88-91** 6 Cyl. E350; 138" W.B.; 300 C.I.D. (4.9L) Engine; 138", 158" W.B.; With Converter (200168)

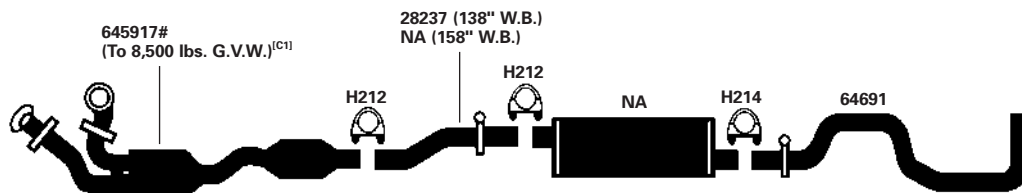

[C1] Exc. Calif., over 7200 lbs. G.V.W. Combination Front and Rear Converter, 2 To 1 Replacement. Only Defective Converters May Be Legally Replaced.

## FORD SCHOOL BUS

**87-94** 6 Cyl. B600, B700; 6.6L Diesel Eng.; Models Built Before 11-93 **(200404)**  
**87-94** 6 Cyl. B600, B700; 7.8L Diesel Eng.; Models Built Before 11-93

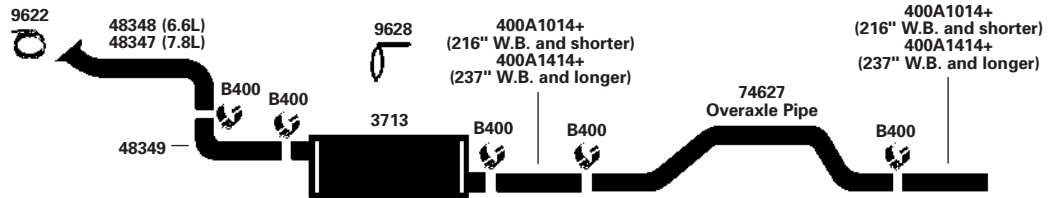

+ Cut to Length

**85-94** 8 Cyl. B600, B700; 370, 429 Eng. **(200405)**

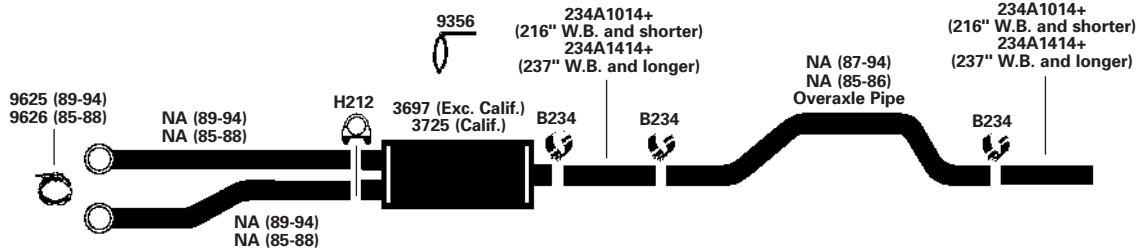

+ Cut to Length

**86-87** 8 Cyl. B600, B700; 8.2L Diesel Eng. (Turbo) **(200407)**  
**86-87** 8 Cyl. B600, B700; 636 Diesel Eng. (3208 Caterpillar) (Turbo)

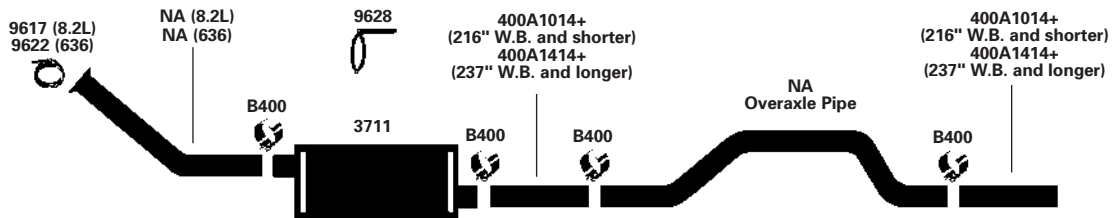

+ Cut to Length

**86-87** 8 Cyl. B600, B700; 8.2L Diesel Eng. (exc. Turbo) **(200410)**  
**86-87** 8 Cyl. B600, B700; 636 Diesel Eng. (3208 Caterpillar) (exc. Turbo)

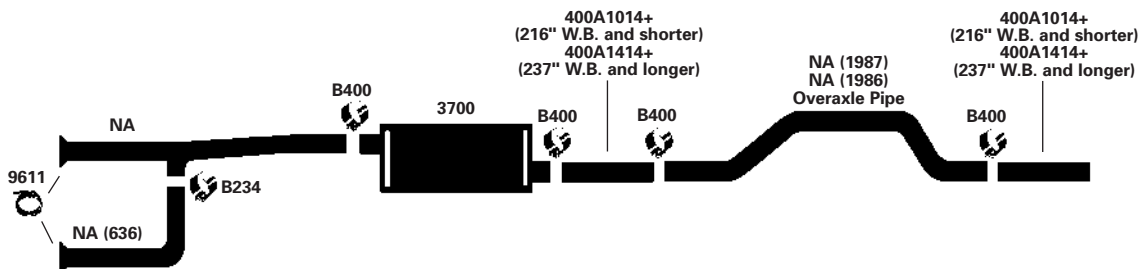

+ Cut to Length

## FORD SCHOOL BUS

**83-85** 8 Cyl. B600, B700; 8.2L Diesel Eng. (Turbo); From 2-1-83 **(200408)**  
**83-85** 8 Cyl. B600, B700; 636 Diesel Eng. (3208 Caterpillar) (Turbo); From 2-1-83

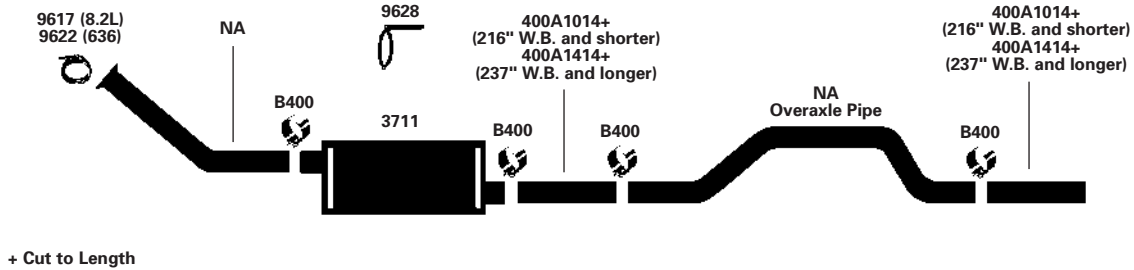

**83-85** 8 Cyl. B600, B700; 8.2L Diesel Eng. (exc. Turbo); From 2-1-83 **(200411)**  
**83-85** 8 Cyl. B600, B700; 636 Diesel Eng. (3208 Caterpillar) (exc. Turbo); From 2-1-83  
**80-83** 8 Cyl. B600, B700; 8.2L Diesel Eng. (exc. Turbo); Before 2-1-83

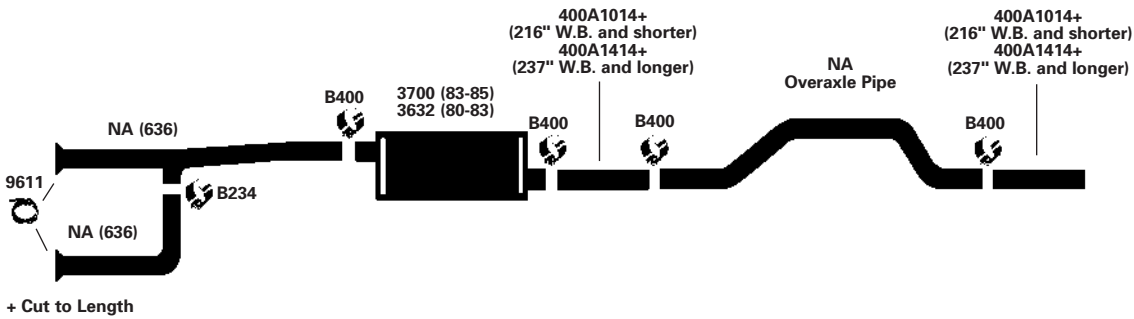

**79-84** 8 Cyl. B600, B700; 370, 429 Eng. **(200406)**

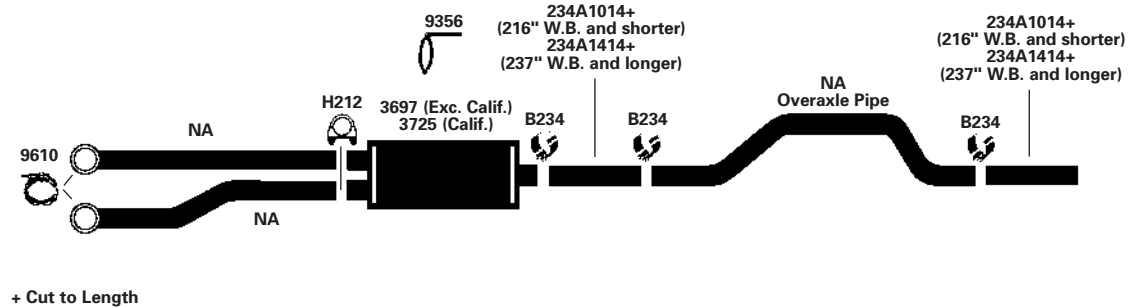

SCHOOL BUS APPLICATIONS

## FORD SCHOOL BUS

YEAR	CYL.	MAKE & MODEL	EXH. PIPE	MUFFLER	TAIL PIPE
80-83	8	B600, B700; 8.2L Diesel Eng. (Turbo); Before 2-1-83		3632	NA
75-82	8	B700; 522, 636 Diesel Eng. (3208 Caterpillar); All Wheel Bases		3668	NA
75-78	8	B600; 330, 361 Eng. 198", 222" W.B. (From V20,001 to BC5,001)		2958	NA
1978	8	B600, B700; 330, 361, 389 Eng.; 242", 260", 280" W.B. (From BC5,001)		3654	NA
73-78	8	B600, B700; 330, 361, 389 Eng.; 242", 260", 280" W.B. (From Q80,001 to BC5,001)		3654	NA
73-77	8	B500; 330 Eng.; 156" W.B. (From V20,001)		2958	NA
73-77	8	B600; 361 Eng.; 242", 260" W.B. (Q80,001 to V20,001)		3654	NA
70-73	8	B600; 330, 361 Eng.; 198", 222" W.B. (Before Q80,001)		3654	NA
70-77	8	B500; 330 Eng.; 156", 222" W.B. (Before Q80,001)		3654	NA
73-77	8	B600; 361 Eng.; 198", 222" W.B. (Before Q80,001 to V20,001)		3654	NA
73-77	8	B750; 361, 391 Eng.; 242", 260", 280" W.B. (From Q80,001)		3654	NA
70-73	8	B600; B700, B750; 330, 361, 389, 391 Eng.; 242", 260", W.B. (Before Q80,001)		3654	NA



## FREIGHTLINER SCHOOL BUS

05-06 4-6 Cyl. Freightliner Mercedes Engine

(200503)

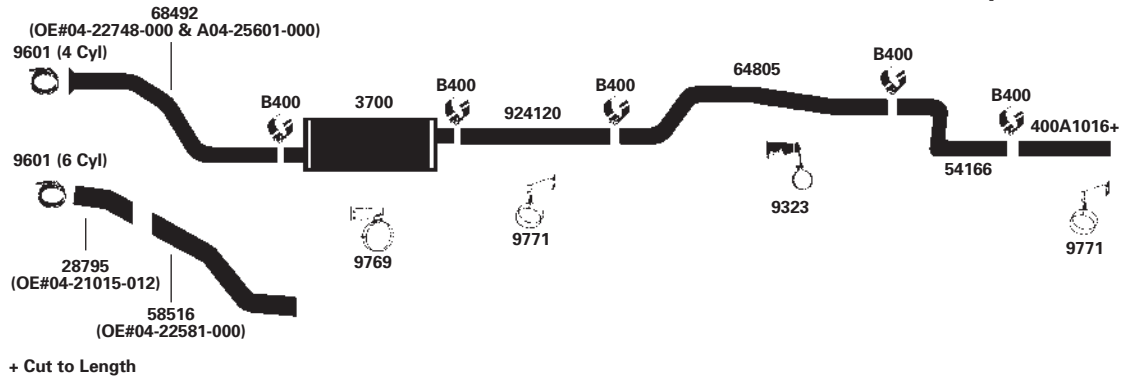

02-04 4-6 Cyl. Freightliner Mercedes Engine

(200484)

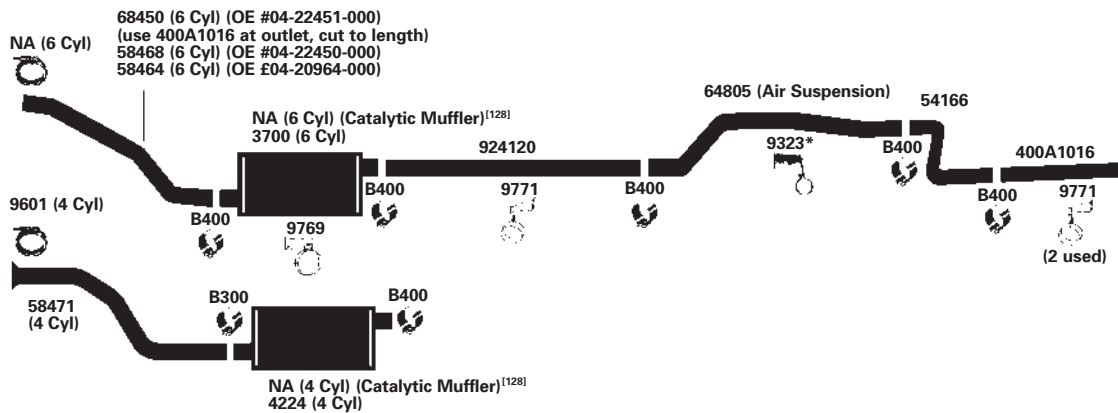

02-04 6 Cyl. Freightliner B-Series Cummins Engine w/ World Trans.

(200486)

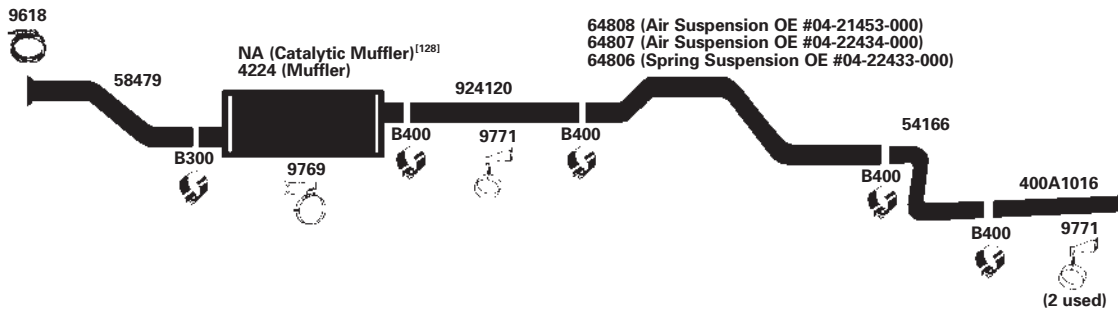

## FREIGHTLINER SCHOOL BUS

02-04 6 Cyl. Freightliner 3126 Caterpillar Engine

(200495)

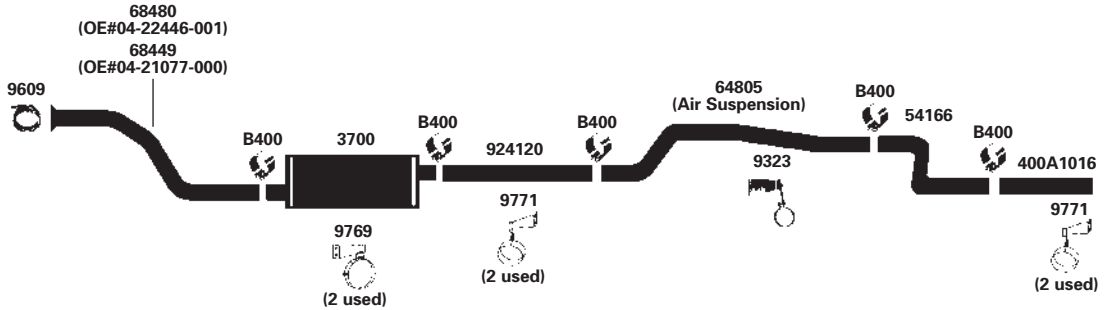

98-01 6 Cyl. Freightliner B-Series Cummins Engine

(200420)

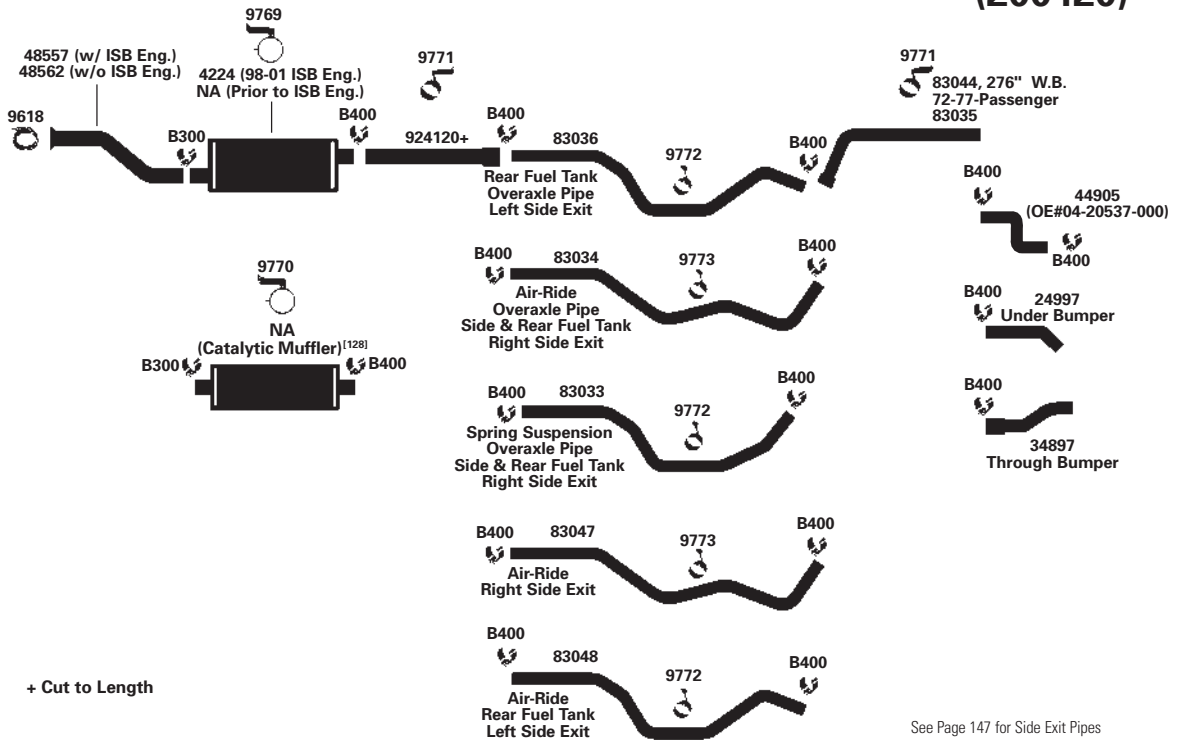

## FREIGHTLINER SCHOOL BUS

98-01 6 Cyl. Freightliner 3126 Caterpillar Engine

(200421)

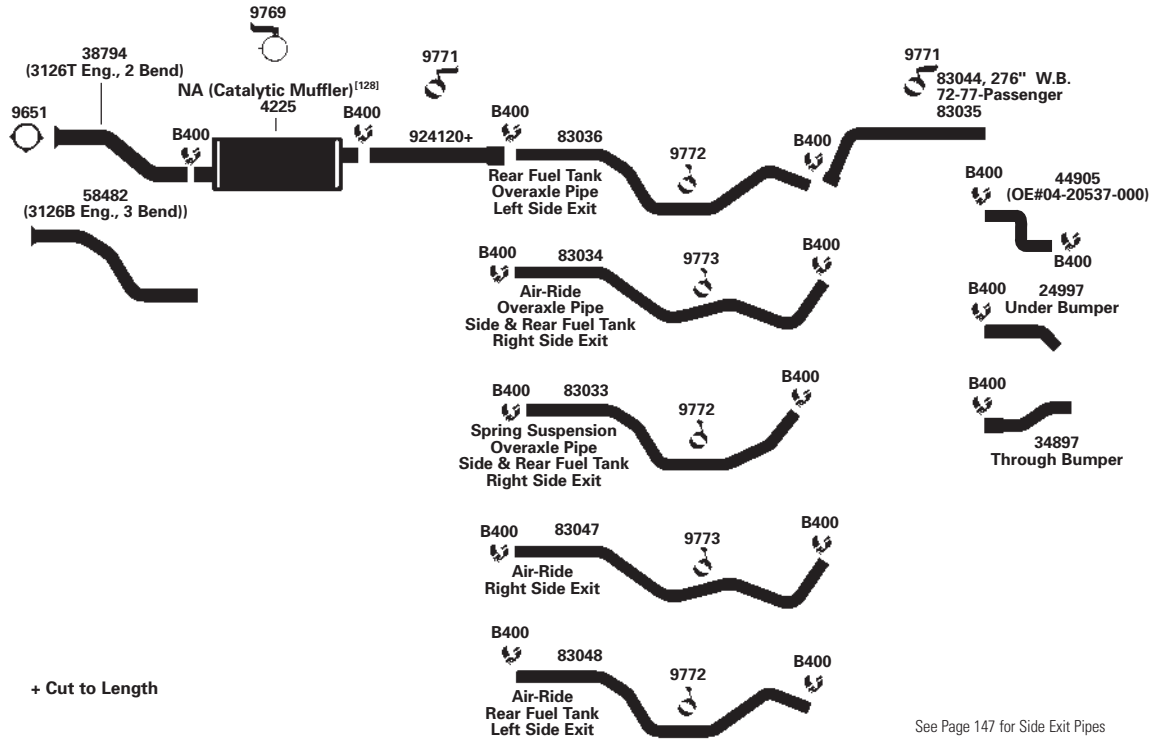

See Page 147 for Side Exit Pipes

## GENESIS SCHOOL BUS

**94-98**    6 Cyl.    Model 3900 Front Engine Chassis w/ DT466 Diesel; RH Tail Pipe;    **(200422)**  
 w/ Air Suspension; 152"-276" W.B.

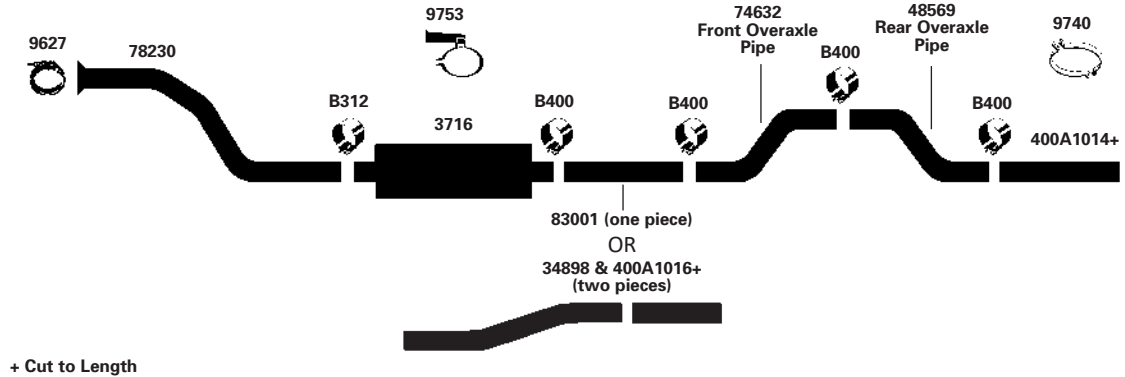

**94-98**    6 Cyl.    Model 3900 Front Engine Chassis w/ DT466 NGD Diesel;    **(200423)**  
 w/o Air Suspension; 152"-276" W.B.

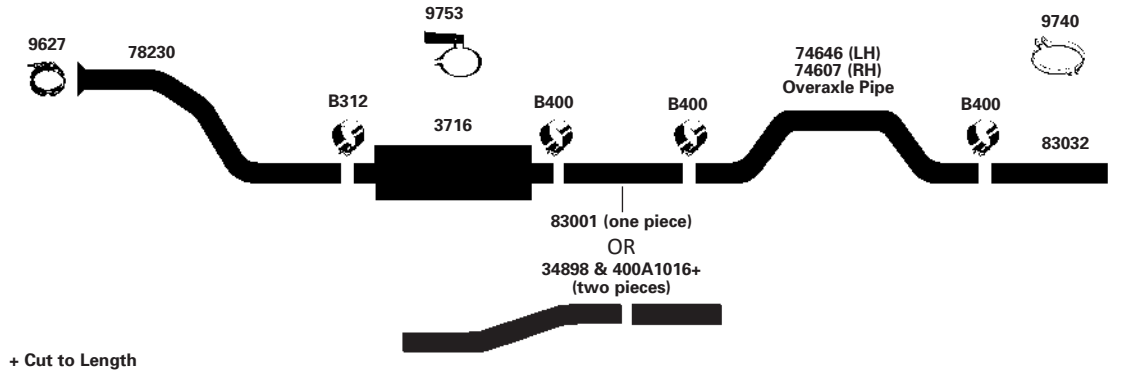

**92-94**    6 Cyl.    Model 3900 Front Engine Chassis w/ DT360 Diesel; RH Tail Pipe;    **(200424)**  
 w/ Air Suspension; 152"-276" W.B.

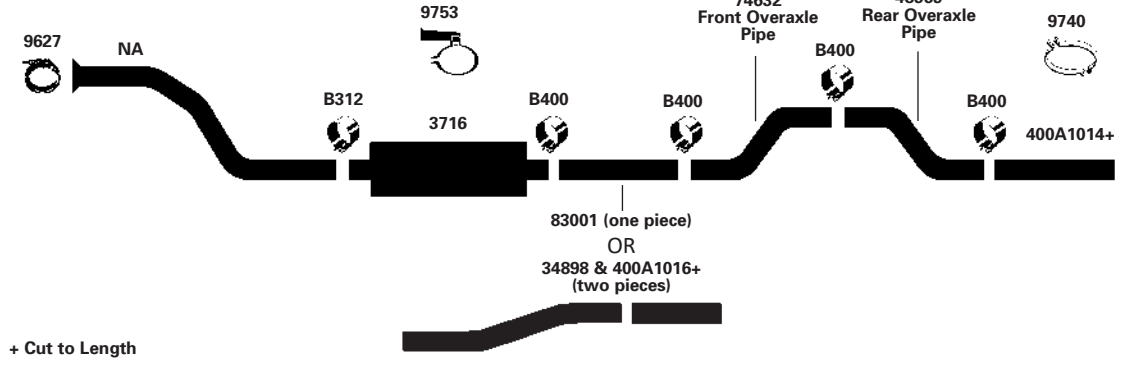

SCHOOL BUS APPLICATIONS

## NAVISTAR / INTERNATIONAL SCHOOL BUS

07-08 6 Cyl. FE international DT 466 Engine, Right Side Exit Max Force DT **(200504)**

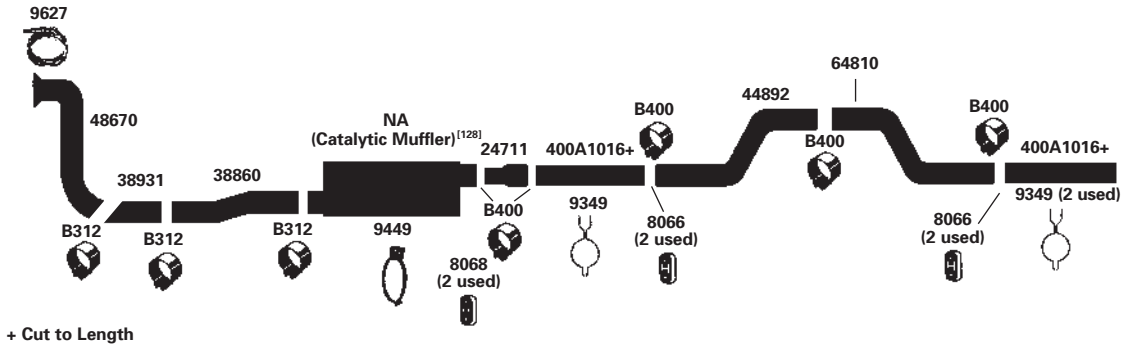

05-08 6 Cyl. CE international w/ DT 466 Engine & VT 365 Engine **(200488)**

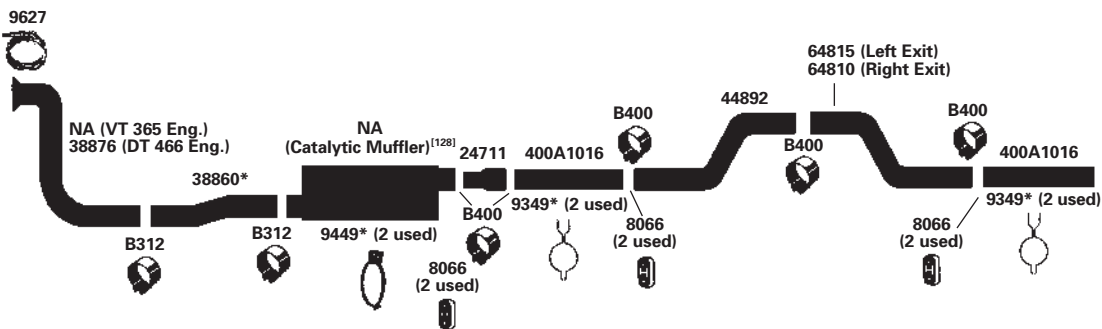

04-07 8 Cyl. IC Rear Engine VT-365 & DT466 **(200506)**

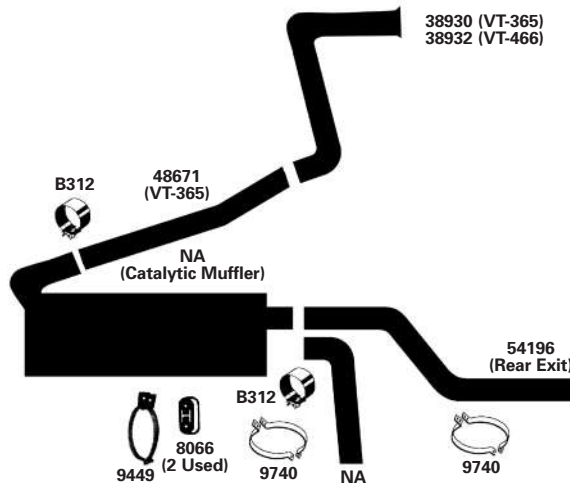

SCHOOL BUS APPLICATIONS

## NAVISTAR / INTERNATIONAL SCHOOL BUS

04-05 8 Cyl. Model IC w/VT365 Diesel (200505)

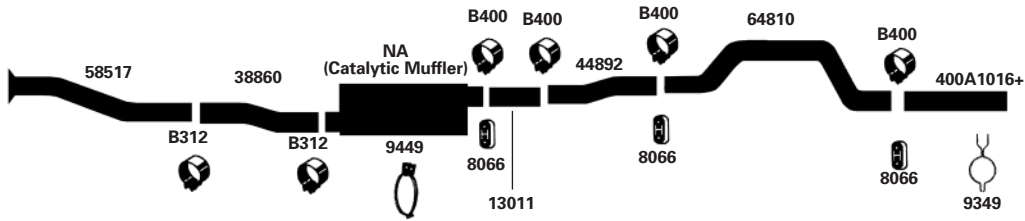

+ Cut to Length

00-03 6 Cyl. International DT 466 Engine, Left Side Exhaust System (200489)

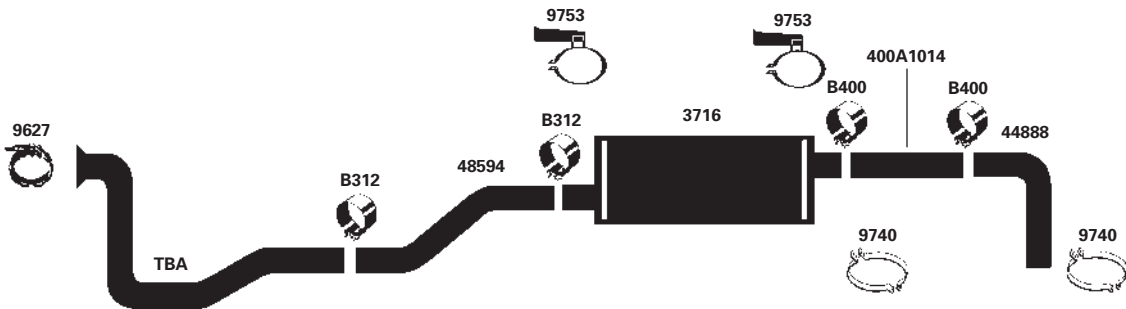

01-04 6 Cyl. Series 3800 w/ T444 Turbo Diesel, w/ Air Ride Suspension (200497)

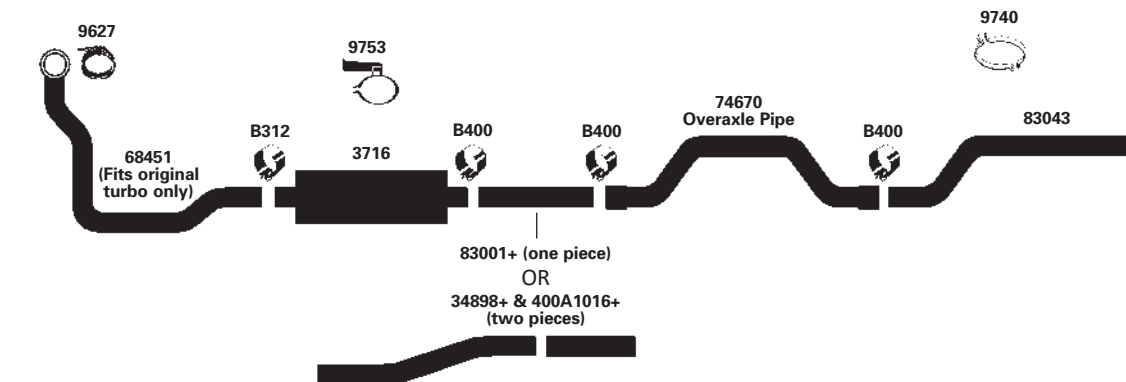

+ Cut to Length

## NAVISTAR / INTERNATIONAL SCHOOL BUS

2001 6 Cyl. Series 3800 w/ 444 Turbo Diesel, w/ Spring Suspension (Vari-Rate Suspension) **(200498)**

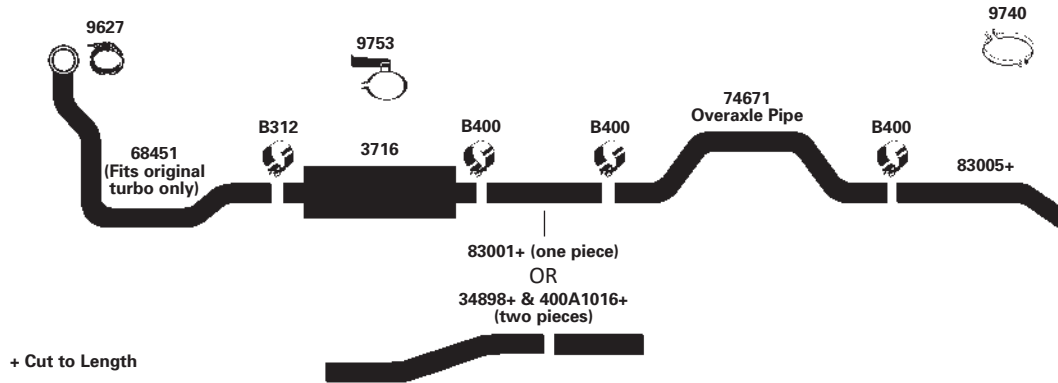

00-01 6 Cyl. Series 3800 w/ 466 Turbo Diesel, w/ Air Ride Suspension **(200499)**

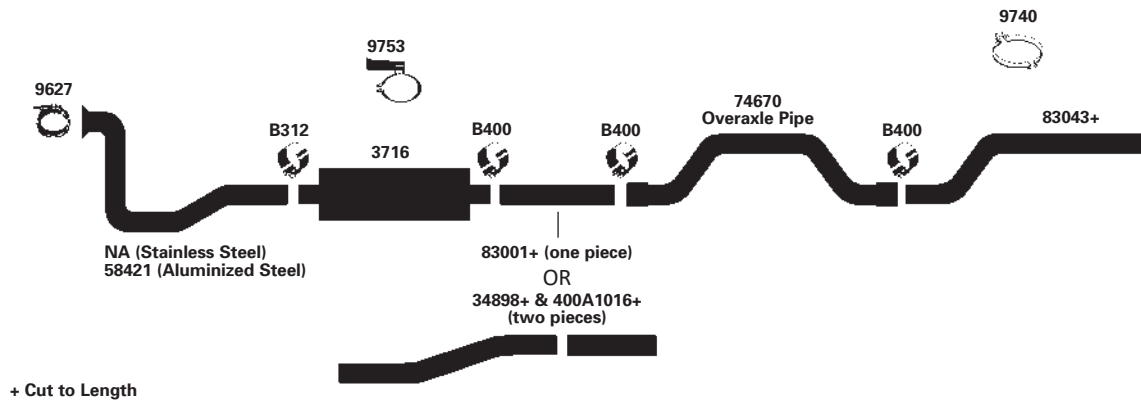

96-00 6 Cyl. Series 3800 w/ DT408, DT466 NGD Diesel; w/ Code 07ABC; RH Exhaust; 152" W.B. **(200425)**

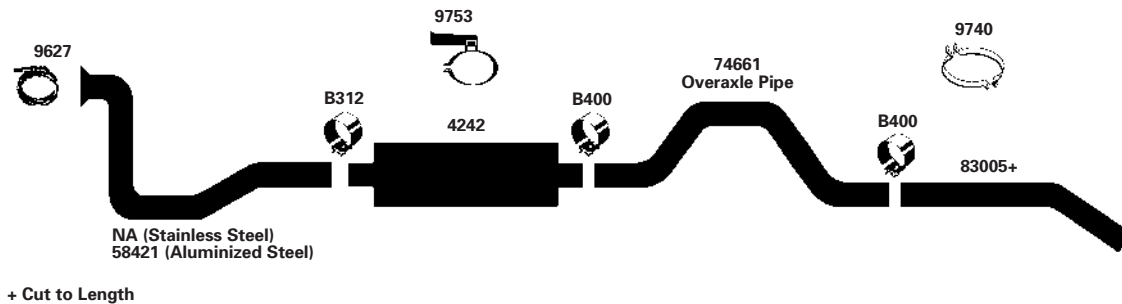

## NAVISTAR / INTERNATIONAL SCHOOL BUS

94-02 8 Cyl. International; Amtran – T444E Rear Engine; Forward Control

(200426)

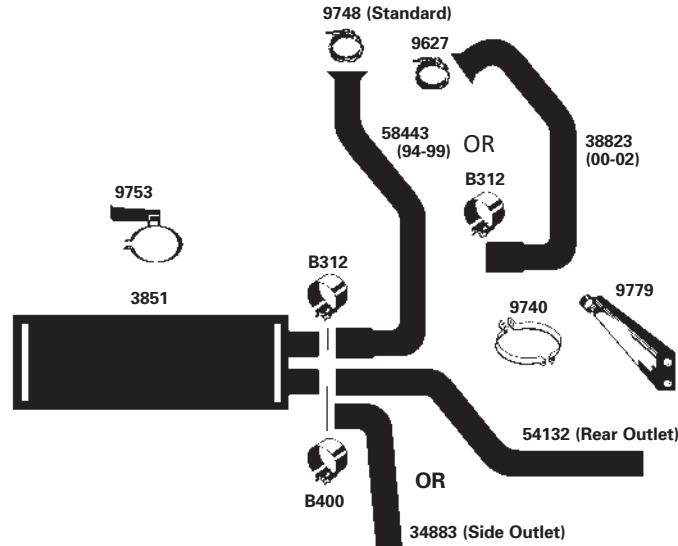

94-00 8 Cyl. Series 3600; w/ T444E Diesel; w/ Code 10NXW-Handicap Pkg.; RH Rear Exit Tail Pipe; 152"-276" W.B.

(200427)

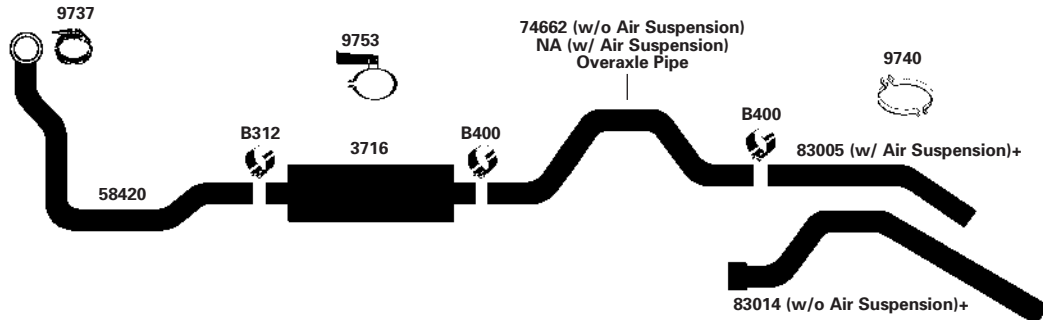

+ Cut to Length

94-00 6-8 Cyl. Series 3600, 3800; 6 Cyl. DT408, DT466E, 8 Cyl. T444E Diesel; w/ Air Suspension; 152"-276" W.B.

(200428)

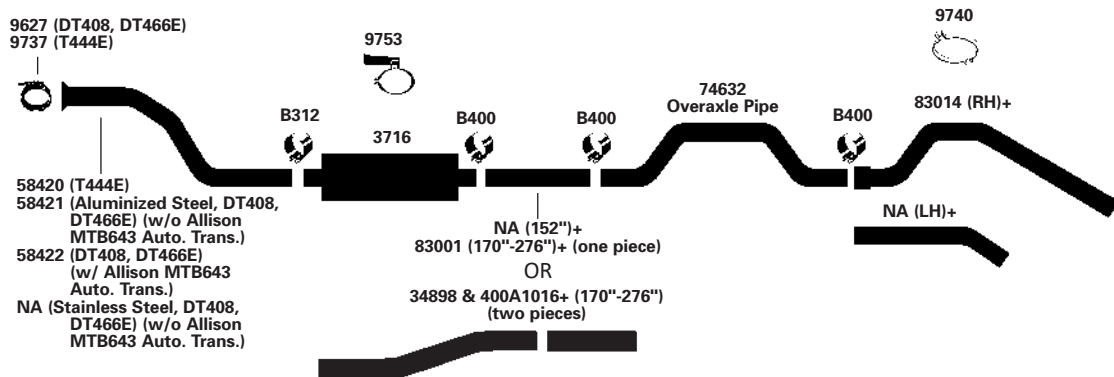

+ Cut to Length



## NAVISTAR / INTERNATIONAL SCHOOL BUS

94-00 6-8 Cyl. Series 3600, 3800; 6 Cyl. DT408, DT466E, 8 Cyl. T444E Turbo Diesel;  
w/ Vari-Rate Suspension; 152"-276" W.B.

(200429)

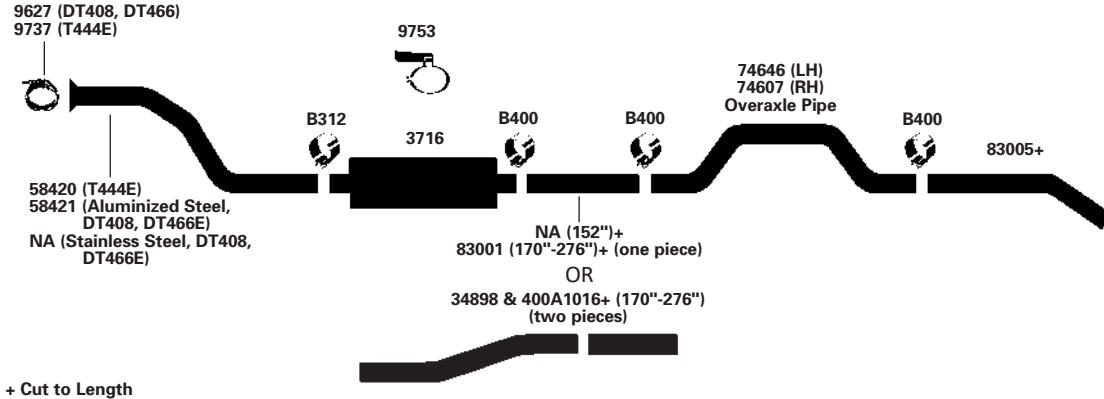

94-00 6 Cyl. Series 3800; w/ DT408, DT466E Turbo Diesel; Code 07AAS;  
Tail Pipe Exits Front of LH Rear Wheel; 152"-276" W.B.

(200430)

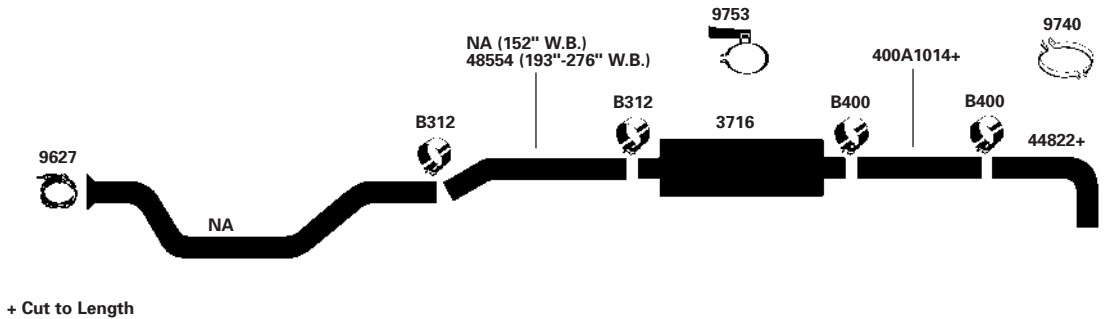

94-00 6 Cyl. Series 3800; w/ DT408, DT466E Turbo Diesel; w/ Code 07AAN;  
LH Exit Tail Pipe; w/o Air Suspension; 152"-276" W.B.

(200431)

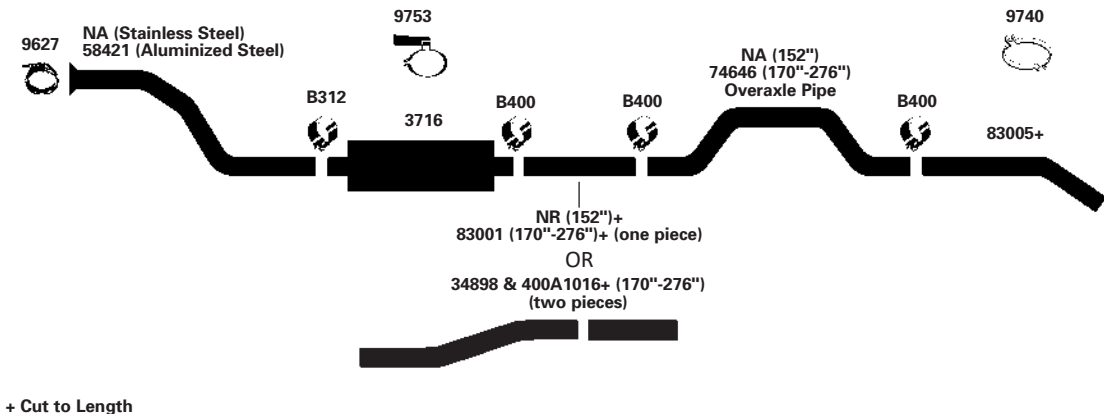

+ Cut to Length

## NAVISTAR / INTERNATIONAL SCHOOL BUS

**94-00**    6 Cyl.    Series 3800; w/ DT408, DT466E Turbo Diesel; w/ Code 07AAW; **(200432)**  
w/ Allison MTB643, MTB653DR Auto. Trans.; LH Exit Tail Pipe;  
w/o Air Suspension; 152", 170"-276" W.B.

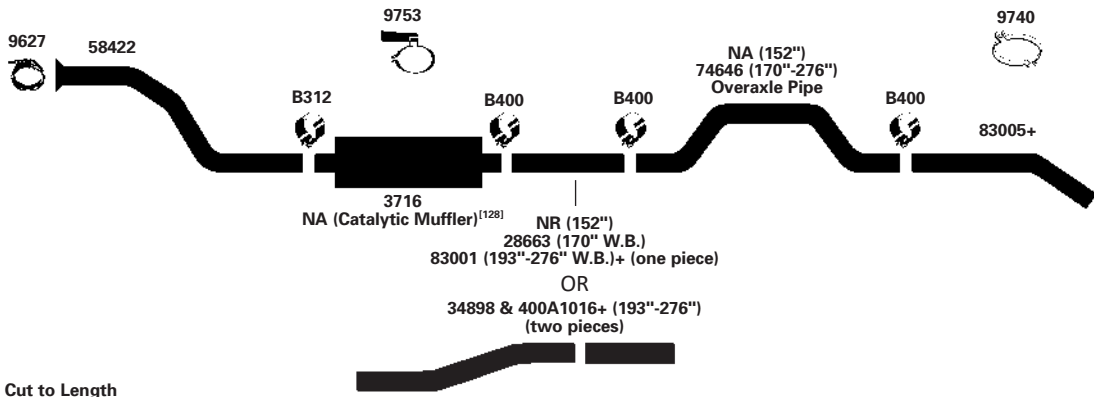

**94-00**    6 Cyl.    Series 3600, 3800; w/ DT408, DT466E, T444E Diesel; **(200433)**  
w/ Mor-Ryde Suspension (exc. RH Rear Exit Tail Pipe);  
152", 170"-276" W.B.

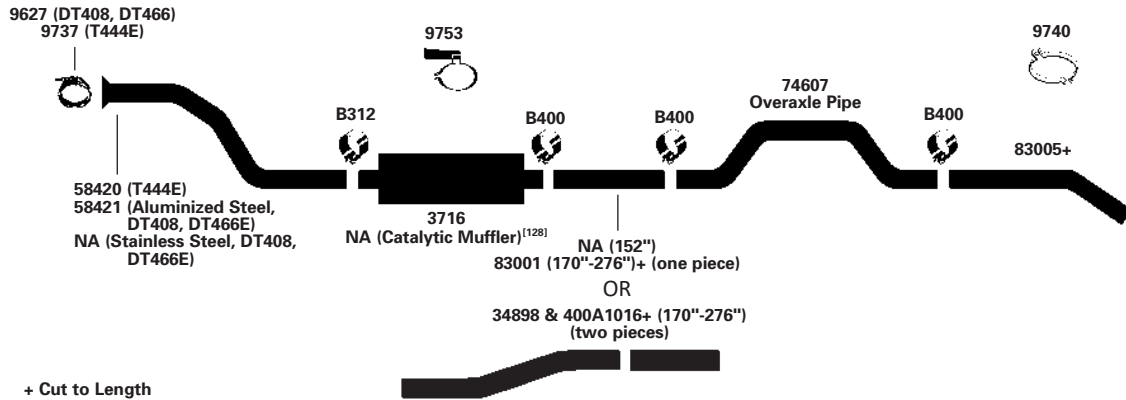

**94-00**    6 Cyl.    International; Amtran – DT 466 Rear Engine; Forward Control **(200490)**

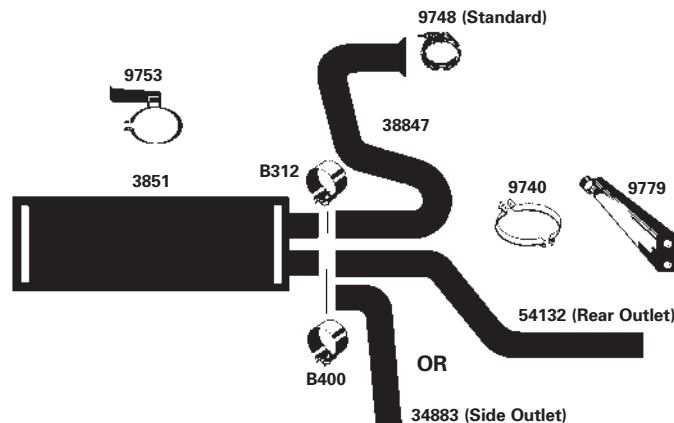

## NAVISTAR / INTERNATIONAL SCHOOL BUS

**91-93** 6 Cyl. Series "S"; 3700, 3800; w/ DT466, DTA466 Diesel Eng.; Allison MTB643 Auto. Trans; w/ Mor-Ryde or Vari-Rate Suspension; w/o Air Suspension; Long Tail Pipe-Left Side Exit **(200434)**

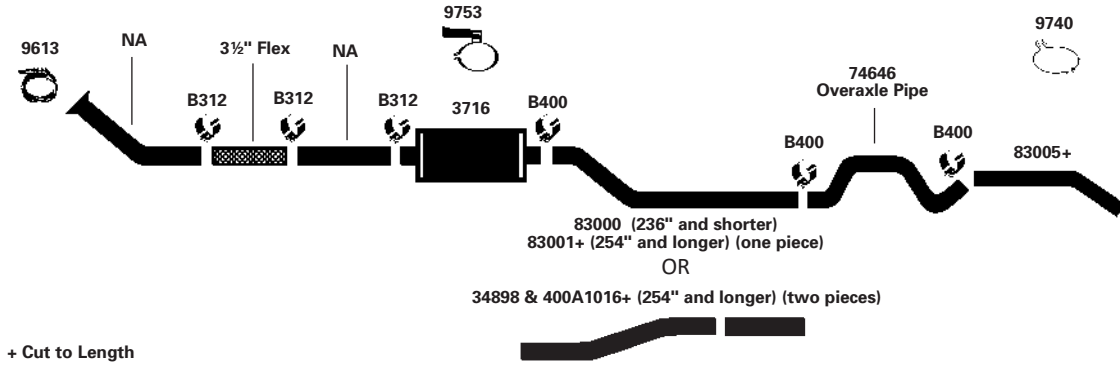

**91-93** 6 Cyl. Series "S"; 3700, 3800; w/ DT466, DTA466 Diesel Eng.; Allison MTB643 Auto. Trans; w/ Air Suspension; Long Tail Pipe-Left Side Exit **(200435)**

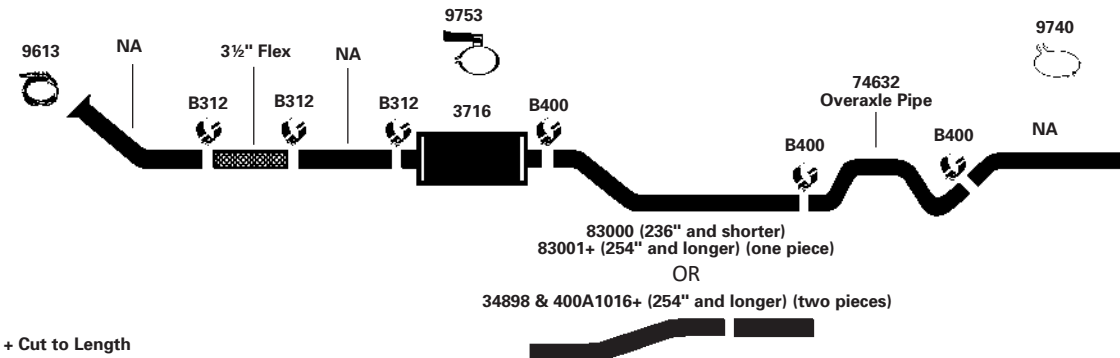

**91-93** 6 Cyl. Series "S"; 3700, 3800; w/ DT466, DTA466 Diesel Eng.; Allison MTB643 Auto. Trans; w/ Air Suspension; Long Tail Pipe - Right Side Exit **(200436)**

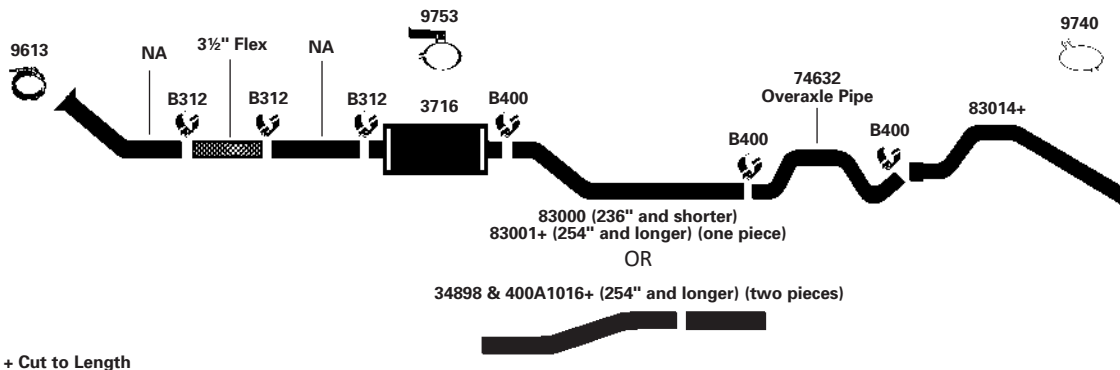

## NAVISTAR / INTERNATIONAL SCHOOL BUS

**91-93** 6 Cyl. Series "S"; 3700, 3800; w/ DT360, DTA360 Diesel Eng.;  
Short Tail Pipe-Left Side Exit in Front of Rear Wheel

**(200437)**

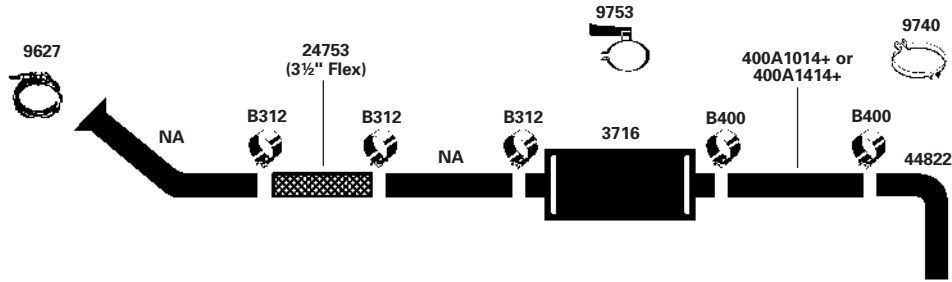

+ Cut to Length

**91-93** 6 Cyl. Series "S"; 3700, 3800; w/ DT466, DTA466 Diesel Eng.;  
Short Tail Pipe-Left Side Exit in Front of Rear Wheel

**(200438)**

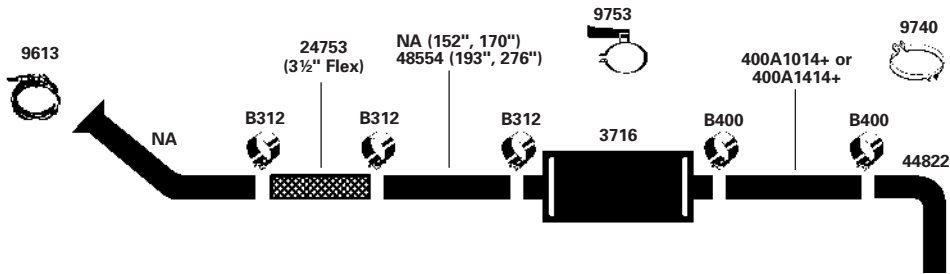

+ Cut to Length

**91-93** 6 Cyl. 3900 FC Series; w/ DT360, DTA360 Diesel Eng.;  
Short Tail Pipe-Left Side Exit in Front of Rear Wheel

**(200439)**

**91-93** 6 Cyl. 3900 FC Series; w/ DT466, DTA466 Diesel Eng.;  
Short Tail Pipe-Left Side Exit in Front of Rear Wheel

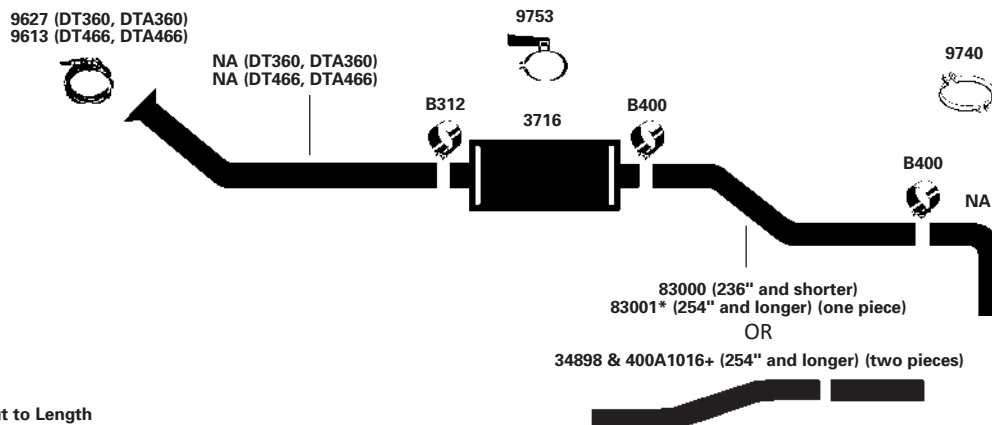

+ Cut to Length

## NAVISTAR / INTERNATIONAL SCHOOL BUS

**91-93** 6 Cyl. 3900 FC Series; DT/DTA360, DT/DTA466 Diesel Eng.; w/o Air Suspension; Long Tail Pipe **(200441)**

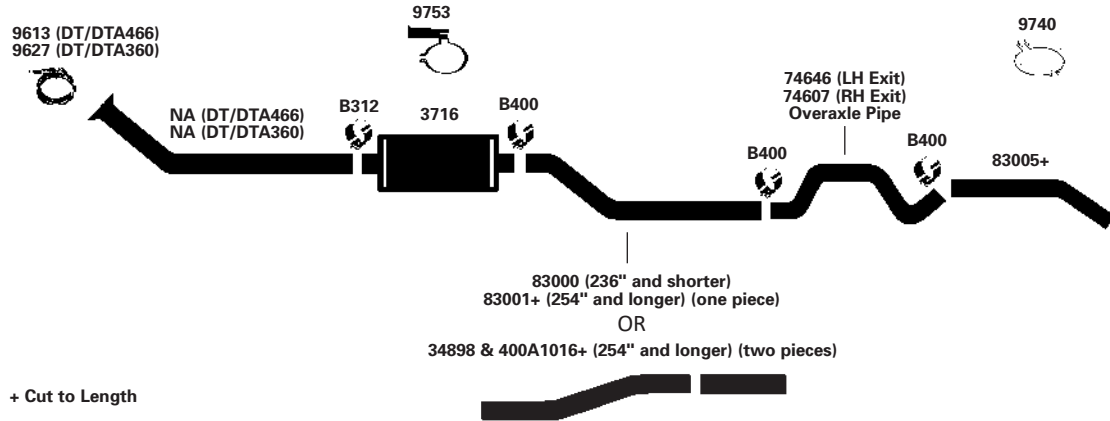

**91-93** 6 Cyl. 3900 FC Series; DT/DTA360, DT/DTA466 Diesel Eng.; w/ Air Suspension; Long Tail Pipe **(200442)**

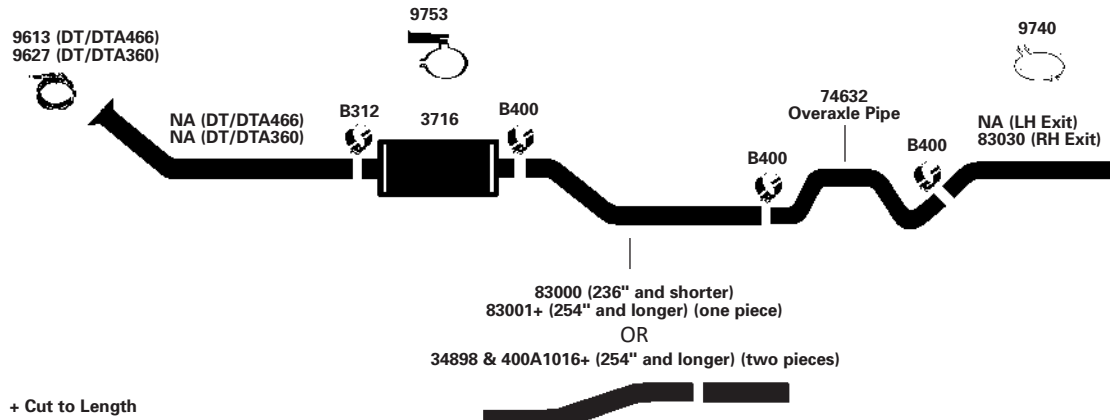

**88-93** 6 Cyl. Series 3700, 3800; w/ 7.3L Diesel; LH Side Exit in Front of Rear Wheel; 152"-276" W.B. **(200447)**

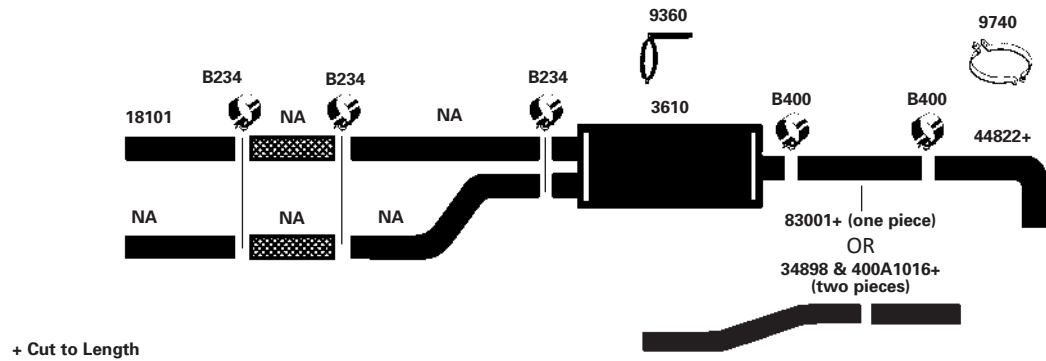

SCHOOL BUS APPLICATIONS

## NAVISTAR / INTERNATIONAL SCHOOL BUS

- |              |        |  |                 |
|--------------|--------|--|-----------------|
| <b>88-93</b> | 8 Cyl. | Series "S"; 3600, 3700; 7.3L Diesel Eng.; w/o Air Susp.;<br>RH Mounted Tail Pipe | <b>(200448)</b> |
| <b>88-93</b> | 8 Cyl. | Series "S"; 3600, 3700; 7.3L Diesel Eng.; w Air Susp.; RH Mounted Tail Pipe      |                 |

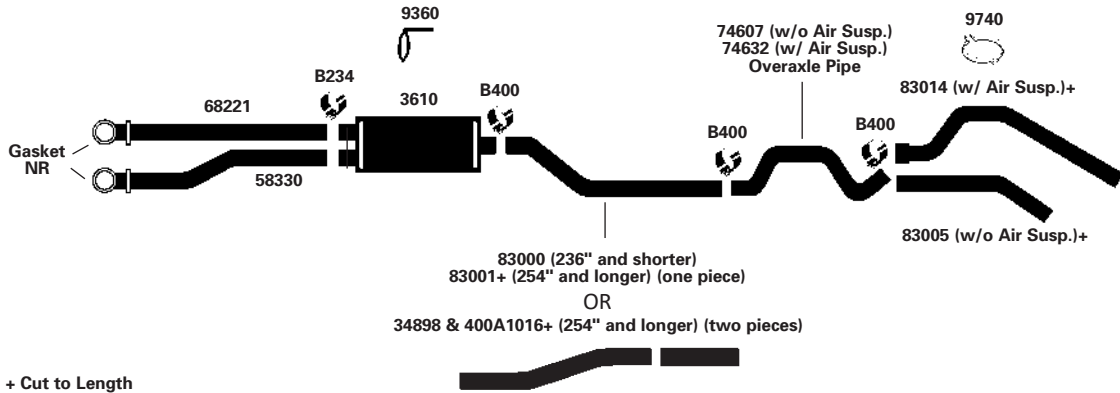

- |              |        |  |                 |
|--------------|--------|--|-----------------|
| <b>88-93</b> | 8 Cyl. | Series "S"; 3600, 3700; 7.3L Diesel Eng.; w/o Air Susp.;<br>LH Mounted Tail Pipe | <b>(200449)</b> |
| <b>88-93</b> | 8 Cyl. | Series "S"; 3600, 3700; 7.3L Diesel Eng.; w Air Susp.; LH Mounted Tail Pipe      |                 |

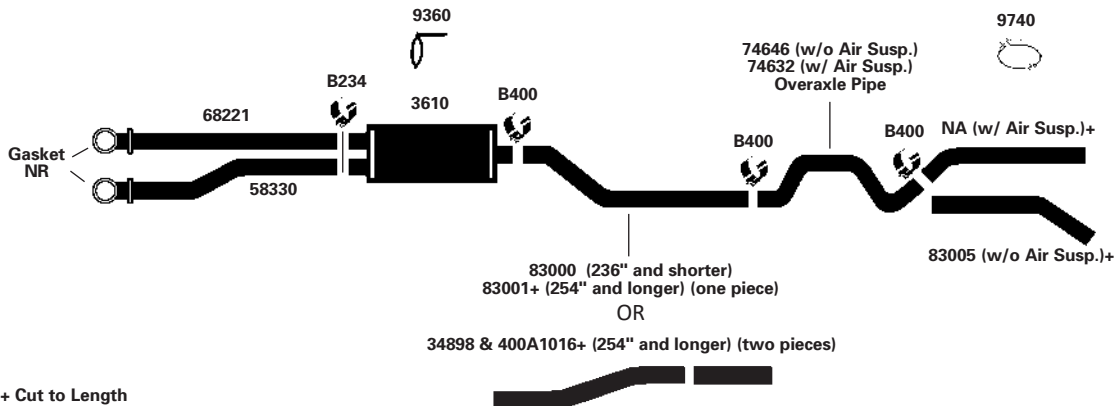

- |              |        |   |  |
|--------------|--------|---|--|
| <b>87-93</b> | 6 Cyl. | Series "S"; 3600, 3700, 3800; DT/DTA360 Diesel Eng.; w/o Air Susp.<br>w/ Mor-Ryde or Vari-Rate Susp.; Long Tail Pipe - Left Side Exit |  |
| <b>87-93</b> | 6 Cyl. | Series "S"; 3600, 3700, 3800; DT/DTA360 Diesel Eng.;<br>w/o Air Susp.; Long Tail Pipe - Right Side Exit                               |  |

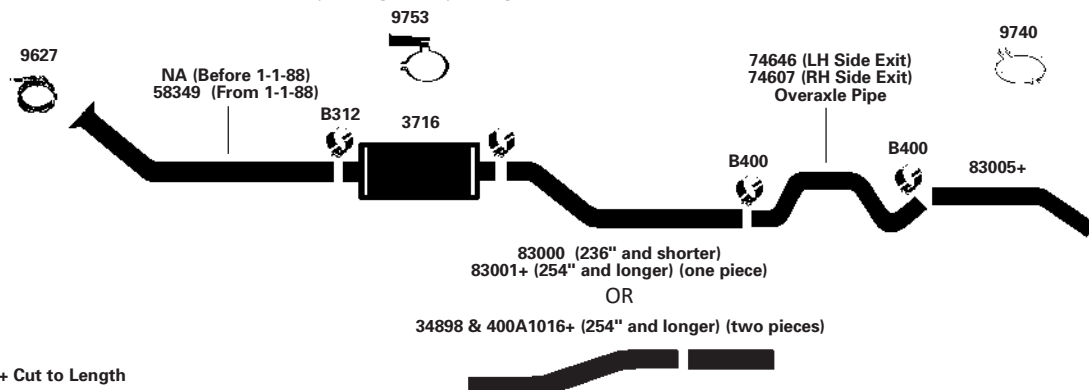

## NAVISTAR / INTERNATIONAL SCHOOL BUS

- 87-93** 6 Cyl. Series "S"; 3700, 3800; DT/DTA360 Diesel Eng.; w/ Air Susp.; Long Tail Pipe - Left Side Exit **(200444)**
- 87-93** 6 Cyl. Series "S"; 3600, 3700, 3800; DT/DTA360 Diesel Eng.; w/ Air Susp.; Long Tail Pipe - Right Side Exit

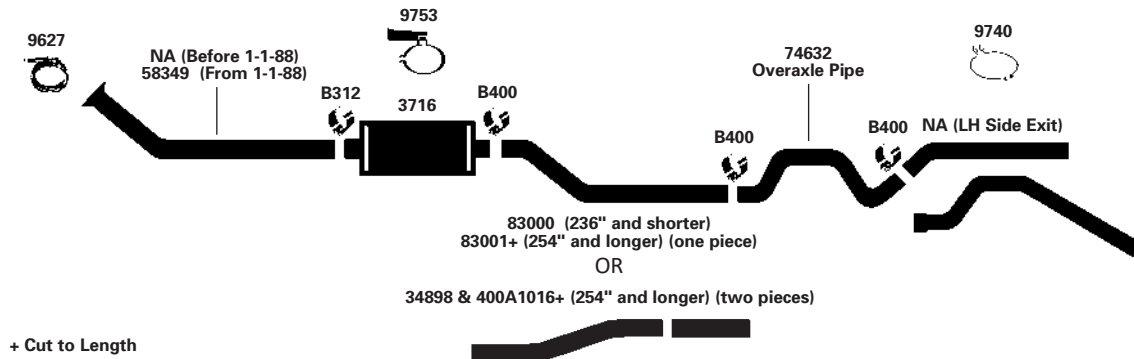

- 87-93** 6 Cyl. Series "S"; 3700, 3800; DT/DTA466 Diesel Eng.; w/ Mor-Ryde or Vari-Rate Susp.; exc. Allison MTB643 Auto. Trans.; Long Tail Pipe - Left Side Exit **(200445)**
- 87-93** 6 Cyl. Series "S"; 3700, 3800; DT/DTA466 Diesel Eng.; w/o Air Susp.; exc. Allison MTB643 Auto. Trans.; Long Tail Pipe - Right Side Exit

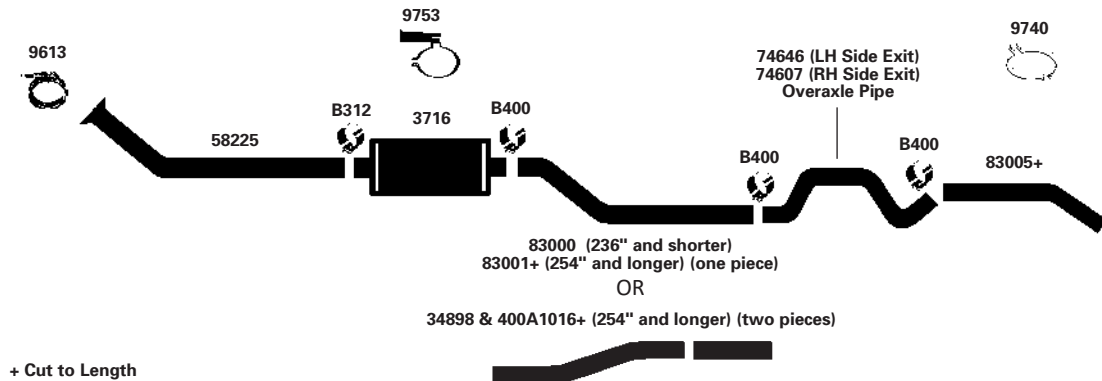

- 87-93** 6 Cyl. Series "S"; 3700, 3800; DT/DTA466 Diesel Eng.; w. Air Susp.; exc. Allison MTB643 Auto. Trans.; Long Tail Pipe - Right Side Exit **(200446)**
- 87-93** 6 Cyl. Series "S"; 3700, 3800; DT/DTA466 Diesel Eng.; w. Air Susp.; Long Tail Pipe - Left Side Exit

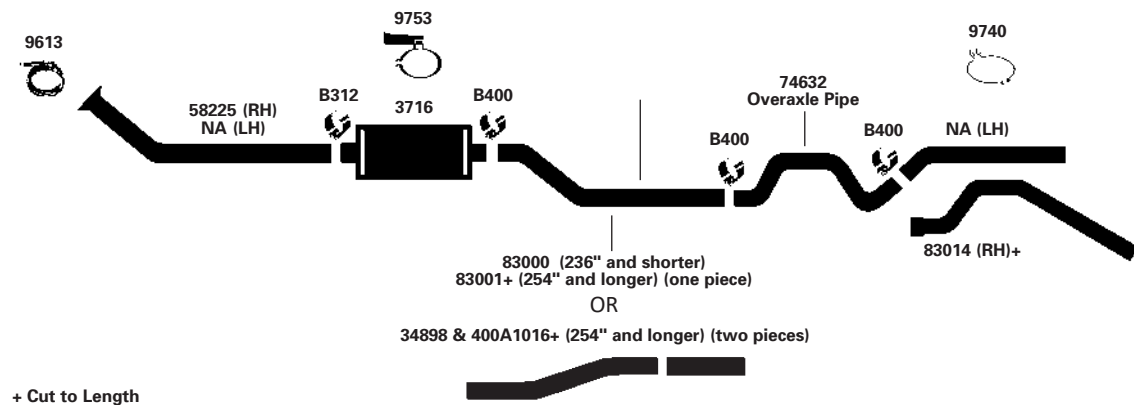

SCHOOL BUS APPLICATIONS

## NAVISTAR / INTERNATIONAL SCHOOL BUS

**80-89**    8 Cyl.    Model 1853; 9.0L Diesel Eng. **(200452)**  
**79-85**    8 Cyl.    Model 1723, 1823; MV404 Eng.

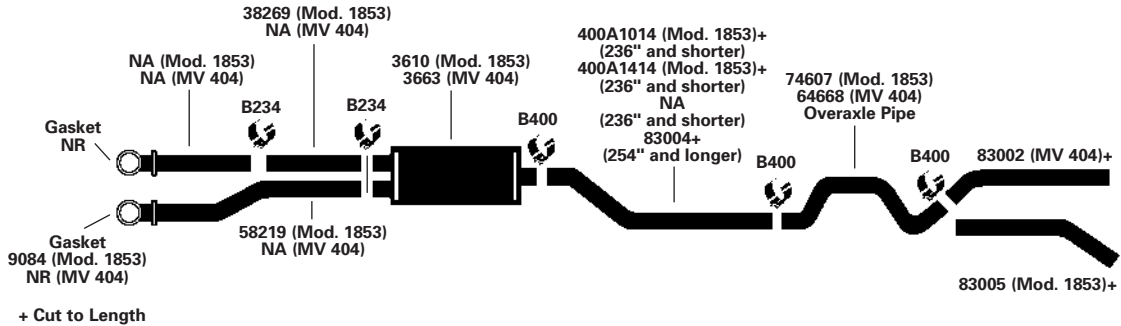

**83-88**    8 Cyl.    Series "S"; 6.9L Diesel Eng.; w/o Air Susp.; RH Mounted Tail Pipe **(200450)**  
**83-88**    8 Cyl.    Series "S"; 6.9L Diesel Eng.; w Air Susp.; RH Mounted Tail Pipe

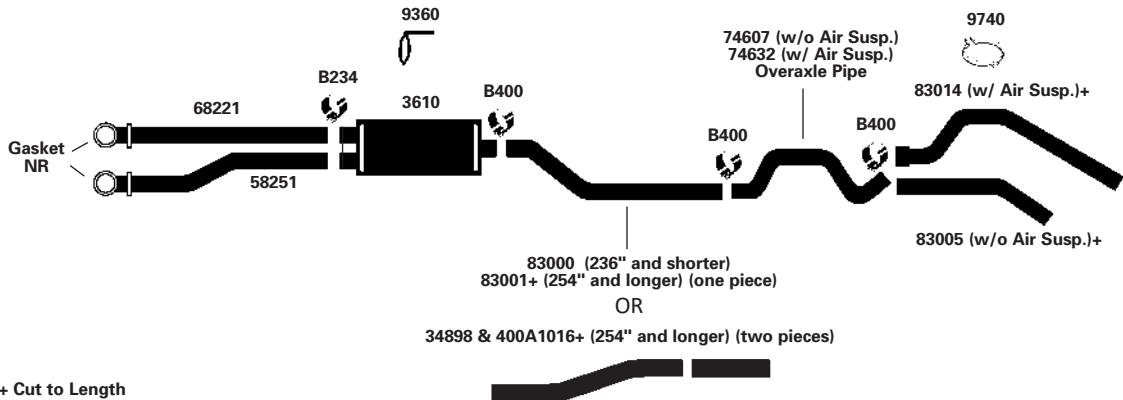

**83-88**    8 Cyl.    Series "S"; 6.9L Diesel Eng.; w/o Air Susp.; LH Mounted Tail Pipe **(200451)**  
**83-88**    8 Cyl.    Series "S"; 6.9L Diesel Eng.; w Air Susp.; LH Mounted Tail Pipe

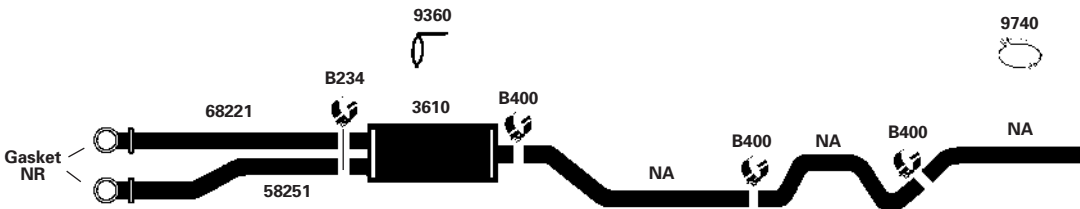

**80-87**    8 Cyl.    Model 1853; w/ 3208 Eng. **(200454)**

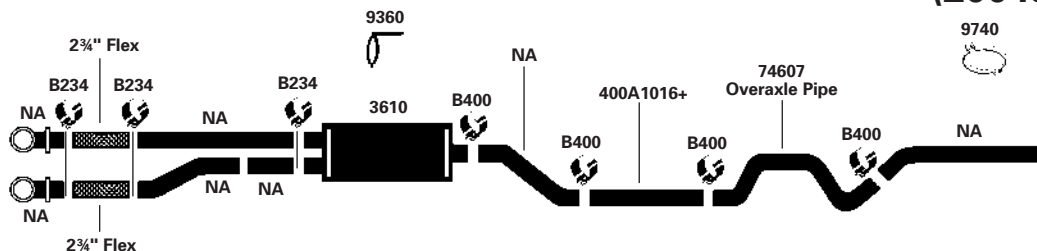



## NAVISTAR / INTERNATIONAL SCHOOL BUS

79-87 6 Cyl. Model 1853; DT466 Diesel Eng.

(200440)

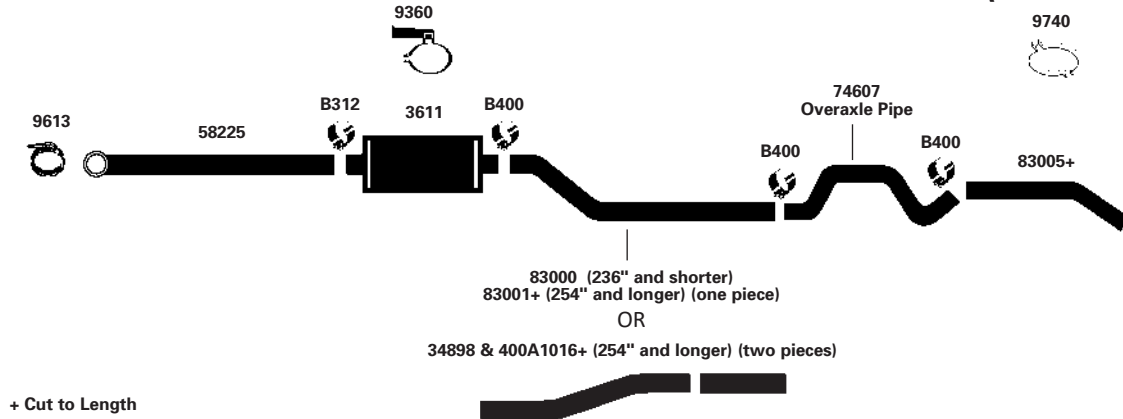

79-85 8 Cyl. Series "S"; 345, 392 Eng.

(200453)

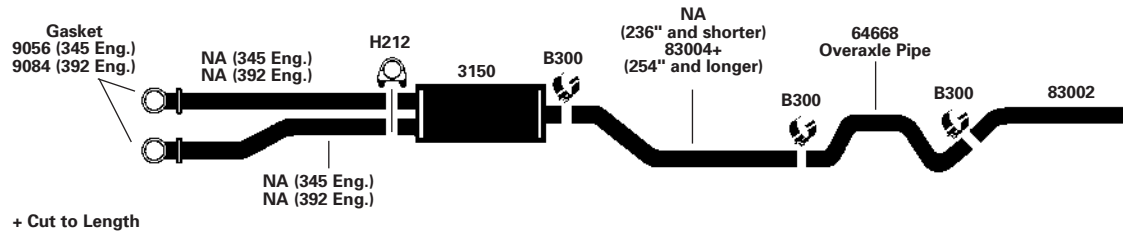

76-78 8 Cyl. Model 1853; w/ D170, D190 Eng.

(200455)

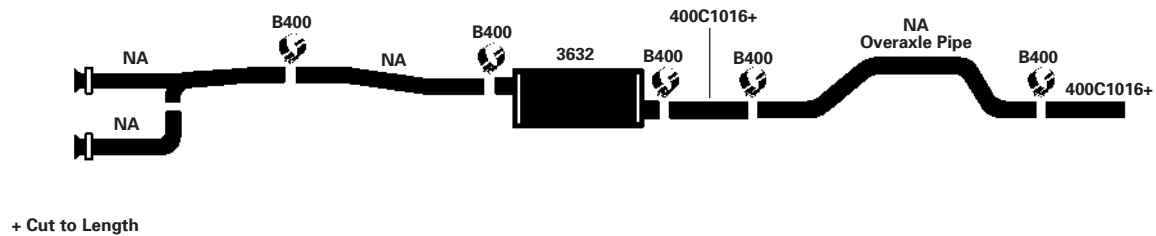

## NAVISTAR / INTERNATIONAL SCHOOL BUS

72-78 8 Cyl. All models w/ 406, 450, 501 C.I.D. Eng.; 151"-276" W.B.

(200457)

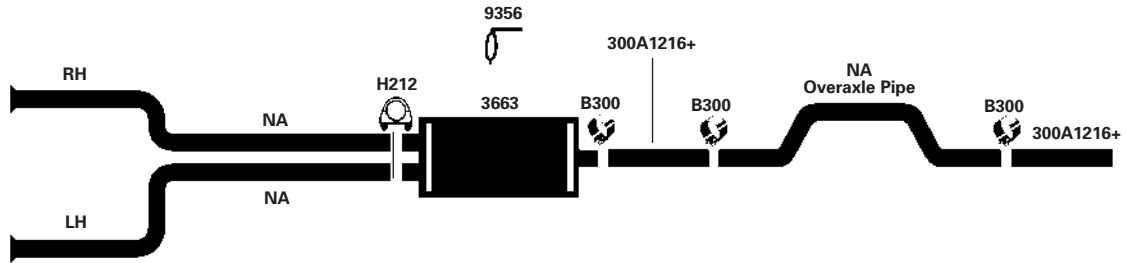

+ Cut to Length

71-78 8 Cyl. Loadstar; 304(62-78), 345, 392 Eng.

(200456)



+ Cut to Length

## THOMAS SCHOOL BUS

98-02 6 Cyl. Thomas MVP E-F, B-Series Cummins Engine Forward

(200491)

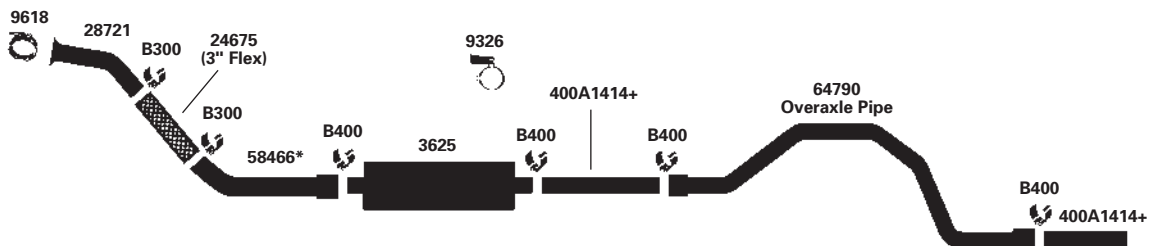

+ Cut to Length

See Page 146-147 for Air Ride Overaxles and Side Exit Tailpipe  
(100 gallon fuel tank use 2 piece Overaxle Pipes on page 187 for easy installation)

## THOMAS SCHOOL BUS

98-01 6 Cyl. Thomas Pusher 3126 Cat. Eng.

(200458)

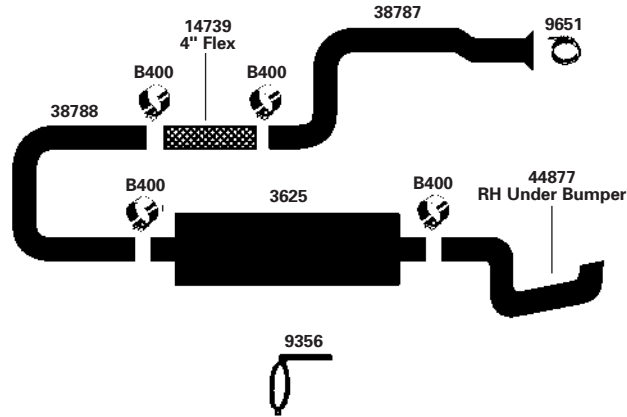

98-01 6 Cyl. Saf-T-Liner w/ 3126 Caterpillar Engine, 8.3L Cummins Engine

(200493)

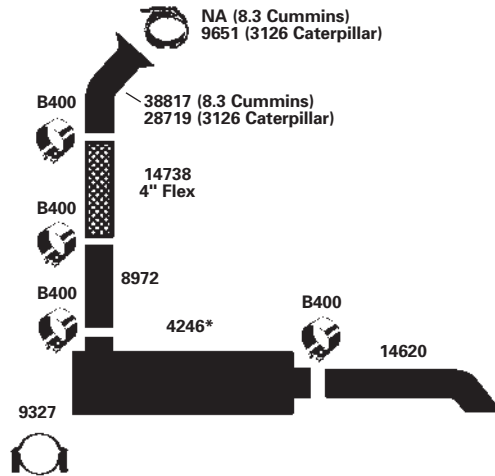

94-01 6 Cyl. Thomas MVP E-F, B-Series Cummins (Non-Catalytic Muffler)

(200461)

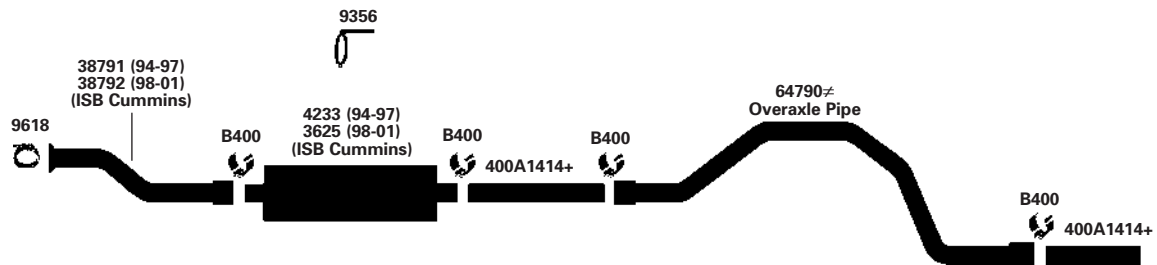

+ Cut to Length

See Page 146-147 for Air Ride Overaxles and Side Exit Tailpipe  
 ≠(100 gallon fuel tank use 2 piece Overaxle Pipes on page 187 for easy installation)

## THOMAS SCHOOL BUS

97-00 6 Cyl. Thomas MVP E-F, 3126 & C7, Caterpillar Engine Forward

(200492)

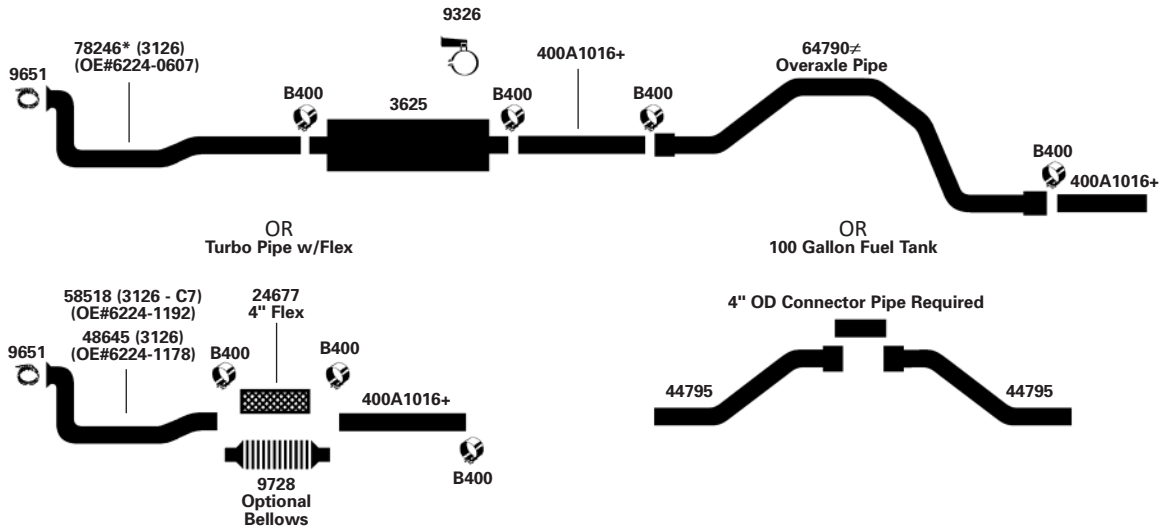

+ Cut to Length

See Page 146-147 for Air Ride Overaxles and Side Exit Tailpipe  
 ≠(100 gallon fuel tank use 2 piece Overaxle Pipes on page 187 for easy installation)

96-00 6 Cyl. Thomas Pusher 8.3 Cummins

(200459)

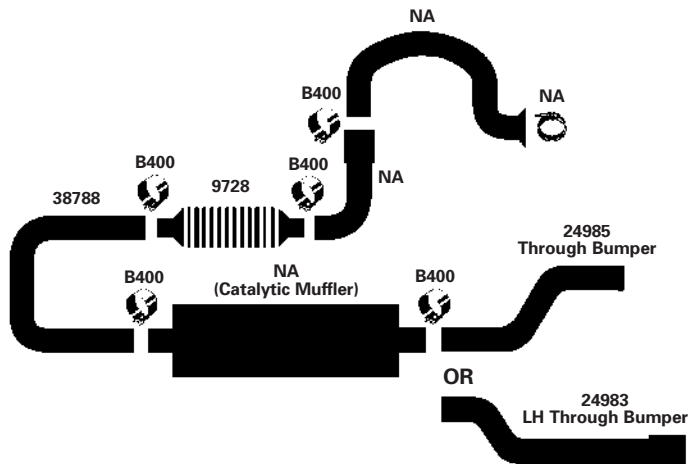

SCHOOL BUS APPLICATIONS

## THOMAS SCHOOL BUS

97-98 6 Cyl. MVP-ER Model; w/ 5.9L Cummins Turbo Diesel; Rear Eng.;  
RH Rear Exit Tail Pipe

(200462)

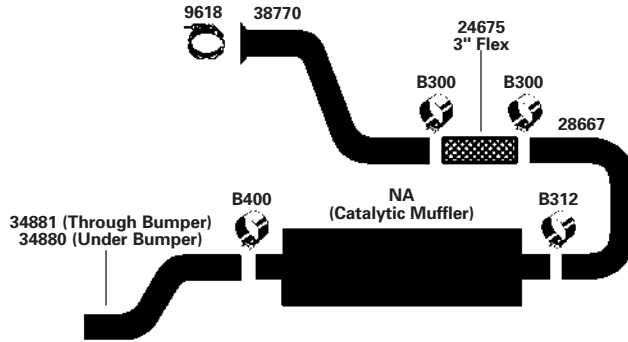

6 Cyl. MVP-ER Model w/ Cat. 3116 Turbo Diesel; Rear Eng.;  
RH Below Bumper Exit

(200463)

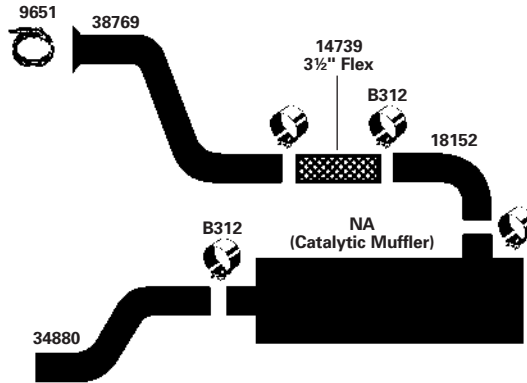

96-98 6 Cyl. Rear Engine Models w/ B-Series Cummins Engine w/ Standard Muffler

(200494)

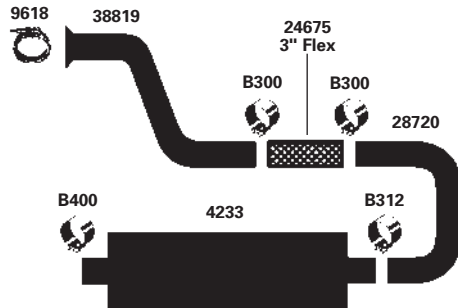

See Page 146-147 for Tailpipe Options

## THOMAS SCHOOL BUS

YEAR	CYL.	MAKE & MODEL	EXH. PIPE	MUFFLER	TAIL PIPE
92-95	8	MVP Model w/Cat. 3116 Turbo Diesel; Rear Eng.		3614	NA
90-93	8	Saf-T-Liner w/6V92 Rear Engine Model; Rear Exit Tail Pipe		3647	NA
89-93	8	All models w/Cummins 6BTA, 6CTA; Rear Eng.; Rear Exit Tail Pipe		3614	NA
89-93	8	Saf-T-Liner w/8.2L Turbo Diesel; Rear Eng. Model; Left Side Exit		3898	NA
89-93	8	Saf-T-Liner w/8.2L Turbo Diesel; Rear Eng. Model; Rear Exit Tail Pipe		3632	NA
84-91	8	Rear Engine Models w/Caterpillar 3208 Turbo Diesel Engine; Left Side Exit		3898	NA
84-91	8	Rear Engine Models w/Caterpillar 3208 Naturally Aspirated Diesel Engine; Left Side Exit		3898	NA
84-88	8	Saf-T-Liner; 3208 Caterpillar Diesel Eng (exec. Turbo); Rear Eng.; Rear Exhaust		3632	NA
84-91	8	Saf-T-Liner; 3208 Caterpillar Turbo Diesel Eng.; Rear Eng.; Rear Exhaust		3632	NA

## THOMAS PIPES

### PULLER OVERAXLE PIPES

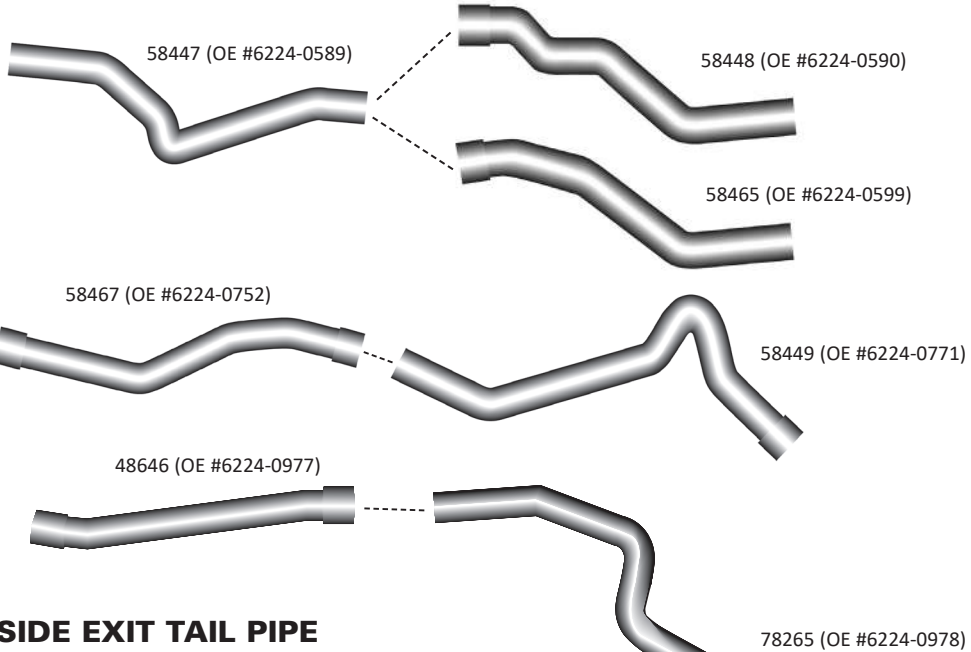

### MVP 4" SIDE EXIT TAIL PIPE

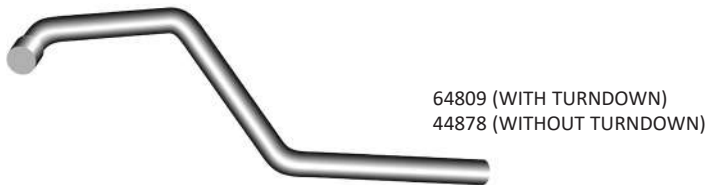

### MVP PUSHER - TAIL PIPE OPTIONS

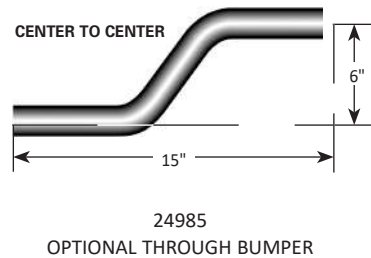
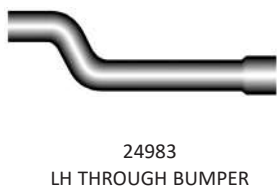
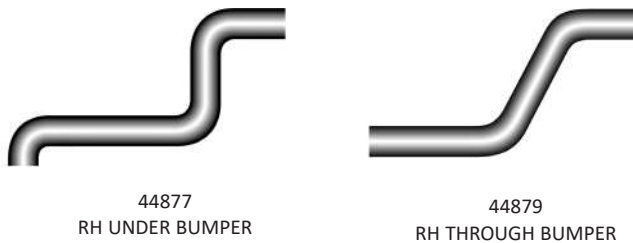

SCHOOL BUS APPLICATIONS

## THOMAS PIPES ////

**ALL MODELS – CONVENTIONAL & FLATNOSE TAIL PIPE OPTIONS**

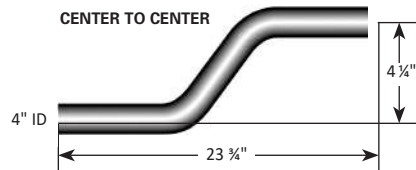

34901  
OPTIONAL THROUGH BUMPER

## SIDE EXIT PIPES ////

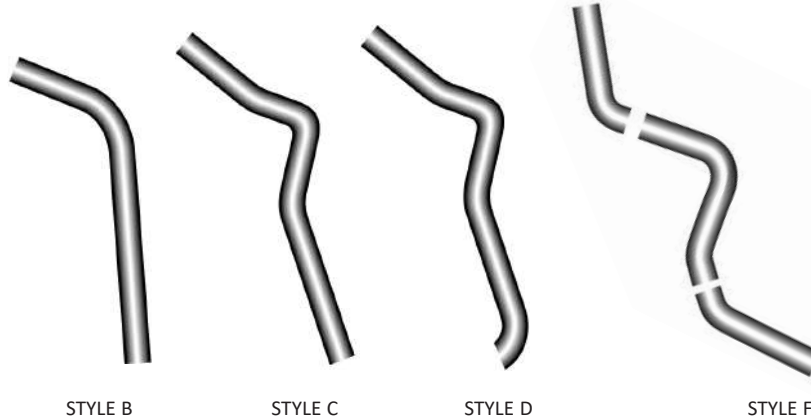

O.E./MAKE ENG. DESCRIPTION	OUTLET TYPE	PIPE O.D.		STYLE
		4"	5"	
3700 & 3800 Series S	w/o Turndown	44822	—	B
<b>45° LEFT SIDE EXIT APPLICATION</b>				
International	w/o Turndown	84559	—	C♣
	w/ Turndown	84584	—	D♣
<b>65° LEFT SIDE EXIT APPLICATION</b>				
98-02 Bluebird All-American	Angle Cut	—	74669*	C♣
Freightliner	w/o Turndown	(1) 34899* (2) 24998* (3) 34900* One Piece* Pipe 83052	—	F♣

♣ Installs over the drive train.



## UNIVERSAL OVER AXLE PIPES

### TWO-PIECE UNIVERSAL OVER AXLE PIPES

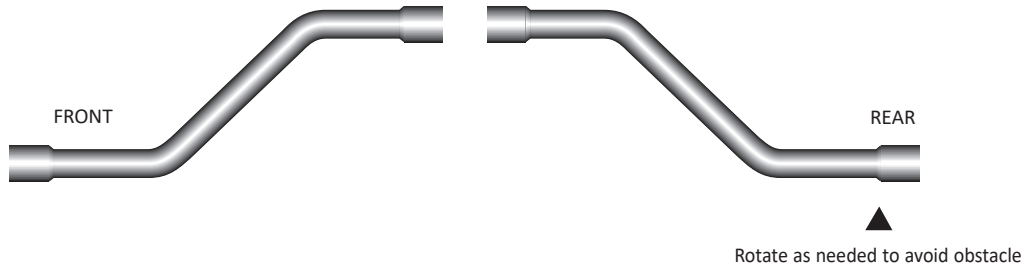

Cut rear pipe to proper length, insert into flared front pipe and clamp.

**NOTE:** on some installations a section of straight pipe may be required for proper clearance.

**FOLLOW THESE INSTALLATION TIPS:**

- A. Use two pipes of the same part number.
- B. Cut inlet end of rear pipe to give needed clearance and fit (See diagram).
- C. Join pipes together and secure with clamp.

The over axle pipe is best for school bus fleets. Four part numbers provide excellent coverage for most buses in operation.

One installation takes two over axle pipes of the same number. Less storage space.

By angling or rotating pipes (before you draw down clamps) you can avoid many under body obstacles (shocks, etc.). Easier installation. Also applicable to vans and other long wheel base trucks.

P/N	I.D.	LENGTH
44748	2 ½"	40"
44749	3"	40"
44795	4"	44 ½"

SCHOOL BUS APPLICATIONS

## ALLIS CHALMERS

P/N	APPLICATION	INLET LENGTH (A)	INLET I.D. (B)	SHELL LENGTH (C)	OUTLET LENGTH (D)	OUTLET O.D. (E)	O/A LENGTH (F)	WEIGHT LBS.
<b>3946</b>	B, C, & CA (exc. low octane engine) (1938-1957) – long muffler (vertical-round body. Shell dia. 3¼")	7"	1¾"	12¾"	9¼"	1½"	29"	5
<b>9896</b> <b>U112</b>	Rain Cap Inlet Clamp Replaces OEM: 70210081							
<b>3947</b>	WD (Gas) (1948-1953) (vertical-round body. Shell dia. 3¼")	2¼"	1⅝"	16½"	10¼"	1¾"	29"	5
<b>9897</b> <b>U158</b>	Rain Cap Inlet Clamp Replaces OEM: 70219534							
<b>3948</b>	7000 (s/n 8553 & up), 7010, 7020, 7030, 7040, 7050 & 7060 (all Diesel) – (1979-1981) (vertical-oval body. Shell 6" x 10")	4"	3"	32½"	11¾"	3"	48"	17
<b>9373</b> <b>H300</b>	Rain Cap Inlet Clamp Replaces OEM: 70268785, 70261975							
<b>3949</b>	200 (late), 7000 (to s/n 8553) (Diesel) 190 Diesel Turbo (vertical-round body. Shell Dia. 5¼")	3½"	3"	32½"	12"	3"	48"	16
<b>9373</b> <b>H300</b>	Rain Cap Inlet Clamp Replaces OEM: 70271755							

## ALLIS CHALMERS

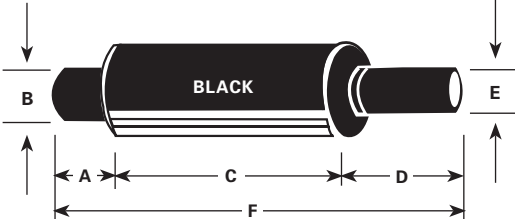
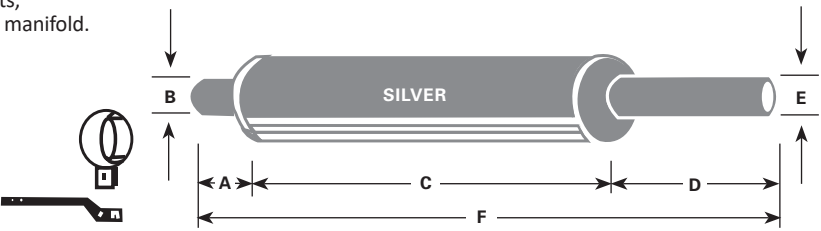
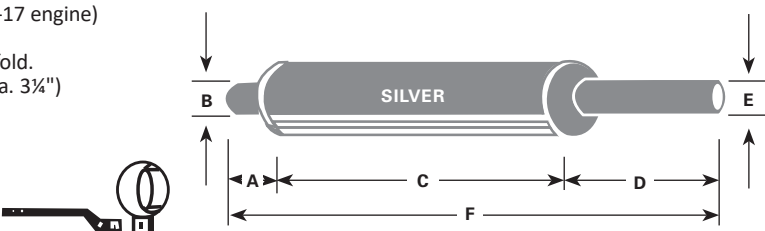
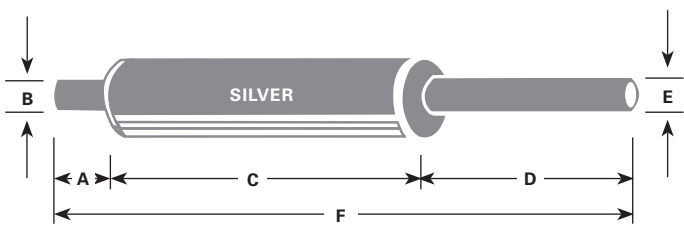
P/N	APPLICATION	INLET LENGTH (A)	INLET I.D. (B)	SHELL LENGTH (C)	OUTLET LENGTH (D)	OUTLET O.D. (E)	O/A LENGTH (F)	WEIGHT LBS.
3950		3"	2¼"	13"	2"	2½"	18¾"	4
	 <p style="text-align: center;">(vertical-round body. Shell 3¼") Replaces OEM: 701444</p>							
3951	B, C & CA (1938-1957) – thru hood D10, D12, D14 & D15 (Gas) – (to s/n 9001) <b>Note:</b> Includes brackets, (1)-to head bolt, (1)-to manifold. (vertical-round body. Shell dia. 3¼")	2½"	1⅜"	16½"	10"	1½"	29"	5
								
9896	Rain Cap Replaces OEM: 70233450, 70227240							
3952	WD45 (Gas) (1953-1957), W226 & G226, D17 (Gas & LP) – (to s/n 32000) Model CP 2 Cotton Picker (D-17 engine) <b>Note:</b> Includes brackets, (1)-to head bolt, (1)-to manifold. (vertical-round body. Shell dia. 3¼")	2½"	1⅝"	16½"	10"	1¾"	29"	7
								
9897	Rain Cap Replaces OEM: 70229531							
3953	D17 (Gas & LP) – (to s/n 32001-42000) D (Gas) combine Model CP 2 Cotton Picker (has different engine than D-17 engine) (vertical-round body. Shell dia. 4¼")	2½"	1⅝"	16½"	10"	1¾"	29"	7
								
9371 H200	Rain Cap Inlet Clamp Replaces OEM: 70234494							

## ALLIS CHALMERS

P/N	APPLICATION	INLET LENGTH (A)	INLET I.D. (B)	SHELL LENGTH (C)	OUTLET LENGTH (D)	OUTLET O.D. (E)	O/A LENGTH (F)	WEIGHT LBS.
4210	7000, 7020 w/ 301 Turbocharged Engine	4"	3½"	28"	10"	3⅝"	42"	
H312	Inlet Clamp (vertical-round body. Shell dia. 5⅝")							

## CASE

P/N	APPLICATION	INLET LENGTH (A)	INLET I.D. (B)	SHELL LENGTH (C)	OUTLET LENGTH (D)	OUTLET O.D. (E)	O/A LENGTH (F)	WEIGHT LBS.
3954	C, CC, CL, D, DC, DE, DL, DIM, DS & "4" (to 1954) (all Gas engine) 400 (Gas & Diesel) (1955-1957) 700 & 800 (Gas & Diesel) (1958-1959) (vertical-round body. Shell dia. 4¼")	3"	2¼"	17"	6"	2¼"	26"	6
9370 H214	Rain Cap Inlet Clamp Replaces OEM: A20494							
3955	730, 740, 830 & 840 (1960-1969) (Gas & Diesel) <b>Note:</b> Short muffler (vertical-round body. Shell dia. 5½")	5½"	2½"	17¼"	3¼"	2½"	26"	6
9372 H212	Rain Cap Inlet Clamp Replaces OEM: A24314							

## CASE

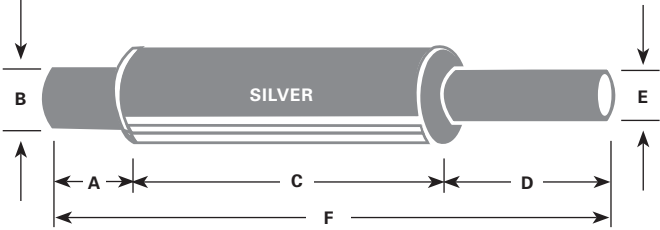
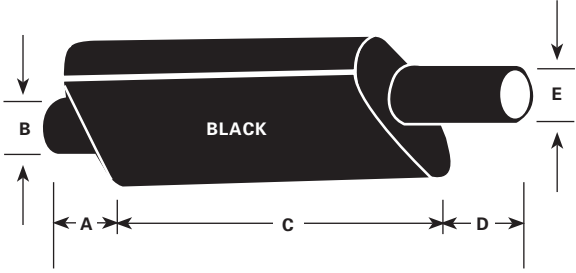
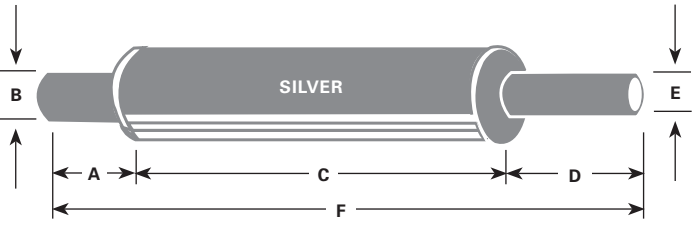
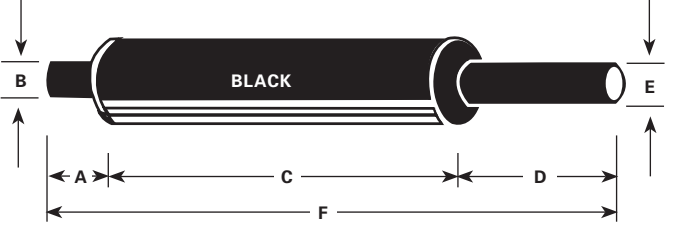
P/N	APPLICATION	INLET LENGTH (A)	INLET I.D. (B)	SHELL LENGTH (C)	OUTLET LENGTH (D)	OUTLET O.D. (E)	O/A LENGTH (F)	WEIGHT LBS.
<b>3956</b>	930 & 940 (Gas & Diesel) – (1960-1969), 930 CK (Diesel) & 1030 (Diesel) – (1960-1969) (vertical-round body. Shell dia. 5½")	3"	2¾"	17"	12"	2¾"	32"	9
								
<b>9378 H234</b>	Rain Cap Inlet Clamp Replaces OEM: T42286, A24103, A27105							
<b>3957</b>	470 & 570 – (1970-1973) 480 & 580 Industrial (1970 & up) (all above – Gas & Diesel) (vertical-oval body. Shell dia. 4½" x 9")	5½"	2½"	19"	8½"	2"	33"	13
								
<b>9371 H212</b>	Rain Cap Inlet Clamp Replaces OEM: A39561							
<b>3958</b>	V, VA, VAC & VC (Gas) (1953-1955) 200B, 300B, 400B & 500B (1957-1959), 300, 400, 500 & 600 (1953-1957) 310 & 350 (1954-1959) (vertical-round body. Shell dia. 3¾")	2¾"	1 <sup>15</sup> / <sub>16</sub> "	16¾"	9½"	2"	29"	5
								
<b>9371 H200</b>	Rain Cap Inlet Clamp Replaces OEM: VTA 2811, VTA 1135							
<b>3959</b>	200B, 210B, 211B (Gas) – (1957-1959), 300 (53-57), 300B, 310B, 311B (1957-1959), 410B (1957-1959) – (Gas & Diesel) 430 (Gas) (to s/n 8191147) – (1960-1962) (horizontal-round body. Shell dia. 3¾")	2¾"	1 <sup>5</sup> / <sub>8</sub> "	16¾"	3"	1¾"	22½"	4
								
<b>9897 U158</b>	Rain Cap Inlet Clamp Replaces OEM: G13032							

## CASE

P/N	APPLICATION	INLET LENGTH (A)	INLET I.D. (B)	SHELL LENGTH (C)	OUTLET LENGTH (D)	OUTLET O.D. (E)	O/A LENGTH (F)	WEIGHT LBS.
<b>3961</b>	530, 630, 640 & 641 (Gas & Diesel) (1960-1969) (vertical-round body. Shell dia. 4¼")	7½"	2½"	17"	4½"	2½"	29"	7
<b>9372 H212</b>	Rain Cap Inlet Clamp Replaces OEM: G45239							
<b>4210</b>	1170, 1175, 1270, 1370 w/ 451 C.I.D. w/ Turbocharger (V)	4"	3½"	28"	10"	3⅝"	42"	
<b>H312</b>	Inlet Clamp (vertical-round body. Shell dia. 5⅝") Replaces OEM: A64990							

## COCKSHUTT

P/N	APPLICATION	INLET LENGTH (A)	INLET I.D. (B)	SHELL LENGTH (C)	OUTLET LENGTH (D)	OUTLET O.D. (E)	O/A LENGTH (F)	WEIGHT LBS.
<b>3962</b>	770 (Gas & Diesel), 1600 (Gas & Diesel), 1550 (Gas & Diesel) & 1650 (Gas) (vertical-round body. Shell dia. 4¼")	2½"	2⅜"	20"	7"	2½"	29"	8
<b>9372 H212</b>	Rain Cap Inlet Clamp Replaces OEM: 164079A, 166486A							

## DEERE COMBINES

P/N	APPLICATION	INLET LENGTH (A)	INLET I.D. (B)	SHELL LENGTH (C)	OUTLET LENGTH (D)	OUTLET O.D. (E)	O/A LENGTH (F)	WEIGHT LBS.
<b>3963</b>	55 Diesel – HA232 – (s/n 46801-60000) 95 Gas – HB317, HD217 or HG217 (s/n 9000 & up) 105 Gas – HA248 – (all s/n) (horizontal-round body. Shell dia. 5½")	2½"	3¼"	15"	7"	2½"	22½"	7
<b>H314</b>	Inlet Clamp Replaces OEM: AH11014H							

## DEERE

P/N	APPLICATION	INLET LENGTH (A)	INLET I.D. (B)	SHELL LENGTH (C)	OUTLET LENGTH (D)	OUTLET O.D. (E)	O/A LENGTH (F)	WEIGHT LBS.
<b>3964</b>	1020, 1520, 1530, 2030, 2630, 2040, 2640 (s/n 341000 & up) (all Gas & Diesel) <b>Note:</b> Inlet is flared; uses special clamp not available at DIESELTECH. (OEM clamp is T19978) (vertical-oval body. Shell dia. 4¾" x 9")	3½"	Flared	19½"	7¾"	2"	30"	12
<b>9371</b>	Rain Cap Replaces OEM: AT21689, AT64102							
<b>3965</b>	3010 (Gas & LP) – (Diesel – to s/n 1T 6643) 3020 (Gas & LP), 4010 (Gas & LP) – (Diesel – to s/n 2T 7026) 4020 & 4000 (Gas & LP) <b>Note:</b> See 3966 for round body muffler with flared inlet (vertical-round body. Shell dia. 6")	3"	2¼ <sup>15</sup> / <sub>16</sub> "	20"	3"	2 <sup>5</sup> / <sub>8</sub> "	26"	10
<b>9378</b> <b>H300</b>	Rain Cap Inlet Clamp Replaces OEM: AR26640, AR26786							

## DEERE

P/N	APPLICATION	INLET LENGTH (A)	INLET I.D. (B)	SHELL LENGTH (C)	OUTLET LENGTH (D)	OUTLET O.D. (E)	O/A LENGTH (F)	WEIGHT LBS.
<b>3966</b>	3020 (Diesel) – (to s/n 122999) 4010 (Diesel) – (to s/n 2T 7027 & up) 4020 (Diesel) – (to s/n 200999) <b>Note:</b> Inlet is flared, uses special clamp 9890. Available from DIESELTECH; (OEM R32235 & AR46323) (vertical-round body. Shell dia. 6")	3"	2 <sup>15</sup> / <sub>16</sub> "	20"	3"	2 <sup>5</sup> / <sub>8</sub> "	26"	11

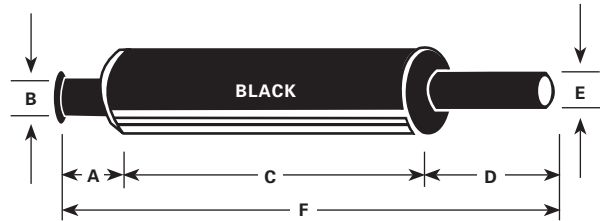

**9378** Rain Cap  
NA  
Inlet Clamp  
Replaces OEM: AR30189, AR30190

<b>3967</b>	Model A, AR, AN, AW & AWH (33-52) Model G, GN, GH & GW (38-53) (Gas & all fuel) - (to s/n 410000 & up) Model 60, 620, 70, 720 (Gas & all fuel) Original equipment standard muffler. <b>Note:</b> 3967 has a 4-bolt mounting plate. 3967 can sub for #'s AA300R, AA4371R and AA5096R (vertical-round body. Shell dia. 3¾")	NA	B-Plate	23"	1"	2½"	24½"	5
-------------	--	----	---------	-----	----	-----	------	---

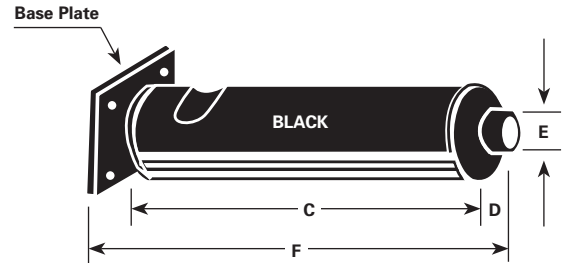

Replaces OEM: AF3770R & AA2214R

<b>3968</b>	Model B, BN & BW (Gas & all fuel) – (to s/n B96000 & up) Model 50, 520 (standard muffler) & 530 (optional muffler) (1953-1959) Application note: 3968 has a 4-bolt mounting plate (vertical-round body. Shell dia. 3¾")	4½"	B-Plate	14½"	5"	2¼"	24½"	5
-------------	---	-----	---------	------	----	-----	------	---

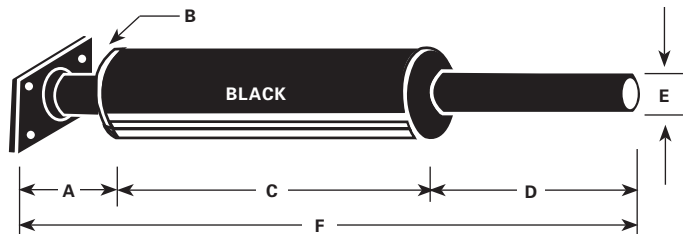

**9371** Rain Cap  
Replaces OEM: R21827R, AB2700R



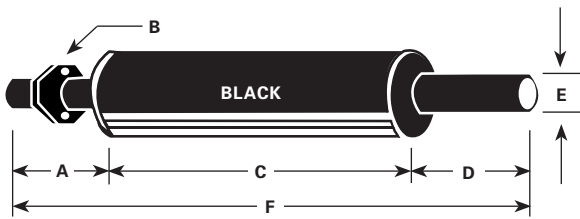
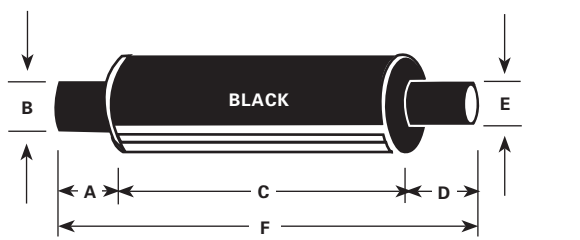
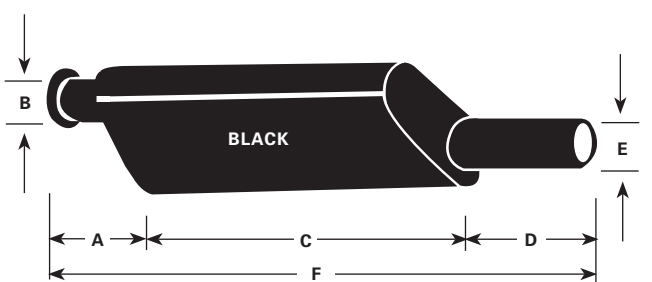

## DEERE

P/N	APPLICATION	INLET LENGTH (A)	INLET I.D. (B)	SHELL LENGTH (C)	OUTLET LENGTH (D)	OUTLET O.D. (E)	O/A LENGTH (F)	WEIGHT LBS.
<b>3969</b>	M, MT, MC & MI (1947-1952) 40 (all 53-56), 320 & 330 (57-59) Application note: 2 bolt-flange mount; 1 <sup>7</sup> / <sub>8</sub> " OD (vertical & horizontal round body. Shell dia. 3 <sup>3</sup> / <sub>4</sub> ")	3 <sup>3</sup> / <sub>4</sub> "	1 <sup>3</sup> / <sub>4</sub> "	14 <sup>1</sup> / <sub>2</sub> "	3 <sup>3</sup> / <sub>4</sub> "	2"	21"	5
								
<b>9371</b>	Rain Cap Replaces OEM: AM364T, AM625T							
<b>3970</b>	320, 330 & 420 (Gas) – (to s/n 135025 & up) 430 & 440 (Gas), 435 (Diesel) – (to s/n 442886 & up) (1957-1959) 1010 (Gas) (all types with vertical exhaust) (vertical-round body. Shell dia. 4 <sup>1</sup> / <sub>4</sub> ")	2 <sup>1</sup> / <sub>4</sub> "	2"	12 <sup>1</sup> / <sub>4</sub> "	3"	2"	17 <sup>1</sup> / <sub>2</sub> "	4
								
<b>9371 H200</b>	Rain Cap Inlet Clamp Replaces OEM: AT10646T, AM3101T							
<b>4200</b>	John Deere Tractor 4030, 4040, 4050, 4250, 4320, 4440, 4450, 4520, 4620, 4630, 4640, 4840, 7020 (vertical-oval body. Shell dia. 4 <sup>5</sup> / <sub>8</sub> " x 8 <sup>3</sup> / <sub>8</sub> ")  Replaces OEM: RE20224	7 <sup>7</sup> / <sub>8</sub> "	4 <sup>3</sup> / <sub>8</sub> ">	33"	4 <sup>1</sup> / <sub>8</sub> "	3 <sup>5</sup> / <sub>8</sub> "	38"	
								> Flared

## FORD/NEW HOLLAND

P/N	APPLICATION	INLET LENGTH (A)	INLET I.D. (B)	SHELL LENGTH (C)	OUTLET LENGTH (D)	OUTLET O.D. (E)	O/A LENGTH (F)	WEIGHT LBS.
<b>3971</b>	801-901 (58-62), 4000 series (61-64), & 1801 (58-60) with 172 cid Gas & Diesel. 501, 601, 701 (58-62), 2000 series (63-64) with 144 cid Diesel 4000 (65-75), 3600 & 4600 (75-81) 3 cyl. Diesel All Orchard & Narrow (horizontal-round body. Shell dia. 3½")	2"	2"	13½"	2"	1⅞"	17½"	3
<b>H200 U178</b>	Inlet Clamp Outlet Clamp Replaces OEM: 310079							
<b>3972</b>	2000, 3000, 4000 & 5000 (68 & up) 3 cyl & 4 cyl Gas & Diesel (vertical-round body. Shell dia. 5½")	4½"	1⅞"	17"	7½"	2"	29"	7
<b>9371 U178</b>	Rain Cap Inlet Clamp Replaces OEM: C7NN 5230Z, C7NN 5230AB, C7NN 5230AC							

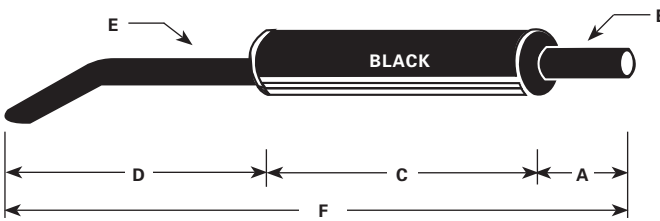
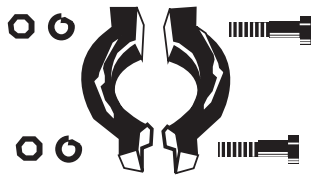
## FORD/NEW HOLLAND

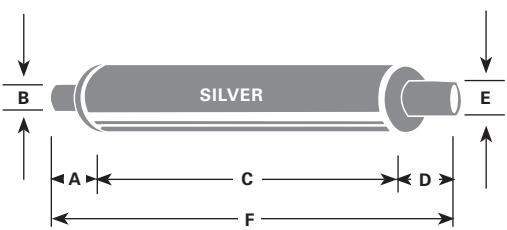
P/N	APPLICATION	INLET LENGTH (A)	INLET I.D. (B)	SHELL LENGTH (C)	OUTLET LENGTH (D)	OUTLET O.D. (E)	O/A LENGTH (F)	WEIGHT LBS.
7660	550, 555, 555A, 555B & 655 (75-78) Industrial Tractor/Loader/Backhoe <b>Note:</b> In some special applications can replace 3972 also. (horizontal-round body. Shell dia. 5 1/2")	3 3/4"	1 7/8"	27"	23 1/4"	Bent Pipe	55"	16
U178	Inlet Clamp Replaces OEM: D6NN 5230F							
7661	9N, 2N & 8N (1939-1952) – (Gas) <b>Note:</b> Welded one piece assembly, with flared inlet. See separate listing for details on inlet clamp.	Flared	15 1/2"	56"	1 1/2"			6
Special Inlet Clamp 9894	 <p>Replaces OEM: 8N5230 Muffler &amp; Pipe</p>							
3973	NAA (53-54), 600 & 700 (55-57), 501, 601 & 701 (58-62), 2000 series (63-64) with 134 cid (Gas) 800 & 900 (55-57) with 172 cid (Gas) (horizontal-round body. Shell dia. 3 1/4")	2 1/4"	1 5/8"	13"	2 1/4"	1 5/8"	17 1/2"	4
U158 U158	Inlet Clamp Outlet Clamp Replaces OEM: NAA 5230E							

## FORD/NEW HOLLAND

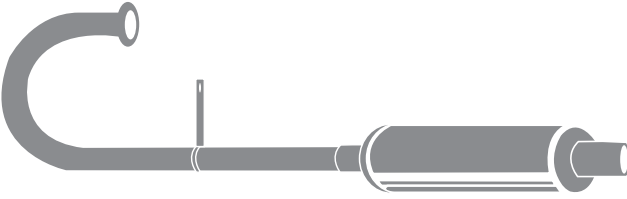
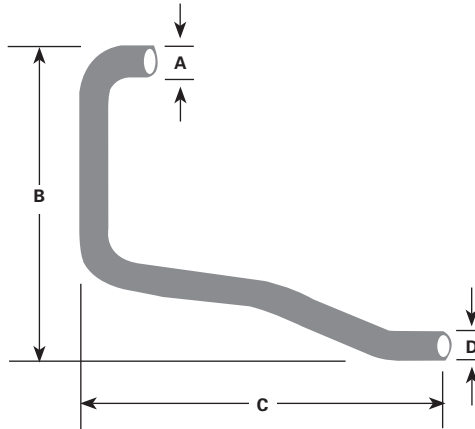
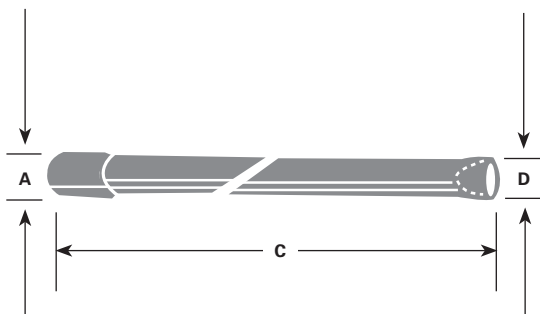
P/N	APPLICATION	ASSEMBLY SPECIFICATIONS				WEIGHT
		INLET I.D.	VERT. LENGTH	OVERALL LENGTH	OUTLET O.D.	LBS.
7662	9N, 2N & 8N (1939-1952) – (Gas) <b>Note:</b> Welded one piece assembly, with flared inlet, requires special inlet clamp 9894, see clamps page 279.	Flared	29"	30½"	1½"	7
<b>Special Inlet Clamp</b>						
9894	No OEM number					
38756	600 (55-57), 601 (58-62), 2000 series (63-64); 134 cid (Gas) 800 & 900 (55-57); 172 cid (Gas) (All models except row crop) <b>Note:</b> Used with 3973 muffler and 54121 tail pipe. (horizontal outlet pipe) – from muffler to tail pipe	1½"	17"	32"	1½"	3
<b>U112</b>	Inlet Clamp Replaces OEM: NCA 5255B					
54121	NAA (53-54), 600 & 700 (55-57), 501 (59-62), 601 & 701 (58-62), 2000 series (63-64) w/ 134 cid (Gas) (all transmissions except Select-O-speed) <b>Note:</b> Used with 38756, above (horizontal tail pipe) – from outlet pipe to rear.	1½"	NA	54"	1½"	3
<b>U112</b>	Inlet Clamp Replaces OEM: NCA 5263B					

## FORD/NEW HOLLAND

P/N	APPLICATION	INLET LENGTH (A)	INLET I.D. (B)	SHELL LENGTH (C)	OUTLET LENGTH (D)	OUTLET O.D. (E)	O/A LENGTH (F)	WEIGHT LBS.
<b>3997</b>	501, 600, 700, 800 1801 (58-64) (horizontal-round body. Shell dia. 3¾")	1½"	2"	15"	2¼"	17⁄8"	17¼"	
<b>H200 9371</b>	Inlet Clamp Rain Cap Replaces OEM: 310079	<p>A technical diagram of a horizontal cylindrical rain cap. It features a central shell labeled 'SILVER'. Dimension lines indicate: A (inlet length), B (inlet inner diameter), C (shell length), D (outlet length), E (outlet outer diameter), and F (overall length). The inlet is on the left and the outlet is on the right.</p>						
<b>4203</b>	7000, 7100, 7200, 7600, 7610, 7700, 7710 (vertical-oval body. Shell dia. 4¼" x 9")	3¾"	2¾"	26¼"	19"	2½"	49"	
<b>H212 9372</b>	Inlet Clamp Rain Cap Replaces OEM: D5NN 5230F	<p>A technical diagram of a vertical cylindrical rain cap. The shell is labeled 'BLACK'. Dimension lines indicate: A (inlet length), B (inlet inner diameter), C (shell length), D (outlet length), E (outlet outer diameter), and F (overall length). The inlet is on the left and the outlet is on the right.</p>						
<b>4204</b>	2910, 3910, 4110 (81-85), 531, 4610 (81-82), 548 (78-82), 515, 531, 535, 4000, 4100, 4600, 5600, 5700, 6600, 6700 w/ Cab 67 (vertical-round body. Shell dia. 4¼")	6"	17⁄8"	26"	8¼"	2"	40¾"	
<b>U178</b>	Inlet Clamp Replaces OEM: E4NN5230GB17M	<p>A technical diagram of a vertical cylindrical rain cap with a tapered outlet. The shell is labeled 'SILVER'. Dimension lines indicate: A (inlet length), B (inlet inner diameter), C (shell length), D (outlet length), E (outlet outer diameter), and F (overall length). The inlet is on the left and the outlet is on the right.</p>						

## NAVISTAR / INTERNATIONAL

P/N	APPLICATION	INLET LENGTH (A)	INLET I.D. (B)	SHELL LENGTH (C)	OUTLET LENGTH (D)	OUTLET O.D. (E)	O/A LENGTH (F)	WEIGHT LBS.
<b>3974</b>	Farmall Cub – Standard (not Lo-Boy) (vertical-round body. Shell dia. 3 3/4")	2 3/4"	1 3/8"	12 1/2"	6 3/4"	1 1/2"	22"	5
<b>9896 U112</b>	Rain Cap Inlet Clamp Replaces OEM: 351436R92							
<b>3975</b>	Farmall H, Super H, M, Super M, MD, Super MD, Super MTA. Also International W-4, S-W4, W6, S-W6, WD6 & S-WD6. (Gas & Diesel) Farmall 300 & 350 (C-175 Gas) Farmall 400 & 450 (C-281 Gas & D281 Diesel), Farmall 460 & International 606 (C-221 Gas & D-236 Diesel), Farmall 560 (C-263 Gas & D-282 Diesel) (vertical-round body. Shell dia. 6")	2 1/2"	2 3/8"	13"	14"	2 1/2"	29"	8
<b>9372 H200</b>	Rain Cap Inlet Clamp Replaces OEM: 350601R95, 370773R91, 403551R1 (universal OEM muffler)							
<b>3976</b>	706 (D-310 Diesel) Note: This is original style muffler (vertical-round body. Shell dia. 5 1/2")	3"	2 3/8"	17"	14"	2 1/2"	34"	8
<b>9372 H212</b>	Rain Cap Inlet Clamp Replaces OEM: 384346R91							
<b>3977</b>	706 (C-263 Gas) & 806 (C-301 Gas & D-361 Diesel) (vertical-round body. Shell dia. 5 1/2")	3 1/2"	2 15/16"	17"	14"	3"	34"	8
<b>9373 H300</b>	Rain Cap Inlet Clamp Replaces OEM: 384345R1, 384345R91							

## NAVISTAR / INTERNATIONAL

P/N	APPLICATION	INLET LENGTH (A)	INLET I.D. (B)	SHELL LENGTH (C)	OUTLET LENGTH (D)	OUTLET O.D. (E)	O/A LENGTH (F)	WEIGHT LBS.
<b>3978</b>	Farmall 544 (C-200 Gas & D-239 Diesel) (vertical-round body. Shell dia. 5 1/2")	2 1/2"	2 3/8"	14 1/2"	11 1/4"	2 1/2"	29"	5
<b>9372 H212</b>	Rain Cap Inlet Clamp Replaces OEM: 370664R1							
<b>3979</b>	706 (C-263 & C-29 Gas/LP), 756 & (C-291 Gas/LP), 856 (C-301 Gas/LP) (vertical-round body. Shell dia. 6")	4"	2 15/16"	19 1/2"	10 1/2"	3"	34"	10
<b>9373 H300</b>	Rain Cap Inlet Clamp Replaces OEM: 398511R1							
<b>3980</b>	Tractor models: 102, 104, 105, 106, 107, 122, 123, 125, 126 & 127 (using Kohler 10 & 12 hp 1 cyl. Engines) (horizontal-round body. Shell dia. 3 1/4")	1 3/4"	1 5/16"	12 1/2"	2 1/2"	1 5/16"	15"	2.5
Replaces Case-IHC OEM: 393840R91								
<b>3981</b>	Farmall A, Super A, B, BN, C & Super C (1939-1954) Farmall 100, 130, 140, 200, 230 & 240 (C-123 Gas) Farmall 330 & 340 (C-135 Gas) International 330 & 340 (Utility C-135 Gas). Also T-340 Crawler (C-135 Gas) (vertical-round body. Shell dia. 4 1/4")	2 3/4"	1 15/16"	17"	9 1/4"	2"	29"	6
<b>9371 H200</b>	Rain Cap Inlet Clamp Replaces OEM: 360720R91, 360720R92							

## NAVISTAR / INTERNATIONAL

P/N	APPLICATION	INLET LENGTH (A)	INLET I.D. (B)	SHELL LENGTH (C)	OUTLET LENGTH (D)	OUTLET O.D. (E)	O/A LENGTH (F)	WEIGHT LBS.
<b>3982</b>	Farmall H & International W-4 (with C-152 Gas) Super H & Super W-4 (with C-164 Gas) Farmall 300 & 350 (C-169 & C-175 Gas) <b>Note:</b> This is original style muffler, OEM style subs to 3975. (vertical-round body. Shell dia. 5 1/2")	2 1/2"	2 3/8"	14 1/2"	11 1/4"	2 1/2"	29"	6
<b>9372</b> <b>H212</b>	Rain Cap Inlet Clamp Replaces OEM: 350600R95, 350660R95							
<b>3998</b>	Cub Cadet Tractor 1000, 1200, 1250, 1450, 1650 (horizontal-round body. Shell dia. 5")	1 1/4"	1 3/8"	12 3/8"	1 1/4"	1 3/8"	12 3/8"	
<b>9896</b> <b>U158</b>	Rain Cap Inlet Clamp Replaces OEM: 106337C4							
<b>4201</b>	340, 540 Diesel Underslung 460, 540, 544, 560, 606, 656, 660, 664 Underslung (horizontal-round body. Shell dia. 4 1/4")	2 1/2"	1 7/8"	17 1/2"	2 1/2"	1 7/8" I.D.	22 1/2"	
<b>H200</b>	Inlet Clamp Replaces OEM: 371039R91							

## NAVISTAR / INTERNATIONAL HARVESTER COMBINE

<b>4202</b>	1460 S.P., 1470 Hillside, 1480 S.P. (vertical-round body. Shell dia. 6 3/8")	2 1/2"	3 3/4"	27 1/2"	2 1/2"	4"	27 1/2"	
<b>9375</b> <b>H312</b>	Rain Cap Inlet Clamp Replaces OEM: 131086C91							



## MASSEY FERGUSON

P/N	APPLICATION	ASSEMBLY SPECIFICATIONS				WEIGHT
		INLET I.D.	VERT. LENGTH	OVERALL LENGTH	OUTLET O.D.	LBS.
<b>7663</b>	MF-35 MH-35 & TO-35 Ag. MF-202, 203, 204 & 205 (Gas & Diesel) Utility Tractors <b>Note:</b> Complete assembly includes muffler, inlet pipe, and clamp.	3-bolt	20"	54"	1½"	9

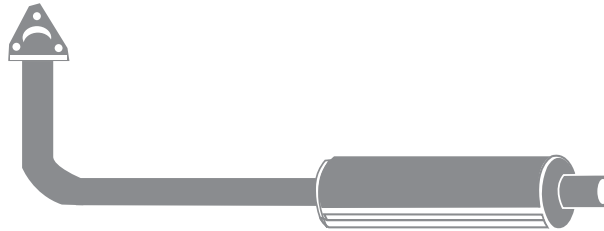

Replaces OEM:  
 505545M91 (muffler)  
 181600M91 (pipe)

<b>7442</b>	TO-20 & TO-30 Gas (1948-1957) <b>Note:</b> Pipe has flared inlet. Requires special inlet clamp 9895, see clamps Page 279.	Flared	18"	57"	1½"		7
-------------	---	--------	-----	-----	-----	--	---



Replaces OEM:  
 505545M91 (muffler)  
 181860M91 (pipe)

P/N	APPLICATION	INLET LENGTH (A)	INLET I.D. (B)	SHELL LENGTH (C)	OUTLET LENGTH (D)	OUTLET O.D. (E)	O/A LENGTH (F)	WEIGHT LBS.
<b>3983</b>	MF-35 (1960-1964) (Gas & Diesel) MF-35 (1964-1974) (Gas & Diesel) MF-202, 203, 204, 205 (Gas & Diesel) Utility tractors. <b>Note:</b> 3983 is used as both vertical & horizontal for these tractor applications. (round body. Shell dia. 4¼")	3"	17/8"	17"	14½"	2"	34"	6

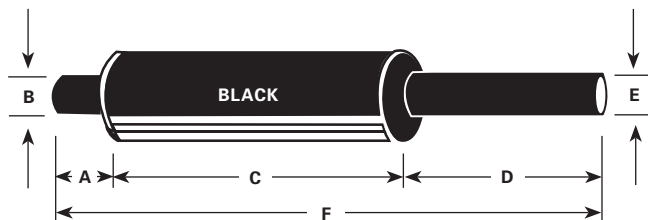

**9371**  
**U178**  
 Rain Cap  
 Inlet Clamp  
 Replaces OEM: 181867M91

## MASSEY FERGUSON

P/N	APPLICATION	INLET LENGTH (A)	INLET I.D. (B)	SHELL LENGTH (C)	OUTLET LENGTH (D)	OUTLET O.D. (E)	O/A LENGTH (F)	WEIGHT LBS.
3984	Ferguson F-40 & MF-50 (57-64) (Gas & LP) <b>Note:</b> Use for both horizontal & vertical applications (round body. Shell dia. 3 1/4")	2 1/2"	1 15/16"	15 1/2"	2"	1 3/8"	18 1/2"	4
H200 U112	Inlet Clamp Outlet Clamp Replaces OEM: 182609M91							
3985	Massey Harris (1942-1957) (Gas & Diesel). 20, 20K, 22, 22K (exc. 1948), 30, 30K, 33, 333, 44, 44SPL, 44D, 44K, 446, 444, 81, 82, 101Jr., 101Sr. & 102Sr. (horizontal-round body. Shell dia. 4 1/4")	2"	2 3/8"	14"	5"	2 1/2"	21"	4
9372 H212	Rain Cap Inlet Clamp Replaces OEM: 32289A & 767994M91							
3986	TE-20, TO-20 & TO-30 (1948-1954) TO-35 & MF-35 (1955-1963) (Gas & Diesel) MF-135 (1964-1974) (Gas & Diesel) (horizontal-round body. Shell dia. 3 1/4")	2 1/2"	1 1/2"	23"	8 1/2"	1 1/2" I.D.	34"	4
U112 U112	Inlet Clamp Outlet Clamp Replaces OEM: 180364M91, 505545M92							
3987	MF-165, MF-175 & MF-180 (Gas & Diesel) (Perkins 4-236 & 4-248 cid) <b>Note:</b> This muffler is for tractors with loaders. See also 3988. (vertical-round body. Shell dia. 4 1/4")	10"	2 1/8"	16 1/2"	13"	Bent Pipe	40"	7
H214	Inlet Clamp Replaces OEM: 194431M91							

## MASSEY FERGUSON

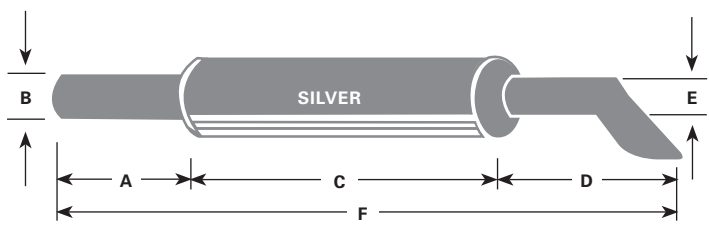
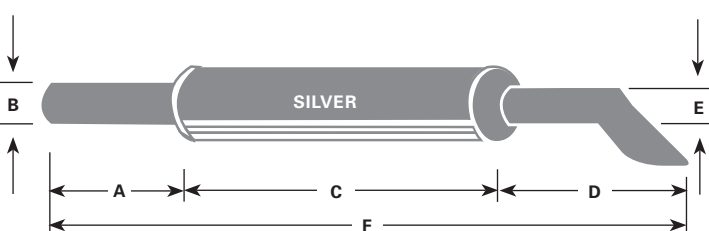
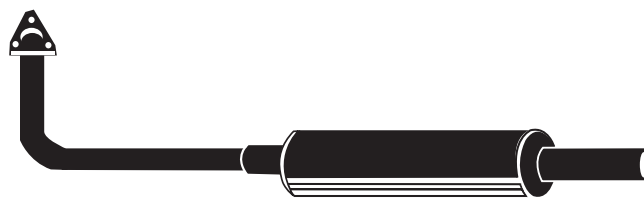
P/N	APPLICATION	INLET LENGTH (A)	INLET I.D. (B)	SHELL LENGTH (C)	OUTLET LENGTH (D)	OUTLET O.D. (E)	O/A LENGTH (F)	WEIGHT LBS.
		3988	MF-165, MF-175 & MF-180 (Gas & Diesel) (Perkins 4-236 & 4-238 cid) <b>Note:</b> This muffler is for tractors without loaders. See 3987 (vertical-round body. Shell dia. 5½")	8"	2½"	19½"	12½"	Bent Pipe
H214	Inlet Clamp Replaces OEM: 523394M95							
3989	MF-135 (U.K.) & MF-150 (Gas & Diesel). (Using Perkins) MF-230, 240, 250 (Gas & Diesel), MF-245, 255, 265, 275 (Diesel) (horizontal-round body. Shell dia. 4¼")	12"	1¾"	15"	12"	1¾"	39"	5
U134	Inlet Clamp Replaces OEM: 522589M91 & 539523M92 539525M91 & 890476M92							
P/N	APPLICATION	ASSEMBLY SPECIFICATIONS					WEIGHT	
		INLET I.D.	VERT. LENGTH	OVERALL LENGTH	OUTLET O.D.		LBS.	
7664	MF-135 (Perkins Gas & Diesel)	3-bolt	12"	60½"	1¾"		9	
	Replaces OEM: 522589M91 (muffler) 522584M91 (pipe)							

## MASSEY FERGUSON

P/N	APPLICATION	INLET LENGTH (A)	INLET I.D. (B)	SHELL LENGTH (C)	OUTLET LENGTH (D)	OUTLET O.D. (E)	O/A LENGTH (F)	WEIGHT LBS.
<b>3990</b>	MF-230, MF-235, MF-245, MF-255, MF-265 & MF-275 (Gas & Diesel) <b>Note:</b> 3990 has straight outlet pipe. To use as replacement for 535389M91 & 998669M91. (vertical-oval body. Shell dia. 4" x 8")	2 3/4"	2 1/8"	23"	8 1/2"	2"	34"	11
<b>H214</b>	Inlet Clamp Replaces OEM: 578090M92 Can sub for 535389M91 & 998669M91							

## MINNEAPOLIS MOLINE

P/N	APPLICATION	INLET LENGTH (A)	INLET I.D. (B)	SHELL LENGTH (C)	OUTLET LENGTH (D)	OUTLET O.D. (E)	O/A LENGTH (F)	WEIGHT LBS.
<b>3999</b>	Minnieapolis Moline Tractor 335 Universal & Utility, 445 Universal & Utility (vertical-round body. Shell dia. 4 1/4")	1 1/2"	2 1/4"	13 1/2"	1 1/2"	2 3/8"	17"	
<b>9372</b> <b>H212</b>	Rain Cap Inlet Clamp Replaces OEM: 10A7889, 10A8693							

## OLIVER

P/N	APPLICATION	INLET LENGTH (A)	INLET I.D. (B)	SHELL LENGTH (C)	OUTLET LENGTH (D)	OUTLET O.D. (E)	O/A LENGTH (F)	WEIGHT LBS.
<b>3991</b>	Super 66, 77 & 88 (Gas & Diesel) (vertical-round body. Shell dia. 3 1/4")	4"	2 3/8"	20"	5"	2 1/2"	29"	4
<b>9372</b> <b>H212</b>	Rain Cap Inlet Clamp Replaces OEM: K-452B							

## OLIVER

P/N	APPLICATION	INLET LENGTH (A)	INLET I.D. (B)	SHELL LENGTH (C)	OUTLET LENGTH (D)	OUTLET O.D. (E)	O/A LENGTH (F)	WEIGHT LBS.
3992	770, 880, 1600 (Gas & Diesel) (vertical-round body. Shell dia. 4 1/4")	4 1/4"	2 3/8"	20"	4 1/2"	2 1/2"	29"	7
9372 H212	Rain Cap Inlet Clamp Replaces OEM: 100694A, 155623A, 164079A							
3993	1650 (Diesel), 1750, 1800 & 1850 (Gas, LP-Gas & Diesel) (vertical-round body – w/ heat shield) (Shell dia. 6")	4 1/2"	2 15/16"	23"	6"	2 1/2"	34"	9
H300	Inlet Clamp Replaces OEM: 104764A, 155980A, 164080A							
4248	77 & 78 (Diesel) <b>Note:</b> Underhood Muffler (vertical-round body. Shell dia. 9")	2 1/4"	2 3/8"	6 1/2"	1 1/4"	1 3/4"	10"	6
H212	Inlet Clamp							
U134	Outlet Clamp Replaces OEM: K-452							

## VERSATILE

<b>3663</b> 118, 145 4WD articulated tractor (Diesel) both 6 cyl. & 8 cyl. <b>Note:</b> Muffler has double inlet tubes (vertical-round body. Shell dia. 9")	<table border="1" style="width: 100%; border-collapse: collapse;"> <tr> <td style="width: 12.5%;">3½"</td> <td style="width: 12.5%;">2½"</td> <td style="width: 12.5%;">36"</td> <td style="width: 12.5%;">5"</td> <td style="width: 12.5%;">37/8"</td> <td style="width: 12.5%;">43"</td> <td style="width: 12.5%;">26"</td> </tr> </table>	3½"	2½"	36"	5"	37/8"	43"	26"
3½"	2½"	36"	5"	37/8"	43"	26"		
<b>9375</b> <b>H212</b> Rain Cap Inlet Clamp Replaces OEM: 606T123-A								
<b>3995</b> 400 Swather (1981 & up) (Gas) & 4400 (Gas) <b>Note:</b> Muffler has side inlet. (horizontal-round body. Shell dia. 5½")	<table border="1" style="width: 100%; border-collapse: collapse;"> <tr> <td style="width: 12.5%;">2"</td> <td style="width: 12.5%;">2"</td> <td style="width: 12.5%;">23½"</td> <td style="width: 12.5%;">2¾"</td> <td style="width: 12.5%;">2"</td> <td style="width: 12.5%;">26"</td> <td style="width: 12.5%;">10"</td> </tr> </table>	2"	2"	23½"	2¾"	2"	26"	10"
2"	2"	23½"	2¾"	2"	26"	10"		
<b>H200</b> Inlet Clamp Replaces OEM: 36460								

CLAMP STYLES	PART NUMBER	REPLACES OEM PART NUMBER	TRACTOR MODEL APPLICATION	WEIGHT LBS.
	<b>9894</b>	CAPN 5200A	to fit Ford Tractors 9N, 2N & 8N with flared inlet pipe	1

## RAIN CAPS



P/N	MATERIAL FINISH	MIN. O.D. SIZE	MAX. O.D. SIZE
9367	POWDER COATING	1¼"	17/16"
9896	POWDER COATING	1½"	111/16"
9897	POWDER COATING	1¾"	115/16"
9371	POWDER COATING	2"	23/16"
9370	POWDER COATING	2¼"	27/8"
9372	POWDER COATING	2½"	211/16"
9378	POWDER COATING	2¾"	215/16"
9373	POWDER COATING	3"	33/16"
9374	POWDER COATING	3½"	311/16"
9375	POWDER COATING	4"	43/16"
9376	POWDER COATING	4½"	411/16"
9377	POWDER COATING	5"	53/16"
9704	POWDER COATING	5½"	511/16"
9369	POWDER COATING	6"	61/8"
9571	CHROME	3"	33/16"
9573	CHROME	4"	43/16"
9575	CHROME	5"	53/16"

## OE INTERCHANGE

CROSS  
REFERENCE

BLUEBIRD	DIESELTECH
000707	18155
000708	58424
003166	54138
003167	54139
003168	34890
003175	24978
003428	28674
003429	38782
125046	9651
997791	9399
1046481	3898
1334226	9618
1342021	300A1016
1357334	34798
1357342	34799
1357359	54880
1357367	34884
1357367	64744
1469931	68421
1477454	300A1016
1477470	300A1016
1477538	34886
1477645	300A1016
1622539	300A1016
1668326	48573
1668359	9764
1668391	48574
1721885	28669
1746676	24977
1746684	34886
1746684	54143
1805241	54137
1864677	34885
1864685	34887
1873447	44869
1997212	44873
1999036	44874
2118149	400A1014
2119378	400A1014
3580115	3679
4303137	44659
4303152	54985
4303178	500A1016
4303194	500A1016
4303210	500A1016
4303232	500A1016
4303244	500A1016
4303269	500A1016
4312955	312A1016
14051204	14662
15651242	74645
15651243	34814
15684601	34813
220093915	H500

BLUEBIRD	DIESELTECH
2201005560	9605
2201033588	3911

CHEV./GMC	DIESELTECH
61997	4211
236730	2704
327255	8560
328166	8793
335219	2538
346853	3906
346865	58313
348902	58120
352733	8566
356725	95951
357400	54650
359094	2538
359837	94953
359905	54650
362281	38093
363866	95952
369177	2538
369178	2943
372489	2538
372498	2538
377424	3666
458462	2538
458462	3906
464012	2538
464015	2538
465375	54650
468873	3006
468873	34684
471895	2944
474002	28154
474206	2943
474219	2538
476005	2538
559042	3006
559042	34684
563054	3005
563054	34684
593606	8719
626736	8566
644133	9395
651996	4211
661998	4211
666800	3911
679399	3713
692944	54789
693299	3613
693610	83007
693611	83007
695424	3911

CHEV./GMC	DIESELTECH
724859	3607
791988	38223
791989	9666
793928	9667
796790	3607
1259323	34684
1259324	3005
1259324	34684
1261466	3006
1261466	34684
1261467	3005
1261467	34684
1276031	8780
2004199	9606
2006721	3614
2008782	687
2011503	9663
2023481	9662
2023483	9607
2023492	T300
2030130	9624
2030132	9669
2037790	94991
2041519	9399
2046594	9479
2046609	3710
2049060	83008
2057214	3632
2061470	3632
2064499	28310
2069199	44773
2069773	9611
2079554	3710
2082251	88104
2082432	64708
2082829	54809
2083403	24836
2199800	3654
2306634	3654
2306635	3654
2306636	2704
2344284	3625
2353719	24346
2357630	3883
2373981	3651
2374639	3625
2383254	4211
2393290	3654
2423714	2704
2427177	3654
2428242	3654
2444889	3654
2456787	4211
2482972	3911

CHEV./GMC	DIESELTECH
2488074	3654
3730022	3651
3731062	8717
3741413	3651
3768711	9118
3816538	3654
3842793	8445
3842795	8445
3850420	3654
3850422	3654
3850424	3654
3873128	3654
3895366	609
3907220	2704
3931392	3654
3941448	3654
3946828	8720
3954018	3654
3954019	687
3954020	3654
3959674	3654
3963837	687
3963837	3654
3981941	687
3998323	2545
6271611	8717
6271612	8738
6272415	8560
10007215	3006
10007215	34684
10112097	9087
10147977	44783
10148001	3404
10148001	44783
10170227	3554
10170227	54859
10170234	44783
10213647	3553
10213647	18097
10213647	54858
12541351	54868
12541384	3599
12541384	9206
12541384	28470
14000137	3005
14000137	34684
14000264	58120
14000517	95957
14002817	3006
14002817	34684
14005903	3005
14005903	34684
14008893	2538
14008903	2538

## OE INTERCHANGE ////

CHEV./GMC	DIESELTECH	CHEV./GMC	DIESELTECH	CHEV./GMC	DIESELTECH	CHEV./GMC	DIESELTECH
14008906	2538	14051251	54750	15535673	3534	15577587	54803
14008908	2538	14054138	38205	15535674	3387	15577588	44766
14008911	2538	14058909	54746	15535684	2872	15577590	28268
14008912	2538	14061322	93962	15537617	2872	15577652	48291
14008913	2943	14061324	94904	15537617	9206	15577842	9162
14008918	2538	14063659	2944	15537617	28172	15577862	3533
14013055	94011	14063659	28174	15537618	2872	15577862	8975
14014746	38204	14063659	54760	15544299	95973	15577863	54853
14014760	38205	14063660	2944	15544300	95973	15577864	3399
14016364	54650	14063660	28174	15544570	94928	15577865	64722
14016370	54650	14063665	3123	15548523	93986	15577868	28268
14016371	2943	14063666	3123	15548783	48300	15582808	3533
14016432	3108	14063666	38249	15549327	3318	15582853	2872
14016433	3108	14063666	54749	15549327	28265	15582853	9206
14016434	3108	14063666	54750	15549327	54800	15582853	28172
14016469	54705	14063795	2943	15549631	54808	15582856	54758
14016470	54706	14063829	2943	15550775	18126	15584678	3533
14016473	54707	14063854	2538	15550775	28424	15584678	9206
14019860	3123	14063877	3387	15555594	3708	15584690	3318
14019861	3123	14063878	3387	15556740	64708	15584692	3318
14024138	93962	14067425	3387	15560703	93983	15584698	3318
14029959	54650	14067428	3387	15567706	3263	15584702	3318
14032690	54760	14067429	28272	15567706	8170	15589909	3387
14033544	54650	14069527	28166	15567706	28239	15589927	3123
14033589	54650	14069592	2872	15567706	54785	15589928	3123
14033591	54650	14069592	9206	15567706	54786	15589928	38249
14034514	8212	14069592	28172	15567709	3269	15589929	2944
14034516	8212	14069595	54758	15567709	8170	15589929	28174
14034520	8212	14071760	3906	15567709	28240	15589930	2944
14034823	54705	14071809	54759	15567709	54785	15589930	28174
14034824	54706	14071813	54758	15567709	54786	15590286	38439
14034833	54707	14072686	9220	15567711	3269	15590705	94932
14034834	44712	14079385	3387	15567711	28240	15590793	3226
14034891	54650	14079386	3387	15567711	54785	15590793	8111
14034897	54650	14089132	2943	15567711	54786	15592091	8223
14034905	2538	14089135	3108	15567728	28245	15592451	9261
14034906	2538	14095528	2538	15567730	48300	15593365	54759
14034935	54650	14095661	28154	15567736	8111	15594198	9206
14041279	94904	14098952	3553	15569650	88104	15594198	28172
14044989	3387	14098952	54858	15569651	88104	15595256	93962
14044990	3387	14098960	3554	15570014	14618	15595258	94904
14044997	3387	14098960	18097	15576674	2943	15595287	68290
14044998	3387	14098960	54859	15576674	28241	15595295	68290
14045001	3387	15327105	38432	15576675	54787	15595607	9597
14045002	3387	15507925	24677	15576676	2943	15595607	27875
14045067	54746	15522175	9160	15576676	38345	15595610	58313
14045068	2872	15522434	9234	15576677	54788	15595621	14662
14045545	68290	15535118	54760	15576680	2943	15595679	2538
14045546	38093	15535366	3123	15577067	3533	15596401	8112
14045568	38204	15535654	3387	15577068	28424	15596681	2872
14049660	8113	15535655	3387	15577579	38367	15596681	9206
14051204	14662	15535667	44758	15577583	38369	15596681	28172
14051246	8107	15535668	3387	15577585	28266	15598205	8111
14051250	54749	15535673	3387	15577586	54802	15598211	3226

CROSS  
REFERENCE



## OE INTERCHANGE



CROSS  
REFERENCE

CHEV./GMC	DIESELTECH	CHEV./GMC	DIESELTECH	CHEV./GMC	DIESELTECH	CHEV./GMC	DIESELTECH
15598211	18038	15631342	94933	15659507	28494	15662530	44810
15598217	44758	15634747	54838	15659507	54758	15662530	54866
15598249	94914	15635938	2944	15659507	54786	15662530	54867
15603976	3269	15635938	28401	15659510	2058	15662531	54869
15603976	28240	15635940	2944	15659510	8170	15662532	54810
15603976	54785	15635940	28401	15659510	8214	15662533	54854
15603976	54786	15635941	54848	15659510	9206	15662533	54855
15607673	93972	15636093	74635	15659510	38553	15662798	2178
15611402	3123	15637249	3534	15659510	54785	15662798	3598
15611402	8170	15637250	3534	15659510	54786	15662798	28400
15611405	3269	15638767	3719	15659512	2058	15662799	44809
15611405	54785	15638980	2062	15659512	8170	15665181	3599
15611405	54786	15638980	64749	15659512	8214	15665182	3599
15613631	24731	15639084	95984	15659512	9206	15666316	2064
15615515	54803	15639088	8975	15659512	38553	15670818	3719
15615666	3533	15639088	94938	15659512	54785	15671561	2943
15615666	9206	15640098	94933	15659512	54786	15671712	2058
15616421	3400	15640280	2704	15659513	2058	15671712	54785
15616422	64723	15640311	93986	15659513	8170	15671884	93971
15616425	3400	15640346	58345	15659513	8214	15671887	93971
15616426	64724	15641364	8066	15659513	38553	15671889	95984
15617160	44766	15641375	3123	15659513	54785	15671890	94938
15618161	2943	15641375	8140	15659513	54786	15671891	93986
15618161	18078	15641375	54837	15659514	2058	15676983	3539
15618162	54787	15642373	3123	15659514	8170	15676983	48448
15618163	2872	15642373	8140	15659514	8214	15677739	93983
15618164	2944	15642373	54837	15659514	28494	15679777	83008
15618164	28174	15644152	68370	15659514	54785	15682576	2016
15618165	54760	15644642	3579	15659514	54786	15682576	18095
15618166	2943	15644642	18092	15661558	2106	15682576	44813
15618166	2944	15644642	44806	15661559	64760	15683950	38504
15618166	28174	15647159	9652	15661675	3549	15683951	3269
15618880	2063	15651242	74645	15661675	28426	15683951	8170
15618881	64750	15651243	34814	15661676	54857	15683951	54785
15618882	2059	15651734	3423	15662508	38525	15683951	54786
15620225	93971	15651734	28400	15662510	28268	15684179	93985
15623923	54846	15651734	28400	15662511	48429	15684601	34813
15623923	64723	15651734	54847	15662512	28266	15687112	2062
15624686	3400	15651799	28391	15662513	38523	15687112	64749
15624686	28335	15651837	2944	15662516	28166	15687225	9234
15627107	3123	15651837	28401	15662517	3599	15696039	400A1014
15627107	3269	15651837	54848	15662518	3599	15957259	3549
15627107	28334	15651857	2944	15662519	3599	15957259	28426
15627107	54785	15651857	28401	15662520	3599	15967769	18098
15627107	54786	15651857	54848	15662521	3599	15967769	48451
15627111	38469	15654304	2064	15662522	3599	15967770	385 67
15627126	3123	15654847	2062	15662523	3599	15967771	48452
15627126	3269	15658202	3595	15662524	3599	15973803	2100
15627126	8170	15658202	28444	15662525	3599	15973803	28508
15627126	28334	15658202	54864	15662526	3599	15973804	2099
15627126	54785	15659507	2058	15662526	28470	15973804	28508
15627126	54786	15659507	8170	15662527	3539	15973805	2100
15629016	38555	15659507	8214	15662528	3539	15973805	18098
15631327	8975	15659507	9206	15662529	54868	15973806	2099

## OE INTERCHANGE ////

CHEV./GMC	DIESELTECH
15973806	18098
15973811	2099
15973811	28509
15973812	2100
15973812	28509
15973820	64754
15976974	28268
15976980	54893
15976981	3539
15976981	38562
15976982	3539
15976982	48447
15976984	54891
15976984	54892
15976993	54895
15976993	54896
15978269	54894
15980181	2016
15980181	38563
15980181	54897
15981463	2115
15981463	38596
15981463	54909
15981464	2114
15981464	54908
16540345	38556
22500899	34684
52003985	44772
52004422	3355
52004422	44760
94021915	8740
94024717	8717
94025166	2960
94044319	3726
94047627	3726
94206497	9058
94207180	8511
94222494	2960
94222502	8515
94222509	28153
94236345	9233
94457763	8233
96051782	8172
96051783	8172

DODGE/PLY.	DIESELTECH
1636570	8722
1636570	8724
2506865	2537
3497444	8571
3641271	8567
3733815	74439

DODGE/PLY.	DIESELTECH
3820811	8571
3893206	24629
3893206	24629
3893207	24629
3893401	8571
3894085	2923
3898336	2664
3898470	54655
3898746	24646
4004392	2923
4032896	74439
4112523	3068
4112524	2923
4112525	2923
4112863	14342
4115381	3068
4115409	24646
4115409	T212
4115410	24646
4115410	54655
4115410	T212
4115411	24646
4115411	54655
4115411	T212
4115415	54655
4115416	54655
4117411	94909
4117447	74439
4117455	24646
4117455	T212
4117456	24646
4117456	54655
4117456	T212
4117457	24646
4117457	54655
4117457	T212
4117461	54655
4117462	54655
4117582	74439
4131333	8094
4164134	24646
4164135	24646
4164136	24646
4164138	14342
4167335	74439
4212523	3068
4218032	8096
4218084	14342
4218166	8093
4218183	94909
4218199	8095
4218200	8070
4218208	28242
4218243	8093

DODGE/PLY.	DIESELTECH
4218250	2923
4218297	14342
4218299	3068
4218307	74621
4218308	74621
4218310	74621
4218311	74621
4218328	8093
4218329	8093
4218339	64699
4218341	64699
4218343	64699
4218344	64699
4218346	64699
4218347	64699
4218350	74621
4218355	54790
4218365	2923
4218459	54790
4218469	74621
4218470	74621
4218472	74621
4218473	74621
4218495	2923
4218496	2923
4218497	2923
4218534	54810
4218536	8975
4218537	38415
4218603	74621
4218607	74621
4218608	74621
4218610	74621
4218618	64699
4218619	64699
4218622	64699
4218623	64699
4218624	64699
4218625	8095
4218627	8093
4218629	54790
4218635	54810
4301195	8069
4301221	74620
4301709	3264
4301711	74619
4301712	3265
4301714	74620
4301756	3264
4301843	3264
4301944	74619
4301951	74620
4301960	8068
4318717	8094

DODGE/PLY.	DIESELTECH
4425075	74619
4427010	3265
4427075	3265
4427092	8070
4427102	3265
4427121	3264
4427234	8069
4427348	74620
4427393	74619
4427395	3429
4427625	58337
4427708	84565
4427728	84570
4427751	3430
4427754	74631
4427757	3430
4427758	84565
4427760	2004
4427762	54876
4427793	2004
4427794	84570
4427796	3430
4427797	74643
4427798	2004
4427799	54876
4428532	3366
4428532	28311
4428542	54810
4428550	9618
4495283	3429
4495284	74631
4495301	3430
4495306	8067
4495307	8067
4495308	2004
4495314	2004
4495314	18094
4495324	54876
4495360	3430
4495680	58337
4495681	2005
4495681	34771
4495701	2005
4495701	34771
4495703	58337
7218604	74621
52004171	3394
52004174	3395
52004178	3394
52004197	8093
52004208	8093
52004210	8093
52004225	27875
52004232	64718

CROSS REFERENCE

## OE INTERCHANGE

CROSS  
REFERENCE

DODGE/PLY.	DIESELTECH
52004462	8093
52005760	38533
52006460	8093
52006463	94909
52006539	2078
52006540	2078
52006556	3366
52006556	8093
52006648	28311
52006748	8093
52006839	3436
52006841	54790
52006842	54840
52006914	8093
52007170	84567
52007171	84567
52007173	54863
52007193	28433
52007194	28434
52007195	28435
52007201	54862
52017519	8093
52017520	8093
52017523	54810
52017525	8093
52017526	8093
52017527	8093
52017528	8093
52017529	8093
52018003	3395
52018004	28391
52018007	38415
52018106	2078
52018312	54865
52018316	28433
52018317	28434
52018513	28434
52018514	28433
52018515	28434
52018859	74641
52018903	54898
52019003	28242
52019005	3394
52019006	8975
52019048	54810
52019108	38415
52019114	3571
52019117	3570
52019118	3570
52019121	3570
52019184	3571
52019185	3571
52019186	3571
52019188	3570

DODGE/PLY.	DIESELTECH
52019189	3570
52019190	84567
52019191	84567
52019192	54790
52019193	54862
52019200	54899
52019341	74642
52019342	74642
52019423	2080
52019424	2080
52019425	2080
52019426	2079
52019427	2079
52020003	28502
52020012	74644
52020115	3571
MB009240	8308
MB149083	8308
MB156180	8697
MB179130	8729
MB376954	8172
MB431821	9240
MB431913	3482
MB431914	9206
MB431915	44769
MB431917	9206
MB431918	44769
MB514246	9240
MB514615	8287
MB514708	8697
MB548707	8139
MB548956	9240
MB549140	9240
MB549154	3482
MB549155	9206
MB549156	44769
MB577083	3482
MB577084	9206
MB577085	44769
MB577834	18073
MB611777	9206
MB612221	24844
MB612304	8139
MB612305	3482
MB612305	9206
MB612305	44769

FORD	DIESELTECH
B5T5230A	3654
C1S29450A	8726
C1T25A231A	T400Z
C2TA5230A	4211

FORD	DIESELTECH
C3T5230H	3614
C3T25230	3654
C4T5230B	3888
C4T25A215B	9666
C5T5230A	3911
C5T25230E	3906
C5T29450B	8727
C6A29450D	8717
C6T25A231B	T312
C6T29450B	8773
C6A29450D	8717
C7T25230A	3911
C7T25230J	3654
C8TA5230M	3632
C8T25230B	3654
C1T25230AT	4211
DOHA5269D	9165
D1T25230E	3521
D1T25230E	54851
D27Z5B266A	9033
D3HA5230GA	3911
D3T25230A	3177
D3T25230A	54757
D3T25230E	3906
D47Z9450A	9047
D4T25230L	609
D4T25230L	2958
D5HZ5246AC	28517
D5HZ5A231C	9667
D5TA5225BDA	3611
D5T25230AC	3654
D5T25230AH	3611
D5T25230AH	3668
D5T25230CC	3463
D5T25230CL	2958
D5T25230CL	3607
D5T25230CM	3654
D5T25255AN	312A1016
D5T25260E	8572
D5T25260L	8572
D5T25260M	8572
D5T25A246G	8572
D5UZ5260D	8572
D5UZ5A246A	8572
D5UZ5A246F	8572
D67Z5B266A	9075
D7HT5225BTA	3611
D7HT5270UA	9624
D7T25260D	8572
D7T25260F	8572
D8HT5270BA	9669
D8HZ5230AC	3611
D8HZ5230AL	3698
D8HZ5230S	3607

FORD	DIESELTECH
D8HZ5246AC	18109
D8HZ5246M	18109
D8HZ-5246-M	18109
D8HZ5255AG	44659
D8HZ5A231J	3613
D8NN5A281AA	9663
D9HT51210DA	9626
D9HZ5230A	3697
D9HZ5230A	3697
D9HZ5230B	3697
D9HZ5A231J	9610
D9HZ5A231J	9626
D9T25230CE	24629
D9T25230CF	24629
D9T25260E	8572
DOHA5225L	3632
DOHZ5230J	3611
DOHZ5230R	3614
DT25260A	8572
EOHT5225AB	3632
EOHZ5225L	400A1014
EOHZ5230A	3632
EOHZ5230B	3632
EOHZ5255G	400A1414
EOHZ5255J	400A1414
EOHZ5263H	400A1014
EOHZ5263K	400A1014
EOHZ5263M	400A1014
EOHZ5A212B	58372
EOHZ5A231A	9611
EOHZ5A231B	9656
EOHZ5A231C	9617
EOHZ5A231C	9735
E0NN5A281AA	9605
E0T25A212A	28134
E0T25A212B	28134
E0T25B266A	9079
E1HT5270BA	9607
E1HT5270EA	9605
E1HT5270HA	9662
E1HZ5255N	T400Z
E1HZ5A231A	9611
E1HZ5A231C	T400Z
E1T25230AF	3424
E1T25230E	3112
E1T25230G	3424
E1T25230J	3112
E1T25230N	3112
E1T25230N	9200
E1T25230N	24629
E1T25230S	3112
E1T25A212A	28134
E2HS5225GA	3700
E2HT5225AFB	3711

## OE INTERCHANGE ////

FORD	DIESELTECH	FORD	DIESELTECH	FORD	DIESELTECH	FORD	DIESELTECH
E2HT5225AG2A	3700	E3TZ5230AK	54757	E4TZ5230K	24629	E5TZ5230L	2048
E2HT5230ANA	3697	E3TZ5230AK	54757	E4TZ5230L	3257	E5TZ5230L	3112
E2HZ5230G	3697	E3TZ5230AL	3177	E4TZ5230L	54783	E5TZ5230L	8080
E2HZ5230S	3697	E3TZ5230AL	3177	E4TZ5230M	8213	E5TZ5230L	24629
E2HZ5230Z	3711	E3TZ5230AL	54757	E4TZ5230M	8214	E5TZ5230L	28296
E2HZ5A212D	18103	E3TZ5230AL	54757	E4TZ5230R	27875	E5TZ5230L	54755
E2HZ5A212F	58372	E3TZ5230AM	3424	E4TZ5230R	54755	E5TZ5230L	54805
E2HZ5A215C	9628	E3TZ5230B	3177	E4TZ5230S	27875	E5TZ5230M	54756
E2HZ5A231A	9622	E3TZ5230B	54757	E4TZ5230S	54755	E5TZ5230N	3201
E2TZ5230A	3112	E3TZ5230F	3112	E4TZ5260A	8197	E5TZ5230N	54757
E2TZ5230B	3112	E3TZ5230F	54755	E4UZ5230A	3193	E5TZ5230R	3201
E2TZ5230B	24629	E3TZ5230G	3177	E4UZ5230A	64675	E5TZ5230R	54757
E2TZ5230G	3112	E3TZ5230G	54757	E4UZ5230B	3112	E5TZ5230T	3201
E2TZ5230G	24629	E3TZ5230H	3177	E4UZ5230B	3193	E5TZ5230T	28203
E2TZ5230J	3112	E3TZ5230H	54757	E4UZ5230B	64675	E5TZ5230T	54757
E2TZ5230K	3112	E3TZ5230J	3112	E4UZ5230C	3256	E5TZ5230U	3201
E2TZ5230L	3112	E3TZ5230J	54755	E4UZ5230D	3181	E5TZ5230U	28203
E2TZ5230M	3112	E3TZ5230K	3112	E4UZ5230D	64675	E5TZ5230U	54757
E2TZ5230N	3112	E3TZ5230K	54755	E4UZ5230E	3181	E5TZ5230V	3177
E2TZ5230N	24629	E3TZ5230M	3357	E4UZ5230E	64675	E5TZ5230V	54757
E2TZ5230W	3112	E3TZ5230M	54755	E4UZ5230F	3181	E5TZ5230W	3177
E2TZ5230Y	3112	E3TZ5230R	3112	E4UZ5230F	64675	E5TZ5230W	54757
E3HZ5230B	3700	E3TZ5230R	54755	E4UZ5320C	3181	E5TZ5230Y	3257
E3HZ5230D	3698	E3TZ5230S	3112	E4UZ5320C	64675	E5TZ5230Y	54783
E3HZ5230S	3697	E3TZ5230S	24629	E5HZ5246J	68371	E5TZ5A212J	28385
E3HZ5246AA	28517	E3TZ5230S	54755	ESHZ5A231B	9610	E5TZ5A212K	28472
E3HZ5246K	68371	E3TZ5230T	3112	E5TZ5230A	3177	ESUZ5230A	64731
E3HZ5246Y	52369	E3TZ5230T	54755	E5TZ5230A	54757	ESUZ5230L	14672
E3HZ5255B	400A1014	E3TZ5230U	3112	E5TZ5230AA	8213	ESUZ5230M	3424
E3HZ5255D	400A1014	E3TZ5230U	24629	E5TZ5230AA	8214	E69Z5230A	3222
E3HZ5255F	400A1014	E3TZ5230U	54755	E5TZ5230AB	8213	E69Z5230A	28215
E3HZ5255H	400A1014	E3TZ5230W	3112	E5TZ5230AB	24629	E69Z5230A	44756
E3HZ5255K	400A1014	E3TZ5230W	54755	E5TZ5230AL	8080	E69Z5230B	3222
E3HZ5255M	400A1014	E3TZ5230Y	3112	E5TZ5230AL	8177	E69Z5230B	28215
E3HZ5255R	400A1014	E3TZ5230Y	24629	E5TZ5230AM	54872	E69Z5230B	44756
E3TZ5230AA	3112	E3TZ5230Y	54755	E5TZ5230AM	54872	E69Z5230D	3222
E3TZ5230AA	54756	E3TZ5320V	3112	E5TZ5230AM	8213	E69Z5230D	28215
E3TZ5230AC	3112	E3TZ5320V	3112	E5TZ5230AN	24629	E69Z5230D	44756
E3TZ5230AC	54755	E3TZ5320V	54759	E5TZ5230AR	2048	E69Z5B266A	8692
E3TZ5230AD	3112	E3TZ5320V	54759	E5TZ5230AR	8080	E69Z5C226A	8768
E3TZ5230AD	24629	E3TZ5A246A	8196	E5TZ5230AR	8080	E69Z5C226A	9258
E3TZ5230AD	54755	E3TZ5A246A	8196	E5TZ5230AR	8177	E6DZ5E241A	9095
E3TZ5230AE	3112	E3TZ5A262A	8196	E5TZ5230AR	8177	E6HZ5255A	74627
E3TZ5230AE	54756	E3TZ5A262A	8196	E5TZ5230AR	54805	E6TZ5230D	3201
E3TZ5230AF	3177	E3UZ5230F	3424	E5TZ5230AR	54805	E6TZ5230D	28216
E3TZ5230AF	54757	E3UZ5230H	3424	E5TZ5230AT	2048	E6TZ5230D	54757
E3TZ5230AG	3177	E3UZ5230J	3424	E5TZ5230AT	8085	E6TZ5230E	3201
E3TZ5230AG	54757	E4HZ5230A	3697	E5TZ5230AT	38528	E6TZ5230E	28216
E3TZ5230AH	3177	E4TZ5230G	54755	E5TZ5230B	3177	E6TZ5230E	54757
E3TZ5230AH	54757	E4TZ5230H	3112	E5TZ5230B	54757	E6TZ5230F	3223
E3TZ5230AJ	3177	E4TZ5230H	24629	E5TZ5230E	54764	E6TZ5230F	54764
E3TZ5230AJ	54757	E4TZ5230H	54755	E5TZ5230K	3112	E6TZ5230M	3201
E3TZ5230AK	3177	E4TZ5230J	3112	E5TZ5230K	54755	E6TZ5230M	28203
E3TZ5230AK	3177	E4TZ5230K	3112	E5TZ5230L	2048	E6TZ5230M	54757

CROSS REFERENCE

## OE INTERCHANGE

CROSS  
REFERENCE

FORD	DIESELTECH	FORD	DIESELTECH	FORD	DIESELTECH	FORD	DIESELTECH
E6T25230N	3201	E7T25230K	3255	E8T25230A	8179	E9H25230A	3725
E6T25230N	28203	E7T25230K	8168	E8T25230A	8179	E9H25246A	68373
E6T25230N	54757	E7T25230K	54781	E8T25230A	28296	E9H25246B	68374
E6T25230R	3309	E7T25230L	3255	E8T25230A	54805	E9H25A231B	9625
E6T25230R	54799	E7T25230L	54755	E8T25230B	3257	E9H28560A	3632
E6T25A212D	28230	E7T25230M	54872	E8T25230B	54782	E9T25230AY	3112
E6T25B266A	9235	E7T25230N	3257	E8T25230B	64692	E9T25230AY	9200
E6U25A212A	28383	E7T25230N	8168	E8T25230C	3257	E9T25230AY	24629
E7H25230A	3713	E7T25230N	54783	E8T25230C	24629	E9T25230B	2048
E7H25230A	3725	E7T25230S	54872	E8T25230C	54782	E9T25230C	2048
E7H25230C	3730	E7T25230T	3255	E8T25230C	64692	E9T25230C	3223
E7H25246G	48348	E7T25230T	8168	E8T25230D	3257	E9T25230F	3112
E7H25246K	48347	E7T25230T	54781	E8T25230D	54783	E9T25230F	3309
E7H25246N	48349	E7T25230U	3309	E8T25230E	54872	E9T25230F	48299
E7H25255A	74627	E7T25230U	54799	E8T25230F	2048	E9T25230F	54799
E7H25255D	28658	E7T25A212A	28383	E8T25230F	3424	E9T25230G	3112
E7H25255E	400A1014	E7T25A212B	28474	E8T25230F	3730	E9T25230K	2002
E7H25255G	400A1014	E7T25B266A	9245	E8T25230F	8086	E9T25230K	44811
E7H25255J	400A1014	E7UA5230A	64709	E8T25230G	3373	E9T25230K	54874
E7H25255L	400A1014	E7UZ5230A	3256	E8T25230G	54812	E9T25230L	2002
E7H25255N	400A1014	E7UZ5230A	28237	E8T25230G	54815	E9T25230L	44811
E7H25255R	400A1414	E7UZ5230A	64691	E8T25230M	54872	E9T25230L	54874
E7H25A231C	9627	E7UZ5230B	3256	E8T25230N	3373	E9T25230R	3373
E7T25230A	3255	E7UZ5230B	28237	E8T25230N	54812	E9T25230R	54812
E7T25230A	64690	E7UZ5230B	64691	E8T25230N	54815	E9T25230R	54815
E7T25230B	3255	E7UZ5230G	3256	E8T25230R	2002	E9T25230S	2002
E7T25230B	24629	E7UZ5230G	28237	E8T25230R	44811	E9T25230S	44811
E7T25230B	64690	E7UZ5230G	28237	E8T25230R	54874	E9T25230S	54874
E7T25230C	24629	E7UZ5230G	64691	E8T25230W	3713	E9T25230T	3373
E7T25230C	54782	E7UZ5230H	3425	E8T25246B	95982	E9T25230T	54812
E7T25230C	64692	E7UZ5230J	18083	E8T25246D	95982	E9T25230T	54815
E7T25230D	3255	E7UZ5230K	3424	E8T25B266A	9263	E9T25230V	3112
E7T25230D	64690	E7UZ5230K	64729	E8UZ5230A	3424	E9T25230W	3112
E7T25230E	3255	E7UZ5230L	3424	E8UZ5230A	3424	E9T25230W	9200
E7T25230E	24629	E7UZ5230N	3256	E8UZ5230A	64729	E9T25230W	24629
E7T25230E	64690	E7UZ5230N	3256	E8UZ5230AA	3926	E9T25230Z	3112
E7T25230F	3257	E7UZ5230N	3256	E8UZ5230AE	3873	E9T25246A	95979
E7T25230F	54782	E7UZ5230N	28237	E8UZ5230B	3424	E9T25246D	95983
E7T25230F	64692	E7UZ5230N	64691	E8UZ5230C	3256	E9T25260AA	9200
E7T25230G	3257	E7UZ5230N	64709	E8UZ5230C	64691	E9T25260AA	24629
E7T25230G	24629	E7UZ5230R	3256	E8UZ5230D	3256	E9T25A212B	28474
E7T25230G	54782	E7UZ5230R	28237	E8UZ5230D	64691	E9UZ2530B	64741
E7T25230G	64692	E7UZ5230R	64691	E8UZ5230G	3425	E9UZ2530A	54875
E7T25230H	2048	E8HT5225A2A	3700	E8UZ5230H	18083	E9UZ2530C	3425
E7T25230H	8080	E8HT5225AEA	3926	E8UZ5230H	64741	E9UZ2530D	54875
E7T25230H	8179	E8HT5225G2A	3919	E8UZ5230J	3425	E9UZ2530E	18083
E7T25230H	8179	E8HT5225LA	3873	E8UZ5230J	54875	E9UZ2530E	18083
E7T25230H	28296	E8HZ5230B	3722	E8UZ5230K	54875	E9UZ2530E	64741
E7T25230H	28296	E8HZ5230E	3920	E8UZ5230L	3424	E9UZ2530F	3425
E7T25230H	54805	E8HZ5230R	3713	E8UZ5230L	54875	E9UZ2530G	3256
E7T25230H	54805	E8HZ5255A	44659	E8UZ5230M	3425	E9UZ2530G	64691
E7T25230J	2048	E8HZ5A231E	9622	E8UZ5230N	18083	E9UZ5A212A	28383
E7T25230J	8085	E8T25230A	2048	E8UZ5230N	64741	EC27PLA	B234
E7T25230J	38528	E8T25230A	8080	E8UZ5230P	3424	EC35PLA	B312

## OE INTERCHANGE ////

FORD	DIESELTECH	FORD	DIESELTECH	FORD	DIESELTECH	FORD	DIESELTECH
EC40PLA	B400	F1TZ5230G	54852	F2UZ5230D	3578	F4UZ5230K	18083
F09Z5230A	28363	F1TZ5230H	3521	F2UZ5230D	28436	F4UZ5230M	28437
F09Z5230A	44785	F1TZ5230H	28419	F2UZ5230D	64743		
F09Z5230B	28363	F1TZ5230H	54852	F2UZ5230E	3256		
F09Z5230B	44785	F1TZ5230J	3521	F2UZ5230E	28437		
FOOZ5230J	54875	F1TZ5230J	28419	F2UZ5230E	64691		
FOTZ5230B	3201	F1TZ5230J	54851	F2UZ5230F	3425		
FOTZ5230B	54823	F1TZ5230K	3522	F2UZ5230G	3256		
FOTZ5230C	3309	F1TZ5230K	54851	F2UZ5230G	64691		
FOTZ5230C	54822	F1TZ5230N	3521	F37Z5230A	38530		
FOTZ5230G	3255	F1TZ5230N	28338	F37Z5230A	54877		
FOTZ5230G	54781	F1TZ5230N	54851	F37Z5230B	38530		
FOTZ5230L	3201	F1TZ5230T	3414	F37Z5230B	54877		
FOTZ5230L	54823	F1TZ5230T	54833	F37Z5230C	48432		
FOTZ5230M	3201	F1TZ5230V	3414	F37Z5230C	54877		
FOTZ5230M	28338	F1TZ5230V	18071	F37Z5230D	2008		
FOTZ5230M	54822	F1TZ5230V	54833	F37Z5230D	28477		
FOTZ5230S	3309	F1TZ5246D	95983	F37Z5230D	54877		
FOTZ5230S	54822	F1UZ5230B	3424	F37Z5230E	2008		
FOTZ5230T	3373	F1UZ5230D	18083	F37Z5230E	38531		
FOTZ5230T	54812	F1UZ5230D	64741	F37Z5230E	54877		
FOTZ5230T	54815	F1UZ5230H	54875	F37Z5230F	2008		
FOTZ5230W	3257	F1UZ5230J	18083	F37Z5230F	48433		
FOTZ5230W	54782	F1UZ5230J	64741	F37Z5230F	54877		
FOTZ5230W	64692	F1UZ5230K	3424	F3HZ5230B	3700		
FOTZ5230X	3257	F1UZ5230L	54875	F3HZ5230B	9628		
FOTZ5230X	24629	F2TZ5230A	3255	F3HZ5230F	3713		
FOTZ5230X	54782	F2TZ5230A	64690	F3HZ5230G	3700		
FOTZ5230X	64692	F2TZ5230B	3255	F3HZ5230R	3700		
FOUZ5230A	3425	F2TZ5230B	24629	F3HZ5230S	3713		
FOUZ5230B	54875	F2TZ5230B	64690	F3HZ5255C	44821		
FOUZ5230D	18083	F2TZ5230D	2011	F3HZ5263B	400A1014		
FOUZ5230D	64741	F2TZ5230D	54879	F3HZ5263D	400A1014		
FOUZ5230E	3425	F2TZ5230E	3257	F3HZ5263F	400A1014		
FOUZ5230E	54875	F2TZ5230E	54782	F3HZ5A281A	9618		
FOUZ5230F	18083	F2TZ5230E	64692	F3TZ5230A	2009		
FOUZ5230F	64741	F2TZ5230F	3255	F3TZ5230A	54878		
FOUZ5230H	18083	F2TZ5230F	64690	F3TZ5230B	28478		
FOUZ5230H	64741	F2TZ5230G	3255	F3TZ5230B	54878		
FOUZ5230K	18083	F2TZ5230G	64690	F3XY5230A	2025		
FOUZ5230K	64741	F2TZ5230H	3521	F3XY5230A	44814		
F1HZ5C210A	9625	F2TZ5230H	28419	F3XY5G226A	8196		
F1TZ5230C	3414	F2TZ5230H	54851	F3XY5G226B	8196		
F1TZ5230C	18071	F2TZ5230J	3521	F4TZ2530C	2329		
F1TZ5230C	54833	F2TZ5230J	28419	F4TZ5230Z	3255		
F1TZ5230D	3414	F2TZ5230J	54852	F4TZ5230Z	24629		
F1TZ5230D	28364	F2TZ5230K	3522	F4TZ5230Z	64753		
F1TZ5230D	54833	F2TZ5230K	54851	F4UZ2530F	64729		
F1TZ5230E	3521	F2UZ5230A	3256	F4UZ5230A	3256		
F1TZ5230F	3522	F2UZ5230A	28437	F4UZ5230A	64691		
F1TZ5230F	3522	F2UZ5230A	64691	F4UZ5230C	3425		
F1TZ5230F	48401	F2UZ5230B	3424	F4UZ5230F	3424		
F1TZ5230F	54851	F2UZ5230B	64729	F4UZ5230H	3424		
F1TZ5230G	3521	F2UZ5230C	3425	F4UZ5230J	54875		

CROSS REFERENCE

FREIGHTLINER	DIESELTECH
0419919	8323
0114596000	9615
0115653000	28699
A0409586013	10786
A0409586015	10787
A0409586017	10788
A0412399000	38762
A0413974000	94010
A0415652000	28655
A0415653000	28699
A0417094012	28698
A0417925005	924120
A0417926000	83036
A0417997000	9770
A0417998001	9769
A0418007000	9771
A0418007001	9772
A0418364000	9773
A0418556000	48557
A0419184000	9601
A0420919000	9348
A0417926001	83033
A0417927008	83035
A0418158000	38794
A0418363001	83034

INT'L/NAVISTAR	DIESELTECH
5132650	9735
10148HA	609
119144H	2704
138534R91	3651
142414R91	3654
1608381C1	74646
1610293C3	74632
1610299C3	83014
1613069C1	83001
1614956C1	58225
1617608C1	9359
1618527C2	83001
1618528C1	83001
1618529C2	83001
1618530C1	83001
1618531C1	83001
1618532C2	83001
1619352C1	44822
1619352C1	44822

## OE INTERCHANGE



CROSS  
REFERENCE

INT'L/NAVISTAR	DIESELTECH	INT'L/NAVISTAR	DIESELTECH	INT'L/NAVISTAR	DIESELTECH	INT'L/NAVISTAR	DIESELTECH
1619388C2	400A1014	321575R91	9373	482622C1	83005	591593C91	58251
1619389C2	400A1014	321577R91	9377	482624C1	83005	591595C1	68221
1619390C2	400A1014	3358614C1	9613	482626C1	83005	591595C92	68221
1619391C2	400A1014	336649R91	9375	482726C1	38269	593781R2	18101
1619392C2	400A1014	338614C1	9613	482728C1	58219	593784C2	18139
1619482C1	400A1014	3526521C1	58443	483055C91	9662	594054C1	8884
1619487C1	83001	360473C1	214A1014	484895C2	83001	598276C1	10783
1619642C1	83001	360481C1	300A1014	484895C2	400A1014	598276C1	18148
1619644C1	83001	360484C1	400A1014	484896C2	83001	690420R91	3614
1619646C1	83001	360486C1	400A1014	484896C2	400A1014	72093R1	9086
1620106C1	83001	360488C1	400A1014	485124C91	9604	72095R91	3654
1647828C1	809299	360490C1	400A1014	486932C2	83004	744829R91	609
1647829C1	809300	360492C1	400A1014	486939C1	83004	758539C1	400A1014
1647960C1	3610	360494C1	44659	486948C1	83002	762783C91	3713
1647998C1	3716	390226C91	9615	486950C1	83002	780067C91	9735
1652937C1	18149	391814C1	14740	486951C1	83002	865034C91	4211
1659768C1	38523	425624R91	9395	486952C4	64668	868829C2	8975
1660460C1	18101	433192R91	9647	488710C1	3697	870336R91	609
1660539C91	9753	434252R91	9396	488710C2	3150	873578R91	3906
1660543C91	9753	437790C1	3611	489737C61	B212	874580C1	8960
1666966C2	58330	437953C1	9056	489737C91	B212	893944R92	9627
1668838C1	58349	437953C1	9056	489790C91	B214	893945R92	9653
1668843C1	83001	437953C1	9613	489790C91	B214	910748R1	9149
1672105C91	9615	439797C1	3677	497843C91	9624	976488R91	3614
1672818C1	400A1014	441336C1	9084	499528C1	2704	987177R91	3625
1678067C1	83030	441337C1	9056	499550C1	8884	989443R91	3614
1678068C1	83030	441337C2	9056	501471C91	9606	998025C1	3625
1678069C1	83030	447662C1	3677	503841C1	28534		
1678070C1	83030	447832C1	38560	503845C1	38607		
1678074C1	83005	449814C1	9716	504926C1	3610		
1680060C2	83001	460938C1	834728	504959C91	9604		
1680062C2	83001	465969C1	609	504960C91	9605		
1680287C2	83001	465971C1	2704	504960C91	9669		
1680289C2	83001	466540C2	3632	519513C3	400A1014		
1686801C1	48554	466984C91	2704	520541C1	3632		
172699R1	214A1014	471382C1	2704	547446C2	44822		
2000225C1	9799	475761C91	9605	549466C1	3607		
2000976C1	44822	475761C91	9605	549469C1	2704		
2003581C1	48554	475761C91	B234	549564C91	8951		
200827R91	4211	475762C91	9606	549904C91	T212		
201761R91	609	476339C91	9624	554319C1	T500Z		
207524R2	48568	476349C91	9606	554430C1	9575		
214463R91	4211	481727C2	3915	572479C1	3697		
231488R91	3651	482167C1	3611	577265C1	8452		
242148R91	3654	482168C4	74607	577265C1	83005		
243658R91	609	482174C1	58225	578068C1	3610		
244007R91	2704	482611C2	83001	579231C91	T500Z		
256017C91	3677	482612C2	83001	582167C1	38608		
277839R91	3883	482613C2	83001	583970C91	B500		
305122C91	3888	482614C2	83001	583975C91	9604		
312137C91	3887	482616C1	83005	583975C91	T300		
320218C1	8884	482618C1	83005	583977C91	9605		
320230C1	24676	482618C2	83005	583978C91	9606		
320233C1	14738	482620C1	83005	587521C2	38585		

JEEP	DIESELTECH
536254	2664
634814	8735
3226666	9226
5354074	8429
5357043	8593
5360106	2664
5361132	2664
5362494	2664
5362517	3161
5362517	44744
5362804	3161
5363080	44744
5363087	8593
5363566	3161
5363566	44744
5363569	44744
5363571	44744
5364312	48369
5364858	54776
52001759	8098
52002400	8097
52002989	48438
52003025	9264

## OE INTERCHANGE ////

JEEP	DIESELTECH
52003934	3262
52003934	9206
52003934	44760
52003985	44772
52004422	3355
52004422	44760
52007220	44772
52017690	2015
52017690	54882
52018162	2015
52018162	54882
52018163	2015
52018163	54882
52019133	2015
52019133	44750
52019134	2015
52019134	44750
52019135	2006
52019135	44760
52019136	2006
52019136	44760
52019137	2015
52019137	44750
52019138	2015
52019138	44750
52040278	48418
83502645	54774
83502655	74622
83502978	3355
83502978	9206
83502979	3262
83502979	9206
83503452	3236
83503453	64700
83503980	44760

KENWORTH	DIESELTECH
K16948012	10788
K18014122	38610
K18014764L	38611
K18014764R	38612
K18014765	28656
K18014766	94942
K18014967	38610
K18015593	10791
K180-15764R	38612
K1805419	18110
K1806326	38613
K1808048	10317
K1808049	38614
K180B10742L	68183
K180B10742L	868184
K180B10742R	68185
K180B10742R	868186

MACK	DIESELTECH
11ME241	9615
11ME29	9619
2ME336B	3667
48RU2341	9614
4ME21698	28528
4ME322825	58529
4ME32611	68181
4ME32612	68182
4ME32618	38761

PETERBILT	DIESELTECH
1401726	10560
1404055	94941
1408525	10784
1410726	10560
1411039	9616
1413055	94011
61240037	3632
61240207	9622
62240301	78166
62240355	24678
62240380	14739
62240386	18150
1401726C	809530
14-130022	18166
14-13056CP	809519
14-13394-202	10799
14-13944-0150	94015
14-15353-0150	94015

THOMAS	DIESELTECH
61240005	3647
61240007	3898
61240008	3614
61240027	4233
61240037	3632
61240207	9622
61240208	9651
61240385	24346
62240301	78166
62240380	24677
62240385	38763
62240386	18150
62240405	18165
62240464	58449
62240464	64790
62240464	64790
62240498	44878
62240498	44878
62240516	24985
62240554	24983

THOMAS	DIESELTECH
62240558	24983
62240565	44877
62240565	44877
62240579	44879
62240587	38791
62240587	38791
62240589	58447
62240589	58448
62240589	58448
62240590	58447
62240590	58448
62240599	58465
62240610	38788
62240610	38788
62240752	58467
62240771	58447
62240771	58449
62240788	24985
62240808	38787
62240808	38787
62240977	48646
62240978	78265
62240895 & 62240727	38792

CROSS  
REFERENCE



## AFTERMARKET INTERCHANGE



CROSS  
REFERENCE

AUTOJET	DIESELTECH	AUTOJET	DIESELTECH	AUTOJET	DIESELTECH	AUTOJET	DIESELTECH
5003	3533	350SCPF	9669	B400400	3666	DTFP	83001
40082	3713	360DTURBO	58349	B500500	3699	E350350	3685
40090	10761	370VCLHD	9610	BBFOA94	84576	F60A	74627
250250	3654	392ER	9084	BBFOA95	84575	F60A91	74654
275275	3613	392HI	8698	BBFOAIR	78250	F60A91	84587
300300	2704	4"OUT-DODRP85	3871	BBHGR5.62	9324	F6TMP	48349
400400	3632	400400L	3710	BBHGR9.25	9325	F6TP91	44821
2250275	3697	40045ETR	10315	BBROA675	54172	F6VCL96	9618
2275400	3610	40082F	4225	BBTP6440	34904	FLD400TP	54994
1000MH	9358	400CON	14603	BDFOA	44796	FLEX200SS	8883
11-0025	4251	400EXT	24737	BDFOA5	38768	FLEX250SS	8884
1100MH	9628	400FDA	3700	BDROA	44797	FLEX30018	24675
17"SWHGR	8051	400PH2PC	9740	BDROA5	48570	FLEX300SS	8885
200SCPF	9664	400PHCE	9349	BDTP5MM	44866	FLEX35018	24676
200STPA	200A1014	400SCPF	9623	BFOA99	58424	FLEX350SS	8886
2250300BS	3719	400STPA	400A1014	BP3116EXT194	48592	FLEX40012	14739
2250300L	3150	400STPID	924120	BP3126MIN	28674	FLEX40018	24677
2250400BS	3708	450STPA	412A1016	BP3126T	38782	FLEX40024	24836
225CON	8951	454ER304	9219	BP500PTB	44873	FLEX40036	34673
225SCPF	9665	466DTFC	78230	BP500TPUB	44874	FLEX400SS	8887
2502250V	2943	466DTLEXT	48554	BP59MIN	38816	FLEX50012	14737
2502250VL	3534	466TURBO93	58421	BP59T	38845	FLEX50018	24678
25045E	10725	466TURBO93ST	58225	BP59TPSTD	64804	FLEX50024	24838
25090E	10303	50045E	10317	BP59TPTD	54163	FLEX50036	34674
250CON	14338	50090E	10308	BPEL94	48591	FLEX500SS	8888
250SCPF	9666	50090ETR	10765	BPTP94	54167	FLEX600SS	8899
250STP409	21451014	500CON	14605	BROAFP99AIR	54138	FORD11MH	9758
250STPA	212A1014	500EXT	24739	BROAFP99SP	54139	FORD400PH	9130
27545E	10318	500SCPF	9624	BROANAV	9776	FRLOAAS149	83047
275CON	8980	500STPA	500A1016	BSD5ODS	74669	FRL11MH	9769
275SAD	9524	500STPID	925120	BTP995	24978	FRL300400	4224
275SCPF	9667	6.9MPL	58251	BV3126T143	48599	FRL3126BT	58482
275STPA	234A1014	6.9MPR	68221	BVTM626	38839	FRL3126T	38794
30045E	10313	600MH	9354	BVTP2614	34903	FRL8MH	9770
30090E	10758	600SCPF	9671	CONVBM1	646303	FRLBTSS	48562
300CON	14601	600STPA	600A1016	C5OFF	54808	FRLISBT	48557
300EXT	24941	66FTURBO	48348	CTP	83007	FRLISBTL	58479
300PH2PC	9738	7.3MPL	58330	CV3116EL	10798	FRLMERC450	58468
300SCPF	9668	700MH	9355	CV3116FP	28668	FRLMERC451	68450
300STPA	300A1014	78FTURBO	48347	CV3116OFF	38773	FRLMERC	58464
300STPID	923120	800MH	9580	CV3116T94	38774	FRLMERCYL4	58471
3116VCL	9651	82CFP	44773	CV3126T	38772	FRLMH919	9348
312STPA	312A1016	82CNAEL	28310	CV400CNTR	4227	FRLMHRUB	8323
3208ER	9743	82COA	54809	CVFOA	34814	FRLOA	83033
345ER	9056	82CTP	83008	CVFOA	48572	FRLOA433	64806
345HI	8699	82FLAIR	9479	CVFOA97	34896	FRLOAAS	83034
350400L	3716	82FVCLNA	9611	CVOA94	54133	FRLOAAS02	64805
35045E	10314	82FVCLT	9617	CVTP94	54134	FRLOARFT	83036
35090E	10305	850MH	9356	DODTP95	54997	FRLOARFTAS	83048
35090ETR	10759	9"SWHGR	8049	DT360VCL	9627	FRLOAS02	64808
350CON	14340	9.0LMP	58219	DT466TRE	38847	FRLOAS434	64807
350EXT	24735	9.0RRMP	38269	DT466VCL	9613	FRLPH	9771
350LY	94991	B3126T99	18155	DTFP	34898	FRLPHOA	9772

## AFTERMARKET INTERCHANGE ////

AUTOJET	DIESELTECH
FRLPHOAR	9773
FRLPHOAR02	9323
FRLSDTP1	34899
FRLSDTP1PC	83052
FRLSDTP2	24998
FRLSDTP3	34900
FRLT1077	68449
FRLTP	83035
FRLTP02	54166
FRLTP77	83044
FRLTPTB	34897
FRLTPUB	24997
G30300TP	54853
GM10MH	9131
GM454FP	24002
GM454L	48583
GM454R	58457
GM6.2ER	9220
GM65300P	4228
GM875BR	9328
GM900MH	9129
GMCONV	646304
GMCONV454	646310
GMCONVR	645317
GMCS3HOLE	9280
GMFRAMBR	9132
GMHGROA	9761
GMMANKIT	8038
GMOVSTRAP	9762
HGRBR	9353
IDOA	74607
IDOAAS	74632
IDOAAS98	74670
IDTP	83005
IDTPAS98	83043
M5325	3424
MERCVCL	9609
NAVBRCOMP&BRTPNV	9779
NAVCE427	44892
NAVCE445	64815
NAVCE451	64810
NAVCE939	38860
NAVEXT20	48594
NAVTPEXT	34901
OVALMH1	9360
OVALMH2	9359
OVMHCE	9449
OVMH73	9753
OVMH1HDT	9753
OVMH1HDTAJ	9321
OVMH1HDTBH	9322
OVMH1HFC	9755

AUTOJET	DIESELTECH
OVMH1HRE	9753
P302250300	4237
REOARP99	34890
RUBHGR	8050
S7OFF	88104
SD14FC	44822
SD190	44888
SDC4TD	84584
SDI14PL	84559
SFP	83004
SOA	64668
SSB30012	9726
SSB35012	9727
SSB40012	9728
SSB50010	9729
T444RETP	54132
T444RETPSD	34883
T444REV	3851
T444REVHDA	3851
T444TRE	58443
T444TRE99	38823
T444TURBO	58420
T444TURBO20	68451
T444VCL	9737
T444VCL	9748
T85171	3625
T85301	4233
TCADAPTSS	9764
TCFOASS	48573
TCFOASS132	48574
TCMAN20	18173
TCMAN94	28669
TCP3126EXT	48590
TCP3126T	18178
TCPBT94	48575
TCPMIN3126	38818
TCPT98	38822
TCPTP94	54165
TCRAFSAS	54143
TCREROAMM	68421
TCRET	34884
TCROAFS	34886
TCROARS	44869
TCROARSAS	54137
TCROARSASMM	24977
TCTPEB	34887
TCTPMMAS	83045
TCTPTB	34885
TD275	14634
TD300ID	24344
TD350	14619
TD350ID	24345
TD400	14620

AUTOJET	DIESELTECH
TD400ID	24346
TD500ID	24347
TD600ID	24696
THGR	9352
TMVP3126T	78246
TMVP85MH	9326
TMVPBT	38791
TMVPBT01A	28721
TMVPBT01B	58466
TMVPBT99	38792
TMVPFOAAS	58447
TMVPFOAD200	58467
TMVPOA	64790
TMVPROA0771	58449
TMVPROAAS	58448
TMVPROAS99	58465
TMVPSDT4	44878
TMVPSDT4TD	64809
TP11MH	9327
TP3116MIN94	18152
TP3116T94	38769
TP3126T	38787
TP3126T98	28719
TP32081	78166
TP400400SI	4246
TP400REV	3898
TP6BFM97	28720
TP6BT	18165
TP6BT97	38819
TP83MIN96	38788
TP83T	18150
TP83T98	38817
TPTP94TBLH	24983
TPTP94TBRH	44879
TPTP94UBRH	44877
TPTP96TB	24985
U200	U200
U200	U200
U225	U214
U225	U214
U250	U212
U250	U212
U300	H300P
U400	H400P
U450	H412
U500	H500P
U600	H600
WBEXT92	24981

DONALDSON	DIESELTECH
J000103	134A1016
J000107	178A1016

DONALDSON	DIESELTECH
J000121	214A1014
J000127	234A1016
J000139	500C1016
J000140	600C1016
J000202	AS400
J000203	AS500
J000210	B200
J000211	B212
J000212	B214
J000213	B234
J000214	B300
J000215	B312
J000216	B400
J000217	B500
J000218	B600
J000219	B412
J000220	H200
J000221	H212
J000222	H214
J000224	H234
J000227	H300
J000228	H312
J000230	H400
J000231	H412
J000232	H500
J000233	H600
J008167	8052
J008681	10681
J008681	10681
J008868	8868
J008870	8870
J008872	8872
J008942	8942
J009391	9391
J009393	9393
J009429	809429
J009479	9479
J009486	9486
J009487	9487
J009500	809500
J009514	9514
J009516	9516
J009518	9518
J009530	809530
J009539	28661
J009547	809547
J009560	10560
J009604	9604
J009605	9605
J009606	9606
J009607	9607
J009611	9611
J009612	9610
J009613	9613

CROSS REFERENCE

## AFTERMARKET INTERCHANGE



CROSS  
REFERENCE

DONALDSON	DIESELTECH	DONALDSON	DIESELTECH	DONALDSON	DIESELTECH	DONALDSON	DIESELTECH
J009614	9614	J190019	809796	M090091	3695	M120382	3678
J009618	9618	J190023	10727	M090146	3679	M120418	3941
J009623	9623	J190025	10729	M090158	3689	M120448	3912
J009624	9624	J190027	10732	M090170	3616	M120450	4205
J009629	9629	J190050	9660	M090280	3632	M120566	3931
J009631	10631	J190051	9661	M090301	3636	M120592	4240
J009632	10632	J190052	9662	M090362	3681	M122300	3913
J009633	10633	J190053	9663	M090520	3611	P101294	926553
J009636	10636	J190056	9664	M090534	3710	P101891	925543
J009637	10637	J190057	9665	M090535	3667	P103516	925553
J009639	10639	J190058	9666	M090535	3897	P105532	924003
J009640	10640	J190059	9667	M090538	3668	P105533	924004
J009641	10641	J190060	9668	M090544	3666	P105534	925506
J009644	10644	J190061	9669	M090544	3666	P105535	926006
J009645	10645	J190062	9670	M090547	3704	P105536	927006
J009648	9648	J190063	9671	M090548	3703	P105545	924105
J009649	9649	J240006	14739	M090563	3610	P105546	925505
J009650	9650	J240007	14737	M090594	3888	P105547	926005
J014621	814621	J280003	18149	M090595	3895	P105609	924104
J014622	814622	J380007	38761	M090680	3716	P105610	925105
J018110	18110	J380008	38762	M090781	3712	P105611	925504
J024735	24735	JO44786	44786	M090823	3926	P105612	926004
J024737	24737	M045123	4223	M100043	3911	P105613	927004
J024739	24739	M045193	3617	M100048	3669	P107844	924005
J024746	24746	M045237	3970	M100049	3670	P109021	925005
J024747	24747	M060037	3690	M100052	3677	P112611	926503
J024748	24748	M060247	3878	M100146	3637	P117724	926557
J024750	24750	M060307	3721	M100213	3702	P148341	9589
J024752	24752	M065030	3691	M100463	3640	P148342	9590
J024753	24753	M065034	3624	M100463	3640	P148343	9591
J024754	24754	M065044	3925	M100464	3714	P148345	9592
J024755	24755	M065065	3654	M100465	3699	P148346	9593
J024835	24835	M065065	3654	M100465	3699	P148347	9594
J024836	24836	M070008	3683	M100466	3714	P148348	9595
J024837	24837	M070028	3618	M100572	3937	P148349	9596
J024838	24838	M070043	609	M100582	3722	P159820	927557
J024849	24849	M070050	3685	M100695	3715	P205834	9811
J028528	28528	M070068	3692	M100807	3873	P205976	9343
J034673	34673	M070069	3693	M100845	4218	P205979	9341
J034674	34674	M080018	3687	M110012	3711	P206279	10312
J034743	34743	M080024	3694	M110014	3923	P206280	10313
J034744	34744	M085008	3662	M110028	3713	P206281	10314
J034785	34785	M085023	2704	M110189	3700	P206282	10315
J038611	38611	M085056	3627	M110311	3919	P206283	10731
J038612	38612	M085090	3626	M110479	3927	P206286	809738
J038613	38613	M085171	3625	M110728	4224	P206297	92673
J038614	38614	M085172	3697	M120100	3614	P206298	92674
J054831	54831	M085182	3663	M120108	3647	P206299	9342
J092679	92679	M085189	3150	M120131	3900	P206300	9344
J092689	92689	M085267	3719	M120154	3898	P206302	14618
J190003	10764	M090009	3684	M120235	3645	P206303	14619
J190004	809771	M090072	3682	M120365	3676	P206304	14620
J190013	10778	M090074	3667	M120366	3698	P206306	10921
J190014	10329	M090074	3897	M120367	3921	P206306	10921

## AFTERMARKET INTERCHANGE ///

DONALDSON	DIESELTECH	DONALDSON	DIESELTECH	DONALDSON	DIESELTECH	DONALDSON	DIESELTECH
P206308	14343	P206373	14602	P206561	8987	P207351	10564
P206309	24344	P206374	14341	P206562	8988	P207352	10565
P206310	24345	P206375	14605	P206563	8989	P207353	10566
P206311	24346	P206375	14605	P206567	8888	P207354	10567
P206312	24347	P206378	44657	P206600	9501	P207356	10311
P206313	8953	P206379	44659	P206601	9502	P207362	10776
P206314	8955	P206380	34828	P206602	9503	P207363	10329
P206315	8956	P206382	44665	P206603	9504	P207364	10781
P206316	8957	P206383	44667	P206604	9395	P207365	10789
P206316	8957	P206395	10684	P206604	9612	P207374	8990
P206317	8958	P206396	10685	P206605	9396	P207375	8883
P206318	9335	P206397	10337	P206606	9399	P207382	8947
P206319	8960	P206398	10338	P206607	9615	P207385	8952
P206320	8962	P206399	10339	P206608	9490	P207386	8954
P206321	8963	P206400	10340	P206610	9492	P207389	8941
P206322	8964	P206403	U200	P206611	9493	P207392	8959
P206323	8965	P206404	U214	P206612	9390	P207393	9334
P206324	9600	P206405	U212	P206613	9709	P207394	8969
P206325	9333	P206406	T234	P206614	9474	P207397	8913
P206326	9722	P206407	T300	P206615	9394	P207401	8961
P206327	9332	P206408	T314	P206616	9586	P207402	9336
P206328	9331	P206409	T312	P206641	9430	P207408	8974
P206331	200A1014	P206410	T400	P207281	9599	P207411	8933
P206333	212A1016	P206411	T500	P207282	24711	P207414	8979
P206334	300A1016	P206507	8483	P207283	24712	P207417	14634
P206335	312A1016	P206508	9456	P207285	44854	P207559	24696
P206335	312A1016	P206509	9457	P207286	44731	P207566	9478
P206336	400A1016	P206510	9451	P207287	44656	P207567	9475
P206337	500A1016	P206511	9452	P207288	54991	P207568	9392
P206337	500A1016	P206512	9453	P207289	54720	P207568	9392
P206338	600A1016	P206513	9453	P207290	54721	P207569	9471
P206339	10672	P206514	9453	P207291	54722	P207581	9473
P206340	10675	P206515	9354	P207292	44658	P207581	9473
P206341	10304	P206516	9355	P207295	44664	P207582	9713
P206342	10676	P206517	9356	P207296	44666	P207584	9715
P206343	10305	P206518	9357	P207297	24713	P207596	9506
P206343	10305	P206519	9358	P207298	24714	P207598	9495
P206344	10678	P206520	9360	P207314	844002	P207619	9470
P206345	10306	P206521	9359	P207322	10773	P207620	9476
P206346	10539	P206522	9361	P207324	10774	P207667	T600
P206347	10554	P206523	9363	P207326	10534	P207707	9398
P206348	10308	P206524	9364	P207327	10535	P208315	8881
P206353	809406	P206525	9365	P207328	10536	P208316	8882
P206354	809408	P206526	9366	P207329	10537	P208324	34713
P206362	8970	P206543	809458	P207330	10538	P208348	34714
P206363	8971	P206544	24674	P207331	10540	P208350	34827
P206364	8972	P206545	24935	P207332	10541	P208358	34723
P206365	8973	P206546	24654	P207333	10301	P208364	34715
P206367	8975	P206547	24936	P207335	10303	P208366	34719
P206368	8976	P206552	24675	P207339	10557	P208374	34724
P206369	8991	P206553	24676	P207341	10556	P208380	34716
P206370	8978	P206554	24677	P207345	809545	P208386	24717
P206371	14338	P206555	24678	P207346	809546	P208387	54984
P206372	14601	P206560	8986	P207349	10562	P208388	54725

CROSS  
REFERENCE

## AFTERMARKET INTERCHANGE



CROSS  
REFERENCE

DONALDSON	DIESELTECH
P208392	24718
P208393	54985
P208394	54726
P210110	9616
P213191	9397
P216164	10318
P216169	809752
P216171	10302
P216191	24941
P216197	44863
P216200	834000
P216240	54827
P222018	9653
P222747	9678
P222753	9686
P222755	9688
P222757	9692
P222758	9693
P222759	9694
P224473	44867
P224477	34826
P224479	14738
P224481	14740
P224487	SBC500
P224488	SBC600
P224489	8899
P224674	10747
P224685	300S1014
P224686	400S1016
P224687	500S1016
P224689	92678
P224698	834002
P224841	9628
P226129	8880
P226132	8982
P226133	8983
P226135	8855
P226137	8856
P226138	8857
P226140	8986
P226141	8987
P226142	8988
P226143	8989
P226144	8885
P226145	8886
P226146	8887
P226147	8888
P226148	8984
P226149	8985
P226150	8990
P226151	8883
P226152	8884
P226153	8895
P226154	8881

DONALDSON	DIESELTECH
P226155	8882
P226156	8878
P226157	8877
P226158	8879
P226166	8859
P226167	8876
P270530	9896
P270531	9897
P270532	9371
P270533	9370
P270534	9372
P270535	9378
P270536	9373
P270538	9374
P270539	9375
P270540	9376
P270541	9377
P270542	9704
P270543	9369
P270837	9573
P270838	9575
P271507	9571
X005190	B314
X005265	9666
X005921	9668
X005985	9670
X006211	9604
X007057	9671

DYNAFLEX	DIESELTECH
10-200	10671
10-225	10673
10-250	10672
10-300	10756
10-350	10676
10-400	10761
10-400CP	809770
10-500	10554
10-500CP	809546
10-600	10556
10L-200	10301
10L-225	10302
10L-250	10303
10L-300	10758
10L-350	10305
10L-400	10762
10L-400CP	809406
10L-500	10308
10L-500CP	809408
10P-200	10773
10P-250	10774
10P-300	10534
10P-350	10329

DYNAFLEX	DIESELTECH
10P-400	10539
10P-500	10540
10P-500CP	809796
10PL-300	10778
10PL-350	10536
10PL-400	10797
10T-250-45	10562
10T-300-45	10564
10T-350-45	10565
10T-400-15	10684
10T-400-30	10636
10T-400-45	10743
10T-400-60	10644
10T-500-15	10685
10T-500-30	10637
10T-500-45	10567
10T-500-60	10645
10T-500-90	10309
10T-600-45	10748
11-275	10674
11-300	10675
11-300	10675
11-350	10795
11-400	10681
11-400CP	809621
11-500	10557
11-500CP	809771
11L-400	10681
11L-500	10765
11P-300	10776
11P-350	10329
11P-350	10794
11P-400	10781
11P-500	10789
11PL-300	10777
11PL-400	18148
11PL-500	10796
11T-300-45	10742
11T-300-90	10337
11T-350-90	10338
11T-400-45	10566
11T-400-90	10339
11T-500-90	10340
12-200	10311
12-225	10320
12-250	10725
12-275	10318
12-300	10313
12-350	10314
12-400	10315
12-500	10732
12-500CP	809738
12L-250	10312
12L-500	10317

DYNAFLEX	DIESELTECH
12L-500	10731
12P-500CP	809752
12PL-400	10745
12PL-500	10747
12PL500CP	809753
13-400	10736
13-500	10729
14FD-R5246	28517
14FL-3974	94010
14FL-6015	10788
14GM-6594	9479
14IH-2167	38608
14KW-4122	38610
14KW-4765	28656
14KW-4766	94942
14KW-5419	18110
14KWL-0742	68183
14KWL-0742CP	868184
14KWL-4764	38611
14KWR-0742	68185
14KWR-0742CP	868186
14KWR-4764	38612
14MK-2611	68181
14MK-2612	68182
14PB-1726	10560
14PB-1726CP	809530
14PB-3055	94011
16-250	44748
16-300	44749
16-300-1256	24344
16-300-1256CP	814621
16-350-1406CP	814622
16P-300-1256	14618
22-150AZ	112A1016
22-175AZ	134A1016
22-200AZ	200A1014
22-200AZ	200A1016
22-200S	200S1016
22-225AZ	214A1014
22-225AZ	214A1016
22-225S	214S1014
22-250AZ	212A1014
22-250AZ	212A1016
22-250S	212S1014
22-275AZ	234A1014
22-275AZ	234A1016
22-300	300A1016
22-300AZ	300A1014
22-300S	300S1014
22-350	312A1016
22-350AZ	312A1016
22-350S	312S1016
22-400	400C1016
22-400AZ	400A1014

## AFTERMARKET INTERCHANGE ///

DYNAFLEX	DIESELTECH	DYNAFLEX	DIESELTECH	DYNAFLEX	DIESELTECH	DYNAFLEX	DIESELTECH
22-400AZ	400A1016	25-60018	24696	34-3040	92698	42B-500	9719
22-400S	400S1016	25P-22512	14342	34-3540	92678	42E-4036	9713
22-450AZ	412A1016	25P-25012	14343	34-400	92679	42EL-4029	9706
22-500	500C1016	25P-27512	14634	34-500	92689	42F-400	9586
22-500AZ	500A1016	25P-30048	34828	35-2022	8946	42HP-300	9708
22-500S	500S1016	25P-35012	24345	35-2025	8947	42P-300	9392
22-550AZ	512A1016	25P-40012	24346	35-2530	8953	42P-350	9391
22-600	600C1016	25P-40018	24717	35-3035	8955	42P-400	9474
22-600AZ	600A1016	25P-40024	24748	35-3040	8956	42P-4050	9717
24-25024	9597	25P-40036	34723	35-3540	8957	42P-500	9478
24-30024	24941	25P-40048	44665	35-4050	8958	42P-500-1	9716
24-30036	34713	25P-40060	54725	35-5060	9335	42P-500-45	9393
24-30048	44854	25P-50018	24718	35P-2022	8912	42R-300	9470
24-30048CP	844002	25P-50024	24750	35P-3040	9648	42R-3031-45	9471
24-35018	9599	25P-50036	34724	35P-4050	9649	42R-350	9711
24-35024	24735	25P-50048	44667	35P-5060	9650	42R-350-45	9392
24-35036	34714	25P-50060	54726	36-2022	8911	42R-400	9476
24-35048	44731	27-125Z	9367	36-2025	8913	42R-400-45	9475
24-40018	24711	27-150Z	9896	36-2530	8960	42R-500-45	9394
24-40024	24737	27-175Z	9897	36-3035	8962	43EL-487	9715
24-40036	34715	27-200Z	9371	36-3040	8963	43EL-500	9718
24-40036CP	834004	27-225Z	9370	36-3540	8964	45-412Z	AS400
24-40048	44656	27-250Z	9372	36-4050	8965	45-512Z	AS500
24-40060	54991	27-275Z	9378	36-5060	9336	45BC-800-3CP	9804
24-50018	24712	27-300CP	9571	37-2220	8938	45PB-500CP	SB500
24-50024	24739	27-300Z	9373	37-2520	8941	45PB-600CP	SB600
24-50036	34716	27-350Z	9374	37-3025	9600	46-300	9501
24-50048	44658	27-400CP	9573	37-3530	9333	46-300CP	9490
24-50060	54720	27-400Z	9375	37-4030	9722	46-350	9502
24-60048	44863	27-450Z	9376	37-4035	9332	46-400	9503
24MP-40036CP	834002	27-500CP	9575	37-5040	9331	46-400CP	9492
24MP-DT40051	54827	27-500Z	9377	37-5045	9723	46-500	9504
24P-40048	44657	27-550Z	9704	37-6050	8969	46-500CP	9493
24P-40060	54984	27-600Z	9369	38P-401	9341	46-600	9506
24P-50048	44659	31-200	8933	38P-501	9342	46-600CP	9495
24P-50060	54985	31-250	8943	39-401	9343	47-150	U112
25-25036CP	834000	31-300	8975	39-501	9344	47-175	U134
25-30018CP	824000	31-350	8976	40-300-1S	9610	47-200	U200
25-30060CP	854000	31-400	18103	40-300S	9395	47-225	U214
25-35012	14619	31-500	8978	40-350-1S	9622	47-250	U212
25-35018	24938	31-600	8979	40-350-2S	9627	47-275	H234
25-35018CP	824001	31L-500	8991	40-350S	9396	47-300	H300
25-35036	34827	32-200	14337	40-400-1S	9617	47-350	H312
25-40012	14620	32-250	14338	40-400-2S	9653	47-400	H400
25-40018	24713	32-300	14601	40-400S	9399	47-450	H412
25-40024	24746	32-350	14602	40-450S	9616	47-500	H500PZ
25-40036	34719	32-400	14603	40-500-1S	9397	47-600	H600
25-40048	44664	32-500	14605	40-500S	9615	47G-200	U200
25-40060	54721	32-600	8974	41-300-1S	9612	47G-225	U214
25-50018	24714	33-500	92697	41-338S	9611	47G-250	U212
25-50024	24747	335L-500	92674	41-400S	9614	47G-300	T300
25-50036	34720	33BL-400	92673	41-450S	9735	47G-350	T312
25-50048	44666	33L-400	92695	42-300	9390	47G-350	T312Z
25-50060	54722	33P-500	92696	42-350	9709	47G-400	T400Z

CROSS  
REFERENCE

## AFTERMARKET INTERCHANGE



CROSS  
REFERENCE

DYNAFLEX	DIESELTECH
47G-400CP	9486
47G-450	T412Z
47G-500	T500Z
47G-500CP	9487
47G-550	T512Z
47G-600	T600
47G-600CP	9734
47HC-400CP	SBC400
47HC-500CP	SBC500
47HC-600CP	SBC600
47HF-400CP	SBF400
47HF-500CP	SBF500
47HF-600CP	SBF600
48CH-250	9361
48CH-300	9363
48CH-350	9364
48CH-400	9365
48-CH-500	9366
50EZ-300S	B300
50EZ-350S	B312
50EZ-400S	B400
50EZ-450S	B412
50EZ-500S	B500
50EZ-600S	B600
50TQ-200AZ	9660
50TQ-250AZ	9662
50TQ-275AZ	9663
50TQ-300AZ	9604
50TQ-350AZ	9605
50TQ-400AZ	9606
50TQ-400S	9623
50TQ-500S	9624
51-175	8866
51-225	8870
51-250	8872
51-300	8880
51-30018	24752
51-30024	24930
51-30036	34826
51-350	8881
51-35018	24753
51-35036	34785
51-400	8882
51-400-12-6	14738
51-400-18-6	24754
51-400-24-6	24835
51-400-36-6	34743
51-500	8877
51-500-12-6	14740
51-500-18-6	24755
51-500-24-6	24837
51-500-36-6	34744
51-600	8898
51F-125	8862

DYNAFLEX	DIESELTECH
51F-150	8864
51F-200	8868
51F-250	8872
51F-300	8875
51F-350	8881
51F-400	8882
51F-500	8877
51F-50048	54831
53-200	8883
53-225	8855
53-250	8884
53-300	8982
53-30018	24675
53-350	8983
53-35018	24676
53-400	8878
53-400-12-6	14739
53-400-18-6	24677
53-400-24-6	24836
53-400-36-6	34673
53-500	8879
53-500-12-6	14737
53-500-18-6	24678
53-500-24-6	24838
53-50036	34674
53-600	8899
66D-30012S	9726
66D-350-12S	9727
66D-400-12S	9728
66D-500-12S	9729
81R-40048C	809308
81R-40048SP	809458
81R-60048SP	809307
83-1012S	9453
83-900S	9452
83R-90048C	809304
84R-1012048CP	809500
85-101233CP	9453
85GH-18SP	9430
85GH-24SP	9811
85SC-10123CP	9799
85SC-10123Z	9807
85SC-4003CP	9456
85SC-4003Z	9801
85SC-5003CP	9457
85SC-5003Z	9803
85SC-6003CP	9810
85SC-9003CP	9724
85SC-9003Z	9725
86-200	3690
86-250	3691
86-300	3692
86-350	3693
86-400	3694

DYNAFLEX	DIESELTECH
86-500	3695
87Q-250-186	3880
87Q-300-119	3652
87Q-300-187	3721
87Q-350-113	3679
87Q-400-108	3666
87Q-400-127	3625
87Q-400-131	3891
87Q-400-189	3887
87Q-4050-205	3893
87Q-4050-514	3712
87Q-500-102	3667
87Q-500-130	3699
87Q-500-132	3667
87Q-500-145	3682
87Q-500-674	3895
88HQ-400-148	3918
88Q-400-115	3898
88Q-400-133	4211
88Q-500-121	3900
89Q-250-137	3654
89Q-300-139	2704
89Q-350-106	3689
89Q-350-134	3662
89Q-400-054	3632
89Q-400-125	3614
89Q-500-117	3676
91-300	9589
91-350	9590
91-400	9591
91-500	9592
91-550	9593
91-600	9594
91-700	9595
91-800	9596
92-300	924003
92-400	924004
92-500	924005
92-550	925506
92-600	926006
92-700	927006
93-400	924105
93-500	925005
93-550	925505
93-600	926005
93-700	927005
94-400	924104
94-500	925105
94-550	925504
94-600	926004
94-700	927004
95-5540	925543
95-5550	925553
95-6050	926503

DYNAFLEX	DIESELTECH
95-6055	926553
96-6055	926557
96-7050	927557
97-5040	925458
97-5550	925558
97-6050	926508
97-6055	926658
D13-0034	3928

ECS	DIESELTECH
8-40	9591
10-40	400C1016
8-50	9592
10-50	500C1016
8-60	9594
10-60	600C1016
8-70	9595
8-80	9596
6-3275	H234P
7-5545	925505
7-5590	925506
10-20SSHD	200S1016
10-25SSHS	212S1014
10-30SSHD	300S1014
1-200	10671
1-250	10672
1-300	10675
1-300PE	10778
1-350	10305
13-902	14337
13-903	14339
13-904	14341
13-905	14605
13-935	14340
1-400	10678
14-020	8933
14-025	8939
14-035	9599
14-040	8991
14-050	8978
1-416PE	10797
15-450	8958
1-617PE	10309
2-245	10311
2-345	10313
2-445	10315
25-1026-120	8894
25-2020	8868
25-22520	8870
25-2520	8872
25-3020	8875
25-3020-120	8986

## AFTERMARKET INTERCHANGE ////

ECS	DIESELTECH	ECS	DIESELTECH	ECS	DIESELTECH	ECS	DIESELTECH
25-3026	8880	350-047	9354	4311-336	34713	4315-253	8953
25-3026-120	8986	350-048	9355	4311-348	44854	4315-253-1	9600
25-3520-120	8987	350-049	8445	4311-3536	34714	4315-253-2	8960
25-3520-18	24753	350-050	9356	4311-3548	44731	4315-335	8955
25-3526	8881	350-051	9357	4311-418	24711	4315-335-1	9333
25-3526	8881	350-056	9360	4311-424	24737	4315-335-2	8962
25-3526-120	8987	4011-348	844002	4311-436	34715	4315-340	8956
25-4020	8882	4011-436	834004	4311-448	44656	4315-340-1	9722
25-4020-12	14738	4012-318	824000	4311-460	54991	4315-340-2	8963
25-4020-120	8988	4012-3518	824001	4311-518	24712	4315-340-3	9648
25-4020-18	24754	4012-3536	834000	4311-524	24739	4315-354	8957
25-4020-24	24835	4012-360	854000	4311-536	34716	4315-354-1	9332
25-4020-36	34743	401-410	809770	4311-548	44658	4315-354-2	8964
25-4026	8882	401-416	809406	4311-560	54720	4315-450	8958
25-4026-120	8988	401-508PE	809796	4311-648	44863	4315-450-1	9331
2-5458-14	10731	401-509	809547	431-200	10301	4315-450-2	8965
25-5020	8877	401-512	809546	431-200PE	10773	4315-450-3	9649
25-5020-12	14740	401-568PE	809530	4312-3518	24938	4315-560	9335
25-5020-120	8989	401-5822L	868186	4312-3536	34827	4315-560-1	8969
25-5020-18	24755	401-5822R	868184	4312-418	24713	4315-560-2	9336
25-5020-24	24837	402-5458	809738	4312-424	24746	4315-560-3	9650
25-5020-36	34744	402-5458PE	809752	4312-436	34719	431-568PE	10560
25-5020-48	54831	404-509	809771	4312-448	44664	431-5822L	68183
25-5026	8877	406-230	9490	4312-460	54721	431-5822R	68185
25-5026-120	8989	406-240	9492	431-250-10	10303	431-589045Y	94942
25-6020-120	8990	406-250	9493	431-250-12PE	10774	431-5904026Y	94011
25-6026	8898	406-260	9495	4312-518	24714	431-59044Y	94941
25-6026-120	8990	406-540	9486	4312-524	24747	431-617	10556
25-8026-120	8893	406-550	9487	4312-536	34720	4316-400	92695
26-3020-120	8859	409-400	9573	4312-548	44666	4316-404	92673
26-3520-120	8876	409-500	9575	4312-560	54722	4316-449011	92679
26-4020-120	8856	420-436	834002	431-300	10675	4316-500	92697
26-4020-18	24931	426-255	T5122	431-300PE	10534	4316-5530	92674
26-4020-24	24835	426-260	H600	431-350	10676	4316-559016	92689
26-5020-120	8857	426-330	H300PZ	431-350PE	10535	4317-318	24344
302-2020	8883	426-340	H400PZ	4313-903	14601	4317-348	34828
302-2520	8884	426-350	H500PZ	4313-904	14603	4317-3518	24345
302-3020	8982	426-530	T300Z	4313-905	14605	4317-418	24717
302-3020-120	8885	426-535	T3122	4313-906	8974	4317-424	24748
302-3520	8983	426-540	T400Z	4313-935	14602	4317-436	34723
302-3520-120	8886	426-550	H500	431-400	10678	4317-448	44665
302-4020	8878	4310-20	200A1014	4314-030	8975	4317-460	54725
302-4020-12	14739	4310-25	212A1014	4314-035	8976	4317-518	24718
302-4020-120	8887	4310-30	300A1016	4314-040	18103	4317-524	24750
302-4020-18	24677	4310-35	312A1016	4314-050	8978	4317-536	34724
302-4020-24	24836	4310-35	312A1016	4314-060	8979	4317-548	44667
302-4020-36	34673	4310-40	400A1014	431-410PE	10783	4317-560	54726
302-5020	8879	4310-448	44657	431-416	10762	432-2545	10312
302-5020-12	14737	4310-460	54984	431-416PE	10537	432-2545	10725
302-5020-120	8888	4310-50	500A1016	431-508	10764	432-2545PE	10562
302-5020-18	24678	4310-536	34829	431-512	10554	432-345	10313
302-5020-24	24838	4310-548	44659	431-515	10765	432-345PE	10564
302-5020-36	34674	4310-560	54985	431-515PE	10540	432-3545	10314
302-6020	8899	4310-60	600A1016	431-518	10308	432-3545	10314

CROSS  
REFERENCE



## AFTERMARKET INTERCHANGE



CROSS  
REFERENCE

ECS	DIESELTECH	ECS	DIESELTECH	ECS	DIESELTECH	ECS	DIESELTECH
432-3545PE	10565	4-515PE	10796	7-850	925105	D12-3430	2704
432-4015PE	10684	56-9514-4	9456	7-855	925504	D12-4000	3651
432-4030PE	10636	56-9514-5	9457	7-860	926004	D12-4002	3652
432-445-12	10727	56-9515-10	9453	7-870	927004	D13-0005	3933
432-445-12PE	10745	56-9515-9	9452	8-275	9589	D13-0036	3939
432-445-8	10726	56-9818	9430	8-325	9590	D13-0079	4227
432-445-8PE	10566	56-9824	9811	8-525	9593	D13-0099	3640
432-5015PE	10685	57-5481	809458	88-306	9395	D13-0103	3970
432-5030PE	10637	57-6480	809307	88-313	9618	D13-0110	4233
432-5458	10729	57-9513-10	809429	88-350	9473	D13-0114	4228
432-5458-14	10732	57-9713-10	809500	88-365	9626	D13-0117	3917
432-5458-14PE	10747	58-51-4	SBC400	88-384	9398	D13-0123	3895
432-5458PE	10746	58-51-5	SBC500	88-400	9474	D13-0196	3891
432-5508PE	38614	58-51-6	SBC600	88-401	9611	D13-1095	3916
433-300	10337	58-52-4	SBF400	88-407	9622	D13-1134	3920
433-350	10338	58-52-5	SBF500	88-414	9627	D13-1147	4225
433-400	10339	58-52-6	SBF600	88-415	9476	D13-1156	3704
433-500	10340	6-230	9501	88-419	9613	D13-1161	3851
434-302PE	10776	6-235	9502	88-449	9614	D13-1179	3653
434-345-7PE	10742	6-240	9503	88-462	9617	D13-1188	3871
434-352PE	10794	6-250	9504	88-463	9653	D13-1585	3617
434-402	10681	6-260	9506	88-469	9399	D13-1626	4246
434-402PE	10781	6-330	H300P	88-479	9647	D13-2006	3898
434-4317PE	10788	6-335	H312PZ	88-482	9619	D13-2008	3676
434-45545L	38611	6-530	T300	88-487	9718	D13-2011	3900
434-45545R	38612	6-535	T312	88-506	9615	D13-2012	3614
434-503PE	10784	67-200	9664	88-569	9616	D13-2017	3670
434-509	10557	67-225	9665	90-410	9341	D13-2018	3662
434-509PE	10789	67-250	9666	90-510	9342	D13-2025	3647
434-545-12PE	10567	67-275	9667	90-520	9344	D13-2032	3684
434-548PE	10788	67-300	9668	9-150	9896	D13-2034	3150
4-352	10795	67-350	9669	9-175	9897	D13-2036	3720
4367-200	9660	67-400	9623	9-200	9371	D13-2039	3714
4367-225	9661	67-450	9670	9-225	9370	D13-2041	3689
4367-250	9662	67-500	9624	9-250	9372	D13-2045	3711
4367-300	9604	67-600	9671	9-275	9378	D13-2070	3931
4367-350	9605	68-350	B312	9-300	9373	D13-2074	3912
4367-400	9606	68-600	B600	9-350	9374	D13-2076	3923
4368-350	9678	7-390	924003	9-400	9375	D13-3590	3679
4368-400	9680	7-445	924105	9-450	9376	D13-4023	3919
4368-500	9682	7-490	924004	9-500	9377	D13-4060	3625
4368-500	9682	7-524	925458	9-550	9704	D13-4070	4224
4368-600	9683	7-524	925558	9-600	9369	D13-4095	3712
4369-400	AS400	7-545	925005	D10-0902	45	D13-4104	3707
4369-500	AS500	7-554	925543	D12-2002	2156	D13-4284	3677
4388-302	9708	7-555	925553	D12-2275	3697	D13-4285	3918
4388-353	9710	7-590	924005	D12-2276	3914	D13-4288	4211
4388-413	9475	7-645	926005	D12-2350	3613	D13-4510	3714
4388-503	9478	7-650	926503	D12-2575	3654	D13-4515	3715
4388-504	9393	7-65590	926557	D12-2580	3908	D13-4515	3715
4-402	10681	7-690	926006	D12-3030	3627	D13-4515	3893
4-4313PE	10786	7-75590	927557	D12-3047	609	D13-4525	4218
4-4315PE	10787	7-790	927006	D12-3255	3663	D13-4590	3666
4-509	10557	7-840	924104	D12-3260	3719	D13-4595	3890

## AFTERMARKET INTERCHANGE ///

ECS	DIESELTECH
D13-5010	3699
D13-5090	3667
D13-5090	3667
D13-5510	3640
D13-5520	3873
D13-5550	3702
D13-5590	3897
D13-5590	3897
D13-6001	3610
D13-6035	3668
D13-6040	3632
D13-6045	3710
D13-6289	3703
D13-6290	3915
D13-6291	3611
D13-6295	3716
D13-6295	4242
D13-7550	3932
D13-7594	3683
D13-7595	3685
D13-7599	3913
D13-7601	3880
D13-7602	3721
D13-7604	3995
D13-7605	3925
D13-7606	3626
D13-7628	3699
D13-7635	3875
D13-7636	3708
D13-7637	3888
D13-7643	3705
D13-7650	3872
D13-7674	3924
D13-7679	3669
D14-0021	3884
D14-0123	3706
D14-0159	3698
D14-0244	3878
D14-0528	3887
D14-0533	3889
D14-0597	3645
D15-0002	4223
D15-0003	3690
D15-0004	3691
D15-0005	3692
D15-0006	3693
D15-0007	3694
D15-0008	3695
D16-0001	3681
D16-0002	3682
D16-0003	3618
D99-0087	4251
Q-118-02	3894
Q-163-02	3883

ECS	DIESELTECH
Q-164-02	3882
Q-166-02	3911
Q-168-02	3881

EII-Con	DIESELTECH
A-200A	10670
A-250A	10672
A-300A	10756
A-31414A	10304
A-350A	10676
A-351616A	10305
A-402A	10681
A-402K	809621
A-41212A	10761
A-41212K	809770
A-41818A	10306
A-41818K	809406
A-503K	809771
A-510A	10554
A-512A	10766
A-51515A	10765
A-51515K	809546
A-52020A	10308
A-52020K	809408
A-555A	10557
AA-324	24941
AA-336	34713
AA-348	44854
AA-3524	24735
AA-3536	34714
AA-3548	44731
AA-418A	24711
AA-424A	24737
AA-436A	34715
AA-436K	834004
AA-448A	44656
AA-460A	54991
AA-518A	24712
AA-524A	24739
AA-536A	34716
AA-548A	44658
AA-560A	54720
AA-648	44863
AB-336	24744
AB-3516	24938
AB-3516K	824001
AB-3536	34827
AB-3536K	834000
AB-360K	854000
AB-418A	24713
AB-424A	24746
AB-436A	34719

EII-Con	DIESELTECH
AB-448A	44664
AB-460A	54721
AB-518A	24714
AB-524A	24747
AB-536A	34720
AB-548A	44666
AB-560A	54722
AB-624	24696
AC-304	14339
AC-308	14601
AC-354	14340
AC-358	14602
AC-404	14341
AC--408	14603
AC-508	14605
AC-604	8974
AD-306	8975
AD-356	8976
AD-406	8991
AD-506	8978
AD-604	8979
AE-335	8955
AE-340	8956
AE-354	8957
AE-450	8958
AE-560	9335
AF-400	92679
AF-404L	92695
AF-500	92689
AF-510	94941
AF-512A	94011
AF-520	94942
AF-555L	92697
A-FL1013	10786
A-FL1015	10787
A-FL13974	94010
A-FL5100	28655
AG-348	34828
AG-418A	24717
AG-424A	24748
AG-436A	34723
AG-448A	44665
AG-460A	54725
AG-518A	24718
AG-524A	24750
AG-536A	34724
AG-548A	44667
AG-560A	54726
AH-318	24674
AH-3518	24935
AH-418	24654
AH-518	24936
AI-1000	9358
AI-1180	9360

EII-Con	DIESELTECH
AI-1500	9359
AI-250	9361
AI-300	9363
AI-350	9364
AI-400	9365
AI-500	9366
AI-600	9354
AI-700	9355
AI-800	9580
AI-850	9356
AI-900	9357
AJ-30A	300A1014
AJ-35A	312A1016
AJ-40	400C1016
AJ-40A	400A1016
AJ-436MCA	834002
AJ-45	412A1016
AJ-460A	54984
AJ-50	500C1016
AJ-50A	500A1016
AJ-548A	44659
AJ-560A	54985
AJ-60	600C1016
A-KW14122A	38610
A-KW52424LK	868184
A-KW52424RK	868186
A-KW5242LA	68183
A-KW5242RA	68185
A-KW54764L	38611
A-KW54764R	38612
AL-530A	10633
AL560A	10641
AL-P530A	10637
ALP560A	10645
A-P300A	10534
A-P351212A	10535
A-P41818A	10537
A-P44915A	10538
A-P508K	809796
A-P51515A	10540
A-P51616A	10796
A-P52020A	10309
A-P555A	10791
A-PB5710	10560
A-PB5710K	809530
B-345A	10313
B-3545A	10313
B-445A	10726
B-445LA	10315
B-51212A	10317
B-5458LK	809738
B-545A	10729
BA-430	8963
BA-435	8964

CROSS REFERENCE

## AFTERMARKET INTERCHANGE



CROSS  
REFERENCE

EII-Con	DIESELTECH
BA-540	8965
BA-650	9336
BD-534K	834007
BE-2010	8984
BE-2026	8868
BE-22526	8869
BE-2510	8985
BE-2526	8872
BE-3010	8986
BE-3026	8875
BE-318	24752
BE-324	24930
BE-336	34826
BE-3510	8987
BE-3518	24753
BE-3524	24849
BE-3526	8881
BE-3536	34785
BE-4010	8988
BE-4026	8882
BE-412	14738
BE-418	24754
BE-424	24835
BE-436	34743
BE-448	44786
BE-5010	8989
BE-5026	8877
BE-512	14740
BE-518	24755
BE-524	24837
BE-536	34744
BE-548	54831
BE-6010	8990
BE-6026	8898
BF-2010	8883
BF-22510	8855
BF-2510	8884
BF-3010	8885
BF-3020	8982
BF-318	24675
BF-3510	8886
BF-3518	24676
BF-3520	8983
BF-4010	8887
BF-4020	8878
BF-412	14739
BF-418	24677
BF-424	24836
BF-436	34673
BF-5010	8888
BF-5020	8879
BF-512	14737
BF-518	24678
BF-524	24838

EII-Con	DIESELTECH
BF-536	34674
BF-548	44867
BF-6010	8895
BF-6020	8899
BH-450	9649
BH-560	9650
BJ-335	9333
BJ340	9722
BJ-354	9332
BJ-450	9331
BJ-560	8969
B-P3545LA	10565
B-P445A	10743
B-P445LA	10745
B-P51212A	10747
B-P51212K	809753
B-P5458LA	10746
B-P5458LK	809752
C-300	10337
C-350	10776
C-350	10794
C-400	10780
D-302	10777
D-352	10329
D-399A	10778
D-402A	10781
D-503A	10784
D-503K	809795
D-548A	10541
D-S1507	10684
D-S1508	10685
E-102	3891
E-103	3667
E-104	3897
E-106	3682
E-107	3666
E-108	3679
E-109	3681
E-110	3625
E-111	3714
E-112	3699
E-113	3890
E-114	3873
E-123	3683
E-130	3721
E130-39	3652
E-131	3875
E-135	3720
E-1351	3618
E-140	3887
E-1413	3889
E-203	3654
E-204	3906
E-206	3669

EII-Con	DIESELTECH
E-208	3662
E-210	3663
E-301	3668
E-302	3614
E-303	3677
E-31505	3647
E-401	3670
E-502	3900
E-704	3678
E-705	3931
E-707	3702
E-720	3690
E-725	3691
E-730	3692
E-735	3693
E-740	3694
E-750	3695
EE-5482K	809458
EF-10270	9724
EF-8510	9804
EF-8551	9451
EF-8551	9805
EF-9270	9725
EF-9515	9806
EF-9516	9801
EF-9517	9803
EF-9518	9430
EF-9519	9810
EF-9520	9807
EF-9524	9811
EG-6483S	809307
EG-9421S	809302
EG-9502S	809429
F-2350	B312
F-2350APF	9605
F-2350PF	9669
F-2400	B400
F-2400APF	9606
F-2400PF	9623
F-240K	9492
F-240Z	9503
F-2500	B500
F-2500PF	9624
F-250K	9504
F-250Z	9493
F-2600	B600
F-2600PF	9671
F-260K	9495
F-260Z	9506
F-320	H200
F-325	H214
F-3275	H234
F-330	H300
F-330Z	H300Z

EII-Con	DIESELTECH
F-3325	H314
F-335	H312
F-335Z	H312PZ
F-340	H400
F-340Z	H400Z
F-345	H412
F-345Z	H412PZ
F-350	H500
F-350Z	H500Z
F-360	H600
F-360Z	H600Z
F-5275	T234
F-5300	T300
F-5300Z	T300Z
F-5325	T314
F-5350	T312
F-5350Z	T312Z
F-5400	T400
F-5400K	9486
F-5400Z	T400Z
F-5450Z	T412Z
F-5500	T500
F-5500K	9487
F-5500Z	T500Z
F-5550Z	T512Z
F-5600	T600
F-5600K	9734
F-5600Z	T600Z
F-640K	SBC400
F-650K	SBC500
F-660K	SBC600
G-390	924003
G-445	924105
G-490	924004
G-5245	925458
G-545	925005
G-5525	925558
G-5545	925505
G-5545	925543
G-555	925553
G-5590	925506
G-590	924005
G-625	926508
G-6255	926658
G-645	926005
G-650	926503
G-655	926553
G-65590	926557
G-690	926006
G-745	927005
G-75590	927557
G-790	927006
G-840	924104
G-850	925105

## AFTERMARKET INTERCHANGE ///

Eii-Con	DIESELTECH
G-855	925504
G-860	926004
G-870	927004
GC-690	926101
H-30	9589
H-35	9590
H-40	9591
H-50	9592
H-55	9593
H-60	9594
H-70	9595
H-81	9596
HH-300	9470
HH-306	9395
HH-316	9612
HH-326	9611
HH-350	9391
HH-356	9396
HH-400	9474
HH-401	9617
HH-406	9399
HH-416	9614
HH-436	9619
HH-456	9616
HH-503	9476
HH-506	9615
HH-507	9652
HH-511	9397
HI-480	9586
HI-484	9518
HI-568	9719
I-150	9896
I-175	9897
I-200	9371
I-225	9370
I-250	9372
I-275	9378
I-300	9373
I-300K	9571
I-350	9374
I-400	9375
I-400K	9573
I-450	9376
I-500	9377
I-500K	9575
I-550	9704
I-600	9369
IJ-401	9341
IJ-402	9343
IJ-501	9342
IJ-502	9344
MT-21698P1	28528
MT-32612	68182

FlexaTube	DIESELTECH
01300	8875
02300	T300Z
02312	T312Z
02400	T400Z
02500	T500Z
04312	H312
04400	H400
04500	H500
04600	9354
10300	8880
10350	8881
10350	8881
10400	8882
10500	8877
17220	B200
17225	B214
17250	B212
17275	B234
17330	B300
17350	B312
17400	9623
17440	B400
17500	9624
17550	B500
17660	B600
20300	8986
20350	8987
20400	8882
20500	8877
33300	24752
33350	24753
33400	24754
33500	24755
35300	24930
35350	24849
35400	24835
35500	24837
39300	34826
39350	34785
39400	34743
39500	34744
40300	8885
40350	8886
40400	8887
40500	8888
44400	24836
44500	24838
46400	34673
46500	34674
48300	24675
48350	24676
48400	24677
48500	24678
50300	8982

FlexaTube	DIESELTECH
50350	8983
50400	8878
50500	8879
54400	9503
54500	9504
54600	9506
69400	10306
69401	10537
69403	809406
69500	10308
70300	9373
70350	9374
70400	9375
70500	9377
71400	10681
71401	10539
71500	10557
71501	10540
72400	10315
72401	10566
72500	10317
73400	92673
73402	92679
73500	92674
80013	14338
91150	112A1016
91175	134A1016
91200	200A1016
91225	214A1016
91250	212A1016
91275	234A1016
91300	300A1016
91350	312A1016
91400	400A1016
91500	500A1016
93300	14618
93301	24344
93400	24713
93401	24346
93500	24714
93501	24718
94436	34719
94448	44664
94460	54721
94536	34720
94548	44666
94560	54722
95436	34723
95448	44665
95536	34724
95548	44667
95560	54726
96300	9334
96301	8954

FlexaTube	DIESELTECH
96400	9332
96401	8957
96500	9331
96501	8958
96550	8978
99300	14601
99400	14603
99500	14605
50500X4	44867
94436SC	34715
94448SC	44656
94536SC	34716
94548SC	44658
94560SC	54720
95448SC	44657
95460SC	54984
95548SC	44659
FLX-459M	3712
FLX-5510M	3699

GRAND ROCK	DIESELTECH
CN-356A	8976
CN-36A	8975
CN-46	8991
CN-46A	18103
CN-56A	8978
CN-56A	8978
CN-66	8979
CP-358	14340
CP-358A	14602
CP-38	14339
CP-38A	14601
CP-48	14341
CP-48A	14603
CP-58A	14605
CP-58A	14605
CP-66A	8974
DISPLAY	HD3050
ED-5LC	834007
EZ-2	B200
EZ-225	B214
EZ-25	B212
EZ-275	B234
EZ-3	B300
EZ-35	B312
EZ-35A	9678
EZ-4	B400
EZ-5	B500
FB-3	9501
FB-35	9502
FB-4C	9492
FB-4ZN	9503

CROSS REFERENCE

## AFTERMARKET INTERCHANGE



CROSS  
REFERENCE

GRAND ROCK	DIESELTECH	GRAND ROCK	DIESELTECH	GRAND ROCK	DIESELTECH	GRAND ROCK	DIESELTECH
FB-5C	9493	K4-36EXA	34719	L445-0909	10315	M-106	3611
FB-5ZN	9504	K4-36SBA	34723	L445-0909A	10315	M-115	3898
FB-6C	9495	K4-48EXA	44664	L445-1212A	10727	M-121	3900
FB-6ZN	9506	K4-48SBA	44665	L445-1212SA	10745	M-127	3625
FL-15653-0	28699	K4-60EXA	54721	L460-1010A	10640	M-130-4	3893
FL-17094-012	28698	K4-60SBA	54725	L460-1010SA	10644	M-131	3891
GF-3120	8986	K5-18EXA	24714	L490-0808A	10681	M-131	3891
GF-318	24752	K5-18SBA	24718	L490-0808A	10681	M-132	3667
GF-3300	8880	K5-24EXA	24747	L490-0808S	10780	M-132	3667
GF-336	34826	K5-24SBA	24750	L490-1010SA	10781	M-144	3681
GF-35120	8987	K5-36EXA	34720	L490-1212A	10761	M-145	3682
GF-3518	24753	K5-36SBA	34724	L490-1212C	809770	M-147	3647
GF-3524	24849	K5-48EXA	44666	L490-1212SA	10539	M-149	3678
GF-35300	8881	K5-48SBA	44667	L490-1212SA	10783	M-153	3632
GF-35300	8881	K5-60EXA	54722	L490-1515A	10761	M-187	3721
GF-3536	34785	K5-60SBA	54726	L490-1515A	10762	M-188	3720
GF-412	14738	KW-10742LC	68183	L490-1515A	10762	M-220	3706
GF-4120	8988	KW-10742RC	68185	L490-1515SA	18148	M-444	3714
GF-418	24754	KW-14764L	38611	L490-1818	10306	M-465	3699
GF-424	24835	KW-14764R	38612	L490-1818A	10306	M-465	3699
GF-4300	8882	KW-14766	94942	L490-1818C	809406	M-511	3703
GF-4300	8882	KW-6326	38613	L490-1818SA	10797	M-512	3716
GF-436	34743	KW-8049	38614	L515-0404SA	10685	M-514	3712
GF-448	44786	L345-0808A	10313	L530-0404A	10633	M-526	3702
GF-512	14740	L345-0808SA	10564	L530-0404SA	10637	M-530	3919
GF-5120	8989	L3530-0404	10631	L545-0808A	10729	M-537	3704
GF-518	24755	L3545-0909	10314	L545-0808C	809738	M-542	3931
GF-524	24837	L3545-0909A	10314	L545-0808SA	10567	M-557	3872
GF-5300	8877	L3545-0909SA	10565	L545-0808SC	809752	M-595	3895
GF-5300	8877	L3560-0808A	10639	L545-1212A	10317	M-672	3698
GF-536	34744	L3590	10338	L545-1212SA	10747	MB-5PBS	SB500
GF-548	54831	L3590-0808SA	10329	L545-1515A	10732	MB-6PBS	SB600
GF-6300	8898	L3590-0808SA	10329	L545-1515SC	809753	MG-10270BRKT	9799
GH-18S	9430	L3590-1212A	10676	L560-1010A	10641	MG-1042RA	809303
GH-24S	9811	L3590-1212A	10759	L560-1010SA	10645	MG-1048RA	809304
H-10	8483	L3590-1212S	10329	L590	10541	MG-85CBRKT	9451
IH-167C1	38608	L3590-1212SA	10535	L590-0808SA	809795	MG-9270S	809500
IH-845C1	38607	L3590-1616A	10305	L590-1010A	10764	MG-9CBRKT	9806
JDS-4A	54827	L3590-1616SA	10536	L590-1010C	809547	MG-S	809429
K3-12EXA	14618	L390-0505SA	10337	L590-1010SA	10784	MK-21698	28528
K3-12SBA	24344	L390-0707A	10675	L590-1212	10557	MK-32612	68182
K3-48SBA	34828	L390-0707SA	10777	L590-1212A	10557	OMH-1015	9359
K35-12EXA	14619	L390-0808A	10675	L590-1212C	809771	OMH-8511	9360
K35-12SB	24345	L390-1010A	10757	L590-1212SA	10789	PB-01726	10560
K35-18EXA	24938	L390-1010SA	10534	L590-1215SA	10787	PB-0455Y	94941
K35-18EXC	824001	L390-1414	10304	L590-1515C	809408	PB-13002	18166
K35-36EXA	34827	L390-1414A	10758	L590-1515S	10791	PB-13055Y	94011
K35-36EXC	834000	L390-1414SA	10778	L590-1515SA	10540	PB-13056C	809519
K4-12EXA	14620	L415-0404A	10684	L590-1515SC	809796	PB-13394	10799
K4-12SBA	24346	L430-0404A	10632	L590-1818	10765	PB-15353Y	94015
K4-18EXA	24713	L430-0404SA	10636	L590-1818C	809546	PF-25A	9662
K4-18SBA	24717	L445-0606A	10726	L590-1818S	10309	PF-275	9667
K4-24EXA	24746	L445-0606SA	10743	L590-520	10308	PF-3	9668
K4-24SBA	24748	L445-0808SA	10566	L690-1313A	10556	PF-35	9669

## AFTERMARKET INTERCHANGE ///

GRAND ROCK	DIESELTECH
PF-35A	9605
PF-3A	9604
PF-4	9623
PF-4A	9606
PF-5	9624
PF-6P	9671
PG 4CBRKT	9456
PG 5CBRKT	9803
PG 9CBRKT	9452
PG10CBRKT	9453
PG-548	809308
PG-5CBRKT	9457
PG-648C	809307
PG-6CBRKT	9810
PG-S	809458
R351-30A	8962
R351-31A	8955
R350-31A	9333
R40-30A	9648
R41-30A	8963
R41-351A	8957
R41-350A	8964
R41-31A	8956
R40-351A	9332
R40-31A	9722
R50-40A	9649
R51-41A	8958
R51-451A	9721
R51-41A	8958
R51-40A	8965
R50-41A	9331
R60-40A	9720
R61-51A	9335
R61-50A	9336
R60-51A	8969
R60-50A	9650
RB-225ZN	U214
RB-25ZN	U212
RB-275ZN	T234
RB-22N	U200
RB-325	T314
RB-35ZN	T312Z
RB-3ZN	T300Z
RB45ZN	T412Z
RB-4C	9486
RB-4ZN	T400Z
RB-5C	9487
RB-5ZN	T500Z
RB-6C	9734
RB-6ZN	T600Z
RC-200	9371
RC-225	9370
RC-250	9372
RC-300	9373

GRAND ROCK	DIESELTECH
RC-350	9374
RC-400	9375
RC-400	9375
RC-400C	9573
RC-450	9376
RC-500	9377
RC-500	9377
RC-500C	9575
RC-600	9369
RMH-10	9358
RMH-11	9628
RMH-85	9580
RMH-9	9357
S3-120EXA	923120
S3-120SB	300A1016
S3-120SBA	300A1014
S3-24EXA	24941
S3-48EXA	44854
S35-120SB	312A1016
S35-120SBA	312A1016
S35-18EXA	9599
S35-24EXA	24735
S35-36EXA	34714
S35-48EXA	44731
S35-6SBA	8971
S3-6SBA	8970
S4-120SB	400C1016
S4-120SBA	400A1016
S4-18EXA	24711
S4-24EXA	24737
S4-36EXA	34715
S4-36EXC	834004
S4-48EXA	44656
S4-48SBA	44657
S4-60EXA	54991
S4-60SBA	54984
S4-6SBA	8972
S5-120EXA	924120
S5-120SB	500C1016
S5-120SBA	500A1016
S5-18EXA	24712
S5-24EXA	24739
S5-36EXA	34716
S5-48EXA	44658
S5-48SBA	44659
S5-60EXA	54720
S5-60SBA	54985
S5-6SBA	8973
S6-120SB	600C1016
S6-120SBA	600A1016
S6-48EXA	44863
S8-120SBA	800A1016
SF-3120	8885
SF-35120	8886

GRAND ROCK	DIESELTECH
SF-4120	8887
SF-418	24677
SF-424	24836
SF-4300	8878
SF-436	34673
SF-5120	8888
SF-518	24678
SF-524	24838
SF-5300	8879
SF-536	34674
T362-6ID	9470
T375-6	9390
T400-6	9710
T407-4	9709
T425-6ID	9473
T450-6	9475
T450-6	9714
T475-4	9474
T475-4ID	9476
T525-4	9718
T550-6	9393
T588-6	9478
T588-6PYRO	9629
T6-433A	92698
TBA-4	9343
TBE-4	9341
TBE-5	9342
VB-419C	9622
VB-461M	9614
VB-475C	9653
VB-475D	9617
VB-525D	9652
VB-588C	9615
Y-400A	92673
Y-401NPA	92695
Y-500A	92674
Y-500NPA	92697
Y-501NPA	92696
YB500A	92689

HD MFG	DIESELTECH
30566	3931
31001	3607
31004	3654
31008	609
31015	2704
31018	3662
31020	3891
31021	3667
31021	3667
31021	3897
31022	3891

HD MFG	DIESELTECH
31023	3897
31024	3682
31025	3679
31026	3689
31031	3669
31032	3670
31035	3676
31036	3614
31037	3647
31038	3687
31045	3893
31063	3640
31074	3970
31076	3955
31081	3925
31084	3683
31085	3618
31096	3625
31102	3626
31104	3627
31109	3681
31119	3666
31123	3632
31127	3611
31129	3716
31133	3705
31136	3636
31139	3677
31142	3637
31150	3702
31163	3873
31164	3714
31164	3714
31165	3699
31165	3699
31179	3898
31200	3900
31202	3678
31214	3704
31218	3698
31219	687
31226	3610
31230	3711
31233	3707
31249	3938
31252	3888
31253	3895
31388	3930
31479	3928
31514	3712
4-4285	809303
10-200A	200A1016
10-250A	212A1016
10-275A	234A1016

CROSS REFERENCE

## AFTERMARKET INTERCHANGE



CROSS  
REFERENCE

HD MFG	DIESELTECH	HD MFG	DIESELTECH	HD MFG	DIESELTECH	HD MFG	DIESELTECH
10-300A	300A1016	12-400FS	10761	1-300-36A	34713	16-350-10S	8886
10-350A	312A1016	12-410CP	809621	1-300-48	44854	16-350M	8881
10-400	400C1016	12-488A	10681	1-300-48CP	844002	16-350M	8881
10-400A	400A1016	12-488A	10681	13-300	9363	16-350S	8983
10-450	412A1016	12-500A	10308	13-350	9364	16-400-10M	8988
10-500	500C1016	12-500CP	809408	13-400	9365	16-400-10M	8988
10-500A	500A1016	12-500F	10765	13-500	9366	16-400-10S	8887
10-500A	500A1016	12-500FA	10554	1-350-18A	9599	16-400M	8882
10-550A	512A1016	12-500FCP	809546	1-350-24A	24735	16-400M	8882
10-600	600C1016	12-510A	10557	1-350-36A	34714	16-400S	8878
10-600A	600A1016	12-510A	10557	1-350-48A	44731	16-500-10M	8989
11-300-45A	10313	12-510CP	809771	13-FMB-1	9352	16-500-10M	8989
11-350-30A	10631	12-512A	10680	13-FMB-2	9353	16-500-10S	8888
11-350-45A	10314	12-512CP	809547	13P-500CP	SB500	16-500M	8877
11-350-45A	10314	12A-300A	10777	13P-600CP	SB600	16-500M	8877
11-350-60A	10639	12A-350A	10794	1-400-18A	24711	16-500S	8879
11-400-30A	10632	12A-350FA	10329	1-400-24A	24737	16-600-10M	8990
11-400-45A	10315	12A-400A	10783	1-400-36A	34715	16-600-10M	8990
11-400-60A	10640	12A-440A	10781	1-400-36CP	834004	16-600-10S	8895
11-500-30A	10633	12A-550	10785	1-400-48A	44656	16-600M	8898
11-500-45	10732	12A-550A	10789	1-400-60A	54991	16-600S	8899
11-500-45A	10317	12A-550CP	809795	14-400A	92673	17-350-18A	24935
11-500-60A	10641	12A-555A	10541	14-500A	92674	17-400-18	24654
11A-300-45	10564	12B-300A	10778	14B-400	92679	17-500-18A	24936
11A-350-45	10565	12B-300FA	10534	14B-500	92689	17B-300-18	24752
11A-400-15A	10684	12B-350A	10536	14F-5974A	94010	17B-300-18SS	24675
11A-400-30A	10636	12B-350FA	10535	14K-14766A	94942	17B-300-36	34826
11A-400-45A	10566	12B-400A	10537	14P-04055A	94941	17B-350-18	24753
11A-400-45A	10745	12B-400F	18148	14P-13055A	94011	17B-350-18SS	24676
11A-400-60A	10644	12B-400FA	10539	1-500-120A	924120	17B-350-24	24849
11A-500-15A	10685	12B-410A	10538	1-500-18A	24712	17B-350-36	34785
11A-500-30A	10637	12B-500	10309	1-500-24A	24739	17B-400-12	14738
11A-500-45A	10747	12B-500FA	10796	1-500-36A	34716	17B-400-12SS	14739
11A-500-45CP	809753	12B-512	10791	1-500-48A	44658	17B-400-18	24754
11A-500-60A	10645	12B-512CP	809796	1-500-60A	54720	17B-400-18SS	24677
11B-400-45A	10736	12F-5013A	10786	15-1000	9358	17B-400-24	24835
11S-500-45A	10729	12K-107LCP	868184	15-1015	9359	17B-400-24	24835
11S-500-45CP	809738	12K-107RCP	868186	15-600	9354	17B-400-24SS	24836
12-107L	68183	12K-14122A	38610	15-700	9355	17B-400-36	34743
12-107R	68185	12K-14764LA	38611	15-800	9580	17B-400-36SS	34673
12-300A	10304	12K-14764RA	38612	15-850	9356	17B-400-48	44786
12-300F	10675	12K-6326A	38613	15-8511	9360	17B-500-12	14740
12-300F	10675	12K-8049A	38614	15-900	9357	17B-500-12SS	14737
12-300FA	10758	12M-21698A	28528	16-200M	8868	17B-500-18	24755
12-300FS	10756	12M-32611SA	68181	16-200M	8868	17B-500-18SS	24678
12-350A	10305	12M-32612RA	68182	16-250M	8872	17B-500-24	24837
12-350A	10305	12M-32618A	38761	16-250M	8872	17B-500-24SS	24838
12-350FA	10759	12N-503841A	28534	16-300-10M	8986	17B-500-36	34744
12-350FS	10795	12N-503845A	38607	16-300-10M	8986	17B-500-36SS	34674
12-350FSA	10676	12N-582167A	38608	16-300-10S	8885	17B-500-48A	54831
12-400A	10306	12P-1726A	10560	16-300M	8880	17B-500-48SS	44867
12-400A	10306	12P-1726CP	809530	16-300S	8982	18-200	U200
12-400CP	809406	1-300-120A	923120	16-350-10M	8987	18-200	U200
12-400FCP	809770	1-300-24A	24941	16-350-10M	8987	18-225	U214

## AFTERMARKET INTERCHANGE ///

HD MFG	DIESELTECH
18-225	U214
18-250	U212
18-250	U212
18-275	H234P
18-275	T234
18-300	T300
18-300Z	T300Z
18-325	T314
18-350	T312
18-350Z	T312Z
18-400	T400
18-400CP	9486
18-400Z	T400Z
18-450	H412
18-450Z	T412Z
18-476Z	H412
18-500	T500
18-500CP	9487
18-500Z	T500Z
18-550	T512Z
18-600	T600
18-600Z	T600Z
18A-400	AS400
18A-500	AS500
19-300	9501
19-300CP	9490
19-350	9502
19-400CP	9492
19-400Z	9503
19-500	9504
19-500CP	9493
19-600CP	9495
19-600Z	9506
19A-200	H200
19A-225	H214
19A-250	H212
19A-300	H300
19A-300Z	H300Z
19A-350	H312
19A-350	H312P
19A-400	H400
19A-400Z	H400Z
19A-450	H412P
19A-450Z	H412PZ
19A-500	H500
19A-500Z	H500Z
19A-600	H600
19A-600Z	H600Z
20-200-ES	B200
20-225-ES	B214
20-250-ES	B212
20-275-ES	B234
20-275-ES	B234
20-300-ES	B300

HD MFG	DIESELTECH
20-300-ES	B300
20-350-ES	B312
20-350-ES	B312
20-400-ES	B400
20-400-ES	B400
20-500-ES	B500
20-500-ES	B500
20-600-ES	B600
20A-200	9660
20A-200	9660
20A-225	9661
20A-250	9662
20A-250	9662
20A-275	9663
20A-275	9663
20A-300	9604
20A-300	9604
20A-350	9605
20A-350	9605
20A-400	9606
20A-500	9607
20B-300	9676
20B-300	9678
20B-350	9678
20B-400	9680
20B-500	9682
20B-500	9682
20S-200	9664
20S-225	9665
20S-225	9665
20S-250	9666
20S-250	9666
20S-275	9667
20S-275	9667
20S-300	9668
20S-300	9668
20S-350	9669
20S-350	9669
20S-400	9623
20S-500	9624
21-113	9395
21-113-1/2	9396
21-114	9399
21-192	9616
21-213	9610
21-215	9615
21-233	9622
21-243 1/2	9613
21-314	9614
21-344	9619
21-364	9617
21-374	9653
23-400A	9341
23-500A	9342

HD MFG	DIESELTECH
2-400-48A	44657
2-400-60A	54984
2-401-36CP	834002
2-401-51DA	54827
24-400A	9343
24-500A	9344
2-500-48A	44659
2-500-60A	54985
2-501-60DA	54992
26-300A	9470
26-305A	9708
26-350A	9391
26-355A	9392
26-355A	9392
26-400A	9474
26-405A	9475
26-500A	9478
26-505A	9393
26-506A	9717
26K-166A	9629
27-404	9586
28-350A	8953
28-353A	8955
28-430A	8956
28-430A	8958
28-435A	8957
28-435A	8957
28-540A	8958
28-650A	9335
29-350	9600
29-353A	9333
29-375A	9334
29-430A	9722
29-435A	9332
29-540A	9331
29-650A	8969
29A-430A	8963
29A-435A	8964
29A-540A	8965
29A-650A	9336
30-300	8975
30-350A	8976
30-400	8991
30-400A	18103
30-500A	8972
30-500A	8978
30-500A	8978
30-600A	8979
31-300	14339
31-300A	14601
31-350	14340
31-350A	14602
31-400	14341
31-400A	14603

HD MFG	DIESELTECH
31-500A	14605
31-500A	14605
31-600A	8974
31A-300A	8970
31A-350A	8971
31A-500A	8973
32-390	924003
32-490	924004
32-5590	925506
32-590	924005
32-690	926006
32-790	927006
32A-690	926101
3-300-12CP	814621
3-300-18CP	824000
3-300-24A	24744
3-300-60CP	854000
3-300A	14618
3-301-48A	34828
3-301A	24344
33-445	924105
3-350-12CP	814622
3-350-18A	24938
3-350-18CP	824001
3-350-36A	34827
3-350-36CP	834000
3-350A	14619
3-351A	24345
33-545	925005
33-5545	925505
33-645	926005
33-745	927005
3-400-18A	24713
3-400-24A	24746
3-400-36A	34719
3-400-48A	44664
3-400-60A	54721
3-400A	24674
3-401-12A	24346
3-401-18A	24717
3-401-24A	24748
3-401-36A	34723
3-401-48A	44665
3-401-48LA	54117
3-401-60A	54725
34-4	924104
34-5	925105
34-55	925504
34-6	926004
34-7	927004
3-500-18A	24714
3-500-20A	24672
3-500-24A	24747
3-500-36A	34720

CROSS REFERENCE



## AFTERMARKET INTERCHANGE



CROSS  
REFERENCE

HD MFG	DIESELTECH
3-500-48A	44666
3-500-60A	54722
3-501-18A	24718
3-501-20A	24347
3-501-24A	24750
3-501-36A	34724
3-501-48A	44667
3-501-60A	54726
35-554	925543
35-555	925553
35-65	926503
35-655	926553
3-600A	24696
36-3	9589
36-35	9590
36-4	9591
36-5	9592
36-55	9593
36-6	9594
36-7	9595
36-8	9596
37-545	925458
37-555	925558
37-65	926508
37-655	926658
38-655	926557
38-7590	927557
4-364P	809301
4-42CP	809302
4-484SS	809458
4-485P	809308
4-51-1075SS	809500
4-5110P	809304
4-51-6SCSS	809307
4-51-9075SS	809500
4-51-90SS	809429
5-1075CP	9724
5-10CP	9453
5-4CP	9456
5-5CP	9457
5-6CP	9810
5-85CP	9451
5-85CP	9805
5-9075CP	9725
5-90CP	9452
6C-400CP	SBC400
6C-500CP	SBC500
6C-600CP	SBC600
6F-400CP	SBF400
6F-500CP	SBF500
6F-600CP	SBF600
7-18CP	9430
9-200	9371
9-225	9370

HD MFG	DIESELTECH
9-250	9372
9-275	9378
9-300	9373
9-300CP	9571
9-350	9374
9-400	9375
9-400	9375
9-400CP	9573
9-450	9376
9-500	9377
9-500	9377
9-500CP	9575
9-550	9704
9-600	9369
HD-15011	3941
HD-250	3880
HD300	3721
HD-300-39	3652
HD350	3720
HD-400	3887
HD-6017	3889
HD-94014	3913
SA300	3692
SA350	3693
SA400	3694
SA500	3695

JONES	DIESELTECH
MH150	4222
TM296	687
TM298	3651
TM299	3654
TM790	2080
TM792	3906
TM795	3150
TM797	3652
TM798	609
TM799	3607
TM801	2704
TM804	3697

NELSON	DIESELTECH
12825	4222
02366T	4248
02454T	3969
03154T	3947
03938T	3985
04269T	3956
04566T	3951
04648T	3984

NELSON	DIESELTECH
04839T	3950
04859T	3999
05388T	3952
05757T	3963
05908T	3953
06292T	3966
06375T	3954
09166T	3981
09167T	3959
09178T	3986
09707T	3964
09947T	3991
10156T	3977
10315T	3972
11026T	4210
11669T	3957
11675T	3967
13994T	4238
14245T	3976
14472T	3980
14490T	3998
14944T	4203
15287T	7661
15288T	3973
15289T	3997
15510T	3995
15906T	4202
16487T	3974
17257T	3949
18202T	3948
18901T	4200
22708T	4201
22724A	2156
24691T	4204
49115U	4223
49120B	3690
49125A	3691
49130A	3692
49135A	3693
49140A	3694
49150A	3695
6292T	3965
86102M	3897
86102M	3897
86106M	3689
86108M	3666
86111M	3666
86113M	3679
86115M	3898
86117M	3676
86118M	3911
86119M	3627
86121M	3900
86125M	3614

NELSON	DIESELTECH
86127M	3625
86130M	3640
86130M	3640
86131M	3666
86132M	3667
86133M	3670
86134M	3662
86135M	3663
86137M	3654
86138M	3906
86139M	2704
86139M	3655
86140M	609
86142M	687
86142M	687
86144M	3681
86145M	3682
86147M	3647
86148M	3918
86149M	3678
86150M	3618
86151M	3677
86152M	3707
86153M	3632
86163M	3654
86164M	2958
86168M	3669
86173M	3683
86174M	3685
86175M	3684
86177M	3970
86178M	3955
86180M	3913
86183M	3697
86184M	3150
86185M	3610
86186M	3880
86187M	3721
86188M	3720
86189M	3887
86191M	3925
86192M	3626
86193M	3636
86194M	3645
86196M	3722
86200M	3714
86213M	3668
86220M	3706
86502M	3700
86503M	3698
86505M	3710
86510M	3915
86511M	3703
86512M	3611

## AFTERMARKET INTERCHANGE ///

NELSON	DIESELTECH	NELSON	DIESELTECH	NELSON	DIESELTECH	NELSON	DIESELTECH
86514M	3890	86756M	3940	89095A	10339	89171A	8963
86519M	3613	86771M	3926	89096A	10789	89172A	8964
86522M	3725	86773M	3893	89097A	10340	89173A	8965
86526M	3702	86774M	3851	89098A	10301	89180A	8941
86529M	3713	89015A	44657	89099A	10303	89182A	9600
86530M	3919	89018A	44659	89101A	10675	89183A	9334
86536M	3716	89019A	54985	89102A	10304	89184A	9333
86536M	4242	89020A	34713	89103A	10759	89185A	9722
86537M	3704	89021A	44854	89104A	10305	89186A	9332
86539M	3624	89021C	844002	89105C	809770	89187A	9331
86542M	3931	89022A	24735	89106A	10306	89205A	54984
86544M	3714	89023A	34714	89106C	809406	89212A	24941
86547M	3715	89024A	44731	89107A	10765	89214A	9599
86548M	3916	89025A	24737	89107C	809546	89216A	24711
86550M	3112	89026A	34715	89108A	10308	89217A	54991
86556M	3875	89026C	834004	89108C	809408	89217C	854002
86557M	3708	89027A	44656	89109A	10556	89218A	24712
86560M	3888	89028A	24739	89110A	10773	89220A	44863
86561M	3889	89029A	34716	89111A	10774	89222A	54725
86563M	3637	89030A	44658	89113A	10534	89226A	54721
86570M	3933	89031A	54720	89114A	10536	89227A	54722
86594M	3908	89031C	854003	89115A	10537	89230A	10302
86597M	3705	89037A	34828	89116A	10539	89234A	10778
86606M	3912	89043A	24748	89117A	10540	89235A	10535
86607M	3930	89044A	34723	89117C	809796	89241A	10320
86624M	3872	89045A	44665	89118A	10309	89243A	10318
86626M	3873	89046A	24750	89124A	10783	89245A	8970
86635M	3387	89047A	34724	89126A	10785	89247A	8972
86640M	2323	89048A	44667	89132A	10684	89248A	8973
86641M	3425	89049A	54726	89133A	10685	89249A	8933
86642M	3256	89053A	34827	89143A	14618	89250A	8943
86653M	3711	89053C	834000	89143C	814621	89252A	8979
86655M	3924	89055A	24746	89144A	14619	89256A	9649
86657M	3616	89056A	34719	89144C	814622	89258A	8971
86672M	3923	89057A	44664	89145A	24713	89261A	14337
86675M	3424	89058A	24747	89146A	24714	89262A	8951
86682M	3699	89059A	34720	89147A	24696	89263A	14338
86682M	3699	89060A	44666	89150A	10921	89264A	8980
86685M	3932	89071A	10311	89151A	14343	89266A	8974
86686M	3921	89072A	10312	89152A	14634	89267A	8946
86690M	3726	89073A	10313	89153A	24344	89268A	8947
86695M	3914	89074A	10727	89154A	24345	89269A	8948
86697M	3920	89075A	10732	89155A	24717	89270A	8952
86698M	3730	89077A	10314	89156A	24718	89271A	8953
86713M	3891	89082A	10562	89160A	14601	89273A	8954
86722M	3719	89083A	10564	89161A	14602	89274A	8955
86723M	3939	89084A	10745	89162A	14603	89275A	8956
86725M	3938	89085A	10747	89163A	14605	89276A	8957
86739M	3667	89087A	10565	89164A	8975	89277A	8958
86740M	3712	89090A	10776	89165A	8976	89278A	9335
86744M	3885	89091A	10337	89166A	8991	89279A	8942
86753M	4240	89092A	10794	89167A	8978	89283A	9336
86754M	3917	89093A	10338	89168A	8960	89284A	14342
86755M	3851	89094A	10781	89169A	8961	89415A	9896
				89170A	8962	89417A	9897

CROSS REFERENCE

## AFTERMARKET INTERCHANGE



CROSS  
REFERENCE

NELSON	DIESELTECH
89420A	9371
89422A	9370
89425A	9372
89427A	9378
89430A	9373
89430C	9571
89435A	9374
89440A	9375
89440C	9573
89445A	9376
89450A	9377
89450C	9575
89455A	9704
89460A	9369
89500K	9612
89501K	9627
89503K	9615
89505K	9395
89506K	9396
89507K	9647
89508K	9479
89509K	9617
89510K	9616
89511K	9398
89512K	9613
89513K	9399
89519K	8483
89520K	9653
89521K	B200
89522K	B214
89523B	B234
89523K	B212
89524K	B234
89525B	B300
89525K	B300
89526B	B312
89526K	B312
89527B	B400
89527K	B400
89528B	B500
89528K	B500
89529B	B600
89529K	B600
89530K	9626
89531K	9622
89532K	9619
89533K	9614
89534K	9354
89535K	9355
89536K	9580
89537K	9360
89538K	9356
89539K	9357
89540K	9358
89541K	U200

NELSON	DIESELTECH
89542K	U214
89543K	U212
89544K	T234
89545K	T300Z
89546K	T314
89547K	T312Z
89548B	H400PZ
89548C	9486
89548K	T400Z
89549C	9487
89549K	T500Z
89550C	9734
89550K	T600Z
89551K	9359
89556K	9501
89557K	9502
89558K	9503
89559K	9504
89560K	9506
89566K	9490
89568K	9492
89569K	9493
89570K	9495
89571K	9618
89580K	9589
89581K	9590
89582K	9591
89584K	9592
89585K	9593
89586K	9594
89587K	9595
89588K	9596
89600K	24752
89601K	24930
89602K	34826
89603K	24753
89604K	24849
89605K	34785
89606K	24754
89607K	24835
89608K	34743
89609K	24755
89610K	24837
89611K	34744
89613K	24675
89617K	24676
89620K	8883
89621K	8884
89622K	8885
89623K	8886
89624K	8887
89625K	8888
89626K	8895
89640K	8984
89641K	8985

NELSON	DIESELTECH
89642K	8986
89642K	8986
89643K	8987
89643K	8987
89644K	8988
89644K	8988
89645K	8989
89645K	8989
89646K	8990
89646K	8990
89657K	8855
89666K	800A1016
89673K	312A1016
89675K	500C1016
89678K	412A1016
89679K	512A1016
89685K	300A1014
89686K	312A1014
89687K	400A1016
89688K	500A1016
89698K	600A1016
89708K	8868
89709K	8870
89710K	8872
89712K	8875
89713K	8881
89713K	8881
89714K	8882
89714K	8882
89715K	8877
89715K	8877
89716K	8898
89721K	8982
89722K	8983
89723K	8878
89724K	8879
89726A	8957
89726K	14739
89727K	24677
89728K	24836
89729K	34673
89730K	14737
89731K	24678
89732K	24838
89733K	34674
89740K	24931
89747C	809429
89749C	809300
89759K	8856
89761K	9451
89762K	9452
89763K	9453
89764K	9453
89764K	9453
89766K	9798

NELSON	DIESELTECH
89767K	9799
89770K	9456
89771K	9457
89772K	8857
89774C	809458
89775K	9811
89780A	10315
89781A	10730
89781C	809738
89782A	10566
89783A	10746
89784A	10680
89784C	809547
89786K	9726
89787K	9727
89788K	9728
89789K	9729
89805K	924105
89807K	925005
89808K	925505
89809K	926005
89810K	927005
89818K	924003
89820K	924004
89821K	924005
89822K	925506
89824K	926006
89825K	927006
89831K	926557
89835K	924104
89837K	925105
89838K	925504
89839K	926004
89840K	927004
89846K	925543
89847K	925553
89848K	926503
89849K	926553
89858K	926508
89866K	927557
89881A	9648
89883A	9650
89885A	38607
89887A	68182
89897A	28528
89901A	68185
89901C	868186
89902A	68183
89902C	868184
89924A	10764
89924C	809771
89925A	10538
89926A	10788
89940A	92673
89941A	92679

## AFTERMARKET INTERCHANGE ////

NELSON	DIESELTECH	NELSON	DIESELTECH	NELSON	DIESELTECH	NELSON	DIESELTECH
89942A	92698	900103A	94010	90375A	9678	90930K	H218
89943A	92678	900105A	28656	90376A	9680	90931A	38761
89950A	92674	900121A	94011	90378A	9682	90936A	9716
89951A	92689	90013A	9261	90378A	9682	90938A	18109
89955K	9470	900190A	9479	90379A	9683	90951K	B314
89956K	9471	900243A	9149	90380A	9684	90955A	38613
89957K	9392	900248A	9165	90381A	9685	90956A	9629
89958A	9473	900249A	9146	90382A	9686	90957A	38610
89958K	9711	900253A	9569	90383A	9687	90958A	28661
89960K	9476	900268A	9353	90384A	9688	90958C	S8600
89961K	9394	900269A	9578	90385A	9690	90961A	28534
89962K	9391	900270A	9579	90386A	9692	90977A	38614
89963K	9710	900304A	8566	90387A	9693	90979A	38612
89964K	9474	900306A	9220	90388A	9694	90980A	38611
89965A	9475	900307A	8717	90389A	9695	90981A	94942
89965K	9714	900308A	9260	90438C	854001	90982A	10787
89966K	9393	900309A	8698	90444C	854006	90987A	28699
89967K	9478	900310A	8699	90451A	54827	90990A	58372
89968K	9706	900311A	9118	90464K	B412	90993A	94941
89969K	9713	900315A	9259	90465A	10560	914006A	94991
89971K	9718	90051A	8660	90465C	809530	921003A	18139
89973K	9586	90054A	8911	90468K	9514	921016A	18101
89991C	834002	90056A	8940	90469K	9516	921023A	18101
900005A	9628	90057A	8959	90470K	9518	921026A	18150
900022C	SB500	90059A	8937	90527K	9610	922009A	28425
900040K	H234P	90066A	8939	90528K	9611	922012A	9597
900041K	H300PZ	90072A	9361	90530K	9397	922016A	28134
900042K	H312P	90076A	9363	90532A	9341	922020A	18083
900043K	H400P	90077A	9364	90533A	9342	922031A	28517
900044K	H500P	90079A	9365	90536A	9343	922038A	28237
900045K	H600	90080A	9366	90539A	9344	922041A	28662
900050A	10674	90092A	T412Z	90555C	809500	922070A	28655
900052A	10758	90161K	9736	90566A	923120	923007A	44796
900055A	10681	90168K	8858	90567A	9708	923008A	48348
900056A	10678	90191K	8859	90823A	38608	923015A	38223
900056A	10678	90206K	8876	90843K	8052	923017A	38269
900059A	18148	90266A	9927	90856C	809307	923025A	28174
900062A	10791	90350A	9660	90857K	9810	923037A	38528
900064A	10315	90351A	9661	90866A	H300	923042A	34879
900065A	10317	90352A	9662	90867A	H400	923043A	34814
900069A	10567	90353A	9663	90868A	H500	923049A	38763
90006A	9245	90354A	9604	90875A	AS400	923050A	38764
900071A	10748	90355A	9605	90877A	AS500	923059A	34882
900072A	10631	90356A	9606	90902K	14740	923063A	10786
900073A	10632	90360A	9664	90903K	14738	924003A	44797
900074A	10633	90361A	9665	90906A	924120	924004A	48349
900077A	10636	90362A	9666	90909A	14620	924008A	58330
900078A	10637	90363A	9667	90913A	24346	924014A	44748
900080A	10639	90364A	9668	90914K	U178	924015A	44749
900081A	10640	90365A	9669	90915K	U214	924016A	48568
900082A	10641	90366A	9623	90916K	U212	924020A	83002
900085A	10644	90367A	9670	90923A	68181	924027A	44773
900086A	10645	90368A	9624	90927K	U112	924029A	54853
900095A	9721	90369A	9671	90928K	U134	924036A	34798
900096A	9723	90374A	9676	90929K	U200	924037A	34799

CROSS REFERENCE

## AFTERMARKET INTERCHANGE

CROSS  
REFERENCE

NELSON	DIESELTECH
924037A	54880
924055A	44795
924057A	54117
924064A	48347
924075A	83015
924078A	34813
924081A	44821
924082A	44822
924085A	48554
924098A	48571
925002A	54809
925003A	54808
925005A	58349
925010A	58219
925013A	68421
925014A	58251
925018A	64729
925020A	54749
925021A	54750
925022A	54760
925032A	64722
925033A	84559
925034A	84584
925045A	68374
925048A	58225
925051C	854000
925055A	54129
925058A	48569
925068A	58421
925070A	58420
926003A	64668
926005A	74607
926008A	68221
926009A	88104
926010A	64708
926011A	74627
926032A	64691
926036A	64741
926062A	58225
926068A	68371
926070A	68420
926072A	74646
926074A	78166
927010A	74632
927018A	64744
927024A	74645
927025A	74654
929001A	83014
929002A	200A1014
929003A	214A1014
929004A	212A1014
929007A	400A1414
929008A	212A1014
929009A	83007
929011A	83005

NELSON	DIESELTECH
929012A	83008
929016A	83000
929023K	400C1016
929024A	234A1014
929025A	300A1014
929026A	312A1016
929027A	400A1014
929032A	83004
929034S	300S1014
929035S	400S1016
929036S	500S1016
929037A	83037
Q78465	8893

PDC	DIESELTECH
31217	814621
31817	824000
34810	844002
36017	854000
43601	834002
43610	834004
351217	814622
351817	824001
353617	834000
002590-12A	10774
00290-12A	10773
00345-9A	10564
003545-9A	10565
003590-12A	10535
003590-16A	10536
003590-8A	10329
00390-14A	10778
00390-7A	10777
00415-4A	10684
00430-4A	10636
00445-12A	10745
00445-9A	10566
00460-8A	10644
00490-10A	10783
00490-12A	10539
00490-15A	10797
00490-18A	10537
00490-18A	10537
00490-8A	10781
00515-4A	10685
00530-4A	10637
00545-12A	10567
00545-15A	10747
00560-10A	10645
00590-10A	10789
00590-10C	809795
00590-12A	10791

PDC	DIESELTECH
00590-12C	809796
00590-16A	10796
00590-20A	10309
00645-8A	10748
102245-6A	10320
102290-12A	10302
10245-6A	10311
102545-6A	10312
102590-12A	10303
102745-6A	10318
10290-12A	10301
10345-6A	10313
10345-9A	10313
103530-4A	10631
103590-16A	10305
10390-12A	10758
10390-14A	10304
10430-4A	10632
10445-12A	10727
10445-6A	10726
10445-6A	10736
10445-9A	10315
10460-8A	10640
10490-10C	809621
10490-12A	10761
10490-12C	809770
10490-18A	10306
10490-18C	809406
10490-8A	10681
10530-4A	10633
10545-12A	10317
10545-15A	10732
10545-7A	10729
10545-7C	809738
10560-10A	10641
10590-10A	10557
10590-12A	10680
10590-12C	809547
10590-16A	10765
10590-16A	10766
10590-16C	809546
10590-20A	10308
10590-20C	809408
10590-8A	10764
31207A	24344
31217A	14618
31810A	24731
32410A	24941
32417A	24744
33610A	34713
34810A	44854
34817A	34828
351207A	24345
351217A	14619
351817A	24938

PDC	DIESELTECH
352410A	24735
353610A	34714
353617A	34827
354810A	44731
41207A	24346
41217A	14620
41807A	24717
41817A	24713
42407A	24748
42417A	24746
43607A	34723
43610A	34715
43617A	34719
44800A	44657
44807A	44665
44810A	44656
44817A	44664
46000A	54984
46007A	54725
46017A	54721
51807A	24718
51817A	24714
52407A	24750
52417A	24747
53607A	34724
53610A	34716
53617A	34720
54800A	44659
54807A	44667
54810A	44658
54817A	44666
55X50	925558
56000A	54985
56007A	54726
56010A	54720
56017A	54722
64810A	44863
AMC113	U118
AMC125	U114
AMC150	U112
AMC162	U158
AMC175	U134
AMC188	U178
AMC200	U200
AMC213	U218
AMC225	U214
AMC250	U212
BA500	9719
CMB400C	SBC400
CMB500C	SBC500
CMB600C	SBC600
CN2120	8933
CN2121	14337
CN251250	9597
CN251251	14338

## AFTERMARKET INTERCHANGE ///

PDC	DIESELTECH
CN271271	8980
CN3030	8970
CN3130	8975
CN3131	14339
CN350350	8971
CN351350	8976
CN351351	14340
CN4040	8972
CN4140	8991
CN4141	14603
CN5050	8973
CN5151	14605
CN6160	8979
CN6161	8974
CNCN5150	8978
CR100	9807
CR40	9801
CR50	9803
CR60	9810
CR80	9804
CR85	9805
CR90	9806
CRH270-10	9724
CRH270-9	9725
FBC400A	A400
FBC500A	A500
FC300-18	24674
FC350-18	24935
FC400-18	24654
FC500-18	24936
FL13974A	94010
FL9586A	10787
FLX200	8984
FLX200BULK	8868
FLX200BULK	8868
FLX200S	8883
FLX200S	8883
FLX225BULK	8870
FLX225S	8855
FLX250	8985
FLX250A	8858
FLX250BULK	8872
FLX250BULK	8872
FLX250S	8884
FLX300	8986
FLX300-18	24752
FLX300-24	24930
FLX300-36	34826
FLX300A	8859
FLX300BULK	8875
FLX300S	8885
FLX300S-18	24675
FLX300SBULK	8982
FLX350	8987
FLX350-18	24753

PDC	DIESELTECH
FLX350-24	24849
FLX350-36	34785
FLX350A	8876
FLX350S	8886
FLX350S-18	24676
FLX350SBULK	8983
FLX400	8988
FLX400-12	14738
FLX400-12	14740
FLX400-18	24754
FLX400-24	24835
FLX400-36	34743
FLX400-48	44786
FLX400A	8856
FLX400S	8887
FLX400S-12	14739
FLX400S-18	24677
FLX400S-24	24836
FLX400S-36	34673
FLX400SBULK	8878
FLX500	8989
FLX500-18	24755
FLX500-24	24837
FLX500-36	34744
FLX500-48	54831
FLX500A	8857
FLX500S	8888
FLX500S	8888
FLX500S-12	14737
FLX500S-18	24678
FLX500S-24	24838
FLX500S-36	34674
FLX500S-48	44867
FLX500SBULK	8879
FLX600	8990
FLX600S	8895
FLX600SBULK	8899
FMB400C	SBF400
FMB500C	SBF500
FMB600C	SBF600
GH18C	9430
GH24C	9811
GR234	T234
GR300	T300
GR300	T300Z
GR325	T314
GR350	T312
GR350	T312Z
GR400	T400
GR400	T400Z
GR400C	9486
GR450	T412Z
GR500	T500
GR500	T500Z
GR500C	9487

PDC	DIESELTECH
GR550	T512Z
GR600	T600
GR600	T600Z
GR600C	9734
HD200	H200
HD225	H214
HD250	H212
HDF300	8880
HDF350	8881
HDF350	8881
HDF400	8882
HDF500	8877
HDF500	8877
HDF600	8898
HH40	924104
HH50	925105
HH55	925504
HH55X40	925543
HH55X5	925553
HH60	926004
HH60X55	926553
HH70	927004
HP3	9589
HP4	9591
HP5	9594
KW10742LA	68183
KW10742LC	868184
KW10742RA	68185
KW10742RC	868186
KW14764LA	38611
KW14764RA	38612
KW14766A	94942
LBP5510	3640
LDL100BULK	8860
LDL150BULK	8864
LDL175BULK	8866
LF18-500	9717
LF20-400	9474
LF20-525	9715
LF22-350351	9473
LF22-4041	9476
LF300	9708
LF301	9471
LF350	9710
LF351	9392
LF401	9475
LF500	9393
LF501	9394
LN5590	3897
LND5510	3722
M2244	3970
M2-2525662	3654
M2-272270	609
M2-3385	2704
M2-3385X32	3627

PDC	DIESELTECH
M2-35358X11	3689
M2-3548X11	3611
M2-4358X11	3668
M2-4410	3669
M2-4410X15	3614
M2-4411	3711
M2-448X11	3632
M2-448X11	3710
M2-5510X15	3647
M2-5510X36	3676
M2A-252785	3697
M2A-25385	3150
M2A-2748X11	3610
M3380	3687
M3-4410X15	3678
M3-4411X6X3	3927
M3-4510X15	3931
M3-4590	3926
M353570	3618
M353590	3679
M3-5510	3702
M4-35408X11	3703
M4-35418X11	3704
M4410	3714
M4-4410	3677
M4-4410X15	3921
M4485	3625
M4490	3891
M4510	3715
M4510	3893
M4-5510X15	3698
M4-5511	3923
M4590	3712
M5-4410	3670
M5-4410X15	3898
M5510	3699
M5510X67	3873
M5-5510X15	3900
M5590	3667
M5590	3667
MC42-9SS	809302
MC51-10SS	809429
MC51-10SS	809500
MC51-9SS	809500
MCH270-10SS	809300
MF400	9586
MH0811	9360
MH1000	9358
MH1015	9359
MH600	9354
MH700	9355
MH850	9356
MH900	9357
MK21698A	28528
MK32611A	68181

CROSS REFERENCE

## AFTERMARKET INTERCHANGE

CROSS  
REFERENCE

PDC	DIESELTECH
MK32612A	68182
MPT20	3878
MPT30	3683
MPT35	3685
MPT40	3684
MR40	3681
MR50	3682
N50X45	925458
N60X50	926508
N60X55	926658
NPT300	9514
NPT350	9516
NPT400	9518
NS225	9370
NS275	9378
NS550	9704
NV1652937A	18149
NV582167A	38608
PB13055A	94011
PB13056C	809519
PB1726A	10560
PB1726C	809530
PB400C	SB400
PB4055A	94941
PB500C	SB500
PB600C	SB600
PH250	9361
PH300	9363
PH350	9364
PH400	9365
PH500	9366
RC200	9371
RC250	9372
RC300	9373
RC300C	9571
RC350	9374
RC400	9375
RC400	9375
RC400C	9573
RC450	9376
RC500	9377
RC500C	9575
RC600	9369
RD22021	8938
RD22120	8911
RD22121	8946
RD25021	8941
RD250221	8942
RD25120	8913
RD25121	8947
RD251220	8940
RD251221	8948
RD30251	9600
RD30271	9334
RD31250	8960

PDC	DIESELTECH
RD31251	8953
RD31271	8954
RD35031	9333
RD35130	8962
RD35131	8955
RD4030	9648
RD4031	9722
RD40351	9332
RD4130	8963
RD4131	8956
RD41350	8964
RD41351	8957
RD5040	9649
RD5041	9331
RD5140	8965
RD5141	8958
RD6040	9720
RD6050	9650
RD6051	8969
RD6150	9336
RD6151	9335
RE30	924003
RE40	924004
RE40-45	924105
RE50	924005
RE50-45	925005
RE55	925506
RE55-45	925505
RE60	926006
RE60-45	926005
RE60X50	926503
RE60x55	926557
RE70	927006
RE70-45	927005
RE70X55	927557
SA200	3690
SA250	3691
SA300	3692
SA350	3693
SA400	3694
SA500	3695
SC485S	809458
SF300	9501
SF300C	9490
SF350	9502
SF400	9503
SF400C	9492
SF500	9504
SF500C	9493
SF550	9736
SF600	9506
SF600C	9495
SM4490	3888
SM5590	3895
SP200A	200A1014

PDC	DIESELTECH
SP225A	214A1014
SP250A	212A1016
SP275A	234A1016
SP300A	300A1016
SP350A	312A1016
SP400	400C1016
SP400A	400A1016
SP450	412A1016
SP500	500C1016
SP500A	500A1016
SP550	512A1016
SP600	600C1016
SP600A	600A1016
SR300	H300
SR300	H300Z
SR350	H312
SR400	H400
SR400	H400Z
SR450	H412
SR500	H500
SR500	H500Z
SR600	H600
SRE3590-4A	10338
SRE390-4A	10337
SRE390-7A	10776
SRE490-4A	10339
SRE590-16A	10541
SRE590-5A	10340
T401A	92679
T4130	92698
T41350	92678
T501A	92689
TAS400A	AS400
TAS500A	AS500
TBC200S	9684
TBC225S	9685
TBC250S	9686
TBC275S	9687
TBC300A	9676
TBC300S	9688
TBC350A	9678
TBC400S	9692
TBC450S	9693
TBC500A	9682
TBC500S	9694
TBC600A	9683
TBC600S	9695
TCB401	9343
TCB501	9344
TCT400	9341
TCT500	9342
TES200	B200
TES225	B214
TES250	B212
TES275	B234

PDC	DIESELTECH
TES300	B300
TES350	B312
TES400	B400
TES450	B412
TES500	B500
TES600	B600
TLC200A	9660
TLC200S	9664
TLC225A	9661
TLC225S	9665
TLC250A	9662
TLC250S	9666
TLC275A	9663
TLC275S	9667
TLC300A	9604
TLC300A	9604
TLC300S	9668
TLC350A	9605
TLC350S	9669
TLC400A	9606
TLC400S	9623
TLC450S	9670
TLC500A	9607
TLC500S	9624
TLC600S	9671
TLC600S	9671
UH100	8483
VBC250F	9610
VBC275C	9618
VBC275F	9656
VBC300C	9612
VBC300DD	9395
VBC300F	9626
VBC350CAT	9622
VBC350DD	9396
VBC350IHC	9613
VBC350NAV	9627
VBC400C	9653
VBC400SW	9614
VBC400T	9399
VBC500C	9615
VBC978DD	9735
Y401A	92673
Y501A	92674

RIKER	DIESELTECH
10915	3669
10922	3873
10928	3722
10931	3670
10945	3715
10961	3702
11901	3700

## AFTERMARKET INTERCHANGE ///

RIKER	DIESELTECH
11917	3919
15007	3678
15901	3898
15903	3614
15905	3900
15906	3676
15909	3645
15913	3913
65901	3654
81005	3616
81006	3689
81010	3915
81021	3703
81908	3632
81922	3668
85901	3625
85903	3662
85904	2704
85924	3150
90045	3712
90501	3872
90910	3888
90915	3679
90945	3890
10019W	3714
10026W	3699
9XD403	3666
9XD503	3897
9XD508	3897
A275	14634
A300	14618
A30024	24744
A30060PL	854000
A300PL	824000
A350	14619
A35036PL	834000
A350PL	824001
A400	14620
A40024	24746
A40036	34719
A40048	44664
A40060	54721
A500	24672
A50024	24747
A50036	34720
A50048	44666
A50060	54722
A600	24696
AA200	10921
AA225	14342
AA250	14343
AA300	24344
AA30048	34828
AA350	24345

RIKER	DIESELTECH
AA400	24717
AA40024	24748
AA40036	34723
AA40048	44665
AA40060	54725
AA500	24347
AA50024	24750
AA50036	34724
AA50048	44667
AA50060	54726
AC300	9589
AC350	9590
AC400	9591
AC500	9592
AC550	9593
AC600	9594
AC700	9595
AC800	9596
AD302	9390
AD305	9708
AD308	9471
AD350	9473
AD352	9391
AD354	9473
AD355	9392
AD358	9392
AD400	9474
AD402	9476
AD405	9475
AD408	9472
AD455	9718
AD502	9478
AD505	9393
AD506	9717
AD508	9394
AD5091	9719
ADN501	9716
B400	9343
B500	9344
C300	24674
C350	24935
C400	24654
C401SS	24677
C500	24936
C501SS	24678
CE200	8933
CE225	8939
CE250	8943
CE300	8975
CE350	8976
CE400	8991
CE500	8978
CE600	8979
CO200	14337

RIKER	DIESELTECH
CO225	8951
CO250	14338
CO275	8980
CO300	14601
CO350	14602
CO400	14603
CO500	14605
CO600	8974
CT200	8907
CT300	8970
CT350	8971
CT400	8972
CT500	8973
FG3001918	24752
FG3501918	24753
FG4001912	14738
FG4001918	24754
FG40024	24835
FG40036	34743
FG40048	44786
FG5001912	14740
FG5001918	24755
FG50024	24837
FG50036	34744
FG50048	54831
FL275	9149
FL404	9586
FS3001918	24675
FS3501918	24676
FS4001912	14739
FS40024	24836
FS40036	34673
FS5001912	14737
FS50024	24838
FS50036	34674
FS50048	44867
FTG20015	8868
FTG2001910	8984
FTG22515	8870
FTG25015	8872
FTG25019	8872
FTG2501910	8985
FTG30015	8875
FTG30019	8880
FTG3001910	8986
FTG35015	8881
FTG35019	8881
FTG3501910	8987
FTG40015	8882
FTG40019	8882
FTG4001910	8988
FTG50015	8877
FTG50019	8877
FTG5001910	8989

RIKER	DIESELTECH
FTG6001910	8990
FTG60024	8898
FTS200SS	8883
FTS22519	8855
FTS250SS	8884
FTS30019	8982
FTS3001910	8885
FTS35019	8983
FTS3501910	8886
FTS40019	8878
FTS4001910	8887
FTS50019	8879
FTS5001910	8888
FTS60019	8899
GH115PL	9430
GH121PL	9811
H1000	9358
H1015	9359
H250	9361
H300	9363
H350	9364
H400	9365
H500	9366
H600	9354
H700	9355
H800	8445
H811	9360
H850	9356
H900	9357
HD225	3954
HD2505	3651
HD2755	3882
HD278	2958
HD3005	3721
HD3055	3652
HD3505	3720
HD4005	3887
HD6060	3677
HD7429	3698
HD7713	3610
KB1110	400A1414
KB2001	9479
KB2011	38223
KB2018	94991
KB2104	44773
KB2106	54809
KB2107	83008
KB2108	54808
KB2116	83007
KB3007	58251
KB3008	68221
KB3009	58219
KB3011	38269
KB3102	74607

CROSS REFERENCE



## AFTERMARKET INTERCHANGE



CROSS  
REFERENCE

RIKER	DIESELTECH
KB3103	83005
KB3106	64668
KB3107	83002
KM1101	3697
KM1111	3911
KM2101	3613
KM2201	3710
KM2202	3708
KS3001	9056
L200	10301
L20045	10311
L200NE	10773
L225	10302
L22545	10320
L250	10303
L25045	10312
L25045NE	10562
L250NE	10774
L27545	10318
L300	10304
L30045	10313
L30045F	10313
L30045NE	10564
L300F	10758
L300FNE	10534
L300FS	10757
L300NE	10778
L300SB	10337
L300SR	10777
L350	10305
L350	10305
L35030	10631
L35045	10314
L35045NE	10565
L35060	10639
L350F	10676
L350F	10676
L350FNE	10535
L350NE	10536
L350SB	10338
L350SR	10329
L350SR	10329
L400	10306
L40015	10684
L40030	10632
L40030NE	10636
L40045	10315
L40045F	10726
L40045NE	10743
L40060	10640
L40060NE	10644
L400CR	10306
L400F	10761
L400FNE	10539

RIKER	DIESELTECH
L400FPL	809770
L400NE	10537
L400NECR	10797
L400PL	809406
L400SB	10780
L400SR	10781
L488	10681
L488CR	10681
L500	10308
L50015	10685
L50030	10633
L50030NE	10637
L50045	10317
L50045F	10729
L50045NECR	10747
L50045SR	10746
L50045SRPL	809752
L50060	10641
L50060NE	10645
L500F	10765
L500FCR	10766
L500FNE	10540
L500FPL	809546
L500NE	10309
L500SB	10785
L500SR	10791
L510	10557
L510PL	809771
L512	10557
L512NEPL	809796
L600F	10556
LF501	10786
LF502	10787
LF503	10788
LK501	68185
LK501PL	868186
LK502	68183
LK502PL	868184
LK503	38612
LK504	38611
LK505	18110
LM401	28528
LM406	68182
LM407	68181
LNN501	38607
LNN502	38608
LP501	10560
LP501PL	809530
LP502	10784
LT300	3875
LT359	3618
LT409	3681
M4010	3714
M4090	3891

RIKER	DIESELTECH
M5010	3699
M5090	3667
MR200	45
MR500	3682
OR220	8938
OR250	8913
OR252	8942
OR275	8959
OR350	9600
OR353	9333
OR375	9334
OR430	9722
OR435	9332
OR540	9331
OR650	8969
OV50032	3647
PB500PL	SB500
PB600PL	SB600
RCG200	9371
RCG225	9370
RCG250	9372
RCG275	9378
RCG300	9373
RCG300PL	9571
RCG350	9374
RCG400	9375
RCG400PL	9573
RCG450	9376
RCG500	9377
RCG500PL	9575
RCG550	9704
RCG600	9369
RE300	924003
RE400	924004
RE40045	924105
RE500	924005
RE50045	925005
RE550	925506
RE55045	925505
RE600	926006
RE60045	926005
RE655	926557
RE700	927006
RE70045	927005
RE750	927557
RH400	924104
RH500	925105
RH554	925543
RH555	925553
RH600	925504
RH650	926503
RH655	926553
RH700	927004
RI220	8946

RIKER	DIESELTECH
RI250	8947
RI252	8948
RI350	8953
RI353	8955
RI375	8954
RI430	8956
RI435	8957
RI540	8958
RI540	8958
RI650	9335
RO430	8963
RO435	8964
RO540	8965
RS540	925458
RS555	925558
RS650	926508
RS655	926658
SA2009	3690
SA2509	3691
SA3009	3692
SA3509	3693
SA4009	3694
SA5009	3695
SKA1710	9724
SKA1740	9801
SKA1750	9803
SKA1760	9810
SKA1780	9804
SKA1785	9805
SKA1790	9725
SP14SS	809300
SP1836	809301
SP214SS	809500
SP5400PL	SBC400
SP5500PL	SBC500
SP5600PL	SBC600
SPF5400PL	SBF400
SPF5500PL	SBF500
SPF5600PL	SBF600
SPI40136PL	834002
SPO30024	24941
SPO30036	34713
SPO30048	44854
SPO30048PL	844002
SPO35036	34714
SPO40024	24737
SPO40036	34715
SPO40036PL	834004
SPO40048	44656
SPO40060	54991
SPO40848	44657
SPO40860	54984
SPO50024	24739
SPO50036	34716

## AFTERMARKET INTERCHANGE ///

RIKER	DIESELTECH
SPO50048	44658
SPO50060	54720
SPO50848	44659
SPO50860	54985
SPO60048	44863
T400	9341
T500	9342
TAA400	AS400
TAA500	AS500
TBA350	9678
TBA400	9680
TBA500	9682
TBA500	9682
TBS350	9690
TBS400	9692
TBS400	9692
TBS500	9694
TEC200	B200
TEC225	B214
TEC250	B212
TEC25050	B234
TEC275	B234
TEC300	B300
TEC30050	B300
TEC350	B312
TEC35050	B312
TEC400	B400
TEC40050	B400
TEC450	B412
TEC500	B500
TEC50050	B500
TEC600	B600
TEC60050	B600
TTA200	9660
TTA225	9661
TTA250	9662
TTA275	9663
TTA300	9604
TTA350	9605
TTA400	9606
TTA600	9683
TTS200	9664
TTS225	9665
TTS22550	9665
TTS250	9666
TTS275	9667
TTS300	9668
TTS350	9669
TTS400	9623
TTS500	9624
TTS600	9671
U200	U200
U225	U214
U250	U212

RIKER	DIESELTECH
U275	T234
U300	T300
U300Z	T300Z
U325	T314
U350	T312
U350Z	T312Z
U400	T400
U400PL	9486
U400Z	T400Z
U476Z	T412Z
U500	T500
U500PL	9487
U500Z	T500Z
U550	T512Z
U600	T600
U600PL	9734
U600Z	T600Z
UA300	H300
UA350	H312
UA400	H400
UA500	H500
UA600	H600
UAF300	9501
UAF300PL	9490
UAF300Z	H300Z
UAF350	9502
UAF400	9503
UAF400PL	9492
UAF400Z	H400Z
UAF500	9504
UAF500PL	9493
UAF500Z	H500Z
UAF600	9506
UAF600PL	9495
UD1501	U112
UD1751	U134
UD1781	U178
UD2001	U200
UD225	H214
UD2251	U214
UD250	H212
UD2501	U212
UD2751	H234
UD2751	H234P
UD300	H200
UD3001	H300PZ
UD3501	H312P
UD4001	H400PZ
UD5001	H500PZ
UH100	8483
UH117	8051
UH227	9351
UH340	9352
UH380	9353

RIKER	DIESELTECH
UH450	9579
UV227	9578
UV251	9610
UV300	9395
UV301	9612
UV352	9396
UV375	9613
UV377	9622
UV379	9627
UV400	9399
UV401	9619
UV407	9611
UV408	9617
UV409	9647
UV411	9614
UV478	9735
UV500	9616
UV501	9615
WT200	200A1014
WT225	214A1014
WT250	212A1014
WT2755	234A1014
WT300	300A1014
WT30010	923120
WT3005	300A1014
WT350	312A1016
WT35010	212A1014
WT350CR	312A1016
WT400	400A1014
WT40010	924120
WT400CR	400C1016
WT450CR	412A1016
WT500	500A1016
WT500	500A1016
WT500CR	500C1016
WT550CR	512A1016
WT600	600A1016
WT600CR	600C1016
X1220	3878
X12309	3683
X1235	3685
X12409	3684
XD4019	4211
XD413	3889
Y400	92673
Y500	92674
YP5011	94941
YS400	92679
YS500	92689

SCHOOL BUS PARTS	DIESELTECH
XB4-102	400A1014
XB4-105	400A1414
XB4AXF	44796
XB4AXF2	34799
XB4AXR	44797
XB4TF	34798
XB7R2	64744
XC1SP	9597
XC214UAL	58225
XC234TR1	83007
XC4AXF7	64708
XC4AXR6	54809
XC4M1	3710
XC4MD6	3708
XC4TF11	44773
XC4TFR6	54808
XC4TR1	83008
XC8.2C1	9479
XC802FL234	9569
XC82XR5	88104
XCG30RT4	54749
XCG30RT5	54750
XCG6.2RT2	84562
XF15P	28134
XF361F4B	212A1014
XF361FL	9165
XF370F2	234A1414
XF370M	3697
XF370M	3725
XF4MT2	3711
XH345MD	3150
XH360XT	58349
XH392FLHD	9149
XH3AX2	64668
XH3TR13	83002
XH45SE4	84559
XH45SE4TD	84584
XH466EX	58225
XH466EXF	68421
XH4AX	74632
XH4TF8	83000
XH4TR3	83005
XH69R	68221
XH9L	58219
XH9L	58251
XH9RX	38269
XQ1	9578
XQ1-14	9579
XQ1MP	9353

CROSS REFERENCE

## AFTERMARKET INTERCHANGE



STANLEY	DIESELTECH
AC-1	3946
AC-2	3947
AC-20	3948
AC-22	3949
AC-3	3951
AC-4	3952
AC-5	3953
CA-1	3954
CA-12	3955
CA-14	3956
CA-18	3957
CA-2	3958
CA-4	3959
CA-7	3961
CO-3	3962
DR-103	3963
DR-14	3964
DR-21	3965
DR-22	3966
DR-23	24737
DR-3	3967
DR-4	3968
DR-5	3969
DR-8	3970
FO-14	3971
FO-17	3972
FO-3	7661
FO-30	7660
FO-300	9894
FO-4	3973
FO-9	7662
FOE-1	38756
FOE-3	54121
IH-1	3974
IH-10	3975
IH-13	3976
IH-14	3977
IH-18	3978
IH-19	3979
IH-20	3980
IH-3	3981
IH-4	3982
MF-10	3983
MF-11	3984
MF-15	3985
MF-16	7442
MF-17	3986
MF-23	3987
MF-30	3988
MF-300	9895
MF-31	3989
MF-36	7664
MF-38	3990
MF-7	7663

STANLEY	DIESELTECH
MM-2	3950
OL-3	3991
OL-6	3992
OL-7	3993
RC-0	9896
RC-1	9897
VT-1	3663
VT-4	3995

STEMCO	DIESELTECH
190-0205	2958
190-0406	3883
190-0408	3653
190-0414	3880
190-1107	3699
190-1125	3678
190-1126	3700
190-1134	3941
190-1138	3708
190-1141	3924
190-1150	3711
190-1160	3689
190-1173	3912
190-1187	3714
190-1204	3702
190-1205	3893
190-1208	3713
190-1220	3931
190-1221	3916
190-1223	3715
190-1231	3873
190-1234	3926
190-1235	3927
190-1265	3940
190-1266	3933
190-1267	3930
190-1268	3851
190-1269	3917
190-1277	3885
190-1289	3677
190-1290	3705
190-1292	3703
190-1296	3881
190-1299	3906
190-1302	3624
190-1303	3616
190-1304	3627
190-1306	3938
190-1310	3932
190-1312	3919
190-1314	3939
190-1315	3730

STEMCO	DIESELTECH
190-1316	3920
190-1322	3726
190-1324	3669
190-1331	3878
190-1332	3626
190-1333	3636
190-1334	3617
190-1335	3925
190-1336	3895
190-1337	3937
190-1343	3662
190-1348	3913
190-1350	3872
190-1351	3645
190-1354	3914
190-1358	3891
190-1359	3725
190-1360	3667
190-1361	3712
190-1364	3637
190-1365	3900
190-1366	3706
190-1367	3704
190-1368	3928
190-1369	3676
190-1371	3707
190-1372	3687
190-1372	3875
190-1373	3670
190-1374	3898
190-1375	3698
190-1379	3941
190-1380	3714
190-1381	3887
190-1384	3666
190-9013	3721
190-9103	3652
190-9105	3720
190-9121	3884
190-9122	3618
190-9123	3681
190-9135	3683
190-9146	3685
190-9159	3607
190-9208	2704
190-9234	3625
190-9241	3150
190-9303	3894
190-9305	3889
190-9310	3682
190-9316	3888
190-9333	3684
190-9341	3679
190-9377	3890

STEMCO	DIESELTECH
190-9400	3614
190-9401	3647
190-9451	3921
190-9532	3611
190-9538	3632
190-9542	3668
190-9550	3710
190-9553	3716
190-9608	3663
190-9855	4211
190-9858	3923
190-9860	3918
190-9872	3640
190-9887	3911
190-9931	3719
201-0014	14601
201-0041	14602
201-0061	14603
201-0069	14605
201-0114	8974
201-1272	14339
201-1274	14340
201-1275	14341
201-1276	14605
202-0200	9371
202-0225	9370
202-0250	9372
202-0300	9373
202-0350	9374
202-0400	9375
202-0450	9376
202-0500	9377
202-0550	9704
202-0600	9369
202-1300	9571
202-1400	9573
202-1500	9575
203-0208	8955
203-0212	8957
203-0213	8958
203-0214	9335
203-0401	8956
203-1275	8957
203-1276	8958
203-1280	9721
205-0010	92673
205-0032	92674
205-0655	92679
205-0657	92689
205-0933	92698
205-0947	92678
205-1148	92696
205-1149	92695
205-1151	92697

## AFTERMARKET INTERCHANGE ///

STEMCO	DIESELTECH	STEMCO	DIESELTECH	STEMCO	DIESELTECH	STEMCO	DIESELTECH
206-0001	T600	210-0161	9580	213-2530	8880	216-1154	10729
206-0001	T600Z	210-0167	9356	213-2535	8881	216-1158	10731
206-0030	T300	210-0180	9357	213-2540	8882	217-0166	10778
206-0030	T300Z	210-0338	9358	213-2550	8877	217-0171	10536
206-0036	T314	210-0988	9456	213-2560	8898	217-0174	10537
206-0042	T312	210-0989	9457	213-3630	34826	217-0182	10534
206-0042	T312Z	210-0990	9804	213-3635	34785	217-0188	10535
206-0063	T400	210-0991	9451	213-3640	34743	217-0194	10783
206-0063	T400Z	210-0992	9452	213-3650	34744	217-0203	10791
206-0072	T500	210-0993	9453	213-4840	44786	217-0380	10538
206-0072	T500Z	211-0221	9586	213-4850	54831	217-0495	10540
206-0078	T512Z	211-1195	9084	214-1030	8859	217-0663	10788
206-0350	T412Z	211-1211	9056	214-1035	8876	217-0971	10797
206-1040	9486	211-1214	9118	214-1040	8856	217-0972	10309
206-1050	9487	211-1234	8699	214-1050	8857	217-0973	10329
206-1060	9734	211-1235	8698	214-1840	24931	217-0992	10789
207-0196	9503	211-1237	9260	214-1850	24933	217-1004	809796
207-0201	9504	211-1238	9259	214-2440	24835	217-1006	10781
207-0209	9736	211-1244	9146	215-1030	8885	217-1009	10777
207-0215	9506	212-0980	809429	215-1035	8886	217-1013	18148
207-1276	9492	212-0981	809304	215-1040	8887	217-1014	10776
207-1277	9493	212-0983	809302	215-1050	8888	217-1015	10541
207-1283	9495	212-0984	809303	215-1240	14739	217-1017	10796
207-1284	9490	212-0986	809458	215-1250	14737	217-1020	10539
207-1285	9501	212-0987	809308	215-1830	24675	217-1022	28661
207-1286	9502	212-0995	809500	215-1835	24676	217-1024	10780
208-0103	H300PZ	212-0997	809301	215-1840	24677	217-1188	10794
208-0105	H312P	212-1001	809300	215-1850	24678	217-8016	10785
208-0107	H400PZ	212-1002	809307	215-1873	24674	218-0062	10305
208-0108	H412	212-1006	809500	215-1874	24654	218-0064	10762
208-0109	H500PZ	213-0030	8986	215-1875	24936	218-0067	10554
208-0124	H412	213-0035	8987	215-1878	24935	218-0075	10757
208-0125	H314	213-0040	8988	215-2440	24836	218-0079	10759
209-0976	9578	213-0050	8989	215-2450	24838	218-0084	10680
209-0977	8998	213-0060	8990	215-2530	8982	218-0381	10764
209-0987	8052	213-0530	8875	215-2535	8983	218-0488	10681
210-0002	9360	213-0535	8881	215-2540	8878	218-1002	809770
210-0003	9359	213-0540	8882	215-2550	8879	218-1003	809406
210-0004	9628	213-0550	8877	215-2560	8899	218-1006	809408
210-0010	9810	213-1030	8986	215-3640	34673	218-1007	809546
210-0011	9799	213-1035	8987	215-3650	34674	218-1125	10304
210-0014	9801	213-1040	8988	215-4850	44867	218-1126	10305
210-0015	9803	213-1050	8989	216-0056	10313	218-1127	10762
210-0017	9363	213-1060	8990	216-0065	10314	218-1128	10766
210-0019	9366	213-1240	14738	216-0070	10315	218-1129	10756
210-0020	8445	213-1250	14740	216-0074	10730	218-1130	10676
210-0021	9453	213-1830	24752	216-1012	809738	218-1136	68185
210-0022	9364	213-1835	24753	216-1126	10313	218-1137	68183
210-0023	9365	213-1840	24754	216-1127	10314	218-1153	10556
210-0025	9453	213-1850	24755	216-1128	10315	218-1183	10675
210-0026	9806	213-2435	24849	216-1129	10730	218-1184	10676
210-0027	9807	213-2440	24835	216-1147	10732	218-1185	10678
210-0146	9354	213-2450	24837	216-1152	10726	218-1187	10758
210-0153	9355	213-2520	8868	216-1153	10727	218-1190	10795

 CROSS  
REFERENCE

## AFTERMARKET INTERCHANGE



CROSS  
REFERENCE

STEMCO	DIESELTECH	STEMCO	DIESELTECH	STEMCO	DIESELTECH	STEMCO	DIESELTECH
218-1191	10765	225-1094	9718	228-1162	34798	238-0904	844002
218-1193	10557	225-1095	9470	228-1174	64744	238-0906	834004
218-1194	10557	225-1096	9711	228-1177	74627	239-0713	H300
218-1196	809771	225-1097	9476	228-1183	83005	239-0714	H312
218-1199	809547	225-1098	9713	228-1193	74632	239-0715	H400
218-1201	10675	225-1254	9475	228-1194	83014	239-0716	H500
218-1202	10329	225-1259	9393	228-1195	44822	239-0728	H600
218-1203	10678	225-1260	9710	228-1198	83001	240-0285	9720
218-1204	10761	225-1261	9392	228-1235	34814	240-0749	9649
218-1205	10761	225-1264	9712	228-1237	38764	240-0860	9648
218-1206	10308	225-1265	9709	228-1239	34879	240-0865	9650
218-1207	10306	225-1274	9707	228-1263	44821	241-0307	9591
218-1208	10306	225-1275	9473	228-1265	34813	241-0309	9592
218-8030	10681	225-1276	9391	228-1268	84559	241-0312	9593
219-0113	300A1016	225-1277	9392	228-1271	74646	241-0321	9594
219-0118	312A1016	225-1279	9473	228-1282	54129	241-0603	9589
219-0125	400C1016	225-1280	9472	228-1291	78166	241-0604	9590
219-0128	500C1016	227-0257	9599	228-1296	68420	241-0605	9595
219-0132	512A1016	227-0260	24711	228-1306	74645	241-1270	9596
219-0345	412A1016	227-0271	24712	228-1307	74654	242-1280	824001
221-0131	14618	227-0542	24737	228-1313	48570	242-1285	834000
221-0141	14619	227-0544	24941	228-1325	44866	242-1312	824000
221-0148	10745	227-0551	24739	228-1327	38768	242-1315	854000
221-0148	14620	227-0565	34713	229-0220	10337	243-0278	10564
221-0154	24714	227-0566	34715	229-0224	10338	243-0283	10565
221-0155	24672	227-0573	34714	229-0227	10339	243-0299	10567
221-8000	24696	227-0574	34716	229-0229	10340	243-0492	10743
222-0124	24344	227-0577	44854	231-0255	9727	243-0613	809753
222-0130	24345	227-0578	44656	232-0002	9344	243-0615	10747
222-0133	24346	227-0579	44863	232-0939	9341	243-0617	10748
222-0136	24347	227-0585	44731	232-0940	9343	243-0618	10746
222-0136	24718	227-0586	44658	232-0941	9342	243-0619	10742
224-0164	44665	227-0590	54991	234-0327	924105	243-0621	809752
224-0176	34723	227-0598	54720	234-0328	925005	244-0191	8975
224-0463	34724	227-0958	44657	234-0331	925505	244-0192	8976
224-0470	44667	227-0959	54984	234-0333	926005	244-0200	18103
224-0878	54725	227-0961	44659	235-0326	924004	244-0204	8978
224-0880	54726	227-0962	54985	235-0329	924005	244-0602	8979
224-0882	24748	228-0764	44749	235-0332	925506	244-0755	8991
224-0883	24750	228-0780	64668	235-0335	926006	244-0756	8978
224-4018	24717	228-0794	83007	235-0474	924003	244-0763	18144
224-8004	34828	228-0942	83004	235-0475	927006	245-0726	300A1014
225-0006	9390	228-0960	74607	235-8000	926557	245-0728	312A1016
225-0008	9708	228-0961	83002	235-8002	927557	245-0729	400A1014
225-0009	9715	228-1061	44796	236-0315	924104	245-0729	400A1016
225-0010	9717	228-1062	44797	236-0317	925105	245-0730	400A1414
225-0011	9719	228-1065	64708	236-0325	925504	245-0732	500A1016
225-0016	9479	228-1066	54809	236-0330	926004	245-0736	500A1016
225-0185	9471	228-1069	83008	236-0478	927004	245-1282	600A1016
225-0205	9714	228-1086	54808	237-0450	925458	250-0001	9611
225-0207	9394	228-1117	44795	237-0555	925558	250-0002	9617
225-0943	9478	228-1150	84584	237-0886	925553	250-0004	9622
225-0944	9474	228-1159	34799	237-0887	926503	250-0006	9656
225-1093	9706	228-1160	54880	237-0924	925543	250-0013	9619

## AFTERMARKET INTERCHANGE ////

STEMCO	DIESELTECH
250-0016	9613
250-0017	9652
250-0018	9626
250-0020	9618
250-0021	9610
250-0023	9653
250-0024	9651
250-0031	9625
250-0638	9398
250-0640	9399
250-0900	9395
250-0901	9396
250-0902	9647
250-0930	9612
250-0931	9615
250-0970	9616
250-1017	9735
250-1278	9627
250-1280	9397
250-8001	9614
252-0846	834708
253-0189	44664
253-0193	34827
253-0198	34719
253-0466	34720
253-0468	44666
253-0894	54721
253-0896	54722
253-0976	24746
253-0977	24747
253-3018	24938
253-4018	24713
255-0001	8969
255-0002	8963
255-0003	9336
255-0157	9333
255-0162	9332
255-0168	9331
255-0904	9723
255-4030	9722
255-8157	8962
255-8162	8964
255-8168	8965
256-0635	8970
256-0636	8971
256-0637	8972
256-0637	28310
256-0752	8973
258-0681	923120
258-0684	924120
258-0686	925120
258-0994	9430
258-0996	9811
258-1371	94941

STEMCO	DIESELTECH
262-1058	4223
262-1059	3690
262-1060	3691
262-1061	3692
262-1062	3693
262-1063	3694
262-1064	3695
268-1420	9660
268-1422	9661
268-1425	9662
268-1427	9663
268-1430	9604
268-1435	9605
268-1440	9606
268-1520	9664
268-1522	9665
268-1525	9666
268-1527	9667
268-1530	9668
268-1535	9669
268-1545	9670
268-1560	9671
268-1820	9660
268-1825	9662
268-1827	9663
268-1830	9604
268-1835	9605
268-1850	9607
268-1922	9665
268-1925	9666
268-1927	9667
268-1930	9668
268-1935	9669
268-1940	9623
268-1945	9670
268-1950	9624
268-1960	9671
268-2430	9676
268-2435	9678
268-2440	9680
268-2450	9682
268-2450	9682
268-2460	9683
268-2830	9676
268-2835	9678
268-2920	9684
268-2922	9685
268-2925	9686
268-2927	9687
268-2930	9688
268-2935	9690
268-2940	9692
268-2945	9693
268-2950	9694

STEMCO	DIESELTECH
268-2960	9695
268-3532	B314
268-3545	B412
268-3630	B300
268-3635	B312
268-3640	B400
268-3650	B500
268-3660	B600
268-4040	AS400
268-4050	AS500
268-6940	9692
269-0040	10684
269-0044	10685
270-0005	834002
272-0001	809530
272-0002	10560
272-0400	10636
272-0500	10637
272-1350	10631
272-1400	10632
272-1500	10633
272-2350	10639
272-2400	10640
272-2500	10641
272-3400	10644
272-3500	10645
273-0001	48568
273-0068	38223
273-0087	94991
273-0138	58219
273-0155	38269
273-0269	68371
273-0270	58372
273-0324	10566
273-0329	44773
273-0362	88104
273-0363	58251
273-0364	68221
273-0399	83015
273-0409	58225
273-0412	28425
273-0415	48348
273-0416	48347
273-0417	48349
273-0418	58349
273-0423	58330
273-0473	18101
273-0474	18150
273-0487	28662
273-0493	38763
273-0518	48554
273-0540	68374
273-0542	58225
273-0554	68421

STEMCO	DIESELTECH
273-0561	28656
273-0587	212A1014
274-0011	28534
274-0016	38608
274-0019	38607
274-0020	28528
274-0022	68182
274-0023	68181
274-0025	28529
274-0055	28517
274-0064	18109
274-0067	9716
274-0070	10786
274-0071	10787
274-0072	10788
274-0109	28530
274-0121	18110
274-0122	54827
274-0148	38612
274-0150	38611
274-0161	38614
274-0165	10317
274-0172	10784
274-0175	38610
274-0176	94942
274-0180	94010
274-0190	94011
274-0244	28658
274-0253	834007
274-0270	28655
274-0272	38761
274-0277	38613

UNITED MUFFLER	DIESELTECH
10-0005	3677
10-0010	3911
10-0015	3670
10-0020	3918
10-0030	3707
10-0035	3702
11-0005	3700
11-0010	3919
11-0020	3923
11-0035	3927
11-0040	4224
12-0005	3924
2250300BS	3150
2250400BS	3708
6-0025	3654
6-0035	687
6-0045	3651

CROSS  
REFERENCE

## AFTERMARKET INTERCHANGE



CROSS  
REFERENCE

UNITED MUFFLER	DIESELTECH
7-0015	3906
7-0025	609
7-0030	3607
7-0035	3652
7-0040	3618
7-0045	3888
85-0005	3697
85-0006	3914
85-0015	2704
85-0025	3720
85-0030	3627
85-0035	3625
85-0045	4233
C-0005	3915
C-0010	3632
C-0015	3611
C-0020	3710
C-0025	3716
C-0030	3703
C-0040	3610
D-0005	3678
D-0010	3614
D-0015	3932
D-0020	3647
D-0025	3898
D-0030	3900
D-0035	4205
NAV-0005	3916
NAV-0020	3851
NAV-0030	3917
V10-0005	3714
V10-0010	3893
V10-0015	3699
V10-0020	3640
V10-0025	3873
V9-0005	3679
V9-0010	3891
V9-0015	3712
V9-0020	3890
V9-0025	3667
V9-0030	3897
V9-0035	3872

WALKER	DIESELTECH
15146	604006
15147	604007
15556	645301
15684	645341
15693	645316
17190	700120
17197	700046

WALKER	DIESELTECH
17807	6539
17809	700141
17809	709997
17824	6595
17827	700050
17831	6505
17832	6576
17840	700062
17842	700076
17843	700052
17849	700065
17849	700104
17855	700051
17868	700001
21033	3954
21035	3986
21039	3958
21040	3974
21046	2320
21054	3423
21060	3976
21069	3940
21070	3933
21071	3930
21073	3917
21074	3916
21075	2328
21092	2080
21097	3654
21146	3884
21151	3906
21161	3931
21165	3923
21172	3681
21174	3614
21188	3970
21259	687
21300	3851
21464	3894
21467	3618
21468	3721
21470	3720
21471	3887
21473	3955
21473	3961
21475	3654
21476	2704
21578	3690
21579	3691
21580	3692
21581	3693
21582	3694
21784	2538
21832	3611
21833	3911

WALKER	DIESELTECH
21835	3682
21838	3625
21969	3918
22000	3256
22004	3632
22022	3980
22023	3953
22032	3950
22033	3977
22037	3956
22038	3999
22040	3964
22042	3947
22043	3952
22046	3973
22047	3971
22100	3424
22171	3123
22231	3610
22234	45
22235	3654
22329	3387
22337	3698
22356	3651
22381	3900
22389	3652
22391	3703
22444	3972
22449	3710
22460	3255
22512	2943
22538	3875
22551	3716
22552	3647
22566	3719
22571	3889
22572	3888
22604	3704
22632	3689
22635	3880
22636	3627
22642	3938
22643	3928
22648	3424
22658	3995
22664	3919
22672	2062
22674	2059
22675	2063
22678	2178
22678	3598
22679	2064
22719	2058
22767	3626
22769	3617

WALKER	DIESELTECH
22770	3925
22771	3895
22789	3711
22822	3663
22833	3676
22865	3150
22866	3697
22888	3700
22899	3713
22907	3913
22914	3872
22915	3702
22916	3714
22920	3699
22932	3914
22936	3891
22940	3667
22941	3712
22948	3926
22958	3927
22962	3893
22963	3640
22964	3897
22965	3666
22966	3715
22967	4218
22971	4205
22991	4224
29029	809303
29041	809458
29042	809429
29046	809300
29052	809304
29100	824001
29109	809770
29120	824000
29121	809796
29209	809530
29210	809408
29219	9811
31307	8724
31337	8771
31358	9240
31370	9086
31394	9261
31398	9234
31400	8717
31405	8773
31416	9083
31417	9056
31500	8738
31508	9118
31512	9079
31520	9220
31530	9245

## AFTERMARKET INTERCHANGE ///

WALKER	DIESELTECH
31543	9244
31591	9119
31802	8781
31803	8780
31806	8789
31821	9743
31850	8775
31850	9165
31851	8776
31865	8792
31875	9149
31883	9146
31887	8792
31952	9160
33220	9666
33222	9668
33223	9669
33224	9623
33225	9624
33226	9666
33227	9667
33228	9684
33229	9685
33230	9664
33231	9666
33240	9686
33241	9687
33271	9671
33272	9668
33273	9669
33275	9670
33277	9671
33278	9688
33279	9690
33280	9692
33282	9694
33283	9695
33284	9604
33285	9605
33288	9607
33304	H400PZ
33305	H500PZ
33310	9676
33311	9678
33314	9682
33315	9683
33967	9604
33968	9605
33969	9606
33974	9660
33975	9661
33976	9662
33977	9663
33980	9702
33981	9731

WALKER	DIESELTECH
33983	9732
35029	8137
35029	8536
35036	9652
35103	8483
35114	8581
35119	8531
35123	8518
35125	8503
35125	8592
35126	8519
35131	9651
35143	8515
35143	8516
35143	8545
35144	8176
35145	8554
35149	8061
35150	8148
35151	8077
35158	8074
35158	8078
35164	9704
35165	PH450
35181	8494
35182	8493
35186	8067
35187	PH550
35206	8149
35209	8484
35212	8075
35225	9896
35226	9897
35227	AS400
35228	AS500
35229	8066
35229	8106
35243	8128
35243	8129
35261	8204
35270	8573
35274	8179
35276	8085
35284	8071
35286	8092
35290	9653
35304	U212
35322	U118
35323	U114
35325	U112
35334	U218
35335	H200
35336	H214
35337	H212
35338	9580

WALKER	DIESELTECH
35339	8060
35351	8553
35352	8166
35358	8215
35358	8566
35362	8112
35362	8560
35364	H218
35370	9799
35373	T412Z
35385	8537
35393	9369
35401	9610
35405	U158
35406	U134
35407	U178
35408	U200
35409	T600
35409	T600Z
35413	U214
35414	U212
35415	B314
35423	B412
35424	H412
35441	9801
35442	9803
35449	9398
35460	8196
35462	8223
35463	8245
35466	8197
35473	8233
35475	8165
35490	9260
35494	9613
35495	9611
35496	9627
35498	9614
35499	9617
35500	9616
35510	H258
35511	8158
35512	9371
35513	9370
35514	9372
35520	9622
35525	8438
35527	8487
35530	9578
35600	8301
35606	9363
35608	9367
35617	9378
35618	9373
35619	9374

WALKER	DIESELTECH
35620	B200
35621	B214
35622	B234
35624	9501
35636	9618
35641	9647
35662	8119
35662	8498
35690	9612
35693	9506
35695	9395
35696	9502
35702	8181
35702	8182
35706	8195
35719	8122
35719	8161
35723	H238
35724	8062
35725	8180
35728	8151
35729	PH50
35733	9360
35734	9366
35745	8445
35746	9735
35750	8068
35750	8098
35752	H400PZ
35753	H312P
35757	H500
35758	H412
35760	H314
35766	8080
35768	8492
35772	H300
35773	H312
35774	H400
35775	H500PZ
35776	9492
35777	9493
35786	T300Z
35787	T312Z
35788	T400Z
35789	T500Z
35790	9806
35791	9807
35793	H234P
35794	H300PZ
35795	H600
35799	9503
35800	9504
35804	9396
35805	9399
35806	9615

CROSS REFERENCE



## AFTERMARKET INTERCHANGE



CROSS  
REFERENCE

WALKER	DIESELTECH
35807	4223
35811	8133
35819	8572
35819	8593
35852	9364
35853	9365
35854	9354
35855	9355
35856	9356
35870	8390
35871	8391
35880	8429
35884	9456
35885	9457
35887	9452
35898	8052
35899	9628
35907	9375
35909	9376
35910	9377
35931	9573
35933	9453
35940	8113
35941	8568
35944	9937
35950	9625
35951	8139
35958	T27
35966	8998
35972	9357
35975	B500
35976	B400
35977	B312
35978	B300
35979	B212
35980	B600
35983	9358
35984	9359
36119	8356
36125	8056
36145	U200
36147	T234
36160	9575
36171	924004
36172	924005
36173	925506
36175	926006
36186	926004
36190	925458
36202	9590
36203	9589
36204	9591
36205	9592
36206	9594
36207	9595

WALKER	DIESELTECH
36208	9596
36212	9737
36213	9397
36224	9804
36225	9656
36226	9807
36234	8055
36249	H300Z
36263	8348
36269	8357
36270	8349
36393	9753
36433	AS214
36434	AS212
36435	AS300
36436	AS312
36437	SAS214
36438	SAS212
36439	SAS300
36440	SAS312
36441	SAS400
36442	SAS500
36457	9769
40000	8860
40001	8862
40002	8864
40003	8866
40005	8868
40006	8870
40007	8872
40008	8875
40009	8880
40010	8881
40011	8882
40012	8877
40013	8865
40020	8982
40021	8983
40022	8878
40023	8879
40024	8881
40025	8882
40026	8877
40030	8872
40211	93986
40220	92696
40223	92697
40247	92673
40256	92679
40257	92689
40295	93972
40295	94938
40342	94933
40343	94932
40364	92674

WALKER	DIESELTECH
40405	94909
40573	95979
40577	94941
40582	95984
40585	95983
40590	94011
41000	10670
41001	10671
41002	10672
41013	10921
41094	14343
41095	24344
41097	24346
41098	10673
41099	10674
41187	10311
41188	10320
41189	10725
41204	10684
41217	10685
41221	10337
41222	10338
41223	10339
41224	10340
41231	10922
41233	14634
41245	14342
41256	10780
41365	10675
41366	10676
41367	10678
41422	10921
41428	10564
41429	10565
41430	10566
41431	10746
41432	10774
41434	10534
41435	10535
41436	10791
41437	10312
41438	10562
41439	10318
41441	10303
41472	10761
41473	10539
41474	10781
41477	10730
41514	8969
41515	9650
41532	10680
41534	10758
41535	10757
41536	10777
41537	10794

WALKER	DIESELTECH
41538	10785
41557	8974
41558	10301
41563	8963
41612	10567
41615	10636
41616	10637
41618	10631
41619	10632
41620	10633
41623	10644
41624	10645
41626	10639
41627	10640
41628	10641
41630	10681
41631	10773
41632	10743
41633	10795
41637	10794
41638	18148
41639	10736
41641	10742
41645	9390
41646	9470
41647	9473
41648	9391
41649	9392
41650	9476
41651	9472
41652	9474
41653	9475
41654	9393
41655	9478
41657	9392
41658	9394
41659	9708
41662	9479
41685	10776
41686	10726
41687	8954
41689	9717
41692	14738
41693	14737
41694	14740
41696	9716
41700	8912
41768	10759
41769	10764
41778	18152
41786	9723
41832	10789
41844	9720
41860	9713
41862	9710

## AFTERMARKET INTERCHANGE ////

WALKER	DIESELTECH
41863	9714
41864	9712
41865	9709
41872	9711
41879	9721
41882	8934
41889	8979
41890	9648
41891	9649
41892	14601
41893	14602
41894	8957
41895	14603
41896	18103
41897	8978
41898	8958
41899	14605
41909	8965
41920	8662
41924	8663
41926	8949
41932	8935
41935	8661
41937	8904
41939	8936
41940	14337
41941	8944
41942	8660
41943	8945
41944	8933
41945	8907
41946	8902
41948	8950
41949	8909
41951	8951
41952	8946
41953	8938
41954	8939
41955	8911
41956	14662
41957	14338
41958	8947
41959	8913
41960	8941
41961	8948
41962	8940
41963	8942
41965	8943
41967	8980
41970	8975
41971	8970
41972	9600
41973	8953
41974	8960
41975	9334

WALKER	DIESELTECH
41977	14340
41978	8976
41979	8971
41980	9333
41981	8955
41982	8962
41983	18144
41984	8964
41987	8972
41988	9722
41989	8956
41991	9332
41992	8973
41994	9331
41997	9336
41998	9335
41999	8959
42065	24752
42066	24753
42067	24754
42068	24755
42069	24835
42070	24837
42072	24747
42081	10787
42125	10541
42126	24712
42127	9599
42128	24696
42129	24717
42130	24718
42177	24654
42178	24941
42185	10305
42186	10788
42220	28400
42233	28502
42246	10727
42247	10745
42249	10747
42253	10788
42272	10765
42274	10796
42288	10536
42338	24836
42339	24838
42344	10778
42355	10729
42364	28598
42377	24672
42423	24677
42424	24678
42444	28509
42445	10304
42447	14620

WALKER	DIESELTECH
42448	14618
42449	14619
42453	10731
42455	24676
42477	24629
42477	24942
42492	24675
42499	24646
42530	24739
42531	24737
42543	24750
42544	24748
42562	10556
42596	9597
42596	27875
42606	24731
42715	24713
42716	24714
42758	10315
42759	10304
42760	10313
42761	10314
42763	10557
42846	28237
42855	10317
42856	10560
42857	10537
42858	10554
42891	24711
42901	28383
42936	10538
42937	10306
42938	10308
42939	10540
42944	10556
42956	28425
42984	18083
43159	28296
43202	34673
43203	34674
43245	38528
43267	28437
43295	28240
43297	38345
43299	3373
43319	34715
43320	34719
43321	34720
43324	34879
43348	10766
43366	34714
43381	34743
43382	34744
43425	38553
43477	28424

WALKER	DIESELTECH
43486	28401
43507	28474
43582	34716
43606	34713
43698	10797
43719	34724
43729	28308
43782	28134
43794	28494
44059	54117
44126	44656
44127	44658
44132	83015
44161	54871
44161	54872
44206	54833
44240	38469w18078
44258	2002
44264	54875
44266	44811
44299	44664
44301	44854
44308	44731
44353	38415
44400	38556
44426	44809
44456	44657
44511	48152
44593	28504
44620	54815
44638	44667
44927	54815
44928	54812
45006	64690
45052	48300
45066	54991
45076	58349
45105	54810
45205	54835
45206	54834
45294	58345
45295	64749
45307	54786
45308	54785
45340	54985
45354	54848
45381	54863
45423	54847
45427	64722
45454	64785
45465	64754
45467	54124
45468	54995
45656	54655
45672	54912

CROSS REFERENCE

## AFTERMARKET INTERCHANGE



CROSS  
REFERENCE

WALKER	DIESELTECH
45726	54725
45727	54726
45751	54749
45752	54750
45993	54805
46425	54650
46588	74607
46704	64691
46776	64741
46778	54720
46832	68370
46887	68421
46911	64793
46912	64794
46913	64793
46914	64794
46917	64791
46918	64792
47552	74439
47617	74621
47645	74632
47653	74635
47669	84567
47698	74642
47767	64774
47960	200A7514
47968	112A7516
47971	134A7516
47972	200A7516
47973	214A7514
47974	212A7514
49010	300A1016SN
49011	312A1016
49012	400C1016
49015	500C1016
49027	600C1016
49028	8986
49029	8987
49030	8988
49031	8989
49032	8885
49033	8886
49034	8887
49035	8888
49036	8990
49044	8884
49045	112A1016
49046	134A1016
49047	200A1014
49048	214A1014
49049	212A1014
49052	400A1414
49056	412A1016
49057	178A1016
49060	8883

WALKER	DIESELTECH
49061	8855
49062	600A1016
49063	8895
49064	500A1016
49065	300A1014
49070	8856
49071	8857
49078	8985
49089	8986
49090	8987
49091	8988
49092	8989
49098	312A1016
49099	412A1016
49105	8859
49106	8876
49151	83005
49159	300A1014
49160	312A1016
49161	400A1014
49162	500A1016
49165	83001
49195	234A1014
49214	924120
49215	925120
49234	83034
49235	83035
49238	83043
50008	8898
50015	8899
52097	28557
52119	10783
52130	28682
52391	28674
53017	38612
53042	10732
53053	34827
53090	24849
53094	10762
53629	44892
53637	38860
54047	34826
54048	34785
54050	44867
54089	38631
54136	38627
54150	54997
54623	58479
55006	44786
55007	54831
55102	54994
55115	54132
55159	68451
55175	54953
55203	54954

WALKER	DIESELTECH
55472	58517
55478	58464
55479	54166
56174	400A1016
56179	64805

## FARM TRACTOR INTERCHANGE

A-C	DIESELTECH
701444	3950
70210081	3946
70219534	3947
70227240	3951
70229531	3952
70233450	3951
70234494	3953
70261975	3948
70268785	3948
70271755	3949

CASE	DIESEL TECH
A20494	3954
A24103	3956
A24314	3955
A27105	3956
A39561	3957
A64990	4210
G13032	3959
G45239	3961
T42286	3956
VTA1135	3958
VTA2811	3958

COCKSHUTT	DIESEL TECH
164079A	3962
166486A	3962

DEERE	DIESEL TECH
AA2214R	3967
AB2700R	3968
AF3770R	3967
AH11014H	3963
AM3101T	3970
AM364T	3969
AM625T	3969
AR26640	3965
AR26786	3965
AR30189	3966
AR30190	3966
AR46323	9890
AR86604	3996
AR89594	3996
AT10523	18146
AT10646T	3970
AT21689	3964
AT64102	3964
AT75038	3996
R21827R	3968
R2235	9890
RE20224	4200

FORD-NH	DIESEL TECH
310079	3971
310079	3997
311051	38757
311466	64786
8N5230	7661
CAPN5200A	9894
C7NN5230AB	3972
C7NN5230AC	3972
C7NN5230Z	3972
C7NN5245B	44865
D5NN5230F	4203
D6NN5230F	7660
E4NN5230GB17M	4204
NAA5230E	3973
NCA5255B	38756
NCA5263B	54121

INT'L	DIESEL TECH
106337C4	3998
131086C91	4202
351436R92	3974
350600R95	3982
350601R95	3975
350660R95	3982
360720R91	3981
360720R92	3981
370664R1	3978
370773R91	3975
371039R91	4201
384345R1	3977
384345R91	3977
384346R91	3976
393840R91	3980
398511R1	3979
403551R1	3975

M-F	DIESEL TECH
180364M91	3986
181461M1	9895
181600M91	7663
181860M91	7442
181867M91	3983
182609M91	3984
194431M91	3987
32289A	3985
505545M91	7442
505545M91	7663
505545M92	3986
522584M91	7664
522589M91	3989
522589M91	7664

M-F	DIESEL TECH
523394M95	3988
535389M91	3990
539523M92	3989
539525M91	3989
578090M92	3990
767994M91	3985
890476M92	3989
998669M91	3990

M-M	DIESEL TECH
10A7889	3999
10A8693	3999

OLIVER	DIESEL TECH
100694A	3992
104764A	3993
155623A	3992
155980A	3993
164079A	3992
164080A	3993
K452	4248
K452B	3991

VERSATILE	DIESEL TECH
36460	3995
606T123A	3995

### LEGEND

A-C = ALLIS-CHALMERS  
M-F = MASSEY-FERGUSON  
M-M = MINNEAPOLIS-MOLINE  
INT'L = INTERNATIONAL/NAVISTAR

## HOW-TO FIND GUIDE

### VERTICAL SYSTEM COMPONENTS

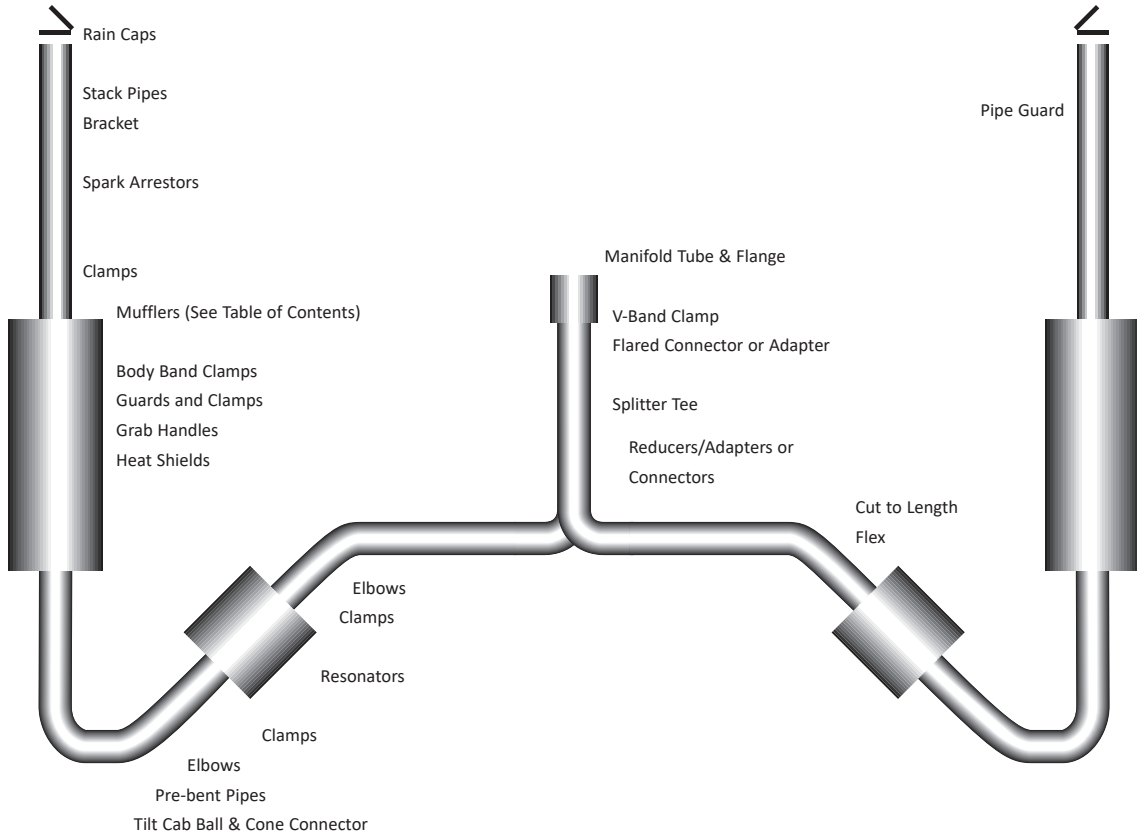

APPENDIX

### HORIZONTAL SYSTEM COMPONENTS

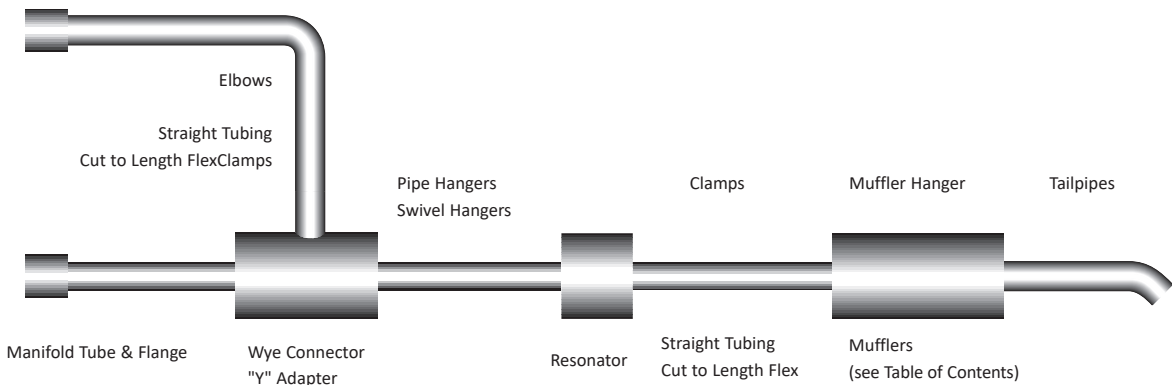

# HOW-TO FIND GUIDE

## ① SERIES P30/3500

## CHEV./GMC TRUCK 6 CYL.

91-95 6 Cyl. ② P30/P3500; 133", 157", 178" W.B., 262(4.3L) Engine; 1 Ton

③ (21412)

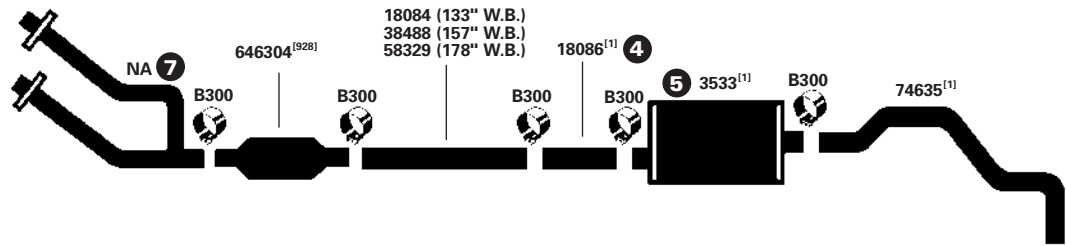

⑥ DIRECT FIT MAXIMUM MUFFLER...700141 UNIVERSAL FIT MAXIMUM MUFFLER...6577  
UNIVERSAL CONVERTER...606007<sup>[928]</sup>

- ① Basic Listing is provided to show make and model for easy reference.
- ② Within model, additional information is provided to distinguish year and engine options.
- ③ Every listing is numbered for quick reference
- ④ Footnotes are printed at the end of each truck model section.
- ⑤ Part numbers appear adjacent to each part for ease of use.
- ⑥ Options for additional muffler, converter and specialty parts are listed.
- ⑦ NA = Not Available; we do not carry this part.

## TRUCK CLASSIFICATION GUIDE

Based on Gross Vehicle Weight of Truck (GVW)

Light	1	Up to 6,000 lbs GVW
Light	2	6,001 – 10,000 lbs GVW
Medium	3	10,001 – 14,000 lbs GVW
Medium	4	14,001 – 16,000 lbs GVW
Medium	5	16,001 – 19,500 lbs GVW
Medium	6	19,501 – 26,000 lbs GVW
Heavy	7	26,001 – 33,000 lbs GVW
Heavy	8	33,001 lbs and up GVW

## ENGINE SIZE CONVERSION CHART

C.I.D.	C.C.	LITER	C.I.D.	C.C.	LITER	C.I.D.	C.C.	LITER
61	1000	1.0	255	4179	4.2	466	7638	7.6
92	1500	1.5	258	4229	4.2	475	7785	7.8
98	1606	1.6	260	4261	4.3	495	8113	8.1
105	1721	1.7	265	4343	4.3	500	8195	8.2
112	1836	1.8	267	4376	4.4	504	8261	8.3
121	1983	2.0	292	4786	4.8	525	8605	8.6
122	2000	2.0	300	4917	4.9	551	9031	9.0
134	2196	2.2	301	4933	4.9	552	9047	9.0
135	2213	2.2	302	4949	5.0	555	9096	9.1
140	2295	2.3	304	4983	5.0	568	9310	9.3
151	2475	2.5	305	4999	5.0	611	10014	10.0
156	2557	2.6	307	5032	5.0	636	10424	10.4
159	2606	2.6	318	5212	5.2	638	10457	10.5
170	2786	2.8	350	5736	5.7	672	11014	11.0
171	2803	2.8	351	5753	5.8	673	11030	11.0
173	2835	2.8	359	5884	5.9	707	11588	11.6
181	2967	3.0	360	5900	5.9	736	12036	12.0
196	3212	3.2	368	6032	6.0	743	12178	12.2
200	3278	3.3	378	6195	6.2	852	13964	13.9
212	3475	3.5	379	6212	6.2	855	14013	14.0
225	3688	3.7	400	6556	6.6	864	14161	14.2
229	3753	3.8	403	6605	6.6	866	14194	14.2
231	3786	3.8	420	6884	6.9	893	14636	14.6
232	3802	3.8	425	6966	7.0	903	14800	14.8
238	3901	3.9	426	6982	7.0	927	15193	15.2
250	4097	4.1	454	7447	7.4	1099	18013	18.0
252	4130	4.1	460	7539	7.5	1151	18848	18.8

## FOR ENGINES NOT LISTED ABOVE, USE FOLLOWING CONVERSION TABLE

TO CONVERT	INTO	MULTIPLY BY-
C.I.D.	cc	16.39
C.I.D.	LITER	.01639
cc	C.I.D.	.06101
LITER	C.I.D.	61.01

## WELDING TIPS

### ❶ OXYACETYLENE WELDING

**Filler Metal:** Use a mild steel filler, 3/32" diameter, free of rust. (American Welding Society classification A5.2)  
**DO NOT** use copper coated filler metal.

**Welding Equipment:** Use a number 3 or 4 tip. Observe instructions of the equipment manufacturer when adjusting the operating pressures at the gas regulators.

**Procedure:** Clean the parts to be welded thoroughly. Incline the torch at a 45° angle away from the direction of travel. Use the forehand welding technique. Keep the torch flame on the tip of the filler rod, not in the center of the puddle.

### ❷ SHIELDED METAL-ARC (STICK ELECTRODE)

Any one of the following rods are recommended: Raco Fer-Al (Reid-Avery Co.), E-6011 (P. & H.), Fleetwood 47 (Lincoln), W-52 (General Electric), Flex-Arc LOH-2 (Westinghouse), Stainless Steel Rods Type 309 or 310 and Low Hydrogen Rods E-7015, E-7016 or E-7018.

### ❸ GAS METAL-ARC (MIG)

Carbon dioxide shielding gas is used with A-675 Airco Wire.

## PRODUCT WARRANTY

HEAVY DUTY EXHAUST PRODUCTS	LENGTH OF WARRANTY
Diesel Mufflers, Vertical Installations	4 Years or 500,000 miles
Diesel Mufflers, Horizontal Installations	3 Years or 500,000 miles
Gas Mufflers	1 Year
Accessories	1 Year
Chrome Parts (Peeling & Blistering Only)	90 Days

## TERMS & CONDITIONS

Warranty coverage begins on the date and mileage the part is purchased by the user and expires when the specified number of years or miles has passed, whichever occurs first.

The Length of Warranty for replacement parts provided under Warranty coverage is the balance of the Warranty period remaining on the part being replaced.

## WARRANTY STATEMENT

DIESELTECH™ warrants its products against failure due to defects in materials and workmanship for the period specified under Terms and Conditions for the particular part. DIESELTECH's obligation under this warranty covers replacement of the failed part including transportation charges. If the DIESELTECH product failure is the sole and direct cause of damage to the equipment on which the product was installed, DIESELTECH will reimburse reasonable costs to restore the equipment to the condition it was in immediately before the failure.

This warranty does not cover failure due to misapplication, misuse, abuse, neglect, rust through and corrosion (muffler), improper service practices or non-approved modification. This warranty gives you specific legal rights. You may have other rights which may vary from state to state. Engine and Equipment Manufacturers warranties remain in effect when DIESELTECH products are used. DIESELTECH must be notified of any claims covered by this warranty within one year of the date of failure.



## 5 MAJOR SOURCES OF NOISE IN TRUCKS

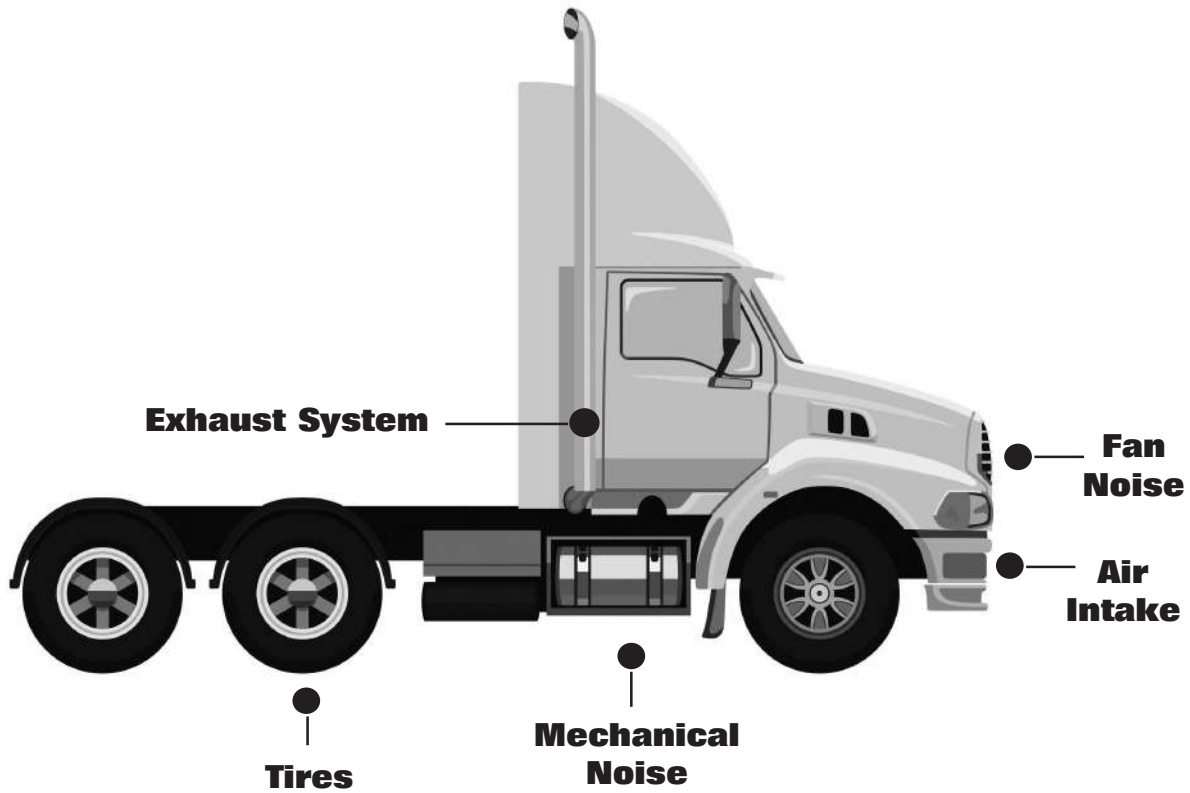

## U.S. EPA NOISE REGULATIONS FOR ON ROAD TRUCKS

The first nationwide regulation of truck noise was established with the Noise Control Act of 1972 (P.L. 92-574.86 STAT. 1234). Regulations apply to trucks greater than 10,000 lbs GVW. Noise regulations apply to total truck noise, not just exhaust noise. The five major sources of noise in trucks are:

- 1. Fan Noise
- 2. Air Intake
- 3. Mechanical Noise (Engine & Drive Train)
- 4. Tires
- 5. Exhaust

### TWICE THE LOUDNESS IS 10dB INCREASE

The increases are not linear! Increasing noise by 10dB sounds twice as loud.

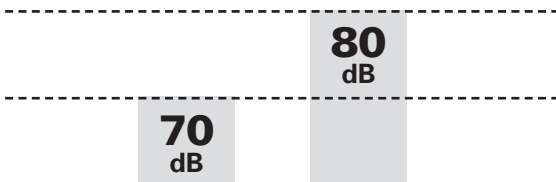

## NOISE REDUCTION TIPS

- 1 Make sure your muffler is recommended by the muffler manufacturer for the particular engine in your vehicle. To meet most new noise laws, the "universal" muffler must be replaced by a muffler designed specifically for the engine.
- 2 Tail pipes on horizontal exhaust systems should be tipped toward the center of the vehicle to avoid noise reflection off the road.
- 3 If you have curved stacks, replace them with straight stacks. Noise coming from a pipe outlet is directional and straight stacks will throw noise up, not to the side. Rain stacks and 45° cut stacks do not appreciably affect noise levels.
- 4 The length of stack installed on the muffler can be critical. If an irritating "rap" is heard at certain engine speeds, try stacks with different lengths.
- 5 In an exhaust system with piping exceeding 10 feet in length, the muffler is suggested to be installed where the exhaust pipe to the muffler is either one-half or four times the length of the tail pipe.
- 6 A resonator can be used in-line with the recommended muffler for additional noise reduction.
- 7 If you have increased the size of the exhaust piping or made a dual out of a single system, check recommendations for piping size. Over-sized systems are exceedingly noisy!
- 8 The vehicle operator, to a certain extent can control his vehicle noise. The greater the engine load the louder the noise. Certain engine speeds may be more noisy than others. High vehicle speed causes more tire noise. Operating an engine brake when it's not needed may cause extra noise.
- 9 If the above-mentioned techniques do not solve your problem, contact DIESELTECH for specific recommendations.

## MAINTENANCE TIPS

- 1 Check flex tubing regularly. Repair worn or leaking tubing.
- 2 Make sure the exhaust system is properly supported with required brackets, clamps and braces.
- 3 Check strap seal band clamps to ensure properly tightened to avoid leaks.
- 4 Consider acoustic compound when repairing OD-ID connections.

## AFTER MARKET REGULATIONS FOR TOTAL TRUCK NOISE

US EPA regulations stipulate maximum noise levels for both new (first-fit) and in-use trucks. Vehicle manufacturers are responsible for compliance of new trucks, and owners are responsible for in-use trucks. New trucks must be no louder than 80 dB at 50 feet. In-use trucks, if manufactured 1986

or later, must be less than 83 dB. If they were manufactured before 1986, they must be no louder than 86 dB. EPA regulations also stipulate that a replacement muffler be no louder than the original equipment (first-fit) muffler.

## EXHAUST PRODUCT MATERIALS

There are a number of materials used in heavy duty exhaust applications. Some of the materials are appropriate for heavy duty applications. Other choices are not durable at the temperatures generated by gas and diesel engines and should be avoided if acceptable service life is desired. Materials selected must not only survive high temperatures, but also severe vibration, corrosive exhaust gasses, and external corroding agents such as salt and water.

The materials generally considered for exhaust parts are as follows:

- Aluminized Steel
- 400 Series Stainless Steel
- 400 Series Aluminized Stainless Steel
- 300 Series Stainless Steel
- Galvanized Steel
- Low Carbon Cold Rolled Steel (CRS)

**Aluminized Steel** is the preferred material for most heavy duty diesel applications. Aluminized Steel is a low carbon steel with a thin layer of aluminum alloyed to the surface. The aluminum provides galvanic protection for the base material. Aluminized Steel parts have an ultimate service temperature of 1250° F with a continuous duty temperature of 1100° F. This material has excellent corrosion resistance to acidic diesel exhaust gasses. Aluminized Steel parts provide excellent field life at a reasonable cost.

**400 Series Steels** are used for extended service life in diesel applications, and often in gas applications due to their higher operating temperatures. This material family provides slightly better strength at exhaust system temperatures than aluminized steel.

The most common 400 Series Steel used in exhaust applications is Type 409. It is stronger than aluminized but has cosmetic problems at exhaust system temperature. At first exposure to high temperature it discolors. Over time it develops a nondestructive coating of surface rust. After an extended time in the field a 409 product will display external discoloration and look worse than a similar aluminized part. Parts made with type 409 generally require some type of paint or other coating to slightly delay the onset of external discoloration, and the parts will hold a magnet due to higher iron content.

Another choice is 409 Stainless Steel with an aluminum coating. Aluminized 409 is used on Diesel Catalytic Converter mufflers due to its excellent high temperature resistance and the corrosion protection of the aluminized coating. This is a premium material found primarily on emission products or high temperature gas applications.

**300 Series Stainless Steels** are also applied in exhaust systems. The most common material is Type 304. This material has excellent corrosion resistance and very good high temperature strength and is used in some muffler applications where very high stresses occur. It is also used as a premium material for gas applications. The most prevalent use of the material in diesel heavy duty applications is for flex pipe. Flex pipe produced from light gauge 304 Stainless Steel is an excellent choice considering all the factors of cost, durability, and service life. In general field service life with stainless steel flex pipe is very good if the flex tubing is installed properly.

Often **Chrome Plated Cold Rolled Steel** parts are found on exhaust system parts. This material is a reasonable choice when a bright mirror finish is desired. Corrosion from the inside of the product can still occur, Chrome parts are very challenging to produce. It is important to produce the parts with a high level of quality because surface irregularities (and field damage to the surface) will lead to external rust. An alternate choice for chrome parts is **Bright Annealed Stainless Steel**. This material provides a bright mirror like finish with excellent exhaust service life. The material is costly, but part of the cost increase is offset by using lighter gauges.

**Galvanized Steel** parts are sometimes used in the exhaust market. Galvanized Steel has very poor field performance. This material has an upper temperature limit of approximately 600° F. At temperatures greater than 600° F the material rapidly corrodes with a resulting degradation in appearance and robust failure. Galvanized Steel is often used for flex pipe as a low cost replacement part. The initial low cost is offset by the limited field life of the product.

**Cold Rolled Steel (CRS)** is a very poor choice for any exhaust system part. This material is extremely susceptible to corrosion. These parts are only used when the lowest possible cost is desired. It is rare to find mufflers made of cold rolled steel, but there are stacks offered in some markets in Cold Rolled Steel. Clamps are another product commonly produced out of Cold Rolled Steel. Clamps are not exposed to the corrosive acids found in exhaust gasses but the high temperatures cause clamps to degrade rapidly in appearance and in function. Cold Rolled Steel clamps can be very difficult to remove after a short time in the field.

## Light- and Medium-duty: Classes 2-6

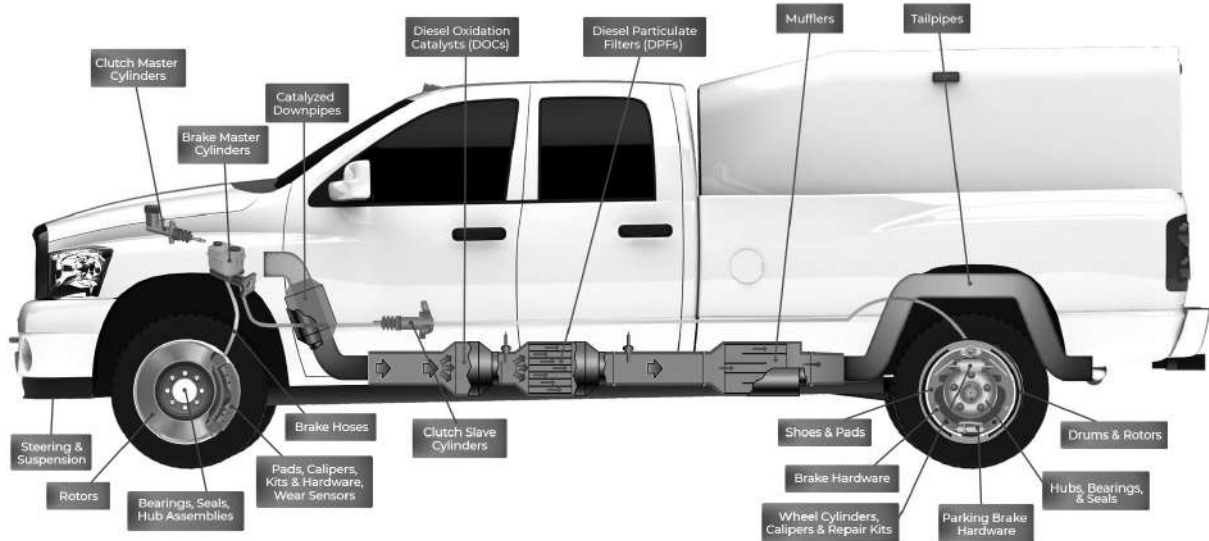

Complete DieselTech exhaust system coverage for:  
System sensors | Exhaust tubing, pipes & connectors | Gaskets, clamps, hangers & other hardware



## Heavy-duty: Classes 7-8

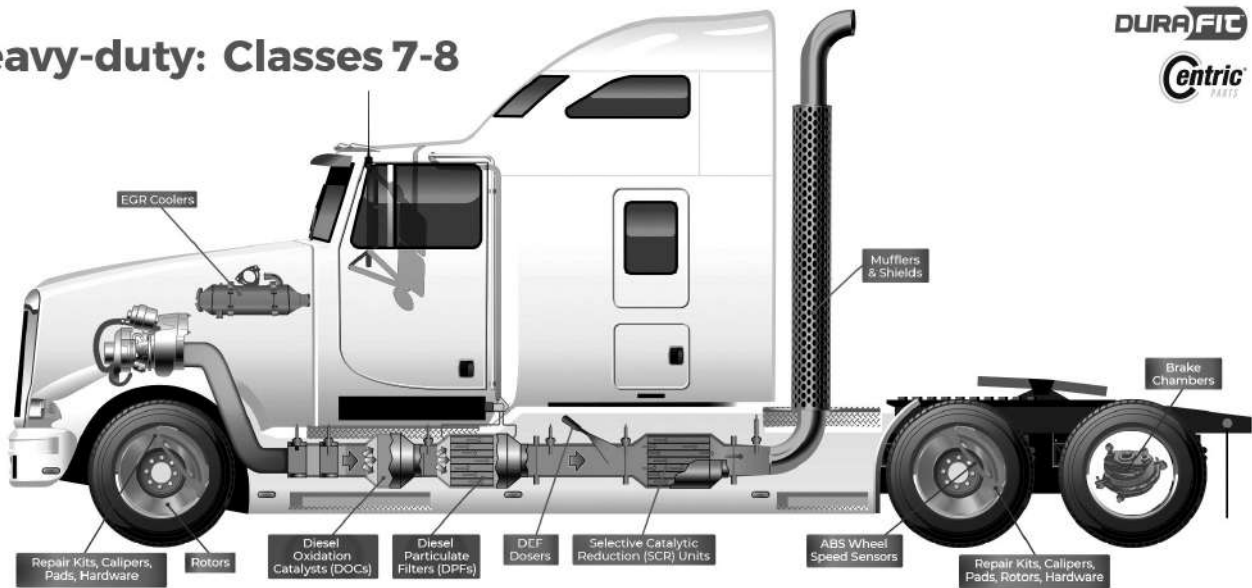

Complete turbo-to-tailpipe system coverage for:  
System sensors & bungs | Exhaust tubing, pipes, connectors & bellows | Gaskets, clamps & other hardware

## Industry-leading content and coverage.

Vertical integration along with decades of aftermarket experience in emissions and brake systems, provides you with convenient single-source access to three leading fleet brands:

**DieselTech:** Full line of medium- and heavy-duty exhaust and emissions parts

**DuraFit:** Comprehensive all-makes product line of heavy-duty DPFs and DOCs

**Centric Parts:** Extensive part coverage for medium- and heavy-duty brake systems

Our product lines cover hundreds of popular Class 2-8 applications across almost every popular original equipment manufacturer (OEM).

## TRUCK EXHAUST – FLEET SURVEY FORM

Fleet Name \_\_\_\_\_

Street \_\_\_\_\_ City/State \_\_\_\_\_

Owner/Manager \_\_\_\_\_ Buyer \_\_\_\_\_

Maint. Supervisor \_\_\_\_\_ Pts. Mgr. \_\_\_\_\_

Phone \_\_\_\_\_

Exhaust Brands \_\_\_\_\_ Suppliers \_\_\_\_\_

TRUCK CLASS	VEHICLE				ENGINE		EXHAUST SYSTEM*			
	YEAR	MAKE	MODEL	#	MAKE	MODEL/SIZE	DIA.	H/V	S/D	VARIATIONS
1-3										
4-6										
7-8										

\*H=Horizontal    V=Vertical    S=Single    D=Dual    Variations may be Wye Connectors, Tilt Cab, Chrome Stacks, Etc.

General Comments \_\_\_\_\_

Call Made By \_\_\_\_\_ Date \_\_\_\_\_  
(Sales Person)

## HEAVY DUTY – EXHAUST SYSTEM CHECKLIST

ENGINE			EXHAUST DESIGN	
	MAKE	MUFFLERS	STYLE*	
	MODEL		VERTICAL	
TURBOCHARGED			HORIZONTAL	
			INLET SIZE	
NATURALLY ASPIRATED		OUTLET SIZE		
		SINGLE		
MANIFOLD OR TURBO OUTLET DIAMETER		EXHAUST SYSTEM OR STACKS	DUAL	
		VERTICAL		
		HORIZONTAL		

\*Refer to Data Section of Catalog

### System Needs:

Manifold Tube/Flange _____	“Y” Pipe _____	Stack Pipe _____
Lipped Flange _____	Tail Spout _____	Muffler Guard _____
V-band Clamp _____	Rain Cap _____	Pipe Guard _____
15° Elbow _____	Straight Tubing _____	Hanger/Bracket _____
45° Elbow _____	Flex Connector _____	Resonator _____
90° Elbow _____	Clamps _____	Wye Connector _____
Reducer/Connector _____	Pipe _____	Muffler _____
Splitter T Adapter _____	Flex Tubing _____	Spark Arrestor _____

## TRUCK MODEL IDENTIFICATION INDEX

**Medium Duty** trucks are 1-2½ ton load capacity vehicles with a GVW rating of 10,001 to 26,000 pounds.  
Examples: school buses, delivery trucks, motor homes.

**Heavy Duty** trucks are 2½ ton and over load capacity vehicles with a GVW rating of 26,001 pounds and over.  
Example: semi tractors, cement trucks, fire trucks.

### CHEVROLET/GMC MEDIUM DUTY

P	Forward Control	Series 40
C	Conventional, TopKick/Kodiak	Series 40, 50, 60, 65, 70, 80
M	Tandem	Series 50, 60, 65, 70, 80
S	School Bus	School Bus Catalog
T	Tilt Cab	Series 40, 50, 60, 65, 70, 80
W	Tilt Cab	W4N, W5N, W6N, W7N

### DODGE MEDIUM DUTY

A, B, PB	Van, Wagon	B-Series/A-Series
CB, MB	Compact Front Section	B-Series/A-Series
D	Pickup - 2 W.D.	D-Series
M	Motor Home	M-Series
P	Forward Control	P-Series, Series 400, 450, 500, 600
W	Pickup - 4 W.D.	W-Series
C	Low Cab Forward	Series 500, 600, 700-1000
CB, MB	Compact Front Section	Series 400, 450
D	Conventional - 2 W.D.	Series 400, 450, 500, 600, 700-1000
L	Tilt Cab	Series 500, 600, 700-1000
M	Motor Home	Series 400, 450, 500, 600
S	School Bus	School Bus Catalog (Available summer, 2002)
W	Conventional - 4 W.D.	Series 400, 450, 500, 600

**FORD LIGHT DUTY** (See Automotive Exhaust Catalog)

## TRUCK MODEL IDENTIFICATION INDEX

### FORD MEDIUM DUTY

SERIES	TYPE	CATALOGED UNDER
B	School Bus	School Bus Catalog
C	Tilt Cab	Series 500, 550, 600, 700, 750, 800, 850, 900, 950, 1000, 1100
CT	Tilt Cab Tandem	Series 700, 750, 800, 850, 900, 950
F, N	Conventional	Series 500, 550, 600, 700, 750, 800, 850, 900, 950, 1000, 1100
L	Hi-Tilt Cab	Series 800, 850, 900, 950
LN	Short Tilt Cab	Series 500, 550, 600, 700, 750, 800, 850, 900, 950
P	Forward Control, Parcel Delivery	Series 500, 550, 600

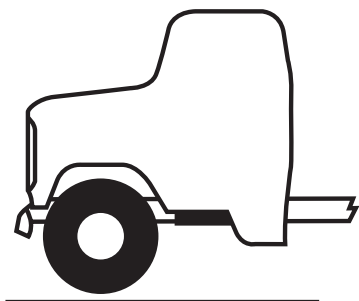

**Model 81 Cab**

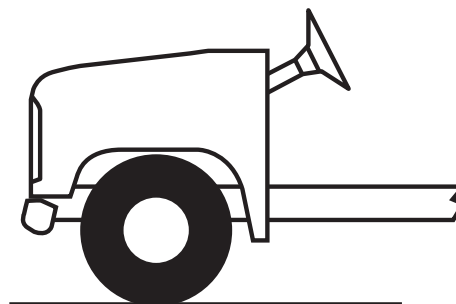

**Model 84 Cowl**

**FORD SERIES "B"** (See School Bus Catalog.)

### FREIGHTLINER MEDIUM DUTY

SERIES	TYPE	CATALOGED UNDER
FL Series	Commercial Truck	FL50-60-70

### FREIGHTLINER HEAVY DUTY

SERIES	TYPE	CATALOGED UNDER
FLC120, FLD120	Commercial Truck	FLC, FLD

### IH/INTERNATIONAL MEDIUM DUTY

SERIES	TYPE	CATALOGED UNDER
400, 500, 1000, 1100, 1200, 1300	Pickup, Travelall	Pickup, Terra, Traveler, Travelall
Fleetstar, Loadstar, S, 2600, 4000	Conventional, School Bus	Fleetstar, Cargostar, Loadstar, Series S, School Bus, 4000
Cargostar	Tilt Cab	Fleetstar, Cargostar, Loadstar, Series S
Metro	Step Van	Metro Series

## TRUCK MODEL IDENTIFICATION INDEX

### IH/INTERNATIONAL HEAVY DUTY

SERIES	TYPE	CATALOGED UNDER
7100, 8000, 8100, 8200, 9300, 9600, 9700	Commercial Truck	7100, 8000, 8100, 8200, 9300, 9600, 9700

### ISUZU MEDIUM DUTY

SERIES	TYPE	CATALOGED UNDER
NPR	Conventional	Isuzu

### KENWORTH HEAVY DUTY

SERIES	TYPE	CATALOGED UNDER
C500B, K100E, T4B, T6, T8, T400A, T450, T450B, T600, T800, W9B, W9L, W900, W900L	Commercial Truck	C500B, K100E, T4B, T6, T8, T400A, T450, T450B, T600, T800, W9B, W9L, W900, W900L

### MERCEDES BENZ

SERIES	TYPE	CATALOGED UNDER
1013, 1113, 1116, 1316, 1418	Medium Duty Truck	Mercedes Benz



## INSTALLATION GUIDE

### INSTALLING WYE CONNECTOR

Wye connectors provide an easy and economical way to join the left and right hand exhaust pipes of V-6 and V-8 diesel engines to form a single exhaust. A wye connector system will have an exhaust noise level 3 to 7 dB lower than a conventional Y-pipe system. Wye connectors are pictured and described in the accessory section of the catalog.

Wye connectors are installed as original equipment on some trucks, and they can be custom installed on many V-6 and V-8 trucks with conventional Y-pipes, as shown below:

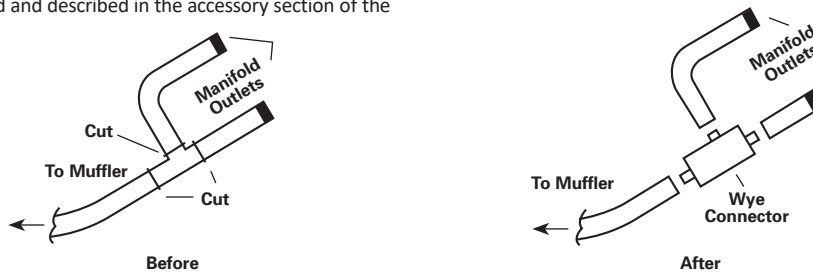

### INSTALLING UNIVERSAL RESONATOR

The universal resonators are shown in the accessory section of the catalog. When properly installed in the center of the exhaust pipe, resonators can generally reduce the exhaust noise level 2 to 3 dB.

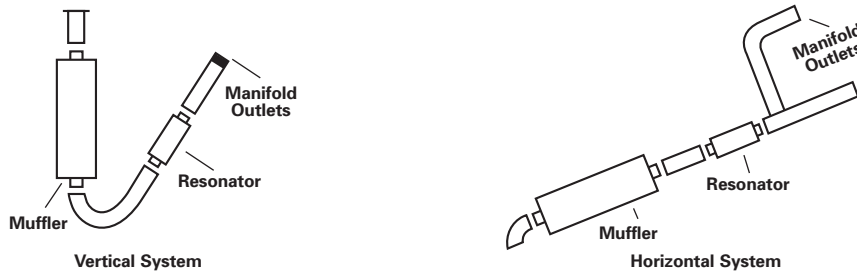

## TYPICAL INSTALLATIONS ON DIESEL ENGINES

### GENERAL POINTS

- 1) Length and diameter of straight tubing and flex tubing are dependent upon: cab size, wheel base, configuration and muffler placement.
- 2) Exhaust system parts are stated by name rather than by part number, because selection of the correct part depends upon variations in system configuration.

### CATERPILLAR 1673T

TURBOCHARGED  
SPLIT TO DUALS

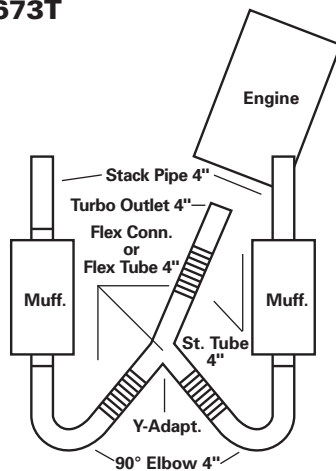

67 dB Exhaust Noise  
1.1 Hg. Backpressure

### CUMMINS NH-250

SINGLE VERTICAL MOUNT

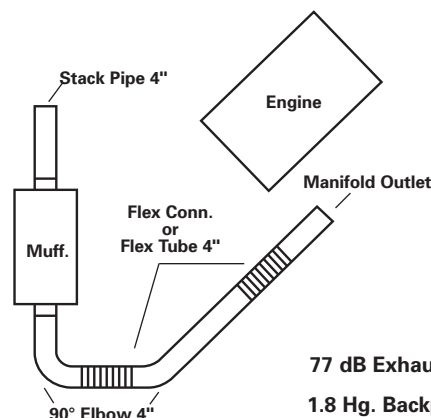

77 dB Exhaust Noise  
1.8 Hg. Backpressure

## INSTALLATION GUIDE

### DETROIT DIESEL 6V-53N

WYE CONNECTOR WITH HORIZONTAL  
MUFFLER-VERTICAL STACK

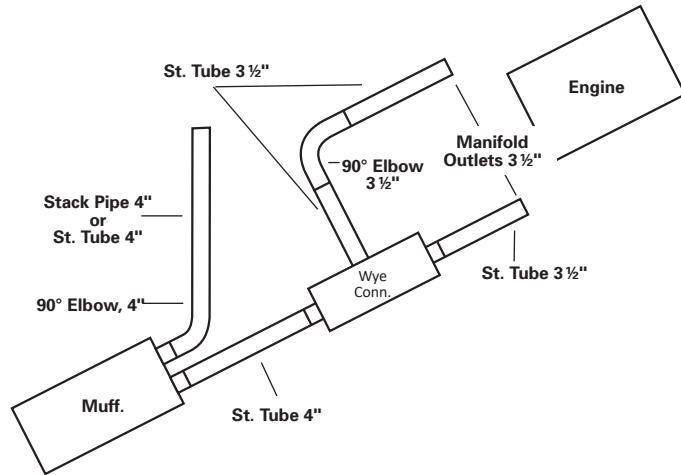

81 dB Exhaust Noise  
2.8 Hg. Backpressure

### DETROIT DIESEL 8V-71N

DUALS VERTICAL MOUNT

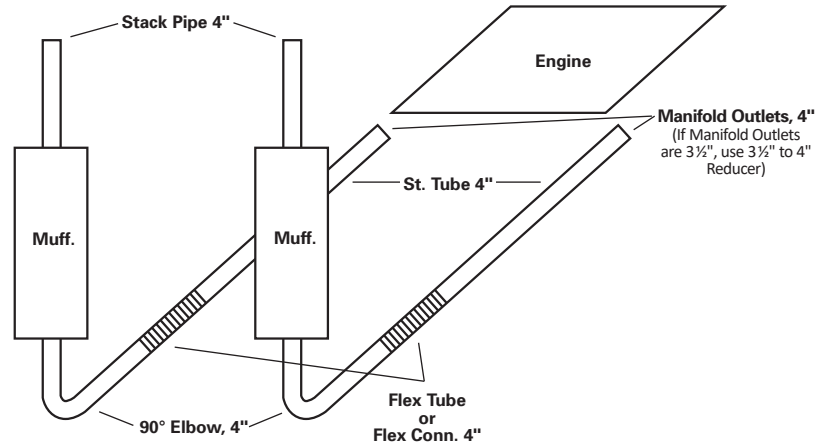

78 dB Exhaust Noise  
3.8 Hg. Backpressure

### MACK END - 672 OR 673

SINGLE HORIZONTAL MOUNT

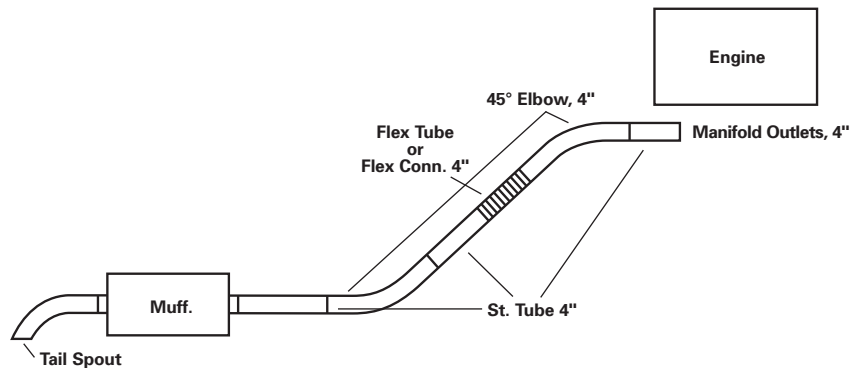

79 dB Exhaust Noise  
1.3 Hg. Backpressure