

AP

EXHAUST TECHNOLOGIES®

**EPA OBD II & PRE-OBD II
CATALYTIC CONVERTERS
DIRECT FIT & UNIVERSAL**



**CATALYTIC
CONVERTER
CATALOG**

Direct Fit | Universal | OBDII



EPA ONLY - Not for sale or installation in California

GENERAL INFORMATION

UNIVERSAL SPECIFICATIONS

SPECIFICATIONS FOR UNIVERSAL CONVERTERS

All Converter Series comply with EPA policies. Application exceptions are noted in this catalog.

THE 602*** Series CAN BE USED:

As a **TWO-WAY (OC)**, Universal and Direct Fit: With an Eng. displacement of 5.9L or less, and vehicle test weight of 6000 lbs or less.

As a **THREE-WAY (TWC)**, Universal and Direct Fit: With an Eng. displacement of 5.9L or less, and vehicle test weight of 6000 lbs or less.

As a **THREE-WAY + OXIDATION (TWC + OC)**, Universal and Direct Fit: With an Eng. displacement of 5.9L or less, and vehicle test weight of 6000 lbs or less.

602* Series** can be used as a 2 to 1 replacement on Three-Way w/Air applications: With an Eng. displacement of 5.8L or less, and vehicle test weight of 5000 lbs or less.

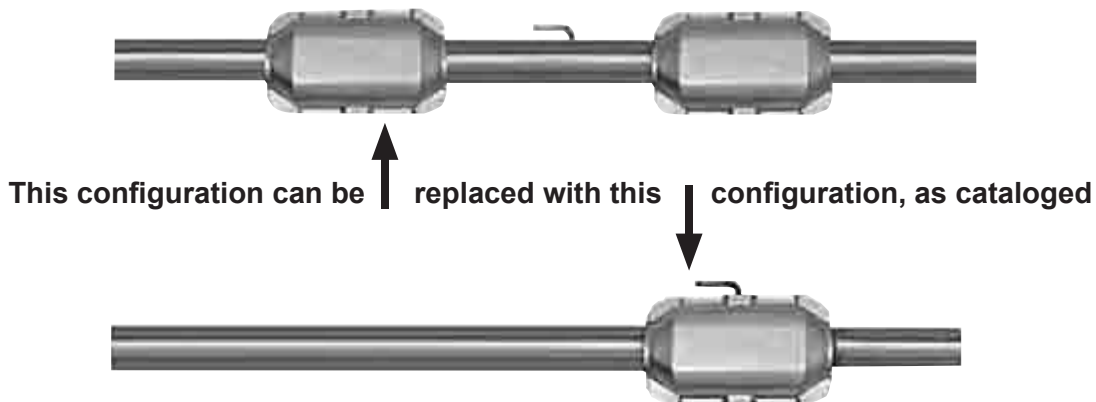

602* Series** can also be used to replace up to 2 Pre-Cats when used in Three-Way w/Air applications as the under body converter, with an Eng. displacement of 5.2L or less, and vehicle test weight of 4000 lbs or less.

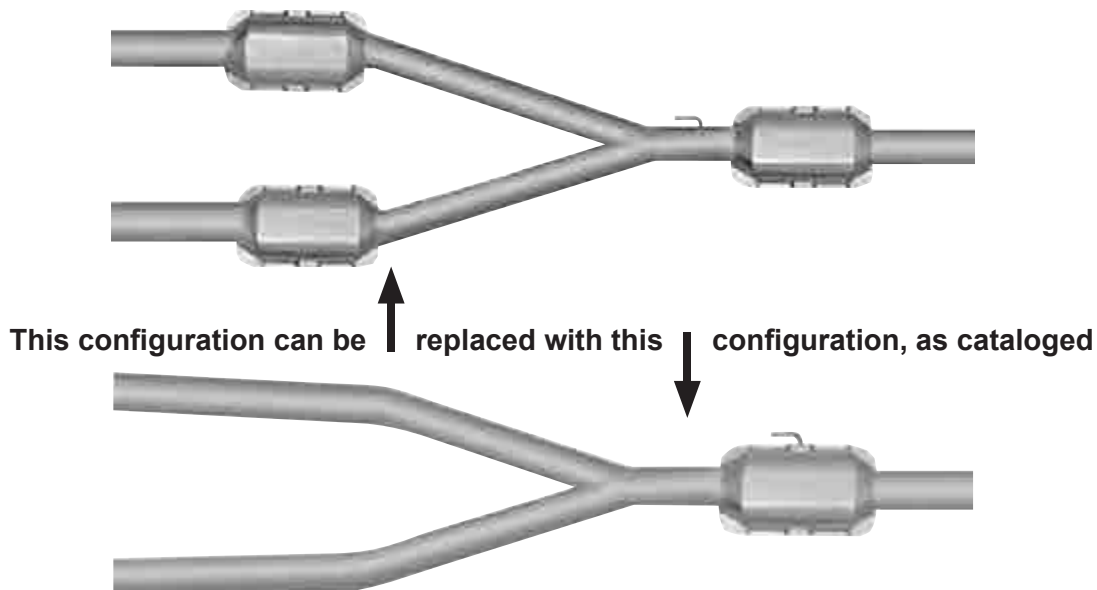

GENERAL INFORMATION

UNIVERSAL CONVERTER SPECIFICATIONS

6020**/6022** Series

STANDARD DUTY

STANDARD DUTY	EPA Eng./Test Weight
2-WAY	5.9L, 5500 lbs
3-WAY	5.9L, 5500 lbs
3-WAY, w/Air	5.9L, 5500 lbs

Oval - w/Air Tube

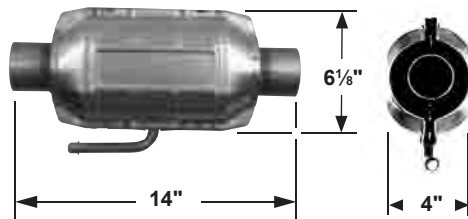

	INLET/I.D.	OUTLET/I.D.
602003	1-3/4"	1-3/4" w/air tube
602004	2"	2" w/air tube
602005	2-1/4"	2-1/4" w/air tube
602006	2-1/2"	2-1/2" w/air tube
602007	3"	3" w/air tube

Oval - w/o Air Tube

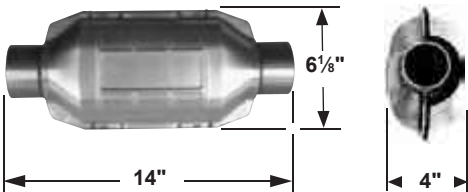

	INLET/I.D.	OUTLET/I.D.
602203	1-3/4"	1-3/4" w/o air tube
602204	2"	2" w/o air tube
602205	2-1/4"	2-1/4" w/o air tube
602206	2-1/2"	2-1/2" w/o air tube
602207	3"	3" w/o air tube

602*** SPECIALTY

STANDARD DUTY

STANDARD DUTY	EPA Eng./Test Weight
2-WAY	5.9L, 5500 lbs
3-WAY	5.9L, 5500 lbs
3-WAY, w/Air	5.9L, 5500 lbs

Round - w/o Air Tube

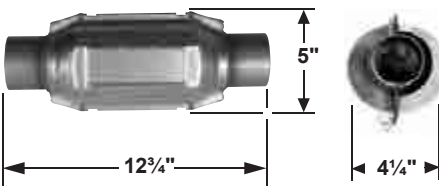

	INLET/I.D.	OUTLET/I.D.
602213	1-3/4"	1-3/4" w/o air tube
602214	2"	2" w/o air tube
602215	2-1/4"	2-1/4" w/o air tube, 13" OAL
602216	2-1/2"	2-1/2" w/o air tube, 13" OAL

Round - w/O2 port

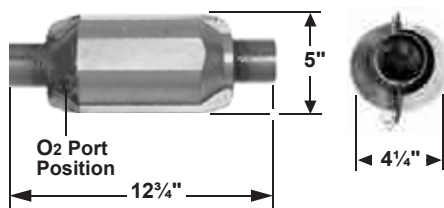

	INLET/I.D.	OUTLET/I.D.
602235	2" w/Dr. side O2 Sensor port	2"

Oval - w/O2 port

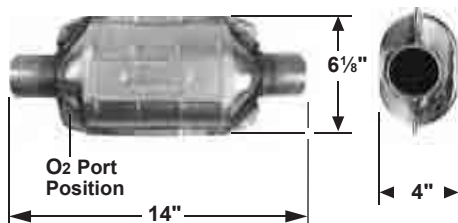

	INLET/I.D.	OUTLET/I.D.
602244	2" Dr. side O2 Sensor port	2"

EPA ONLY - Not for sale or installation in California

GENERAL INFORMATION

UNIVERSAL CONVERTER SPECIFICATIONS



602*** SPECIALTY - (cont.)

STANDARD DUTY

STANDARD DUTY	EPA Eng./Test Weight
2-WAY	5.9L, 5500 lbs
3-WAY	5.9L, 5500 lbs
3-WAY, w/Air	5.9L, 5500 lbs

Oval - w/o Air Tube

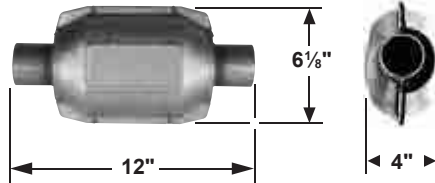

	INLET/I.D.	OUTLET/I.D.
602294	2"	2"
602295	2-1/4"	2-1/4"
602296	2-1/2"	2-1/2"

Spun Body one-piece design

Round - w/o Air Tube

Pre-OBDDII, EPA, 5.9L to 6000 lbs

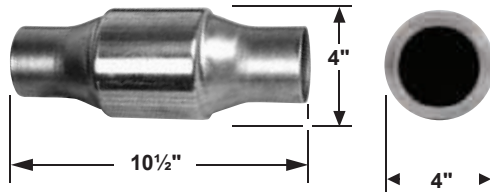

	INLET/I.D.	OUTLET/I.D.
602384	2"	2"
602385	2-1/4"	2-1/4"
602386	2-1/2"	2-1/2"
602387	3"	3"

6025** Series

ENHANCED STANDARD DUTY

ENHANCED STANDARD DUTY	EPA Eng./Test Weight
2-WAY	5.9L, 6515 lbs
3-WAY	5.9L, 6515 lbs
3-WAY, w/Air	5.9L, 6515 lbs

Oval - w/Air Tube

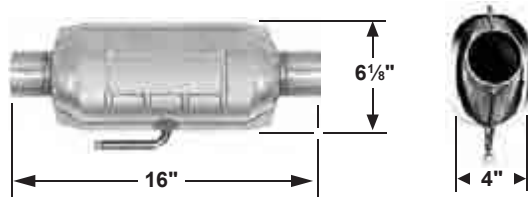

	INLET/I.D.	OUTLET/I.D.
602534	2"	2" w/air tube
602535	2-1/4"	2-1/4" w/air tube
602536	2-1/2"	2-1/2" w/air tube
602537	3"	3" w/air tube

Can be used as alternate converters to 602000, 602200 and 602500 Series converters.

Oval - w/o Air Tube

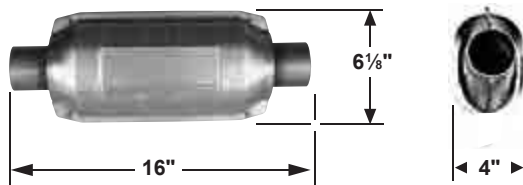

	INLET/I.D.	OUTLET/I.D.
602543	1-3/4"	1-3/4" w/o air tube
602544	2"	2" w/o air tube
602545	2-1/4"	2-1/4" w/o air tube
602546	2-1/2"	2-1/2" w/o air tube
602547	3"	3" w/o air tube

Can be used as alternate converters to 602000, 602200 and 602500 Series converters.

Oval - w/o Air Tube

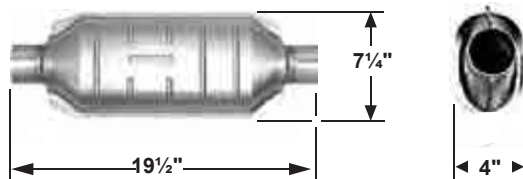

	INLET/I.D.	OUTLET/I.D.
602585	2-1/4"	2-1/4" w/o air tube

Can be used as alternate converters to 602000, 602200, 602500, 602530, 602540 and 602570 Series converters.

EPA ONLY - Not for sale or installation in California

GENERAL INFORMATION

UNIVERSAL CONVERTER SPECIFICATIONS

603*** Series

MEDIUM DUTY

MEDIUM DUTY	EPA Eng./Test Weight
2-WAY	5.9L, 5500 lbs
3-WAY	5.9L, 5500 lbs
3-WAY, w/Air	5.9L, 5500 lbs

Oval - w/Air Tube

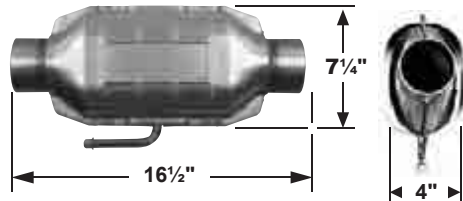

INLET/I.D.

OUTLET/I.D.

603006	2-1/2"	2-1/2" w/air tube
603007	3"	3" w/air tube

Oval - w/Air Tube

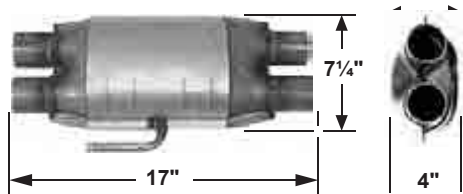

INLET/I.D.

OUTLET/I.D.

603031	2" Dual Inlets	2" Dual Outlets, w/air tube
---------------	----------------	-----------------------------

Oval - w/Air Tube

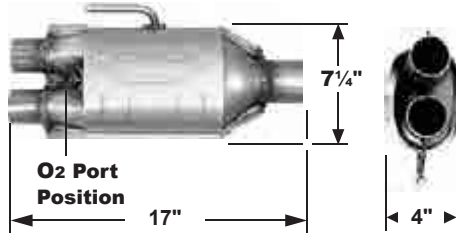

INLET/I.D.

OUTLET/I.D.

603040	2" Dual Inlets w/O2 Sensor port	2-1/2" w/air tube
---------------	------------------------------------	-------------------

Oval - w/o Air Tube

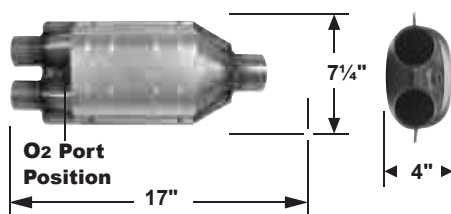

INLET/I.D.

OUTLET/I.D.

603240	2" Dual, w/O2 Sensor port	2-1/2"
---------------	---------------------------	--------

6040** Series

HEAVY DUTY

HEAVY DUTY	EPA Eng./Test Weight
2-WAY	7.7L, 7000 lbs
3-WAY	7.5L, 7000 lbs

Oval - w/o Air Tube

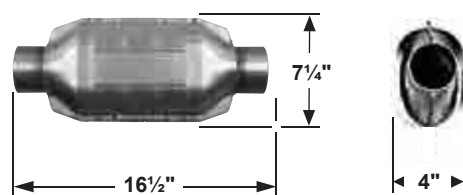

INLET/I.D.

OUTLET/I.D.

604005	2-1/4"	2-1/4"
604006	2-1/2"	2-1/2"
604007	3"	3"

GENERAL INFORMATION

UNIVERSAL CONVERTER SPECIFICATIONS



6040** Series - (cont.)

HEAVY DUTY

HEAVY DUTY	EPA Eng./Test Weight
2-WAY	7.7L, 7000 lbs
3-WAY	7.5L, 7000 lbs

Oval - w/o Air Tube

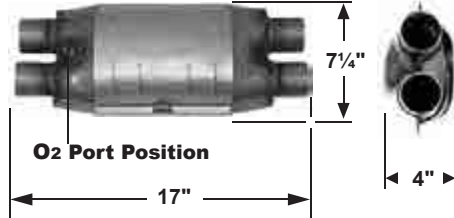

INLET/I.D.

OUTLET/I.D.

604051 2" Dual Inlets,
O2 Sensor port

2" Dual Outlets

6050** Series

HEAVY DUTY

HEAVY DUTY	EPA Eng./Test Weight
2-WAY	7.7L, 7000 lbs
3-WAY	7.5L, 7000 lbs
3-WAY, w/Air	7.5L, 7000 lbs

Oval - w/Air Tube

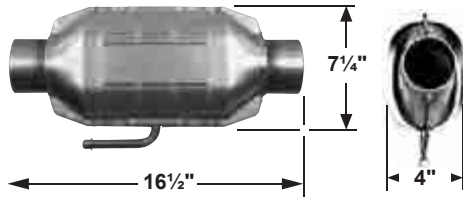

INLET/I.D.

OUTLET/I.D.

605004 2"

2"

605005 2-1/4"

2-1/4"

605006 2-1/2"

2-1/2"

605007 3"

3"

Oval - w/Air Tube

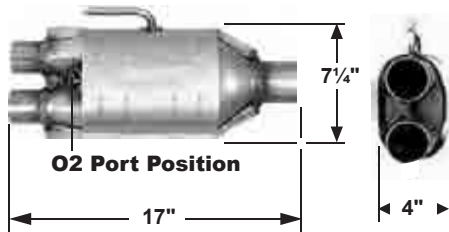

INLET/I.D.

OUTLET/I.D.

605040 2" Dual, w/O2 Sensor
port

2-1/2"

Can be used in 604008, 604009 and 604040 applications where Air Tube is required.

GENERAL INFORMATION

UNIVERSAL CONVERTER SPECIFICATIONS

6060** Series

SUPER DUTY

Oval - w/o Air Tube

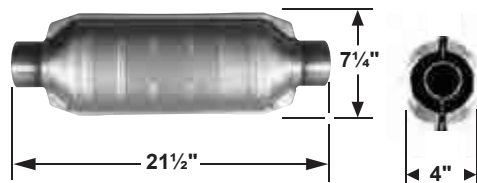

SUPER DUTY	EPA Eng./GVWR
2-WAY	7.5L, 15000 lbs or less
3-WAY	7.5L, 15000 lbs or less

	INLET/I.D.	OUTLET/I.D.
606005	2-1/4"	2-1/4" w/o air tube
606006	2-1/2"	2-1/2" w/o air tube
606007	3"	3" w/o air tube

6070** Series

SUPER DUTY

Oval - w/Air Tube

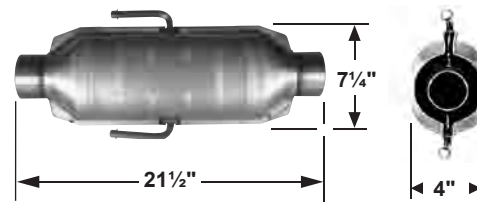

SUPER DUTY	EPA Eng./GVWR
2-WAY	7.5L, 15000 lbs or less
3-WAY	7.5L, 15000 lbs or less
3-WAY, w/Air	7.5L, 15000 lbs or less

	INLET/I.D.	OUTLET/I.D.
607005	2-1/4"	2-1/4" w/Dual air tubes
607006	2-1/2"	2-1/2" w/Dual air tubes
607007	3"	3" w/Dual air tubes

608*** Series OBDII Vehicles up to LEV

EPA OBDII BY DESIGN

Made to keep the "Light Off" (MIL check engine light).

Oval - w/o Air Tube

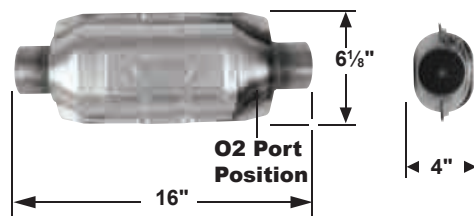

EPA OBD II	EPA Eng./Test Weight
3-WAY	5.9L, 6250 lbs
3-WAY w/Air	5.9L, 6250 lbs

Units have O2 Sensor port in Outlet, unless otherwise noted

	INLET/I.D.	OUTLET/I.D.
608204	2"	2" w/O2 Sensor port
608205	2-1/4"	2-1/4" w/O2 Sensor port
608206	2-1/2"	2-1/2" w/O2 Sensor port

Round - w/o Air Tube

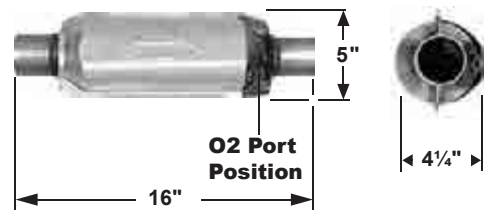

Units have O2 Sensor port in Outlet, unless otherwise noted

	INLET/I.D.	OUTLET/I.D.
608214	2"	2" w/O2 Sensor port
608215	2-1/4"	2-1/4" w/O2 Sensor port
608216	2-1/2"	2-1/2" w/O2 Sensor port
608217	3"	3" w/O2 Sensor port

GENERAL INFORMATION

UNIVERSAL CONVERTER SPECIFICATIONS



608*** Series - (cont.) OBDII Vehicles up to LEV

EPA OBDII BY DESIGN

Made to keep the "Light Off" (MIL check engine light).

EPA OBD II	EPA Eng./Test Weight
3-WAY	5.9L, 6250 lbs
3-WAY w/Air	5.9L, 6250 lbs

Oval - w/o Air Tube

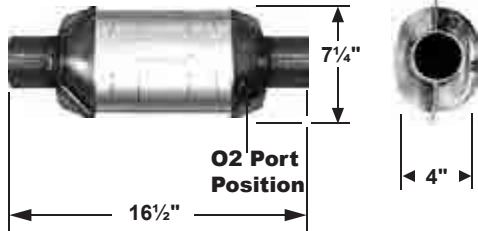

	INLET/I.D.	OUTLET/I.D.
608224	2"	2" w/O2 Sensor port
608225	2-1/4"	2-1/4" w/O2 Sensor port
608226	2-1/2"	2-1/2" w/O2 Sensor port
608227	3"	3" w/O2 Sensor port

Oval - w/o Air Tube

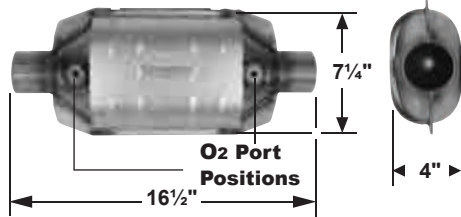

	INLET/I.D.	OUTLET/I.D.
608234	2"	2" w/Two O2 Sensor ports
608235	2-1/4"	2-1/4" w/Two O2 Sensor ports

Oval - w/Air Tube

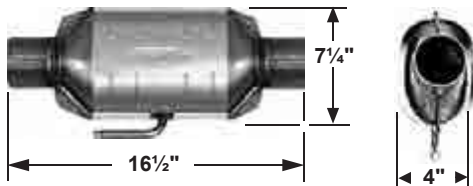

	INLET/I.D.	OUTLET/I.D.
608006	2-1/2"	2-1/2" w/air tube

Oval - w/o Air Tube

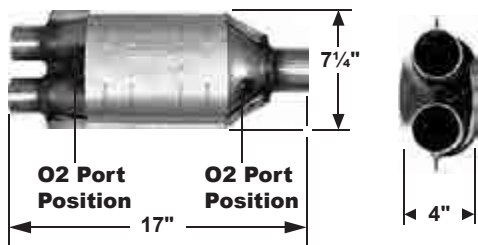

	INLET/I.D.	OUTLET/I.D.
608240	2" Dual	2-1/2" w/Two O2 Sensor ports

GENERAL INFORMATION

UNIVERSAL CONVERTER SPECIFICATIONS

608*** Series - (cont.) OBDII Vehicles up to LEV

EPA OBDII BY DESIGN

Made to keep the "Light Off" (MIL check engine light).

EPA OBD II	EPA Eng./Test Weight
3-WAY	5.9L, 6250 lbs
3-WAY w/Air	5.9L, 6250 lbs

Round - w/o Air Tube

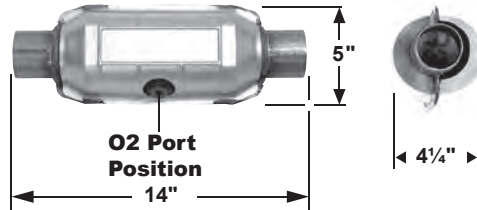

	INLET/I.D.	OUTLET/I.D.
608254	2"	2" w/O2 sensor port at middle of shell
608255	2-1/4"	2-1/4" w/O2 sensor port at middle of shell
608256	2-1/2"	2-1/2" w/O2 sensor port at middle of shell

Oval - w/o Air Tube

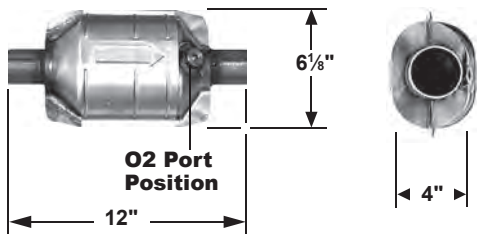

	INLET/I.D.	OUTLET/I.D.
608294	2"	2" w/O2 Sensor port
608295	2-1/4"	2-1/4" w/O2 Sensor port

608*** Series OBDII Vehicles up to LEV

EPA OBDII BY DESIGN

Made to keep the "Light Off" (MIL check engine light).

EPA OBD II	EPA Eng./Test Weight
2-WAY	5.9L, 5500 lbs
3-WAY	5.9L, 5500 lbs

Round - No Necks, w/o Air Tube

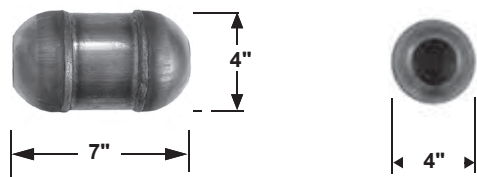

	INLET/I.D.	OUTLET/I.D.
608364	2"	2"
608365	2-1/4"	2-1/4"
608366	2-1/2"	2-1/2"

Round - No Necks, w/o Air Tube

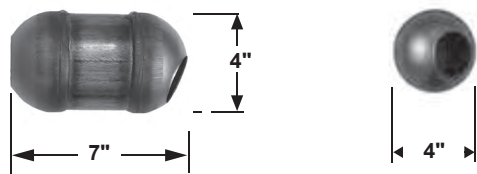

	INLET/I.D.	OUTLET/I.D.
608374	2" Angled	2"
608375	2-1/4" Angled	2-1/4"
608376	2-1/2" Angled	2-1/2"

GENERAL INFORMATION



UNIVERSAL CONVERTER SPECIFICATIONS

608*** Series - (cont.) OBDII Vehicles up to LEV

EPA OBDII BY DESIGN

Made to keep the "Light Off" (MIL check engine light).

EPA OBD II	EPA Eng./Test Weight
3-WAY	5.9L, 6000 lbs
3-WAY w/Air	5.9L, 6000 lbs

Spun Body one-piece design
Round - w/o Air Tube

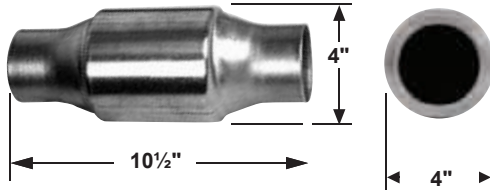

	INLET/I.D.	OUTLET/I.D.
608384	2"	2"
608385	2-1/4"	2-1/4"
608395	2-1/4"	2-1/4" w/O ₂ Sensor Fitting
608386	2-1/2"	2-1/2"
608396	2-1/2"	2-1/2" w/O ₂ Sensor Fitting
608387	3"	3"
608397	3"	3" w/O ₂ Sensor Fitting

608*** Series LEVII and Cleaner Applications

EPA OBDII BY DESIGN

These parts utilize a higher precious metal loading for LEV II and cleaner emission standards.

EPA OBD II	EPA Eng./Test Weight
3-WAY	5.9L, 6250 lbs
3-WAY w/Air	5.9L, 6250 lbs

Round - w/o Air Tube

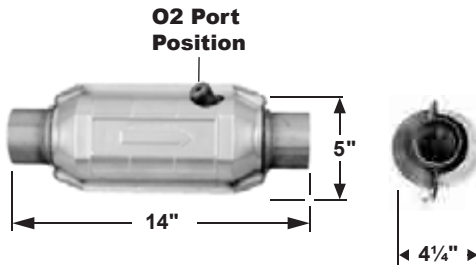

	INLET/I.D.	OUTLET/I.D.
608264	2"	2" w/O ₂ Sensor port
608265	2-1/4"	2-1/4" w/O ₂ Sensor port
608266	2-1/2"	2-1/2" w/O ₂ Sensor port

Special Body - Angled Inlet and Outlet, w/o Air Tube

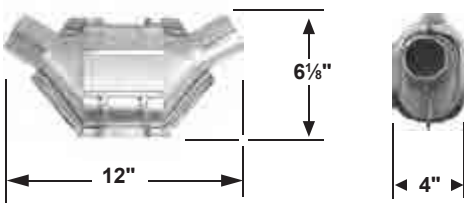

	INLET/I.D.	OUTLET/I.D.
608274	2"	2"
608275	2-1/4"	2-1/4"
608276	2-1/2"	2-1/2"

Special Body - Angled Inlet, w/o Air Tube

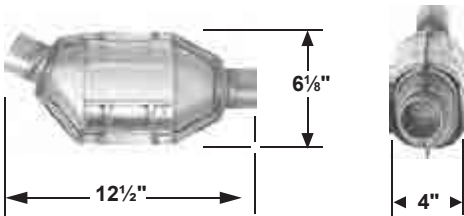

	INLET/I.D.	OUTLET/I.D.
608284	2"	2"
608285	2-1/4"	2-1/4"
608286	2-1/2"	2-1/2"

GENERAL INFORMATION

UNIVERSAL CONVERTER SPECIFICATIONS

608*** Series - (cont.) LEVII and Cleaner Applications

EPA OBD II	EPA Eng./Test Weight
3-WAY	5.9L, 6250 lbs
3-WAY w/Air	5.9L, 6250 lbs

EPA OBDII BY DESIGN

These parts utilize a higher precious metal loading for LEVII and cleaner emission standards.

Round - w/o Air Tube

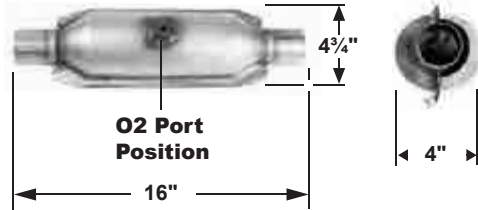

	INLET/I.D.	OUTLET/I.D.
608314	2"	2" w/O2 sensor port at middle of shell
608315	2-1/4"	2-1/4" w/O2 sensor port at middle of shell

Round - w/o Air Tube

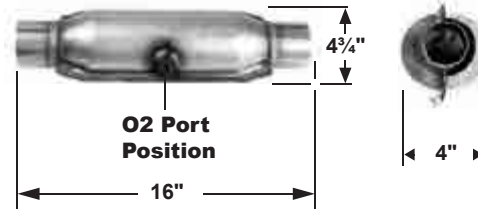

	INLET/I.D.	OUTLET/I.D.
608316	2-1/2"	2-1/2" w/O2 sensor port at middle of shell

Round - w/o Air Tube

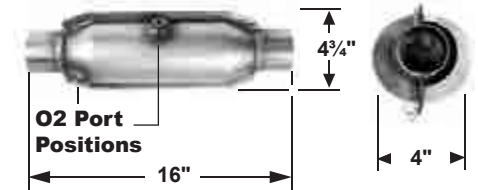

	INLET/I.D.	OUTLET/I.D.
608326	2-1/2"	2-1/2" w/Two O2 sensor ports, one at middle of shell & one at left top inlet

Oval - w/o Air Tube

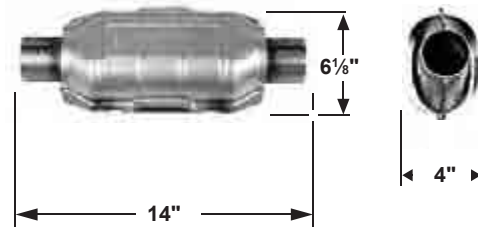

	INLET/I.D.	OUTLET/I.D.
608404	2"	2"
608405	2-1/4"	2-1/4"
608406	2-1/2"	2-1/2"
608407	3"	3"

Round - w/o Air Tube

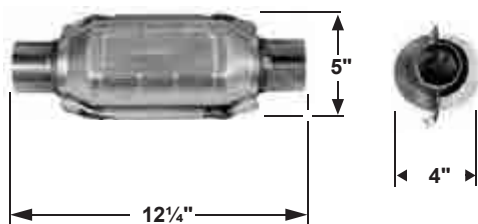

	INLET/I.D.	OUTLET/I.D.
608414	2"	2"
608415	2-1/4"	2-1/4"
608416	2-1/2"	2-1/2"
608417	3"	3"

GENERAL INFORMATION

UNIVERSAL CONVERTER SPECIFICATIONS



608*** Series - (cont.) LEVII and Cleaner Applications

EPA OBDII BY DESIGN

These parts utilize a higher precious metal loading for LEVII and cleaner emission standards.

EPA OBD II	EPA Eng./Test Weight
3-WAY	5.9L, 6250 lbs
3-WAY w/Air	5.9L, 6250 lbs

Oval - w/o Air Tube

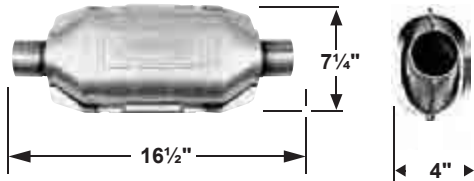

	INLET/I.D.	OUTLET/I.D.
608434	2"	2"
608435	2-1/4"	2-1/4"
608436	2-1/2"	2-1/2"
608437	3"	3"

6090** Series

LARGE BODY SUPER X DUTY

SPECIAL	EPA Eng./Test Weight
2-WAY	5.9L, 6515 lbs
3-WAY	5.9L, 6515 lbs
3-WAY, w/Air	5.9L, 6515 lbs

Oval - w/Air Tube

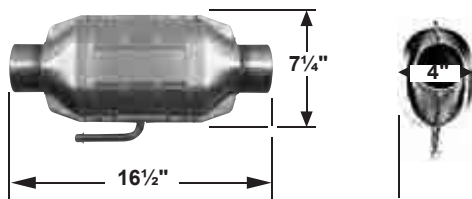

	INLET/I.D.	OUTLET/I.D.
609004	2"	2" w/air tube
609005	2-1/4"	2-1/4" w/air tube
609006	2-1/2"	2-1/2" w/air tube

Oval - w/o Air Tube

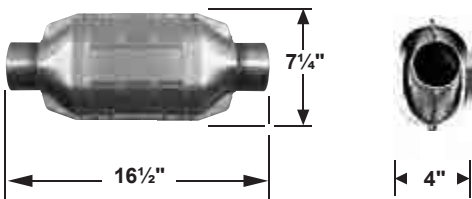

	INLET/I.D.	OUTLET/I.D.
609007	3"	3" w/o air tube

Oval

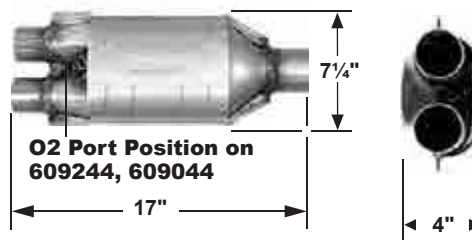

	INLET/I.D.	OUTLET/I.D.
609240	2" Dual	2-1/2" w/o air tube
609244	2" Dual, w/O2 Sensor port	2-1/2" w/o air tube
609044	2" Dual, w/O2 Sensor port	2-1/2" w/air tube

Oval - w/o Air Tube

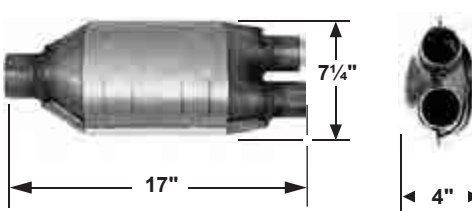

	INLET/I.D.	OUTLET/I.D.
609220	2-1/2"	2" Dual Outlets

EPA ONLY - Not for sale or installation in California



GENERAL INFORMATION

UNIVERSAL CONVERTER SPECIFICATIONS

6090** Series LARGE BODY SUPER X DUTY

SPECIAL	EPA Eng./Test Weight
2-WAY	5.9L, 6515 lbs
3-WAY	5.9L, 6515 lbs
3-WAY, w/Air	5.9L, 6515 lbs

Oval - w/o Air Tube

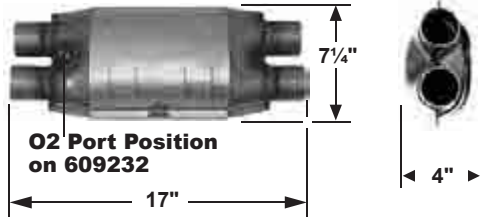

	INLET/I.D.	OUTLET/I.D.
609231	2" Dual	2" Dual
609232	2" Dual, w/O ₂ Sensor port	2" Dual

HIGH FLOW

HIGH FLOW	EPA Eng./Test Weight
2-WAY	5.7L, 6000 lbs
3-WAY	5.7L, 6000 lbs

Round - Small Body, OBDII EPA Only, w/o Air tube, 200 Cell Stainless Steel Substrate

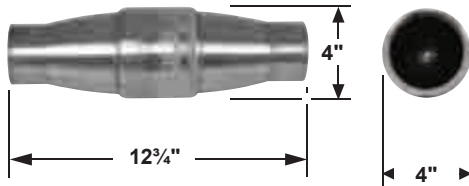

	INLET/I.D.	OUTLET/I.D.
X24	2"	2" w/o air tube
X25	2-1/4"	2-1/4" w/o air tube
X26	2-1/2"	2-1/2" w/o air tube

Round - Large Body, OBDII EPA Only, w/o Air tube, 200 Cell Stainless Steel Substrate

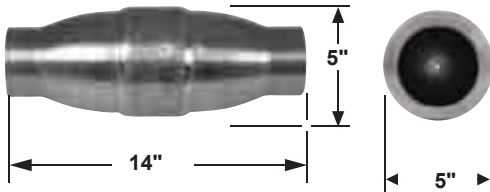

	INLET/I.D.	OUTLET/I.D.
X36	2-1/2"	2-1/2" w/o air tube
X37	3"	3" w/o air tube

APPLICATION LISTINGS

FEDERAL CONVERTERS



YR/YRS	CYL	LITER	DESCRIPTION	DIRECT FIT	UNIVERSAL
ACURA CL					
1997	4	2.2L		642738 ③	608264 ③
97-99	6	3.0L	Federal Emissions	642770 ④	608265 ④
97-99	6	3.0L	California Emissions	642731 ⑤	608205 ⑤
01-03	6	3.2L	Federal Emissions, Exc. Type S	642717 ④	608265 ④
01-03	6	3.2L	Type-S	--	608265 ③
ACURA EL					
01-03	4	1.7L	(Canada Model)	642281 ③	--
ACURA INTEGRA					
88-89	4	1.6L		642382 ③	602214 ③
86-87	4	1.6L	w/Air Tube	--	602004 ③
86-87	4	1.6L	w/o Air Tube	642378 ③	602214 ③
92-93	4	1.7L		642429 ③	602214 ③
00-01	4	1.8L	(Exc. VTEC Eng.)	--	608264 ③
00-01	4	1.8L	VTEC	--	608265 ③
00-01	4	1.8L	Type-R	--	608265 ③
96-99	4	1.8L	Manual Trans., (Exc. GSR Models)	--	608264 ③
96-99	4	1.8L	GSR Models	642705 ③	608204 ③
96-99	4	1.8L	Auto Trans., (Exc. GSR Models)	642757 ③	608264 ③
94-95	4	1.8L	3 Dr., (Exc. DOHC-VTEC Eng.)	642429 ③	602214 ③
92-93	4	1.8L		642429 ③	602214 ③
90-91	4	1.8L		642430 ③	602214 ③
ACURA LEGEND					
86-87	6	2.5L		--	602214 ③
87-90	6	2.7L		--	602214 ③
94-95	6	3.2L	GS Sedan, Front Left	--	X24 ③
94-95	6	3.2L	GS Sedan, Main Conv.	642573 ③	602216 ③
94-95	6	3.2L	GS Sedan, Front Right	--	X24 ③
93-95	6	3.2L	Coupe L or LS Models, Front Left	--	X24 ③
93-95	6	3.2L	Coupe L or LS Models, Main Conv.	642573 ③	602216 ③
93-95	6	3.2L	Coupe L or LS Models, Front Right	--	X24 ③
91-92	6	3.2L		642573 ③	602216 ③
ACURA MDX					
03-06	6	3.5L	Front Left	641355 ③	--
03-06	6	3.5L	Front Left	641257 ③④	--
			Front Right	641356 ③	--
			Front Right	641258 ③④	--
03-06	6	3.5L	Rear Main	642185 ③	608415 ③④
01-02	6	3.5L		642262 ③	608265 ③
07-09	6	3.7L	Front Left	641355 ③	--
			Front Left	641257 ③④	--
07-09	6	3.7L	Front Right	641356 ③	--
			Front Right	641258 ③④	--
ACURA NSX					
04-05	6	3.0L	Right Side	--	608326 ③
95-03	6	3.0L	Right	--	608265 ③
95-03	6	3.0L	Left	--	608265 ③
91-94	6	3.0L	Right	--	602215 ③

- ④ Discontinued, use until inventory is depleted.
- ③ Federal & California Emissions. Not For Sale or Use on vehicles licensed in the state of CA & NY (NY vehicles with CA Emissions). Check with your state authority for details.
- ④ Federal Emissions. Not For Sale or Use on vehicles licensed in the state of CA. Check with your state authority.
- ⑤ California Emissions. Not For Sale or Use on vehicles licensed in the state of CA & NY. Check with your state authority.
- EPA Enhanced OBDII By Design Unit



APPLICATION LISTINGS FEDERAL CONVERTERS

YR/YRS	CYL	LITER	DESCRIPTION	DIRECT FIT	UNIVERSAL
ACURA NSX (Cont.)					
91-94	6	3.0L	Left	--	602215 ^③
04-05	6	3.2L	Right Side	--	608326 ^③
97-03	6	3.2L	Right	--	608265 ^③
97-03	6	3.2L	Left	--	608265 ^③
ACURA RDX					
07-12	4	2.3L	Rear	642824 ^③	--
13-14	6	3.5L	Front Left	641334 ^③	--
13-14	6	3.5L	Front Right	641413 ^③	--
13-14	6	3.5L	Rear	642035 ^③	608295 ^③
ACURA RL					
05-08	6	3.5L	Main Conv.	--	608326 ^③
96-04	6	3.5L		642676 ^③	--
2009	6	3.7L	Rear	642035 ^③	608295 ^③
2009	6	3.7L	Front Left	641334 ^③	--
2009	6	3.7L	Front Right	641413 ^③	--
ACURA RSX					
05-06	4	2.0L		--	608265 ^③
02-04	4	2.0L	Type-S	642026 ^③	608265 ^③
02-04	4	2.0L	(Exc. Type S)	642193 ^③	608264 ^③
ACURA SLX					
98-99	6	3.5L	Left	643079 ^③	608264 ^③
ACURA TL					
97-98	5	2.5L	Sedan, Front	--	608275 ^③
95-98	5	2.5L	Rear Main Conv.	642188 ^③	608264 ^③
04-08	6	3.2L	Front Left	641355 ^③	--
			Front Left	641257 ^{③①}	--
04-08	6	3.2L	Front Right	641356 ^③	--
			Front Right	641258 ^{③①}	--
04-08	6	3.2L	Rear Main	642185 ^③	608415 ^{③①}
00-03	6	3.2L	Federal Emissions, Exc. Type S	642717 ^④	608265 ^④
1999	6	3.2L	Federal Emissions	642770 ^④	608265 ^④
1999	6	3.2L	California Emissions	642731 ^⑤	608205 ^⑤
96-98	6	3.2L	w/o Resonator	642849 ^③	--
96-98	6	3.2L	w/Resonator	642676 ^③	--
09-14	6	3.5L	Front Right	641413 ^③	--
09-14	6	3.5L	Front Left	641334 ^③	--
09-14	6	3.5L	Rear	642035 ^③	608295 ^③
07-08	6	3.5L	Front Left	641355 ^③	--
			Front Left	641257 ^{③①}	--
07-08	6	3.5L	Front Right	641356 ^③	--
			Front Right	641258 ^{③①}	--
07-08	6	3.5L	Main Conv.	--	608326 ^③
09-14	6	3.7L	Rear	642035 ^③	608295 ^③
09-14	6	3.7L	Front Left	641334 ^③	--
09-14	6	3.7L	Front Right	641413 ^③	--

- ① Discontinued, use until inventory is depleted.
- ② Federal & California Emissions. Not For Sale or Use on vehicles licensed in the state of CA & NY (NY vehicles with CA Emissions). Check with your state authority for details.
- ③ Federal Emissions. Not For Sale or Use on vehicles licensed in the state of CA. Check with your state authority.
- ④ California Emissions. Not For Sale or Use on vehicles licensed in the state of CA & NY. Check with your state authority.
- ⑤ EPA Enhanced OBDII By Design Unit

APPLICATION LISTINGS

FEDERAL CONVERTERS



YR/YRS	CYL	LITER	DESCRIPTION	DIRECT FIT	UNIVERSAL
ACURA TSX					
09-12	4	2.4L	Front	641281 ③	--
09-12	4	2.4L	Rear Conv.	642118 ③	608416 ③
2009	4	2.4L	Main Conv.	--	608265 ③
04-08	4	2.4L		642039 ③	608265 ③
10-14	6	3.5L	Rear	642035 ③	608295 ③
10-14	6	3.5L	Front Left	641334 ③	--
10-14	6	3.5L	Front Right	641413 ③	--
ACURA VIGOR					
92-94	5	2.5L	Auto Trans.	--	602214 ③
92-94	5	2.5L	Manual Trans.	--	602214 ③
ACURA ZDX					
10-13	6	3.7L	Rear	642035 ③	608295 ③
10-13	6	3.7L	Front Right	641413 ③	--
10-13	6	3.7L	Front Left	641334 ③	--
ALFA ROMEO 164					
91-95	6	3.0L		--	609004 ③
ALFA ROMEO ALFETTA					
75-77	4	2.0L		--	602204 ③
ALFA ROMEO MILANO					
87-89	6	2.5L		--	609004 ③
88-89	6	3.0L		--	609004 ③
ALFA ROMEO SPIDER					
92-94	4	2.0L		--	602204 ③
75-81	4	2.0L		--	602203 ③
AMERICAN MOTORS AMX					
78-79	6,8	All		--	602004 ③
AMERICAN MOTORS CONCORD					
78-79	4	2.0L		--	602004 ③
80-82	4	All		--	602004 ③
80-83	6	4.2L	w/Air Tube	--	602004 ③
80-83	6	4.2L	w/o Air Tube	--	602204 ③
78-79	6,8	All		--	602004 ③
AMERICAN MOTORS EAGLE, SX4					
1984	4	2.5L		--	602004 ③
81-83	4	2.5L		--	602004 ③
85-88	6	4.2L	w/Air Tube	--	602004 ③
82-84	6	4.2L		--	602004 ③
80-81	6	4.2L		--	602004 ③
AMERICAN MOTORS GREMLIN					
75-76	8	5.0L		--	602004 ③
1978	4,6	2.0L, 3.8L,		--	602004 ③
75-77	4,6	3.8L, 4.2L		--	602004 ③
AMERICAN MOTORS HORNET					
75-77	6,8	All		--	602004 ③
AMERICAN MOTORS MATADOR					
1978	6	All		--	602004 ③
75-76	8	6.6L	401 C.I.D.	--	605004 ③
75-77	6,8	All	(Exc. 401 C.I.D.)	--	602004 ③

③ Federal & California Emissions. Not For Sale or Use on vehicles licensed in the state of CA & NY (NY vehicles with CA Emissions). Check with your state authority for details.



APPLICATION LISTINGS FEDERAL CONVERTERS

YR/YRS	CYL	LITER	DESCRIPTION	DIRECT FIT	UNIVERSAL
AMERICAN MOTORS PACER					
75-79	6	All		--	602004 ^③
AMERICAN MOTORS SPIRIT					
81-82	4	All		--	602004 ^③
1980	4	All		--	602004 ^③
79-83	6	All		--	602004 ^③
1979	8	All		--	602004 ^③
ASTON MARTIN LAGONDA					
85-89	V8	5.3L		--	609005 ^③
ASTON MARTIN V-8					
85-89	V8	5.3L		--	609005 ^③
ASTON MARTIN ZAGATO					
87-88	V8	5.3L		--	609005 ^③
ASTON MARTIN VIRAGE					
89-90	V8	5.3L		--	609005 ^③
ASUNA GT					
1993	4	All	GT Models	--	602206 ^③
ASUNA SE					
1993	4	All	SE Models	--	602206 ^③
ASUNA SUNFIRE					
92-93	4	1.8L	Sunfire	--	602206 ^③
ASUNA SUNRUNNER					
94-95	4	1.6L	w/21" Conv. (Canada Model)	--	602204 ^③
89-93	4	All	(Canada Model)	642418 ^③	602205 ^③
AUDI 100					
75-77	4	1.9L		--	602214 ^③
89-91	5	2.3L	Auto Trans., (Exc. Quattro); From 8/89	--	602215 ^③
89-91	5	2.3L	Manual Trans., (Exc. Quattro); From 8/89	--	602215 ^③
89-91	5	2.3L	Quattro; From 5/88 To 12/90	--	602214 ^③
93-94	6	2.8L	Manual Trans., Left	--	602205 ^③
93-94	6	2.8L	Manual Trans., Right	--	602205 ^③
93-94	6	2.8L	S, CS Sedan & S Wagon w/Auto Trans., Right Side	642586 ^③	602205 ^③
93-94	6	2.8L	S, CS Sedan & S Wagon w/Auto Trans., Left Side	642938 ^③	602205 ^③
92-93	6	2.8L	Quattro, Right Side	642586 ^③	602205 ^③
92-93	6	2.8L	Quattro, Left Side	642938 ^③	602205 ^③
1992	6	2.8L	Manual Trans., Right, (Exc. Quattro)	--	602205 ^③
1992	6	2.8L	Manual Trans., Left, (Exc. Quattro)	--	602205 ^③
AUDI 200					
90-91	5	2.2L	Quattro	--	602205 ^③
89-91	5	2.2L	Auto Trans., (Exc. Quattro)	--	602216 ^③
AUDI 4000					
1980	4	1.6L		--	602214 ^③
81-83	4	1.7L	w/Conv.	--	602214 ^③
84-87	4	1.8L		--	602214 ^③
85-86	5	2.2L	(Exc. Quattro)	--	602214 ^③
AUDI 5000					
86-88	5	2.2L	Auto Trans., (Exc. Quattro)	--	602216 ^③
86-88	5	2.2L	Manual Trans., (Exc. Quattro)	--	602215 ^③
81-85	5	2.2L	(Exc. Turbo or Quattro); To 12/84	--	602214 ^③

③ Federal & California Emissions. Not For Sale or Use on vehicles licensed in the state of CA & NY (NY vehicles with CA Emissions). Check with your state authority for details.

APPLICATION LISTINGS

FEDERAL CONVERTERS



YR/YRS	CYL	LITER	DESCRIPTION	DIRECT FIT	UNIVERSAL
AUDI 5000 (Cont.)					
87-88	5	2.3L	Auto Trans., (Exc. Quattro)	--	602216 ^③
87-88	5	2.3L	Manual Trans., (Exc. Quattro)	--	602215 ^③
81-85	5	All	Turbo, (Exc. Quattro)	--	602216 ^③
1980	5	All	California Emissions, w/Turbo	--	602216 ^⑤
1980	5	All	California Emissions, (Exc. Turbo)	--	602214 ^⑤
1980	5	All	Federal Emissions	--	602215 ^④
78-79	5	All		--	602215 ^③
AUDI 80					
88-90	4	2.0L	Auto Trans.	--	602214 ^③
88-90	4	2.0L	Manual Trans.	--	602214 ^③
91-92	5	2.3L	(Exc. Quattro)	--	602214 ^③
88-91	5	All	Quattro; From 10/87 To 9/91	--	602214 ^③
AUDI 90 (Exc. Cabriolet)					
1988	4	2.0L	Auto Trans.	--	602214 ^③
1988	4	2.0L	Manual Trans.	--	602215 ^③
90-91	5	2.3L	4 Speed Auto Trans., (Exc. Quattro)	--	602215 ^③
88-91	5	2.3L	Manual Trans., (Exc. Quattro)	--	602215 ^③
88-91	5	All	Quattro or 3 Speed Auto Trans.	--	602215 ^③
93-95	6	2.8L	Auto Trans., Right Side	--	602215 ^③
93-95	6	2.8L	Auto Trans., Left Side	--	602215 ^③
93-95	6	2.8L	Manual Trans., Right	--	602214 ^③
93-95	6	2.8L	Manual Trans., Left	--	602214 ^③
AUDI A3					
06-08	4	2.0L		642007 ^③	--
AUDI A3 QUATTRO					
06-09	6	3.2L		643110 ^③	--
AUDI A4					
97-06	4	1.8L	Turbo	642688 ^③	608214 ^③
97-05	4	1.8L	Quattro, Turbo	642688 ^③	608214 ^③
2009	4	2.0L	A4 & A4 Quattro, Cabriolet Submodels	642018 ^③	--
05-08	4	2.0L	A4 & A4 Quattro	642018 ^③	--
2001	6	2.8L	Quattro, Right Side, w/ Man. Trans.	643057 ^③	--
2001	6	2.8L	Quattro, Left Side, w/ Man. Trans.	643058 ^③	--
00-01	6	2.8L	Quattro, Automatic Trans., Right	643118 ^③	--
00-01	6	2.8L	Quattro, Automatic Trans., Left	643117 ^③	--
98-99	6	2.8L	Quattro, Right	643022 ^③	608284 ^③
98-99	6	2.8L	Quattro, Left	643023 ^③	608284 ^③
98-99	6	2.8L	Auto Trans., Right Side	643022 ^③	608284 ^③
98-99	6	2.8L	Auto Trans., Left Side	643023 ^③	608284 ^③
1997	6	2.8L	AHA Engine, Auto. Trans., Right	643022 ^③	608284 ^③
1997	6	2.8L	AHA Engine, Auto. Trans., Left	643023 ^③	608284 ^③
1996	6	2.8L	Right	--	608214 ^③
1996	6	2.8L	Left	--	608214 ^③
02-05	6	3.0L	Quattro, Left Side, w/ Man. Trans.	642011 ^③	--
02-05	6	3.0L	Quattro, Right Side, w/ Man. Trans.	642012 ^③	--
03-04	6	3.0L	Cabriolet, Right	642211 ^③	--
03-04	6	3.0L	Cabriolet, Left	642210 ^③	--

③ Federal & California Emissions. Not For Sale or Use on vehicles licensed in the state of CA & NY (NY vehicles with CA Emissions). Check with your state authority for details.

④ Federal Emissions. Not For Sale or Use on vehicles licensed in the state of CA. Check with your state authority.

⑤ California Emissions. Not For Sale or Use on vehicles licensed in the state of CA & NY. Check with your state authority.



APPLICATION LISTINGS FEDERAL CONVERTERS

YR/YRS	CYL	LITER	DESCRIPTION	DIRECT FIT	UNIVERSAL
AUDI A4 (Cont.)					
02-04	6	3.0L	Sedan, 5 Speed Auto. Trans., Right	642211 ③	--
02-04	6	3.0L	Sedan, 5 Speed Auto. Trans., Left	642210 ③	--
07-08	6	3.2L	Right	--	608265 ③
07-08	6	3.2L	Left	--	608265 ③
AUDI A6					
03-04	6	2.7L	Left	--	608265 ③
03-04	6	2.7L	Quattro, Automatic Trans., Right	642894 ③	--
03-04	6	2.7L	Quattro, Automatic Trans., Left	642893 ③	--
03-04	6	2.7L	Right	--	608265 ③
00-04	6	2.7L	Quattro, Standard Trans., Right	642879 ③	--
00-04	6	2.7L	Quattro, Standard Trans., Left	642878 ③	--
00-02	6	2.7L	Turbo Quattro w/Auto Trans., Right Side	642978 ③	608214 ③
00-02	6	2.7L	Turbo Quattro w/Auto Trans., Left Side	642748 ③	608214 ③
00-01	6	2.8L	Quattro Sedan & Wagon w/Auto Trans., Right Side	642976 ③	608214 ③
00-01	6	2.8L	Quattro Sedan & Wagon w/Auto Trans., Left Side	642977 ③	608214 ③
98-99	6	2.8L	AHA Engine, Right	643022 ③	--
98-99	6	2.8L	AHA Engine, Left	643027 ③	--
98-99	6	2.8L	Quattro Sedan & Wagon, AHA Engine, Right Side	643022 ③	--
98-99	6	2.8L	Quattro Sedan & Wagon, AHA Engine, Left Side	643027 ③	--
95-97	6	2.8L	Left	--	608214 ③
95-97	6	2.8L	Right	--	608214 ③
2003	6	3.0L	Quattro, Right Side, w/ Auto. Trans.	643063 ③	608265 ③
2003	6	3.0L	Quattro, Left Side, w/ Auto. Trans.	643064 ③	608265 ③
06-08	6	3.2L	Left	--	608265 ③
06-08	6	3.2L	Right	--	608265 ③
05-08	6	3.2L	Quattro, Left	643131 ③	--
05-08	6	3.2L	Quattro, Right	643132 ③	--
03-04	8	4.2L	Left	--	608265 ③
03-04	8	4.2L	Right	--	608265 ③
00-01	8	4.2L	Quattro Sedan & Wagon w/Auto Trans., Right Side	642976 ③	608214 ③
00-01	8	4.2L	Quattro Sedan & Wagon w/Auto Trans., Left Side	642977 ③	608214 ③
AUDI ALL ROAD					
03-05	6	2.7L	Right	--	608265 ③
03-05	6	2.7L	Left	--	608265 ③
01-02	6	2.7L	Turbo Quattro, w/Auto Trans, Right Side	642978 ③	608214 ③
01-02	6	2.7L	Turbo Quattro, w/Auto Trans, Left Side	642748 ③	608214 ③
01-02	6	2.7L	Manual Trans., Right	--	608265 ③
01-02	6	2.7L	Manual Trans., Left	--	608265 ③
AUDI ALLROAD QUATTRO					
03-05	6	2.7L	Automatic Trans., Left	642893 ③	--
03-05	6	2.7L	Automatic Trans., Right	642894 ③	--
01-05	6	2.7L	Quattro, Standard Trans., Right	642879 ③	--
01-05	6	2.7L	Quattro, Standard Trans., Left	642878 ③	--
03-05	8	4.2L	Automatic Trans., Left	643127 ③	--
03-05	8	4.2L	Automatic Trans., Right	643128 ③	--

③ Federal & California Emissions. Not For Sale or Use on vehicles licensed in the state of CA & NY (NY vehicles with CA Emissions). Check with your state authority for details.

APPLICATION LISTINGS

FEDERAL CONVERTERS



YR/YRS	CYL	LITER	DESCRIPTION	DIRECT FIT	UNIVERSAL
AUDI CABRIOLET					
96-98	6	2.8L	AFC Eng., Left	--	608214③
96-98	6	2.8L	AFC Eng., Right	--	608214③
96-97	6	2.8L	AAH & AFC Eng., Right	--	608214③
96-97	6	2.8L	AAH & AFC Eng., Left	--	608214③
94-95	6	2.8L	AAH & AFC Eng., Right	--	602214③
94-95	6	2.8L	AAH & AFC Eng., Left	--	602214③
AUDI COUPE					
81-85	5	2.2L	Quattro	--	602214③
AUDI FOX					
75-79	4	1.6L		--	602214③
AUDI Q7					
2007	6	3.6L	Left	642875 ③	--
2007	6	3.6L	Right	642876 ③	--
AUDI S4					
92-94	5	2.2L		--	602214③
04-09	8	4.2L	Standard Trans., Left	642886 ③	--
04-09	8	4.2L	Standard Trans., Right	642887 ③	--
AUDI S6					
1995	5	2.2L	Right	--	608214③
1995	5	2.2L	Left	--	608214③
AUDI TT					
03-06	4	1.8L	AWD Quattro, Eng. Code-BEA	642709 ③	--
00-06	4	1.8L	(Exc. Quattro)	642687 ③	--
01-02	4	1.8L	AWD Quattro, Eng. Code-AMU	642709 ③	--
04-06	6	3.2L	Quattro	642859 ③	--
AUDI V-8					
90-91	8	3.6L		--	602215③
92-94	8	4.2L		--	602215③
AVANTI II					
84-85	V8	5.0L	w/Air Tube	--	609006③
81-85	V8	5.0L	w/o Air Tube	--	602205③
77-80	V8	5.7L		--	602005③
75-76	V8	6.6L		--	605005③
BERTONE X-1/9					
84-89	4	1.5L	17-3/4" Conv	--	602203③
84-85	4	2.0L	17-3/4" Conv	--	602203③
84-89	4	All	(Exc. 17-3/4" Conv.)	--	602203③
BLUE BIRD BUS CV200					
98-00	8	7.4L	Built on GMC Chassis	646310 ③	606007③
BMW 318					
1995	4	1.8L		--	609004③
91-94	4	1.8L		645949 ③	609004③
84-85	4	1.8L		--	609004③
96-98	4	1.9L	318I, IS, IC, (E36 Models)	642956 ③	608235③
1996	4	1.9L	318 TI, (E36 Models)	642956 ③	608235③
BMW 320					
80-83	4	1.8L	From 9/79	--	609004③
77-79	4	All	California Emissions	--	609004⑤

③ Federal & California Emissions. Not For Sale or Use on vehicles licensed in the state of CA & NY (NY vehicles with CA Emissions). Check with your state authority for details.

⑤ California Emissions. Not For Sale or Use on vehicles licensed in the state of CA & NY. Check with your state authority.



APPLICATION LISTINGS FEDERAL CONVERTERS

YR/YRS	CYL	LITER	DESCRIPTION	DIRECT FIT	UNIVERSAL
BMW 323CI					
2000	6	2.5L	Manifold Unit, Front	642134 ③	--
2000	6	2.5L	Rear Manifold Conv.	642133 ③	--
BMW 323I					
99-00	6	2.5L	Manifold Unit, Front	642134 ③	--
99-00	6	2.5L	Rear Manifold Conv.	642133 ③	--
BMW 325					
01-06	6	2.5L	325ci, Exc. SULEV Emissions, Front	642234 ③	--
01-06	6	2.5L	325ci, Exc. SULEV Emissions, Rear	642233 ③	--
01-05	6	2.5L	325i, 325xi, Exc. SULEV Emissions, Front	642234 ③	--
01-05	6	2.5L	325i, 325xi, Exc. SULEV Emissions, Rear	642233 ③	--
1995	6	2.5L	325i iC iS E/36, Right	--	602214③
1995	6	2.5L	325i iC iS E/36, Left	--	602214③
92-95	6	2.5L	325i iC iS	645939 ③	--
88-91	6	2.5L	325 Models, (Exc. iC)	--	609220③
87-91	6	2.5L	325 iC ; From 9/86	--	609220③
84-87	6	2.7L	325, 325E, 325ES	--	609004③
2006	6	3.0L	325i, Rear Left	642856 ③	--
2006	6	3.0L	325xi, Rear Left	642856 ③	--
2006	6	3.0L	325i, Rear Right	642857 ③	--
2006	6	3.0L	325xi, Rear Right	642857 ③	--
BMW 328					
2000	6	2.8L	328ci, Front Manifold Conv.	642134 ③	--
2000	6	2.8L	328ci, Rear Manifold Conv.	642133 ③	--
99-00	6	2.8L	328i, Front Manifold Conv.	642134 ③	--
99-00	6	2.8L	328i, Rear Manifold Conv.	642133 ③	--
96-98	6	2.8L	328i, iS, Convertible	645939 ③	--
96-97	6	2.8L	328 E/36, Right	--	608214③
96-97	6	2.8L	328 E/36, Left	--	608214③
07-12	6	3.0L	328i, ULEV Emissions, Rear Left	642856 ③	--
07-12	6	3.0L	328i, ULEV Emissions, Rear Right	642857 ③	--
07-08	6	3.0L	328xi, ULEV Emissions, Rear Left	642856 ③	--
07-08	6	3.0L	328xi, ULEV Emissions, Rear Right	642857 ③	--
BMW 330					
2006	6	3.0L	330i, Rear Manifold Converter	642159 ③	--
2006	6	3.0L	330ci, Rear Left	642856 ③	--
2006	6	3.0L	330xi, Rear Left	642856 ③	--
2006	6	3.0L	330ci, Rear Right	642857 ③	--
2006	6	3.0L	330xi, Rear Right	642857 ③	--
04-06	6	3.0L	330ci, Exc. SULEV Emissions, Front	642158 ③	--
04-06	6	3.0L	330ci, Exc. SULEV Emissions, Rear	642159 ③	--
01-06	6	3.0L	330xi, Front Manifold Converter	642158 ③	--
01-06	6	3.0L	330xi, Rear Manifold Converter	642159 ③	--
01-05	6	3.0L	330i, Exc. SULEV Emissions, Front	642234 ③	--
01-05	6	3.0L	330i, Exc. SULEV Emissions, Rear	642233 ③	--
01-03	6	3.0L	330ci, Exc. SULEV Emissions, Front	642234 ③	--
01-03	6	3.0L	330ci, Exc. SULEV Emissions, Rear	642233 ③	--

③ Federal & California Emissions. Not For Sale or Use on vehicles licensed in the state of CA & NY (NY vehicles with CA Emissions). Check with your state authority for details.

APPLICATION LISTINGS

FEDERAL CONVERTERS



YR/YRS	CYL	LITER	DESCRIPTION	DIRECT FIT	UNIVERSAL
BMW 525					
04-05	6	2.5L	525i, Manifold Unit, Front	641437 ③	--
04-05	6	2.5L	525i, Manifold Unit, Rear	641438 ③	--
01-03	6	2.5L	Manifold Unit, Rear	641397 ③	--
01-03	6	2.5L	Manifold Unit, Front	641396 ③	--
91-95	6	2.5L	525i, 24 valve E/34; To 3/95	--	609232 ③
89-90	6	2.5L		--	609231 ③
06-07	6	3.0L	525i & 525Xi, Front Manifold Converter	642106 ③	--
06-07	6	3.0L	525i & 525Xi, Rear Manifold Converter	642119 ③	--
06-07	6	3.0L	525i & 525Xi, Right Rear	642146 ③	--
06-07	6	3.0L	525i & 525Xi, Left Rear	642145 ③	--
BMW 528					
87-88	6	2.7L	528E; From 3/87	--	609231 ③
82-87	6	2.7L	528E ; To 2/87	--	609240 ③
99-00	6	2.8L	528i, Front Manifold Conv.	642134 ③	--
99-00	6	2.8L	528i, Rear Manifold Conv.	642135 ③	--
97-99	6	2.8L	528i, Right	--	608214 ③
97-99	6	2.8L	528i, Left	--	608214 ③
79-81	6	All	528i	--	609220 ③
BMW 530					
06-07	6	3.0L	530i & 530Xi, Front Manifold Converter	642106 ③	--
06-07	6	3.0L	530i & 530Xi, Rear Manifold Converter	642119 ③	--
06-07	6	3.0L	530i & 530Xi, Right Rear	642146 ③	--
06-07	6	3.0L	530i & 530Xi, Left Rear	642145 ③	--
04-05	6	3.0L	530i, Manifold Unit, Rear	641438 ③	--
04-05	6	3.0L	530i, Manifold Unit, Front	641437 ③	--
01-03	6	3.0L	Manifold Unit, Rear	641397 ③	--
01-03	6	3.0L	Manifold Unit, Front	641396 ③	--
1994	8	All	530, Right	--	602214 ③
1994	8	All	530, Left	--	602214 ③
BMW 533					
83-84	6	All		--	609220 ③
BMW 535					
88-93	6	3.5L	535i; From 6/88	--	604051 ③
85-88	6	3.5L	To 5/88	--	609231 ③
88-93	6	All	California Emissions, Main Conv.; From 6/88	--	609231 ⑤
BMW 540					
1994	8	4.0L	540i, Right Side	--	609004 ③
1994	8	4.0L	540i, Left Side	--	609004 ③
99-03	8	4.4L	Rear Right	643106 ③	--
99-03	8	4.4L	Rear Left	643105 ③	--
97-98	8	4.4L	Left	643025 ③	608235 ③
97-98	8	4.4L	Right	643024 ③	608235 ③
BMW 550I					
2011	8	4.4L	Front Left	641430 ③	--
2011	8	4.4L	Front Right	641431 ③	--
BMW 550I GT					
10-11	8	4.4L	Front Left	641430 ③	--
10-11	8	4.4L	Front Right	641431 ③	--

③ Federal & California Emissions. Not For Sale or Use on vehicles licensed in the state of CA & NY (NY vehicles with CA Emissions). Check with your state authority for details.

⑤ California Emissions. Not For Sale or Use on vehicles licensed in the state of CA & NY. Check with your state authority.



APPLICATION LISTINGS FEDERAL CONVERTERS

YR/YRS	CYL	LITER	DESCRIPTION	DIRECT FIT	UNIVERSAL
BMW 550I GT XDRIVE					
10-11	8	4.4L	Front Left	641430 ③	--
10-11	8	4.4L	Front Right	641431 ③	--
BMW 550I XDRIVE					
2011	8	4.4L	Front Left	641430 ③	--
2011	8	4.4L	Front Right	641431 ③	--
BMW 633					
82-84	6	3.2L	633 CSI ; From 9/81 To 8/84	--	609220③
79-81	6	3.2L	633 CSI ; From 9/79 To 8/81	--	609240③
BMW 635					
88-89	6	3.5L	635 CSI	--	609231③
85-87	6	3.5L	635 CSI ; From 9/84 To 8/87	--	609231③
BMW 650I					
2012	8	4.4L	Front Left	641430 ③	--
2012	8	4.4L	Front Right	641431 ③	--
BMW 650I XDRIVE					
2012	8	4.4L	Front Left	641430 ③	--
2012	8	4.4L	Front Right	641431 ③	--
BMW 733					
82-84	6	3.2L		--	609220③
80-81	6	3.2L		--	609231③
BMW 735					
87-92	6	3.5L	735i, iL, E/32	--	609231③
85-87	6	3.5L	735i, E/23; From 9/84	--	609220③
BMW 740					
1995	8	4.0L	Left	--	608214③
1995	8	4.0L	Right	--	608214③
1994	8	4.0L	Left	--	609004③
1994	8	4.0L	Right	--	609004③
1993	8	4.0L	740i & 740il Models, Right Side	--	609004③
1993	8	4.0L	740i & 740il Models, Left Side	--	609004③
99-01	8	4.4L	740i, Rear Right	643106 ③	--
99-01	8	4.4L	740i, Rear Left	643105 ③	--
99-01	8	4.4L	740il, Rear Right	643106 ③	--
99-01	8	4.4L	740il, Rear Left	643105 ③	--
97-98	8	4.4L	740i & 740il Models, Right Side	643024 ③	608235③
97-98	8	4.4L	740i & 740il Models, Left Side	643025 ③	608235③
1996	8	4.4L	740il, Right	643024 ③	608235③
1996	8	4.4L	740il, Left	643025 ③	608235③
BMW 745					
02-05	8	4.4L	745Li, Right	--	608284③
BMW 750					
88-94	12	5.0L	E/32, Right; From 12/87	--	609240③
88-94	12	5.0L	E/32, Left; From 12/87	--	609240③
95-96	12	5.4L	E/38, Right	--	608235③
95-96	12	5.4L	E/38, Left	--	608235③
BMW 750I					
09-11	8	4.4L	Front Left	641430 ③	--
09-11	8	4.4L	Front Right	641431 ③	--

③ Federal & California Emissions. Not For Sale or Use on vehicles licensed in the state of CA & NY (NY vehicles with CA Emissions). Check with your state authority for details.

APPLICATION LISTINGS

FEDERAL CONVERTERS



YR/YRS	CYL	LITER	DESCRIPTION	DIRECT FIT	UNIVERSAL
BMW 750I XDRIVE					
10-11	8	4.4L	Front Left	641430 ③	--
10-11	8	4.4L	Front Right	641431 ③	--
BMW 750LI					
10-11	8	4.4L	Front Left	641430 ③	--
10-11	8	4.4L	Front Right	641431 ③	--
BMW 750LI XDRIVE					
10-11	8	4.4L	Front Left	641430 ③	--
10-11	8	4.4L	Front Right	641431 ③	--
BMW 840					
1995	8	4.0L	840 CI, Right	--	608234 ③
1995	8	4.0L	840 CI, Left	--	608234 ③
1994	8	4.0L	840 CI, Right	--	609004 ③
1994	8	4.0L	840 CI, Left	--	609004 ③
1996	8	4.4L	840 CI, Right	--	608234 ③
1996	8	4.4L	840 CI, Left	--	608234 ③
BMW 850					
1994	12	5.0L	850 CI, Right	--	609240 ③
1994	12	5.0L	850 CI, Left	--	609240 ③
91-93	12	5.0L	850, Right	--	609240 ③
91-93	12	5.0L	850, Left	--	609240 ③
1996	12	5.4L	850 CI, Right	--	608235 ③
1996	12	5.4L	850 CI, Left	--	608235 ③
1995	12	5.4L	850 CI, Right	--	608235 ③
1995	12	5.4L	850 CI, Left	--	608235 ③
1995	12	5.6L	850 CSI, Right	--	608235 ③
1995	12	5.6L	850 CSI, Left	--	608235 ③
1994	12	5.6L	850 CSI, Right	--	609240 ③
1994	12	5.6L	850 CSI, Left	--	609240 ③
BMW M3					
88-91	4	2.3L	Right	--	609004 ③
88-91	4	2.3L	Left	--	609004 ③
1995	6	3.0L	Right	--	608235 ③
1995	6	3.0L	Left	--	608235 ③
96-98	6	3.2L		645939 ③	--
96-97	6	3.2L	Right	--	608235 ③
96-97	6	3.2L	Left	--	608235 ③
BMW M5					
1988	6	3.5L	Right	--	609004 ③
1988	6	3.5L	Left	--	609004 ③
91-93	6	3.6L	Right	--	609004 ③
91-93	6	3.6L	Left	--	609004 ③
BMW M6					
87-88	6	3.5L	Right	--	609004 ③
87-88	6	3.5L	Left	--	609004 ③
BMW X5					
01-06	6	3.0L	Manifold Unit, Rear	641397 ③	--
01-06	6	3.0L	Manifold Unit, Front	641396 ③	--
10-11	8	4.4L	Front Left	641430 ③	--

③ Federal & California Emissions. Not For Sale or Use on vehicles licensed in the state of CA & NY (NY vehicles with CA Emissions). Check with your state authority for details.



APPLICATION LISTINGS FEDERAL CONVERTERS

YR/YRS	CYL	LITER	DESCRIPTION	DIRECT FIT	UNIVERSAL
BMW X5 (Cont.)					
10-11	8	4.4L	Front Right	641431 ③	--
00-03	8	4.4L	Right	642261 ③	608264 ③
00-03	8	4.4L	Left	642260 ③	608264 ③
02-03	8	4.6L	Right	642261 ③	608264 ③
BMW X6					
08-11	8	4.4L	Front Left	641430 ③	--
08-11	8	4.4L	Front Right	641431 ③	--
BMW Z3					
96-98	4	1.9L		--	608235 ③
01-02	6	2.5L	Front Conv.	642234 ③	--
01-02	6	2.5L	Rear Conv.	642233 ③	--
99-00	6	2.5L	Manifold Unit, Front	642134 ③	--
99-00	6	2.5L	Rear Manifold Conv.	642133 ③	--
99-00	6	2.8L	Manifold Unit, Front	642134 ③	--
99-00	6	2.8L	Rear Manifold Conv.	642133 ③	--
01-02	6	3.0L	Front Conv.	642234 ③	--
01-02	6	3.0L	Rear Conv.	642233 ③	--
BMW Z4					
03-05	6	2.5L	Right	--	608265 ③
03-06	6	3.0L	Right	--	608265 ③
BUICK ALLURE					
2010	6	3.0L	Front, Left	641444 ③	--
2010	6	3.0L	Front Right	641445 ③	--
2010	6	3.0L	FWD, Center	643135 ③	--
BUICK APOLLO					
1975	6,8	All		--	602205 ③
BUICK CENTURY					
1996	4	2.2L		642921 ③	608205 ③
93-95	4	2.2L		642921 ③	602204 ③
86-92	4	2.5L	Conv. w/Front Pipe, w/o Air Tube	642954 ③	602204 ③
86-92	4	2.5L	Conv. w/o Front Pipe, w/Air Tube	642374 ☆②③	602004 ③
82-85	4	2.5L		--	602004 ③
87-89	6	2.8L	Conv. w/Front Pipe	--	602004 ③
84-89	6	2.8L	Conv. Only	642374 ☆②③	602004 ③
82-83	6	2.8L		--	602004 ③
82-85	6	3.0L		--	602004 ③
97-05	6	3.1L		642525 ③	608205 ③
1996	6	3.1L		642971 ③	608205 ③
1995	6	3.1L		642971 ③	608205 ③
1994	6	3.1L		642971 ③	602205 ③
1993	6	3.3L	Station Wgn.	--	602205 ③
89-93	6	3.3L	(Exc. '93 Station Wgn.)	642416 ③	602205 ③
86-88	6	3.8L	Includes Front Pipe, w/o Air Tube	--	602204 ③
86-88	6	3.8L	Conv. Only, w/Air Tube	642374 ☆②③	602004 ③
84-85	6	3.8L		--	602004 ③
1981	6	3.8L	(Exc. Turbo)	642352 ☆③	602005 ③
1980	6	3.8L	(Exc. Turbo)	--	602206 ③

☆ Air Tube kit 4948 may be required for installation.

② When using with aftermarket piping, direct fit converter may require INLET/OUTLET pipe resizing.

③ Federal & California Emissions. Not For Sale or Use on vehicles licensed in the state of CA & NY (NY vehicles with CA Emissions). Check with your state authority for details.

APPLICATION LISTINGS

FEDERAL CONVERTERS



YR/YRS	CYL	LITER	DESCRIPTION	DIRECT FIT	UNIVERSAL
BUICK CENTURY (Cont.)					
79-80	6	3.8L	Turbo	--	602206③
75-77	6	3.8L		--	602206③
78-79	6	All	(Exc. Turbo)	642352 ☆③	602005③
1981	8	4.3L		642352 ☆③	602005③
1979	8	4.9L		--	602005③
1978	8	5.0L	w/2 bbl Carb.	642352 ☆③	602005③
1977	8	6.6L	403 C.I.D.	--	604006③
1980	8	All		--	602006③
78-79	8	All	(Exc. 5.0L w/2 bbl Carb.)	--	602206③
75-77	8	All	(Exc. 403 C.I.D. 6.6L Eng.)	--	602206③
BUICK ELECTRA - (Inc. Park Avenue)					
88-90	6	3.8L	For use with OE intermediate pipe, #6 bushing may be required with aftermarket pipe.	642360 ②③	602205③
88-90	6	3.8L	For use with 2-3/8" I.D. aftermarket intermediate pipe.	642657 ③	602205③
86-87	6	3.8L	For use with OE intermediate pipe.	642426 ②③	602205③
86-87	6	3.8L	For use with 2-3/8" I.D. aftermarket intermediate pipe.	--	602205③
1984	6	4.1L		642353 ☆③	602205③
81-83	6	4.1L		642352 ☆③	602005③
1980	6	4.1L		--	602206③
1985	6	All		--	602004③
1980	8	4.9L		--	602206③
84-89	8	5.0L	Electra Station Wgn.	--	609005③
84-89	8	5.0L	Electra Station Wgn., Optional Direct Fit Converter	642359 ☆③	602005③
1984	8	5.0L	Electra, (Exc. Station Wgn.)	642359 ☆③	602005③
81-83	8	5.0L		642352 ☆③	602005③
1980	8	5.7L	Code "X"	--	602206③
1980	8	5.7L	Code "R"	--	602005③
77-79	8	6.6L	403 C.I.D.	--	605006③
75-76	8	7.5L		--	604006③
77-79	8	All	(Exc. 403 C.I.D.)	--	602206③
BUICK ENCLAVE					
09-12	6	3.6L	Rear Main	642044 ③	--
08-11	6	3.6L	Front Conv.	642125 ③	--
08-11	6	3.6L	Rear Conv.	642126 ③	--
BUICK LACROSSE					
2010	6	3.0L	Front, Left	641444 ③	--
2010	6	3.0L	Front Right	641445 ③	--
2010	6	3.0L	FWD, Center	643135 ③	--
06-08	6	3.6L		--	608405③○
05-09	6	3.8L		642278 ③	608405③○
				--	608294③□
08-09	8	5.3L		642101 ③	--
BUICK LESABRE					
00-05	6	3.8L	(Exc. Supercharged, Use w/OE Pipe, Includes Resonator)	645979 ③	608227③
00-05	6	3.8L		645288 ③	608227③

☆ Air Tube kit 4948 may be required for installation.

② When using with aftermarket piping, direct fit converter may require INLET/OUTLET pipe resizing.

③ Federal & California Emissions. Not For Sale or Use on vehicles licensed in the state of CA & NY (NY vehicles with CA Emissions). Check with your state authority for details.

□ EPA OBDII By Design Unit

○ EPA Enhanced OBDII By Design Unit



APPLICATION LISTINGS FEDERAL CONVERTERS

YR/YRS	CYL	LITER	DESCRIPTION	DIRECT FIT	UNIVERSAL
BUICK LESABRE (Cont.)					
97-99	6	3.8L	Models w/4 Bolt Flange Inlet, front pipe & conv. separate, for use with OE intermediate pipe, additional sizing, bushings, cutting may be required due to OE exhaust design, # 3 bushing may be required.	645357 ②③ -- -- --	608226 ③ -- -- --
97-99	6	3.8L	Models w/4 Bolt Flange Inlet, front pipe & conv. separate, for use with aftermarket intermediate pipe, additional sizing, bushings, cutting may be required due to OE exhaust design.	645410 ②③ -- --	608226 ③ -- --
95-97	6	3.8L	"K" & "L" Eng., front pipe & conv. 1 piece, w/ 2 Bolt Flange, additional sizing, bushings, cutting may be required due to OE exhaust design, # 3 bushing may be required.	642706 ②③ -- --	608226 ③ -- --
92-94	6	3.8L	Models w/o O2 Sensor, for use with OE intermediate pipe, additional sizing, bushings, cutting may be required due to OE exhaust design, # 3 bushing may be required.	642475 ②③ -- --	602206 ③ -- --
92-94	6	3.8L	Models w/o O2 Sensor, for use with aftermarket intermediate pipe, additional sizing, bushings, cutting may be required due to OE exhaust design.	642771 ②③ -- --	602206 ③ -- --
88-91	6	3.8L	For use with OE intermediate pipe, # 6 bushing may be required with aftermarket pipe.	642360 ②③ --	602205 ③ --
88-91	6	3.8L	For use with 2-3/8" I.D. aftermarket intermediate pipe.	642657 ③	602205 ③
1979	6	3.8L	Turbo, Angled Conv.	--	602206 ③
1979	6	3.8L	Turbo, Straight Conv.	--	602005 ③
77-79	6	3.8L	(Exc. Turbo)	--	602206 ③
1976	6	3.8L		--	602206 ③
86-87	6	All	For use with OE intermediate pipe.	642426 ②③	602205 ③
86-87	6	All	For use with 2-3/8" I.D. aftermarket intermediate pipe.	--	602205 ③
83-85	6	All		642353 ☆③	602205 ③
81-82	6	All		642352 ☆③	602005 ③
1980	6	All	w/o Air Tube	--	602206 ③
1980	6	All	w/Air Tube	--	602006 ③
1980	8	4.9L		--	602206 ③
85-90	8	5.0L	Station Wgn.	642359 ☆③	602005 ③
84-85	8	5.0L	LeSabre, (Exc. Station Wgn.)	642359 ☆③	602005 ③
81-83	8	5.0L		642352 ☆③	602005 ③
1980	8	5.7L	Code "X"	--	602206 ③
1980	8	5.7L	Code "R"	--	602005 ③
75-76	8	7.5L	455 C.I.D.	--	604006 ③
77-79	8	All		--	602206 ③
75-76	8	All	(Exc. 455 C.I.D.)	--	602206 ③
BUICK LUCERNE					
06-08	6	3.8L		--	608405 ③○
06-08	6	3.8L		644014 ③	--
09-11	6	3.9L	Front	644016 ③	--
06-08	8	4.6L		--	608405 ③○
BUICK PARK AVENUE					
00-05	6	3.8L	(Exc. Supercharged, Use w/OE Pipe, Includes Resonator)	645979 ③	608227 ③
00-05	6	3.8L	For use with Aftermarket pipes, additional sizing, bushings, cutting may be required due to OE exhaust design.	645288 ③ --	608227 ③ --

☆ Air Tube kit 4948 may be required for installation.

② When using with aftermarket piping, direct fit converter may require INLET/OUTLET pipe resizing.

③ Federal & California Emissions. Not For Sale or Use on vehicles licensed in the state of CA & NY (NY vehicles with CA Emissions). Check with your state authority for details.

○ EPA Enhanced OBDII By Design Unit

APPLICATION LISTINGS

FEDERAL CONVERTERS



YR/YRS	CYL	LITER	DESCRIPTION	DIRECT FIT	UNIVERSAL
BUICK PARK AVENUE (Cont.)					
97-00	6	3.8L	Supercharged Eng., Additional sizing, bushings, cutting may be required due to OE exhaust design.	642741 ③ --	608226 ③ --
97-99	6	3.8L	Models w/4 Bolt Flange Inlet, 2nd design front pipe & conv. separate, for use with OE intermediate pipe, additional sizing, bushings, cutting may be required due to OE exhaust design, # 3 bushing may be required.	645357 ②③ -- --	608226 ③ -- --
97-99	6	3.8L	Models w/4 Bolt Flange Inlet, 2nd design front pipe & conv. separate, for use with aftermarket intermediate pipe, additional sizing, bushings, cutting may be required due to OE exhaust design.	645410 ②③ -- --	608226 ③ -- --
1996	6	3.8L	Supercharged Code "1" Eng., w/front pipe, additional sizing, bushings, cutting may be required due to OE exhaust design, # 3 bushing may be required.	642706 ②③ -- --	608226 ③ -- --
95-96	6	3.8L	"K" Eng. w/Post Conv. O2 Sensor, w/front pipe, (Exc. Supercharged), additional sizing, bushings, cutting may be required due to OE exhaust design, # 3 bushing may be required.	642706 ②③ -- --	608226 ③ -- --
91-94	6	3.8L	Models w/o O2 Sensor, for use with OE intermediate pipe, additional sizing, bushings, cutting may be required due to OE exhaust design, # 3 bushing may be required.	642475 ②③ -- --	602206 ③ -- --
91-94	6	3.8L	Models w/o O2 Sensor, for use with aftermarket intermediate pipe, additional sizing, bushings, cutting may be required due to OE exhaust design.	642771 ②③ -- --	602206 ③ -- --
BUICK RAINIER					
06-07	6	4.2L		645864 ③	608206 ③
04-05	6	4.2L		645878 ③	608216 ③
2007	8	5.3L		--	608265 ③
06-07	8	5.3L		645186 ③	--
05-06	8	5.3L		645265 ③	608286 ③
2004	8	5.3L		645784 ③ 642084 ③⑩	-- 608265 ③
BUICK REATTA					
1991	6	3.8L	Additional sizing, bushings, cutting may be required due to OE exhaust design.	642386 ②③ --	602206 ③ --
88-90	6	3.8L	Additional sizing, bushings, cutting may be required due to OE exhaust design.	--	602205 ③ --
BUICK REGAL					
88-89	6	2.8L	For use with OE intermediate pipe, additional sizing, bushings, cutting may be required due to OE exhaust design, # 6 bushing may be required at inlet & # 8 bushing may be required at outlet for use w/aftermarket pipe.	642370 ②③ -- --	602205 ③ -- --
88-89	6	2.8L	For use with 2-1/8" I.D. aftermarket intermediate pipe, additional sizing, bushings, cutting may be required due to OE exhaust design.	642524 ②③ --	602205 ③ --
95-96	6	3.1L	w/Post Conv. O2 Sensor	642569 ③	608215 ③
94-95	6	3.1L	(Exc. w/Post Conv. O2 Sensor)	642474 ③	602214 ③
1993	6	3.1L	Federal Emissions, For use with OE intermediate pipe, additional sizing, bushings, cutting may be required due to OE exhaust design, # 6 bushing may be required at inlet & # 8 bushing may be required at outlet for use w/aftermarket pipe.	642370 ②④ -- --	602205 ④ -- --

⑩ Discontinued, use until inventory is depleted.
 ② When using with aftermarket piping, direct fit converter may require INLET/OUTLET pipe resizing.
 ③ Federal & California Emissions. Not For Sale or Use on vehicles licensed in the state of CA & NY (NY vehicles with CA Emissions). Check with your state authority for details.
 ④ Federal Emissions. Not For Sale or Use on vehicles licensed in the state of CA. Check with your state authority.



APPLICATION LISTINGS FEDERAL CONVERTERS

YR/YRS	CYL	LITER	DESCRIPTION	DIRECT FIT	UNIVERSAL
BUICK REGAL (Cont.)					
1993	6	3.1L	Federal Emissions, For use with 2-1/8" I.D. aftermarket intermediate pipe, additional sizing, bushings, cutting may be required due to OE exhaust design.	642524 ②④ -- --	602205④ -- --
89-92	6	3.1L	For use with OE intermediate pipe, additional sizing, bushings, cutting may be required due to OE exhaust design, # 6 bushing may be required at inlet & # 8 bushing may be required at outlet for use w/aftermarket pipe.	642370 ②③ -- -- --	602205③ -- -- --
89-92	6	3.1L	For use with 2-1/8" I.D. aftermarket intermediate pipe, additional sizing, bushings, cutting may be required due to OE exhaust design.	642524 ②③ --	602205③ --
97-04	6	3.8L		642583 ③ --	608416③○ 608216③□
1996	6	3.8L	w/Resonator	642614 ③	608216③
94-95	6	3.8L		642749 ③	602205③
90-93	6	3.8L		642394 ③	602206③
86-87	6	3.8L	Turbo Grand National Pkg.	--	602206③
85-87	6	3.8L		642353 ☆③	602005③
1984	6	3.8L	(Exc. Turbo)	642353 ☆③	602005③
1983	6	3.8L	Federal Emissions, (Exc. Turbo)	642353 ☆④	602005④
1983	6	3.8L	California Emissions, (Exc. Turbo)	--	602005⑤
1980	6	3.8L		--	602006③
78-79	6	3.8L	Turbo	--	602206③
78-79	6	3.8L	(Exc. Turbo)	642352 ☆③	602205③
75-76	6	3.8L		--	602206③
83-84	6	4.1L		642353 ☆③	602005③
81-82	6	All		642352 ☆③	602005③
1979	8	4.9L		--	602005③
86-87	8	5.0L		642353 ☆③	602005③
83-85	8	5.0L	Code "H"	642355 ☆③	602005③
78-79	8	5.0L	Code "H"	--	602206③
1978	8	5.0L	Code "U"	--	602005③
80-82	8	All	w/ Air Tube	642352 ☆③	602005③
80-82	8	All	w/o Air Tube	--	602206③
75-77	8	All		--	602206③
BUICK RENDEZVOUS					
02-05	6	3.4L	AWD	642981 ③	608416③○
02-05	6	3.4L	FWD	643055 ③	608265③□
06-07	6	3.5L	FWD	643055 ③	608265③□
06-07	6	3.5L	AWD	--	608265③□
BUICK RIVIERA					
97-99	6	3.8L	Supercharged Eng.	642741 ③	608226③
1997	6	3.8L	Models w/4 Bolt Flange Inlet, 2nd design front pipe & conv. separate, for use with OE intermediate pipe, additional sizing, bushings, cutting may be required due to OE exhaust design, # 3 bushing may be required.	645357 ②③ -- -- --	608226③ -- -- --
1997	6	3.8L	Models w/4 Bolt Flange Inlet, 2nd design front pipe & conv. separate, for use with aftermarket intermediate pipe, additional sizing, bushings, cutting may be required due to OE exhaust design.	645410 ②③ -- --	608226③ -- --

☆ Air Tube kit 4948 may be required for installation.
 ② When using with aftermarket piping, direct fit converter may require INLET/OUTLET pipe resizing.
 ③ Federal & California Emissions. Not For Sale or Use on vehicles licensed in the state of CA & NY (NY vehicles with CA Emissions). Check with your state authority for details.
 ④ Federal Emissions. Not For Sale or Use on vehicles licensed in the state of CA. Check with your state authority.
 ⑤ California Emissions. Not For Sale or Use on vehicles licensed in the state of CA & NY. Check with your state authority.
 □ EPA OBDII By Design Unit
 ○ EPA Enhanced OBDII By Design Unit

APPLICATION LISTINGS

FEDERAL CONVERTERS



YR/YRS	CYL	LITER	DESCRIPTION	DIRECT FIT	UNIVERSAL
BUICK RIVIERA (Cont.)					
1996	6	3.8L	Code "1"	--	608234 ③
95-96	6	3.8L	Code "K" Eng.	642706 ③	608226 ③
91-93	6	3.8L	For use with OE intermediate pipe, additional sizing, bushings, cutting may be required due to OE exhaust design.	--	602006 ③
91-93	6	3.8L		--	--
88-90	6	3.8L	Additional sizing, bushings, cutting may be required due to OE exhaust design, two # 6 bushing may be required.	--	602204 ③
86-87	6	3.8L	For use with OE intermediate pipe, # 6 bushing may be required with aftermarket pipe.	642360 ②③	602205 ③
86-87	6	3.8L	For use with 2-3/8" I.D. aftermarket intermediate pipe.	642657 ③	602205 ③
84-85	6	3.8L	Turbo	642353 ☆③	602005 ③
81-83	6	3.8L	Turbo	642353 ☆③	602005 ③
79-80	6	3.8L	Turbo	--	602206 ③
1984	6	4.1L		642353 ☆③	602005 ③
81-83	6	4.1L		642352 ☆③	602005 ③
1995	6	All	w/Supercharged Eng., additional sizing, bushings, cutting may be required due to OE exhaust design, # 3 bushing may be required.	--	602206 ③
84-85	8	5.0L		642359 ☆③	602005 ③
81-83	8	5.0L		642352 ☆③	602005 ③
1980	8	5.7L	Code "R"	--	602205 ③
77-79	8	5.7L		--	602206 ③
77-78	8	6.6L		--	604006 ③
75-76	8	7.5L		--	604006 ③
BUICK ROADMASTER					
1991	8	5.0L	Station Wgn.	645310 ☆③	609005 ③
1991	8	5.0L	Optional Direct Fit Converter	642355 ☆③	602005 ③
95-96	8	5.7L	Right	645336 ③	608225 ③
95-96	8	5.7L	Left	645337 ③	608225 ③
1994	8	5.7L	Right	645336 ③	609005 ③
1994	8	5.7L	Left	645337 ③	609005 ③
92-93	8	5.7L	(Exc. Station Wgn.)	642355 ☆③	602005 ③
92-93	8	5.7L	Station Wgn.	645310 ☆③	609005 ③
BUICK SKYHAWK					
84-86	4	1.8L	Turbo	--	602004 ③
82-86	4	1.8L	(Exc. Turbo)	--	602003 ③
87-89	4	2.0L	Code "1", Additional sizing, bushings, cutting may be required due to OE exhaust design.	642357 ②③	602204 ③
87-88	4	2.0L	Code "K"	--	602004 ③
1987	4	2.0L	Code "M" Turbo	--	602005 ③
75-80	6	3.8L		--	602205 ③
BUICK SKYLARK					
93-95	4	2.3L		642490 ③	602215 ③
1992	4	2.3L		--	602203 ③
90-91	4	2.3L		--	602205 ③
88-89	4	2.3L	Additional sizing, bushings, cutting may be required due to OE exhaust design.	--	602205 ③
96-98	4	2.4L		642545 ③	608214 ③

☆ Air Tube kit 4948 may be required for installation.

② When using with aftermarket piping, direct fit converter may require INLET/OUTLET pipe resizing.

③ Federal & California Emissions. Not For Sale or Use on vehicles licensed in the state of CA & NY (NY vehicles with CA Emissions). Check with your state authority for details.



APPLICATION LISTINGS FEDERAL CONVERTERS

YR/YRS	CYL	LITER	DESCRIPTION	DIRECT FIT	UNIVERSAL
BUICK SKYLARK (Cont.)					
90-91	4	2.5L		642459 ③	602204 ③
90-91	4	2.5L	Optional Direct Fit Converter	--	602204 ③
86-89	4	2.5L	Additional sizing, bushings, cutting may be required due to OE exhaust design, Two # 8 bushings may be required (1 at inlet & 1 at outlet).	642357 ②③ -- --	602204 ③ -- --
82-85	4	2.5L		--	602004 ③
1981	4	2.5L		--	602003 ③
1980	4	2.5L		--	602204 ③
83-85	6	2.8L		--	602004 ③
1982	6	2.8L	Code "Z" Eng.	642395 ☆③	602005 ③
1982	6	2.8L	Code "X" Eng.	--	602004 ③
1981	6	2.8L		--	602003 ③
1980	6	2.8L		--	602204 ③
97-98	6	3.1L		642570 ③	608214 ③
1996	6	3.1L		642546 ③	608214 ③
94-95	6	3.1L		642515 ③	602214 ③
90-93	6	3.3L		642456 ③	602205 ③
86-89	6	All	Additional sizing, bushings, cutting may be required due to OE exhaust design, Two # 8 bushings may be required (1 at inlet & 1 at outlet).	642357 ②③ -- --	602204 ③ -- --
75-79	6,8	All		--	602205 ③
BUICK SOMERSET - SOMERSET REGAL					
85-87	4,6	All	Additional sizing, bushings, cutting may be required due to OE exhaust design, Two # 8 bushings may be required (1 at inlet & 1 at outlet).	642357 ②③ -- --	602204 ③ -- --
BUICK TERRAZA					
05-06	6	3.5L	FWD	643017 ③	608286 ③
2007	6	3.9L		643029 ③	608285 ③
CADILLAC ALLANTE					
87-88	8	4.1L	Additional sizing, bushings, cutting may be required due to OE exhaust design.	-- --	602006 ③ --
89-92	8	4.5L		642432 ☆③	602006 ③
1993	8	4.6L		642432 ☆③	602006 ③
CADILLAC CATERA					
97-01	6	3.0L	Right	642983 ③	608204 ③
97-01	6	3.0L	Left	642984 ③	608204 ③
CADILLAC CIMARRON					
82-86	4	All		--	602003 ③
87-88	6	2.8L	Additional sizing, bushings, cutting may be required due to OE exhaust design.	642357 ②③ -- --	602204 ③ -- --
85-86	6	2.8L		--	602204 ③
CADILLAC COMMERCIAL CHASSIS - FUNERAL COACH, LIMOUSINE					
86-87	8	4.1L	For use with OE intermediate pipe, # 6 bushing may be required with aftermarket pipe.	642360 ②③ --	602205 ③ --
86-87	8	4.1L	For use with 2-3/8" I.D. aftermarket intermediate pipe.	642657 ③	602205 ③
88-90	8	4.5L	w/Air Tube, additional sizing, bushings, cutting may be required due to OE exhaust design.	642640 ☆②③ --	609006 ③ --

☆ Air Tube kit 4948 may be required for installation.

② When using with aftermarket piping, direct fit converter may require INLET/OUTLET pipe resizing.

③ Federal & California Emissions. Not For Sale or Use on vehicles licensed in the state of CA & NY (NY vehicles with CA Emissions). Check with your state authority for details.

APPLICATION LISTINGS

FEDERAL CONVERTERS



YR/YRS	CYL	LITER	DESCRIPTION	DIRECT FIT	UNIVERSAL
CADILLAC COMMERCIAL CHASSIS - FUNERAL COACH, LIMOUSINE (Cont.)					
88-90	8	4.5L	w/o Air Tube	642386 ③	602206 ③
1992	8	4.9L	Large Body for sound control, additional sizing, bushings, cutting may be required due to OE exhaust design.	645375 ☆②③	609006 ③
				--	--
94-95	8	5.7L	Code "P", Left	645337 ③	609005 ③
94-95	8	5.7L	Code "P", Right	645336 ③	609005 ③
81-84	8	6.0L		--	605005 ③
1980	8	6.0L		--	604006 ③
77-79	8	7.0L		--	604006 ③
1993	8	All		645310 ☆③	602206 ③
CADILLAC CTS					
05-07	6	2.8L	Right Side	642142 ③	--
05-07	6	2.8L	Left Side	642143 ③	--
03-04	6	3.2L	Right, (Exc. Towing Package)	642200 ③	608265 ③
03-04	6	3.2L	Left, (Exc. Towing Package)	642199 ③	608265 ③
08-11	6	3.6L	RWD, Right	642105 ③	--
08-11	6	3.6L	RWD, Left	642095 ③	--
04-07	6	3.6L	Right Side	642142 ③	608285 ③
04-07	6	3.6L	Left Side	642143 ③	608285 ③
CADILLAC DEVILLE					
81-82	6	4.1L		642352 ☆③	602005 ③
1980	6	4.1L		--	602206 ③
86-87	8	4.1L	For use with OE intermediate pipe, w/o Air Tube, # 6 bushing may be required with aftermarket pipe.	642360 ②③	602205 ③
				--	--
86-87	8	4.1L	For use with 2-3/8" I.D. aftermarket intermediate pipe.	642657 ③	602205 ③
1985	8	4.1L		642395 ③	602005 ③
1984	8	4.1L		642359 ☆③	602005 ③
82-83	8	4.1L		642352 ☆③	602005 ③
88-90	8	4.5L	Large Body for sound control, additional sizing, bushings, cutting may be required due to OE exhaust design, # 3 bushing may be required.	645375 ☆②③	609006 ③
				--	--
				--	--
00-05	8	4.6L	Use w/OE Pipe, Includes Resonator	645979 ③	--
00-05	8	4.6L	For use with Aftermarket pipes, additional sizing, bushings, cutting may be required due to OE exhaust design.	645288 ③	608227 ③
				--	--
96-99	8	4.6L	For use with O.E. Piping, additional sizing, bushings, cutting may be required due to OE exhaust design.	642565 ②③	608226 ③
				--	--
94-95	8	4.6L	Additional sizing, bushings, cutting may be required due to OE exhaust design.	642432 ☆②③	602006 ③
				--	--
94-95	8	4.9L	For use with OE intermediate pipe, additional sizing, bushings, cutting may be required due to OE exhaust design.	642571 ②③	602206 ③
				--	--
94-95	8	4.9L		642774 ②③	602206 ③
92-93	8	4.9L	For use with OE pipes, additional sizing, bushings, cutting may be required due to OE exhaust design.	642386 ②③	602206 ③
				--	--
92-93	8	4.9L	For use with Aftermarket pipes, additional sizing, bushings, cutting may be required due to OE exhaust design.	--	602206 ③
				--	--
1991	8	4.9L	Additional sizing, bushings, cutting may be required due to OE exhaust design, # 3 bushing may be required on inlet w/aftermarket pipe.	642555 ②③	602206 ③
				--	--
				--	--

☆ Air Tube kit 4948 may be required for installation.

② When using with aftermarket piping, direct fit converter may require INLET/OUTLET pipe resizing.

③ Federal & California Emissions. Not For Sale or Use on vehicles licensed in the state of CA & NY (NY vehicles with CA Emissions). Check with your state authority for details.



APPLICATION LISTINGS FEDERAL CONVERTERS

YR/YRS	CYL	LITER	DESCRIPTION	DIRECT FIT	UNIVERSAL
CADILLAC DEVILLE (Cont.)					
80-81	8	6.0L		--	604005③
77-79	8	7.0L		--	604006③
CADILLAC DTS					
06-11	8	4.6L	Includes Resonator	645979 ③ ²⁴²	--
CADILLAC ELDORADO					
81-82	6	4.1L		642352 ☆③	602005③
86-87	8	4.1L	Additional sizing, bushings, cutting may be required due to OE exhaust design, # 6 bushing may be required.	642395 ②③	602005③
84-85	8	4.1L		--	609005③
82-83	8	4.1L		642352 ☆③	602005③
1990	8	4.5L	For use with OE intermediate pipe, additional sizing, bushings, cutting may be required due to OE exhaust design.	642432 ☆②③	602006③
1990	8	4.5L		642775 ☆②③	602006③
88-89	8	4.5L	Additional sizing, bushings, cutting may be required due to OE exhaust design, # 3 bushing may be required.	--	602006③
96-99	8	4.6L	For use with OE pipes, additional sizing, bushings, cutting may be required due to OE exhaust design.	642565 ②③	608226③
93-95	8	4.6L	For use with OE intermediate pipe, additional sizing, bushings, cutting may be required due to OE exhaust design.	642432 ☆②③	602006③
93-95	8	4.6L		642775 ☆②③	602006③
1993	8	4.9L	For use with OE pipes, additional sizing, bushings, cutting may be required due to OE exhaust design.	642571 ②③	602206③
1993	8	4.9L		642774 ②③	602206③
91-92	8	4.9L	For use with OE pipes, additional sizing, bushings, cutting may be required due to OE exhaust design.	642432 ☆②③	602006③
91-92	8	4.9L		642775 ☆②③	602006③
79-80	8	5.7L		--	602206③
80-81	8	6.0L		--	605005③
77-78	8	7.0L		--	604006③
CADILLAC ESCALADE					
02-05	8	5.3L	Dual Convs.	645988 ③④	--
			Dual Convs.	645236 ③	608216③
99-00	8	5.7L	Dual Convs.	645328 ③	608235③
04-06	8	6.0L	Right	645448 ③	608216③
04-06	8	6.0L	Left	645844 ③	608216③
02-03	8	6.0L	Right	645448 ③	608216③
02-03	8	6.0L	Left	645844 ③	608216③
07-10	8	6.2L	AWD, Federal Tier 2 Emissions	645291 ④	--
CADILLAC FLEETWOOD					
81-82	6	4.1L		642352 ☆③	602005③
1980	6	4.1L		--	602206③
86-87	8	4.1L	For use with OE intermediate pipe, #6 bushing may be required with aftermarket pipe.	642360 ②③	602205③
86-87	8	4.1L	Optional Conv. w/Air Tube, additional sizing, bushings, cutting may be required due to OE exhaust design.	642640 ☆②③	602005③
86-87	8	4.1L	For use with 2-3/8" I.D. aftermarket intermediate pipe.	642657 ③	602205③
82-83	8	4.1L		642352 ☆③	602005③

④ Discontinued, use until inventory is depleted.

☆ Air Tube kit 4948 may be required for installation.

²⁴² The O.E. system must be cut off 16" behind the rear resonator weld.

② When using with aftermarket piping, direct fit converter may require INLET/OUTLET pipe resizing.

③ Federal & California Emissions. Not For Sale or Use on vehicles licensed in the state of CA & NY (NY vehicles with CA Emissions). Check with your state authority for details.

④ Federal Emissions. Not For Sale or Use on vehicles licensed in the state of CA. Check with your state authority.

APPLICATION LISTINGS

FEDERAL CONVERTERS



YR/YRS	CYL	LITER	DESCRIPTION	DIRECT FIT	UNIVERSAL
CADILLAC FLEETWOOD (Cont.)					
88-90	8	4.5L	Additional sizing, bushings, cutting may be required due to OE exhaust design, # 3 bushing may be required.	642640 ☆②③	609006③
1992	8	4.9L	Large Body for sound control, additional sizing, bushings, cutting may be required due to OE exhaust design, # 3 bushing may be required.	645375 ☆②③	609006③
1991	8	4.9L	Additional sizing, bushings, cutting may be required due to OE exhaust design, # 3 bushing may be required on inlet w/aftermarket pipe.	642555 ②③	602206③
1986	8	5.0L		645310 ☆③	609005③
1996	8	5.7L	Right	645336 ③	608225③
1996	8	5.7L	Left	645337 ③	608225③
94-95	8	5.7L	Right	645336 ③	609005③
94-95	8	5.7L	Left	645337 ③	609005③
1993	8	5.7L		645310 ☆③	609005③
80-84	8	6.0L		--	605005③
77-79	8	7.0L		--	604006③
CADILLAC SEVILLE					
81-82	6	4.1L		642352 ☆③	602005③
86-87	8	4.1L	Additional sizing, bushings, cutting may be required due to OE exhaust design, # 6 bushing may be required.	642395 ②③	602005③
84-85	8	4.1L		--	609005③
82-83	8	4.1L		642352 ☆③	602005③
1990	8	4.5L	For use with OE pipes, additional sizing, bushings, cutting may be required due to OE exhaust design.	642432 ☆②③	602006③
1990	8	4.5L		642775 ☆②③	602006③
88-89	8	4.5L	Additional sizing, bushings, cutting may be required due to OE exhaust design, # 3 bushing may be required.	--	602006③
98-03	8	4.6L	STS Models, Conv. Unit includes Resonator, Use With OE Center Pipe	645999 ③	608226③
96-97	8	4.6L	For use with OE pipes, additional sizing, bushings, cutting may be required due to OE exhaust design.	642565 ②③	608226③
1995	8	4.6L	Additional sizing, bushings, cutting may be required due to OE exhaust design.	642432 ☆②③	602006③
93-94	8	4.6L	For use with OE intermediate pipe, additional sizing, bushings, cutting may be required due to OE exhaust design.	642432 ☆②③	602006③
93-94	8	4.6L		642775 ☆②③	602006③
1993	8	4.9L	For use with OE intermediate pipe, additional sizing, bushings, cutting may be required due to OE exhaust design.	642571 ②③	602206③
1993	8	4.9L		642774 ②③	602206③
91-92	8	4.9L	For use with OE intermediate pipe, additional sizing, bushings, cutting may be required due to OE exhaust design.	642432 ☆②③	602006③
91-92	8	4.9L		642775 ☆②③	602006③
79-80	8	5.7L		--	602206③
77-78	8	5.7L	w/Flanged Outlet Pipe	--	602206③
76-77	8	5.7L	w/Flanged Inlet and Outlet	--	602205③
80-81	8	6.0L		--	605005③

☆ Air Tube kit 4948 may be required for installation.

② When using with aftermarket piping, direct fit converter may require INLET/OUTLET pipe resizing.

③ Federal & California Emissions. Not For Sale or Use on vehicles licensed in the state of CA & NY (NY vehicles with CA Emissions). Check with your state authority for details.



APPLICATION LISTINGS FEDERAL CONVERTERS

YR/YRS	CYL	LITER	DESCRIPTION	DIRECT FIT	UNIVERSAL
CADILLAC SRX					
2009	6	3.6L	RWD, Right	642105 ③	608265 ③
2009	6	3.6L	RWD, Left	642095 ③	608265 ③
2008	6	3.6L	Left	--	608265 ③
2008	6	3.6L	Right	--	608265 ③
04-07	6	3.6L	Right	642131 ③	--
04-07	6	3.6L	Left	642132 ③	--
07-09	8	4.6L	Right	--	608285 ③
07-09	8	4.6L	Left	--	608285 ③
04-09	8	4.6L	Manifold Unit, Front Left	641442 ③	--
04-09	8	4.6L	Manifold Unit, Front Right	641443 ③	--
CADILLAC STS					
08-11	6	3.6L	RWD, Right	642105 ③	--
08-11	6	3.6L	RWD, Left	642095 ③	--
05-07	6	3.6L	Right Side	642131 ③	--
05-07	6	3.6L	Left Side	642132 ③	--
05-10	8	4.6L	Manifold Unit, Front Left	641442 ③	--
05-10	8	4.6L	Manifold Unit, Front Right	641443 ③	--
CADILLAC XLR					
2006	8	4.4L	Right	--	608265 ③
2006	8	4.4L	Left	--	608265 ③
05-07	8	4.6L	Right	--	608265 ③
05-07	8	4.6L	Left	--	608265 ③
CHECKER MARATHON					
81-82	6	3.8L	Marathon Models	--	609005 ③
77-80	6	All		642301 ③	602206 ③
75-80	8	All		645301 ③	604006 ③
CHEVROLET ASTRO VAN					
88-90	4	2.5L		--	602205 ③
85-87	4	2.5L		--	602205 ③
00-05	6	4.3L	California Emissions	645879 ⑤	--
00-01	6	4.3L	Federal Emissions	645959 ④	608227 ④
96-99	6	4.3L		645955 ③	608227 ③
94-95	6	4.3L	(Exc. AWD)	645925 ③	609007 ③
94-95	6	4.3L	AWD	645974 ③	609007 ③
1993	6	4.3L		645316 ③	609007 ③
1992	6	4.3L	Code "Z" Eng., 2-1/2" Pipe	645341 ③	609006 ③
1992	6	4.3L	Code "W" Eng.	645316 ③	609007 ③
86-91	6	4.3L		645301 ③	609006 ③
1985	6	4.3L		642301 ③	602206 ③
CHEVROLET AVEO					
04-08	4	1.6L		642263 ③	--
09-11	6	1.6L	Rear	642021 ③	--
CHEVROLET AVEO5					
09-11	4	1.6L	Rear	642021 ③	--
07-08	4	1.6L		642263 ③	--

③ Federal & California Emissions. Not For Sale or Use on vehicles licensed in the state of CA & NY (NY vehicles with CA Emissions). Check with your state authority for details.

④ Federal Emissions. Not For Sale or Use on vehicles licensed in the state of CA. Check with your state authority.

⑤ California Emissions. Not For Sale or Use on vehicles licensed in the state of CA & NY. Check with your state authority.

APPLICATION LISTINGS

FEDERAL CONVERTERS



YR/YRS	CYL	LITER	DESCRIPTION	DIRECT FIT	UNIVERSAL
CHEVROLET BERETTA					
87-89	4	2.0L	Additional sizing, bushings, cutting may be required due to OE exhaust design.	642396 ☆②③	602204③
1996	4	2.2L		642542 ③	608204③
93-95	4	2.2L		642412 ③	602204③
93-95	4	2.2L	Optional Direct Fit Converter	--	602204③
90-92	4	2.2L	Additional sizing, bushings, cutting may be required due to OE exhaust design.	642396 ☆②③	602204③
93-94	4	2.3L		642412 ②③	602204③
93-94	4	2.3L	Optional Direct Fit Converter	--	602204③
90-92	4	2.3L	GTZ Models, Additional sizing, bushings, cutting may be required due to OE exhaust design.	--	602205③
1996	6	3.1L		642546 ③	608204③
94-95	6	3.1L	Conv. w/Front pipe	642515 ③	602204③
94-95	6	3.1L	Semi Direct Fit Conv. Must Reuse Front Pipe	--	602204③
1993	6	3.1L	Additional sizing, bushings, cutting may be required due to OE exhaust design.	642357 ②③	602204③
87-92	6	All	Additional sizing, bushings, cutting may be required due to OE exhaust design.	642396 ☆②③	602204③
CHEVROLET BLAZER FULL SIZE					
75-82	6	4.1L		642301 ③	602206③
1994	8	5.7L	Code "K" Eng., w/Conv. In Y-Pipe	645342 ③	609007③
1994	8	5.7L	(Exc. Conv. In Y-Pipe)	645316 ③	609007③
87-93	8	5.7L		645316 ③	609007③
75-78	8	6.6L	400 C.I.D.	645301 ③	604006③
83-87	8	All	(Exc. 1987, 350 C.I.D., 5.7L)	645301 ③	609006③
75-82	8	All	(Exc. 400 C.I.D.)	642301 ③	602206③
CHEVROLET BLAZER S-Series					
83-88	4	All	All	642304 ③	602205③
83-87	6	2.8L		642304 ③	602205③
01-05	6	4.3L	Complete Assembly, 2WD, 2 Dr., California Emissions, Auto Trans.	645850 ⑤	--
01-05	6	4.3L	Rear, 2WD, 2 Dr., California Emissions	--	608264⑤
01-05	6	4.3L	Complete Assembly, 4WD, 2 Dr. California Emissions, Auto Trans.	645849 ⑤	--
01-05	6	4.3L	Rear, 4WD, 2 Dr., California Emissions	--	608226⑤
01-05	6	4.3L	2 Dr., 4WD, Federal Emissions	--	608227④
00-05	6	4.3L	Front, 4WD & Auto Trans. & 4 Dr., California Emissions	--	608416⑤
00-05	6	4.3L	Rear, 4WD & Auto Trans. & 4 Dr., California Emissions	--	608227⑤
00-05	6	4.3L	Complete Assembly, 2WD, 4 Dr., California Emissions	645841 ⑤	--
00-05	6	4.3L	4WD & Auto Trans. & 4 Dr., California Emissions	645890 ⑤	--
2000	6	4.3L	Complete Assembly, 2WD, 4 Dr., Federal Emissions	645840 ④	--
2000	6	4.3L	2WD, 2 Dr., Federal Emissions	645837 ④	608227④
2000	6	4.3L	4WD & Auto Trans. & 4 Dr., Federal Emissions	645891 ④	608227④
2000	6	4.3L	4WD, 2 Dr., Federal Emissions	645836 ④	608226④
98-99	6	4.3L	Front, California Emissions	641166 ⑤	608294⑤
98-99	6	4.3L	Rear, California Emissions	642514 ⑤	608226⑤
98-99	6	4.3L	Federal Emissions	642514 ④	608226④
96-97	6	4.3L		642514 ③	608226③
1995	6	4.3L	4WD, 2 Dr.	642257 ③	608226③

☆ Air Tube kit 4948 may be required for installation.

② When using with aftermarket piping, direct fit converter may require INLET/OUTLET pipe resizing.

③ Federal & California Emissions. Not For Sale or Use on vehicles licensed in the state of CA & NY (NY vehicles with CA Emissions). Check with your state authority for details.

④ Federal Emissions. Not For Sale or Use on vehicles licensed in the state of CA. Check with your state authority.

⑤ California Emissions. Not For Sale or Use on vehicles licensed in the state of CA & NY. Check with your state authority.



APPLICATION LISTINGS FEDERAL CONVERTERS

YR/YRS	CYL	LITER	DESCRIPTION	DIRECT FIT	UNIVERSAL
CHEVROLET BLAZER S-Series (Cont.)					
1995	6	4.3L	4WD, 4 Dr.	642256 ③	608226 ③
92-94	6	4.3L	Code "W" Eng.	645356 ③	609006 ③
92-94	6	4.3L	Code "Z" Eng.	642335 ③	609006 ③
88-91	6	All		642335 ③	609006 ③
CHEVROLET C-(2WD), K-(4WD) PICKUP 1/2 TON, (Inc. SILVERADO & AVALANCHE)					
09-13	6	4.3L	Complete Assembly	645821 ③④	--
			Complete Assembly	645797 ③	--
09-13	6	4.3L	Front Right	--	608286 ③
09-13	6	4.3L	Rear Conv.	--	608216 ③
09-13	6	4.3L	Front Left	--	608286 ③
2008	6	4.3L	Federal Emissions	645459 ④	--
00-06	6	4.3L	Dual Convs. 2000 w/Flat Spot in Middle Pipe	645988 ③④	--
			Dual Convs. 2000 w/Flat Spot in Middle Pipe	645236 ③	608216 ③
99-00	6	4.3L	Dual Convs. 2000 w/o Flat Spot in Middle Pipe	645947 ③	608226 ③
96-98	6	4.3L	(Exc. Dual Conv.)	645946 ③	608227 ③
94-95	6	4.3L		645342 ③	609007 ③
1993	6	4.3L	27-1/2" Conv.	645341 ③	609006 ③
1993	6	4.3L	Closed Coupled Exhaust (Conv. welded to front pipe), (Exc. 27-1/2" Conv.)	--	609006 ③
				--	--
88-92	6	4.3L		645341 ③	609006 ③
83-86	6	All		645301 ③	604006 ③
75-82	6	All		642301 ③	602206 ③
09-13	8	4.8L	Complete Assembly	645821 ③④	--
09-13	8	4.8L	Front Right	--	608286 ③
09-13	8	4.8L	Rear Conv.	--	608216 ③
09-13	8	4.8L	Front Left	--	608286 ③
09-13	8	4.8L	Complete Assembly	645797 ③	--
07-08	8	4.8L	Exc. Classic Model, Federal Emissions	645459 ④	--
00-06	8	4.8L	Dual Convs. 2000 w/Flat Spot in Middle Pipe	645988 ③④	--
			Dual Convs. 2000 w/Flat Spot in Middle Pipe	645236 ③	608216 ③
99-00	8	4.8L	Dual Convs. 2000 w/o Flat Spot in Middle Pipe	645947 ③	608226 ③
96-99	8	5.0L	Single Conv.	645946 ③	608227 ③
94-95	8	5.0L		645342 ③	609007 ③
1993	8	5.0L	27-1/2" Conv.	645341 ③	609006 ③
1993	8	5.0L	(Exc. 27-1/2" Conv.)	--	609006 ③
88-92	8	5.0L		645341 ③	609006 ③
83-86	8	5.0L		642301 ③	602206 ③
09-13	8	5.3L	Complete Assembly	645821 ③④	--
09-13	8	5.3L	Front Right	--	608286 ③
09-13	8	5.3L	Rear Conv.	--	608216 ③
09-13	8	5.3L	Front Left	--	608286 ③
09-13	8	5.3L	Complete Assembly	645797 ③	--
07-08	8	5.3L	Exc. Classic Model, Federal Emissions	645459 ④	--
07-08	8	5.3L	Avalanche, Federal Emissions	645459 ④	--
00-06	8	5.3L	Dual Convs. 2000 w/Flat Spot in Middle Pipe	645988 ③④	--
			Dual Convs. 2000 w/Flat Spot in Middle Pipe	645236 ③	608216 ③
99-00	8	5.3L	Dual Convs. 2000 w/o Flat Spot in Middle Pipe	645947 ③	608226 ③

④ Discontinued, use until inventory is depleted.

③ Federal & California Emissions. Not For Sale or Use on vehicles licensed in the state of CA & NY (NY vehicles with CA Emissions). Check with your state authority for details.

④ Federal Emissions. Not For Sale or Use on vehicles licensed in the state of CA. Check with your state authority.

APPLICATION LISTINGS

FEDERAL CONVERTERS



YR/YRS	CYL	LITER	DESCRIPTION	DIRECT FIT	UNIVERSAL
CHEVROLET C-(2WD), K-(4WD) PICKUP 1/2 TON, (Inc. SILVERADO & AVALANCHE) (Cont.)					
96-99	8	5.7L	Single Conv.	645946 ③	608227 ③
96-99	8	5.7L	Dual Convs.	645328 ③	608235 ③
94-95	8	5.7L		645342 ③	609007 ③
1993	8	5.7L	(Exc. 26-1/4" Conv.)	--	609007 ③
92-93	8	5.7L	26-1/4" Conv.	645316 ③	609007 ③
88-91	8	5.7L		645316 ③	609007 ③
83-86	8	5.7L		645301 ③	609006 ③
07-08	8	6.0L	Exc. Classic Model, Federal Emissions	645459 ④	--
06-08	8	6.0L	Right	--	608437 ③○
06-08	8	6.0L	Left	--	608437 ③○
05-06	8	6.0L	1500HD, Right	645454 ④	--
05-06	8	6.0L	1500HD, Left	645455 ④	--
03-06	8	6.0L	SS Models, Left	645844 ③	--
03-06	8	6.0L	SS Models, Right	645448 ③	--
02-03	8	6.0L	1500HD, Right	645454 ④	--
02-03	8	6.0L	1500HD, Left	645455 ④	--
09-10	8	6.2L		645291 ③	--
90-92	8	7.4L	(Exc. 454 SS)	645316 ③	604007 ③
90-92	8	7.4L	SS Models, Right	--	604007 ③
90-92	8	7.4L	SS Models, Left	--	604007 ③
75-79	8	7.4L		645301 ③	604006 ③
75-82	8	All	(Exc. 454 C.I.D.)	642301 ③	602206 ③
CHEVROLET C-(2WD), K-(4WD) PICKUP 3/4 TON, (Inc. SILVERADO & AVALANCHE)					
75-84	6	4.1L		645301 ③	605006 ③
94-95	6	4.3L	To 8600 lbs GVW	645342 ③	609007 ③
91-93	6	4.3L	To 8600 lbs GVW, w/3" Piping	645316 ③	609007 ③
88-93	6	4.3L	To 8600 lbs GVW, w/2-1/2" Piping	645341 ③	609006 ③
85-86	6	4.3L	C2500	645301 ③	609006 ③
96-98	8	5.0L		645946 ③	608227 ③
94-95	8	5.0L	To 8600 lbs GVW	645342 ③	609007 ③
88-93	8	5.0L		645341 ③	609006 ③
83-86	8	5.0L		645301 ③	609006 ③
2000	8	5.3L	Dual Convs. 2000 w/Flat Spot in Middle Pipe	645988 ③○	--
			Dual Convs. 2000 w/Flat Spot in Middle Pipe	645236 ③	608216 ③
99-00	8	5.3L	Dual Convs. 2000 w/o Flat Spot in Middle Pipe	645947 ③	608226 ③
96-00	8	5.7L	8600 lbs GVW and Over, Front	645998 ③	608227 ③
96-00	8	5.7L	8600 lbs GVW and Over, 155.5" W.B., Rear	645828 ②③	608227 ③
96-99	8	5.7L	8600 lbs GVW and Over, 141.5" W.B., Rear	645392 ③	608227 ③
96-99	8	5.7L	8600 lbs GVW and Over, 131.5" W.B., Rear	645425 ③	608227 ③
96-98	8	5.7L	Dual Convs., to 8600 lbs GVW	645328 ③	608234 ③
94-95	8	5.7L	To 8600 lbs GVW	645342 ③	609007 ③
88-93	8	5.7L	To 8600 lbs GVW	645316 ③	604007 ③
88-93	8	5.7L	Models w/Rear Conv. behind muffler, to 8600 lbs GVW	645317 ③	604007 ③
88-93	8	5.7L	To 11000 lbs GVW	646304 ③	606007 ③
88-93	8	5.7L	Models w/Rear Conv. behind muffler, to 11000 lbs GVW	--	606007 ③
83-86	8	5.7L		645301 ③	609006 ③
11-13	8	6.0L	2500 HD, w/o Third Converter	645184 ③	--

- ① Discontinued, use until inventory is depleted.
- ② When using with aftermarket piping, direct fit converter may require INLET/OUTLET pipe resizing.
- ③ Federal & California Emissions. Not For Sale or Use on vehicles licensed in the state of CA & NY (NY vehicles with CA Emissions). Check with your state authority for details.
- ④ Federal Emissions. Not For Sale or Use on vehicles licensed in the state of CA. Check with your state authority.
- EPA Enhanced OBDII By Design Unit



APPLICATION LISTINGS FEDERAL CONVERTERS

YR/YRS	CYL	LITER	DESCRIPTION	DIRECT FIT	UNIVERSAL
CHEVROLET C-(2WD), K-(4WD) PICKUP 3/4 TON, (Inc. SILVERADO & AVALANCHE) (Cont.)					
07-09	8	6.0L	2500 HD	645778 ③	--
06-08	8	6.0L	Right	--	608437 ③○
06-08	8	6.0L	Left	--	608437 ③○
03-06	8	6.0L	2500 HD, California Emissions, Right	645783 ⑤	--
03-06	8	6.0L	2500 HD, California Emissions, Left	645782 ⑤	--
01-06	8	6.0L	2500 HD, 143.5", 153", 157.5", 167" WB, Federal Emissions, Right Side, OE System is completely welded. Additional sizing, bushings, cutting may be required.	645454 ④	--
01-06	8	6.0L	2500 HD, 143.5", 153", 157.5", 167" WB, Federal Emissions, Left Side, OE System is completely welded. Additional sizing, bushings, cutting may be required.	645455 ④	--
01-06	8	6.0L	2500 HD, 133" WB, Federal Emissions, Left Side, OE System is completely welded. Additional sizing, bushings, cutting may be required.	645455 ④	--
01-06	8	6.0L	2500 HD, 133" WB, Federal Emissions, Right Side, OE System is completely welded. Additional sizing, bushings, cutting may be required.	645473 ④	--
01-03	8	6.0L	Federal Emissions	--	606007 ④
01-03	8	6.0L	Right, California Emissions	--	604007 ⑤
01-03	8	6.0L	Left, California Emissions	--	604007 ⑤
01-02	8	6.0L	2500 HD, Incomplete Chassis, Left	645818 ③	--
01-02	8	6.0L	2500 HD, Incomplete Chassis, Right	645276 ③	--
2001	8	6.0L	143.5" W.B., Federal Emissions, Right, O.E. System is Completely Welded, Replace With Complete AP System	645272 ④	--
2001	8	6.0L	Federal Emissions, Left, O.E. System is completely welded, Replace with complete AP system	645842 ④	--
99-00	8	6.0L	Right, 6-1/2' Bed	645451 ③	--
99-00	8	6.0L	Left	645842 ③	--
99-00	8	6.0L	143.5" W.B., Right, O.E. System is Completely Welded, Replace With Complete Ap System	645272 ③	--
96-00	8	7.4L	Front, Federal Emissions	645931 ④	604006 ④
91-95	8	7.4L	To 8600 lbs GVW	645316 ③	604007 ③
91-95	8	7.4L	Models w/Rear Conv. behind muffler, to 8600 lbs GVW	645317 ③	604007 ③
91-95	8	7.4L	To 11000 lbs GVW	646304 ③	606007 ③
91-95	8	7.4L	Models w/Rear Conv. behind muffler, to 11000 lbs GVW	--	606007 ③
06-07	8	8.1L	Right	--	608437 ③○
06-07	8	8.1L	Left	--	608437 ③○
03-06	8	8.1L	2500 HD, California Emissions, Right	645783 ⑤	--
01-06	8	8.1L	2500 HD, 143.5", 153", 157.5", 167" WB, Federal Emissions, Right Side, OE System is completely welded. Additional sizing, bushings, cutting may be required.	645454 ④	--
01-06	8	8.1L	2500 HD, 143.5", 153", 157.5", 167" WB, Federal Emissions, Left Side, OE System is completely welded. Additional sizing, bushings, cutting may be required.	645455 ④	--
01-06	8	8.1L	2500 HD, 133" WB, Federal Emissions, Right Side, OE System is completely welded. Additional sizing, bushings, cutting may be required.	645473 ④	--

- ③ Federal & California Emissions. Not For Sale or Use on vehicles licensed in the state of CA & NY (NY vehicles with CA Emissions). Check with your state authority for details.
- ④ Federal Emissions. Not For Sale or Use on vehicles licensed in the state of CA. Check with your state authority.
- ⑤ California Emissions. Not For Sale or Use on vehicles licensed in the state of CA & NY. Check with your state authority.
- EPA Enhanced OBDII By Design Unit

APPLICATION LISTINGS

FEDERAL CONVERTERS



YR/YRS	CYL	LITER	DESCRIPTION	DIRECT FIT	UNIVERSAL
CHEVROLET C-(2WD), K-(4WD) PICKUP 3/4 TON, (Inc. SILVERADO & AVALANCHE) (Cont.)					
01-06	8	8.1L	2500 HD, 133" WB, Federal Emissions, Left Side, OE System is completely welded. Additional sizing, bushings, cutting may be required.	645455 ④	--
2001	8	8.1L	Right, California Emissions	--	604007 ⑤
2001	8	8.1L	Left, California Emissions	--	604007 ⑤
75-82	8	All	All	645301 ③	605006 ③
CHEVROLET C-(2WD), K-(4WD) PICKUP 1 TON, (Inc. SILVERADO)					
96-00	8	5.7L	8600 lbs GVW and Over, Front	645998 ③	608227 ③
96-00	8	5.7L	8600 lbs GVW and Over, 155.5" W.B., Rear	645828 ②③	608227 ③
96-99	8	5.7L	8600 lbs GVW and Over, 141.5" W.B., Rear	645392 ③	608227 ③
96-99	8	5.7L	8600 lbs GVW and Over, 131.5" W.B., Rear	645425 ③	608227 ③
96-97	8	5.7L	Rear	--	608226 ③
96-97	8	5.7L	Front	--	608226 ③
1986	8	5.7L	To 9000 lbs GVW	645341 ③	604006 ③
11-13	8	6.0L	3500 HD, w/o Third Converter	645184 ③	--
07-09	8	6.0L	3500 HD	645778 ③	--
06-08	8	6.0L	Right	--	608437 ③○
06-08	8	6.0L	Left	--	608437 ③○
04-06	8	6.0L	133" WB, Federal Emissions, Exc. HD Series and Cab-Chassis Models, Right Side, OE System is completely welded. Additional sizing, bushings, cutting may be required.	645473 ④	--
04-06	8	6.0L	157.5" & 167" WB, Federal Emissions, Exc. HD Series and Cab-Chassis Models, Right Side, OE System is completely welded. Additional sizing, bushings, cutting may be required.	645454 ④	--
04-06	8	6.0L	133", 157.5" & 167" WB, Federal Emissions, Exc. HD Series and Cab-Chassis Models, Left Side, OE System is completely welded. Additional sizing, bushings, cutting may be required.	645455 ④	--
03-06	8	6.0L	California Emissions, Right	645783 ⑤	--
03-06	8	6.0L	California Emissions, Left	645782 ⑤	--
01-02	8	6.0L	Federal Emissions	--	606007 ④
01-02	8	6.0L	Right, California Emissions	--	604007 ⑤
01-02	8	6.0L	Left, California Emissions	--	604007 ⑤
96-00	8	7.4L	Front, Federal Emissions	645931 ④	604006 ④
96-00	8	7.4L	Rear, Federal Emissions	--	604006 ④
96-00	8	7.4L	159.5" W.B., 15000 lbs GVW, Rear	645187 ③	--
06-07	8	8.1L	Right	--	608437 ③○
06-07	8	8.1L	Left	--	608437 ③○
04-06	8	8.1L	133" WB, Federal Emissions, Exc. HD Series and Cab-Chassis Models, Right Side, OE System is completely welded. Additional sizing, bushings, cutting may be required.	645473 ④	--
04-06	8	8.1L	157.5" & 167" WB, Federal Emissions, Exc. HD Series and Cab-Chassis Models, Right Side, OE System is completely welded. Additional sizing, bushings, cutting may be required.	645454 ④	--
04-06	8	8.1L	133", 157.5" & 167" WB, Federal Emissions, Exc. HD Series and Cab-Chassis Models, Left Side, OE System is completely welded. Additional sizing, bushings, cutting may be required.	645455 ④	--
03-06	8	8.1L	California Emissions, Right	645783 ⑤	--

- ② When using with aftermarket piping, direct fit converter may require INLET/OUTLET pipe resizing.
- ③ Federal & California Emissions. Not For Sale or Use on vehicles licensed in the state of CA & NY (NY vehicles with CA Emissions). Check with your state authority for details.
- ④ Federal Emissions. Not For Sale or Use on vehicles licensed in the state of CA. Check with your state authority.
- ⑤ California Emissions. Not For Sale or Use on vehicles licensed in the state of CA & NY. Check with your state authority.
- EPA Enhanced OBDII By Design Unit



APPLICATION LISTINGS FEDERAL CONVERTERS

YR/YRS	CYL	LITER	DESCRIPTION	DIRECT FIT	UNIVERSAL
CHEVROLET C-(2WD), K-(4WD) PICKUP 1 TON, (Inc. SILVERADO) (Cont.)					
03-06	8	8.1L	California Emissions, Left	645782 ⑤	--
2001	8	8.1L	Right, California Emissions	--	604007 ⑤
2001	8	8.1L	Left, California Emissions	--	604007 ⑤
93-95	8	All	To 12000 lbs GVW	646304 ③	606007 ③
93-95	8	All	Models w/Rear Conv. behind muffler, To 12000 lbs GVW	--	606007 ③
93-95	8	All	To 9000 lbs GVW	645316 ③	604007 ③
93-95	8	All	Models w/Rear Conv., To 9000 lbs GVW, 7.4L	645317 ③	604007 ③
88-92	8	All	To 12000 lbs GVW	646304 ③	606007 ③
88-92	8	All	Models w/Rear Conv. behind muffler, To 12000 lbs GVW	--	606007 ③
88-92	8	All	To 9000 lbs GVW	645316 ③	604007 ③
88-92	8	All	Models w/Rear Conv., To 9000 lbs GVW, 7.4L	645317 ③	604007 ③
CHEVROLET C4500 KODIAK					
03-09	8	8.1L	Front	645774 ③	--
03-09	8	8.1L	Rear	645775 ③	--
CHEVROLET CAMARO					
82-85	4	2.5L		--	602004 ③
1982	6	2.8L		--	602004 ③
93-95	6	3.4L		642433 ③	602206 ③
10-11	6	3.6L	Left	644018 ③	--
10-11	6	3.6L	Right	644019 ③	--
00-02	6	3.8L		642994 ③	608226 ③
95-99	6	3.8L		642933 ③	608235 ③
1981	6	3.8L	229 C.I.D.	642352 ☆③	602005 ③
1981	6	3.8L	231 C.I.D.	642352 ☆③	602005 ③
1980	6	3.8L	229 C.I.D.	--	602205 ③
1980	6	3.8L	231 C.I.D.	--	602005 ③
75-79	6	4.1L		--	602205 ③
83-92	6	All		642355 ☆③	602005 ③
1980	8	4.4L	Angled Conv.	642352 ☆③	602005 ③
1980	8	4.4L	Straight Conv.	642359 ☆③	602005 ③
90-92	8	5.0L	Code "E" & "F", (Exc. Dual Conv. System & 2 3/4" Ext. Pipe)	642355 ☆③	602005 ③
89-92	8	5.0L	Code "F", Left, Dual Conv. System, Additional sizing, bushings, cutting may be required due to OE exhaust design.	--	609005 ③
89-92	8	5.0L	Code "F", Right, Dual Conv. System, Additional sizing, bushings, cutting may be required due to OE exhaust design.	--	609005 ③
89-92	8	5.0L	Code "F", Complete, Dual Conv. System	--	609005 ③
86-89	8	5.0L	Code "F" & "G", (Exc. Dual Conv. System)	645307 ☆③	605007 ③
83-89	8	5.0L	Code "E" & "H"	642355 ☆③	602005 ③
84-85	8	5.0L	Code "F" & "G"	642356 ☆③	602006 ③
1983	8	5.0L	Code "7"	642356 ☆③	602006 ③
1983	8	5.0L	Code "S"	642355 ☆③	602005 ③
1982	8	5.0L	Code "7"	642355 ☆③	602005 ③
1982	8	5.0L	Code "H", Angled Conv.	--	609005 ③
1982	8	5.0L	Code "H", Straight Conv.	--	609005 ③
76-79	8	5.0L		--	602205 ③
00-02	8	5.7L	Right	645407 ③	--
00-02	8	5.7L	Left	645408 ③	--

☆ Air Tube kit 4948 may be required for installation.

③ Federal & California Emissions. Not For Sale or Use on vehicles licensed in the state of CA & NY (NY vehicles with CA Emissions). Check with your state authority for details.

⑤ California Emissions. Not For Sale or Use on vehicles licensed in the state of CA & NY. Check with your state authority.

APPLICATION LISTINGS

FEDERAL CONVERTERS



YR/YRS	CYL	LITER	DESCRIPTION	DIRECT FIT	UNIVERSAL
CHEVROLET CAMARO (Cont.)					
98-99	8	5.7L	Right	645978 ③	--
98-99	8	5.7L	Left	645374 ③	--
96-97	8	5.7L		645945 ③	608226 ③
96-97	8	5.7L	Front	645363 ③	--
1995	8	5.7L	Federal Emissions	645354 ④	609007 ④
1995	8	5.7L	Rear, California Emissions	645945 ⑤	604006 ⑤
1995	8	5.7L	Front, California Emissions	645363 ⑤	--
93-94	8	5.7L		645354 ③	609007 ③
90-92	8	5.7L	(Exc. Dual Conv. System)	645310 ☆③	609005 ③
89-92	8	5.7L	Code "8", Left, Dual Conv. System, Additional sizing, bushings, cutting may be required due to OE exhaust design.	--	609005 ③
89-92	8	5.7L	Code "8", Right, Dual Conv. System, Additional sizing, bushings, cutting may be required due to OE exhaust design.	--	609005 ③
89-92	8	5.7L	Code "8", Complete, Dual Conv. System	--	609005 ③
87-89	8	5.7L	(Exc. Dual Conv. System)	645307 ☆③	605007 ③
1981	8	5.7L	(Exc. Z28)	--	609005 ③
1981	8	5.7L	Z28 Models	--	604005 ③
75-76	8	5.7L		--	604005 ③
1981	8	All	(Exc. 5.7L)	642352 ☆③	602005 ③
1980	8	All	(Exc. 267 C.I.D.)	--	602006 ③
77-79	8	All	Z28 Models	--	604005 ③
77-79	8	All	(Exc. Z28)	--	604005 ③
CHEVROLET CAVALIER					
1982	4	1.8L		--	602003 ③
87-89	4	2.0L	Additional sizing, bushings, cutting may be required due to OE exhaust design.	642357 ②③	602204 ③
83-86	4	2.0L		--	602003 ③
03-05	4	2.2L		642730 ③	608214 ③
2002	4	2.2L	Code "F" Eng.	642730 ③	608214 ③
2002	4	2.2L	Code "4" Eng.	642924 ③	608214 ③
99-01	4	2.2L		642924 ③	608214 ③
96-98	4	2.2L		642476 ③	608204 ③
90-95	4	2.2L		642412 ③	602204 ③
90-95	4	2.2L	Optional Direct Fit Converter	--	602204 ③
99-02	4	2.4L		642572 ③	608214 ③
96-98	4	2.4L		642671 ③	608214 ③
87-89	6	2.8L	Z24 Models	--	602207 ③
87-89	6	2.8L	(Exc. Z24 Models), Additional sizing, bushings, cutting may be required due to OE exhaust design.	642357 ②③	602204 ③
85-86	6	2.8L		--	602204 ③
90-94	6	3.1L	2" Conv. Outlet Pipe, Additional sizing, bushings, cutting may be required due to OE exhaust design.	642357 ②③	602204 ③
1990	6	3.1L	3" Conv. Outlet Pipe	--	602007 ③
CHEVROLET CELEBRITY					
86-90	4	2.5L	Conv.w/o Front Pipe, w/Air Tube	642374 ☆②③	602004 ③
86-90	4	2.5L	Conv. w/Front Pipe, w/o Air Tube	642954 ③	602204 ③
82-85	4	2.5L		--	602004 ③

☆ Air Tube kit 4948 may be required for installation.

② When using with aftermarket piping, direct fit converter may require INLET/OUTLET pipe resizing.

③ Federal & California Emissions. Not For Sale or Use on vehicles licensed in the state of CA & NY (NY vehicles with CA Emissions). Check with your state authority for details.

④ Federal Emissions. Not For Sale or Use on vehicles licensed in the state of CA. Check with your state authority.

⑤ California Emissions. Not For Sale or Use on vehicles licensed in the state of CA & NY. Check with your state authority.



APPLICATION LISTINGS FEDERAL CONVERTERS

YR/YRS	CYL	LITER	DESCRIPTION	DIRECT FIT	UNIVERSAL
CHEVROLET CELEBRITY (Cont.)					
82-85	6	2.8L		--	602004③
86-90	6	All	Conv. Only	642374 ☆②③	602004③
86-89	6	All	Conv. w/Front Pipe	--	602004③
CHEVROLET CHEVETTE					
81-87	4	1.6L		--	602004③
76-80	4	All		--	602205③
CHEVROLET CITATION					
82-85	4	2.5L		--	602004③
1981	4	2.5L		--	602003③
1980	4	2.5L		--	602204③
83-85	6	2.8L	Code "W" "X" "Z" Eng.	--	602004③
1982	6	2.8L	(Exc. Code "Z" Eng.)	--	602004③
1982	6	2.8L	Code "Z" Eng.	642395 ☆③	602005③
1981	6	2.8L	X-11 Models	--	602005③
1981	6	2.8L	(Exc. X-11 Models)	--	602003③
1980	6	2.8L		--	602204③
CHEVROLET COBALT					
05-07	4	2.0L		642089 ③	--
09-10	4	2.2L	Auto Trans.	642061 ③	608265③
2009	4	2.2L		--	608265③
2008	4	2.2L	Auto Trans., Exc. PZEV California Emissions	642061 ③	608265③
06-07	4	2.2L	Auto Trans., Federal Emissions	642780 ④	608264③○
			Auto Trans., Federal Emissions	--	608215③□
2005	4	2.2L	Auto Trans.	642780 ③	608264③○
			Auto Trans.	--	608215③□
2008	4	2.4L	Auto Trans.	642061 ③	608265③
06-07	4	2.4L	Auto Trans.	642780 ③	608264③○
			Auto Trans.	--	608215③□
CHEVROLET COLORADO					
04-06	4	2.8L	Front	641216 ③	--
04-06	4	2.8L		645852 ③	608415③
07-12	4	2.9L		641339 ③	--
04-06	5	3.5L	Front	642196 ③	--
04-06	5	3.5L		645852 ③	608415③
07-12	5	3.7L	Manifold Unit, Front	641338 ③	--
09-12	8	5.3L	Left	645179 ③	--
09-12	8	5.3L	Right	645180 ③	--
CHEVROLET CORSICA					
1996	4	2.2L		642542 ③	608204③
93-95	4	2.2L		642412 ③	602004③
93-95	4	2.2L	Optional Direct Fit Converter	--	602004③
87-92	4	All	Additional sizing, bushings, cutting may be required due to OE exhaust design.	642396 ☆③	602004③
				--	--
1996	6	3.1L		642546 ③	608214③
94-95	6	3.1L	Conv. w/Front Pipe	642515 ③	602214③
1993	6	3.1L	Additional sizing, bushings, cutting may be required due to OE exhaust design.	642357 ②③	602204③
				--	--

☆ Air Tube kit 4948 may be required for installation.

② When using with aftermarket piping, direct fit converter may require INLET/OUTLET pipe resizing.

③ Federal & California Emissions. Not For Sale or Use on vehicles licensed in the state of CA & NY (NY vehicles with CA Emissions). Check with your state authority for details.

④ Federal Emissions. Not For Sale or Use on vehicles licensed in the state of CA. Check with your state authority.

□ EPA OBDII By Design Unit

○ EPA Enhanced OBDII By Design Unit

APPLICATION LISTINGS

FEDERAL CONVERTERS



YR/YRS	CYL	LITER	DESCRIPTION	DIRECT FIT	UNIVERSAL
CHEVROLET CORSICA (Cont.)					
87-92	6	All	Additional sizing, bushings, cutting may be required due to OE exhaust design.	642396 ☆③ --	602204 ③ --
CHEVROLET CORVETTE					
00-04	8	5.7L	Federal Emissions	645868 ④	608226 ④
00-04	8	5.7L	California Emissions	645856 ⑤	608226 ⑤
97-99	8	5.7L		645977 ③	--
92-96	8	5.7L	Code "P", Right	645308 ③	604007 ③
92-96	8	5.7L	Code "P", Left	645309 ③	604007 ③
1995	8	5.7L	Right	--	604007 ③
1995	8	5.7L	Left	--	604007 ③
86-91	8	5.7L	Y-Pipe Pre Cats	641900 ③	602215 ③
86-91	8	5.7L	Main Conv., (Exc. ZR1)	645307 ☆③	605007 ③
86-91	8	5.7L	Main Plus Pre Cat Eliminator	645924 ☆③	605007 ③
84-85	8	5.7L		--	609006 ③
81-82	8	5.7L		--	604005 ③
76-80	8	All		--	604005 ③
1975	8	All		--	604005 ③
CHEVROLET CRUZE					
11-15	4	1.4L	Rear	643091 ③	--
11-14	4	1.8L	Manifold Unit, Front	641449 ③	--
CHEVROLET EL CAMINO					
1984	6	3.8L	231 C.I.D.	642353 ☆③	602005 ③
83-84	6	3.8L	229 C.I.D.	642355 ☆③	602005 ③
81-83	6	3.8L	231 C.I.D.	642352 ☆③	602005 ③
81-82	6	3.8L	229 C.I.D.	642352 ☆③	602005 ③
1980	6	3.8L	229 C.I.D., Angled Conv.	642352 ☆③	602005 ③
1980	6	3.8L	229 C.I.D., Straight Conv.	642304 ③	602205 ③
1980	6	3.8L	231 C.I.D.	--	602006 ③
75-77	6	4.1L		--	602206 ③
85-87	6	4.3L		642395 ☆③	602005 ③
78-79	6	All		642352 ☆③	602005 ③
1979	8	4.4L	267 C.I.D.	642352 ☆③	602005 ③
1979	8	5.0L		--	602206 ③
1978	8	5.0L		642352 ☆③	602005 ③
76-77	8	5.0L		--	602206 ③
78-79	8	5.7L		--	602206 ③
75-77	8	5.7L		--	602206 ③
75-76	8	6.6L		--	604006 ③
1975	8	7.4L		--	604006 ③
83-87	8	All		642355 ☆③	602005 ③
81-82	8	All		642352 ☆③	602005 ③
1980	8	All		--	602006 ③
CHEVROLET EQUINOX					
10-15	4	2.4L	Rear	642042 ③	608406 ③
10-15	4	2.4L	Front	644015 ③	--
2012	6	3.0L	Front Left	641450 ③	--
10-12	6	3.0L	Rear Conv.	642041 ③	608406 ③

☆ Air Tube kit 4948 may be required for installation.

③ Federal & California Emissions. Not For Sale or Use on vehicles licensed in the state of CA & NY (NY vehicles with CA Emissions). Check with your state authority for details.

④ Federal Emissions. Not For Sale or Use on vehicles licensed in the state of CA. Check with your state authority.

⑤ California Emissions. Not For Sale or Use on vehicles licensed in the state of CA & NY. Check with your state authority.



APPLICATION LISTINGS FEDERAL CONVERTERS

YR/YRS	CYL	LITER	DESCRIPTION	DIRECT FIT	UNIVERSAL
CHEVROLET EQUINOX (Cont.)					
10-11	6	3.0L	Front Left	641325 ③	--
10-11	6	3.0L	Front Right	641326 ③	--
05-09	6	3.4L		642754 ③	608226 ③
13-15	6	3.6L	Front Left	641450 ③	--
08-09	6	3.6L	Front Conv.	642221 ③	608405 ③
08-09	6	3.6L	Rear Conv.	642220 ③	608405 ③
CHEVROLET FULL SIZE (Inc. Impala RWD, Caprice, Belair, Police, Taxi, Station Wagon)					
1984	6	3.8L	231 C.I.D.	642353 ☆③	602005 ③
83-84	6	3.8L	229 C.I.D.	642355 ☆③	602005 ③
1983	6	3.8L	231 C.I.D., California Emissions	642352 ☆⑤	602005 ⑤
1983	6	3.8L	231 C.I.D., Federal Emissions	642353 ☆④	602005 ④
77-79	6	4.1L		--	602206 ③
92-93	6	4.3L		642355 ☆③	602005 ③
85-90	6	4.3L	w/Air Tube	642395 ☆③	602005 ③
80-82	6	All	w/2-1/4" Angled Conv.	--	602005 ③
80-82	6	All	w/2-1/4" Straight Conv.	--	602005 ③
1980	6	All	w/2-1/2" Angled Conv.	--	602206 ③
91-93	8	5.0L	(Exc. Taxi & Station Wgn.)	642355 ☆③	602005 ③
91-93	8	5.0L	Taxi & Station Wgn.	645310 ☆③	609005 ③
88-90	8	5.0L	(Exc. Taxi & Station Wgn.)	642355 ☆③	602005 ③
88-90	8	5.0L	Taxi	645310 ☆③	609005 ③
88-90	8	5.0L	Station Wgn.	--	609005 ③
83-88	8	5.0L	Code "H"	642355 ☆③	602005 ③
92-95	8	5.7L	Police Car, w/GM RPO 9C-1	645307 ☆③	605007 ③
83-90	8	5.7L	(Exc. Taxi & Station Wgn.)	642355 ☆③	602005 ③
83-90	8	5.7L	Taxi & Station Wgn.	645310 ☆③	609005 ③
81-82	8	5.7L		--	609005 ③
1980	8	5.7L		--	602206 ③
75-76	8	5.7L		--	602206 ③
75-76	8	6.6L		--	604006 ③
75-76	8	7.4L		--	604006 ③
94-96	8	All	Left	645337 ③	608225 ③
94-96	8	All	Right	645336 ③	608225 ③
81-82	8	All	(Exc. 5.7L)	642352 ☆③	602005 ③
1980	8	All	(Exc. 5.7L)	--	602006 ③
77-79	8	All		--	602206 ③
CHEVROLET G -VAN 1/2 & 3/4 TON (Inc. Express Van)					
83-84	6	4.1L		642301 ③	602206 ③
75-82	6	4.1L		645301 ③	609006 ③
09-14	6	4.3L	1500	645777 ③	--
07-08	6	4.3L	1500, Right	--	608265 ③
07-08	6	4.3L	1500, Left	--	608265 ③
03-06	6	4.3L	1500, Complete Assembly	645813 ③	608416 ③
03-05	6	4.3L	2500, Complete Assembly	645813 ③	608416 ③
00-02	6	4.3L	Under 8500 lbs GVW, w/2 Bolt Outlet Flange	645896 ③	608227 ③
96-99	6	4.3L	Over 8500 lbs GVW, w/3 Bolt Outlet Flange	645882 ③	608227 ③
96-99	6	4.3L	To 8500 lbs GVW, w/3 Bolt Outlet Flange	645927 ③	608227 ③

☆ Air Tube kit 4948 may be required for installation.

③ Federal & California Emissions. Not For Sale or Use on vehicles licensed in the state of CA & NY (NY vehicles with CA Emissions). Check with your state authority for details.

④ Federal Emissions. Not For Sale or Use on vehicles licensed in the state of CA. Check with your state authority.

⑤ California Emissions. Not For Sale or Use on vehicles licensed in the state of CA & NY. Check with your state authority.

APPLICATION LISTINGS

FEDERAL CONVERTERS



YR/YRS	CYL	LITER	DESCRIPTION	DIRECT FIT	UNIVERSAL
CHEVROLET G -VAN 1/2 & 3/4 TON (Inc. Express Van) (Cont.)					
1995	6	4.3L		645350 ③	609007 ③
85-94	6	4.3L		645301 ③	609006 ③
08-13	8	4.8L	2500, Cutaway & Stripped Chassis, Left	645781 ③	--
10-11	8	4.8L	2500, Y-Pipe Unit, Exc. Cutaway & Stripped Chassis	645777 ③	--
06-10	8	4.8L	2500, Standard Passenger Van, Standard Cargo Van, Extended Cargo Van, California Emissions, Left	645779 ⑤	--
				--	--
06-10	8	4.8L	2500, Standard Passenger Van, Standard Cargo Van, Extended Cargo Van, California Emissions, Right	645780 ⑤	--
				--	--
06-09	8	4.8L	2500, Left, Federal Emissions, Body to Front	645817 ④	608407 ④
06-09	8	4.8L	2500, Right, Federal Emissions, Body to Front	645816 ④	608407 ④
03-05	8	4.8L	2500, Right Conv. 68-1/4", Federal Emissions	645853 ④	608227 ④
03-05	8	4.8L	2500, Right Conv. 60-3/4", Federal Emissions	645863 ④	608227 ④
03-05	8	4.8L	2500, Left, Federal Emissions	645862 ④	608227 ④
03-05	8	4.8L	2500, 2 Bodies, Left, California Emissions	645814 ⑤	--
03-05	8	4.8L	2500, 2 Bodies, Right, California Emissions	645815 ⑤	--
00-02	8	5.0L	Under 8500 lbs GVW	645896 ③	608227 ③
96-99	8	5.0L	w/3 Bolt Outlet Flange	645927 ③	608227 ③
1995	8	5.0L	(Exc. 146" W.B.)	645350 ③	609007 ③
87-94	8	5.0L		645301 ③	609006 ③
09-14	8	5.3L	1500	645777 ③	--
03-05	8	5.3L	1500 & 2500, Complete Assembly	645813 ③	608416 ③
2002	8	5.7L	1500, Under 8500 lbs GVW, Complete Assembly	645820 ③	--
2002	8	5.7L	1500, Under 8500 lbs GVW, Right	--	608215 ③
2002	8	5.7L	1500, Under 8500 lbs GVW, Left	--	608215 ③
01-02	8	5.7L	1500 & 2500, Over 8500 lbs GVW, Left	645811 ③	--
01-02	8	5.7L	1500 & 2500, Over 8500 lbs GVW, Right	645812 ③	--
00-02	8	5.7L	2500, Under 8500 lbs GVW	645785 ③	--
2000	8	5.7L	2500, Under 8500 lbs GVW, Right	--	608227 ③
2000	8	5.7L	2500, Under 8500 lbs GVW, Left	--	608227 ③
2000	8	5.7L	1500, Under 8500 lbs GVW	645785 ③	--
97-00	8	5.7L	2500 Over 8500 lbs GVW, Right	645996 ③	608227 ③
97-00	8	5.7L	2500 Over 8500 lbs GVW, Left	645997 ③	608227 ③
96-99	8	5.7L	Single Conv. System, W/3 Bolt Outlet Flange	645927 ③	608227 ③
96-99	8	5.7L	Dual Conv. System, Under 8500 lbs GVW, Right	645980 ③	608227 ③
96-99	8	5.7L	Dual Conv. System, Under 8500 lbs GVW, Left	645981 ③	608227 ③
1995	8	5.7L	2500, (Exc. 146" W.B.)	645350 ③	609007 ③
92-94	8	5.7L	Over 9000 lbs GVW	646304 ③	606007 ③
92-94	8	5.7L	Models w/Rear Conv. behind muffler, Over 9000 lbs GVW	--	606007 ③
92-94	8	5.7L	To 9000 lbs GVW	645316 ③	604007 ③
92-94	8	5.7L	Models w/Rear Conv. behind muffler, To 9000 lbs GVW	645317 ③	604007 ③
87-91	8	5.7L	Over 9000 lbs GVW	646304 ③	606007 ③
87-91	8	5.7L	Models w/Rear Conv. behind muffler, Over 9000 lbs GVW	--	606007 ③
87-91	8	5.7L	To 9000 lbs GVW	645316 ③	604007 ③
87-91	8	5.7L	Models w/Rear Conv., To 9000 lbs GVW	645317 ③	604007 ③
75-76	8	5.7L	w/Conv.	642301 ③	602206 ③
08-13	8	6.0L	2500, Cutaway & Stripped Chassis, Left	645781 ③	--
11-12	8	6.0L	2500, Complete Assembly	645819 ③	--

③ Federal & California Emissions. Not For Sale or Use on vehicles licensed in the state of CA & NY (NY vehicles with CA Emissions). Check with your state authority for details.
 ④ Federal Emissions. Not For Sale or Use on vehicles licensed in the state of CA. Check with your state authority.
 ⑤ California Emissions. Not For Sale or Use on vehicles licensed in the state of CA & NY. Check with your state authority.



APPLICATION LISTINGS FEDERAL CONVERTERS

YR/YRS	CYL	LITER	DESCRIPTION	DIRECT FIT	UNIVERSAL
CHEVROLET G -VAN 1/2 & 3/4 TON (Inc. Express Van) (Cont.)					
10-11	8	6.0L	2500, Y-Pipe Unit, Exc. Cutaway & Stripped Chassis	645777 ③	--
06-10	8	6.0L	2500, Standard Passenger Van, Standard Cargo Van, Extended Cargo Van, California Emissions, Left	645779 ⑤	--
06-10	8	6.0L	2500, Standard Passenger Van, Standard Cargo Van, Extended Cargo Van, California Emissions, Right	645780 ⑤	--
06-09	8	6.0L	2500, Left, Federal Emissions, Body to Front	645817 ④	608407 ④
06-09	8	6.0L	2500, Right, Federal Emissions, Body to Front	645816 ④	608407 ④
03-05	8	6.0L	2500, Right Conv. 68-1/4", Federal Emissions	645853 ④	608227 ④
03-05	8	6.0L	2500, Right Conv. 60-3/4", Federal Emissions	645863 ④	608227 ④
03-05	8	6.0L	2500, Left, Federal Emissions	645862 ④	608227 ④
03-05	8	6.0L	2500, 2 Bodies, Left, California Emissions	645814 ⑤	--
03-05	8	6.0L	2500, 2 Bodies, Right, California Emissions	645815 ⑤	--
79-80	8	6.6L		645301 ③	604006 ③
83-86	8	All		645301 ③	604006 ③
79-82	8	All	(Exc. 400 C.I.D.)	642301 ③	602206 ③
CHEVROLET G -VAN 1 TON (Inc. Express Van)					
1995	6	4.3L		--	609007 ③
91-94	6	4.3L	To 8500 lbs GVW	645301 ③	609006 ③
91-94	6	4.3L	Over 8500 lbs GVW	--	606006 ③
78-90	6	All	To 8500 lbs GVW	645301 ③	604006 ③
08-13	8	4.8L	Cutaway & Stripped Chassis, Left	645781 ③	--
10-11	8	4.8L	Y-Pipe Unit, Exc. Cutaway & Stripped Chassis	645777 ③	--
06-10	8	4.8L	Standard Passenger Van, Standard Cargo Van, Extended Cargo Van, California Emissions, Left	645779 ⑤	--
06-10	8	4.8L	Standard Passenger Van, Standard Cargo Van, Extended Cargo Van, California Emissions, Right	645780 ⑤	--
01-02	8	5.7L	Over 8500 lbs GVW, Left	645811 ③	--
01-02	8	5.7L	Over 8500 lbs GVW, Right	645812 ③	--
00-02	8	5.7L	Under 8500 lbs GVW	645785 ③	--
2000	8	5.7L	Under 8500 lbs GVW	--	608227 ③
97-00	8	5.7L	135" & 155" W.B. Over 8500 lbs GVW, Right	645996 ③	608227 ③
97-00	8	5.7L	135" & 155" W.B. Over 8500 lbs GVW, Left	645997 ③	608227 ③
1996	8	5.7L	Under 8500 lbs GVW, Right	645980 ③	608227 ③
1996	8	5.7L	Under 8500 lbs GVW, Left	645981 ③	608227 ③
1996	8	5.7L	135" & 155" W.B. Over 8500 lbs GVW, Right	645996 ③	608227 ③
1996	8	5.7L	135" & 155" W.B. Over 8500 lbs GVW, Left	645997 ③	608227 ③
1995	8	5.7L	Under 9000 lbs GVW	--	604007 ③
87-91	8	5.7L	Under 9000 lbs GVW	645316 ③	604007 ③
87-91	8	5.7L	Models w/Rear Conv. behind muffler, Under 9000 lbs GVW	645317 ③	604007 ③
87-91	8	5.7L	Over 9000 lbs GVW	646304 ③	606007 ③
87-91	8	5.7L	Models w/Rear Conv. behind muffler, Over 9000 lbs GVW	--	606007 ③
80-86	8	5.7L		645301 ③	604006 ③
08-13	8	6.0L	Cutaway & Stripped Chassis, Left	645781 ③	--
11-12	8	6.0L	135" and 155" W.B., Complete Assembly	645819 ③	--
10-11	8	6.0L	Y-Pipe Unit, Exc. Cutaway & Stripped Chassis	645777 ③	--
06-10	8	6.0L	Standard Passenger Van, Standard Cargo Van, Extended Passenger Van, Extended Cargo Van, California Emissions, Left	645779 ⑤	--

③ Federal & California Emissions. Not For Sale or Use on vehicles licensed in the state of CA & NY (NY vehicles with CA Emissions). Check with your state authority for details.

④ Federal Emissions. Not For Sale or Use on vehicles licensed in the state of CA. Check with your state authority.

⑤ California Emissions. Not For Sale or Use on vehicles licensed in the state of CA & NY. Check with your state authority.

APPLICATION LISTINGS

FEDERAL CONVERTERS



YR/YRS	CYL	LITER	DESCRIPTION	DIRECT FIT	UNIVERSAL
CHEVROLET G -VAN 1 TON (Inc. Express Van) (Cont.)					
06-10	8	6.0L	Standard Passenger Van, Standard Cargo Van, Extended Passenger Van, Extended Cargo Van, California Emissions, Right	645780 ⑤ --	-- --
06-09	8	6.0L	Left, Federal Emissions, Body to Front	645817 ④	608407 ④
06-09	8	6.0L	Right, Federal Emissions, Body to Front	645816 ④	608407 ④
03-05	8	6.0L	Right, 60-3/4", Federal Emissions	645863 ④	608227 ④
03-05	8	6.0L	Right, 68-1/4", Federal Emissions	645853 ④	608227 ④
03-05	8	6.0L	Left, Federal Emissions	645862 ④	608227 ④
03-05	8	6.0L	2 Bodies, Left, California Emissions	645814 ⑤	--
03-05	8	6.0L	2 Bodies, Right, California Emissions	645815 ⑤	--
1995	8	7.4L	Under 9000 lbs GVW	--	604007 ③
92-94	8	All	Under 9000 lbs GVW	645316 ③	604007 ③
92-94	8	All	Over 9000 lbs GVW	646304 ③	606007 ③
78-79	8	All	w/Conv.	645301 ③	604006 ③
CHEVROLET HHR					
08-11	4	2.2L	Auto Trans.	642061 ③	608265 ③
06-07	4	2.2L	Auto Trans. Auto Trans.	642780 ③ --	608264 ③○ 608215 ③□
08-11	4	2.4L	Auto Trans.	642061 ③	608265 ③
2008	4	2.4L	Auto Trans.	642152 ③⑩	--
06-07	4	2.4L	Auto Trans. Auto Trans.	642780 ③ --	608264 ③○ 608215 ③□
CHEVROLET IMPALA FWD					
00-05	6	3.4L		642525 ③	608216 ③
2009	6	3.5L	Gas, Calif. Emissions (LEV2 Spec.)	642235 ⑤	608285 ⑤
06-09	6	3.5L	Flex Fuel	642235 ③	608285 ③
06-08	6	3.5L	Gas	642235 ③	608285 ③
12-13	6	3.6L	Exc. PZEV Spec, Rear	642000 ③	608266 ③
12-13	6	3.6L	Front Left	641447 ③	--
12-13	6	3.6L	Front Right	641448 ③	--
04-05	6	3.8L	Supercharged Supercharged	642583 ③ --	608416 ③○ 608216 ③□
00-05	6	3.8L	Code "K" Eng. Code "K" Eng.	642583 ③ --	608416 ③○ 608216 ③□
10-11	6	3.9L	Center	644017 ③	--
08-09	6	3.9L	Flex Fuel	642235 ③	608285 ③
06-07	6	3.9L	Gas	642235 ③	608285 ③
06-09	8	5.3L	SS	642101 ③	--
CHEVROLET LAGUNA					
75-76	8	6.6L	400 C.I.D.	--	604006 ③
75-76	8	All	(Exc. 400 C.I.D.)	--	602206 ③
CHEVROLET LLV					
94-95	4	2.2L		642471 ③	602205 ③
87-93	4	2.5L		642304 ③	602205 ③

- ⑩ Discontinued, use until inventory is depleted.
- ③ Federal & California Emissions. Not For Sale or Use on vehicles licensed in the state of CA & NY (NY vehicles with CA Emissions). Check with your state authority for details.
- ④ Federal Emissions. Not For Sale or Use on vehicles licensed in the state of CA. Check with your state authority.
- ⑤ California Emissions. Not For Sale or Use on vehicles licensed in the state of CA & NY. Check with your state authority.
- EPA OBDII By Design Unit
- EPA Enhanced OBDII By Design Unit



APPLICATION LISTINGS FEDERAL CONVERTERS

YR/YRS	CYL	LITER	DESCRIPTION	DIRECT FIT	UNIVERSAL
CHEVROLET LUMINA					
90-92	4	2.5L	For use with OE intermediate pipe, additional sizing, bushings, cutting may be required due to OE exhaust design, # 6 bushing may be required at inlet & # 8 bushing may be required at outlet for use w/aftermarket pipe.	642370 ②③ -- -- --	602205③ -- -- --
90-92	4	2.5L	For use with 2-1/8" I.D. aftermarket intermediate pipe, additional sizing, bushings, cutting may be required due to OE exhaust design.	642524 ②③ --	602205③ --
1993	4	All		--	602205③
97-01	6	3.1L		642949 ③	608214③
95-96	6	3.1L	w/Post Conv. O2 Sensor	642569 ③	608215③
94-95	6	3.1L	(Exc. w/Post Conv. O2 Sensor), 1994 small outlet flange distance between bottom holes in intermediate pipe is 2-11/16" center to center.	642474 ③ -- --	602214③ -- --
1994	6	3.1L	With large outlet flange, distance between bottom holes in intermediate pipe is 3-3/16" center to center.	642678 ③ --	609004③ --
1993	6	3.1L	California Emissions, (Exc. Methanol Fueled Vehicle)	--	602205⑤
1993	6	3.1L	Federal Emissions, (Exc. Methanol Fueled Vehicle), For use with OE intermediate pipe, additional sizing, bushings, cutting may be required due to OE exhaust design, # 6 bushing may be required at inlet & # 8 bushing may be required at outlet for use w/af	642370 ②④ -- -- --	602205④ -- -- --
1993	6	3.1L	Federal Emissions, (Exc. Methanol Fueled Vehicle), For use with 2-1/8" I.D. aftermarket intermediate pipe, additional sizing, bushings, cutting may be required due to OE exhaust design.	642524 ②④ -- --	602205④ -- --
90-92	6	3.1L	(Exc. Methanol Fueled Vehicle), For use with OE intermediate pipe, additional sizing, bushings, cutting may be required due to OE exhaust design, # 6 bushing may be required at inlet & # 8 bushing may be required at outlet for use w/aftermarket pipe.	642370 ②③ -- -- --	602205③ -- -- --
90-92	6	3.1L	(Exc. Methanol Fueled Vehicle), For use with 2-1/8" I.D. aftermarket intermediate pipe, additional sizing, bushings, cutting may be required due to OE exhaust design.	642524 ②③ -- --	602205③ -- --
1997	6	3.4L		--	608215③
1996	6	3.4L		642614 ③	608216③
91-95	6	3.4L		642509 ③	602206③
98-99	6	3.8L	Federal Emissions	642205 ④	--
98-99	6	3.8L	Federal Emissions, Front	--	608216④
98-99	6	3.8L	Federal Emissions, Rear	--	608295④
98-99	6	3.8L	California Emissions	642219 ⑤	608216⑤
CHEVROLET LUMINA APV					
93-95	6	3.1L		642972 ③	609005③
90-92	6	3.1L	Conv., w/Front Pipe	--	609005③
90-92	6	3.1L	Conv. Only	--	609005③
1996	6	3.4L		642920 ③	608226③
93-95	6	3.8L		642948 ③	609005③
CHEVROLET LUV					
76-82	4	1.8L		--	602205③

② When using with aftermarket piping, direct fit converter may require INLET/OUTLET pipe resizing.
 ③ Federal & California Emissions. Not For Sale or Use on vehicles licensed in the state of CA & NY (NY vehicles with CA Emissions). Check with your state authority for details.
 ④ Federal Emissions. Not For Sale or Use on vehicles licensed in the state of CA. Check with your state authority.
 ⑤ California Emissions. Not For Sale or Use on vehicles licensed in the state of CA & NY. Check with your state authority.

APPLICATION LISTINGS

FEDERAL CONVERTERS



YR/YRS	CYL	LITER	DESCRIPTION	DIRECT FIT	UNIVERSAL
CHEVROLET MALIBU					
04-08	4	2.2L	Manifold Unit, Front	642198 ③①	--
			Manifold Unit, Front	641343 ③	--
04-05	4	2.2L	Classic Model	642730 ③	608264 ③○
			Classic Model	--	608214 ③□
11-12	4	2.4L	Front	644013 ③	--
09-12	4	2.4L	Rear, OE exhaust system is completely welded, additional adapters or sizing and cutting of the OE pipe may be required to complete installation.	642060 ③	--
				--	--
08-10	4	2.4L	6 Speeds, Front	644013 ③	--
08-10	4	2.4L	4 Speed, Manifold Unit, Front	642198 ③	--
			4 Speed, Manifold Unit, Front	641343 ③	--
2008	4	2.4L	Rear; LS, LT, LTZ Models; OE exhaust system is completely welded, additional adapters or sizing of the OE pipe may be required to complete installation	642060 ③	--
				--	--
1999	4	2.4L		642572 ③	608214 ③
97-98	4	2.4L		642671 ③	608215 ③
98-03	6	3.1L		642547 ③	608215 ③
1997	6	3.1L		--	608215 ③
2008	6	3.5L	Classic LS, Classic LT, Front Right	644012 ③	--
2007	6	3.5L	Front Right	644012 ③	--
2007	6	3.5L	Front Conv.	--	608284 ③○
2007	6	3.5L	Rear Conv.	--	608434 ③○
05-06	6	3.5L	Front Conv.	642229 ③	608274 ③
05-06	6	3.5L	Rear Conv.	642228 ③	608294 ③
2004	6	3.5L	With No Flex Coupling in Pipe, Front Conv.	642111 ③	--
2004	6	3.5L	With No Flex Coupling in Pipe, Rear Conv.	642112 ③	--
08-09	6	3.6L	Rear	--	608414 ③○
08-09	6	3.6L	Front	--	608414 ③○
2008	6	3.6L	Front	642144 ③	--
2008	6	3.6L	Rear	642093 ③	--
1983	6	3.8L	229 C.I.D.	642355 ☆③	602005 ③
81-83	6	3.8L	231 C.I.D.	642352 ☆③	602005 ③
81-82	6	3.8L	229 C.I.D.	642352 ☆③	602005 ③
1980	6	3.8L	229 C.I.D., Angled Conv.	642352 ☆③	602005 ③
1980	6	3.8L	229 C.I.D., Straight Conv.	642304 ③	602205 ③
1980	6	3.8L	231 C.I.D.	--	602006 ③
2007	6	3.9L	Front Conv.	--	608284 ③○
2007	6	3.9L	Rear Conv.	--	608434 ③○
06-07	6	3.9L	Front Right	644012 ③	--
75-77	6	4.1L		--	602206 ③
78-79	6	All		642352 ☆③	602005 ③
1979	8	4.4L		642352 ☆③	602005 ③
1983	8	5.0L	Code "H"	642355 ☆③	602005 ③
1979	8	5.0L		--	602206 ③
1978	8	5.0L		--	602005 ③
76-77	8	5.0L		--	602206 ③
78-79	8	5.7L		--	602206 ③

① Discontinued, use until inventory is depleted.

☆ Air Tube kit 4948 may be required for installation.

③ Federal & California Emissions. Not For Sale or Use on vehicles licensed in the state of CA & NY (NY vehicles with CA Emissions). Check with your state authority for details.

□ EPA OBDII By Design Unit

○ EPA Enhanced OBDII By Design Unit



APPLICATION LISTINGS FEDERAL CONVERTERS

YR/YRS	CYL	LITER	DESCRIPTION	DIRECT FIT	UNIVERSAL
CHEVROLET MALIBU (Cont.)					
75-77	8	5.7L		--	602206③
75-76	8	6.6L		--	604006③
1975	8	7.4L		--	604006③
81-82	8	All		642352 ☆③	602005③
1980	8	All		--	602006③
CHEVROLET METRO					
98-00	3	1.0L	51-1/8" Conv., Federal Emissions	642957 ④	608294④
98-01	4	1.3L	Front, California Emissions, Includes Pipe Between Converters	641191 ⑤	--
98-01	4	1.3L	Rear, California Emissions	642300 ⑤	608294⑤
98-00	4	1.3L	51-1/8" Conv., Federal Emissions	642957 ④	608294④
CHEVROLET MONTE CARLO					
97-99	6	3.1L		642949 ③	608214③
95-96	6	3.1L	w/Post Conv. O2 Sensor	642569 ③	608215③
1995	6	3.1L	(Exc. Models w/Post Conv. O2 Sensor)	642474 ③	602214③
00-05	6	3.4L		642525 ③	608216③
1997	6	3.4L	Z34, DOHC	--	608215③
1996	6	3.4L	Z34, DOHC	642614 ③	608216③
1995	6	3.4L		642509 ③	602206③
06-07	6	3.5L		642235 ③	608414③○
04-05	6	3.8L	Supercharged	642583 ③	608416③○
			Supercharged	--	608216③□
00-05	6	3.8L	Code "K" Eng.	642583 ③	608416③○
			Code "K" Eng.	--	608216③□
98-99	6	3.8L	Federal Emissions	642205 ④	--
98-99	6	3.8L	Federal Emissions, Front	--	608216④
98-99	6	3.8L	Federal Emissions, Rear	--	608295④
98-99	6	3.8L	California Emissions	642219 ⑤	608216⑤
1984	6	3.8L	231 C.I.D.	642353 ☆③	602005③
83-84	6	3.8L	229 C.I.D.	642355 ☆③	602005③
81-83	6	3.8L	231 C.I.D., (Exc. Turbo)	642352 ☆③	602005③
81-82	6	3.8L	229 C.I.D.	642352 ☆③	602005③
1981	6	3.8L	231 C.I.D., Turbo	642353 ☆③	602005③
1980	6	3.8L	229 C.I.D., Angled Conv.	642352 ☆③	602005③
1980	6	3.8L	229 C.I.D., Straight Conv.	642304 ③	602205③
1980	6	3.8L	231 C.I.D.	--	602006③
2006	6	3.9L		642235 ③	608414③○
85-88	6	4.3L		642395 ☆③	602005③
78-79	6	All		--	602005③
1979	8	4.4L		642352 ☆③	602005③
83-88	8	5.0L	Monte Carlo SS	642356 ☆③	602006③
1979	8	5.0L		--	602206③
1978	8	5.0L		642352 ☆③	602005③
76-77	8	5.0L		--	602206③
06-07	8	5.3L		642101 ③	--
75-77	8	5.7L		--	602206③
75-76	8	6.6L		--	604006③
1975	8	7.4L		--	604006③

☆ Air Tube kit 4948 may be required for installation.

③ Federal & California Emissions. Not For Sale or Use on vehicles licensed in the state of CA & NY (NY vehicles with CA Emissions). Check with your state authority for details.

④ Federal Emissions. Not For Sale or Use on vehicles licensed in the state of CA. Check with your state authority.

⑤ California Emissions. Not For Sale or Use on vehicles licensed in the state of CA & NY. Check with your state authority.

□ EPA OBDII By Design Unit

○ EPA Enhanced OBDII By Design Unit

APPLICATION LISTINGS

FEDERAL CONVERTERS



YR/YRS	CYL	LITER	DESCRIPTION	DIRECT FIT	UNIVERSAL
CHEVROLET MONTE CARLO (Cont.)					
83-88	8	All	(Exc. Monte Carlo SS)	642355 ☆③	602005③
81-82	8	All		642352 ☆③	602005③
1980	8	All		--	602006③
CHEVROLET MONZA					
77-80	4	All		--	602205③
1976	4	All	w/A.I.R.	--	602205③
1976	4	All	(Exc. Models w/A.I.R.)	--	602205③
1975	4	All		--	602205③
1980	6	3.8L		--	602205③
75-79	6,8	All		--	602205③
CHEVROLET NOVA					
1988	4	1.6L	SOHC	642326 ☆③	602004③
1988	4	1.6L	SOHC, California Emissions	--	602004⑤
1988	4	1.6L	DOHC	642403 ③	602204③
85-87	4	1.6L		642326 ☆③	602004③
77-79	6	All	California Emissions	--	602206⑤
77-79	6	All	Federal Emissions	--	602205④
75-76	6	All		--	602205③
75-79	8	All		--	602205③
CHEVROLET P30, P30 SERIES, P30 VAN					
97-99	8	5.7L		645188 ③	--
CHEVROLET PRIZM					
98-02	4	1.8L	DOHC, 4 Dr.	642939 ③	608214③
CHEVROLET R-(2WD), V-(4WD) PICKUP					
1987	6	4.3L		645301 ③	609006③
1987	8	5.0L		645341 ③	609006③
87-89	8	5.7L	Under 9000 lbs GVW	645316 ③	609007③
87-89	8	7.4L	Over 9000 lbs GVW	646304 ③	606007③
CHEVROLET S-Series (2WD), T-Series (4WD) PICKUP					
82-84	4	1.9L		642304 ③	602205③
83-84	4	2.0L		642304 ③	602205③
96-03	4	2.2L		642543 ③	608206③
94-95	4	2.2L		642471 ③	602205③
85-93	4	2.5L		642304 ③	602205③
88-93	6	2.8L		642335 ③	602206③
82-87	6	2.8L		642304 ③	602205③
01-04	6	4.3L	4WD, 4 Dr., California Emissions	645890 ⑤	--
01-04	6	4.3L	Front, 4WD, 4 Dr., California Emissions	--	608416⑤
01-04	6	4.3L	Rear, 4WD, 4 Dr., California Emissions	--	608227⑤
01-03	6	4.3L	4WD, 3 Dr. Extended Cab, California Emissions	645889 ⑤	--
01-03	6	4.3L	RWD, Automatic Trans., With One Conv.	645806 ③	608406③
00-02	6	4.3L	RWD, Automatic Trans., With Two Convs., California Emissions	645894 ⑤	--
2000	6	4.3L	2WD	--	608226③
2000	6	4.3L	4WD, Federal Emissions	645457 ④	--
2000	6	4.3L	2WD, Extended Cab, Auto. Trans., Federal Emissions	645458 ④	--
98-99	6	4.3L	2WD & Extended Cab, California Emissions	641227 ⑤	608264⑤
98-99	6	4.3L	2WD, w/ 31 1/2" OAL Conv.	642710 ③	608226③

☆ Air Tube kit 4948 may be required for installation.

③ Federal & California Emissions. Not For Sale or Use on vehicles licensed in the state of CA & NY (NY vehicles with CA Emissions). Check with your state authority for details.

④ Federal Emissions. Not For Sale or Use on vehicles licensed in the state of CA. Check with your state authority.

⑤ California Emissions. Not For Sale or Use on vehicles licensed in the state of CA & NY. Check with your state authority.



APPLICATION LISTINGS FEDERAL CONVERTERS

YR/YRS	CYL	LITER	DESCRIPTION	DIRECT FIT	UNIVERSAL
CHEVROLET S-Series (2WD), T-Series (4WD) PICKUP (Cont.)					
96-99	6	4.3L	4WD	645372 ③	608227 ③
96-97	6	4.3L	2WD	645348 ③	608226 ③
1995	6	4.3L	4WD & Extended Cab	645347 ③	608226 ③
1995	6	4.3L	RWD	642473 ③	608226 ③
88-94	6	4.3L		642335 ③	602206 ③
CHEVROLET SILVERADO 2500 HD CLASSIC					
2007	8	6.0L	2500 HD Classic Models Only, 133" WB, Federal Emissions, Right Side, OE System is completely welded. Additional sizing, bushings, cutting may be required.	645473 ④ -- --	-- -- --
2007	8	6.0L	2500 HD Classic Models Only, 143.5", 153", 157.5", 167" WB, Federal Emissions, Right Side, OE System is completely welded. Additional sizing, bushings, cutting may be required.	645454 ④ -- --	-- -- --
2007	8	6.0L	2500 HD Classic Models Only, 133", 157.5", 167" WB, Federal Emissions, Left Side, OE System is completely welded. Additional sizing, bushings, cutting may be required.	645455 ④ -- --	-- -- --
2007	8	8.1L	2500 HD Classic Models Only, 133" WB, Federal Emissions, Right Side, OE System is completely welded. Additional sizing, bushings, cutting may be required.	645473 ④ -- --	-- -- --
2007	8	8.1L	2500 HD Classic Models Only, 143.5", 153", 157.5", 167" WB, Federal Emissions, Right Side, OE System is completely welded. Additional sizing, bushings, cutting may be required.	645454 ④ -- --	-- -- --
2007	8	8.1L	2500 HD Classic Models Only, 133", 157.5", 167" WB, Federal Emissions, Left Side, OE System is completely welded. Additional sizing, bushings, cutting may be required.	645455 ④ -- --	-- -- --
CHEVROLET SILVERADO 3500 CLASSIC					
2007	8	6.0L	Cab-Chassis Classic Models Only, 133" W.B., Federal Emissions, Right Side, OE System is completely welded. Additional sizing, bushings, cutting may be required.	645473 ④ -- --	-- -- --
2007	8	6.0L	Cab-Chassis Classic Models Only, 157.5" & 167" W.B., Federal Emissions, Right Side, OE System is completely welded. Additional sizing, bushings, cutting may be required.	645454 ④ -- --	-- -- --
2007	8	6.0L	Cab-Chassis Classic Models Only; 133", 157.5", 167" W.B., Federal Emissions, Left Side, OE system is completely welded. Additional sizing, bushings, cutting may be required.	645455 ④ -- --	-- -- --
2007	8	8.1L	Cab-Chassis Classic Models Only, 133" W.B., Federal Emissions, Right Side, OE System is completely welded. Additional sizing, bushings, cutting may be required.	645473 ④ -- --	-- -- --
2007	8	8.1L	Cab-Chassis Classic Models Only, 157.5" & 167" W.B., Federal Emissions, Right Side, OE System is completely welded. Additional sizing, bushings, cutting may be required.	645454 ④ -- --	-- -- --
2007	8	8.1L	Cab-Chassis Classic Models Only; 133", 157.5", 167" W.B., Federal Emissions, Left Side, OE system is completely welded. Additional sizing, bushings, cutting may be required.	645455 ④ -- --	-- -- --
CHEVROLET SONIC					
12-14	4	1.8L	Manifold Unit, Front	641449 ③	--
CHEVROLET SPECTRUM					
87-88	4	1.5L	Turbo	642380 ③	602206 ③
85-88	4	1.5L	Pre-Cat Conv., (Exc. Turbo)	--	602214 ③

③ Federal & California Emissions. Not For Sale or Use on vehicles licensed in the state of CA & NY (NY vehicles with CA Emissions). Check with your state authority for details.

④ Federal Emissions. Not For Sale or Use on vehicles licensed in the state of CA. Check with your state authority.

APPLICATION LISTINGS

FEDERAL CONVERTERS



YR/YRS	CYL	LITER	DESCRIPTION	DIRECT FIT	UNIVERSAL
CHEVROLET SPECTRUM (Cont.)					
85-88	4	1.5L	Main Conv., (Exc. Turbo)	--	602206 ^③
CHEVROLET SPRINT					
89-91	3	All	Manual Trans. (Canada Model)	642917 ^③	602204 ^③
87-88	3	All	Turbo	--	602204 ^③
85-88	3	All	(Exc. Turbo)	642904 ^③	602204 ^③
CHEVROLET SSR					
03-04	8	5.3L	Complete Assembly	645427 ^③	--
03-04	8	5.3L	Right	--	608265 ^③
03-04	8	5.3L	Left	--	608265 ^③
05-06	8	6.0L	Right	--	608265 ^③
05-06	8	6.0L	Left	--	608265 ^③
CHEVROLET SUBURBAN/TAHOE					
2009	8	4.8L	Complete Assembly	645821 ^{③④}	--
2009	8	4.8L	Front Right	--	608286 ^③
2009	8	4.8L	Rear Conv.	--	608216 ^③
2009	8	4.8L	Front Left	--	608286 ^③
2009	8	4.8L	Complete Assembly	645797 ^③	--
07-08	8	4.8L	Federal Emissions	645459 ^④	--
00-05	8	4.8L	Federal Emissions	645988 ^{④⑩}	--
			Federal Emissions	645236 ^③	608216 ^④
83-87	8	5.0L		645301 ^③	609006 ^③
09-14	8	5.3L	Complete Assembly	645821 ^{③④}	--
09-14	8	5.3L	Front Right	--	608286 ^③
09-14	8	5.3L	Rear Conv.	--	608216 ^③
09-14	8	5.3L	Front Left	--	608286 ^③
09-14	8	5.3L	Complete Assembly	645797 ^③	--
07-08	8	5.3L	1/2 Ton Models, Federal Emissions	645459 ^④	--
00-05	8	5.3L	Federal Emissions	645988 ^{④⑩}	--
			Federal Emissions	645236 ^③	608216 ^④
98-00	8	5.7L	1/2 Ton Models, Dual Convs., to 9200 lbs GVW, Federal Emissions	645328 ^④	608234 ^④
96-99	8	5.7L	3/4 Ton Models, Front, to 9200 lbs GVW	645998 ^③	608226 ^③
96-99	8	5.7L	3/4 Ton Models, Rear, to 9200 lbs GVW	--	608226 ^③
96-97	8	5.7L	1/2 Ton Models, Dual Convs., to 9200 lbs GVW	645328 ^③	608234 ^③
94-95	8	5.7L	To 8600 lbs GVW	645342 ^③	609007 ^③
88-93	8	5.7L	To 8600 lbs GVW	645316 ^③	604007 ^③
88-93	8	5.7L	To 11,000 lbs GVW	646304 ^③	606007 ^③
1987	8	5.7L	Fuel Injection	645316 ^③	609007 ^③
83-86	8	5.7L		645301 ^③	609006 ^③
07-08	8	6.0L	SUBURBAN 1500, Federal Emissions	645459 ^④	--
06-08	8	6.0L	SUBURBAN 2500, Right	--	608435 ^{③④}
06-08	8	6.0L	SUBURBAN 2500, Left	--	608435 ^{③④}
02-03	8	6.0L	Right, Federal Emissions	--	608235 ^④
02-03	8	6.0L	Left, Federal Emissions	--	608235 ^④
01-02	8	6.0L	3/4 Ton Models, 2WD, Left, Calif. Emissions	645842 ^⑤	--
01-02	8	6.0L	3/4 Ton Models, 2WD, Right, Calif. Emissions	645453 ^⑤	--
2000	8	6.0L	3/4 Ton Suburban, Right	645287 ^③	--
96-99	8	7.4L	3/4 Ton Models, Front	645931 ^③	604006 ^③

- ⑩ Discontinued, use until inventory is depleted.
- ③ Federal & California Emissions. Not For Sale or Use on vehicles licensed in the state of CA & NY (NY vehicles with CA Emissions). Check with your state authority for details.
- ④ Federal Emissions. Not For Sale or Use on vehicles licensed in the state of CA. Check with your state authority.
- ⑤ California Emissions. Not For Sale or Use on vehicles licensed in the state of CA & NY. Check with your state authority.
- EPA Enhanced OBDII By Design Unit



APPLICATION LISTINGS FEDERAL CONVERTERS

YR/YRS	CYL	LITER	DESCRIPTION	DIRECT FIT	UNIVERSAL
CHEVROLET SUBURBAN/TAHOE (Cont.)					
96-99	8	7.4L	3/4 Ton Models, Rear	--	604006 ^③
91-95	8	7.4L	To 8600 lbs GVW	645316 ^③	604007 ^③
91-95	8	7.4L	To 11,000 lbs GVW	646304 ^③	606007 ^③
87-89	8	7.4L	To 8600 lbs GVW	645316 ^③	604007 ^③
87-89	8	7.4L	To 11,620 lbs GVW	646304 ^③	606007 ^③
2006	8	8.1L	SUBURBAN 2500, Right	--	608435 ^{③○}
2006	8	8.1L	SUBURBAN 2500, Left	--	608435 ^{③○}
75-82	8	All		645301 ^③	605006 ^③
CHEVROLET TRACKER					
99-02	4	1.6L	Front, California Emissions	641162 ^⑤	--
98-02	4	1.6L		642595 ^③	608224 ^③
99-04	4	2.0L	Front, California Emissions	641162 ^⑤	--
99-03	4	2.0L		642595 ^③	608224 ^③
99-00	4	2.0L	Rear, California Emissions	642595 ^⑤	608224 ^⑤
01-04	6	2.5L	Rear Conv.	642139 ^③	--
01-04	6	2.5L	Front Left	641268 ^③	--
01-04	6	2.5L	Front Right	641269 ^③	--
CHEVROLET TRAILBLAZER					
08-09	6	4.2L		645185 ^③	--
06-07	6	4.2L	(Exc. Ext. Models)	645864 ^③	608206 ^③
02-05	6	4.2L	(Exc. Ext. Models)	645878 ^③	608216 ^③
06-08	8	5.3L		645186 ^③	--
06-07	8	5.3L		645265 ^③	608286 ^③
06-09	8	6.0L		645186 ^③	--
CHEVROLET TRAILBLAZER EXT					
02-05	6	4.2L		645845 ^{③○}	--
				645804 ^③	608216 ^③
05-06	8	5.3L	Center	645776 ^③	--
CHEVROLET TRAVERSE					
09-15	6	3.6L	Rear Main	642044 ^③	--
09-11	6	3.6L	Front Conv.	642125 ^③	--
09-11	6	3.6L	Rear Conv.	642126 ^③	--
CHEVROLET UPLANDER					
05-06	6	3.5L	FWD	643017 ^③	608286 ^③
07-08	6	3.9L		643029 ^③	608285 ^③
CHEVROLET VEGA					
75-77	4	All	Straight Conv.	--	602205 ^③
75-77	4	All	Angled Conv.	--	602205 ^③
CHEVROLET VENTURE					
02-05	6	3.4L	FWD	642988 ^③	608435 ^{③○}
			FWD	--	608226 ^{③□}
2001	6	3.4L		643007 ^③	608226 ^③
97-00	6	3.4L		642941 ^③	608215 ^③
CHRYSLER 300					
05-10	6	2.7L	Right, RWD	643009 ^③	608285 ^{③○}
			Right, RWD	--	608265 ^{③□}

① Discontinued, use until inventory is depleted.

② Federal & California Emissions. Not For Sale or Use on vehicles licensed in the state of CA & NY (NY vehicles with CA Emissions). Check with your state authority for details.

⑤ California Emissions. Not For Sale or Use on vehicles licensed in the state of CA & NY. Check with your state authority.

□ EPA OBDII By Design Unit

○ EPA Enhanced OBDII By Design Unit

APPLICATION LISTINGS

FEDERAL CONVERTERS



YR/YRS	CYL	LITER	DESCRIPTION	DIRECT FIT	UNIVERSAL
CHRYSLER 300 (Cont.)					
05-10	6	2.7L	Left, RWD	643010 ③	608285 ③○
			Left, RWD	--	608265 ③□
05-10	6	3.5L	Right, RWD	643009 ③	608285 ③○
			Right, RWD	--	608265 ③□
05-10	6	3.5L	Left, RWD	643010 ③	608285 ③○
			Left, RWD	--	608265 ③□
11-12	6	3.6L	Right	643067 ③	--
11-12	6	3.6L	Left	643065 ③	--
05-07	8	5.7L	Right, RWD	643018 ③	608285 ③□
			Right, RWD	--	608276 ③○
05-07	8	5.7L	Left, RWD	643019 ③	608285 ③□
			Left, RWD	--	608276 ③○
CHRYSLER 300M					
99-04	6	3.5L	Right	642846 ③	608215 ③
99-04	6	3.5L	Semi- Direct Fit, fabrication required, Right	642729 ③	608215 ③
99-04	6	3.5L	Left	642526 ③	608215 ③
CHRYSLER ASPEN					
2007	8	4.7L		645472 ③	608415 ③
CHRYSLER CIRRUS					
95-00	4	2.4L		642533 ③	608205 ③
95-00	6	2.5L		642533 ③	608205 ③
CHRYSLER CONCORDE					
02-04	6	2.7L	Right	642268 ③	608214 ③
02-04	6	2.7L	Left	642526 ③	608214 ③
98-01	6	2.7L	Semi- Direct Fit, fabrication required, Right	642527 ③	608214 ③
98-01	6	2.7L	Left	642526 ③	608214 ③
98-01	6	3.2L	Right	642258 ③	608215 ③
98-01	6	3.2L	Left	642526 ③	608215 ③
93-96	6	3.3L	Right Front, Federal Models	641140 ④	608294 ④
93-96	6	3.3L	Left Front, Federal Models	641141 ④	608294 ④
93-96	6	3.3L	For use with OE intermediate pipe, Main Conv., additional sizing, bushings, cutting may be required due to OE exhaust design.	642460 ②③	608240 ③
				--	--
93-96	6	3.3L	For use with aftermarket intermediate pipe, Main Conv., additional sizing, bushings, cutting may be required due to OE exhaust design.	642777 ②③	608240 ③
				--	--
93-96	6	3.3L	Right, California Emissions & 3 Bolt Inlet Flanges	641139 ⑤	--
93-96	6	3.3L	Left, California Emissions & 3 Bolt Inlet Flanges	641138 ⑤	--
93-96	6	3.3L	For use with OE intermediate pipe, Rear Main, California Emissions, additional sizing, bushings, cutting may be required due to OE exhaust design.	642460 ②⑤	608240 ⑤
				--	--
				--	--
93-96	6	3.3L	For use with aftermarket intermediate pipe, Rear Main, California Emissions, additional sizing, bushings, cutting may be required due to OE exhaust design.	642777 ②⑤	608240 ⑤
				--	--
				--	--
02-04	6	3.5L	Right	642258 ③	608214 ③
02-04	6	3.5L	Left	642526 ③	608214 ③
96-97	6	3.5L	Right Front	641112 ③	--
96-97	6	3.5L	Left Front	641113 ③	--

- ② When using with aftermarket piping, direct fit converter may require INLET/OUTLET pipe resizing.
- ③ Federal & California Emissions. Not For Sale or Use on vehicles licensed in the state of CA & NY (NY vehicles with CA Emissions). Check with your state authority for details.
- ④ Federal Emissions. Not For Sale or Use on vehicles licensed in the state of CA. Check with your state authority.
- ⑤ California Emissions. Not For Sale or Use on vehicles licensed in the state of CA & NY. Check with your state authority.
- EPA OBDII By Design Unit
- EPA Enhanced OBDII By Design Unit



APPLICATION LISTINGS FEDERAL CONVERTERS

YR/YRS	CYL	LITER	DESCRIPTION	DIRECT FIT	UNIVERSAL
CHRYSLER CONCORDE (Cont.)					
96-97	6	3.5L	Main Conv., additional sizing, bushings, cutting may be required due to OE exhaust design.	642415 ②③	608240③
93-95	6	3.5L	Right Front	641112 ③	--
93-95	6	3.5L	Left Front	641113 ③	--
93-95	6	3.5L	Main Conv., additional sizing, bushings, cutting may be required due to OE exhaust design.	642415 ②③	609240③
CHRYSLER CONQUEST					
87-89	4	2.6L	Turbo, Rear	--	602204③
CHRYSLER CORDOBA					
80-83	6	3.7L	Underbody	--	602004③
80-83	6	3.7L	Main Plus Pre Cat Eliminator	--	602004③
81-83	8	5.2L	Underbody	--	602005③
81-83	8	5.2L	Main Plus Pre Cat Eliminator	--	602005③
1980	8	5.2L	Right, Dual Exhaust	--	602205③
1980	8	5.2L	Left, Dual Exhaust	--	602205③
1979	8	5.2L		--	602205③
1980	8	5.9L	Right, Dual Exhaust	--	602205③
1980	8	5.9L	Left, Dual Exhaust	--	602205③
1979	8	5.9L		--	602205③
75-78	8	6.6L	400 C.I.D.	--	604005③
1980	8	All	(Exc. Models w/Lean Burn)	--	602005③
1980	8	All	California Emissions	--	602005⑤
1980	8	All	Lean Burn Models	--	604005③
75-78	8	All	(Exc. 400 C.I.D.)	--	602205③
CHRYSLER CROSSFIRE					
04-08	6	3.2L	Right, Exc. 05-06 Supercharged	642255 ③	608405③
04-08	6	3.2L	Left, Exc. 05-06 Supercharged	643016 ③	608405③
CHRYSLER DAYTONA					
87-88	4	2.2L	Turbo (Canada Model)	--	602206③
1986	4	2.2L	Turbo (Canada Model)	--	602204③
84-85	4	2.2L	Turbo (Canada Model)	--	602204③
89-93	4	2.5L	(Exc. Turbo) (Canada Model)	642320 ☆③	602004③
89-92	4	2.5L	Turbo (Canada Model)	--	602206③
CHRYSLER DYNASTY					
88-93	4	2.5L	(Canada Model)	642320 ☆③	602004③
92-93	6	3.3L	(Canada Model)	--	602005③
88-91	6	All	(Canada Model)	--	602206③
CHRYSLER E CLASS					
1984	4	2.2L	Turbo	--	602205③
1984	4	2.2L	(Exc. Turbo)	--	602004③
1983	4	2.2L		--	602004③
83-84	4	2.6L		--	602204③
CHRYSLER FIFTH AVENUE					
92-93	6	3.3L		642798 ③	602205③
1991	6	3.3L		--	602206③
1990	6	3.3L		--	602206③
1983	6	3.7L	Underbody	--	602004③

☆ Air Tube kit 4948 may be required for installation.

② When using with aftermarket piping, direct fit converter may require INLET/OUTLET pipe resizing.

③ Federal & California Emissions. Not For Sale or Use on vehicles licensed in the state of CA & NY (NY vehicles with CA Emissions). Check with your state authority for details.

⑤ California Emissions. Not For Sale or Use on vehicles licensed in the state of CA & NY. Check with your state authority.

APPLICATION LISTINGS

FEDERAL CONVERTERS



YR/YRS	CYL	LITER	DESCRIPTION	DIRECT FIT	UNIVERSAL
CHRYSLER FIFTH AVENUE (Cont.)					
92-93	6	3.8L		642798 ③	602205 ③
1991	6	3.8L		--	602206 ③
83-89	8	5.2L	Underbody	--	602004 ③
CHRYSLER IMPERIAL					
1991	6	3.3L		--	602206 ③
1990	6	3.3L	Conv. includes Resonator	642388 ③	602206 ③
92-93	6	3.8L		642798 ③	602205 ③
81-83	8	5.2L	Rear	--	602004 ③
1975	8	All	(Exc. Dual Exhaust)	--	604006 ③
1975	8	All	Right, Dual Exhaust	--	604006 ③
1975	8	All	Left, Dual Exhaust	--	604006 ③
CHRYSLER INTREPID					
93-95	6	3.3L	Right (Canada Model)	--	602294 ③
93-95	6	3.3L	Left (Canada Model)	--	602294 ③
93-95	6	3.3L	For use with OE intermediate pipe, Main Conv., additional sizing, bushings, cutting may be required due to OE exhaust design. (Canada Model)	642460 ②③	609240 ③
				--	--
				--	--
93-95	6	3.3L	For use with aftermarket intermediate pipe, Main Conv., additional sizing, bushings, cutting may be required due to OE exhaust design. (Canada Model)	642777 ②③	609240 ③
				--	--
				--	--
93-95	6	3.5L	Right (Canada Model)	--	602294 ③
93-95	6	3.5L	Left (Canada Model)	--	602294 ③
93-95	6	3.5L	Main Conv. (Canada Model)	642415 ③	609240 ③
CHRYSLER LASER					
1986	4	2.2L	Rear, Turbo	--	602205 ③
84-86	4	All	(Exc. Turbo)	642320 ☆③	602004 ③
84-85	4	All	Rear, Turbo	--	602205 ③
CHRYSLER LEBARON					
89-90	4	2.2L	Turbo, (Exc. GTS)	--	602206 ③
1989	4	2.2L	(Exc. Turbo)	642320 ☆③	602004 ③
1988	4	2.2L	4 Dr., (Exc. Turbo)	--	602004 ③
87-88	4	2.2L	Turbo 2 Dr.	--	602206 ③
87-88	4	2.2L	Turbo 4 Dr.	--	602005 ③
86-87	4	2.2L	(Exc. Turbo)	--	602004 ③
1985	4	2.2L	EFI, (Exc. Turbo)	--	602005 ③
84-85	4	2.2L	Turbo	--	602005 ③
1984	4	2.2L	TBI	--	602004 ③
82-83	4	2.2L		--	602004 ③
82-83	4	2.2L	Front	--	602004 ③
89-93	4	2.5L	(Exc. Turbo)	642320 ☆③	602004 ③
89-92	4	2.5L	Turbo, (Exc. GTS)	--	602206 ③
1988	4	2.5L	4 Dr., (Exc. Turbo)	642506 ☆③	602004 ③
1987	4	2.5L	Auto Trans., (Exc. GTS or Turbo)	642506 ☆③	602004 ③
1986	4	2.5L	Front	642506 ☆③	602004 ③
83-85	4	2.6L		--	602204 ③
1982	4	2.6L	Front	--	602204 ③
1982	4	2.6L		--	602205 ③

☆ Air Tube kit 4948 may be required for installation.

② When using with aftermarket piping, direct fit converter may require INLET/OUTLET pipe resizing.

③ Federal & California Emissions. Not For Sale or Use on vehicles licensed in the state of CA & NY (NY vehicles with CA Emissions). Check with your state authority for details.



APPLICATION LISTINGS FEDERAL CONVERTERS

YR/YRS	CYL	LITER	DESCRIPTION	DIRECT FIT	UNIVERSAL
CHRYSLER LEBARON (Cont.)					
88-89	4	All	GTS Turbo	--	602206③
92-95	6	3.0L		642576 ③	602205③
90-91	6	3.0L		--	602206③
80-81	6	3.7L	Rear, 2 Dr.	--	602004③
80-81	6	3.7L	Main Plus Pre Cat, 2 Dr.	--	602004③
80-81	6	3.7L	Rear, 4 Dr. & Station Wgn.	--	602204③
80-81	6	3.7L	4 Dr. & Station Wgn., Main Plus Pre Cat Eliminator	--	602004③
1979	6	3.7L	Underbody	--	602204③
1979	6	3.7L	Main Plus Pre Cat Eliminator	--	602004③
1978	6	3.7L	Rear	--	602204③
1978	6	3.7L	Main Plus Pre Cat Eliminator	--	602004③
1981	8	5.2L	Rear, 4 Dr. or Station Wgn.	--	602004③
1981	8	5.2L	4 Dr. & Station Wgn., Main Plus Pre Cat Eliminator	--	602004③
1980	8	5.2L	2 Dr.	--	602005③
77-78	8	5.2L		--	602205③
1978	8	5.9L	Single Exhaust	--	602205③
1978	8	5.9L	Right, Dual Exhaust	--	602205③
1978	8	5.9L	Left, Dual Exhaust	--	602205③
1979	8	All	Single Exhaust	--	602205③
1979	8	All	Right, Dual Exhaust	--	602205③
1979	8	All	Left, Dual Exhaust	--	602205③
CHRYSLER LHS					
99-01	6	3.5L	Right, Includes Pipe Between Converter and Front Muffler	642258 ③	608215③
99-01	6	3.5L	Semi- Direct Fit, fabrication required, Right	642729 ③	608215③
99-01	6	3.5L	Left	642526 ③	608215③
96-97	6	3.5L	Right Front	641112 ③	--
96-97	6	3.5L	Left Front	641113 ③	--
96-97	6	3.5L	Main Conv., additional sizing, bushings, cutting may be required due to OE exhaust design.	642415 ②③	608240③
94-95	6	3.5L	Right Front	641112 ③	--
94-95	6	3.5L	Left Front	641113 ③	--
94-95	6	3.5L	Main Conv., additional sizing, bushings, cutting may be required due to OE exhaust design.	642415 ②③	609240③
CHRYSLER NEW YORKER					
87-88	4	2.2L	Turbo	--	602206③
1986	4	2.2L		--	602205③
84-85	4	2.2L	Turbo	--	602205③
83-84	4	2.2L	(Exc. Turbo)	--	602004③
1987	4	2.5L		642506 ☆③	602004③
1986	4	2.5L		642506 ☆③	602004③
1985	4	2.6L		--	602204③
83-84	4	2.6L		--	602204③
88-90	6	3.0L	Conv. includes Resonator	642388 ③	602206③
92-93	6	3.3L		642798 ③	602205③
90-91	6	3.3L		--	602206③
1996	6	3.5L	Left Front	641113 ③	--
1996	6	3.5L	Right Front	641112 ③	--

☆ Air Tube kit 4948 may be required for installation.

② When using with aftermarket piping, direct fit converter may require INLET/OUTLET pipe resizing.

③ Federal & California Emissions. Not For Sale or Use on vehicles licensed in the state of CA & NY (NY vehicles with CA Emissions). Check with your state authority for details.

APPLICATION LISTINGS

FEDERAL CONVERTERS



YR/YRS	CYL	LITER	DESCRIPTION	DIRECT FIT	UNIVERSAL
CHRYSLER NEW YORKER (Cont.)					
1996	6	3.5L	Main Conv., additional sizing, bushings, cutting may be required due to OE exhaust design.	642415 ②③	608240③
94-95	6	3.5L	Left Front	641113 ③	--
94-95	6	3.5L	Right Front	641112 ③	--
94-95	6	3.5L	Main Conv., additional sizing, bushings, cutting may be required due to OE exhaust design.	642415 ②③	609240③
1982	6	3.7L	Underbody	--	602004③
1982	6	3.7L	Main Plus Pre Cat	--	602004③
1982	8	5.2L		--	602005③
1982	8	5.2L	Main Plus Pre Cat	--	602005③
80-81	8	5.2L	Rear	--	602205③
80-81	8	5.2L	Main Plus Pre Cat	--	602005③
1980	8	5.9L		--	602205③
77-78	8	5.9L		--	602206③
75-78	8	6.6L	(Exc. Dual Exhaust)	--	604006③
75-78	8	7.2L	(Exc. Dual Exhaust)	--	604006③
1979	8	All		--	602205③
75-76	8	All	Right, Dual Exhaust	--	604006③
75-76	8	All	Left, Dual Exhaust	--	604006③
CHRYSLER NEWPORT					
80-81	6	3.7L	Rear	--	602204③
1979	6	3.7L		--	602205③
80-81	8	5.2L	(Exc. Lean Burn)	--	602205③
80-81	8	5.2L	Lean Burn Models	--	604005③
1979	8	5.2L		--	602205③
79-80	8	5.9L		--	602205③
75-78	8	7.2L	440 C.I.D., (Exc. Dual Exhaust)	--	604005③
75-78	8	All	(Exc. 440 7.2L or Dual Exhaust)	--	604005③
75-78	8	All	Right, Dual Exhaust	--	604005③
75-78	8	All	Left, Dual Exhaust	--	604005③
CHRYSLER PACIFICA					
04-06	6	3.5L		642279 ③	608316③○
				--	608216③□
05-08	6	3.8L		642246 ③	608316③○
				--	608265③□
2007	6	4.0L	Manifold Unit, Front Right	641382 ③	--
CHRYSLER PT CRUISER					
01-10	4	2.4L	Includes Turbo	642286 ③	608316③○
			Includes Turbo	--	608215③□
CHRYSLER SEBRING					
95-99	4	2.0L	(Exc. Convertible)	642755 ③	608205③
09-10	4	2.4L	Eng. Code ED3	642231 ③	608316③
07-08	4	2.4L		642231 ③	608316③
2006	4	2.4L	Sedan & Convertible	642791 ③	608214③
04-05	4	2.4L	Sedan & Convertible Exc. PZEV Emissions	642791 ③	608214③
01-05	4	2.4L	Coupe, Front	641207 ③	--
01-05	4	2.4L	Coupe, Rear	643011 ③	608205③

② When using with aftermarket piping, direct fit converter may require INLET/OUTLET pipe resizing.

③ Federal & California Emissions. Not For Sale or Use on vehicles licensed in the state of CA & NY (NY vehicles with CA Emissions). Check with your state authority for details.

□ EPA OBDII By Design Unit

○ EPA Enhanced OBDII By Design Unit



APPLICATION LISTINGS FEDERAL CONVERTERS

YR/YRS	CYL	LITER	DESCRIPTION	DIRECT FIT	UNIVERSAL
CHRYSLER SEBRING (Cont.)					
01-03	4	2.4L	Sedan & Convertible	642791 ③	608214 ③
96-98	4	2.4L	Convertible Models	642533 ③	608205 ③
98-00	6	2.5L	Coupe, California Emissions, Front Left	641380 ⑤	--
98-00	6	2.5L	Coupe, California Emissions, Front Right	641381 ⑤	--
96-00	6	2.5L	Convertible Models	642533 ③	608205 ③
95-00	6	2.5L	Rear Manifold, (Exc. Convertible), Federal Emissions	641213 ④	--
95-00	6	2.5L	Middle Conv., (Exc. Convertible), Federal Emissions	642695 ④	--
95-00	6	2.5L	Rear, (Exc. Convertible), Federal Emissions	642700 ④	608235 ④
01-06	6	2.7L	Manifold Unit, Front	642692 ③	--
01-06	6	2.7L	Rear Manifold Conv.	642693 ③	--
01-05	6	3.0L	Front Side	641163 ③	--
01-05	6	3.0L	Rear Side	641164 ③	--
01-05	6	3.0L	Main Rear	642987 ③	608235 ③
CHRYSLER TC					
89-91	4,6	All		--	602204 ③
CHRYSLER TOWN & COUNTRY					
08-10	6	3.3L		643032 ③	608416 ③○
05-07	6	3.3L	With Stow and Go Option	642979 ③	608416 ③○
			Without Stow and Go Option	--	608316 ③□
05-07	6	3.3L	Without Stow and Go Option	642992 ③	608316 ③
01-04	6	3.3L		642992 ③	608316 ③
96-00	6	3.3L	Federal Emissions	642969 ④	608235 ④
96-00	6	3.3L	California Emissions	642967 ⑤	608235 ⑤
92-93	6	3.3L	(Exc. AWD)	642591 ③	609005 ③
92-93	6	3.3L	AWD	642932 ③	609006 ③
90-91	6	3.3L	(Exc. AWD)	642417 ③	602205 ③
11-16	6	3.6L	Front Left	641383 ③	--
11-16	6	3.6L	Front Right	641384 ③	--
08-10	6	3.8L		643032 ③	608416 ③○
05-07	6	3.8L		642979 ③	608416 ③○
				--	608316 ③□
01-04	6	3.8L		642991 ③	608316 ③
96-00	6	3.8L	Federal Emissions	642969 ④	608235 ④
96-00	6	3.8L	California Emissions	642967 ⑤	608235 ⑤
94-95	6	3.8L	(Exc. AWD)	642591 ③	609005 ③
94-95	6	3.8L	AWD	642932 ③	609006 ③
CHRYSLER VOYAGER, GRAND VOYAGER					
01-03	4	2.4L		645851 ③	608265 ③
2000	4	2.4L		642969 ③	608235 ③
2000	6	3.0L		642951 ③	608235 ③
01-03	6	3.3L		642992 ③	608316 ③
2000	6	3.3L	Federal Emissions	642969 ④	608235 ④
2000	6	3.3L	California Emissions	642967 ⑤	608235 ⑤
DAEWOO LANOS					
1999	4	1.5L		--	608234 ③
99-02	4	1.6L	Front Straight Unit	642263 ③	--
99-02	4	1.6L	Rear Conv. for Vehicles with Front Conv. with Curved Outlet	--	608204 ③

③ Federal & California Emissions. Not For Sale or Use on vehicles licensed in the state of CA & NY (NY vehicles with CA Emissions). Check with your state authority for details.

④ Federal Emissions. Not For Sale or Use on vehicles licensed in the state of CA. Check with your state authority.

⑤ California Emissions. Not For Sale or Use on vehicles licensed in the state of CA & NY. Check with your state authority.

□ EPA OBDII By Design Unit

○ EPA Enhanced OBDII By Design Unit

APPLICATION LISTINGS

FEDERAL CONVERTERS



YR/YRS	CYL	LITER	DESCRIPTION	DIRECT FIT	UNIVERSAL
DAEWOO LEGANZA					
99-02	4	2.2L	Leganza, Front	641195 ③	--
99-02	4	2.2L	Leganza, Rear	643000 ③	608205 ③
DAEWOO NUBIRA					
99-02	4	2.0L	Nubira, Front	641135 ③	--
99-02	4	2.0L	Nubira, Rear	642964 ③	608235 ③
DAIHATSU CHARADE					
89-92	3	1.0L	Rear	--	602204 ③
89-92	4	1.3L	Rear	--	602204 ③
DAIHATSU ROCKY					
90-92	4	1.6L		--	602204 ③
DELOREAN DMC 12					
81-82	6	2.9L		--	602204 ③
DODGE 2000 GTX					
89-90	4	All		642403 ③	602204 ③
DODGE ARIES, 400, 600					
1989	4	2.2L		--	602004 ③
1988	4	2.2L	Auto Trans., Built After 10/12/87, (Exc. Turbo)	642506 ☆③	602004 ③
87-88	4	2.2L	Manual Trans., (Exc. Turbo)	642506 ☆③	602004 ③
87-88	4	2.2L	Turbo	--	602206 ③
1986	4	2.2L	Manual Trans., (Exc. Turbo)	--	602004 ③
1986	4	2.2L	Turbo	--	602205 ③
1986	4	2.2L	Auto Trans., (Exc. Turbo)	--	602004 ③
1985	4	2.2L	(Exc. Turbo)	--	602004 ③
1985	4	2.2L	Turbo	--	602205 ③
1984	4	2.2L	Turbo	--	602205 ③
81-84	4	2.2L	Front, w/Air Tube, (Exc. Turbo)	--	602004 ③
81-82	4	2.2L	Rear, w/Air Tube	--	602004 ③
81-82	4	2.2L	Front, w/o Air Tube	--	602204 ③
1989	4	2.5L	Auto Trans.	642506 ☆③	602004 ③
87-88	4	2.5L		642506 ☆③	602004 ③
1986	4	2.5L		642506 ☆③	602004 ③
83-85	4	2.6L		--	602204 ③
81-82	4	2.6L		--	602204 ③
DODGE ASPEN					
1980	6	3.7L	Rear, 2 Dr.	--	602204 ③
1980	6	3.7L	2 Dr., Main Plus Pre Cat Eliminator	--	602004 ③
1980	6	3.7L	Rear, 4 Dr. or Station Wgn.	--	602204 ③
1980	6	3.7L	4 Dr. or Station Wgn., Main Plus Pre Cat Eliminator	--	602004 ③
1979	6	3.7L	Rear, 2 Dr.	--	602004 ③
1979	6	3.7L	2 Dr., Main Plus Pre Cat Eliminator	--	602004 ③
1979	6	3.7L	Rear, 4 Dr. or Station Wgn.	--	602204 ③
1979	6	3.7L	4 Dr. or Station Wgn., Main Plus Pre Cat Eliminator	--	602004 ③
1978	6	3.7L	2 Dr.	--	602205 ③
1978	6	3.7L	4 Dr. or Station Wgn.	--	602205 ③
1977	6	3.7L	2 Dr., 2-1/4" Pipe	--	602205 ③
1977	6	3.7L	2 Dr., 1-7/8" Pipe	--	602204 ③
1977	6	3.7L	4 Dr. or Station Wgn., 2-1/4" Pipe	--	602205 ③

☆ Air Tube kit 4948 may be required for installation.

③ Federal & California Emissions. Not For Sale or Use on vehicles licensed in the state of CA & NY (NY vehicles with CA Emissions). Check with your state authority for details.



APPLICATION LISTINGS FEDERAL CONVERTERS

YR/YRS	CYL	LITER	DESCRIPTION	DIRECT FIT	UNIVERSAL
DODGE ASPEN (Cont.)					
1977	6	3.7L	4 Dr. or Station Wgn., 1-7/8" Pipe	--	602204③
1976	6	3.7L	2 Dr.	--	602204③
1976	6	3.7L	4 Dr. or Station Wgn.	--	602204③
79-80	8	5.2L	2 Dr., Rear	--	602205③
79-80	8	5.2L	2 Dr., Main Plus Pre Cat Eliminator	--	602005③
79-80	8	5.2L	4 Dr. or Station Wgn., Rear	--	602205③
79-80	8	5.2L	4 Dr. or Station Wgn., Main Plus Pre Cat	--	602005③
76-78	8	5.2L	2 Dr.	--	602205③
76-78	8	5.2L	4 Dr. or Station Wgn.	--	602205③
79-80	8	5.9L	Left	--	602205③
79-80	8	5.9L	Right	--	602205③
76-78	8	5.9L	2 Dr.	--	602205③
76-78	8	5.9L	4 Dr. or Station Wgn.	--	602205③
DODGE AVENGER					
95-99	4	2.0L	DOHC	642466 ③	608204③
09-10	4	2.4L	Eng. Code ED3	642231 ③	608316③○
			Eng. Code ED3	--	608215③□
2008	4	2.4L		642231 ③	608316③○
				--	608215③□
98-00	6	2.5L	California Emissions, Front Left	641380 ⑤	--
98-00	6	2.5L	California Emissions, Front Right	641381 ⑤	--
95-00	6	2.5L	Rear Manifold Conv., Federal Emissions	641213 ④	--
95-00	6	2.5L	Middle Conv., Federal Emissions	642695 ④	--
95-00	6	2.5L	Rear, Federal Emissions	642700 ④	608235④
08-10	6	2.7L	Manifold Unit, Front	642098 ③	--
08-10	6	2.7L	Rear Manifold Conv.	642120 ③	--
11-14	6	3.6L	Front Left	641383 ③	--
11-14	6	3.6L	Front Right	641384 ③	--
DODGE B-VAN					
1987	6	3.7L		--	609004③
80-86	6	3.7L	Underbody	--	609004③
75-79	6	3.7L	2" Outlet	--	602205③
98-03	6	3.9L	w/48-3/4" Conv.	645990 ③	608240③
00-02	6	3.9L		--	608226③
95-97	6	3.9L		645938 ③	608240③
93-94	6	3.9L	From 7/93	--	609005③
			To 7/93	645322 ③	609006③
92-93	6	3.9L		645332 ③	609006③
88-91	6	3.9L		645332 ☆③	609006③
98-03	8	5.2L	w/48-3/4" Conv.	645990 ③	608240③
95-97	8	5.2L		645938 ③	608240③
80-86	8	5.2L	Underbody	--	609006③
80-86	8	5.2L	Main & Pre-Cat	--	609006③
02-03	8	5.9L	Ram 2500 Van, 3 Converter System	645792 ③	--
01-03	8	5.9L	Ram 3500 Van, 3 Converter System	645792 ③	--
98-03	8	5.9L	w/48-3/4" Conv.	645990 ③	608240③
2000	8	5.9L	Ram 2500 Van, 3 Converter System	645792 ③	--
95-97	8	5.9L	Under 8600 lbs GVW, w/53-1/4" Conv.	645938 ③	608240③

☆ Air Tube kit 4948 may be required for installation.

③ Federal & California Emissions. Not For Sale or Use on vehicles licensed in the state of CA & NY (NY vehicles with CA Emissions). Check with your state authority for details.

④ Federal Emissions. Not For Sale or Use on vehicles licensed in the state of CA. Check with your state authority.

⑤ California Emissions. Not For Sale or Use on vehicles licensed in the state of CA & NY. Check with your state authority.

□ EPA OBDII By Design Unit

○ EPA Enhanced OBDII By Design Unit

APPLICATION LISTINGS

FEDERAL CONVERTERS



YR/YRS	CYL	LITER	DESCRIPTION	DIRECT FIT	UNIVERSAL
DODGE B-VAN (Cont.)					
80-86	8	5.9L	Underbody	--	609006③
80-86	8	5.9L	Main & Pre-Cat	--	609006③
93-94	8	All	From 7/93	--	609005③
92-93	8	All	To 7/93	645322 ③	609006③
87-91	8	All		645332 ☆③	609006③
80-81	8	All	w/o Pre-Cat	--	609005③
75-79	8	All		--	605006③
DODGE CALIBER					
07-09	4	1.8L		642231 ③	608316③
07-10	4	2.0L		642231 ③	608316③○
				--	608215③□
2010	4	2.4L	Eng. Code ED3	642231 ③	608316③
08-09	4	2.4L	(Exc. Turbo)	642231 ③	608316③
07-08	4	2.4L	R/T Models, AWD, Front	641235 ③	--
07-08	4	2.4L	R/T Models, AWD, Rear	645452 ③	--
2007	4	2.4L	FWD	642231 ③	608316③
DODGE CARAVAN					
84-87	4	2.2L		--	602204③
01-07	4	2.4L		645851 ③	608265③
96-00	4	2.4L		642969 ③	608235③
91-95	4	2.5L		642521 ③	602204③
89-90	4	2.5L	(Exc. Turbo)	642521 ③	602204③
89-90	4	2.5L	Turbo	--	602205③
84-87	4	2.6L	Front	--	602204③
84-87	4	2.6L		--	602204③
1988	4	All		642521 ③	602204③
96-00	6	3.0L		642951 ③	608235③
92-95	6	3.0L		642591 ③	609005③
89-91	6	3.0L		642505 ③	602205③
87-88	6	3.0L		--	602205③
08-10	6	3.3L	Grand Caravan	643032 ③	608416③○
06-07	6	3.3L	Grand Caravan	642979 ③	608416③○
			Grand Caravan	--	608316③□
05-07	6	3.3L	Caravan	642992 ③	608316③
2005	6	3.3L	Grand Caravan with Stow and Go Option	642979 ③	608416③○
			Grand Caravan with Stow and Go Option	--	608316③□
2005	6	3.3L	Grand Caravan without Stow and Go Option	642992 ③	608316③
01-04	6	3.3L		642992 ③	608316③
96-00	6	3.3L	Federal Emissions	642969 ④	608235④
96-00	6	3.3L	California Emissions	642967 ⑤	608235⑤
94-95	6	3.3L	(Exc. AWD or Flexible Fuel)	642591 ③	609005③
1994	6	3.3L	AWD	642932 ③	609006③
92-93	6	3.3L	(Exc. AWD)	642479 ③	602205③
91-93	6	3.3L	AWD	642932 ③	609006③
90-91	6	3.3L	(Exc. AWD)	642417 ③	602205③
11-16	6	3.6L	Grand Caravan, Front Left	641383 ③	--
11-16	6	3.6L	Grand Caravan, Front Right	641384 ③	--

☆ Air Tube kit 4948 may be required for installation.

③ Federal & California Emissions. Not For Sale or Use on vehicles licensed in the state of CA & NY (NY vehicles with CA Emissions). Check with your state authority for details.

④ Federal Emissions. Not For Sale or Use on vehicles licensed in the state of CA. Check with your state authority.

⑤ California Emissions. Not For Sale or Use on vehicles licensed in the state of CA & NY. Check with your state authority.

□ EPA OBDII By Design Unit

○ EPA Enhanced OBDII By Design Unit



APPLICATION LISTINGS FEDERAL CONVERTERS

YR/YRS	CYL	LITER	DESCRIPTION	DIRECT FIT	UNIVERSAL
DODGE CARAVAN (Cont.)					
08-10	6	3.8L	Grand Caravan	643032 ③	608416 ③○
05-07	6	3.8L		642979 ③	608416 ③○
				--	608316 ③□
01-04	6	3.8L		642991 ③	608316 ③
96-00	6	3.8L	Federal Emissions	642969 ④	608235 ④
96-00	6	3.8L	California Emissions	642967 ⑤	608235 ⑤
94-95	6	3.8L	AWD	642932 ③	609006 ③
94-95	6	3.8L	(Exc. AWD or Flexible Fuel)	642591 ③	609005 ③
DODGE CHALLENGER					
78-79	4	1.6L		--	602204 ③
80-83	4	2.6L	Donut Gasket at Inlet	--	602206 ③
79-80	4	2.6L	(Exc. Donut Gasket at Inlet)	--	602294 ③
09-10	6	3.5L	Right	643009 ③	--
09-10	6	3.5L	Left	643010 ③	--
11-12	6	3.6L	Right	643067 ③	--
11-12	6	3.6L	Left	643065 ③	--
DODGE CHARGER					
1984	4	1.6L	Front	--	602004 ③
85-87	4	2.2L	(Exc. Turbo)	--	602004 ③
85-87	4	2.2L	Turbo	--	602205 ③
83-84	4	2.2L	Front	--	602004 ③
06-10	6	2.7L	Right	643009 ③	608285 ③○
			Right	--	608265 ③□
06-10	6	2.7L	Left	643010 ③	608285 ③○
			Left	--	608265 ③□
2007	6	2.7L	With Front Mini Converter, Left	643099 ③	--
2007	6	2.7L	With Front Mini Converter, Right	643100 ③	--
06-10	6	3.5L	Right	643009 ③	608285 ③○
			Right	--	608265 ③□
06-10	6	3.5L	Left	643010 ③	608285 ③○
			Left	--	608265 ③□
11-12	6	3.6L	Right	643067 ③	--
11-12	6	3.6L	Left	643065 ③	--
75-76	8	5.2L		--	602205 ③
06-07	8	5.7L	Right, RWD	643018 ③	608285 ③□
			Right, RWD	--	608276 ③○
06-07	8	5.7L	Left, RWD	643019 ③	608285 ③□
			Left, RWD	--	608276 ③○
75-76	8	5.9L		--	602205 ③
2007	8	6.1L	Left	645294 ③	--
75-78	8	6.6L	400 C.I.D.	--	604005 ③
77-78	8	All	(Exc. 400 C.I.D.)	--	602205 ③
DODGE COLT					
81-84	4	1.4L		--	602294 ③
89-91	4	1.5L		642403 ③	602204 ③
87-88	4	1.5L		642385 ③	602214 ③
85-86	4	1.5L	Rear	--	602294 ③

③ Federal & California Emissions. Not For Sale or Use on vehicles licensed in the state of CA & NY (NY vehicles with CA Emissions). Check with your state authority for details.

④ Federal Emissions. Not For Sale or Use on vehicles licensed in the state of CA. Check with your state authority.

⑤ California Emissions. Not For Sale or Use on vehicles licensed in the state of CA & NY. Check with your state authority.

□ EPA OBDII By Design Unit

○ EPA Enhanced OBDII By Design Unit

APPLICATION LISTINGS

FEDERAL CONVERTERS



YR/YRS	CYL	LITER	DESCRIPTION	DIRECT FIT	UNIVERSAL
DODGE COLT (Cont.)					
89-90	4	1.6L		642403 ③	602204 ③
87-88	4	1.6L		642385 ③	602214 ③
81-86	4	1.6L		--	602294 ③
89-90	4	1.8L		--	602204 ③
89-91	4	2.0L	Vista	642403 ③	602204 ③
87-88	4	2.0L	Vista, Built After 12/86	642403 ③	602204 ③
1987	4	2.0L	Vista, Built Before 12/86	--	602294 ③
84-86	4	2.0L	Vista	--	602294 ③
92-94	4	All	Includes Vista	642403 ③	602204 ③
DODGE CONQUEST					
84-86	4	2.6L	Turbo, Rear	--	602204 ③
DODGE CORONET					
75-76	6	3.7L		--	602204 ③
1975	8	7.2L	Right	--	604005 ③
1975	8	7.2L	Left	--	604005 ③
75-76	8	All	(Exc. 1975 w/440 C.I.D.)	--	602205 ③
DODGE D-(2WD) & W-(4WD) PICKUP 1/2 & 3/4 TON					
84-87	6	3.7L	Rear, 2WD Under 8500 lbs GVW, Federal Emissions	--	609005 ④
79-83	6	3.7L	Underbody	--	609005 ③
75-78	6	3.7L		--	602204 ③
92-93	6	3.9L	From 2/92 To 7/93	645322 ③	609006 ③
88-92	6	3.9L	To 2/92	645900 ☆③	609005 ③
92-93	8	5.2L	Under 8800 lbs GVW; From 2/92 To 7/93	645322 ③	605006 ③
86-90	8	5.2L	4WD	645366 ③	609006 ③
82-87	8	5.2L	2WD, Rear	--	605005 ③
1979	8	5.2L		--	605005 ③
92-93	8	5.9L	Under 8800 lbs GVW; From 2/92 To 7/93	645322 ③	605006 ③
88-92	8	5.9L	Under 8800 lbs GVW; To 2/92	645900 ☆③	605005 ③
88-89	8	5.9L	Over 8800 lbs GVW, Right	--	607005 ③
88-89	8	5.9L	Over 8800 lbs GVW, Left	--	607005 ③
82-87	8	5.9L	4WD	--	609006 ③
82-87	8	5.9L	2WD, Rear	--	605005 ③
1979	8	5.9L		--	605005 ③
80-81	8	All		--	605005 ③
75-78	8	All		--	605006 ③
DODGE D-(2WD) & W-(4WD) PICKUP 1 TON					
90-93	8	5.9L	To 8600 lbs GVW, Right	--	605004 ③
90-93	8	5.9L	Over 8600 lbs GVW, Right	--	607005 ③
90-93	8	5.9L	To 8600 lbs GVW, Left	--	605004 ③
90-93	8	5.9L	Over 8600 lbs GVW, Left	--	607005 ③
88-91	8	5.9L	Single exhaust	645900 ☆③	605005 ③
82-87	8	All	w/Conv.	--	605005 ③
DODGE DAKOTA					
87-88	4	2.2L		--	602204 ③
1999	4	2.5L		--	608235 ③
97-98	4	2.5L	2WD	645880 ③	608204 ③
97-98	4	2.5L	4WD	--	608235 ③

☆ Air Tube kit 4948 may be required for installation.

③ Federal & California Emissions. Not For Sale or Use on vehicles licensed in the state of CA & NY (NY vehicles with CA Emissions). Check with your state authority for details.

④ Federal Emissions. Not For Sale or Use on vehicles licensed in the state of CA. Check with your state authority.



APPLICATION LISTINGS FEDERAL CONVERTERS

YR/YRS	CYL	LITER	DESCRIPTION	DIRECT FIT	UNIVERSAL
DODGE DAKOTA (Cont.)					
1996	4	2.5L		--	608234③
93-95	4	2.5L		--	609004③
89-92	4	2.5L	(Exc. 131" W.B.)	--	602204③
89-92	4	2.5L	131" W.B.	--	602204③
06-08	6	3.7L		645428 ③	--
00-03	6	3.9L	4WD, Federal Emissions	645899 ④	608226④
00-03	6	3.9L	2WD, Federal Emissions	645859 ④	608216④
00-03	6	3.9L	Front Right, 2WD, California Emissions	--	608285⑤
00-03	6	3.9L	Rear, 2WD, California Emissions	--	608216⑤
00-03	6	3.9L	Completed Assembly, 2WD w/ Auto. Trans., California Emissions	645860 ⑤	--
00-03	6	3.9L	Completed Assembly, 4WD, California Emissions	645847 ⑤	--
00-03	6	3.9L	Rear, 4WD, California Emissions	--	608206⑤
00-03	6	3.9L	Front Left, 2WD, California Emissions	--	608285⑤
97-99	6	3.9L	4WD, 124" & 131" W.B.	645989 ③	608226③
97-99	6	3.9L	2WD, 59" Conv.	645961 ③	608226③
1996	6	3.9L	2WD, 131" W.B.	645855 ③	608226③
94-95	6	3.9L	2WD, 131" W.B.	642912 ③	602006③
92-93	6	3.9L	2WD	645940 ③	609006③
92-93	6	3.9L	4WD	--	609006③
90-91	6	3.9L	2WD	645944 ☆③	609006③
87-89	6	3.9L	2WD, Rear	642910 ☆③	602004③
87-89	6	3.9L	4WD, Rear	642919 ☆③	602004③
2008	8	4.7L	California Emissions	645225 ⑤	--
2005	8	4.7L		645428 ③	--
01-03	8	4.7L	4WD, 131.5" W.B., Federal Emissions	645869 ④	608216④
01-03	8	4.7L	DF Conv., Complete Assembly, 4WD, 131.5" W.B., California Emissions	645870 ⑤	--
01-03	8	4.7L	Front Right Universal, 4WD, 131.5" W.B., California Emissions	--	608285⑤
01-03	8	4.7L	Rear Universal, 4WD, 131.5" W.B., California Emissions	--	608216⑤
01-03	8	4.7L	Front Left Universal, 4WD, 131.5" W.B., California Emissions	--	608285⑤
00-03	8	4.7L	RWD, Federal Emissions	645791 ④	608216④
00-03	8	4.7L	2WD, Front, California Emissions	--	608285⑤
00-03	8	4.7L	2WD, Rear Conv., California Emissions	--	608216⑤
00-02	8	4.7L	RWD, California Emissions	645805 ⑤	--
97-99	8	5.2L	4WD, 124" & 131" W.B.	645989 ③	608226③
97-99	8	5.2L	2WD, 124" & 131" W.B.	645994 ③	608226③
97-99	8	5.2L	2WD & 4WD 112" W.B.	--	608226③
1996	8	5.2L	(Exc. 2WD, 131" W.B.)	--	608226③
1996	8	5.2L	2WD, 131" W.B.	645855 ③	608226③
94-95	8	5.2L	2WD, 131" W.B.	642912 ③	602006③
94-95	8	5.2L	(Exc. 2WD, 131" W.B.)	--	609005③
92-93	8	5.2L	2WD	645940 ③	609006③
92-93	8	5.2L	4WD	--	609007③
1991	8	5.2L		--	609005③
98-99	8	5.9L	2WD	645994 ③	608226③

☆ Air Tube kit 4948 may be required for installation.

③ Federal & California Emissions. Not For Sale or Use on vehicles licensed in the state of CA & NY (NY vehicles with CA Emissions). Check with your state authority for details.

④ Federal Emissions. Not For Sale or Use on vehicles licensed in the state of CA. Check with your state authority.

⑤ California Emissions. Not For Sale or Use on vehicles licensed in the state of CA & NY. Check with your state authority.

APPLICATION LISTINGS

FEDERAL CONVERTERS



YR/YRS	CYL	LITER	DESCRIPTION	DIRECT FIT	UNIVERSAL
DODGE DART, DEMON					
75-76	6	3.7L		--	602204③
75-76	8	5.2L	2 Dr. Coupe	--	602205③
75-76	8	5.9L		--	602205③
75-76	8	All	(Exc. 2 Dr. Coupe w/318 C.I.D.)	--	602205③
DODGE DAYTONA					
1993	4	2.2L	Turbo	--	602205③
89-92	4	2.2L	Turbo	--	602206③
86-88	4	2.2L	Turbo	--	602206③
84-85	4	2.2L	Turbo	--	602205③
1984	4	2.2L	(Exc. Turbo)	642320 ☆③	602004③
89-93	4	2.5L	(Exc. Turbo)	642320 ☆③	602004③
89-92	4	2.5L	Turbo	--	602206③
87-88	4	2.5L	(Exc. Turbo)	642320 ☆③	602004③
85-86	4	All	(Exc. Turbo)	642320 ☆③	602004③
92-93	6	3.0L		642576 ③	602205③
90-91	6	3.0L		--	602205③
DODGE DIPLOMAT					
81-83	6	3.7L	Underbody	--	602004③
81-83	6	3.7L	Main & Pre-Cat	--	602004③
1980	6	3.7L	Rear, 2 Dr.	--	602004③
1980	6	3.7L	2 Dr., Main & Pre-Cat	--	602004③
1980	6	3.7L	Rear, 4 Dr. or Station Wgn.	--	602004③
1980	6	3.7L	4 Dr. or Station Wgn., Main & Pre-Cat	--	602004③
1979	6	3.7L	Rear, 2 Dr.	--	602004③
1979	6	3.7L	2 Dr., Main & Pre-Cat	--	602004③
1979	6	3.7L	Rear, 4 Dr. or Station Wgn.	--	602004③
1979	6	3.7L	4 Dr. or Station Wgn., Main & Pre-Cat	--	602004③
1978	6	3.7L	2 Dr.	--	602205③
1978	6	3.7L	4 Dr. or Station Wgn.	--	602205③
81-89	8	5.2L	Underbody	--	602005③
81-89	8	5.2L	Main & Pre-Cat	--	602005③
1980	8	5.2L	2 Dr.	--	602205③
1980	8	5.2L	4 Dr., Station Wgn.	--	602205③
1980	8	5.2L	California Emissions	--	602205⑤
77-78	8	5.2L	2 Dr.	--	602205③
77-78	8	5.2L	4 Dr. or Station Wgn.	--	602205③
1978	8	5.9L	2 Dr.	--	602205③
1978	8	5.9L	4 Dr. or Station Wgn.	--	602205③
1979	8	All	2 Dr.	--	602205③
1979	8	All	4 Dr. or Station Wgn.	--	602205③
DODGE DURANGO					
05-07	6	3.7L		645472 ③	608415③
2004	6	3.7L		642088 ③	608226③
1999	6	3.9L	2WD	645961 ③	608226③
98-99	6	3.9L	4WD	--	608226③
05-07	8	4.7L		645472 ③	608415③○
2004	8	4.7L		642088 ③	608226③

☆ Air Tube kit 4948 may be required for installation.

③ Federal & California Emissions. Not For Sale or Use on vehicles licensed in the state of CA & NY (NY vehicles with CA Emissions). Check with your state authority for details.

⑤ California Emissions. Not For Sale or Use on vehicles licensed in the state of CA & NY. Check with your state authority.

○ EPA Enhanced OBDII By Design Unit



APPLICATION LISTINGS FEDERAL CONVERTERS

YR/YRS	CYL	LITER	DESCRIPTION	DIRECT FIT	UNIVERSAL
DODGE DURANGO (Cont.)					
00-03	8	4.7L	2WD, Federal Emissions	645848 ④	608216 ③
00-03	8	4.7L	4WD, Federal Emissions	645888 ④	608216 ④
98-99	8	5.2L	4WD	645995 ③	608226 ③
04-05	8	5.7L	4WD, Right Side	645822 ③	--
04-05	8	5.7L	4WD, Left Side	645296 ③	--
01-03	8	5.9L	4WD, California Emissions	645790 ⑤	--
01-03	8	5.9L	4WD, Federal Emissions	645884 ④	608216 ④
2000	8	5.9L	4WD	645884 ③	608216 ③
98-99	8	5.9L	4WD	645995 ③	608226 ③
DODGE DYNASTY					
88-93	4	2.5L		642320 ☆③	602004 ③
92-93	6	3.0L		642576 ③	602205 ③
88-91	6	3.0L	Conv. includes Resonator	642388 ③	602206 ③
92-93	6	3.3L		642798 ③	602205 ③
90-91	6	3.3L		--	602206 ③
DODGE INTREPID					
02-04	6	2.7L	Right	642268 ③	608214 ③
02-04	6	2.7L	Left	642526 ③	608214 ③
98-01	6	2.7L	Semi- Direct Fit, fabrication required, Right	642527 ③	608214 ③
98-01	6	2.7L	Left	642526 ③	608214 ③
98-01	6	3.2L	Right	642258 ③	608215 ③
98-01	6	3.2L	Left	642526 ③	608215 ③
93-97	6	3.3L	Right Front, w/2 Bolt Inlet Flange, Federal Models	641140 ④	608294 ④
93-97	6	3.3L	Left Front, w/2 Bolt Inlet Flange, Federal Models	641141 ④	608294 ④
93-97	6	3.3L	For use with OE intermediate pipe, Main Conv., additional sizing, bushings, cutting may be required due to OE exhaust design.	642460 ②③	608240 ③
93-97	6	3.3L	For use with aftermarket intermediate pipe, Main Conv., additional sizing, bushings, cutting may be required due to OE exhaust design.	642777 ②③	608240 ③
93-96	6	3.3L	Right, California Emissions & 3 Bolt Inlet Flanges	641139 ⑤	--
93-96	6	3.3L	Left, California Emissions & 3 Bolt Inlet Flanges	641138 ⑤	--
93-96	6	3.3L	For use with OE intermediate pipe, Rear Main, California Emissions, additional sizing, bushings, cutting may be required due to OE exhaust design.	642460 ②⑤	608240 ⑤
93-96	6	3.3L	For use with aftermarket intermediate pipe, Rear Main, California Emissions, additional sizing, bushings, cutting may be required due to OE exhaust design.	642777 ②⑤	608240 ⑤
02-04	6	3.5L	Right	642258 ③	608214 ③
02-04	6	3.5L	Left	642526 ③	608214 ③
2000	6	3.5L	Semi- Direct Fit, fabrication required, Right	642729 ③	608215 ③
2000	6	3.5L	R/T Models, Left	642526 ③	608215 ③
96-97	6	3.5L	Right Front	641112 ③	--
96-97	6	3.5L	Left Front	641113 ③	--
96-97	6	3.5L	Main Conv., additional sizing, bushings, cutting may be required due to OE exhaust design.	642415 ②③	608240 ③
93-95	6	3.5L	Right Front	641112 ③	--
93-95	6	3.5L	Left Front	641113 ③	--

☆ Air Tube kit 4948 may be required for installation.

② When using with aftermarket piping, direct fit converter may require INLET/OUTLET pipe resizing.

③ Federal & California Emissions. Not For Sale or Use on vehicles licensed in the state of CA & NY (NY vehicles with CA Emissions). Check with your state authority for details.

④ Federal Emissions. Not For Sale or Use on vehicles licensed in the state of CA. Check with your state authority.

⑤ California Emissions. Not For Sale or Use on vehicles licensed in the state of CA & NY. Check with your state authority.

APPLICATION LISTINGS

FEDERAL CONVERTERS



YR/YRS	CYL	LITER	DESCRIPTION	DIRECT FIT	UNIVERSAL
DODGE INTREPID (Cont.)					
93-95	6	3.5L	Main Conv., additional sizing, bushings, cutting may be required due to OE exhaust design.	642415 ②③ --	609240 ③ --
DODGE JOURNEY					
11-14	6	3.6L	Front Left	641383 ③	--
11-14	6	3.6L	Front Right	641384 ③	--
DODGE LANCER					
88-89	4	2.2L	(Exc. Turbo)	642320 ☆③	602004 ③
88-89	4	2.2L	Turbo	--	602205 ③
1987	4	2.2L	Turbo	--	602005 ③
86-87	4	2.2L	(Exc. Turbo)	--	602204 ③
1985	4	2.2L	(Fuel Injection, Exc. Turbo)	--	602005 ③
1985	4	2.2L	Turbo	--	602205 ③
1989	4	2.5L	(Exc. Turbo)	642320 ☆③	602004 ③
1989	4	2.5L	Turbo	--	602205 ③
1988	4	2.5L	Auto Trans., (Exc. Turbo)	642320 ☆③	602004 ③
1988	4	2.5L	Manual Trans., (Exc. Turbo Built Before 10/12/87)	642506 ☆③	602004 ③
1988	4	2.5L	Manual Trans., (Exc. Turbo Built After 10/12/87)	642320 ☆③	602004 ③
1987	4	2.5L		642506 ☆③	602004 ③
1986	4	2.5L		642506 ☆③	602004 ③
DODGE MAGNUM					
05-08	6	2.7L	Right, RWD	643009 ③	608285 ③○
			Right, RWD	--	608265 ③□
05-08	6	2.7L	Left, RWD	643010 ③	608285 ③○
			Left, RWD	--	608265 ③□
2007	6	2.7L	With Front Mini Converter, Left	643099 ③	--
2007	6	2.7L	With Front Mini Converter, Right	643100 ③	--
05-08	6	3.5L	Right, RWD	643009 ③	608285 ③○
			Right, RWD	--	608265 ③□
05-08	6	3.5L	Left, RWD	643010 ③	608285 ③○
			Left, RWD	--	608265 ③□
05-07	8	5.7L	Right, RWD	643018 ③	608285 ③□
			Right, RWD	--	608276 ③○
05-07	8	5.7L	Left, RWD	643019 ③	608285 ③□
			Left, RWD	--	608276 ③○
DODGE MAGNUM XE					
1979	8	All		--	602205 ③
1978	8	All		--	602205 ③
DODGE MIRADA					
81-83	6	3.7L		--	602004 ③
1980	6	3.7L	Underbody	--	602204 ③
1980	6	3.7L	Main & Pre-Cat	--	602004 ③
81-83	8	5.2L	Underbody	--	602205 ③
81-83	8	5.2L	Main & Pre-Cat	--	602005 ③
DODGE MONACO					
90-92	6	3.0L		642311 ③	602205 ③
77-78	6	3.7L	Monaco	--	602205 ③
77-78	8	5.2L	Monaco	--	602205 ③

☆ Air Tube kit 4948 may be required for installation.

② When using with aftermarket piping, direct fit converter may require INLET/OUTLET pipe resizing.

③ Federal & California Emissions. Not For Sale or Use on vehicles licensed in the state of CA & NY (NY vehicles with CA Emissions). Check with your state authority for details.

□ EPA OBDII By Design Unit

○ EPA Enhanced OBDII By Design Unit



APPLICATION LISTINGS FEDERAL CONVERTERS

YR/YRS	CYL	LITER	DESCRIPTION	DIRECT FIT	UNIVERSAL
DODGE MONACO (Cont.)					
1977	8	5.2L	Royal Monaco	--	602205 ^③
75-76	8	5.2L	Monaco	--	602205 ^③
75-76	8	5.2L	Royal Monaco	--	602205 ^③
77-78	8	5.9L	Monaco	--	602205 ^③
1977	8	5.9L	Royal Monaco	--	602205 ^③
75-76	8	5.9L	Monaco	--	602205 ^③
75-76	8	5.9L	Royal Monaco	--	602205 ^③
77-78	8	6.6L	Monaco, Right, Dual Exhaust	--	604005 ^③
77-78	8	6.6L	Monaco, Left, Dual Exhaust	--	604005 ^③
1977	8	6.6L	Monaco, (Exc. Dual Exhaust)	--	604005 ^③
75-76	8	6.6L	Royal Monaco, Right, Dual Exhaust	--	604005 ^③
75-76	8	6.6L	Royal Monaco, (Exc. Dual Exhaust)	--	602205 ^③
75-76	8	6.6L	Royal Monaco, Left, Dual Exhaust	--	604005 ^③
75-77	8	7.2L	Royal Monaco, Right, Dual Exhaust	--	604005 ^③
75-77	8	7.2L	Royal Monaco, (Exc. Dual Exhaust)	--	604006 ^③
75-77	8	7.2L	Royal Monaco, Left, Dual Exhaust	--	604005 ^③
75-76	8	7.2L	Monaco, Right, Dual Exhaust	--	604005 ^③
75-76	8	7.2L	Monaco, (Exc. Dual Exhaust)	--	604006 ^③
75-76	8	7.2L	Monaco, Left, Dual Exhaust	--	604005 ^③
DODGE NEON					
2005	4	2.0L		642847 ^③	--
01-04	4	2.0L	Engine VIN F	642847 ^③	--
00-02	4	2.0L	ULEV, VIN C, Rear	642843 ^③	--
00-01	4	2.0L	w/2" OD Outlet, Federal Emissions TLEV, Exc. ULEV	642292 ^④	608215 ^④
98-99	4	2.0L	OBDII Equipped, Federal Emissions, Exc. LEV	642478 ^④	608205 ^④
96-97	4	2.0L	OBDII Equipped, Federal Emissions	642478 ^④	608205 ^④
1995	4	2.0L	Non-OBD II equipped, Federal Emissions	642478 ^④	602205 ^④
00-04	4	All	w/2-1/4" OD Outlet, Exc. ULEV	642594 ^③	608215 ^③
DODGE NITRO					
2008	6	3.7L	Complete Assembly	645830 ^③	--
2008	6	3.7L	Right Side	--	608314 ^③
2008	6	3.7L	Left Side	--	608316 ^③
DODGE OMNI, 024					
83-86	4	1.6L	Front	--	602004 ^③
83-84	4	1.6L		--	602204 ^③
82-83	4	1.7L	Front	--	602004 ^③
82-83	4	1.7L		--	602204 ^③
1981	4	1.7L	Front	--	602004 ^③
80-81	4	1.7L		--	602004 ^③
1980	4	1.7L	Front Mini-Ox Conv.	--	602214 ^③
78-80	4	1.7L		--	602004 ^③
88-90	4	2.2L	Semi-Direct Fit, fabrication required - Outlet Pipe	--	602004 ^③
81-87	4	2.2L	(Exc. Turbo), Front	--	602004 ^③
85-86	4	2.2L	Turbo	--	602205 ^③
81-82	4	2.2L		--	602004 ^③

③ Federal & California Emissions. Not For Sale or Use on vehicles licensed in the state of CA & NY (NY vehicles with CA Emissions). Check with your state authority for details.

④ Federal Emissions. Not For Sale or Use on vehicles licensed in the state of CA. Check with your state authority.

APPLICATION LISTINGS

FEDERAL CONVERTERS



YR/YRS	CYL	LITER	DESCRIPTION	DIRECT FIT	UNIVERSAL
DODGE RAIDER					
87-89	4	2.6L		642385 ③	602204 ③
1989	6	3.0L	16-3/8" Conv.	642403 ③	602204 ③
DODGE RAM (2WD & 4WD) PICKUP 1/2 & 3/4 TON					
04-05	6	3.7L	Right, 1500	645854 ③	608215 ③
04-05	6	3.7L	Left, 1500	645438 ③	608215 ③
02-03	6	3.7L	2WD, 4 Dr., w/Flanges, Will replace 1st or 2nd Design OEM System	645986 ③	608240 ③
00-01	6	3.9L		--	608240 ③
96-99	6	3.9L		645937 ③	608240 ③
94-95	6	3.9L		645926 ③	609244 ③
09-10	8	4.7L	Ram 1500	645231 ③	--
2008	8	4.7L	Ram 1500	645228 ③	--
04-05	8	4.7L	Right, 1500	645854 ③	608215 ③
04-05	8	4.7L	Left, 1500	645438 ③	608215 ③
02-03	8	4.7L	2WD, 4 Dr., w/Flanges, Will replace 1st or 2nd Design OEM System, Exc. ULEV	645986 ③	608240 ③
02-03	8	4.7L	R1500, 4WD, Federal Emissions	645846 ④	608240 ④
00-01	8	5.2L	1500	645858 ③	608240 ③
96-99	8	5.2L		645937 ③	608240 ③
94-95	8	5.2L		645926 ③	609244 ③
09-10	8	5.7L	Ram 1500	645224 ③	--
2009	8	5.7L	Ram 2500	645230 ③	--
2008	8	5.7L	Ram 1500, Exc. Mega Cab	645229 ③	--
06-07	8	5.7L	Ram 1500, Exc. Mega Cab	645227 ③	--
04-05	8	5.7L	Right, 1500	645866 ③	608216 ③
04-05	8	5.7L	Left, 1500	645436 ③	608216 ③
2003	8	5.7L	1500, 2WD, 160" W.B.	645857 ③	608240 ③
2003	8	5.7L	R2500	645807 ③	608416 ③
2003	8	5.9L	R1500, 4WD	645800 ③	608266 ③
02-03	8	5.9L	2WD, 4 Dr., w/Flanges, Will replace 1st or 2nd Design OEM System, Exc. ULEV	645986 ③	608240 ③
2002	8	5.9L	R1500, 4WD, Federal Emissions	645800 ④	608266 ④
00-01	8	5.9L		645858 ③	608240 ③
96-99	8	5.9L		645937 ③	608240 ③
94-95	8	5.9L		645926 ③	609244 ③
94-02	10	8.0L	R2500 3/4 Ton Only, Dual Exhaust, 2 1/4" Pipe, With Air Tube, To 12000 lbs GVW, Left	646309 ☆③	607005 ③
94-02	10	8.0L	R2500 3/4 Ton Only, Dual Exhaust, 2 1/4" Pipe, With Air Tube, To 12000 lbs GVW, Right	646309 ☆③	607005 ③
DODGE RAM (2WD & 4WD) PICKUP 1 TON					
2009	8	5.7L	Ram 3500	645230 ③	--
2003	8	5.7L	R3500	645807 ③	608416 ③
00-01	8	5.9L		645858 ③	608240 ③
96-99	8	5.9L		645937 ③	608240 ③
1996	8	5.9L	w/H.D. Exhaust, Right	646306 ③	606005 ③
1996	8	5.9L	w/H.D. Exhaust, Left	--	606005 ③
95-96	8	5.9L	Dual Exhaust, 2-1/4" Pipe, w/o Air Tube, To 12000 lbs GVW, Right	646306 ③	--
94-95	8	5.9L	Under 8800 lbs GVW, Right	--	605005 ③

☆ Air Tube kit 4948 may be required for installation.

③ Federal & California Emissions. Not For Sale or Use on vehicles licensed in the state of CA & NY (NY vehicles with CA Emissions). Check with your state authority for details.

④ Federal Emissions. Not For Sale or Use on vehicles licensed in the state of CA. Check with your state authority.



APPLICATION LISTINGS FEDERAL CONVERTERS

YR/YRS	CYL	LITER	DESCRIPTION	DIRECT FIT	UNIVERSAL
DODGE RAM (2WD & 4WD) PICKUP 1 TON (Cont.)					
94-95	8	5.9L	Under 8800 lbs GVW, Left	--	605005③
94-95	8	5.9L	2-1/4" Conv. w/o Air Tube, over 8800 lbs GVW, Right	646306 ③	607005③
94-95	8	5.9L	2-1/4" Conv. w/o Air Tube, over 8800 lbs GVW, Left	--	607005③
94-02	10	8.0L	Dual Exhaust, 2 1/4" Pipe, With Air Tube, To 12000lbs GVW, Left	646309 ☆③	607005③
94-02	10	8.0L	Dual Exhaust, 2 1/4" Pipe, With Air Tube, To 12000 lbs GVW, Right	646309 ☆③	607005③
95-96	10	8.0L	Dual Exhaust, 3" Pipe, To 12000 lbs GVW, Right	646307 ③	--
DODGE RAM 50 PICKUP					
87-89	4	2.0L		642385 ③	602204③
85-86	4	2.0L		--	602204③
90-92	4	2.4L		642403 ③	602204③
87-89	4	2.6L		642385 ③	602204③
85-86	4	2.6L		--	602204③
82-84	4	2.6L		--	602204③
79-81	4	All		--	602204③
90-91	6	All	4WD	--	602204③
DODGE RAMCHARGER					
1980	6	3.7L	Underbody	--	609005③
78-79	6	3.7L		--	602205③
75-80	8	5.2L		--	609006③
75-80	8	5.9L		--	609006③
1976	8	6.6L		--	604006③
92-93	8	All		--	609005③
90-91	8	All	4WD	--	609006③
89-91	8	All	2WD	--	609006③
80-88	8	All	2WD, Rear	--	609006③
80-88	8	All	4WD, Rear	--	609006③
DODGE RAMPAGE					
1984	4	2.2L		--	602004③
82-83	4	2.2L	Semi-Direct Fit, fabrication required - Outlet Pipe	--	602004③
DODGE SHADOW					
87-94	4	2.2L	(Exc. Turbo)	642320 ☆③	602004③
89-90	4	2.2L	Turbo	--	602206③
1988	4	2.2L	Turbo	--	602206③
1987	4	2.2L	Turbo	--	602205③
89-94	4	2.5L	(Exc. Turbo)	642320 ☆③	602004③
89-92	4	2.5L	Turbo	--	602004③
92-94	6	3.0L		642576 ③	602205③
DODGE SPIRIT					
91-92	4	2.2L	Turbo	--	602205③
89-95	4	2.5L	(Exc. Turbo)	642320 ☆③	602004③
89-92	4	2.5L	Turbo	--	602206③
92-95	6	3.0L		642576 ③	602205③
89-91	6	3.0L	Complete, w/Piping, Conv. includes Resonator	642388 ③	602206③
89-91	6	3.0L	Weld-in direct fit	--	602206③
DODGE ST. REGIS					
1981	6	3.7L	Rear	--	602005③
1981	6	3.7L	Main & Pre-Cat	--	602005③

☆ Air Tube kit 4948 may be required for installation.

③ Federal & California Emissions. Not For Sale or Use on vehicles licensed in the state of CA & NY (NY vehicles with CA Emissions). Check with your state authority for details.

APPLICATION LISTINGS

FEDERAL CONVERTERS



YR/YRS	CYL	LITER	DESCRIPTION	DIRECT FIT	UNIVERSAL
DODGE ST. REGIS (Cont.)					
79-80	6	3.7L		--	602205③
80-81	8	5.2L	Rear	--	602205③
80-81	8	5.2L	Main & Pre-Cat	--	602005③
1980	8	5.9L		--	602005③
1979	8	All		--	602205③
DODGE STEALTH					
91-95	6	3.0L	Front	--	602214③
91-95	6	3.0L		642403 ③	602204③
DODGE STRATUS					
98-00	4	2.0L		642768 ③	608204③
96-97	4	2.0L		642675 ③	608235③
2006	4	2.4L	Sedan & Convertible	642791 ③	608214③
04-05	4	2.4L	Sedan & Convertible Exc. PZEV Emissions	642791 ③	608214③
01-05	4	2.4L	Coupe, Front	641207 ③	--
01-05	4	2.4L	Coupe, Rear	643011 ③	608205③
01-03	4	2.4L	Sedan & Convertible	642791 ③	608214③
95-00	4	2.4L		642533 ③	608205③
95-00	6	2.5L		642533 ③	608205③
01-06	6	2.7L	Manifold Unit, Front	642692 ③	--
01-06	6	2.7L	Rear Manifold Conv.	642693 ③	--
01-05	6	3.0L	Front Conv.	641163 ③	--
01-05	6	3.0L	Rear Conv.	641164 ③	--
01-05	6	3.0L	Main Rear	642987 ③	608235③
DODGE VIPER					
03-06	10	8.3L	3" System, Left	642844 ③	--
03-06	10	8.3L	3" System, Right	642845 ③	--
EAGLE MEDALLION					
88-89	4	2.2L		--	602204③
EAGLE PREMIER					
88-89	4	2.5L		642311 ③	602205③
88-92	6	3.0L		642311 ③	602205③
EAGLE SUMMIT					
93-95	4	1.5L		642403 ③	602204③
89-92	4	1.5L		642403 ③	602204③
89-90	4	1.6L	DOHC	642403 ③	602204③
93-94	4	1.8L		642403 ③	602204③
92-94	4	2.4L		--	602204③
EAGLE TALON					
95-98	4	2.0L		642755 ③	608204③
90-94	4	All		642403 ③	602204③
EAGLE VISION					
93-97	6	3.3L	Left Front, Federal Models	641141 ④	608294④
93-97	6	3.3L	Right Front, Federal Models	641140 ④	608294④
93-97	6	3.3L	For use with OE intermediate pipe, Main Conv., additional sizing, bushings, cutting may be required due to OE exhaust design.	642460 ②③	608240③
93-97	6	3.3L	For use with aftermarket intermediate pipe, Main Conv., additional sizing, bushings, cutting may be required due to OE exhaust design.	--	--
93-97	6	3.3L	For use with aftermarket intermediate pipe, Main Conv., additional sizing, bushings, cutting may be required due to OE exhaust design.	642777 ②③	608240③
93-97	6	3.3L	For use with aftermarket intermediate pipe, Main Conv., additional sizing, bushings, cutting may be required due to OE exhaust design.	--	--

② When using with aftermarket piping, direct fit converter may require INLET/OUTLET pipe resizing.

③ Federal & California Emissions. Not For Sale or Use on vehicles licensed in the state of CA & NY (NY vehicles with CA Emissions). Check with your state authority for details.

④ Federal Emissions. Not For Sale or Use on vehicles licensed in the state of CA. Check with your state authority.



APPLICATION LISTINGS FEDERAL CONVERTERS

YR/YRS	CYL	LITER	DESCRIPTION	DIRECT FIT	UNIVERSAL
EAGLE VISION (Cont.)					
95-96	6	3.3L	Left, California Emissions & 3 Bolt Inlet Flanges	641138 ⑤	--
95-96	6	3.3L	Right, California Emissions & 3 Bolt Inlet Flanges	641139 ⑤	--
95-96	6	3.3L	For use with OE intermediate pipe, Rear Main, California Emissions additional sizing, bushings, cutting may be required due to OE exhaust design.	642460 ②⑤	608240 ⑤
				--	--
				--	--
95-96	6	3.3L	For use with aftermarket pipe, Rear Main, California Emissions, additional sizing, bushings, cutting may be required due to OE exhaust design.	642777 ②⑤	608240 ⑤
				--	--
				--	--
93-94	6	3.3L	Left, California Emissions & 3 Bolt Inlet Flanges	641138 ⑤	--
93-94	6	3.3L	Right, California Emissions & 3 Bolt Inlet Flanges	641139 ⑤	--
93-94	6	3.3L	For use with OE intermediate pipe, Rear Main, California Emissions, additional sizing, bushings, cutting may be required due to OE exhaust design.	642460 ②⑤	609240 ⑤
				--	--
				--	--
93-94	6	3.3L	For use with aftermarket intermediate pipe, Rear Main, California Emissions, additional sizing, bushings, cutting may be required due to OE exhaust design.	642777 ②⑤	608240 ⑤
				--	--
				--	--
1996	6	3.5L	Left Front	641113 ③	--
1996	6	3.5L	Right Front	641112 ③	--
1996	6	3.5L	Main Conv., additional sizing, bushings, cutting may be required due to OE exhaust design.	642415 ②③	608240 ③
				--	--
93-95	6	3.5L	Left Front	641113 ③	--
93-95	6	3.5L	Right Front	641112 ③	--
93-95	6	3.5L	Main Conv., additional sizing, bushings, cutting may be required due to OE exhaust design.	642415 ②③	609240 ③
				--	--
EAGLE VISTA					
89-92	4	1.5L	(Canada Model)	642403 ③	602204 ③
FIAT 124					
79-81	L4	2.0L		--	602203 ③
FIAT BRAVA					
80-81	L4	2.0L		--	602203 ③
FIAT X-1/9					
1980	4	1.5L	Exc. Fuel Injection	--	602203 ③
80-83	L4	1.5L	Fuel Injection	--	602203 ③
FIAT STRADA					
80-82	L4	1.5L	Fuel Injection	--	602203 ③
FORD AEROSTAR					
86-87	4	2.3L	Front	--	602204 ③
86-87	4	2.3L		--	602004 ③
86-87	4	2.3L	2 to 1 Conv. Replacement	--	605004 ③
1986	6	2.8L	Front	--	602204 ③
1986	6	2.8L		--	602004 ③
96-97	6	3.0L	Front	--	608226 ③
96-97	6	3.0L		--	608226 ③
94-95	6	3.0L	Front	--	602205 ③
94-95	6	3.0L		--	602205 ③
86-93	6	3.0L	Front	--	602204 ③
86-93	6	3.0L		--	602204 ③
86-93	6	3.0L	Complete Assembly	645302 ③	--

② When using with aftermarket piping, direct fit converter may require INLET/OUTLET pipe resizing.

③ Federal & California Emissions. Not For Sale or Use on vehicles licensed in the state of CA & NY (NY vehicles with CA Emissions). Check with your state authority for details.

⑤ California Emissions. Not For Sale or Use on vehicles licensed in the state of CA & NY. Check with your state authority.

APPLICATION LISTINGS

FEDERAL CONVERTERS



YR/YRS	CYL	LITER	DESCRIPTION	DIRECT FIT	UNIVERSAL
FORD AEROSTAR (Cont.)					
90-97	6	4.0L	2WD & AWD, Front	--	609005③
90-97	6	4.0L	2WD & AWD, Rear	--	609005③
90-97	6	4.0L	2WD & AWD, Complete Assembly	645973 ③	--
FORD ASPIRE					
96-97	4	1.3L		642477 ③	608294③
94-95	4	1.3L		642477 ③	602294③
FORD BRONCO					
91-92	6	4.9L	Front, Dual Inlet	--	609244③
91-92	6	4.9L		--	609005③
91-92	6	4.9L	2 to 1 Conv. Replacement	--	609005③
87-90	6	4.9L	Front, Dual Inlet	--	609244③
87-90	6	4.9L		--	609005③
87-90	6	4.9L	2 to 1 Conv. Replacement	645928 ☆③	609005③
84-86	6	4.9L	Front	--	609005③
84-86	6	4.9L		--	609005③
84-86	6	4.9L	2 to 1 Conv. Replacement	--	609005③
80-83	6	4.9L		--	602005③
91-95	8	5.0L	Front, Dual Inlet	--	609244③
91-95	8	5.0L		--	609006③
91-95	8	5.0L	2 to 1 Conv. Replacement	645320 ☆③	609006③
85-90	8	5.0L	Front, Dual Inlet	--	609244③
85-90	8	5.0L		--	609006③
85-90	8	5.0L	2 to 1 Conv. Replacement	--	609006③
1984	8	5.0L	Front, Dual Inlet	--	609244③
1984	8	5.0L		--	609006③
1984	8	5.0L	2 to 1 Conv. Replacement	--	609006③
91-95	8	5.8L		--	605006③
91-95	8	5.8L	2 to 1 Conv. Replacement	--	609006③
88-90	8	5.8L	Front, Dual Inlet	--	609244③
88-90	8	5.8L		--	609006③
88-90	8	5.8L	2 to 1 Conv. Replacement	--	609006③
85-87	8	5.8L	Front, Dual Inlet, 4 bbl.	--	609244③
85-87	8	5.8L	Rear, 4 bbl.	--	609006③
85-87	8	5.8L	4 bbl., 2 to 1 Conv. Replacement	--	609006③
84-85	8	5.8L	Front, Dual Inlet, 2 bbl.	--	609244③
84-85	8	5.8L	Rear, 2 bbl.	--	609006③
84-85	8	5.8L	2 bbl, 2 to 1 Conv. Replacement	--	609006③
80-83	8	All		--	602005③
78-79	8	All		--	604006③
FORD BRONCO II					
84-85	6	2.8L		--	602005③
1990	6	2.9L	Front	--	602205③
1990	6	2.9L		--	602205③
1990	6	2.9L	OEM Y-Pipe must be trimmed 1/2" from face of flange for proper insertion into converter.	645339 ③	--
1990	6	2.9L	2 to 1 Conv. Replacement	--	609005③
88-89	6	2.9L	Front	--	602205③

☆ Air Tube kit 4948 may be required for installation.

③ Federal & California Emissions. Not For Sale or Use on vehicles licensed in the state of CA & NY (NY vehicles with CA Emissions). Check with your state authority for details.



APPLICATION LISTINGS FEDERAL CONVERTERS

YR/YRS	CYL	LITER	DESCRIPTION	DIRECT FIT	UNIVERSAL
FORD BRONCO II (Cont.)					
88-89	6	2.9L	Rear	--	602205③
88-89	6	2.9L	OEM Y-Pipe must be trimmed 1/2" from face of flange for proper insertion into converter.	645340 ③	--
88-89	6	2.9L	2 to 1 Conv. Replacement	--	609005③
86-87	6	2.9L	Front	--	609240③
86-87	6	2.9L	Rear	--	609005③
86-87	6	2.9L	2 to 1 Conv. Replacement	--	609005③
FORD CONTOUR					
98-00	4	2.0L	Eng. Code 3	642677 ③	--
95-97	4	2.0L		642610 ③	--
95-00	6	2.5L	Front Side Manifold Conv.	641127 ③	--
95-00	6	2.5L	Rear Side Manifold Conv.	641129 ③	--
95-00	6	2.5L	Rear, Auto Trans., w/O2 Sensor	642683 ③	608204③
95-00	6	2.5L	Main Conv., Manual Trans.	642538 ③	608205③
95-96	6	2.5L	Main Conv., Auto Trans., w/o O2 Sensor	642492 ③	602204③
FORD CROWN VICTORIA (Inc. Police, Taxi, Station Wagon)					
03-11	8	4.6L	Front Left	--	608274③
03-11	8	4.6L	Rear Left	--	608284③
03-11	8	4.6L	Front Right	--	608274③
03-11	8	4.6L	Rear Right	--	608284③
03-11	8	4.6L	Right	642161 ③	--
03-11	8	4.6L	Left	642179 ③	--
03-06	8	4.6L	Right	642733 ③①	--
03-06	8	4.6L	Left	642734 ③①	--
96-02	8	4.6L	Front Left	--	608274③
96-02	8	4.6L	Rear Left	--	608204③
96-02	8	4.6L	Right	642550 ③	--
96-02	8	4.6L	Left	642549 ③	--
96-02	8	4.6L	Front Right	--	608274③
96-02	8	4.6L	Rear Right	--	608204③
1995	8	4.6L	Right	642463 ③	608204③
1995	8	4.6L	Left	642462 ③	608204③
92-94	8	4.6L	Right, Main & Pre-Cat	642436 ③	602204③
92-94	8	4.6L	Left, Main & Pre-Cat	642437 ③	602204③
90-91	8	5.0L	Right Side, Main & Pre-Cat	642390 ☆③	602004③
90-91	8	5.0L	Left, Main & Pre-Cat	642391 ☆③	602004③
1989	8	5.0L	Right Side, Main & Pre-Cat	642390 ☆③	602004③
1989	8	5.0L	Left, Main & Pre-Cat	642391 ☆③	602004③
86-88	8	5.0L	Right Side, Main & Pre-Cat	642390 ☆③	602004③
86-88	8	5.0L	Left, Main & Pre-Cat	642391 ☆③	602004③
86-91	8	5.8L	Police Pkg., Right, Main & Pre-Cat	--	609004③
86-91	8	5.8L	Police Pkg., Left, Main & Pre-Cat	--	609004③
FORD CUSTOM, CUSTOM 500					
75-77	8	5.8L	Right	--	602214③
75-77	8	5.8L	Left	--	602214③

① Discontinued, use until inventory is depleted.

☆ Air Tube kit 4948 may be required for installation.

③ Federal & California Emissions. Not For Sale or Use on vehicles licensed in the state of CA & NY (NY vehicles with CA Emissions). Check with your state authority for details.

APPLICATION LISTINGS

FEDERAL CONVERTERS



YR/YRS	CYL	LITER	DESCRIPTION	DIRECT FIT	UNIVERSAL
FORD E-100 VAN					
79-83	6	4.9L		--	602005③
77-78	6	4.9L		--	602205③
75-76	6	4.9L		--	602204③
1978	8	5.8L		--	602005③
1977	8	5.8L		--	602205③
75-76	8	5.8L		--	602005③
79-83	8	All		--	602006③
FORD E-150 VAN 1/2 TON					
00-03	6	4.2L	Left Side Complete, Only failed converters may be replaced.	645260 ③	--
00-03	6	4.2L	Right Side Complete, Only failed converters may be replaced.	645259 ③	--
97-03	6	4.2L	Front Right	--	608286③
97-03	6	4.2L	Rear Right	--	608235③
97-03	6	4.2L	Front Left	--	608286③
97-03	6	4.2L	Rear Left	--	608235③
1999	6	4.2L	Left Side Complete, Only failed converters may be replaced, Federal Emissions	645346 ④	--
1999	6	4.2L	Right Side Complete, Only failed converters may be replaced, Federal Emissions	645935 ④	--
1999	6	4.2L	Left Side Complete, Only failed converters may be replaced, California Emissions	645260 ⑤	--
1999	6	4.2L	Right Side Complete, Only failed converters may be replaced, California Emissions	645259 ⑤	--
97-98	6	4.2L	Left Side Complete, Only failed converters may be replaced.	645346 ③	--
97-98	6	4.2L	Right Side Complete, Only failed converters may be replaced.	645935 ③	--
1996	6	4.9L		645875 ③	--
1996	6	4.9L	Front	--	608240③
1996	6	4.9L	Rear	--	608006③
90-95	6	4.9L	Front, Dual Inlet	--	609244③
90-95	6	4.9L		--	609006③
90-95	6	4.9L	2 to 1 Conv. Replacement	645917 ☆③	609006③
87-89	6	4.9L	Under 8500 lbs GVW, Front, Dual Inlet	--	609244③
87-89	6	4.9L	Under 8500 lbs GVW, Rear	--	609006③
87-89	6	4.9L	Under 8500 lbs GVW, 2 to 1 Conv. Replacement	645917 ☆③	609006③
84-86	6	4.9L	Front	--	602205③
84-86	6	4.9L		--	602005③
84-86	6	4.9L	2 to 1 Conv. Replacement	--	609005③
79-83	6	4.9L		--	602005③
77-78	6	4.9L		--	602205③
75-76	6	4.9L		--	602204③
09-14	8	4.6L		645789 ③	--
07-08	8	4.6L	From 10/16/06, Complete Y Assembly w/4 Converters	645464 ③	--
04-07	8	4.6L	Rear Right	--	608235③
04-07	8	4.6L	Front Right	--	608286③
04-07	8	4.6L	Rear Left	--	608235③
04-07	8	4.6L	Front Left	--	608286③
00-07	8	4.6L	To 10/16/06, 2 Piece Design, Left	645283 ③	--
00-07	8	4.6L	To 10/16/06, 2 Piece Design, Right	645284 ③	--

☆ Air Tube kit 4948 may be required for installation.

③ Federal & California Emissions. Not For Sale or Use on vehicles licensed in the state of CA & NY (NY vehicles with CA Emissions). Check with your state authority for details.

④ Federal Emissions. Not For Sale or Use on vehicles licensed in the state of CA. Check with your state authority.

⑤ California Emissions. Not For Sale or Use on vehicles licensed in the state of CA & NY. Check with your state authority.



APPLICATION LISTINGS FEDERAL CONVERTERS

YR/YRS	CYL	LITER	DESCRIPTION	DIRECT FIT	UNIVERSAL
FORD E-150 VAN 1/2 TON (Cont.)					
97-03	8	4.6L	Front Right	--	608286 ^③
97-03	8	4.6L	Rear Right	--	608226 ^③
97-03	8	4.6L	Front Left	--	608286 ^③
97-03	8	4.6L	Rear Left	--	608226 ^③
97-99	8	4.6L	Left	645261 ^③	--
97-99	8	4.6L	Right	645262 ^③	--
1996	8	5.0L	Front	--	608240 ^③
1996	8	5.0L		--	608226 ^③
1996	8	5.0L	Complete Assembly	645881 ^③	--
92-95	8	5.0L	Front, Dual Inlet	--	609244 ^③
92-95	8	5.0L		--	609006 ^③
92-95	8	5.0L	Complete Assembly	645881 ^③	--
86-91	8	5.0L	Front, Dual Inlet	--	609244 ^③
86-91	8	5.0L		--	609005 ^③
86-91	8	5.0L	2 to 1 Conv. Replacement	645922 ☆ ^③	609005 ^③
84-85	8	5.0L	w/Carb., Front Conv., Dual Inlet	--	609244 ^③
84-85	8	5.0L	w/Carb., Rear	--	609006 ^③
84-85	8	5.0L	w/Carb., 2 to 1 Conv. Replacement	--	609006 ^③
05-08	8	5.4L	Complete Assembly	645463 ^③	--
02-04	8	5.4L	Under 8600 lbs GVW, California Emissions, Front	641219 ^⑤	608265 ^⑤
02-04	8	5.4L	Under 8600 lbs GVW, California Emissions, Rear	646316 ^⑤	606007 ^⑤
88-95	8	5.8L	Front	--	609244 ^③
88-95	8	5.8L		--	609006 ^③
88-95	8	5.8L	2 to 1 Conv. Replacement	645962 ☆ ^③	609006 ^③
84-87	8	5.8L	Light Duty, Dual Inlet, 4 bbl. Carb., Front	--	609244 ^③
84-87	8	5.8L	Light Duty, 4 bbl. Carb., Rear	--	609006 ^③
84-87	8	5.8L	Light Duty, 4 bbl. Carb., 2 to 1 Conv. Replacement	--	609006 ^③
1978	8	5.8L		--	602005 ^③
1977	8	5.8L		--	602205 ^③
75-76	8	5.8L		--	602005 ^③
79-83	8	All		--	602006 ^③
FORD E-250 VAN 3/4 TON					
00-03	6	4.2L	Right Side Complete, Only failed converters may be replaced.	645259 ^③	--
00-03	6	4.2L	Left Side Complete, Only failed converters may be replaced.	645260 ^③	--
97-03	6	4.2L	Front Right	--	608286 ^③
97-03	6	4.2L	Rear Right	--	608235 ^③
97-03	6	4.2L	Front Left	--	608286 ^③
97-03	6	4.2L	Rear Left	--	608235 ^③
1999	6	4.2L	Right Side Complete, Only failed converters may be replaced, Federal Emissions	645935 ^④	--
1999	6	4.2L	Left Side Complete, Only failed converters may be replaced, Federal Emissions	645346 ^④	--
1999	6	4.2L	Right Side Complete, Only failed converters may be replaced, California Emissions	645259 ^⑤	--
1999	6	4.2L	Left Side Complete, Only failed converters may be replaced, California Emissions	645260 ^⑤	--
97-98	6	4.2L	Left Side Complete, Only failed converters may be replaced.	645346 ^③	--

☆ Air Tube kit 4948 may be required for installation.

③ Federal & California Emissions. Not For Sale or Use on vehicles licensed in the state of CA & NY (NY vehicles with CA Emissions). Check with your state authority for details.

④ Federal Emissions. Not For Sale or Use on vehicles licensed in the state of CA. Check with your state authority.

⑤ California Emissions. Not For Sale or Use on vehicles licensed in the state of CA & NY. Check with your state authority.

APPLICATION LISTINGS

FEDERAL CONVERTERS



YR/YRS	CYL	LITER	DESCRIPTION	DIRECT FIT	UNIVERSAL
FORD E-250 VAN 3/4 TON (Cont.)					
97-98	6	4.2L	Right Side Complete, Only failed converters may be replaced.	645935 ③	--
1996	6	4.9L		645875 ③	--
1996	6	4.9L	Front	--	608226 ③
1996	6	4.9L		--	608006 ③
90-95	6	4.9L	Front, Dual Inlet	--	609244 ③
90-95	6	4.9L		--	609006 ③
90-95	6	4.9L	2 to 1 Conv. Replacement	645917 ☆③	609006 ③
87-89	6	4.9L	Under 8500 lbs GVW, Front, Dual Inlet	--	609244 ③
87-89	6	4.9L	Under 8500 lbs GVW, Rear	--	609006 ③
87-89	6	4.9L	Under 8500 lbs GVW, 2 to 1 Conv. Replacement	645917 ☆③	609006 ③
84-86	6	4.9L	Front	--	602205 ③
84-86	6	4.9L		--	602005 ③
84-86	6	4.9L	2 to 1 Conv. Replacement	--	609005 ③
79-83	6	4.9L		--	602005 ③
77-78	6	4.9L		--	602205 ③
75-76	6	4.9L		--	602204 ③
09-14	8	4.6L		645789 ③	--
07-08	8	4.6L	From 10/16/06, Complete Y Assembly w/4 Converters	645464 ③	--
04-07	8	4.6L	Rear Right	--	608235 ③
04-07	8	4.6L	Front Right	--	608286 ③
04-07	8	4.6L	Rear Left	--	608235 ③
04-07	8	4.6L	Front Left	--	608286 ③
03-07	8	4.6L	To 10/16/06, 2 Piece Design, Left	645283 ③	--
03-07	8	4.6L	To 10/16/06, 2 Piece Design, Right	645284 ③	--
2003	8	4.6L	Under 8500 lbs GVW, Front Right	--	608286 ③
2003	8	4.6L	Under 8500 lbs GVW, Rear Right	--	608226 ③
2003	8	4.6L	Under 8500 lbs GVW, Front Left	--	608286 ③
2003	8	4.6L	Under 8500 lbs GVW, Rear Left	--	608226 ③
1997	8	4.6L	Under 8500 lbs GVW, Front Right	--	608294 ③
1997	8	4.6L	Under 8500 lbs GVW, Rear Right	--	608226 ③
1997	8	4.6L	Under 8500 lbs GVW, Front Left	--	608294 ③
1997	8	4.6L	Under 8500 lbs GVW, Rear Left	--	608226 ③
86-91	8	5.0L	EFI, Front, Dual Inlet	--	609244 ③
86-91	8	5.0L	EFI, Rear	--	609006 ③
86-91	8	5.0L	EFI, 2 to 1 Conv. Replacement	645922 ☆③	609006 ③
84-85	8	5.0L	w/Carb., Front Conv., Dual Inlet	--	609244 ③
84-85	8	5.0L	w/Carb., Rear	--	609006 ③
84-85	8	5.0L	w/Carb., 2 to 1 Conv. Replacement	--	609006 ③
05-09	8	5.4L	Complete Assembly	645463 ③	--
02-04	8	5.4L	Under 8600 lbs GVW, California Emissions, Front	641219 ⑤	608265 ⑤
02-04	8	5.4L	Under 8600 lbs GVW, California Emissions, Rear	646316 ⑤	606007 ⑤
97-03	8	5.4L	Under 8500 lbs GVW, Front Right	--	608294 ③
97-03	8	5.4L	Under 8500 lbs GVW, Rear Right	--	608226 ③
97-03	8	5.4L	Under 8500 lbs GVW, Front Left	--	608294 ③
97-03	8	5.4L	Under 8500 lbs GVW, Rear Left	--	608226 ③
97-99	8	5.4L	Over 8500 lbs GVW, Single Conv. System, w/o O2 Sensor	646901 ③	606007 ③
1996	8	5.8L	To 9200 lbs GVW	646900 ③	607006 ③

☆ Air Tube kit 4948 may be required for installation.

③ Federal & California Emissions. Not For Sale or Use on vehicles licensed in the state of CA & NY (NY vehicles with CA Emissions). Check with your state authority for details.

⑤ California Emissions. Not For Sale or Use on vehicles licensed in the state of CA & NY. Check with your state authority.



APPLICATION LISTINGS FEDERAL CONVERTERS

YR/YRS	CYL	LITER	DESCRIPTION	DIRECT FIT	UNIVERSAL
FORD E-250 VAN 3/4 TON (Cont.)					
92-95	8	5.8L	To 9200 lbs GVW	645343 ③	--
92-95	8	5.8L	To 11620 lbs GVW	646303 ③	607007 ③
88-95	8	5.8L	Under 8500 lbs GVW, Front, Dual Inlet	--	609244 ③
88-95	8	5.8L	Under 8500 lbs. GVW, Rear	--	609006 ③
88-95	8	5.8L	2 to 1 Conv. Replacement, Under 8500 lbs GVW	645962 ☆③	609006 ③
88-91	8	5.8L	To 9200 lbs GVW	645343 ③	--
88-91	8	5.8L	To 11620 lbs GVW	646303 ③	607007 ③
84-87	8	5.8L	4 bbl. Carb., Front, Dual Inlet	--	609244 ③
84-87	8	5.8L	4 bbl. Carb., Rear	--	609006 ③
84-87	8	5.8L	4 bbl. Carb., 2 to 1 Conv. Replacement	--	609006 ③
1978	8	5.8L		--	602205 ③
1977	8	5.8L		--	602205 ③
75-76	8	5.8L		--	602205 ③
80-81	8	6.6L		--	604006 ③
90-93	8	7.5L	To 9200 lbs GVW	645343 ③	--
90-93	8	7.5L	To 11620 lbs GVW	646303 ③	607007 ③
87-89	8	7.5L	To 9200 lbs GVW	645343 ③	--
87-89	8	7.5L	To 11620 lbs GVW	646303 ③	607007 ③
79-83	8	All	(Exc. 400 C.I.D.)	--	602006 ③
FORD E-350 VAN 1 TON					
1996	6	4.9L		645875 ③	--
1996	6	4.9L	Under 8600 lbs GVW, Front	--	608240 ③
1996	6	4.9L	Under 8600 lbs GVW, Rear	--	608006 ③
90-95	6	4.9L	Up to 8600 lbs GVW, Front, Dual Inlet	--	609244 ③
90-95	6	4.9L	Up to 8600 lbs GVW, Rear	--	609006 ③
90-95	6	4.9L	2 to 1 Conv. Replacement, Up to 8600 lbs GVW	645917 ☆③	609006 ③
87-89	6	4.9L	Front, Dual Inlet	--	609244 ③
87-89	6	4.9L		--	609006 ③
87-89	6	4.9L	2 to 1 Conv. Replacement	645917 ☆③	609006 ③
84-86	6	4.9L	Front	--	609005 ③
84-86	6	4.9L		--	609005 ③
84-86	6	4.9L	2 to 1 Conv. Replacement	--	609005 ③
1983	6	4.9L		--	609005 ③
05-09	8	5.4L	Complete Assembly	645463 ③	--
07-08	8	5.4L	From 10/2006, Super Duty, Stripped Chassis, OEM Torpedo Style, Rear	646321 ③	--
97-98	8	5.4L	Over 8500 lbs GVW, w/o O2 Sensor	646901 ☆③	607007 ③
1996	8	5.8L	To 9200 lbs GVW	646900 ☆③	606006 ③
90-95	8	5.8L		645343 ③	--
88-89	8	5.8L	To 8500 lbs GVW	645343 ③	--
88-89	8	5.8L	To 11620 lbs GVW	646303 ③	607007 ③
1987	8	5.8L	4 bbl. Carb., Front, Dual Inlet	--	609244 ③
1987	8	5.8L	4 bbl. Carb., Rear	--	609006 ③
1987	8	5.8L	4 bbl. Carb., 2 to 1 Conv. Replacement	--	609006 ③
90-95	8	7.5L	To 8500 lbs GVW	645343 ③	--
90-95	8	7.5L	To 11620 lbs GVW	646303 ③	607007 ③
88-89	8	7.5L	To 8500 lbs GVW	645343 ③	--

☆ Air Tube kit 4948 may be required for installation.

③ Federal & California Emissions. Not For Sale or Use on vehicles licensed in the state of CA & NY (NY vehicles with CA Emissions). Check with your state authority for details.

APPLICATION LISTINGS

FEDERAL CONVERTERS



YR/YRS	CYL	LITER	DESCRIPTION	DIRECT FIT	UNIVERSAL
FORD E-350 VAN 1 TON (Cont.)					
88-89	8	7.5L	To 11620 lbs GVW	646303 ③	607007 ③
1987	8	7.5L	To 8500 lbs GVW	645343 ③	--
1987	8	7.5L	To 11620 lbs GVW	646303 ③	607007 ③
84-86	8	All		--	605005 ③
07-08	10	6.8L	From 10/2006, Super Duty, Stripped Chassis, OEM Torpedo Style, Rear	646321 ③	--
06-07	10	6.8L		646315 ③	606007 ③
01-05	10	6.8L		--	606007 ③
97-00	10	6.8L	Over 8500 lbs GVW, w/Curved Outlet Pipe, Federal Emissions	646311 ④	606007 ④
97-00	10	6.8L	Over 8500 lbs GVW, w/Curved Outlet Pipe & O2 Sensor, California Emissions	646313 ⑤	606007 ⑤
97-00	10	6.8L	Stripped Chassis	646318 ③	--
97-98	10	6.8L	Over 8500 lbs GVW, w/Straight Outlet Pipe, w/o O2 Sensor	646901 ☆③	606007 ③
FORD E-450 VAN					
2008	8	5.4L	OEM Torpedo Style, Rear	646321 ③	--
2006	8	5.4L	Super Duty, Cutaway Van, OEM Torpedo Style	646322 ③	--
2006	8	5.4L	Super Duty, Stripped Chassis, OEM Torpedo Style	646322 ③	--
2004	8	5.4L	Super Duty, Stripped Chassis, OEM Torpedo Style	646322 ③	--
03-04	8	5.4L	Super Duty, Cutaway Van, OEM Torpedo Style	646322 ③	--
00-02	8	5.4L	Super Duty, Cutaway Van, OEM Torpedo Style	646322 ③	--
2008	10	6.8L	OEM Torpedo Style, Rear	646321 ③	--
06-07	10	6.8L	From 10/16/06, With 3 Bolt Flange on Inlet	646315 ③	606007 ③
04-07	10	6.8L	Up to 10/16/06, Up to 14,050 lbs.	646317 ③	--
04-06	10	6.8L	Super Duty, Stripped Chassis, OEM Torpedo Style	646322 ③	--
04-06	10	6.8L	Super Duty, Cutaway Van, OEM Torpedo Style	646322 ③	--
2003	10	6.8L	Super Duty, Cutaway Van, OEM Torpedo Style	646322 ③	--
00-02	10	6.8L	Super Duty, Cutaway Van, OEM Torpedo Style	646322 ③	--
FORD E-550 SUPER DUTY					
2003	10	6.8L	Super Duty, Cutaway Van, OEM Torpedo Style	646322 ③	--
FORD EDGE					
11-14	6	3.5L	Manifold Unit, Front Left	641388 ③	--
11-13	6	3.5L	Manifold Unit, Front Right	641389 ③	--
07-10	6	3.5L	Front Conv.	642215 ③	--
07-10	6	3.5L	Rear Conv.	642214 ③	--
11-14	6	3.7L	Manifold Unit, Front Left	641388 ③	--
FORD ESCAPE					
06-08	4	2.3L	Front Manifold Conv., From 10/03/05; XLS & XLT, Exc. Hybrid	641264 ③	--
05-08	4	2.3L	Rear Main	645293 ③	--
09-12	4	2.5L	XLS, XLT, Limited; Exc. Hybrid; Requires Welded Assembly 60005 to Complete Assembly	645273 ③	--
10-12	6	3.0L	Manifold Unit, Front Right	641392 ③	--
09-12	6	3.0L	Manifold Unit, Front Left	641391 ③	--
09-12	6	3.0L	Rear	645197 ③	--
2008	6	3.0L	Manifold Unit, Front Left	641386 ③	--
05-06	6	3.0L	Rear Main	645293 ③	--
01-06	6	3.0L	Manifold Unit, Front	641170 ③	--
01-06	6	3.0L	Rear Manifold Conv.	641169 ③	--

☆ Air Tube kit 4948 may be required for installation.

③ Federal & California Emissions. Not For Sale or Use on vehicles licensed in the state of CA & NY (NY vehicles with CA Emissions). Check with your state authority for details.

④ Federal Emissions. Not For Sale or Use on vehicles licensed in the state of CA. Check with your state authority.

⑤ California Emissions. Not For Sale or Use on vehicles licensed in the state of CA & NY. Check with your state authority.



APPLICATION LISTINGS FEDERAL CONVERTERS

YR/YRS	CYL	LITER	DESCRIPTION	DIRECT FIT	UNIVERSAL
FORD ESCAPE (Cont.)					
01-04	6	3.0L	Rear Main	645409 ③	608204 ③
FORD ESCORT					
83-85	4	1.6L		--	602004 ③
81-82	4	1.6L		--	602004 ③
91-95	4	1.8L		--	602204 ③
1996	4	1.9L		642701 ③	608294 ③
91-95	4	1.9L	w/EGR Port on Conv.	642468 ③	608294 ③
91-95	4	1.9L	w/o EGR Port on Conv.	642354 ③	608294 ③
87-90	4	1.9L	C.F.I.	--	602294 ③
86-90	4	1.9L	E.F.I.	642362 ☆③	--
85-86	4	1.9L	2 bbl. Carb.	--	602004 ③
98-03	4	2.0L	ZX2 Models w/ Auto Trans.	642716 ③	608234 ③
97-02	4	2.0L	(Exc. ZX2)	642548 ③	608294 ③
FORD EXCURSION					
00-02	8	5.4L	Up to 12,000 lbs GVW w/o Rear O2 Sensor, Federal Emissions	646902 ④	606007 ④
00-02	10	6.8L	Up to 12,000 lbs GVW w/o Rear O2 Sensor, Federal Emissions	646902 ④	606007 ④
FORD EXP					
83-84	4	1.6L		--	602004 ③
1982	4	1.6L		--	602004 ③
FORD EXPEDITION					
03-04	8	4.6L	Right	645431 ③	--
03-04	8	4.6L	Left	645433 ③	--
03-04	8	4.6L	Front Right	--	608286 ③
03-04	8	4.6L	Rear Right	--	608226 ③
03-04	8	4.6L	Front Left	--	608286 ③
03-04	8	4.6L	Rear Left	--	608226 ③
01-02	8	4.6L	Front Right	--	608286 ③
01-02	8	4.6L	Rear Right	--	608226 ③
01-02	8	4.6L	Front Left	--	608286 ③
01-02	8	4.6L	Rear Left	--	608226 ③
01-02	8	4.6L	4WD, Left	645213 ③	--
01-02	8	4.6L	4WD, Right	645214 ③	--
2000	8	4.6L	Left, 2WD	645413 ③	--
2000	8	4.6L	Right, 2WD	645412 ③	--
99-00	8	4.6L	4WD, Left	645403 ③	--
99-00	8	4.6L	4WD, Right	645402 ③	--
97-00	8	4.6L	2WD, Front, Right	--	608286 ③
97-00	8	4.6L	2WD, Rear, Right	--	608226 ③
97-00	8	4.6L	2WD, Front, Left	--	608286 ③
97-00	8	4.6L	2WD, Rear, Left	--	608226 ③
97-98	8	4.6L	4WD, Front Right	--	608286 ③
97-98	8	4.6L	4WD, Rear, Right	--	608235 ③
97-98	8	4.6L	4WD, Front Left	--	608286 ③
97-98	8	4.6L	4WD, Rear Left	--	608235 ③
07-14	8	5.4L	Left	645281 ③	--
07-14	8	5.4L	Right	645282 ③	--
05-06	8	5.4L	Left	645290 ③	--

☆ Air Tube kit 4948 may be required for installation.

③ Federal & California Emissions. Not For Sale or Use on vehicles licensed in the state of CA & NY (NY vehicles with CA Emissions). Check with your state authority for details.

④ Federal Emissions. Not For Sale or Use on vehicles licensed in the state of CA. Check with your state authority.

APPLICATION LISTINGS

FEDERAL CONVERTERS



YR/YRS	CYL	LITER	DESCRIPTION	DIRECT FIT	UNIVERSAL
FORD EXPEDITION (Cont.)					
05-06	8	5.4L	Right	645289 ③	--
03-04	8	5.4L	Right	645443 ③	--
03-04	8	5.4L	Left	645444 ③	--
03-04	8	5.4L	Front Right	--	608285 ③
03-04	8	5.4L	Rear Right	--	608216 ③
03-04	8	5.4L	Front Left	--	608285 ③
03-04	8	5.4L	Rear Left	--	608216 ③
01-02	8	5.4L	Right, 4WD	645445 ③	--
01-02	8	5.4L	Left, 4WD	645446 ③	--
01-02	8	5.4L	4WD, Front Right	--	608286 ③
01-02	8	5.4L	4WD, Rear, Right	--	608206 ③
01-02	8	5.4L	2WD, Front, Right	--	608286 ③
01-02	8	5.4L	2WD, Rear, Right	--	608226 ③
01-02	8	5.4L	4WD, Front Left	--	608286 ③
01-02	8	5.4L	4WD, Rear Left	--	608206 ③
01-02	8	5.4L	2WD, Front, Left	--	608286 ③
01-02	8	5.4L	2WD, Rear, Left	--	608226 ③
97-00	8	5.4L	4WD, Front Right	--	608295 ③
97-00	8	5.4L	4WD, Rear, Right	--	608235 ③
97-00	8	5.4L	Complete Right Assembly, 4WD, 4R100 Trans.	645384 ③	--
97-00	8	5.4L	Complete Left Assembly, 4WD, 4R100 Trans.	645385 ③	--
97-00	8	5.4L	2WD, Front, Right	--	608286 ③
97-00	8	5.4L	2WD, Rear, Right	--	608226 ③
97-00	8	5.4L	4WD, Front Left	--	608295 ③
97-00	8	5.4L	4WD, Rear Left	--	608235 ③
97-00	8	5.4L	2WD, Front, Left	--	608286 ③
97-00	8	5.4L	2WD, Rear, Left	--	608226 ③
FORD EXPLORER					
11-13	6	3.5L	Manifold Unit, Front Left	641388 ③	--
11-13	6	3.5L	Manifold Unit, Front Right	641389 ③	--
07-10	6	4.0L	Sport Trac, Complete Assembly	645430 ③	--
07-10	6	4.0L	Sport Trac, Right	--	608265 ③
07-10	6	4.0L	Sport Trac, Left	--	608265 ③
06-10	6	4.0L	Complete Assembly	645430 ③	--
06-10	6	4.0L	Left	--	608265 ③
06-10	6	4.0L	Right	--	608265 ③
04-05	6	4.0L	Sport Trac, VIN K, Front	641385 ③	--
04-05	6	4.0L	Sport Trac, VIN K, Rear	645219 ③	--
02-05	6	4.0L	Code E Eng., Front Convs.	--	608214 ③
02-05	6	4.0L	Code E Eng., Rear	--	608226 ③
02-05	6	4.0L	Code E Eng., Complete Assembly	645887 ③	--
02-04	6	4.0L	Code K Eng., Front Convs.; To 3/1/04	--	608214 ③
02-04	6	4.0L	Code K Eng., Rear; To 3/1/04	--	608226 ③
02-04	6	4.0L	Code K Eng., Complete Assembly; To 3/1/04	645887 ③	--
01-02	6	4.0L	Sport Models, Code E Eng., Front Conv. w/Y Pipe	641178 ③	--
01-02	6	4.0L	Sport Models, Code E Eng., 1st or 2nd Rear Conv.	--	608226 ③
01-02	6	4.0L	Sport Models, Code E Eng., Rear Conv., Complete Assembly	645420 ③	--

③ Federal & California Emissions. Not For Sale or Use on vehicles licensed in the state of CA & NY (NY vehicles with CA Emissions). Check with your state authority for details.



APPLICATION LISTINGS FEDERAL CONVERTERS

YR/YRS	CYL	LITER	DESCRIPTION	DIRECT FIT	UNIVERSAL
FORD EXPLORER (Cont.)					
01-02	6	4.0L	Sport Trac, Code E Eng., Front Conv. w/Y Pipe	641178 ③	--
01-02	6	4.0L	Sport Trac, Code E Eng., 1st or 2nd Rear Conv.	--	608226③
01-02	6	4.0L	Sport Trac, Code E Eng., Rear Conv., Complete Assembly	645420 ③	--
2001	6	4.0L	Code "K", w/Dual Inlet Pipe Muffler, Left	642590 ③	608215③
2001	6	4.0L	Code "K", w/Dual Inlet Pipe Muffler, Right Conv. w/Left Side Extension Pipe	642293 ③	608235③
2001	6	4.0L	Code "K", w/Dual Inlet Pipe Muffler, Right Conv. w/o Left Side Extension Pipe	642589 ③	608205③
98-01	6	4.0L	LEV Code "E" Eng., w/Single Inlet Pipe Muffler, Front Convs., California Emissions	641178 ⑤	--
98-01	6	4.0L	LEV Code "E" Eng., w/Single Inlet Pipe Muffler, Rear Convs., California Emissions	645420 ⑤	--
97-01	6	4.0L	Code "E" w/Dual Inlet Pipe Muffler, Left	642590 ③	608215③
97-01	6	4.0L	Code "E", w/Dual Inlet Pipe Muffler, Right Conv. w/Left Side Extension Pipe	642293 ③	608235③
97-01	6	4.0L	Code "E", w/Dual Inlet Pipe Muffler, Right Conv. w/o Left Side Extension Pipe	642589 ③	608205③
99-00	6	4.0L	Code "X" Eng., Front Conv. w/Y Pipe	641185 ③	--
99-00	6	4.0L	Code "X" Eng., Front	--	608226③
99-00	6	4.0L	Code "X" Eng., Rear	--	608226③
99-00	6	4.0L	Code "X" Eng., Complete Assembly, Rear	645391 ③	--
96-98	6	4.0L	Code "X" Front	--	608226③
96-98	6	4.0L	Code "X" Rear	--	608226③
96-98	6	4.0L	Code "X" Complete Assembly	645360 ③	--
1995	6	4.0L	Front	--	609006③
1995	6	4.0L		--	609006③
1995	6	4.0L	Complete Assembly	645360 ③	--
91-94	6	4.0L	Front	--	602205③
91-94	6	4.0L		--	602205③
91-94	6	4.0L	2 to 1 Conv. Replacement, OEM Y-Pipe must be trimmed 1/2" from face of flange for proper insertion into converter.	645339 ③	609005③
07-10	8	4.6L	Sport Trac, Complete Assembly	643056 ③	--
06-10	8	4.6L	Complete Assembly	643056 ③	--
02-05	8	4.6L	Complete Assembly	645872 ③	--
02-05	8	4.6L	Front Right	--	608214③
02-05	8	4.6L	Rear Universal	--	608226③
02-05	8	4.6L	Front Left	--	608214③
98-00	8	5.0L	Left; From 2/98	642925 ③	--
98-00	8	5.0L	Right; From 2/98	642926 ③	--
96-98	8	5.0L	Front Right; To 1/98	642611 ③	--
96-98	8	5.0L	Front Left; To 1/98	642612 ③	--
96-98	8	5.0L	Rear Left; To 1/98	--	608225③
96-98	8	5.0L	Rear Right; To 1/98	--	608225③
96-98	8	5.0L	Complete Rear Assembly; To 1/98	645370 ③	--
FORD F-100 PICKUP 1/2 TON					
75-79	6	4.9L		--	602204③
80-83	6	All		--	602005③

③ Federal & California Emissions. Not For Sale or Use on vehicles licensed in the state of CA & NY (NY vehicles with CA Emissions). Check with your state authority for details.

⑤ California Emissions. Not For Sale or Use on vehicles licensed in the state of CA & NY. Check with your state authority.

APPLICATION LISTINGS

FEDERAL CONVERTERS



YR/YRS	CYL	LITER	DESCRIPTION	DIRECT FIT	UNIVERSAL
FORD F-100 PICKUP 1/2 TON (Cont.)					
81-82	8	4.2L		--	602005③
81-82	8	4.2L	California Emissions	--	602005⑤
80-83	8	5.0L	Federal Emissions	--	602005④
80-83	8	5.0L	California Emissions	--	602005⑤
75-79	8	5.0L		--	602204③
1981	8	5.8L		--	602005③
FORD F-150 PICKUP 1/2 TON					
11-14	6	3.7L	Left	645202 ③	--
11-14	6	3.7L	Right	645203 ③	--
05-08	6	4.2L	Left	645462 ③	--
05-08	6	4.2L	Right, Auto Trans.	645832 ③	--
2004	6	4.2L	Right, 2WD, (Heritage)	645255 ③	--
2004	6	4.2L	Left, 2WD, (Heritage)	645256 ③	--
2004	6	4.2L	Rear Left, (Heritage)	--	608226③
2004	6	4.2L	Front Left, (Heritage)	--	608286③
2004	6	4.2L	Rear Right, (Heritage)	--	608226③
2004	6	4.2L	Front Right, (Heritage)	--	608286③
2004	6	4.2L	Heritage, 4WD, Left	645220 ③	--
2004	6	4.2L	Heritage, 4WD, Right	645221 ③	--
00-03	6	4.2L	Left, 2WD	645389 ③④	--
			Left, 2WD	645256 ③	--
00-03	6	4.2L	Right, 2WD	645388 ③④	--
			Right, 2WD	645255 ③	--
00-03	6	4.2L	Front Right	--	608286③
00-03	6	4.2L	Rear Right	--	608226③
00-03	6	4.2L	Front Left	--	608286③
00-03	6	4.2L	Rear Left	--	608226③
00-03	6	4.2L	4WD, Left	645220 ③	--
00-03	6	4.2L	4WD, Right	645221 ③	--
99-00	6	4.2L	4WD, California Emissions, Left	645210 ⑤	--
99-00	6	4.2L	4WD, California Emissions, Right	645211 ⑤	--
1999	6	4.2L	4WD, Front Right	--	608286③
1999	6	4.2L	4WD, Rear, Right	--	608226③
1999	6	4.2L	4WD, Front Left	--	608286③
1999	6	4.2L	4WD, Rear Left	--	608226③
97-99	6	4.2L	RWD, With 2 Converters, Left	645389 ③④	--
			RWD, With 2 Converters, Left	645256 ③	--
97-99	6	4.2L	RWD, With 2 Converters, Right	645388 ③④	--
			RWD, With 2 Converters, Right	645255 ③	--
97-99	6	4.2L	2WD, Front, Right	--	608286③
97-99	6	4.2L	2WD, Rear, Right	--	608226③
97-99	6	4.2L	2WD, Front, Left	--	608286③
97-99	6	4.2L	2WD, Rear, Left	--	608226③
97-98	6	4.2L	4WD, Complete Assembly, Right	645432 ③	--
97-98	6	4.2L	4WD, Complete Assembly, Left	645434 ③	--
97-98	6	4.2L	4WD, Front Right	--	608286③
97-98	6	4.2L	4WD, Rear, Right	--	608226③

- ④ Discontinued, use until inventory is depleted.
- ③ Federal & California Emissions. Not For Sale or Use on vehicles licensed in the state of CA & NY (NY vehicles with CA Emissions). Check with your state authority for details.
- ④ Federal Emissions. Not For Sale or Use on vehicles licensed in the state of CA. Check with your state authority.
- ⑤ California Emissions. Not For Sale or Use on vehicles licensed in the state of CA & NY. Check with your state authority.



APPLICATION LISTINGS FEDERAL CONVERTERS

YR/YRS	CYL	LITER	DESCRIPTION	DIRECT FIT	UNIVERSAL
FORD F-150 PICKUP 1/2 TON (Cont.)					
97-98	6	4.2L	4WD, Front Left	--	608286 ^③
97-98	6	4.2L	4WD, Rear Left	--	608226 ^③
97-98	6	4.2L	RWD, With 1 Converter, Left	645222 ^③	--
97-98	6	4.2L	RWD, With 1 Converter, Right	645223 ^③	--
1996	6	4.9L	Front, 2WD	--	608240 ^③
1996	6	4.9L	Rear, 2WD	--	608006 ^③
1996	6	4.9L	2WD	645898 ^③	--
1996	6	4.9L	Front, 4WD	--	608240 ^③
1996	6	4.9L	Rear, 4WD	--	608006 ^③
87-95	6	4.9L	Front, Dual Inlet	--	609244 ^③
87-95	6	4.9L		--	609006 ^③
87-95	6	4.9L	2 to 1 Conv. Replacement	645928 ☆ ^③	609006 ^③
84-86	6	4.9L	Front	--	602205 ^③
84-86	6	4.9L		--	602005 ^③
84-86	6	4.9L	2 to 1 Conv. Replacement	--	609005 ^③
80-83	6	4.9L		--	602005 ^③
75-79	6	All		--	602204 ^③
09-10	8	4.6L	RWD, 16 Valve Engine, Left	645204 ^③	--
09-10	8	4.6L	RWD, 16 Valve Engine, Right	645205 ^③	--
09-10	8	4.6L	4WD, 24 Valve Engine, Left	645177 ^③	--
09-10	8	4.6L	4WD, 24 Valve Engine, Right	645178 ^③	--
06-08	8	4.6L	Right	--	608315 ^③
06-08	8	4.6L	Left	--	608315 ^③
06-08	8	4.6L	4WD, Left	645200 ^③	--
06-08	8	4.6L	4WD, Right	645201 ^③	--
05-08	8	4.6L	RWD, Left	645208 ^③	--
05-08	8	4.6L	RWD, Right	645209 ^③	--
04-05	8	4.6L	To 8/8/05, 2WD, Right, (2004 New Body Style), With 2 Conv. Bodies	645831 ^③	--
04-05	8	4.6L	To 8/8/05, 2WD, Left, (2004 New Body Style), With 2 Conv. Bodies	645449 ^③	--
2004	8	4.6L	RWD, With 1 Converter, Left	645208 ^③	--
2004	8	4.6L	RWD, With 1 Converter, Right	645209 ^③	--
01-03	8	4.6L	2WD, Rear, Right	--	608226 ^③
01-03	8	4.6L	2WD, Complete Assembly, Right	645412 ^③	--
01-03	8	4.6L	2WD, Front, Right	--	608286 ^③
01-03	8	4.6L	2WD, Rear, Right	--	608226 ^③
01-03	8	4.6L	2WD, Complete Assembly, Left	645413 ^③	--
01-03	8	4.6L	4WD, Rear, Right	--	608226 ^③
01-03	8	4.6L	4WD, Front Right	--	608286 ^③
01-03	8	4.6L	4WD, Rear, Right	--	608226 ^③
01-03	8	4.6L	2WD, Front, Left	--	608286 ^③
01-03	8	4.6L	2WD, Rear, Left	--	608226 ^③
01-03	8	4.6L	4WD, Front Left	--	608286 ^③
01-03	8	4.6L	4WD, Rear Left	--	608226 ^③
01-02	8	4.6L	4WD, Left	645213 ^③	--
01-02	8	4.6L	4WD, Right	645214 ^③	--
99-00	8	4.6L	2WD, Right	645395 ^③	--
99-00	8	4.6L	2WD, Left	645396 ^③	--

☆ Air Tube kit 4948 may be required for installation.

③ Federal & California Emissions. Not For Sale or Use on vehicles licensed in the state of CA & NY (NY vehicles with CA Emissions). Check with your state authority for details.

APPLICATION LISTINGS

FEDERAL CONVERTERS



YR/YRS	CYL	LITER	DESCRIPTION	DIRECT FIT	UNIVERSAL
FORD F-150 PICKUP 1/2 TON (Cont.)					
99-00	8	4.6L	2WD, Front, Right	--	608286③
99-00	8	4.6L	2WD, Rear, Right	--	608226③
99-00	8	4.6L	4WD, Front Right	--	608286③
99-00	8	4.6L	4WD, Rear, Right	--	608226③
99-00	8	4.6L	2WD, Front, Left	--	608286③
99-00	8	4.6L	2WD, Rear, Left	--	608226③
99-00	8	4.6L	4WD, Front Left	--	608286③
99-00	8	4.6L	4WD, Rear Left	--	608226③
97-00	8	4.6L	4WD, Right	645402 ③	--
97-00	8	4.6L	4WD, Left	645403 ③	--
97-98	8	4.6L	2WD, Right	645395 ③	--
97-98	8	4.6L	2WD, Left	645396 ③	--
97-98	8	4.6L	Front Right	--	608286③
97-98	8	4.6L	Rear Right	--	608226③
97-98	8	4.6L	Front Left	--	608286③
97-98	8	4.6L	Rear Left	--	608226③
11-14	8	5.0L	Left	645198 ③	--
11-14	8	5.0L	Right	645199 ③	--
1996	8	5.0L	Front	--	608240③
1996	8	5.0L		--	608006③
1996	8	5.0L	Complete Assembly	645923 ☆③	--
85-95	8	5.0L	EFI Eng., Front, Dual Inlet	--	609244③
85-95	8	5.0L	EFI Eng., Rear	--	609006③
85-95	8	5.0L	EFI Eng., 2 to 1 Conv. Replacement	645911 ③	609006③
84-85	8	5.0L	(Exc. EFI), Front, Dual Inlet	--	609244③
84-85	8	5.0L	(Exc. EFI), Rear	--	609006③
84-85	8	5.0L	(Exc. EFI), 2 to 1 Conv. Replacement	--	609006③
1983	8	5.0L	Single Conv. System	--	609005③
80-82	8	5.0L		--	609006③
75-79	8	5.0L		--	602204③
09-10	8	5.4L	Left	645281 ③	--
09-10	8	5.4L	Right	645282 ③	--
05-08	8	5.4L	2WD, Right	645843 ③	608316③
05-08	8	5.4L	2WD, Left	645461 ③	608316③
04-08	8	5.4L	4WD, Right, (2004 New Body Style)	645829 ③	608316③
04-08	8	5.4L	4WD, Left, (2004 New Body Style)	645471 ③	608316③
04-06	8	5.4L	4WD, w/ 2 Converters, California Emissions, Base Payload, To 8/8/05, Left	645217 ⑤	--
04-06	8	5.4L	4WD, w/ 2 Converters, California Emissions, Base Payload, To 8/8/05, Right	645218 ⑤	--
04-05	8	5.4L	RWD, With 2 Converters, Left	645215 ③	--
04-05	8	5.4L	RWD, With 2 Converters, Right	645216 ③	--
2004	8	5.4L	Heritage SVT Lightning, Left	645206 ③	--
2004	8	5.4L	Heritage SVT Lightning, Right	645207 ③	--
01-04	8	5.4L	4WD, Right, w/ Rear O2 sensor port between converter bodies. (2004 Old Body Style)	645895 ③	--

☆ Air Tube kit 4948 may be required for installation.

③ Federal & California Emissions. Not For Sale or Use on vehicles licensed in the state of CA & NY (NY vehicles with CA Emissions). Check with your state authority for details.

⑤ California Emissions. Not For Sale or Use on vehicles licensed in the state of CA & NY. Check with your state authority.



APPLICATION LISTINGS FEDERAL CONVERTERS

YR/YRS	CYL	LITER	DESCRIPTION	DIRECT FIT	UNIVERSAL
FORD F-150 PICKUP 1/2 TON (Cont.)					
01-04	8	5.4L	4WD, Left, w/ Rear O2 sensor port between converter bodies. (2004 Old Body Style)	645399 ③	--
01-04	8	5.4L	4WD, Front Right, (2004 Old Body Style)	--	608286 ③
01-04	8	5.4L	4WD, Rear Right, (2004 Old Body Style)	--	608226 ③
01-04	8	5.4L	4WD, Front Left, (2004 Old Body Style)	--	608286 ③
01-04	8	5.4L	4WD, Rear Left, (2004 Old Body Style)	--	608226 ③
01-03	8	5.4L	Lightning, Harley-Davidson Edition, 4R100 Trans. Mfg Code, Left	645206 ③	--
01-03	8	5.4L	Lightning, Harley-Davidson Edition, 4R100 Trans. Mfg Code, Right	645207 ③	--
01-02	8	5.4L	2WD, Front, Left	--	608286 ③
01-02	8	5.4L	2WD, Rear, Left	--	608226 ③
01-02	8	5.4L	2WD, 4R70W Trans., Complete Assembly, Right	645415 ③	--
01-02	8	5.4L	2WD, 4R70W Trans., Complete Assembly, Left	645416 ③	--
01-02	8	5.4L	2WD, Front, Right	--	608286 ③
01-02	8	5.4L	2WD, Rear, Right	--	608226 ③
98-00	8	5.4L	4WD, 4R100 Trans., Right	645384 ③	--
98-00	8	5.4L	4WD, 4R100 Trans., Left	645385 ③	--
98-00	8	5.4L	4WD, 4R70W Trans., Right	645467 ③	--
98-00	8	5.4L	4WD, 4R70W Trans., Left	645468 ③	--
97-00	8	5.4L	2WD & 4WD, Front Left	--	608286 ③
97-00	8	5.4L	2WD & 4WD, Rear Left	--	608226 ③
97-00	8	5.4L	2WD & 4WD, Front Right	--	608286 ③
97-00	8	5.4L	2WD & 4WD, Rear Right	--	608226 ③
1996	8	5.8L	Front	--	608240 ③
1996	8	5.8L		--	608006 ③
1995	8	5.8L	Front, Dual Inlet	--	609244 ③
1995	8	5.8L		--	609006 ③
1995	8	5.8L	2 to 1 Conv. Replacement	645933 ☆③	609006 ③
88-94	8	5.8L	Front, Dual Inlet	--	609244 ③
88-94	8	5.8L		--	609006 ③
88-94	8	5.8L	2 to 1 Conv. Replacement	645933 ☆③	609006 ③
84-86	8	5.8L	Front, Dual Inlet	--	609244 ③
84-86	8	5.8L		--	609006 ③
84-86	8	5.8L	2 to 1 Conv. Replacement	--	609006 ③
82-83	8	5.8L	Front, Dual Inlet	--	609244 ③
82-83	8	5.8L		--	609006 ③
82-83	8	5.8L	2 to 1 Conv. Replacement	--	609006 ③
80-81	8	5.8L		--	609006 ③
77-79	8	5.8L		--	609005 ③
77-79	8	6.6L		--	604005 ③
FORD F-250 PICKUP 3/4 TON					
1996	6	4.9L	Front, 2WD	--	608240 ③
1996	6	4.9L	Rear, 2WD	--	608006 ③
1996	6	4.9L	2WD	645898 ③	--
1996	6	4.9L	Front, 4WD	--	608240 ③
1996	6	4.9L	Rear, 4WD	--	608006 ③
87-95	6	4.9L	Front, Dual Inlet	--	609244 ③
87-95	6	4.9L		--	609006 ③

☆ Air Tube kit 4948 may be required for installation.

③ Federal & California Emissions. Not For Sale or Use on vehicles licensed in the state of CA & NY (NY vehicles with CA Emissions). Check with your state authority for details.

APPLICATION LISTINGS

FEDERAL CONVERTERS



YR/YRS	CYL	LITER	DESCRIPTION	DIRECT FIT	UNIVERSAL
FORD F-250 PICKUP 3/4 TON (Cont.)					
87-95	6	4.9L	2 to 1 Conv. Replacement	645928 ☆③	609006③
84-86	6	4.9L	Front	--	602205③
84-86	6	4.9L		--	602005③
84-86	6	4.9L	2 to 1 Conv. Replacement	--	609005③
80-83	6	4.9L		--	602005③
75-79	6	All		--	602204③
97-98	8	4.6L	2WD, Right	645395 ③	--
97-98	8	4.6L	2WD, Left	645396 ③	--
1996	8	5.0L	Front, Dual Inlet	--	608240③
1996	8	5.0L		--	608006③
1996	8	5.0L	2 to 1 Conv. Replacement	645923 ☆③	--
85-95	8	5.0L	EFI Eng., Front, Dual Inlet	--	609244③
85-95	8	5.0L	EFI Eng., Rear	--	609006③
85-95	8	5.0L	EFI Eng., 2 to 1 Conv. Replacement	645911 ☆③	609006③
84-85	8	5.0L	(Exc. EFI), Front, Dual Inlet	--	609244③
84-85	8	5.0L	(Exc. EFI), Rear	--	609006③
84-85	8	5.0L	(Exc. EFI), 2 to 1 Conv. Replacement	--	609006③
1983	8	5.0L	Single Conv. System	--	609005③
80-82	8	5.0L		--	609006③
75-79	8	5.0L		--	602204③
08-10	8	5.4L	Super Duty	645212 ③	--
05-07	8	5.4L	Complete Y Assembly	643047 ③	--
05-07	8	5.4L	Super Duty, w/ Center O2 Port, OEM Torpedo Style, Rear	646320 ③	--
05-07	8	5.4L	Super Duty, w/o Center O2 Port, OEM Torpedo Style	646323 ③	--
01-03	8	5.4L	4WD, Front Left	--	608286③
01-03	8	5.4L	4WD, Rear, Right	--	608226③
01-03	8	5.4L	4WD, Front Right	--	608286③
01-03	8	5.4L	4WD, Rear Left	--	608226③
00-03	8	5.4L	To 12000 lbs GVW, w/o Rear O2 Sensor, Federal Emissions	646902 ④	606007④
1999	8	5.4L	Single Conv. System, To 12000 lbs GVW, w/o O2 Sensor	646901 ☆③	606007③
1999	8	5.4L	Super Duty, w/ O2 Sensor Port, Federal Emissions, OEM Torpedo Style	646319 ④	--
98-99	8	5.4L	Dual Conv. System, 4WD, 4R100 Trans., To 8600 lbs GVW, Right	645384 ③	--
98-99	8	5.4L	Dual Conv. System, 4WD, 4R100 Trans., To 8600 lbs GVW, Left	645385 ③	--
98-99	8	5.4L	Dual Conv. System, 4WD, 4R70W Trans., Exc. Super Duty, Right	645467 ③	--
98-99	8	5.4L	Dual Conv. System, 4WD, 4R70W Trans., Exc. Super Duty, Left	645468 ③	--
97-99	8	5.4L	Dual Conv. System, To 8600 lbs GVW, Front Right	--	608286③
97-99	8	5.4L	Dual Conv. System, To 8600 lbs GVW, Rear Right	--	608226③
97-99	8	5.4L	Dual Conv. System, To 8600 lbs GVW, Front Left	--	608286③
97-99	8	5.4L	Dual Conv. System, To 8600 lbs GVW, Rear Left	--	608226③
1998	8	5.4L	To 12000 lbs GVW	646303 ③	607007③
96-97	8	5.8L	To 9200 lbs GVW, w/ 2-1/2" Outlet Pipe	645343 ③	--
96-97	8	5.8L	To 9200 lbs GVW, w/ 3" Outlet Pipe	645345 ③	--
96-97	8	5.8L	To 12000 lbs GVW, w/ 2-1/2" Outlet Pipe	646303 ③	607007③
96-97	8	5.8L	To 12000 lbs GVW, w/ 3" Outlet Pipe	646302 ③	--
1996	8	5.8L	Light Duty, Front	--	608240③
1996	8	5.8L	Light Duty, Rear	--	608006③

☆ Air Tube kit 4948 may be required for installation.

③ Federal & California Emissions. Not For Sale or Use on vehicles licensed in the state of CA & NY (NY vehicles with CA Emissions). Check with your state authority for details.

④ Federal Emissions. Not For Sale or Use on vehicles licensed in the state of CA. Check with your state authority.



APPLICATION LISTINGS FEDERAL CONVERTERS

YR/YRS	CYL	LITER	DESCRIPTION	DIRECT FIT	UNIVERSAL
FORD F-250 PICKUP 3/4 TON (Cont.)					
1995	8	5.8L	Light Duty, Front, Dual Inlet	--	609244③
1995	8	5.8L	Light Duty, Rear	--	609006③
1995	8	5.8L	Light Duty, 2 to 1 Conv. Replacement	645933 ☆③	609006③
94-95	8	5.8L	To 9200 lbs GVW, (Exc. 4 Bolt Flange Inlet)	645344 ③	605007③
94-95	8	5.8L	To 9200 lbs GVW, 4 Bolt Flange Inlet, w/ 2-1/2" Outlet Pipe	645343 ③	--
94-95	8	5.8L	To 9200 lbs GVW, 4 Bolt Flange Inlet, w/ 3" Outlet Pipe	645345 ③	--
94-95	8	5.8L	To 12000 lbs GVW, 4 Bolt Flange Inlet, w/ 2-1/2" Outlet Pipe	646303 ③	607007③
94-95	8	5.8L	To 12000 lbs GVW, 4 Bolt Flange Inlet, w/ 3" Outlet Pipe	646302 ③	--
94-95	8	5.8L	To 12000 lbs GVW, (Exc. 4 Bolt Flange Inlet)	646301 ③	607007③
94-95	8	5.8L	California Emissions, To 9200 lbs GVW, (Exc. 4 Bolt Flange Inlet)	645344 ⑤	605007⑤
94-95	8	5.8L	California Emissions, To 9200 lbs GVW, 4 Bolt Flange Inlet	645343 ⑤	--
88-94	8	5.8L	Light Duty, Front, Dual Inlet	--	609244③
88-94	8	5.8L	Light Duty, Rear	--	609006③
88-94	8	5.8L	Light Duty, 2 to 1 Conv. Replacement	645933 ☆③	609006③
87-93	8	5.8L	To 9200 lbs GVW, 4 Bolt Flange Inlet, w/ 2-1/2" Outlet Pipe	645343 ③	--
87-93	8	5.8L	To 9200 lbs GVW, 4 Bolt Flange Inlet, w/ 3" Outlet Pipe	645345 ③	--
87-93	8	5.8L	To 12000 lbs GVW, 4 Bolt Flange Inlet, w/ 2-1/2" Outlet Pipe	646303 ③	607007③
87-93	8	5.8L	To 12000 lbs GVW, 4 Bolt Flange Inlet, w/ 3" Outlet Pipe	646302 ③	--
87-93	8	5.8L	To 9200 lbs GVW, California Emissions	645343 ⑤	--
87-93	8	5.8L	To 9200 lbs GVW, (Exc. 4 Bolt Flange Inlet)	645344 ③	605007③
87-93	8	5.8L	To 12000 lbs GVW, (Exc. 4 Bolt Flange Inlet)	646301 ③	607007③
87-93	8	5.8L	To 9200 lbs GVW, California Emissions, 4 Bolt Flange Inlet	645343 ⑤	--
84-86	8	5.8L	Front, Dual Inlet	--	609244③
84-86	8	5.8L		--	609006③
84-86	8	5.8L	2 to 1 Conv. Replacement	--	609006③
82-83	8	5.8L	Front, Dual Inlet	--	609244③
82-83	8	5.8L		--	609006③
82-83	8	5.8L	2 to 1 Conv. Replacement	--	609006③
80-81	8	5.8L		--	609006③
77-79	8	5.8L		--	609005③
1980	8	6.6L		--	604006③
77-79	8	6.6L		--	604005③
96-97	8	7.5L	To 9200 lbs GVW, w/ 2-1/2" Outlet Pipe	645343 ③	--
96-97	8	7.5L	To 9200 lbs GVW, w/ 3" Outlet Pipe	645345 ③	--
96-97	8	7.5L	To 12000 lbs GVW, w/ 2-1/2" Outlet Pipe	646303 ③	607007③
96-97	8	7.5L	To 12000 lbs GVW, w/ 3" Outlet Pipe	646302 ③	--
94-95	8	7.5L	To 9200 lbs GVW, (Exc. 4 Bolt Flange Inlet)	645344 ③	605007③
94-95	8	7.5L	To 9200 lbs GVW, 4 Bolt Flange Inlet, w/ 2-1/2" Outlet Pipe	645343 ③	--
94-95	8	7.5L	To 9200 lbs GVW, 4 Bolt Flange Inlet, w/ 3" Outlet Pipe	645345 ③	--
94-95	8	7.5L	To 12000 lbs GVW, 4 Bolt Flange Inlet, w/ 2-1/2" Outlet Pipe	646303 ③	607007③
94-95	8	7.5L	To 12000 lbs GVW, 4 Bolt Flange Inlet, w/ 3" Outlet Pipe	646302 ③	--
94-95	8	7.5L	To 12000 lbs GVW, (Exc. 4 Bolt Flange Inlet)	646301 ③	607007③
87-93	8	7.5L	To 9200 lbs GVW, 4 Bolt Flange Inlet, w/ 2-1/2" Outlet Pipe	645343 ③	--
87-93	8	7.5L	To 9200 lbs GVW, 4 Bolt Flange Inlet, w/ 3" Outlet Pipe	645345 ③	--
87-93	8	7.5L	To 12000 lbs GVW, 4 Bolt Flange Inlet, w/ 2-1/2" Outlet Pipe	646303 ③	607007③
87-93	8	7.5L	To 12000 lbs GVW, 4 Bolt Flange Inlet, w/ 3" Outlet Pipe	646302 ③	--
87-93	8	7.5L	To 9200 lbs GVW, (Exc. 4 Bolt Flange Inlet)	645344 ☆③	605007③

☆ Air Tube kit 4948 may be required for installation.

③ Federal & California Emissions. Not For Sale or Use on vehicles licensed in the state of CA & NY (NY vehicles with CA Emissions). Check with your state authority for details.

⑤ California Emissions. Not For Sale or Use on vehicles licensed in the state of CA & NY. Check with your state authority.

APPLICATION LISTINGS

FEDERAL CONVERTERS



YR/YRS	CYL	LITER	DESCRIPTION	DIRECT FIT	UNIVERSAL
FORD F-250 PICKUP 3/4 TON (Cont.)					
87-93	8	7.5L	To 12000 lbs GVW, (Exc. 4 Bolt Flange Inlet)	646301 ☆③	607007③
1979	8	7.5L		--	604006③
08-10	10	6.8L	Super Duty	645212 ③	--
05-07	10	6.8L	Super Duty, w/ Center O2 Port, OEM Torpedo Style, Rear	646320 ③	--
05-07	10	6.8L	Super Duty, w/o Center O2 Port, OEM Torpedo Style	646323 ③	--
99-03	10	6.8L	To 12000 lbs GVW, w/o Rear O2 Sensor, Federal Emissions	646902 ④	606007④
1999	10	6.8L	Super Duty, w/ O2 Sensor Port, Federal Emissions, OEM Torpedo Style	646319 ④	--
				--	--
FORD F-350 PICKUP 1 TON					
1996	6	4.9L	Front, 2WD	--	608240③
1996	6	4.9L	Rear, 2WD	--	608006③
1996	6	4.9L	Front & Rear, 2WD	645898 ③	--
87-95	6	4.9L	Under 8500 lbs GVW, Front, Dual Inlet	--	609244③
87-95	6	4.9L	Under 8500 lbs GVW, Rear	--	609006③
87-95	6	4.9L	Under 8500 lbs GVW, 2 to 1 Conv. Replacement	645928 ☆③	609006③
84-86	6	4.9L	Under 8500 lbs GVW, Front	--	609005③
84-86	6	4.9L	Under 8500 lbs GVW, Rear	--	609005③
84-86	6	4.9L	Under 8500 lbs GVW, 2 to 1 Conv. Replacement	--	609005③
81-83	6	4.9L	Under 8500 lbs GVW	--	609005③
08-10	8	5.4L	Super Duty	645212 ③	--
07-08	8	5.4L	Rear Main Conv. After Converter Y Pipe Assembly	--	606007③
05-07	8	5.4L	Super Duty, w/ Center O2 Port, OEM Torpedo Style, Rear	646320 ③	--
05-07	8	5.4L	Super Duty, w/o Center O2 Port, OEM Torpedo Style	646323 ③	--
05-06	8	5.4L	Complete Assembly, 41" OAL, 2WD	645292 ③	--
2004	8	5.4L	Super Duty Cab & Chassis, Up To 9,900 lbs. GVW	646903 ③	--
99-03	8	5.4L	To 12000 lbs GVW, w/o Rear O2 Sensor, Federal Emissions	646902 ④	606007④
88-97	8	5.8L	To 9200 lbs GVW, 4 Bolt Flange Inlet, w/ 2-1/2" Outlet Pipe	645343 ③	--
88-97	8	5.8L	To 9200 lbs GVW, 4 Bolt Flange Inlet, w/ 3" Outlet Pipe	645345 ③	--
88-97	8	5.8L	To 12000 lbs GVW, 4 Bolt Flange Inlet, w/ 2-1/2" Outlet Pipe	646303 ③	607007③
88-97	8	5.8L	To 12000 lbs GVW, 4 Bolt Flange Inlet, w/ 3" Outlet Pipe	646302 ③	--
88-97	8	5.8L	To 9200 lbs GVW, (Exc. 4 Bolt Flange Inlet)	645344 ③	605007③
88-97	8	5.8L	To 12,000 lbs GVW, (Exc. 4 Bolt Flange Inlet)	646301 ③	607007③
88-95	8	5.8L	To 9200 lbs GVW, (Exc. 4 Bolt Flange Inlet), California Emissions	645344 ⑤	605007⑤
88-95	8	5.8L	To 9200 lbs GVW, 4 Bolt Flange Inlet, California Emissions	645343 ⑤	--
87-89	8	5.8L	To 9200 lbs GVW	645343 ③	--
87-89	8	5.8L	To 12000 lbs GVW	646303 ③	607007③
88-97	8	7.5L	To 9200 lbs GVW, 4 Bolt Flange Inlet, w/ 2-1/2" Outlet Pipe	645343 ③	--
88-97	8	7.5L	To 9200 lbs GVW, 4 Bolt Flange Inlet, w/ 3" Outlet Pipe	645345 ③	--
88-97	8	7.5L	To 12000 lbs GVW, 4 Bolt Flange Inlet, w/ 2-1/2" Outlet Pipe	646303 ③	607007③
88-97	8	7.5L	To 12000 lbs GVW, 4 Bolt Flange Inlet, w/ 3" Outlet Pipe	646302 ③	--
88-97	8	7.5L	To 9200 lbs GVW, (Exc. 4 Bolt Flange Inlet)	645344 ③	605007③
88-97	8	7.5L	To 12,000 lbs GVW, (Exc. 4 Bolt Flange Inlet)	646301 ③	607007③
87-89	8	7.5L	To 9200 lbs GVW	645343 ③	--
87-89	8	7.5L	To 12000 lbs GVW	646303 ③	607007③
08-10	10	6.8L	Super Duty	645212 ③	--
07-08	10	6.8L	Rear Main Conv. After Converter Y Pipe Assembly	--	606007③
05-07	10	6.8L	Super Duty, w/ Center O2 Port, OEM Torpedo Style, Rear	646320 ③	--

☆ Air Tube kit 4948 may be required for installation.

③ Federal & California Emissions. Not For Sale or Use on vehicles licensed in the state of CA & NY (NY vehicles with CA Emissions). Check with your state authority for details.

④ Federal Emissions. Not For Sale or Use on vehicles licensed in the state of CA. Check with your state authority.

⑤ California Emissions. Not For Sale or Use on vehicles licensed in the state of CA & NY. Check with your state authority.



APPLICATION LISTINGS FEDERAL CONVERTERS

YR/YRS	CYL	LITER	DESCRIPTION	DIRECT FIT	UNIVERSAL
FORD F-350 PICKUP 1 TON (Cont.)					
05-07	10	6.8L	Super Duty, w/o Center O2 Port, OEM Torpedo Style	646323 ③	--
99-03	10	6.8L	To 12000 lbs GVW, w/o Rear O2 Sensor, Federal Emissions	646902 ④	606007④
1999	10	6.8L	To 12000 lbs GVW, w/O2 Sensor	646312 ③	606007③
1999	10	6.8L	To 12000 lbs GVW, w/o O2 Sensor	646901 ③	606007③
1999	10	6.8L	Super Duty, w/ O2 Sensor Port, Federal Emissions, OEM Torpedo Style	646319 ④	--
				--	--
FORD F-450 PICKUP 1-1/2 TON					
94-95	8	7.5L	To 12000 lbs GVW	646302 ③	607007③
90-93	8	7.5L	To 12000 lbs GVW	646303 ③	607007③
05-07	10	6.8L	Super Duty, w/ Center O2 Port, OEM Torpedo Style, Rear	646320 ③	--
05-07	10	6.8L	Super Duty, w/o Center O2 Port, OEM Torpedo Style	646323 ③	--
04-07	10	6.8L		--	606007③
2003	10	6.8L		--	606007③
1999	10	6.8L		646312 ③	--
1999	10	6.8L	Super Duty, w/ O2 Sensor Port, Federal Emissions, OEM Torpedo Style	646319 ④	--
				--	--
FORD F-550 SUPER DUTY					
05-07	10	6.8L	W/ Center O2 Port, OEM Torpedo Style, Rear	646320 ③	--
05-07	10	6.8L	W/O Center O2 Port, OEM Torpedo Style	646323 ③	--
FORD FAIRMONT, FUTURA					
1983	4	2.3L	39" Conv.	--	602004③
81-83	4	2.3L	(Exc. 39" Conv.)	--	602005③
78-80	4	2.3L	17" Conv.	--	602204③
78-83	6	3.3L	Rear	--	602204③
78-83	6	3.3L	Main & Pre-Cat	--	602004③
1982	8	4.2L	w/23" Rear Conv.	--	602005③
1982	8	4.2L	Main & Pre-Cat, 23" Rear Conv.	--	602004③
1982	8	4.2L	w/25" Conv., Rear	--	602004③
1982	8	4.2L	Main & Pre-Cat, 25" Rear Conv.	--	602004③
1981	8	4.2L		--	602005③
1981	8	4.2L	Main & Pre-Cat	--	602004③
1980	8	4.2L		--	602204③
1980	8	4.2L	Main & Pre-Cat	--	602004③
78-79	8	5.0L	Rear	--	602204③
FORD FESTIVA					
90-93	4	1.3L		--	602294③
88-89	4	1.3L	w/Air Tube	--	602004③
88-89	4	1.3L	w/o Air Tube	642403 ③	602204③
FORD FIESTA					
78-80	4	1.6L		--	602204③
FORD FIVE HUNDRED					
05-07	6	3.0L	Front, 2WD	642252 ③	--
05-07	6	3.0L	Front, AWD	642243 ③	--
05-07	6	3.0L		642251 ③	--
05-07	6	3.0L	Rear Main Conv.	642250 ③	608285③○

③ Federal & California Emissions. Not For Sale or Use on vehicles licensed in the state of CA & NY (NY vehicles with CA Emissions). Check with your state authority for details.

④ Federal Emissions. Not For Sale or Use on vehicles licensed in the state of CA. Check with your state authority.

○ EPA Enhanced OBDII By Design Unit

APPLICATION LISTINGS

FEDERAL CONVERTERS



YR/YRS	CYL	LITER	DESCRIPTION	DIRECT FIT	UNIVERSAL
FORD FLEX					
09-10	6	3.5L	Rear Main Conv.	--	608265③○
09-10	6	3.5L	To 03/09/10, Non-Turbo, Engine Code "C", Front	642215 ③	--
09-10	6	3.5L	To 03/09/10, Non-Turbo, Engine Code "C", Rear	642214 ③	--
FORD FOCUS					
09-10	4	2.0L	Auto Trans., Exc. PZEV, Manifold Unit, Front	641390 ③	--
05-08	4	2.0L	Models w/ Air Manifold	641272 ③	--
05-07	4	2.0L	Front, California Emissions w/o Air Manifold	641247 ⑤	--
05-07	4	2.0L	Rear, California Emission	642269 ⑤	608414⑤○
			Rear, California Emission	--	608264⑤□
03-04	4	2.0L	SVT, Engine Code 5, Manual Trans., Rear	--	608294③
03-04	4	2.0L	SVT, Engine Code 5, Manual Trans., Front	--	608294③
02-04	4	2.0L	SVT, Code "5" Engine, Front	642848 ③	--
00-04	4	2.0L	Code "P" Engine	642703 ③	--
00-04	4	2.0L	Code "3" Eng. & Auto Trans.	642719 ③	--
00-04	4	2.0L	Code "3" Eng. & Man Trans.	642799 ③	608294③
05-07	4	2.3L	Front, California Emissions w/o Air Manifold	641247 ⑤	--
05-07	4	2.3L	Rear, California Emission	642269 ⑤	608414⑤○
			Rear, California Emission	--	608264⑤□
04-07	4	2.3L	Front, w/ Air Manifold	641272 ③	--
03-04	4	2.3L		642269 ③	608414③
FORD FREESTAR					
04-07	6	3.9L		642767 ③	--
04-07	6	4.2L		642767 ③	--
FORD FREESTYLE					
05-07	6	3.0L	Front	642243 ③	--
05-07	6	3.0L		642251 ③	--
05-07	6	3.0L	Rear Main Conv.	642250 ③	608285③
FORD FUSION					
2009	4	2.3L	Rear, Federal Emissions	642269 ④	608414④
07-09	4	2.3L	With Air Tube, Auto Trans., California Emissions, Front	641321 ⑤	--
06-09	4	2.3L	Front Manifold Conv., FWD, Federal Emissions, From 09/04/06	642148 ④	--
10-12	6	3.0L	Front Right	641387 ③	--
06-12	6	3.0L	Manifold Unit, Front Left	641329 ③	--
			Manifold Unit, Front Left	641241 ③○	--
07-08	6	3.0L	Rear Manifold Conv., AWD, 09-04-06 to 12-03-07	641282 ③	--
06-08	6	3.0L	Rear Main Conv., FWD	642216 ③	608295③
06-08	6	3.0L	Rear Manifold Conv., FWD	641242 ③	--
06-08	6	3.0L	Rear Main Conv., AWD	642216 ③	608295③
2010	6	3.5L	Rear Conv.	642214 ③	--
2010	6	3.5L	Front Conv.	642215 ③	--
FORD GRANADA					
81-82	4	2.3L	(Exc. w/22" Rear Conv.), Front	--	602214③
81-82	4	2.3L	(Exc. w/22" Rear Conv.), Rear	--	602204③
81-82	4	2.3L	(Exc. w/22" Rear Conv.), Main & Pre-Cat	--	602004③
81-82	4	2.3L	w/22" Rear Conv., Front	--	602214③
81-82	4	2.3L	w/22" Rear Conv., Rear	--	602005③
81-82	4	2.3L	w/22" Rear Conv., Main & Pre-Cat	--	602004③

○ Discontinued, use until inventory is depleted.

③ Federal & California Emissions. Not For Sale or Use on vehicles licensed in the state of CA & NY (NY vehicles with CA Emissions). Check with your state authority for details.

④ Federal Emissions. Not For Sale or Use on vehicles licensed in the state of CA. Check with your state authority.

⑤ California Emissions. Not For Sale or Use on vehicles licensed in the state of CA & NY. Check with your state authority.

□ EPA OBDII By Design Unit

○ EPA Enhanced OBDII By Design Unit



APPLICATION LISTINGS FEDERAL CONVERTERS

YR/YRS	CYL	LITER	DESCRIPTION	DIRECT FIT	UNIVERSAL
FORD GRANADA (Cont.)					
81-82	6	3.3L	Rear	--	602204 [ⓐ]
81-82	6	3.3L	Main & Pre-Cat	--	602004 [ⓐ]
1982	6	3.8L	w/22" Conv., Rear	--	602005 [ⓐ]
1982	6	3.8L	w/22" Conv., Main & Pre-Cat	--	602004 [ⓐ]
1982	6	3.8L	w/25" Conv., Rear	--	602204 [ⓐ]
1982	6	3.8L	w/25" Conv., Main & Pre-Cat	--	602004 [ⓐ]
1980	6	4.1L	(Exc. w/14-1/4" Rear Conv.), Rear	--	602004 [ⓐ]
1980	6	4.1L	(Exc. w/14-1/4" Rear Conv.), Main & Pre-Cat	--	602004 [ⓐ]
78-80	6	4.1L	w/14-1/4" Conv., Rear	--	602205 [ⓐ]
77-79	6	4.1L	w/18" Conv.	--	602205 [ⓐ]
75-76	6	All		--	602204 [ⓐ]
1981	8	4.2L	w/22" Rear Conv., Rear	--	602005 [ⓐ]
1981	8	4.2L	w/22" Rear Conv., Main & Pre-Cat	--	602004 [ⓐ]
77-79	8	5.0L	(Exc. w/18" Conv.)	--	602205 [ⓐ]
77-79	8	5.0L	w/18" Conv.	--	602205 [ⓐ]
75-76	8	5.0L		--	602205 [ⓐ]
1977	8	5.8L	Left	--	602214 [ⓐ]
1977	8	5.8L	Right	--	602214 [ⓐ]
75-76	8	5.8L	Left	--	602214 [ⓐ]
75-76	8	5.8L	Right	--	602214 [ⓐ]
1980	8	All		--	602205 [ⓐ]
FORD LTD FULL SIZE					
81-82	8	4.2L	Right	--	602004 [ⓐ]
81-82	8	4.2L	Left	--	602004 [ⓐ]
81-85	8	5.0L	Right	--	602004 [ⓐ]
81-85	8	5.0L	Left	--	602004 [ⓐ]
77-78	8	5.0L	Right	--	602214 [ⓐ]
77-78	8	5.0L	Left	--	602214 [ⓐ]
83-85	8	5.8L	Right	--	609004 [ⓐ]
83-85	8	5.8L	Left	--	609004 [ⓐ]
81-82	8	5.8L	Right	--	609004 [ⓐ]
81-82	8	5.8L	Left	--	609004 [ⓐ]
75-78	8	5.8L		--	602214 [ⓐ]
75-78	8	5.8L	Left	--	602214 [ⓐ]
75-78	8	6.6L	Right	--	605004 [ⓐ]
75-78	8	6.6L	Left	--	605004 [ⓐ]
79-80	8	All	Right	--	602004 [ⓐ]
79-80	8	All	Left	--	602004 [ⓐ]
FORD LTD II					
77-79	8	All	Left	--	602214 [ⓐ]
77-79	8	All	Right	--	602214 [ⓐ]
FORD LTD MIDSIZE					
84-86	4	2.3L	w/39" Conv.	--	602004 [ⓐ]
1983	4	2.3L	Front	--	602214 [ⓐ]
1983	4	2.3L		--	602204 [ⓐ]
1983	4	2.3L	Main & Pre-Cat	--	602004 [ⓐ]
1983	6	3.3L	Rear	--	602204 [ⓐ]

[ⓐ] Federal & California Emissions. Not For Sale or Use on vehicles licensed in the state of CA & NY (NY vehicles with CA Emissions). Check with your state authority for details.

APPLICATION LISTINGS

FEDERAL CONVERTERS



YR/YRS	CYL	LITER	DESCRIPTION	DIRECT FIT	UNIVERSAL
FORD LTD MIDSIZE (Cont.)					
1983	6	3.3L	Main & Pre-Cat	--	602004 ^③
84-86	6	3.8L	w/ Fuel Injection, Rear	--	602005 ^③
84-86	6	3.8L	w/ Fuel Injection, Main & Pre-Cat	--	602005 ^③
1984	6	3.8L	w/EEC, Rear	--	602204 ^③
1984	6	3.8L	w/EEC, Main & Pre-Cat	--	602005 ^③
1984	6	3.8L	Rear, (Exc. Fuel Injection & EEC)	--	602005 ^③
1984	6	3.8L	(Exc. Fuel Injection & EEC), Main & Pre-Cat	--	602004 ^③
1983	6	3.8L		--	602005 ^③
1983	6	3.8L	Main & Pre-Cat	--	602004 ^③
FORD MAVERICK					
75-76	6	All		--	602205 ^③
75-76	8	All		--	602205 ^③
1977	6,8	All	w/14-1/4" Conv.	--	602205 ^③
1977	6,8	All	(Exc. w/14-1/4" Conv.)	--	602205 ^③
FORD MUSTANG					
87-93	4	2.3L	Front	--	602294 ^③
87-93	4	2.3L		--	602204 ^③
87-93	4	2.3L	Main & Pre-Cat	642913 ^③	602204 ^③
84-86	4	2.3L	(Exc. Turbo)	--	602004 ^③
84-86	4	2.3L	Turbo	--	602205 ^③
1983	4	2.3L	(Exc. Turbo)	--	602204 ^③
1983	4	2.3L	California Emissions	--	602004 ^⑤
1983	4	2.3L	Turbo	--	602205 ^③
79-82	4	2.3L	w/o Air Tube	--	602204 ^③
79-82	4	2.3L	w/Air Tube	--	602005 ^③
99-04	6	3.8L	Front, Left	--	608274 ^③
99-04	6	3.8L	Rear Left	--	608205 ^③
99-04	6	3.8L	Complete	642942 ^③	--
99-04	6	3.8L	Front, Right	--	608274 ^③
99-04	6	3.8L	Rear Right	--	608205 ^③
96-98	6	3.8L		642965 ^③	--
94-95	6	3.8L	Left	--	608205 ^③
94-95	6	3.8L	Right	--	608205 ^③
94-95	6	3.8L	Complete	642458 ^③	--
84-86	6	3.8L	Rear	--	602005 ^③
84-86	6	3.8L	Main & Pre-Cat	--	602005 ^③
1983	6	3.8L		--	602005 ^③
1983	6	3.8L	Main & Pre-Cat	--	602004 ^③
2004	6	3.9L	Complete	642942 ^③	--
2004	6	3.9L	Front Left	--	608274 ^③
2004	6	3.9L	Rear Left	--	608205 ^③
2004	6	3.9L	Front Right	--	608274 ^③
2004	6	3.9L	Rear Right	--	608205 ^③
08-10	6	4.0L	Complete, Federal Emissions	643004 ^④	--
08-09	6	4.0L	Left, Federal Emissions	--	608285 ^④
08-09	6	4.0L	Right, Federal Emissions	--	608285 ^④
05-07	6	4.0L	Left	--	608285 ^③

③ Federal & California Emissions. Not For Sale or Use on vehicles licensed in the state of CA & NY (NY vehicles with CA Emissions). Check with your state authority for details.

④ Federal Emissions. Not For Sale or Use on vehicles licensed in the state of CA. Check with your state authority.

⑤ California Emissions. Not For Sale or Use on vehicles licensed in the state of CA & NY. Check with your state authority.



APPLICATION LISTINGS FEDERAL CONVERTERS

YR/YRS	CYL	LITER	DESCRIPTION	DIRECT FIT	UNIVERSAL
FORD MUSTANG (Cont.)					
05-07	6	4.0L	Complete	643004 ③	--
05-07	6	4.0L	Right	--	608285③
79-82	6	All	Rear	--	602204③
79-82	6	All	Main & Pre-Cat	--	602004③
1982	8	4.2L	Rear	--	602005③
1982	8	4.2L	Main & Pre-Cat	--	602004③
1981	8	4.2L	Rear	--	602005③
1981	8	4.2L	Main & Pre-Cat	--	602005③
05-07	8	4.6L	Complete	643008 ③	--
05-07	8	4.6L	Left	--	608406③○
05-07	8	4.6L	Right	--	608406③○
2004	8	4.6L	GT	643097 ③	--
99-03	8	4.6L	Complete	643002 ③	--
99-03	8	4.6L	Front, Left	--	608285③
99-03	8	4.6L	Rear Left	--	608295③
99-03	8	4.6L	Front, Right	--	608285③
99-03	8	4.6L	Rear Right	--	608295③
96-98	8	4.6L	Rear, GT Models	--	608294③
96-98	8	4.6L	Complete, (Exc. Cobra)	642927 ③	--
96-98	8	4.6L	Center, Exc. Cobra	--	608294③
96-98	8	4.6L	Front, Exc. Cobra	--	608294③
11-14	8	5.0L	From 8/16/2010, Left	642811 ③	--
11-14	8	5.0L	From 8/16/2010, Right	642812 ③	--
94-95	8	5.0L	Front Left	--	608276③
94-95	8	5.0L	Complete	642916 ③	--
94-95	8	5.0L	Front Right	--	608276③
94-95	8	5.0L	Rear Left	--	608276③
94-95	8	5.0L	Rear Right	--	608276③
86-93	8	5.0L	Front Left	--	602005③
86-93	8	5.0L	Complete	642903 ③	--
86-93	8	5.0L	Front Right	--	602005③
86-93	8	5.0L	Rear Left	--	602005③
86-93	8	5.0L	Rear Right	--	602005③
84-85	8	5.0L	Manual Trans., Rear	--	602006③
84-85	8	5.0L	Manual Trans., Main & Pre-Cat	--	602006③
84-85	8	5.0L	Auto Trans., Rear	--	602006③
84-85	8	5.0L	Auto Trans., Main & Pre-Cat	--	602006③
1983	8	5.0L	Auto Trans., Rear	--	602006③
1983	8	5.0L	Auto Trans., Main & Pre-Cat	--	602006③
1982	8	5.0L	25" Conv., Rear	--	602005③
1982	8	5.0L	25" Conv., Main & Pre-Cat	--	602004③
79-80	8	All	Rear	--	602204③
79-80	8	All	Main & Pre-Cat	--	602004③
FORD MUSTANG II					
75-76	4	2.3L		--	602204③
75-76	6	2.8L		--	602214③
75-76	8	5.0L		--	602214③

③ Federal & California Emissions. Not For Sale or Use on vehicles licensed in the state of CA & NY (NY vehicles with CA Emissions). Check with your state authority for details.

○ EPA Enhanced OBDII By Design Unit

APPLICATION LISTINGS

FEDERAL CONVERTERS



YR/YRS	CYL	LITER	DESCRIPTION	DIRECT FIT	UNIVERSAL
FORD MUSTANG II (Cont.)					
77-78	All	All	w/14" Conv.	--	602205③
77-78	All	All	w/19" Conv.	--	602205③
FORD PINTO					
75-80	4	All	w/14" Conv.	--	602205③
75-80	4	All	w/19" Conv.	--	602205③
75-79	4	All	(Exc. w/14" or 19" Conv.)	--	602204③
77-79	6	2.8L	w/14" Conv.	--	602205③
77-79	6	2.8L	w/19" Conv.	--	602205③
75-76	6	2.8L	Left	--	602214③
75-76	6	2.8L	Right	--	602214③
FORD PROBE					
96-97	4	2.0L	Front, Includes Head Pipe	642659 ③	--
96-97	4	2.0L		642485 ③	608234③
93-95	4	2.0L		642409 ③	602205③
89-92	4	2.2L	Auto Trans., (Exc. Turbo, Reversible/Non-Directional Unit)	642485 ③	602204③
89-92	4	2.2L	Manual Trans., (Exc. Turbo)	--	602204③
96-97	6	2.5L	Main Conv.	--	608234③
93-95	6	2.5L		642448 ③	--
90-92	6	3.0L	25-3/4" Conv.	--	602205③
FORD RANCHERO					
75-79	8	5.8L	Left	--	602214③
75-79	8	5.8L	Right	--	602214③
FORD RANGER					
87-88	4	2.0L	w/o Air Tube	--	602205③
86-88	4	2.0L	w/Air Tube	--	602005③
85-86	4	2.0L	To 1/86	--	602205③
07-11	4	2.3L		645833 ③	--
01-06	4	2.3L		645871 ③	--
01-06	4	2.3L	Front Universal	--	608285③
01-06	4	2.3L	Rear Universal	--	608205③
96-97	4	2.3L		642531 ③	608235③
1995	4	2.3L		642531 ③	608235③
90-94	4	2.3L		642472 ③	602205③
89-92	4	2.3L	125" W.B.	642472 ③	602205③
86-89	4	2.3L	(Exc. 125" W.B.); From 1/86	--	602005③
86-88	4	2.3L	125" W.B., (Exc. Manual Trans.); From 1/86	642472 ③	602205③
86-88	4	2.3L	Manual Trans., 125" W.B.; From 1/86	--	602005③
85-86	4	2.3L	To 1/86	--	602205③
98-01	4	2.5L		645897 ③	608224③
1983	4	All	36-1/2" Conv.	--	602005③
83-85	6	2.8L		--	602005③
88-92	6	2.9L	Front	--	609005③
88-92	6	2.9L		--	609005③
1988	6	2.9L	Complete Assembly, OEM Y-Pipe must be trimmed 1/2" from face of flange for proper insertion into converter.	645340 ③	--
86-87	6	2.9L	Rear	--	609005③
04-06	6	3.0L	Front Conv.	641224 ③	--

③ Federal & California Emissions. Not For Sale or Use on vehicles licensed in the state of CA & NY (NY vehicles with CA Emissions). Check with your state authority for details.



APPLICATION LISTINGS FEDERAL CONVERTERS

YR/YRS	CYL	LITER	DESCRIPTION	DIRECT FIT	UNIVERSAL
FORD RANGER (Cont.)					
04-06	6	3.0L	Rear Conv.	645442 ③	--
01-03	6	3.0L	Rear Conv.	645418 ③	--
01-02	6	3.0L	Complete Assembly, Front	641250 ③	--
98-00	6	3.0L	36" Conv., Front	--	608226 ③
98-00	6	3.0L	36" Conv., Rear	--	608226 ③
98-00	6	3.0L	36" Conv., Complete Assembly	645365 ③	--
98-00	6	3.0L	With 2 Converters, California Emissions, Front	642016 ⑤	--
98-00	6	3.0L	With 2 Converters, California Emissions, Front	642016 ⑤	--
96-97	6	3.0L	Front	--	608226 ③
96-97	6	3.0L		--	608226 ③
96-97	6	3.0L	Complete Assembly	642541 ③	--
91-95	6	3.0L	Front	--	609005 ③
91-95	6	3.0L		--	609005 ③
91-95	6	3.0L	Complete Assembly, OEM Y-Pipe must be trimmed 1/2" from face of flange for proper insertion into converter.	645339 ③	--
04-06	6	4.0L	Rear	645442 ③	--
2005	6	4.0L	Front, Complete Assembly, 4WD Federal Emissions	642103 ④	--
01-03	6	4.0L	Front	641178 ③	--
01-03	6	4.0L		645418 ③	--
98-00	6	4.0L	36" Conv., Front	--	608226 ③
98-00	6	4.0L	36" Conv., Rear	--	608226 ③
98-00	6	4.0L	36" Conv., Complete Assembly	645365 ③	--
96-97	6	4.0L	Front	--	608226 ③
96-97	6	4.0L		--	608226 ③
96-97	6	4.0L	Complete Assembly	642541 ③	--
90-95	6	4.0L	Front	--	609005 ③
90-95	6	4.0L		--	609005 ③
90-95	6	4.0L	Complete Assembly, OEM Y-Pipe must be trimmed 1/2" from face of flange for proper insertion into converter.	645339 ③	--
FORD TAURUS					
00-07	6	3.0L	Front, 12 valve	642696 ③	--
00-07	6	3.0L	Rear, 12 valve	642697 ③	--
00-05	6	3.0L	Front Y Type Conv., 24 valve Eng.	641149 ③	--
00-05	6	3.0L	Rear Manifold Conv., 24 valve Eng.	641153 ③	--
00-05	6	3.0L	Rear Main Conv., 24 valve Eng.	642697 ③	--
96-99	6	3.0L	24 valve Eng.	642660 ③	--
96-99	6	3.0L	12 Valve, California Emissions, LEV	642726 ⑤	--
96-99	6	3.0L	12 Valve, Code "U", Federal Emissions	642581 ④	--
94-95	6	3.0L	(Exc. SHO)	642480 ③	602294 ③
86-93	6	3.0L	w/Single Conv.	642328 ③	--
94-95	6	3.2L	SHO Models, Left	--	608294 ③
94-95	6	3.2L	SHO Models, Right	--	608294 ③
1993	6	3.2L	SHO Models, Left	--	602294 ③
1993	6	3.2L	SHO Models, Right	--	602294 ③
10-12	6	3.5L	Non-Turbo, Rear	642214 ③	--
2010	6	3.5L	Non-Turbo, Front	642215 ③	--
08-09	6	3.5L	Rear, Federal Emissions	642214 ④	--

③ Federal & California Emissions. Not For Sale or Use on vehicles licensed in the state of CA & NY (NY vehicles with CA Emissions). Check with your state authority for details.

④ Federal Emissions. Not For Sale or Use on vehicles licensed in the state of CA. Check with your state authority.

⑤ California Emissions. Not For Sale or Use on vehicles licensed in the state of CA & NY. Check with your state authority.

APPLICATION LISTINGS

FEDERAL CONVERTERS



YR/YRS	CYL	LITER	DESCRIPTION	DIRECT FIT	UNIVERSAL
FORD TAURUS (Cont.)					
08-09	6	3.5L	Front, Federal Emissions	642215 ④	--
08-09	6	3.5L	FWD, Left	--	608275 ③
08-09	6	3.5L	Rear, California Emissions	642056 ⑤	--
08-09	6	3.5L	FWD, Right	--	608275 ③
91-95	6	3.8L		642358 ③	602204 ③
88-90	6	3.8L	Rear	--	602004 ③
88-90	6	3.8L	Main & Pre-Cat	--	602004 ③
96-99	8	3.4L	SHO Models, Front	642739 ③	--
96-99	8	3.4L	SHO Models, Rear	642740 ③	--
FORD TAURUS X					
08-09	6	3.5L	Rear, California Emission	642056 ⑤	--
08-09	6	3.5L	Federal Emissions, Front	642215 ④	--
08-09	6	3.5L	Federal Emissions, Rear	642214 ④	--
FORD TEMPO					
85-94	4	2.3L	(Exc. A.W.D.)	642362 ☆③	--
1984	4	2.3L		--	602004 ③
92-94	6	3.0L		642441 ③	602204 ③
FORD THUNDERBIRD					
87-88	4	2.3L		--	602206 ③
83-86	4	2.3L		--	602206 ③
80-82	6	3.3L	Rear	--	602204 ③
80-82	6	3.3L	Main & Pre-Cat	--	602004 ③
96-97	6	3.8L	Front Left	--	608274 ③
96-97	6	3.8L	Rear	--	608235 ③
96-97	6	3.8L	Complete	642922 ③	--
96-97	6	3.8L	Front Right	--	608274 ③
92-95	6	3.8L	w/O2 Sensor Ports, Front Left	--	602204 ③
92-95	6	3.8L	w/O2 Sensor Ports, Complete	642950 ③	--
92-95	6	3.8L	w/O2 Sensor Ports, Front Right	--	602204 ③
91-95	6	3.8L	Exc. Conv. w/O2 Sensor Ports, Front Left	--	602204 ③
91-95	6	3.8L	Exc. Conv. w/O2 Sensor Ports, Front Right	--	602204 ③
89-93	6	3.8L	Complete, Super Coupe Models	642943 ③	--
89-90	6	3.8L	Left, (Exc. Super Coupe)	--	602204 ③
89-90	6	3.8L	Right, (Exc. Super Coupe)	--	602204 ③
84-88	6	3.8L	Rear	--	602005 ③
84-88	6	3.8L	Main & Pre-Cat	--	602005 ③
82-83	6	3.8L	Rear	--	602005 ③
82-83	6	3.8L	Main & Pre-Cat	--	602004 ③
04-05	8	3.9L	Complete Assembly, 07/03 to 05	642982 ③	--
04-05	8	3.9L	Front Left, 07/03 to 05	--	608405 ③
04-05	8	3.9L	Front Right, 07/03 to 05	--	608405 ③
2003	8	3.9L	Complete Assembly	643066 ③	--
96-97	8	4.6L	Front Left	--	608274 ③
96-97	8	4.6L	Rear	--	608240 ③
96-97	8	4.6L	Complete Conv.	642961 ③	--
96-97	8	4.6L	Front Right	--	608274 ③
94-95	8	4.6L	w/Post Conv. O2 Sensor, Front Left	--	608204 ③

☆ Air Tube kit 4948 may be required for installation.

③ Federal & California Emissions. Not For Sale or Use on vehicles licensed in the state of CA & NY (NY vehicles with CA Emissions). Check with your state authority for details.

④ Federal Emissions. Not For Sale or Use on vehicles licensed in the state of CA. Check with your state authority.

⑤ California Emissions. Not For Sale or Use on vehicles licensed in the state of CA & NY. Check with your state authority.



APPLICATION LISTINGS FEDERAL CONVERTERS

YR/YRS	CYL	LITER	DESCRIPTION	DIRECT FIT	UNIVERSAL
FORD THUNDERBIRD (Cont.)					
94-95	8	4.6L	w/Post Conv. O2 Sensor, Rear	--	608240 ^③
94-95	8	4.6L	w/Post Conv. O2 Sensor, Complete	642915 ^③	--
94-95	8	4.6L	w/o Post Conv. O2 Sensor Port, Front Left	--	602204 ^③
94-95	8	4.6L	w/o Post Conv. O2 Sensor Port, Rear	--	609244 ^③
94-95	8	4.6L	w/Post Conv. O2 Sensor, Front Right	--	608204 ^③
94-95	8	4.6L	w/o Post Conv. O2 Sensor Port, Front Right	--	602204 ^③
91-93	8	5.0L	Left	--	602204 ^③
91-93	8	5.0L	Right	--	602204 ^③
91-93	8	5.0L		--	609244 ^③
91-93	8	5.0L	Complete System	642958 ^③	--
87-88	8	5.0L	w/4 Conv. System, Front Left	--	602004 ^③
87-88	8	5.0L	w/4 Conv. System, Front Right	--	602004 ^③
87-88	8	5.0L	w/4 Conv. System, Rear Left	--	602004 ^③
87-88	8	5.0L	w/4 Conv. System, Rear Right	--	602004 ^③
86-88	8	5.0L	w/3 Conv. System, Rear	--	602005 ^③
86-88	8	5.0L	w/3 Conv. System, Main & Pre-Cat	--	602005 ^③
83-85	8	5.0L	Left	--	602005 ^③
83-85	8	5.0L	Right	--	602005 ^③
77-78	8	6.6L	Left	--	605004 ^③
77-78	8	6.6L	Right	--	605004 ^③
75-76	8	7.5L	Left	--	605004 ^③
75-76	8	7.5L	Right	--	605004 ^③
80-82	8	All	Rear	--	602005 ^③
80-82	8	All	Main & Pre-Cat	--	602005 ^③
77-79	8	All	Exc. 400 C.I.D., Left	--	602214 ^③
77-79	8	All	Left, Exc. 6.6L 400 C.I.D.	--	602214 ^③
77-79	8	All	Right, Exc. 6.6L 400 C.I.D.	--	602214 ^③
77-79	8	All	Exc. 400 C.I.D., Right	--	602214 ^③
FORD TORINO, GRAN TORINO					
75-76	8	6.6L	Left	--	605004 ^③
75-76	8	6.6L	Right	--	605004 ^③
75-76	8	7.5L	Left	--	605004 ^③
75-76	8	7.5L	Right	--	605004 ^③
75-76	8	All	(Exc. 400 or 460 C.I.D.)	--	602214 ^③
FORD TRANSIT CONNECT					
10-13	4	2.0L	Rear	642051 ^③	--
10-13	4	2.0L	Front	642050 ^③	--
FORD WINDSTAR					
99-00	6	3.0L	Left	--	608286 ^③
99-00	6	3.0L	Right	--	608286 ^③
97-98	6	3.0L	Left	--	608205 ^③
97-98	6	3.0L	Complete Assembly	642532 ^③	--
97-98	6	3.0L	Right	--	608205 ^③
95-96	6	3.0L	Left	--	608294 ^③
95-96	6	3.0L	Complete Assembly	642797 ^③	--
95-96	6	3.0L	Right	--	608294 ^③
01-03	6	3.8L		642767 ^③	--

^③ Federal & California Emissions. Not For Sale or Use on vehicles licensed in the state of CA & NY (NY vehicles with CA Emissions). Check with your state authority for details.

APPLICATION LISTINGS

FEDERAL CONVERTERS



YR/YRS	CYL	LITER	DESCRIPTION	DIRECT FIT	UNIVERSAL
FORD WINDSTAR (Cont.)					
98-00	6	3.8L	(Exc. Models w/Mid-Bed O2 Sensor), Federal Emissions; From 5/98	642691 ④	--
98-00	6	3.8L	California Emissions; From 4/30/98	642782 ⑤	--
98-00	6	3.8L	California Emissions, From 04/30/98, Left	--	608286 ⑤
98-00	6	3.8L	California Emissions, From 04/30/98, Right	--	608286 ⑤
97-98	6	3.8L	Exc. Models w/Mid-Bed O2 Sensor, To 04/98, Left	--	608205 ③
97-98	6	3.8L	(Exc. Models w/Mid-Bed O2 Sensor), Complete Assembly; To 4/98	642539 ③	--
97-98	6	3.8L	California Emissions, To 04/29/98, Left	--	608294 ⑤
97-98	6	3.8L	Exc. Models w/Mid-Bed O2 Sensor, To 04/98, Right	--	608205 ③
97-98	6	3.8L	California Emissions, To 04/29/98, Right	--	608294 ⑤
95-96	6	3.8L	Left	--	608205 ③
95-96	6	3.8L	Complete Assembly	642450 ③	--
95-96	6	3.8L	Right	--	608205 ③
GEO METRO					
96-97	3	1.0L	w/51-1/8" Conv., Federal Emissions	642957 ④	608294 ④
1996	3	1.0L	w/54-1/4" Conv.	642934 ③	608204 ③
1995	3	1.0L	Rear, 2 Dr.	642917 ③	602204 ③
89-94	3	All		642904 ③	602204 ③
1997	4	1.3L	w/51-1/8" Conv., Federal Emissions	642957 ④	608294 ④
1997	4	1.3L	Front, California Emissions, Includes Pipe Between Converters	641191 ⑤	--
1997	4	1.3L	Rear, California Emissions	642300 ⑤	608214 ⑤
1996	4	1.3L	w/51-1/8" Conv.	642957 ③	608294 ③
GEO PRIZM					
96-97	4	1.6L		642577 ③	608294 ③
90-95	4	1.6L	(Exc. H.O.)	642403 ③	602004 ③
90-93	4	1.6L	w/H.O.	--	602004 ③
96-97	4	1.8L		642577 ③	608294 ③
93-95	4	1.8L		642403 ③	602004 ③
GEO SPECTRUM					
1989	4	1.5L		--	602206 ③
1989	4	1.5L	Main & Pre-Cat	--	602004 ③
GEO STORM					
90-93	4	All		642380 ③	602206 ③
GEO TRACKER					
94-95	4	1.6L	16 valve	642535 ☆③	602204 ③
90-94	4	1.6L	8 valve	642418 ③	602206 ③
1989	4	1.6L		642418 ③	602206 ③
96-97	4	All		642595 ③	608204 ③
GMC ACADIA					
09-12	6	3.6L	Rear Main Conv.	642044 ③	--
07-11	6	3.6L	Front Conv.	642125 ③	--
07-11	6	3.6L	Rear Conv.	642126 ③	--
GMC B7 CONVENTIONAL CHASSIS					
98-00	8	7.4L		646310 ③	606007 ③
GMC C-(2WD), K-(4WD) PICKUP 1/2 TON, (Inc. SIERRA)					
09-13	6	4.3L	Complete Assembly	645821 ③④	--
			Complete Assembly	645797 ③	--
09-13	6	4.3L	Front Left	--	608286 ③

④ Discontinued, use until inventory is depleted.

☆ Air Tube kit 4948 may be required for installation.

③ Federal & California Emissions. Not For Sale or Use on vehicles licensed in the state of CA & NY (NY vehicles with CA Emissions). Check with your state authority for details.

④ Federal Emissions. Not For Sale or Use on vehicles licensed in the state of CA. Check with your state authority.

⑤ California Emissions. Not For Sale or Use on vehicles licensed in the state of CA & NY. Check with your state authority.



APPLICATION LISTINGS FEDERAL CONVERTERS

YR/YRS	CYL	LITER	DESCRIPTION	DIRECT FIT	UNIVERSAL
GMC C-(2WD), K-(4WD) PICKUP 1/2 TON, (Inc. SIERRA) (Cont.)					
09-13	6	4.3L	Rear Conv.	--	608216 ^③
09-13	6	4.3L	Front Right	--	608286 ^③
2008	6	4.3L	Exc. Classic Model, Federal Emissions	645459 ^④	--
00-06	6	4.3L	Dual Convs., 2000 w/Flat Spot in Middle Pipe	645988 ^{③①}	--
			Dual Convs., 2000 w/Flat Spot in Middle Pipe	645236 ^③	608216 ^③
98-00	6	4.3L	Dual Convs. 2000 w/o Flat Spot in Middle Pipe	645947 ^③	608226 ^③
96-98	6	4.3L	(Exc. Dual Conv.)	645946 ^③	608227 ^③
94-95	6	4.3L		645342 ^③	609007 ^③
1993	6	4.3L	27-1/2" Conv.	645341 ^③	609006 ^③
1993	6	4.3L	Closed Coupled Exhaust (Conv. welded to front pipe), (Exc. 27-1/2" Conv.)	--	609006 ^③
				--	--
88-92	6	4.3L		645341 ^③	609006 ^③
83-86	6	All		645301 ^③	604006 ^③
75-82	6	All		642301 ^③	602206 ^③
09-13	8	4.8L	Complete Assembly	645821 ^{③①}	--
09-13	8	4.8L	Front Left	--	608286 ^③
09-13	8	4.8L	Rear Conv.	--	608216 ^③
09-13	8	4.8L	Front Right	--	608286 ^③
09-13	8	4.8L	Complete Assembly	645797 ^③	--
07-08	8	4.8L	Exc. Classic Model, Federal Emissions	645459 ^④	--
00-06	8	4.8L	Dual Convs., 2000 w/Flat Spot in Middle Pipe	645988 ^{③①}	--
			Dual Convs., 2000 w/Flat Spot in Middle Pipe	645236 ^③	608216 ^③
99-00	8	4.8L	Dual Convs. 2000 w/o Flat Spot in Middle Pipe	645947 ^③	608226 ^③
96-98	8	5.0L	Single Conv.	645946 ^③	608227 ^③
94-95	8	5.0L		645342 ^③	609007 ^③
1993	8	5.0L	27-1/2" Conv.	645341 ^③	609006 ^③
1993	8	5.0L	(Exc. 27-1/2" Conv.)	--	609006 ^③
88-92	8	5.0L		645341 ^③	609006 ^③
83-86	8	5.0L		642301 ^③	602206 ^③
09-13	8	5.3L	Complete Assembly	645821 ^{③①}	--
09-13	8	5.3L	Front Left	--	608286 ^③
09-13	8	5.3L	Rear Conv.	--	608216 ^③
09-13	8	5.3L	Front Right	--	608286 ^③
09-13	8	5.3L	Complete Assembly	645797 ^③	--
07-08	8	5.3L	Exc. Classic Model, Federal Emissions	645459 ^④	--
00-06	8	5.3L	Dual Convs., 2000 w/Flat Spot in Middle Pipe	645988 ^{③①}	--
			Dual Convs., 2000 w/Flat Spot in Middle Pipe	645236 ^③	608216 ^③
99-00	8	5.3L	Dual Convs. 2000 w/o Flat Spot in Middle Pipe	645947 ^③	608226 ^③
96-98	8	5.7L	Single Conv.	645946 ^③	608227 ^③
96-98	8	5.7L	Dual Convs.	645328 ^③	608235 ^③
94-95	8	5.7L		645342 ^③	609007 ^③
1993	8	5.7L	(Exc. 26-1/4" Conv.)	--	609007 ^③
92-93	8	5.7L	26-1/4" Conv.	645316 ^③	609007 ^③
88-91	8	5.7L		645316 ^③	609007 ^③
83-86	8	5.7L		645301 ^③	609006 ^③
07-08	8	6.0L	Exc. Classic Model, Federal Emissions	645459 ^④	--
06-08	8	6.0L	Left	--	608437 ^{③①}

① Discontinued, use until inventory is depleted.

③ Federal & California Emissions. Not For Sale or Use on vehicles licensed in the state of CA & NY (NY vehicles with CA Emissions). Check with your state authority for details.

④ Federal Emissions. Not For Sale or Use on vehicles licensed in the state of CA. Check with your state authority.

① EPA Enhanced OBDII By Design Unit

APPLICATION LISTINGS

FEDERAL CONVERTERS



YR/YRS	CYL	LITER	DESCRIPTION	DIRECT FIT	UNIVERSAL
GMC C-(2WD), K-(4WD) PICKUP 1/2 TON, (Inc. SIERRA) (Cont.)					
06-08	8	6.0L	Right	--	608437③○
02-06	8	6.0L	1500 HD, Federal Emissions, Left	645455 ④	--
02-06	8	6.0L	1500 HD, Federal Emissions, Right	645454 ④	--
09-10	8	6.2L		645291 ③	--
75-79	8	7.4L		645301 ③	604006③
75-82	8	All	(Exc. 454 C.I.D.)	642301 ③	602206③
GMC C-(2WD), K-(4WD) PICKUP 3/4 TON, (Inc. SIERRA)					
75-84	6	4.1L		645301 ③	605006③
94-95	6	4.3L	To 8600 lbs GVW	645342 ③	609007③
91-93	6	4.3L	To 8600 lbs GVW, w/3" Piping	645316 ③	609007③
88-93	6	4.3L	To 8600 lbs GVW, w/2-1/2" Piping	645341 ③	609006③
85-86	6	4.3L	C2500	645301 ③	609006③
96-98	8	5.0L		645946 ③	608227③
94-95	8	5.0L	To 8600 lbs GVW	645342 ③	609007③
88-93	8	5.0L		645341 ③	609006③
83-86	8	5.0L		645301 ③	609006③
2000	8	5.3L	Dual Convs., 2000 w/Flat Spot in Middle Pipe	645988 ③○	--
			Dual Convs., 2000 w/Flat Spot in Middle Pipe	645236 ③	608216③
99-00	8	5.3L	Dual Convs. 2000 w/o Flat Spot in Middle Pipe	645947 ③	608226③
96-00	8	5.7L	8600 lbs GVW and Over, Front	645998 ③	608227③
96-00	8	5.7L	8600 lbs GVW and Over, 155.5" W.B., Rear	645828 ②③	608227③
96-99	8	5.7L	8600 lbs GVW and Over, 141.5" W.B., Rear	645392 ③	608227③
96-99	8	5.7L	8600 lbs GVW and Over, 131.5" W.B., Rear	645425 ③	608227③
96-98	8	5.7L	Dual Convs., to 8600 lbs GVW	645328 ③	608235③
94-95	8	5.7L	To 8600 lbs GVW	645342 ③	609007③
88-93	8	5.7L	To 8600 lbs GVW	645316 ③	604007③
88-93	8	5.7L	Models w/Rear Conv. behind muffler, to 8600 lbs GVW	645317 ③	604007③
88-93	8	5.7L	To 11000 lbs GVW	646304 ③	606007③
88-93	8	5.7L	Models w/Rear Conv. behind muffler, to 11000 lbs GVW	--	606007③
83-86	8	5.7L		645301 ③	609006③
11-13	8	6.0L	2500 HD, w/o Third Converter	645184 ③	--
07-09	8	6.0L	2500 HD	645778 ③	--
06-08	8	6.0L	Left	--	608437③○
06-08	8	6.0L	Right	--	608437③○
03-06	8	6.0L	2500 HD, California Emissions, Right	645783 ⑤	--
03-06	8	6.0L	2500 HD, California Emissions, Left	645782 ⑤	--
01-06	8	6.0L	2500 HD, 133" WB, Federal Emissions, Right Side, OE System is completely welded. Additional sizing, bushings, cutting may be required.	645473 ④	--
				--	--
				--	--
01-06	8	6.0L	2500 HD, 133" WB, Federal Emissions, Left Side, OE System is completely welded. Additional sizing, bushings, cutting may be required.	645455 ④	--
				--	--
				--	--
01-06	8	6.0L	2500 HD, 143.5", 153", 157.5", 167" WB, Federal Emissions, Right Side, OE System is completely welded. Additional sizing, bushings, cutting may be required.	645454 ④	--
				--	--
				--	--

- ① Discontinued, use until inventory is depleted.
- ② When using with aftermarket piping, direct fit converter may require INLET/OUTLET pipe resizing.
- ③ Federal & California Emissions. Not For Sale or Use on vehicles licensed in the state of CA & NY (NY vehicles with CA Emissions). Check with your state authority for details.
- ④ Federal Emissions. Not For Sale or Use on vehicles licensed in the state of CA. Check with your state authority.
- ⑤ California Emissions. Not For Sale or Use on vehicles licensed in the state of CA & NY. Check with your state authority.
- EPA Enhanced OBDII By Design Unit



APPLICATION LISTINGS FEDERAL CONVERTERS

YR/YRS	CYL	LITER	DESCRIPTION	DIRECT FIT	UNIVERSAL
GMC C-(2WD), K-(4WD) PICKUP 3/4 TON, (Inc. SIERRA) (Cont.)					
01-06	8	6.0L	2500 HD, 143.5", 153", 157.5", 167" WB, Federal Emissions, Left Side, OE System is completely welded. Additional sizing, bushings, cutting may be required.	645455 ④ -- --	-- -- --
01-03	8	6.0L	Federal Emissions	--	606007④
01-03	8	6.0L	California Emissions, Left	--	604007⑤
01-03	8	6.0L	California Emissions, Right	--	604007⑤
01-02	8	6.0L	2500 HD, Incomplete Chassis, Right	645276 ③	--
01-02	8	6.0L	2500 HD, Incomplete Chassis, Left	645818 ③	--
2001	8	6.0L	143.5" W.B., Federal Emissions, Right, O.E. System is Completely Welded, Replace With Complete AP System	645272 ④ --	-- --
2001	8	6.0L	Federal Emissions, Left, O.E. System is completely welded, Replace with complete AP system	645842 ④ --	-- --
99-00	8	6.0L	Right, 6-1/2' Bed	645451 ③	--
99-00	8	6.0L	Left	645842 ③	--
99-00	8	6.0L	143.5" W.B., Right, O.E. System is Completely Welded, Replace With Complete Ap System	645272 ③ --	-- --
96-00	8	7.4L	Front, Federal Emissions	645931 ④	604006④
91-95	8	7.4L	To 8600 lbs GVW	645316 ③	604007③
91-95	8	7.4L	Models w/Rear Conv. behind muffler, to 8600 lbs GVW	645317 ③	604007③
91-95	8	7.4L	To 11000 lbs GVW	646304 ③	606007③
91-95	8	7.4L	Models w/Rear Conv. behind muffler, to 11000 lbs GVW	--	606007③
06-07	8	8.1L	Left	--	608437③○
06-07	8	8.1L	Right	--	608437③○
03-06	8	8.1L	2500 HD, California Emissions, Right	645783 ⑤	--
01-06	8	8.1L	2500 HD, 133" WB, Federal Emissions, Right Side, OE System is completely welded. Additional sizing, bushings, cutting may be required.	645473 ④ -- --	-- -- --
01-06	8	8.1L	2500 HD, 133" WB, Federal Emissions, Left Side, OE System is completely welded. Additional sizing, bushings, cutting may be required.	645455 ④ -- --	-- -- --
01-06	8	8.1L	2500 HD, 143.5", 153", 157.5", 167" WB, Federal Emissions, Right Side, OE System is completely welded. Additional sizing, bushings, cutting may be required.	645454 ④ -- --	-- -- --
01-06	8	8.1L	2500 HD, 143.5", 153", 157.5", 167" WB, Federal Emissions, Left Side, OE System is completely welded. Additional sizing, bushings, cutting may be required.	645455 ④ -- --	-- -- --
2001	8	8.1L	California Emissions, Left	--	604007⑤
2001	8	8.1L	California Emissions, Right	--	604007⑤
75-82	8	All		645301 ③	605006③
GMC C-(2WD), K-(4WD) PICKUP 1 TON, (Inc. SIERRA)					
96-00	8	5.7L	8600 lbs GVW and Over, Front	645998 ③	608227③
96-00	8	5.7L	8600 lbs GVW and Over, 155.5" W.B., Rear	645828 ②③	608227③
96-99	8	5.7L	8600 lbs GVW and Over, 141.5" W.B., Rear	645392 ③	608227③
96-99	8	5.7L	8600 lbs GVW and Over, 131.5" W.B., Rear	645425 ③	608227③
96-97	8	5.7L	Rear	--	608226③
96-97	8	5.7L	Front	--	608226③
1986	8	5.7L	To 9000 lbs GVW	645341 ③	604006③

- ② When using with aftermarket piping, direct fit converter may require INLET/OUTLET pipe resizing.
- ③ Federal & California Emissions. Not For Sale or Use on vehicles licensed in the state of CA & NY (NY vehicles with CA Emissions). Check with your state authority for details.
- ④ Federal Emissions. Not For Sale or Use on vehicles licensed in the state of CA. Check with your state authority.
- ⑤ California Emissions. Not For Sale or Use on vehicles licensed in the state of CA & NY. Check with your state authority.
- EPA Enhanced OBDII By Design Unit

APPLICATION LISTINGS

FEDERAL CONVERTERS



YR/YRS	CYL	LITER	DESCRIPTION	DIRECT FIT	UNIVERSAL
GMC C-(2WD), K-(4WD) PICKUP 1 TON, (Inc. SIERRA) (Cont.)					
11-13	8	6.0L	3500 HD, w/o Third Converter	645184 ③	--
07-09	8	6.0L	3500 HD	645778 ③	--
06-08	8	6.0L	Left	--	608437 ③○
06-08	8	6.0L	Right	--	608437 ③○
03-06	8	6.0L	California Emissions, Right	645783 ⑤	--
03-06	8	6.0L	California Emissions, Left	645782 ⑤	--
01-02	8	6.0L	Federal Emissions	--	606007 ④
01-02	8	6.0L	California Emissions, Left	--	604007 ⑤
01-02	8	6.0L	California Emissions, Right	--	604007 ⑤
96-00	8	7.4L	Front, Federal Emissions	645931 ④	604006 ④
96-00	8	7.4L	Rear, Federal Emissions	--	604006 ④
96-00	8	7.4L	159.5" W.B., 15000 lbs GVW, Rear	645187 ③	--
06-07	8	8.1L	Left	--	608437 ③○
06-07	8	8.1L	Right	--	608437 ③○
03-06	8	8.1L	California Emissions, Right	645783 ⑤	--
03-06	8	8.1L	California Emissions, Left	645782 ⑤	--
2001	8	8.1L	California Emissions, Left	--	604007 ⑤
2001	8	8.1L	California Emissions, Right	--	604007 ⑤
93-95	8	All	To 12000 lbs GVW	646304 ③	606007 ③
93-95	8	All	Models w/Rear Conv. behind muffler, To 12000 lbs GVW	--	606007 ③
93-95	8	All	To 9000 lbs GVW	645316 ③	604007 ③
93-95	8	All	Models w/Rear Conv., To 9000 lbs GVW	645317 ③	604007 ③
88-92	8	All	To 12000 lbs GVW	646304 ③	606007 ③
88-92	8	All	Models w/Rear Conv. behind muffler, To 12000 lbs GVW	--	606007 ③
88-92	8	All	To 9000 lbs GVW	645316 ③	604007 ③
88-92	8	All	Models w/Rear Conv., To 9000 lbs GVW	645317 ③	604007 ③
GMC C4500 TOPKICK					
03-09	8	8.1L	Front	645774 ③	--
03-09	8	8.1L	Rear	645775 ③	--
GMC C5500					
05-08	8	8.1L	Front	645861 ③	608227 ③
05-08	8	8.1L		645437 ③	608227 ③
GMC CABALLERO/SPRINT					
1984	6	3.8L	231 C.I.D.	642353 ☆③	602005 ③
83-84	6	3.8L	229 C.I.D.	642355 ☆③	602005 ③
81-83	6	3.8L	231 C.I.D.	642352 ☆③	602005 ③
81-82	6	3.8L	229 C.I.D.	642352 ☆③	602005 ③
1980	6	3.8L	229 C.I.D., Angled Conv.	642352 ☆③	602005 ③
1980	6	3.8L	229 C.I.D., Straight Conv.	642304 ③	602205 ③
1980	6	3.8L	231 C.I.D.	--	602006 ③
75-77	6	4.1L		--	602206 ③
85-87	6	4.3L		642395 ☆③	602005 ③
78-79	6	All		642352 ☆③	602005 ③
1979	8	4.4L	267 C.I.D.	642352 ☆③	602005 ③
1979	8	5.0L		--	602206 ③
1978	8	5.0L		642352 ☆③	602005 ③
76-77	8	5.0L		--	602206 ③

☆ Air Tube kit 4948 may be required for installation.

③ Federal & California Emissions. Not For Sale or Use on vehicles licensed in the state of CA & NY (NY vehicles with CA Emissions). Check with your state authority for details.

④ Federal Emissions. Not For Sale or Use on vehicles licensed in the state of CA. Check with your state authority.

⑤ California Emissions. Not For Sale or Use on vehicles licensed in the state of CA & NY. Check with your state authority.

○ EPA Enhanced OBDII By Design Unit



APPLICATION LISTINGS FEDERAL CONVERTERS

YR/YRS	CYL	LITER	DESCRIPTION	DIRECT FIT	UNIVERSAL
GMC CABALLERO/SPRINT (Cont.)					
78-79	8	5.7L		--	602206 ^③
75-77	8	5.7L		--	602206 ^③
75-76	8	6.6L		--	604006 ^③
1975	8	7.4L		--	604006 ^③
83-87	8	All		642355 ☆ ^③	602005 ^③
81-82	8	All		642352 ☆ ^③	602005 ^③
1980	8	All		--	602006 ^③
GMC CANYON					
04-06	4	2.8L	Front	641216 ^③	--
04-06	4	2.8L		645852 ^③	608415 ^③
07-12	4	2.9L	Front Main Conv.	641339 ^③	--
04-06	5	3.5L	Front	642196 ^③	--
04-06	5	3.5L		645852 ^③	608415 ^③
07-12	5	3.7L	Manifold Unit, Front	641338 ^③	--
09-12	8	5.3L	Left	645179 ^③	--
09-12	8	5.3L	Right	645180 ^③	--
GMC ENVOY					
08-09	6	4.2L		645185 ^③	--
06-07	6	4.2L	Exc. XL	645864 ^③	608206 ^③
02-05	6	4.2L	Exc. XL	645878 ^③	608216 ^③
2000	6	4.3L	4WD & Auto Trans. & 4 Dr., Federal Emissions	645891 ^④	608227 ^④
06-09	8	5.3L		645186 ^③	--
05-06	8	5.3L		645265 ^③	608286 ^③
GMC ENVOY XL					
02-05	6	4.2L		645845 ^{③①}	--
				645804 ^③	608216 ^③
05-06	8	5.3L	Center	645776 ^③	--
03-04	8	5.3L		645784 ^③	--
GMC ENVOY XUV					
04-05	6	4.2L		645845 ^{③①}	--
				645804 ^③	608216 ^③
2005	8	5.3L	Center	645776 ^③	--
GMC G -VAN 1/2 & 3/4 TON (Inc. Savana Van)					
83-84	6	4.1L		642301 ^③	602206 ^③
75-82	6	4.1L		645301 ^③	609006 ^③
09-14	6	4.3L	1500	645777 ^③	--
07-08	6	4.3L	1500, Right	--	608265 ^③
07-08	6	4.3L	1500, Left	--	608265 ^③
03-06	6	4.3L	1500, Complete Assembly	645813 ^③	608416 ^③
03-05	6	4.3L	2500, Complete Assembly	645813 ^③	608416 ^③
00-02	6	4.3L	Under 8500 lbs GVW	645896 ^③	608227 ^③
96-99	6	4.3L	Over 8500 lbs GVW, w/3 Bolt Outlet Flange	645882 ^③	608227 ^③
96-99	6	4.3L	To 8500 lbs GVW, w/3 Bolt Outlet Flange	645927 ^③	608227 ^③
1995	6	4.3L		645350 ^③	609007 ^③
85-94	6	4.3L		645301 ^③	609006 ^③
08-13	8	4.8L	2500, Cutaway & Stripped Chassis, Left	645781 ^③	--
10-11	8	4.8L	2500, Y-Pipe Unit, Exc. Cutaway & Stripped Chassis	645777 ^③	--

① Discontinued, use until inventory is depleted.

☆ Air Tube kit 4948 may be required for installation.

③ Federal & California Emissions. Not For Sale or Use on vehicles licensed in the state of CA & NY (NY vehicles with CA Emissions). Check with your state authority for details.

④ Federal Emissions. Not For Sale or Use on vehicles licensed in the state of CA. Check with your state authority.

APPLICATION LISTINGS

FEDERAL CONVERTERS



YR/YRS	CYL	LITER	DESCRIPTION	DIRECT FIT	UNIVERSAL
GMC G -VAN 1/2 & 3/4 TON (Inc. Savana Van) (Cont.)					
06-10	8	4.8L	2500, Standard Passenger Van, Standard Cargo Van, Extended Cargo Van, California Emissions, Left	645779 ⑤ --	-- --
06-10	8	4.8L	2500, Standard Passenger Van, Standard Cargo Van, Extended Cargo Van, California Emissions, Right	645780 ⑤ --	-- --
06-09	8	4.8L	2500, Left, Federal Emissions, Body to Front	645817 ④	608407 ④
06-09	8	4.8L	2500, Right, Federal Emissions, Body to Front	645816 ④	608407 ④
03-05	8	4.8L	2500, Right Conv. 68-1/4", Federal Emissions	645853 ④	608227 ④
03-05	8	4.8L	2500, Right Conv. 60-3/4", Federal Emissions	645863 ④	608227 ④
03-05	8	4.8L	2500, Left, Federal Emissions	645862 ④	608227 ④
03-05	8	4.8L	2500, 2 Bodies, Left, California Emissions	645814 ⑤	--
03-05	8	4.8L	2500, 2 Bodies, Right, California Emissions	645815 ⑤	--
00-02	8	5.0L	Under 8500 lbs GVW	645896 ③	608227 ③
00-01	8	5.0L	G20 Model	--	608227 ③
96-99	8	5.0L	w/3 Bolt Outlet Flange	645927 ③	608227 ③
1995	8	5.0L	(Exc. 146" W.B.)	645350 ③	609007 ③
87-94	8	5.0L		645301 ③	609006 ③
09-14	8	5.3L	1500	645777 ③	--
03-05	8	5.3L	1500 & 2500, Complete Assembly	645813 ③	608416 ③
2002	8	5.7L	1500, Under 8500 lbs GVW, Complete Assembly	645820 ③	--
2002	8	5.7L	1500, Under 8500 lbs GVW, Left	--	608215 ③
2002	8	5.7L	1500, Under 8500 lbs GVW, Right	--	608215 ③
01-02	8	5.7L	1500 & 2500, Over 8500 lbs GVW, Left	645811 ③	--
01-02	8	5.7L	1500 & 2500, Over 8500 lbs GVW, Right	645812 ③	--
00-02	8	5.7L	2500, Under 8500 lbs GVW	645785 ③	--
2000	8	5.7L	2500, Under 8500 lbs GVW, Left	--	608227 ③
2000	8	5.7L	2500, Under 8500 lbs GVW, Right	--	608227 ③
2000	8	5.7L	1500, Under 8500 lbs GVW	645785 ③	--
97-00	8	5.7L	2500 Over 8500 lbs GVW, Right	645996 ③	608227 ③
97-00	8	5.7L	2500 Over 8500 lbs GVW, Left	645997 ③	608227 ③
96-99	8	5.7L	Single Conv. System, w/3 Bolt Outlet Flange	645927 ③	608227 ③
96-99	8	5.7L	Dual Conv. System, Under 8500 lbs GVW, Right	645980 ③	608227 ③
96-99	8	5.7L	Dual Conv. System, Under 8500 lbs GVW, Left	645981 ③	608227 ③
1995	8	5.7L	(Exc. 146" W.B.)	645350 ③	609007 ③
92-94	8	5.7L	Over 9000 lbs GVW	646304 ③	606007 ③
92-94	8	5.7L	Models w/Rear Conv. behind muffler, Over 9000 lbs GVW	--	606007 ③
92-94	8	5.7L	To 9000 lbs GVW	645316 ③	604007 ③
92-94	8	5.7L	Models w/Rear Conv. behind muffler, To 9000 lbs GVW	645317 ③	604007 ③
87-91	8	5.7L	Over 9000 lbs GVW	646304 ③	606007 ③
87-91	8	5.7L	Models w/Rear Conv. behind muffler, Over 9000 lbs GVW	--	606007 ③
87-91	8	5.7L	To 9000 lbs GVW	645316 ③	604007 ③
87-91	8	5.7L	Models w/Rear Conv., To 9000 lbs GVW	645317 ③	604007 ③
75-76	8	5.7L	w/Conv.	642301 ③	602206 ③
08-13	8	6.0L	2500, Cutaway & Stripped Chassis, Left	645781 ③	--
11-12	8	6.0L	2500, Complete Assembly	645819 ③	--
10-11	8	6.0L	2500, Y-Pipe Unit, Exc. Cutaway & Stripped Chassis	645777 ③	--
06-10	8	6.0L	2500, Standard Passenger Van, Standard Cargo Van, Extended Cargo Van, California Emissions, Left	645779 ⑤ --	-- --

③ Federal & California Emissions. Not For Sale or Use on vehicles licensed in the state of CA & NY (NY vehicles with CA Emissions). Check with your state authority for details.
 ④ Federal Emissions. Not For Sale or Use on vehicles licensed in the state of CA. Check with your state authority.
 ⑤ California Emissions. Not For Sale or Use on vehicles licensed in the state of CA & NY. Check with your state authority.



APPLICATION LISTINGS FEDERAL CONVERTERS

YR/YRS	CYL	LITER	DESCRIPTION	DIRECT FIT	UNIVERSAL
GMC G -VAN 1/2 & 3/4 TON (Inc. Savana Van) (Cont.)					
06-10	8	6.0L	2500, Standard Passenger Van, Standard Cargo Van, Extended Cargo Van, California Emissions, Right	645780 ⑤ --	-- --
06-09	8	6.0L	2500, Left, Federal Emissions, Body to Front	645817 ④	608407 ④
06-09	8	6.0L	2500, Right, Federal Emissions, Body to Front	645816 ④	608407 ④
03-05	8	6.0L	2500, Right Conv. 68-1/4", Federal Emissions	645853 ④	608227 ④
03-05	8	6.0L	2500, Right Conv. 60-3/4", Federal Emissions	645863 ④	608227 ④
03-05	8	6.0L	2500, Left, Federal Emissions	645862 ④	608227 ④
03-05	8	6.0L	2500, 2 Bodies, Left, California Emissions	645814 ⑤	--
03-05	8	6.0L	2500, 2 Bodies, Right, California Emissions	645815 ⑤	--
79-80	8	6.6L		645301 ③	604006 ③
1995	8	All	146" W.B.	--	609007 ③
83-86	8	All		645301 ③	604006 ③
79-82	8	All	(Exc. 400 C.I.D.)	642301 ③	602206 ③
GMC G -VAN 1 TON (Inc. Savana Van)					
1995	6	4.3L		--	609007 ③
91-94	6	4.3L	Over 8500 lbs GVW	--	606006 ③
91-94	6	4.3L	To 8500 lbs GVW	645301 ③	609006 ③
78-90	6	All	To 8500 lbs GVW	645301 ③	604006 ③
08-13	8	4.8L	Cutaway & Stripped Chassis, Left	645781 ③	--
10-11	8	4.8L	Y-Pipe Unit, Exc. Cutaway & Stripped Chassis	645777 ③	--
06-10	8	4.8L	Standard Passenger Van, Standard Cargo Van, Extended Cargo Van, California Emissions, Left	645779 ⑤ --	-- --
06-10	8	4.8L	Standard Passenger Van, Standard Cargo Van, Extended Cargo Van, California Emissions, Right	645780 ⑤ --	-- --
01-02	8	5.7L	Over 8500 lbs GVW, Left	645811 ③	--
01-02	8	5.7L	Over 8500 lbs GVW, Right	645812 ③	--
00-02	8	5.7L	Under 8500 lbs GVW	645785 ③	--
2000	8	5.7L		--	608227 ③
97-00	8	5.7L	135" & 155" W.B. Over 8500 lbs GVW, Right	645996 ③	608227 ③
97-00	8	5.7L	135" & 155" W.B. Over 8500 lbs GVW, Left	645997 ③	608227 ③
1996	8	5.7L	Under 8500 lbs GVW, Right	645980 ③	608227 ③
1996	8	5.7L	Under 8500 lbs GVW, Left	645981 ③	608227 ③
1996	8	5.7L	135" & 155" W.B. Over 8500 lbs GVW, Right	645996 ③	608227 ③
1996	8	5.7L	135" & 155" W.B. Over 8500 lbs GVW, Left	645997 ③	608227 ③
1995	8	5.7L	Under 9000 lbs GVW	--	604007 ③
87-91	8	5.7L	Over 9000 lbs GVW	646304 ③	606007 ③
87-91	8	5.7L	Models w/Rear Conv. behind muffler, Over 9000 lbs GVW	--	606007 ③
87-91	8	5.7L	Under 9000 lbs GVW	645316 ③	604007 ③
87-91	8	5.7L	Models w/Rear Conv. behind muffler, Under 9000 lbs GVW	645317 ③	604007 ③
80-86	8	5.7L		645301 ③	604006 ③
08-13	8	6.0L	Cutaway & Stripped Chassis, Left	645781 ③	--
11-12	8	6.0L	135" and 155" W.B., Complete Assembly	645819 ③	--
10-11	8	6.0L	Y-Pipe Unit, Exc. Cutaway & Stripped Chassis	645777 ③	--
06-10	8	6.0L	Standard Passenger Van, Standard Cargo Van, Extended Passenger Van, Extended Cargo Van, California Emissions, Left	645779 ⑤ --	-- --
06-10	8	6.0L	Standard Passenger Van, Standard Cargo Van, Extended Passenger Van, Extended Cargo Van, California Emissions, Right	645780 ⑤ --	-- --

③ Federal & California Emissions. Not For Sale or Use on vehicles licensed in the state of CA & NY (NY vehicles with CA Emissions). Check with your state authority for details.

④ Federal Emissions. Not For Sale or Use on vehicles licensed in the state of CA. Check with your state authority.

⑤ California Emissions. Not For Sale or Use on vehicles licensed in the state of CA & NY. Check with your state authority.

APPLICATION LISTINGS

FEDERAL CONVERTERS



YR/YRS	CYL	LITER	DESCRIPTION	DIRECT FIT	UNIVERSAL
GMC G -VAN 1 TON (Inc. Savana Van) (Cont.)					
06-09	8	6.0L	Left, Federal Emissions, Body to Front	645817 ④	608407 ④
06-09	8	6.0L	Right, Federal Emissions, Body to Front	645816 ④	608407 ④
03-05	8	6.0L	Right, 68-1/4", Federal Emissions	645853 ④	608227 ④
03-05	8	6.0L	Right, 60-3/4", Federal Emissions	645863 ④	608227 ④
03-05	8	6.0L	Left, Federal Emissions	645862 ④	608227 ④
03-05	8	6.0L	2 Bodies, Left, California Emissions	645814 ⑤	--
03-05	8	6.0L	2 Bodies, Right, California Emissions	645815 ⑤	--
1995	8	7.4L	Under 9000 lbs GVW	--	604007 ③
92-94	8	All	Over 9000 lbs GVW	646304 ③	606007 ③
92-94	8	All	Under 9000 lbs GVW	645316 ③	604007 ③
78-79	8	All	w/Conv.	645301 ③	604006 ③
GMC JIMMY FULL SIZE					
75-82	6	4.1L		642301 ③	602206 ③
87-91	8	5.7L		645316 ③	609007 ③
75-78	8	6.6L		645301 ③	604006 ③
83-87	8	All	(Exc. 1987, 350 C.I.D., 5.7L)	645301 ③	609006 ③
75-82	8	All	(Exc. 400 C.I.D.)	642301 ③	602206 ③
GMC S-15 JIMMY					
83-88	4	All		642304 ③	602205 ③
83-87	6	2.8L		642304 ③	602205 ③
01-02	6	4.3L	Complete Assembly, 4WD, 2 Dr. California Emissions, Auto Trans.	645849 ⑤	--
01-02	6	4.3L	Rear, 4WD, 2 Dr., California Emissions	--	608226 ⑤
01-02	6	4.3L	Complete Assembly, 2WD, 2 Dr., California Emissions, Auto Trans.	645850 ⑤	--
01-02	6	4.3L	Rear, 2WD, 2 Dr., California Emissions	--	608264 ⑤
01-02	6	4.3L	2 Dr., Federal Emissions	--	608227 ④
00-02	6	4.3L	4WD & Auto Trans. & 4 Dr., California Emissions	645890 ⑤	--
00-02	6	4.3L	Complete Assembly, 2WD, 4 Dr., California Emissions	645841 ⑤	--
00-02	6	4.3L	Front, 4WD & Auto Trans. & 4 Dr., California Emissions	--	608416 ⑤
00-02	6	4.3L	Rear, 4WD & Auto Trans. & 4 Dr., California Emissions	--	608227 ⑤
2000	6	4.3L	4WD & Auto Trans. & 4 Dr., Federal Emissions	645891 ④	608227 ④
2000	6	4.3L	Complete Assembly, 2WD, 4 Dr., Federal Emissions	645840 ④	--
2000	6	4.3L	2WD, 2 Dr., Federal Emissions	645837 ④	608227 ④
2000	6	4.3L	4WD, 2 Dr., Federal Emissions	645836 ④	608226 ④
98-99	6	4.3L	Front, California Emissions	641166 ⑤	608294 ⑤
98-99	6	4.3L	Rear, California Emissions	642514 ⑤	608226 ⑤
98-99	6	4.3L	Federal Emissions	642514 ④	608226 ④
96-97	6	4.3L		642514 ③	608226 ③
1995	6	4.3L	4WD, 4 Door	642256 ③	608226 ③
1995	6	4.3L	4WD, 2 Door	642257 ③	608226 ③
92-94	6	4.3L	Code "Z" Eng.	642335 ③	609006 ③
92-94	6	4.3L	Code "W" Eng.	645356 ③	609006 ③
88-91	6	All		642335 ③	609006 ③
GMC S-Series (2WD), T-Series (4WD) PICKUP (SONOMA)					
82-84	4	1.9L		642304 ③	602205 ③
83-84	4	2.0L		642304 ③	602205 ③
96-03	4	2.2L		642543 ③	608206 ③
94-95	4	2.2L		642471 ③	602205 ③

- ③ Federal & California Emissions. Not For Sale or Use on vehicles licensed in the state of CA & NY (NY vehicles with CA Emissions). Check with your state authority for details.
- ④ Federal Emissions. Not For Sale or Use on vehicles licensed in the state of CA. Check with your state authority.
- ⑤ California Emissions. Not For Sale or Use on vehicles licensed in the state of CA & NY. Check with your state authority.



APPLICATION LISTINGS FEDERAL CONVERTERS

YR/YRS	CYL	LITER	DESCRIPTION	DIRECT FIT	UNIVERSAL
GMC S-Series (2WD), T-Series (4WD) PICKUP (SONOMA) (Cont.)					
85-93	4	2.5L		642304 ③	602205 ③
88-93	6	2.8L		642335 ③	602206 ③
82-87	6	2.8L		642304 ③	602205 ③
01-04	6	4.3L	4WD, 4 Dr., California Emissions	645890 ⑤	--
01-04	6	4.3L	Front, 4WD, 4 Dr., California Emissions	--	608416 ⑤
01-04	6	4.3L	Rear, 4WD, 4 Dr., California Emissions	--	608227 ⑤
01-03	6	4.3L	Extended Cab, 4WD, California Emissions	645889 ⑤	--
00-02	6	4.3L	2WD & Auto Trans., Calif. Emissions	645894 ⑤	--
2000	6	4.3L	2WD	--	608226 ③
2000	6	4.3L	4WD, Federal Emissions	645457 ④	--
2000	6	4.3L	2WD, Extended Cab, Auto. Trans., Federal Emissions	645458 ④	--
98-99	6	4.3L	2WD & Extended Cab, California Emissions	641227 ⑤	608264 ⑤
98-99	6	4.3L	2WD, w/ 31 1/2" OAL Conv.	642710 ③	608226 ③
96-99	6	4.3L	4WD	645372 ③	608227 ③
96-97	6	4.3L	2WD	645348 ③	608226 ③
1995	6	4.3L	4WD & Extended Cab	645347 ③	608226 ③
1995	6	4.3L	2WD	642473 ③	608226 ③
88-94	6	4.3L		642335 ③	602206 ③
GMC SAFARI VAN					
88-90	4	2.5L		--	602205 ③
85-87	4	2.5L		--	602205 ③
00-05	6	4.3L	California Emissions	645879 ⑤	--
00-01	6	4.3L	Federal Emissions	645959 ④	608227 ④
96-99	6	4.3L		645955 ③	608227 ③
94-95	6	4.3L	(Exc. AWD)	645925 ③	609007 ③
94-95	6	4.3L	AWD	645974 ③	609007 ③
1993	6	4.3L		645316 ③	609007 ③
1992	6	4.3L	Code "Z" Eng., 2-1/2" Pipe	645341 ③	609006 ③
1992	6	4.3L	Code "W" Eng., 3" Pipe	645316 ③	609007 ③
86-91	6	4.3L		645301 ③	609006 ③
1985	6	4.3L		642301 ③	602206 ③
GMC SIERRA 2500 HD CLASSIC					
2007	8	6.0L	2500 HD Classic Models Only, 133" WB, Federal Emissions, Right Side, OE System is completely welded. Additional sizing, bushings, cutting may be required.	645473 ④	--
2007	8	6.0L	2500 HD Classic Models Only, 143.5", 153", 157.5", 167" WB, Federal Emissions, Right Side, OE System is completely welded. Additional sizing, bushings, cutting may be required.	645454 ④	--
2007	8	6.0L	2500 HD Classic Models Only, 133", 157.5", 167" WB, Federal Emissions, Left Side, OE System is completely welded. Additional sizing, bushings, cutting may be required.	645455 ④	--
2007	8	8.1L	2500 HD Classic Models Only, 133" WB, Federal Emissions, Right Side, OE System is completely welded. Additional sizing, bushings, cutting may be required.	645473 ④	--
2007	8	8.1L	2500 HD Classic Models Only, 143.5", 153", 157.5", 167" WB, Federal Emissions, Right Side, OE System is completely welded. Additional sizing, bushings, cutting may be required.	645454	--

③ Federal & California Emissions. Not For Sale or Use on vehicles licensed in the state of CA & NY (NY vehicles with CA Emissions). Check with your state authority for details.

④ Federal Emissions. Not For Sale or Use on vehicles licensed in the state of CA. Check with your state authority.

⑤ California Emissions. Not For Sale or Use on vehicles licensed in the state of CA & NY. Check with your state authority.

APPLICATION LISTINGS

FEDERAL CONVERTERS



YR/YRS	CYL	LITER	DESCRIPTION	DIRECT FIT	UNIVERSAL
GMC SIERRA 2500 HD CLASSIC (Cont.)					
2007	8	8.1L	2500 HD Classic Models Only, 133", 157.5", 167" WB, Federal Emissions, Left Side, OE System is completely welded. Additional sizing, bushings, cutting may be required.	645455 ④ -- --	-- -- --
GMC SIERRA 3500 CLASSIC					
2007	8	6.0L	Cab-Chassis Classic Models Only, 133" W.B., Federal Emissions, Right Side, OE System is completely welded. Additional sizing, bushings, cutting may be required.	645473 ④ -- --	-- -- --
2007	8	6.0L	Cab-Chassis Classic Models Only, 157.5" & 167" W.B., Federal Emissions, Right Side, OE System is completely welded. Additional sizing, bushings, cutting may be required.	645454 ④ -- --	-- -- --
2007	8	6.0L	Cab-Chassis Classic Models Only; 133", 157.5", 167" W.B., Federal Emissions, Left Side, OE system is completely welded. Additional sizing, bushings, cutting may be required.	645455 ④ -- --	-- -- --
2007	8	8.1L	Cab-Chassis Classic Models Only, 133" W.B., Federal Emissions, Right Side, OE System is completely welded. Additional sizing, bushings, cutting may be required.	645473 ④ -- --	-- -- --
2007	8	8.1L	Cab-Chassis Classic Models Only, 157.5" & 167" W.B., Federal Emissions, Right Side, OE System is completely welded. Additional sizing, bushings, cutting may be required.	645454 ④ -- --	-- -- --
2007	8	8.1L	Cab-Chassis Classic Models Only; 133", 157.5", 167" W.B., Federal Emissions, Left Side, OE system is completely welded. Additional sizing, bushings, cutting may be required.	645455 ④ -- --	-- -- --
GMC SUBURBAN/YUKON					
2009	8	4.8L	Complete Assembly	645821 ③④	--
2009	8	4.8L	Front Left	--	608286③
2009	8	4.8L	Rear Conv.	--	608216③
2009	8	4.8L	Front Right	--	608286③
2009	8	4.8L	Complete Assembly	645797 ③	--
07-08	8	4.8L	Federal Emissions	645459 ④	--
01-05	8	4.8L	Left, Federal Emissions	--	608216④
01-05	8	4.8L	Right, Federal Emissions	--	608216④
01-05	8	4.8L	Complete Assembly, Federal Emissions	645988 ④④	--
			Complete Assembly, Federal Emissions	645236 ③	--
83-87	8	5.0L		645301 ③	609006③
09-14	8	5.3L	Yukon & Yukon XL, Complete Assembly	645821 ③④	--
09-14	8	5.3L	Yukon & Yukon XL, Front Left	--	608286③
09-14	8	5.3L	Yukon & Yukon XL, Rear	--	608216③
09-14	8	5.3L	Yukon & Yukon XL, Front Right	--	608286③
09-14	8	5.3L	Yukon & Yukon XL, Complete Assembly	645797 ③	--
07-08	8	5.3L	1/2 Ton Models, Federal Emissions	645459 ④	--
01-05	8	5.3L	Yukon & Yukon XL, Federal Emissions, Left	--	608216④
01-05	8	5.3L	Yukon & Yukon XL, Federal Emissions, Complete Assembly	645988 ④④	--
			Yukon & Yukon XL, Federal Emissions, Complete Assembly	645236 ③	--
01-05	8	5.3L	Yukon & Yukon XL, Federal Emissions, Right	--	608216④
98-00	8	5.7L	1/2 Ton Models, Dual Convs., to 9200 lbs GVW, Federal Emissions	645328 ④	608234④
96-99	8	5.7L	3/4 Ton Models, Front, to 9200 lbs GVW	645998 ③	608226③
96-99	8	5.7L	3/4 Ton Models, Rear, to 9200 lbs GVW	--	608226③
96-97	8	5.7L	1/2 Ton Models, Dual Convs., to 9200 lbs GVW	645328 ③	608234③

④ Discontinued, use until inventory is depleted.

③ Federal & California Emissions. Not For Sale or Use on vehicles licensed in the state of CA & NY (NY vehicles with CA Emissions). Check with your state authority for details.

④ Federal Emissions. Not For Sale or Use on vehicles licensed in the state of CA. Check with your state authority.



APPLICATION LISTINGS FEDERAL CONVERTERS

YR/YRS	CYL	LITER	DESCRIPTION	DIRECT FIT	UNIVERSAL
GMC SUBURBAN/YUKON (Cont.)					
94-95	8	5.7L	To 8600 lbs GVW	645342 ③	609007 ③
88-93	8	5.7L	To 8600 lbs GVW	645316 ③	604007 ③
88-93	8	5.7L	To 11,000 lbs GVW	646304 ③	606007 ③
1987	8	5.7L	Fuel Injection	645316 ③	609007 ③
83-86	8	5.7L		645301 ③	609006 ③
07-08	8	6.0L	Yukon XL 1500, Federal Emissions	645459 ④	--
01-06	8	6.0L	Yukon Denali, Left	645844 ③	--
01-06	8	6.0L	Yukon Denali, Right	645448 ③	--
02-03	8	6.0L	Federal Emissions, Left	--	608235 ④
02-03	8	6.0L	Federal Emissions, Right	--	608235 ④
2000	8	6.0L	Yukon XL 2500, Right	645287 ③	--
96-99	8	7.4L	3/4 Ton Models, Front	645931 ③	604006 ③
96-99	8	7.4L	3/4 Ton Models, Rear	--	604006 ③
91-95	8	7.4L	To 8600 lbs GVW	645316 ③	604007 ③
91-95	8	7.4L	To 11,000 lbs GVW	646304 ③	606007 ③
87-89	8	7.4L	To 8600 lbs GVW	645316 ③	604007 ③
87-89	8	7.4L	To 11,620 lbs GVW	646304 ③	606007 ③
75-82	8	All		645301 ③	605006 ③
GMC TERRAIN					
10-15	4	2.4L	Rear	642042 ③	608406 ③
10-15	4	2.4L	Front	644015 ③	--
2012	6	3.0L	Manifold Unit, Front Left	641450 ③	--
10-12	6	3.0L	Rear	642041 ③	608406 ③
10-11	6	3.0L	Front Left	641325 ③	--
10-11	6	3.0L	Front Right	641326 ③	--
13-15	6	3.6L	Manifold Unit, Front Left	641450 ③	--
HONDA ACCORD					
84-85	4	1.8L		--	602294 ③
84-85	4	1.8L	Optional Direct Fit Converter	--	602294 ③
81-83	4	1.8L		642378 ③	602214 ③
81-83	4	1.8L	Optional Direct Fit Converter	--	602214 ③
1980	4	1.8L	12-1/2" Conv.	642378 ③	602214 ③
1980	4	1.8L	Optional Direct Fit Converter	--	602214 ③
86-89	4	2.0L	U.S. Models	642378 ③	602214 ③
86-89	4	2.0L	Optional Direct Fit Converter	--	602214 ③
86-87	4	2.0L	(Canada Model)	--	602214 ③
96-97	4	2.2L	2 & 4 Dr., DX / LX / SE	642738 ③	608264 ③
96-97	4	2.2L	LX Wagon	642738 ③	608264 ③
96-97	4	2.2L	EX Sedan & Coupe	642738 ③	608264 ③
94-95	4	2.2L	VTEC, DX / LX / EX Models	642453 ③	602204 ③
91-93	4	2.2L	14" Conv.	642422 ③	602214 ③
91-93	4	2.2L	Optional Direct Fit Converter	642606 ③	602214 ③
90-93	4	2.2L	13" Conv.	642421 ③	602214 ③
90-93	4	2.2L	Optional Direct Fit Converter	642606 ③	602214 ③
98-02	4	2.3L		642682 ③	608264 ③
08-12	4	2.4L	California Emissions w/ Man. Trans., Rear	642118 ⑤	608416 ⑤
08-12	4	2.4L	California Emissions w/ Man. Trans., Front	641281 ⑤	--

③ Federal & California Emissions. Not For Sale or Use on vehicles licensed in the state of CA & NY (NY vehicles with CA Emissions). Check with your state authority for details.

④ Federal Emissions. Not For Sale or Use on vehicles licensed in the state of CA. Check with your state authority.

⑤ California Emissions. Not For Sale or Use on vehicles licensed in the state of CA & NY. Check with your state authority.

APPLICATION LISTINGS

FEDERAL CONVERTERS



YR/YRS	CYL	LITER	DESCRIPTION	DIRECT FIT	UNIVERSAL
HONDA ACCORD (Cont.)					
08-12	4	2.4L	Federal Emissions, Front	641281 ④	--
08-12	4	2.4L	Federal Emissions, Rear	642118 ④	608416④
03-07	4	2.4L		642189 ③	608314③
95-97	6	2.7L		642544 ③	608264③
2007	6	3.0L	Special Edition, Front Left	641355 ③	--
			Special Edition, Front Left	641257 ③①	--
2007	6	3.0L	Special Edition, Front Right	641356 ③	--
			Special Edition, Front Right	641258 ③①	--
03-07	6	3.0L	EX & LX, Front Left	641355 ③	--
			EX & LX, Front Left	641257 ③①	--
03-07	6	3.0L	EX & LX, Front Right	641356 ③	--
			EX & LX, Front Right	641258 ③①	--
03-07	6	3.0L	Rear Main Conv.	642185 ③	608415③①
00-02	6	3.0L		642717 ③	608265③
98-99	6	3.0L	Federal Emissions	642770 ④	608265④
98-99	6	3.0L	California Emissions	642731 ⑤	608265⑤
08-15	6	3.5L	Front Left	641334 ③	--
08-15	6	3.5L	Front Right	641413 ③	--
13-14	6	3.5L	Center	644008 ③	--
10-12	6	3.5L	Rear	642035 ③	608295③
08-09	6	3.5L	Rear	642035 ④	608295④
HONDA ACCORD CROSSTOUR					
10-11	6	3.5L	Rear	642035 ③	608295③
10-11	6	3.5L	Front Right	641413 ③	--
10-11	6	3.5L	Front Left	641334 ③	--
HONDA CIVIC					
06-11	4	1.3L	Hybrid, Front	641421 ③	--
06-11	4	1.3L	Hybrid, Rear	642003 ③	--
03-05	4	1.3L	Hybrid Rear Conv., exc. models w/ NOX adsorptive converter	642071 ③	--
03-05	4	1.3L	Hybrid, Front	641377 ③	--
80-83	4	1.3L		642378 ③	602214③
80-83	4	1.3L	Optional Direct Fit Converter	--	602214③
94-95	4	1.5L	DX / SI, 3 Dr. Hatchback	642487 ③	602214③
94-95	4	1.5L	Optional Direct Fit Converter	642605 ③	602214③
92-95	4	1.5L	DX, Auto Trans.	642487 ③	602214③
92-95	4	1.5L	Optional Direct Fit Converter	642605 ③	602214③
1993	4	1.5L	DX / SI, 3 Dr. Hatchback	--	602214③
92-93	4	1.5L	DX, (Exc. Auto Trans.)	--	602214③
90-91	4	1.5L	3 Dr.	642382 ③	602214③
90-91	4	1.5L	Optional Direct Fit Converter	642605 ③	602214③
88-90	4	1.5L	DX	642382 ③	602214③
88-90	4	1.5L	Optional Direct Fit Converter	642605 ③	602214③
88-90	4	1.5L	4 Dr.	642382 ③	602214③
88-90	4	1.5L	Optional Direct Fit Converter	642605 ③	602214③
86-87	4	1.5L	EFI, SI 3 Dr.	--	602204③
80-83	4	1.5L		642378 ③	602214③
80-83	4	1.5L	Optional Direct Fit Converter	--	602214③

- ① Discontinued, use until inventory is depleted.
- ③ Federal & California Emissions. Not For Sale or Use on vehicles licensed in the state of CA & NY (NY vehicles with CA Emissions). Check with your state authority for details.
- ④ Federal Emissions. Not For Sale or Use on vehicles licensed in the state of CA. Check with your state authority.
- ⑤ California Emissions. Not For Sale or Use on vehicles licensed in the state of CA & NY. Check with your state authority.
- ① EPA Enhanced OBDII By Design Unit
Exc. Models with NOX Adsorptive Converter



APPLICATION LISTINGS FEDERAL CONVERTERS

YR/YRS	CYL	LITER	DESCRIPTION	DIRECT FIT	UNIVERSAL
HONDA CIVIC (Cont.)					
99-00	4	1.6L	SI or EX Models	642582 ③	608264 ③
96-00	4	1.6L	CX, DX, LX	642597 ③	--
96-98	4	1.6L	EX / HX / SI	642786 ③	--
94-95	4	1.6L	DX / SI, 3 Dr. Hatchback	642487 ③	602214 ③
94-95	4	1.6L	Optional Direct Fit Converter	642605 ③	602214 ③
93-95	4	1.6L	EX Models	642487 ③	602214 ③
93-95	4	1.6L	Optional Direct Fit Converter	642605 ③	602214 ③
1992	4	1.6L	EX Coupe or Sedan	--	602214 ③
90-91	4	1.6L	3 Dr.	642382 ③	602214 ③
90-91	4	1.6L	Optional Direct Fit Converter	642605 ③	602214 ③
89-90	4	1.6L	SI 3 Dr.	642382 ③	602214 ③
89-90	4	1.6L	Optional Direct Fit Converter	642605 ③	602214 ③
01-05	4	1.7L	(Exc. VTEC Eng.)	642281 ③	--
01-05	4	1.7L	EX Models	642785 ③	608404 ③○
			EX Models	--	608264 ③□
10-11	4	1.8L	GX, Front	641322 ③	--
09-11	4	1.8L	EX-L & LX-S, Front	641322 ③	--
06-11	4	1.8L	DX, EX & LX; Front	641322 ③	--
06-11	4	2.0L	SI Models	642224 ③	608326 ③○
88-89	4	All	Station Wgn.	642382 ③	602214 ③
88-89	4	All	Optional Direct Fit Converter	642605 ③	602214 ③
HONDA CIVIC DEL SOL					
93-95	4	1.5L		642487 ③	602214 ③
93-95	4	1.5L	Optional Direct Fit Converter	642605 ③	602214 ③
96-97	4	1.6L	S Models	642597 ③	--
93-95	4	1.6L		642487 ③	602214 ③
93-95	4	1.6L	Optional Direct Fit Converter	642605 ③	602214 ③
HONDA CROSSTOUR					
12-14	6	3.5L	Front Right	641413 ③	--
12-14	6	3.5L	Front Left	641334 ③	--
HONDA CRV					
99-01	4	2.0L		642732 ③	608264 ③
97-98	4	2.0L		642732 ③	608264 ③
10-11	4	2.4L	Front	641415 ③	--
07-09	4	2.4L		642127 ③	608316 ③○
02-06	4	2.4L		642288 ③	608314 ③○
				--	608264 ③□
HONDA CRX					
88-91	4	1.5L	DX	642382 ③	602214 ③
88-91	4	1.5L	Optional Direct Fit Converter	642605 ③	602214 ③
85-87	4	1.5L	SI	--	602204 ③
88-91	4	1.6L	SI	642382 ③	602214 ③
88-91	4	1.6L	Optional Direct Fit Converter	642605 ③	602214 ③
HONDA ELEMENT					
03-11	4	2.4L		642184 ③	608316 ③○

③ Federal & California Emissions. Not For Sale or Use on vehicles licensed in the state of CA & NY (NY vehicles with CA Emissions). Check with your state authority for details.

□ EPA OBDII By Design Unit

○ EPA Enhanced OBDII By Design Unit

APPLICATION LISTINGS

FEDERAL CONVERTERS



YR/YRS	CYL	LITER	DESCRIPTION	DIRECT FIT	UNIVERSAL
HONDA FIT					
07-08	4	1.5L	Auto Trans.	642117 ③	--
HONDA INSIGHT					
00-06	3	1.0L	Hybrid Front Conv.	--	X25 ③
00-01	3	1.0L	Hybrid Front Conv., Manual Trans.	641237 ③	--
00-01	3	1.0L	Hybrid Rear Conv., Manual Trans.	642225 ③	--
10-14	4	1.3L	Rear	642897 ③	--
HONDA ODYSSEY					
96-97	4	2.2L		642732 ③	608264 ③
1995	4	2.2L		642605 ③	602214 ③
1998	4	2.3L		642759 ③	608264 ③
11-14	6	3.5L	Rear	642035 ③	608295 ③
11-14	6	3.5L	Front Right	641413 ③	--
11-14	6	3.5L	Front Left	641334 ③	--
08-10	6	3.5L	EX & LX, Front Left	641355 ③	--
			EX & LX, Front Left	641257 ③①	--
08-10	6	3.5L	EX & LX, Front Right	641356 ③	--
			EX & LX, Front Right	641258 ③①	--
08-10	6	3.5L	EX-L & Touring, Front Left	641273 ③	--
08-10	6	3.5L	EX-L & Touring, Front Right	641274 ③	--
05-10	6	3.5L	Rear Main	642185 ③	608415 ③①
05-07	6	3.5L	Front Left	641355 ③	--
			Front Left	641257 ③①	--
05-07	6	3.5L	Front Right	641356 ③	--
			Front Right	641258 ③①	--
99-04	6	3.5L		642717 ③	608265 ③
HONDA PASSPORT					
94-95	4	2.6L		--	602206 ③
98-02	6	3.2L	Right, Auto Trans., Federal Emissions	642760 ④	608214 ④
98-02	6	3.2L	Left, Auto Trans., Federal Emissions	642761 ④	608214 ④
96-97	6	3.2L	Right, Auto Trans.	642720 ③	608264 ③
96-97	6	3.2L	Left, Auto Trans.	642970 ③	608264 ③
94-95	6	3.2L	Front, Auto Trans.	641181 ③	--
94-95	6	3.2L		642380 ③	602206 ③
HONDA PILOT					
09-15	6	3.5L	Front Left	641334 ③	--
09-14	6	3.5L	Rear	642035 ③	608295 ③
09-11	6	3.5L	Front Right	641413 ③	--
05-08	6	3.5L	Front Left	641355 ③	--
			Front Left	641257 ③①	--
05-08	6	3.5L	Front Right	641356 ③	--
			Front Right	641258 ③①	--
05-08	6	3.5L	Rear Main	642185 ③	608415 ③
03-04	6	3.5L		642262 ③	608265 ③
HONDA PRELUDE					
83-87	4	1.8L		--	602294 ③
83-87	4	1.8L	Optional Direct Fit Converter	--	602294 ③
81-82	4	1.8L		642378 ③	602214 ③

Ⓞ Discontinued, use until inventory is depleted.

③ Federal & California Emissions. Not For Sale or Use on vehicles licensed in the state of CA & NY (NY vehicles with CA Emissions). Check with your state authority for details.

④ Federal Emissions. Not For Sale or Use on vehicles licensed in the state of CA. Check with your state authority.

⓪ EPA Enhanced OBDII By Design Unit



APPLICATION LISTINGS FEDERAL CONVERTERS

YR/YRS	CYL	LITER	DESCRIPTION	DIRECT FIT	UNIVERSAL
HONDA PRELUDE (Cont.)					
81-82	4	1.8L	Optional Direct Fit Converter	--	602214 ^③
1980	4	1.8L	Auto Trans.	642378 ^③	602214 ^③
1980	4	1.8L	Optional Direct Fit Converter, Auto Trans.	--	602214 ^③
1980	4	1.8L	Manual Trans.	--	602204 ^③
88-91	4	2.0L		642378 ^③	602214 ^③
88-91	4	2.0L	Optional Direct Fit Converter	--	602214 ^③
85-87	4	2.0L		642421 ^③	602204 ^③
85-87	4	2.0L	Optional Direct Fit Converter	642606 ^③	602214 ^③
97-01	4	2.2L		642188 ^③	608264 ^③
92-95	4	2.2L		642606 ^③	602214 ^③
1996	4	2.3L		--	608264 ^③
92-95	4	2.3L		--	602214 ^③
92-95	4	2.3L	Optional Direct Fit Converter	642606 ^③	602214 ^③
HONDA RIDGELINE					
09-14	6	3.5L	Front Left	641334 ^③	--
09-14	6	3.5L	Rear	642035 ^③	608295 ^③
09-11	6	3.5L	Front Right	641413 ^③	--
06-08	6	3.5L	Front Left	641355 ^③	--
			Front Left	641257 ^{③①}	--
06-08	6	3.5L	Front Right	641356 ^③	--
			Front Right	641258 ^{③①}	--
06-08	6	3.5L	Rear Main Conv.	642185 ^③	608415 ^③
HONDA S2000					
00-03	4	2.0L	VTEC Engine	642704 ^③	--
04-05	4	2.2L		642704 ^③	--
HUMMER H2					
2007	8	6.0L		645277 ^③	--
03-06	8	6.0L	Right	645429 ^③	--
03-06	8	6.0L	Left	645873 ^③	--
2008	8	6.2L		645277 ^③	--
HUMMER H3					
2006	5	3.5L	Front	642196 ^③	--
07-08	5	3.7L	Manifold Unit, Front	641338 ^③	--
2007	5	3.7L	Rear	645852 ^③	608415 ^③
08-10	8	5.3L	Left	645179 ^③	--
08-10	8	5.3L	Right	645180 ^③	--
HYUNDAI ACCENT					
00-02	4	1.5L	Manifold Conv.	642788 ^③	--
98-99	4	1.5L	SOHC	642796 ^③	--
96-97	4	1.5L	SOHC	642578 ^③	608214 ^③
96-97	4	1.5L	DOHC	642578 ^③	608214 ^③
1995	4	1.5L	SOHC	642578 ^③	602214 ^③
12-14	4	1.6L	Rear Conv., Requires Resonator Pipe 58555 to Complete Installation, As OE was a One Piece Welded Assembly	642036 ^③	608294 ^③
				--	--
10-11	4	1.6L	Rear Conv.	642073 ^③	--
06-10	4	1.6L	Manifold Conv.	642121 ^③	--
06-09	4	1.6L	Rear Conv.	642178 ^③	--

① Discontinued, use until inventory is depleted.

③ Federal & California Emissions. Not For Sale or Use on vehicles licensed in the state of CA & NY (NY vehicles with CA Emissions). Check with your state authority for details.

APPLICATION LISTINGS

FEDERAL CONVERTERS



YR/YRS	CYL	LITER	DESCRIPTION	DIRECT FIT	UNIVERSAL
HYUNDAI ACCENT (Cont.)					
01-05	4	1.6L	Manifold Conv.	642232 ③	--
HYUNDAI AZERA					
07-08	6	3.3L	Manifold Unit, Front	641310 ③	--
07-08	6	3.3L	Rear Manifold Conv.	641311 ③	--
06-10	6	3.8L	Manifold Unit, Front	641310 ③	--
06-10	6	3.8L	Rear Manifold Conv.	641311 ③	--
06-09	6	3.8L	Rear Main Conv.	642208 ③	608265③
HYUNDAI ELANTRA					
92-95	4	1.6L		642403 ③	602204③
1998	4	1.8L		642745 ③	--
96-98	4	1.8L		642578 ③	608214③
93-94	4	1.8L		642403 ③	602204③
04-12	4	2.0L	Straight Outlet, Manifold Unit, Front	641344 ③	--
			Straight Outlet, Manifold Unit, Front	641271 ③④	--
06-10	4	2.0L	Manifold Conv. w/ Curved Outlet, Calif. Emissions	641312 ⑤	--
07-08	4	2.0L	Rear, Federal Emissions	642176 ④	--
06-08	4	2.0L	Rear, California Emission	642827 ⑤	608415⑤
04-05	4	2.0L	Rear, OAL 14 3/4", California Emissions	642171 ⑤	608214⑤
04-05	4	2.0L	Rear, Federal Emissions	642072 ④	608214④
01-05	4	2.0L	Manifold Conv. w/ Curved Outlet, Calif. Emissions	641180 ⑤	--
01-05	4	2.0L	Manifold Conv. w/ Curved Outlet, Federal Emissions	641180 ④	--
2003	4	2.0L	Rear, Federal Emissions	642290 ④	608214④
2003	4	2.0L	W/ CVT Engine, Straight Outlet, Manifold Unit, Front	641344 ③	--
			W/ CVT Engine, Straight Outlet, Manifold Unit, Front	641271 ③④	--
01-03	4	2.0L	Rear, California Emissions	642147 ⑤	608214⑤
01-02	4	2.0L	Rear, Federal Emissions	--	608214④
99-00	4	2.0L	Front	642745 ③	--
99-00	4	2.0L	Rear, California Emissions	642578 ⑤	608204⑤
HYUNDAI ENTOURAGE					
07-08	6	3.8L	Manifold Unit, Front	641310 ③	--
07-08	6	3.8L	Rear Manifold Conv.	641311 ③	--
07-08	6	3.8L	Rear Main Conv.	642066 ③	--
HYUNDAI EXCEL					
90-94	4	1.5L		642385 ③	602214③
86-89	4	1.5L	Rear, w/Air Tube	--	602004③
86-89	4	1.5L	Rear, w/o Air Tube	--	602204③
86-89	4	1.5L	Main & Pre-Cat	--	602004③
HYUNDAI GENESIS COUPE					
10-12	4	2.0L	Front	641429 ③	--
HYUNDAI SANTA FE					
10-12	4	2.4L	Rear	642052 ③	608414③
01-04	4	2.4L	Front	641154 ③	--
01-04	4	2.4L	Rear	642989 ③	608215③
07-09	6	2.7L	Manifold Unit, Front	641439 ③	--
			Manifold Unit, Front	641275 ③④	--
07-09	6	2.7L	Rear Manifold Conv.	641340 ③	--
			Rear Manifold Conv.	641276 ③④	--

① Discontinued, use until inventory is depleted.

② Federal & California Emissions. Not For Sale or Use on vehicles licensed in the state of CA & NY (NY vehicles with CA Emissions). Check with your state authority for details.

④ Federal Emissions. Not For Sale or Use on vehicles licensed in the state of CA. Check with your state authority.

⑤ California Emissions. Not For Sale or Use on vehicles licensed in the state of CA & NY. Check with your state authority.



APPLICATION LISTINGS FEDERAL CONVERTERS

YR/YRS	CYL	LITER	DESCRIPTION	DIRECT FIT	UNIVERSAL
HYUNDAI SANTA FE (Cont.)					
07-09	6	2.7L	Rear Main Conv.	642130 ③	--
01-06	6	2.7L	Rear Manifold Conv.	641254 ③	--
01-06	6	2.7L	Rear Main Conv.	642966 ③	608235 ③
01-04	6	2.7L	Manifold Unit, Front	641253 ③	--
07-09	6	3.3L	Rear	642057 ③	--
07-09	6	3.3L	Front Left Manifold Conv.	641332 ③	--
07-09	6	3.3L	Front Right Manifold Conv.	641333 ③	--
03-06	6	3.5L	Rear Main Conv.	643043 ③	--
03-06	6	3.5L	Front Right	641261 ③	--
			Front Right	641285 ③Ⓞ	--
03-06	6	3.5L	Front Left	641260 ③	--
			Front Left	641284 ③Ⓞ	--
2004	6	3.5L	Rear Main Conv.	643062 ③Ⓞ	--
HYUNDAI SCOUPE					
93-95	4	1.5L	Turbo	642403 ③	602204 ③
91-95	4	1.5L	(Exc. Turbo)	642385 ③	602214 ③
HYUNDAI SONATA					
96-98	4	2.0L		642789 ③	608205 ③
92-95	4	2.0L		642403 ③	602204 ③
11-14	4	2.4L	Hybrid, Hybrid Limited, Rear	642828 ③	608265 ③
2011	4	2.4L	Federal Emissions, Exc. Hybrid	642113 ④	--
2010	4	2.4L	Federal Emissions, Rear	642067 ③	--
09-10	4	2.4L	California Emissions, w/o Center O2 Port, Rear	642828 ⑤	608265 ⑤
2009	4	2.4L	Federal Emissions, Rear	642236 ④	608414 ④Ⓞ
			Federal Emissions, Rear	--	608264 ④□
06-08	4	2.4L		642236 ③	608414 ③Ⓞ
				--	608264 ④□
06-07	4	2.4L	Front	641231 ③	--
99-05	4	2.4L	Front	641154 ③	--
99-05	4	2.4L	Rear	642986 ③	608205 ③
89-91	4	2.4L		642403 ③	602204 ③
99-01	6	2.5L	Front Manifold Conv., w/ Curved Outlet	641157 ③	--
99-01	6	2.5L	Rear Manifold Conv., w/ Curved Outlet	641158 ③	--
99-01	6	2.5L	Rear Main Conv.	642980 ③	608204 ③
02-05	6	2.7L	Front Manifold Conv., w/ Curved Outlet	641157 ③	--
02-05	6	2.7L	Rear Manifold Conv., w/ Curved Outlet	641158 ③	--
1996	6	3.0L		642789 ③	608205 ③
90-95	6	3.0L		--	602204 ③
09-10	6	3.3L	Rear	642830 ③	608415 ③
2008	6	3.3L	Rear	642057 ③	--
06-07	6	3.3L	Manifold Unit, Front	641310 ③	--
06-07	6	3.3L	Federal Emissions, Rear	642170 ④	--
06-07	6	3.3L	Rear Manifold Conv.	641311 ③	--
HYUNDAI STELLAR					
85-86	4	1.6L	(Canada Model)	--	602004 ③
1987	4	2.0L	(Canada Model)	--	602004 ③

- Ⓞ Discontinued, use until inventory is depleted.
- ③ Federal & California Emissions. Not For Sale or Use on vehicles licensed in the state of CA & NY (NY vehicles with CA Emissions). Check with your state authority for details.
- ④ Federal Emissions. Not For Sale or Use on vehicles licensed in the state of CA. Check with your state authority.
- ⑤ California Emissions. Not For Sale or Use on vehicles licensed in the state of CA & NY. Check with your state authority.
- 152 □ EPA OBDII By Design Unit
- EPA Enhanced OBDII By Design Unit

APPLICATION LISTINGS

FEDERAL CONVERTERS



YR/YRS	CYL	LITER	DESCRIPTION	DIRECT FIT	UNIVERSAL
HYUNDAI TIBURON					
1997	4	1.8L	Rear, M Eng.	642578 ③	608204 ③
07-08	4	2.0L	Straight Outlet, Manifold Unit, Front	641344 ③	--
03-06	4	2.0L	Manifold Conv.	641180 ③	--
03-06	4	2.0L	Rear, Federal Emissions	642290 ④	608415 ④○
			Rear, Federal Emissions	--	608214 ④□
03-06	4	2.0L	Rear, California Emission	642147 ③	608214 ③
98-01	4	2.0L	Models w/1 Piece Manifold Conv.; From 8/16/98	642745 ③	--
98-01	4	2.0L	Rear, California Emissions	642578 ⑤	--
03-05	6	2.7L	Manifold Unit, Front	641157 ③	--
03-05	6	2.7L	Rear Manifold Conv.	641201 ③	--
03-05	6	2.7L	Rear Main Conv.	642274 ③	608205 ③
HYUNDAI TUCSON					
05-08	4	2.0L	Rear	642064 ③	--
05-06	4	2.0L	Manifold Conv.	641313 ③	--
05-09	6	2.7L	Left Manifold Conv., Up To 01/01/09	641280 ③	--
05-09	6	2.7L	FWD, Right Manifold Conv.	641327 ③	--
			FWD, Right Manifold Conv.	641279 ③○	--
05-08	6	2.7L	Rear	642065 ③	--
05-08	6	2.7L	4WD, Manifold Unit, Front Right	641441 ③	--
HYUNDAI VELOSTER					
12-15	4	1.6L	Naturally Aspirated, Rear	643126 ③	--
HYUNDAI VERACRUZ					
07-12	6	3.8L	Manifold Unit, Front Left	641332 ③	--
07-12	6	3.8L	Manifold Unit, Front Right	641333 ③	--
07-12	6	3.8L	Rear	642057 ③	--
HYUNDAI XG300					
2001	6	3.0L	Manifold Unit, Front	641203 ③	--
2001	6	3.0L	Rear Manifold Conv.	641208 ③	--
2001	6	3.0L		643031 ③	608265 ③
HYUNDAI XG350					
02-05	6	3.5L	Rear Conv.	643031 ③	608265 ③
02-03	6	3.5L	Front Manifold	641203 ③	--
02-03	6	3.5L	Rear Manifold	641208 ③	--
INFINITI FX35					
03-08	V6	3.5L	Left	642714 ③	--
03-08	V6	3.5L	Right	642713 ③	--
INFINITI FX45					
07-08	8	4.5L	Rear Right	642881 ③	--
07-08	8	4.5L	Rear Left	642880 ③	--
03-08	8	4.5L	Front Right	642068 ③	--
03-08	8	4.5L	Front Left	642070 ③	--
2005	8	4.5L	Rear Right	642096 ③	--
2005	8	4.5L	Rear Left	642097 ③	--
INFINITI G20					
00-02	4	2.0L		642793 ③	608295 ③
91-94	4	2.0L		642409 ☆③	602205 ③

○ Discontinued, use until inventory is depleted.

☆ Air Tube kit 4948 may be required for installation.

③ Federal & California Emissions. Not For Sale or Use on vehicles licensed in the state of CA & NY (NY vehicles with CA Emissions). Check with your state authority for details.

④ Federal Emissions. Not For Sale or Use on vehicles licensed in the state of CA. Check with your state authority.

⑤ California Emissions. Not For Sale or Use on vehicles licensed in the state of CA & NY. Check with your state authority.

□ EPA OBDII By Design Unit

○ EPA Enhanced OBDII By Design Unit



APPLICATION LISTINGS FEDERAL CONVERTERS

YR/YRS	CYL	LITER	DESCRIPTION	DIRECT FIT	UNIVERSAL
INFINITI G35					
03-07	6	3.5L	Right	642713 ③	--
03-07	6	3.5L	Left	642714 ③	--
INFINITI I30					
00-01	6	3.0L	Front, California Emissions	641167 ⑤	--
00-01	6	3.0L	Middle Conv., California Emissions	642779 ⑤	--
00-01	6	3.0L	Rear, California Emissions	642793 ⑤	608295 ⑤
1999	6	3.0L	California Emissions, Center	642850 ⑤	--
96-99	6	3.0L	Rear	642574 ③	608235 ③
96-98	6	3.0L	Front	642680 ③	--
INFINITI I35					
02-04	6	3.5L	Manifold Unit, Front	641182 ③	--
02-04	6	3.5L	Rear Manifold Conv.	641183 ③	--
02-04	6	3.5L	Rear Main Conv.	642764 ③	--
INFINITI J30					
93-97	6	3.0L	Right, (Includes '97 J30t)	642248 ③	608204 ③
93-97	6	3.0L	Left, (Includes '97 J30t)	642247 ③	608204 ③
INFINITI M30					
90-92	6	3.0L		--	602205 ③
INFINITI M35					
06-08	6	3.5L	Right	642713 ③	--
06-08	6	3.5L	Left	642714 ③	--
INFINITI M45					
06-10	8	4.5L	Manifold Unit, Front Right	642068 ③	--
06-10	8	4.5L	Manifold Unit, Front Left	642070 ③	--
03-04	8	4.5L	Rear Main Conv.	642153 ③	--
INFINITI Q45					
02-06	8	4.5L	Rear Main Conv.	642153 ③	--
02-05	8	4.5L	Left	--	608294 ③
02-05	8	4.5L	Right	--	608294 ③
2002	8	4.5L	Right Manifold Conv.	641288 ③	--
90-95	8	4.5L	Rear-Left	--	609004 ③
90-95	8	4.5L	Rear-Right	--	609004 ③
INFINITI QX4					
98-00	6	3.3L	Rear Right, California Emissions	642283 ⑤	608204 ⑤
98-00	6	3.3L	Rear Left, California Emissions	642282 ⑤	608204 ⑤
97-00	6	3.3L	Front, Right	641134 ③	--
97-00	6	3.3L	Front, Left	641133 ③	--
01-03	6	3.5L	Front Right	641212 ③	--
01-03	6	3.5L	Front Left	641133 ③	--
2001	6	3.5L	Rear Right	642283 ③	608204 ③
2001	6	3.5L	Rear Left	642282 ③	608204 ③
INFINITI QX56					
07-10	8	5.6L	Rear Right	642115 ③	608405 ③
07-10	8	5.6L	Rear Left	642031 ③	608405 ③
04-06	V8	5.6L	Manifold Unit, Right	642075 ③	--
04-06	V8	5.6L	Manifold Unit, Left	642074 ③	--
04-06	V8	5.6L	Without Flex, US EPA, BIN 8, SULEV Emissions, Right Rear	642115 ③	608405 ③

③ Federal & California Emissions. Not For Sale or Use on vehicles licensed in the state of CA & NY (NY vehicles with CA Emissions). Check with your state authority for details.

⑤ California Emissions. Not For Sale or Use on vehicles licensed in the state of CA & NY. Check with your state authority.

APPLICATION LISTINGS

FEDERAL CONVERTERS



YR/YRS	CYL	LITER	DESCRIPTION	DIRECT FIT	UNIVERSAL
INFINITI QX56 (Cont.)					
04-06	V8	5.6L	Without Flex, US EPA, BIN 8, SULEV Emissions, Left Rear	642116 ③	608405 ③
INTERNATIONAL HARVESTER					
79-80	6	All		--	602206 ③
79-80	8	5.0L		--	602206 ③
79-80	8	5.6L		--	604006 ③
ISUZU AMIGO					
98-00	4	2.2L	Federal Emissions	643036 ④	--
89-93	4	2.3L		642380 ③	602206 ③
89-94	4	2.6L		642380 ③	602206 ③
ISUZU ASCENDER					
06-07	6	4.2L	Non-Extended Wheelbase, 113" W.B.	645864 ③	608206 ③
04-05	6	4.2L	Non-Extended Wheelbase, 113" W.B.	645878 ③	608216 ③
04-05	6	4.2L	Extended Wheelbase, 129" W.B.	645804 ③	608216 ③
2006	8	5.3L		645186 ③	--
ISUZU I-280					
2006	4	2.8L	Rear	645852 ③	608415 ③
2006	4	2.8L	Front	641216 ③	--
ISUZU I-290					
07-08	4	2.9L	Manifold Unit, Front	641339 ③	--
ISUZU I-350					
2006	5	3.5L	Rear	645852 ③	608415 ③
2006	5	3.5L	Front	642196 ③	--
ISUZU I-370					
07-08	5	3.7L	Front Main Conv.	641338 ③	--
ISUZU I-MARK					
87-89	4	1.5L	Turbo, Rear	--	602295 ③
85-89	4	1.5L	(Exc. Turbo), Rear	--	602206 ③
85-89	4	1.5L	(Exc. Turbo), Optional Direct Fit Converter	642380 ③	602206 ③
1989	4	1.6L	DOHC	--	602204 ③
81-85	4	1.8L		--	602206 ③
81-85	4	1.8L	Optional Direct Fit Converter	642380 ③	602206 ③
ISUZU IMPULSE					
90-92	4	1.6L		642380 ③	602206 ③
1992	4	1.8L		642380 ③	602206 ③
83-86	4	1.9L		642380 ③	602206 ③
87-89	4	2.0L		642380 ③	602206 ③
85-86	4	2.0L		642380 ③	602206 ③
88-89	4	2.3L		642380 ③	602206 ③
ISUZU OASIS					
96-97	4	2.2L		642732 ③	608264 ③
98-99	4	2.3L		642759 ③	608264 ③
ISUZU PICKUP					
96-00	4	2.2L	Hombre Models	642543 ③	608205 ③
86-95	4	2.3L		642380 ③	602206 ③
88-95	4	2.6L	(Exc. 27-1/2" Conv.)	642380 ③	602206 ③
81-87	4	All		642380 ③	602206 ③
91-94	6	3.1L		642380 ③	602206 ③

③ Federal & California Emissions. Not For Sale or Use on vehicles licensed in the state of CA & NY (NY vehicles with CA Emissions). Check with your state authority for details.

④ Federal Emissions. Not For Sale or Use on vehicles licensed in the state of CA. Check with your state authority.



APPLICATION LISTINGS FEDERAL CONVERTERS

YR/YRS	CYL	LITER	DESCRIPTION	DIRECT FIT	UNIVERSAL
ISUZU PICKUP (Cont.)					
98-99	6	4.3L	Hombre 2WD, w/ 31 1/2" OAL Conv.	642710 ③	608226 ③
98-99	6	4.3L	Hombre 4WD	645372 ③	608226 ③
98-99	6	4.3L	Hombre, 2WD & Extended Cab, California Emissions	641227 ⑤	608264 ⑤
1997	6	4.3L	Hombre 2WD	645348 ③	608226 ③
ISUZU RODEO					
01-03	4	2.2L		643108 ③	--
98-00	4	2.2L	Federal Emissions	643036 ④	--
91-95	4	2.6L		642380 ③	602206 ③
91-92	6	3.1L		642380 ③	602206 ③
98-02	6	3.2L	Right, Auto Trans., Federal Emissions	642760 ④	608205 ④
98-02	6	3.2L	Left, Auto Trans., Federal Emissions	642761 ④	608205 ④
96-97	6	3.2L	Right, Auto Trans.	642720 ③	608264 ③
96-97	6	3.2L	Left, Auto Trans.	642970 ③	608264 ③
94-95	6	3.2L	Front, 4WD Auto Trans.	641181 ③	--
94-95	6	3.2L		642380 ③	602294 ③
1993	6	3.2L	Front, 4WD Auto Trans., California Emissions	641181 ⑤	--
1993	6	3.2L	Rear, 4WD Auto Trans., California Emissions	642380 ⑤	602294 ⑤
ISUZU RODEO SPORT					
01-03	4	2.2L		643108 ③	--
ISUZU STYLUS					
91-93	4	All		--	602206 ③
ISUZU TROOPER					
84-91	4	All		--	602206 ③
89-91	6	2.8L		642380 ③	602206 ③
92-95	6	3.2L	Main Conv.	--	602206 ③
00-02	6	3.5L	Without Torque Control, Right Side	643080 ③	--
98-02	6	3.5L	Left	643079 ③	608264 ③
98-99	6	3.5L	Auto Trans., Right Side	643080 ③	--
ISUZU VEHICROSS					
99-01	6	3.5L	Left	643079 ③	608264 ③
JAGUAR S-TYPE					
00-02	6	3.0L	Right	643026 ③	--
00-02	6	3.0L	Left	642230 ③	--
00-02	8	4.0L	Left	642742 ③	608204 ③
00-02	8	4.0L	Right	642975 ③	608204 ③
JAGUAR VANDEN PLAS					
04-06	6	4.2L	Naturally Aspirated, Right	645190 ③	--
04-06	6	4.2L	Naturally Aspirated, Left	645189 ③	--
JAGUAR X-TYPE					
02-03	6	2.5L	Front Right	641419 ③	--
02-03	6	2.5L	Front Left	641418 ③	--
02-03	6	3.0L	Front Left	641418 ③	--
02-03	6	3.0L	Front Right	641419 ③	--
JAGUAR XJ6					
90-94	6	4.0L	Front Left	--	602214 ③
90-94	6	4.0L	Rear Left	--	609004 ③
90-94	6	4.0L	Front Right	--	602214 ③

③ Federal & California Emissions. Not For Sale or Use on vehicles licensed in the state of CA & NY (NY vehicles with CA Emissions). Check with your state authority for details.

④ Federal Emissions. Not For Sale or Use on vehicles licensed in the state of CA. Check with your state authority.

⑤ California Emissions. Not For Sale or Use on vehicles licensed in the state of CA & NY. Check with your state authority.

APPLICATION LISTINGS

FEDERAL CONVERTERS



YR/YRS	CYL	LITER	DESCRIPTION	DIRECT FIT	UNIVERSAL
JAGUAR XJ6 (Cont.)					
90-94	6	4.0L	Rear Right	--	609004③
90-92	6	4.0L	Rear, DOHC	--	609004③
JAGUAR XJ8					
04-06	6	4.2L	Naturally Aspirated, Right	645190 ③	--
04-06	6	4.2L	Naturally Aspirated, Left	645189 ③	--
JAGUAR XJ12					
94-96	12	6.0L	Right	642182 ③	--
94-96	12	6.0L	Rear	643037 ③	--
78-79	12	All	Left	--	602214③
78-79	12	All	Right	--	602214③
75-77	12	All	Left	--	602214③
75-77	12	All	Right	--	602214③
JAGUAR XJS					
80-92	12	All	Front Left	--	602214③
80-92	12	All	Rear Left	--	609004③
80-92	12	All	Front Right	--	602214③
80-92	12	All	Rear Right	--	609004③
78-79	12	All	Left	--	602214③
78-79	12	All	Right	--	602214③
76-77	12	All	Left	--	602214③
76-77	12	All	Right	--	602214③
JEEP CHEROKEE					
96-00	4	2.5L	w/o Converter Flanges	645327 ③	608226③
93-95	4	2.5L		642451 ③	602205③
86-92	4	2.5L		642311 ③	602205③
84-85	4	2.5L		642420 ☆③	602204③
84-86	6	2.8L		642420 ☆③	602205③
00-01	6	4.0L	Front; From 01/20/00	641172 ③	--
00-01	6	4.0L	Rear; From 01/20/00	645423 ③	608226③
96-00	6	4.0L	To 01/20/00	645327 ③	608226③
93-95	6	4.0L		642451 ③	602205③
87-92	6	4.0L		642311 ③	602205③
82-83	6	4.2L		--	602004③
1981	6	4.2L	(Exc. w/ 2-1/2" Pipe)	--	602004③
79-81	6	4.2L		--	602206③
81-83	8	5.9L		--	605004③
79-80	8	5.9L		--	605006③
1978	8	5.9L		--	609006③
JEEP CJ					
84-86	4	2.5L		--	602004③
80-83	4	2.5L		--	602206③
82-86	6	4.2L		--	602004③
80-81	6	4.2L	w/Air Tube	--	602006③
80-81	6	4.2L	w/o Air Tube	--	602206③
1979	6	4.2L		--	602206③
75-78	6	All		--	605006③
1981	8	5.0L		642357 ②③	602204③

☆ Air Tube kit 4948 may be required for installation.

② When using with aftermarket piping, direct fit converter may require INLET/OUTLET pipe resizing.

③ Federal & California Emissions. Not For Sale or Use on vehicles licensed in the state of CA & NY (NY vehicles with CA Emissions). Check with your state authority for details.



APPLICATION LISTINGS FEDERAL CONVERTERS

YR/YRS	CYL	LITER	DESCRIPTION	DIRECT FIT	UNIVERSAL
JEEP CJ (Cont.)					
79-80	8	5.0L		--	602205 ^③
75-78	8	5.0L		--	602206 ^③
JEEP COMANCHE					
1986	4	2.5L		642311 ^③	602205 ^③
1986	6	2.8L		642420 ☆ ^③	602004 ^③
87-92	4,6	All		642311 ^③	602205 ^③
JEEP COMMANDER					
08-10	6	3.7L		645226 ^③	--
06-07	6	3.7L		645450 ^③	--
2006	6	4.7L		642151 ^③	--
2008	8	5.7L	Complete Assembly	642077 ^③	--
06-07	8	5.7L		645232 ^③	--
JEEP COMPASS					
07-11	4	2.0L	FWD	642231 ^③	608316 ^③ ○
07-08	4	2.0L	4WD, Front	641235 ^③	--
07-08	4	2.0L	4WD, Rear	645452 ^③	--
07-11	4	2.4L	FWD	642231 ^③	608316 ^③ ○
07-10	4	2.4L	4WD, Front	641235 ^③	--
07-09	4	2.4L	4WD, Rear	645452 ^③	--
JEEP GRAND CHEROKEE/GRAND WAGONEER					
07-09	6	3.7L		645226 ^③	--
05-06	6	3.7L		645450 ^③	--
02-04	6	4.0L	Front	641177 ^③	--
02-04	6	4.0L		645417 ^③	608226 ^③
2001	6	4.0L	Front, Federal Emissions	641177 ^④	--
2001	6	4.0L		645422 ^③	608226 ^③
96-00	6	4.0L	w/o Flange	645327 ^③	608226 ^③
93-95	6	4.0L		642451 ^③	602205 ^③
84-86	6	4.2L		--	602004 ^③
05-06	8	4.7L		642151 ^③	--
02-04	8	4.7L	Rear, Federal Emissions	645417 ^④	608226 ^④
02-04	8	4.7L	Front	642027 ^③	--
2001	8	4.7L	Front	641209 ^③	--
2001	8	4.7L		645422 ^③	608226 ^④
99-00	8	4.7L	Front, California Emissions	641209 ^⑤	--
99-00	8	4.7L	Rear, California Emissions	645422 ^⑤	608226 ^⑤
99-00	8	4.7L	Federal Emissions	645422 ^④	608226 ^④
96-98	8	5.2L	w/o Flange	645327 ^③	608235 ^③
93-95	8	5.2L		642536 ^③	602205 ^③
05-10	8	5.7L		645232 ^③	--
1998	8	5.9L	w/o Flange	645327 ^③	608235 ^③
84-91	8	5.9L		645315 ☆ ^③	609006 ^③
JEEP J-Series PICKUP					
82-86	6	4.2L		--	602004 ^③
1981	6	4.2L	w/Air Tube	--	602004 ^③
1981	6	4.2L	w/o Air Tube	--	602205 ^③
79-80	6	4.2L		--	602205 ^③

☆ Air Tube kit 4948 may be required for installation.

③ Federal & California Emissions. Not For Sale or Use on vehicles licensed in the state of CA & NY (NY vehicles with CA Emissions). Check with your state authority for details.

④ Federal Emissions. Not For Sale or Use on vehicles licensed in the state of CA. Check with your state authority.

⑤ California Emissions. Not For Sale or Use on vehicles licensed in the state of CA & NY. Check with your state authority.

APPLICATION LISTINGS

FEDERAL CONVERTERS



YR/YRS	CYL	LITER	DESCRIPTION	DIRECT FIT	UNIVERSAL
JEEP J-Series PICKUP (Cont.)					
81-88	8	5.9L		--	602004 ^③
79-80	8	5.9L		--	602205 ^③
JEEP LIBERTY					
2008	6	3.7L	Complete Assembly	645830 ^③	--
2008	6	3.7L	Right	--	608314 ^{③○}
2008	6	3.7L	Left	--	608316 ^{③○}
2007	6	3.7L	Complete Assembly	645874 ^{③④}	--
05-07	6	3.7L	Left	--	608215 ^③
05-07	6	3.7L	Right	--	608215 ^③
05-07	6	3.7L		645798 ^③	--
2006	6	3.7L	Federal Emissions, Complete Assembly	645874 ^{④⑤}	--
2005	6	3.7L	Complete Assembly	645874 ^{③④}	--
2004	6	3.7L	Right	645435 ^③	608265 ^{③○}
2004	6	3.7L	Left	645867 ^③	608265 ^{③○}
02-03	6	3.7L	Front Left, To 02/14/03	641143 ^③	--
02-03	6	3.7L	Front Right, To 02/14/03	641142 ^③	--
02-03	6	3.7L	Rear, To 02/14/03	643040 ^③	608235 ^③
JEEP PATRIOT					
07-11	4	2.0L	FWD	642231 ^③	608316 ^{③○}
07-08	4	2.0L	4WD, Manifold Unit, Front	641235 ^③	--
07-08	4	2.0L	4WD, Rear	645452 ^③	--
2010	4	2.4L	FWD	642231 ^③	608316 ^{③○}
07-09	4	2.4L	FWD	642231 ^③	608316 ^{③○}
07-08	4	2.4L	4WD, Manifold Unit, Front	641235 ^③	--
07-08	4	2.4L	4WD, Rear	645452 ^③	--
JEEP SCRAMBLER					
84-85	4	2.5L		--	602004 ^③
81-83	4	2.5L		--	602205 ^③
82-85	6	4.2L		--	602004 ^③
1981	6	4.2L	w/Air Tube	--	602004 ^③
1981	6	4.2L	w/o Air Tube	--	602205 ^③
JEEP WAGONEER					
86-87	4	2.5L		642311 ^③	602205 ^③
84-85	4	2.5L	w/Air Tube	642420 ^{☆③}	602004 ^③
84-86	6	2.8L		642420 ^{☆③}	602004 ^③
87-90	6	4.0L		642311 ^③	602205 ^③
82-83	6	4.2L		--	602004 ^③
80-81	6	4.2L	w/Air Tube	--	602004 ^③
80-81	6	4.2L	w/o Air Tube	--	602205 ^③
81-83	8	5.9L		--	602004 ^③
79-80	8	5.9L		--	602205 ^③
1978	8	5.9L		--	609006 ^③
JEEP WRANGLER					
01-02	4	2.5L	Rear Main Conv., w/O2 Sensor	645373 ^③	--
99-00	4	2.5L	w/Front Pipe	645406 ^③	608235 ^③
97-99	4	2.5L	w/o Front Pipe, Additional sizing, bushings, cutting may be required due to OE exhaust design.	645421 ^③	608235 ^③

③ Discontinued, use until inventory is depleted.

☆ Air Tube kit 4948 may be required for installation.

③ Federal & California Emissions. Not For Sale or Use on vehicles licensed in the state of CA & NY (NY vehicles with CA Emissions). Check with your state authority for details.

④ Federal Emissions. Not For Sale or Use on vehicles licensed in the state of CA. Check with your state authority.

○ EPA Enhanced OBDII By Design Unit



APPLICATION LISTINGS FEDERAL CONVERTERS

YR/YRS	CYL	LITER	DESCRIPTION	DIRECT FIT	UNIVERSAL
JEEP WRANGLER (Cont.)					
97-98	4	2.5L	w/Front Pipe	645405 ③	608235 ③
93-95	4	2.5L		642483 ③	609005 ③
87-92	4	2.5L		642311 ③	602205 ③
07-09	6	3.8L		645269 ③	--
04-06	6	4.0L		645865 ③	--
00-03	6	4.0L	Front	641160 ③	--
00-03	6	4.0L	Rear Main Conv., w/O2 Sensor	645373 ③	608235 ③
00-03	6	4.0L	Rear Main Conv., w/o O2 Sensor	645358 ③	608235 ③
97-00	6	4.0L	w/Front Pipe; To 1/24/00	645893 ③	--
			w/Front Pipe; To 1/24/00	645892 ③④	608235 ③
97-99	6	4.0L	w/o Front Pipe, Additional sizing, bushings, cutting may be required due to OE exhaust design.	645421 ③	608235 ③
				--	--
93-95	6	4.0L		645349 ③	609005 ③
91-92	6	4.0L		642311 ③	602205 ③
87-90	6	4.2L		642420 ☆③	602004 ③
KIA AMANTI					
04-06	6	3.5L		643031 ③	608265 ③○
07-09	6	3.8L	Manifold Unit, Front	641310 ③	--
07-09	6	3.8L	Rear Manifold Conv.	641311 ③	--
07-09	6	3.8L	Rear Main Conv.	642208 ③	608265 ③○
KIA FORTE					
2013	4	2.0L	Auto Trans., California Emissions, w/o Center O2 Port, Rear	642828 ⑤	608265 ⑤
10-12	4	2.0L	California Emissions, w/o Center O2 Port, Rear	642828 ⑤	608265 ⑤
10-13	4	2.4L	California Emissions, w/o Center O2 Port, Rear	642828 ⑤	608265 ⑤
10-12	4	2.4L	Federal Emissions, w/ Center O2 Port, Rear	642067 ④	--
KIA FORTE KOUP					
10-14	4	2.0L	California Emissions, w/o Center O2 Port, Rear	642828 ⑤	608265 ⑤
10-13	4	2.4L	California Emissions, w/o Center O2 Port, Rear	642828 ⑤	608265 ⑤
10-12	4	2.4L	Rear, Federal Emissions	642067 ④	--
KIA OPTIMA					
13-14	4	2.4L	Hybrid EX, Hybrid LX, Rear	642828 ⑤	608265 ⑤
09-10	4	2.4L	Rear	642067 ③	--
07-08	4	2.4L	Front Conv.	641231 ③	--
07-08	4	2.4L	Rear Conv.	642236 ③	608414 ③○
			Rear Conv.	--	608264 ③□
2006	4	2.4L	Front, w/ Eng. VIN 6	641154 ③	--
2006	4	2.4L	Rear, w/ Eng. VIN 6	642986 ③	608205 ③
2006	4	2.4L	Front, w/ Eng. VIN 3	641231 ③	--
2006	4	2.4L	Rear, w/ Eng. VIN 3	642236 ③	608414 ③○
			Rear, w/ Eng. VIN 3	--	608264 ③□
01-05	4	2.4L	Front	641154 ③	--
01-05	4	2.4L	Rear	642986 ③	608205 ③
2001	6	2.5L	Front Manifold Conv., w/ Curved Outlet	641157 ③	--
2001	6	2.5L	Rear Manifold Conv., w/ Curved Outlet	641158 ③	--
07-08	6	2.7L	Manifold Unit, Front Left	641439 ③	--
2006	6	2.7L	Rear Manifold Conv., VIN 8 Only or With Curved Outlet	641158 ③	--
2006	6	2.7L	Front Manifold Conv., VIN 8 Only or With Curved Outlet	641157 ③	--

③ Discontinued, use until inventory is depleted.

☆ Air Tube kit 4948 may be required for installation.

③ Federal & California Emissions. Not For Sale or Use on vehicles licensed in the state of CA & NY (NY vehicles with CA Emissions). Check with your state authority for details.

④ Federal Emissions. Not For Sale or Use on vehicles licensed in the state of CA. Check with your state authority.

160 ⑤ California Emissions. Not For Sale or Use on vehicles licensed in the state of CA & NY. Check with your state authority.

□ EPA OBDII By Design Unit

○ EPA Enhanced OBDII By Design Unit

APPLICATION LISTINGS

FEDERAL CONVERTERS



YR/YRS	CYL	LITER	DESCRIPTION	DIRECT FIT	UNIVERSAL
KIA OPTIMA (Cont.)					
2006	6	2.7L	Eng. VIN 4, Manifold Unit, Front Left	641439 ③	--
02-05	6	2.7L	Front Manifold Conv., w/ Curved Outlet	641157 ③	--
02-05	6	2.7L	Rear Manifold Conv., w/ Curved Outlet	641158 ③	--
KIA RIO					
01-02	4	1.5L	Manifold Unit, Front	641194 ③	--
01-02	4	1.5L		642296 ③	608234 ③
12-14	4	1.6L	Rear Conv., Requires Resonator Pipe 58555 to Complete Installation, As OE was a One Piece Welded Assembly	642036 ③	608294 ③
06-11	4	1.6L	Rear Conv.	642178 ③	--
06-10	4	1.6L	Manifold Conv.	642121 ③	--
03-05	4	1.6L	Manifold Conv.	641176 ③	--
03-04	4	1.6L		--	608204 ③
KIA RIO5					
06-10	4	1.6L	Manifold Conv.	642121 ③	--
06-09	4	1.6L	Rear Conv.	642178 ③	--
KIA RONDO					
09-10	4	2.4L	Rear, From 10/08	642067 ③	608316 ③
2009	4	2.4L	Rear, From 10/08	642190 ③④	608316 ③④
07-09	4	2.4L	Rear, To 10/08	642236 ③	608414 ③④
			Rear, To 10/08	--	608264 ③□
2007	4	2.7L	Rear Main Conv.	642130 ③	--
07-10	6	2.7L	Manifold Unit, Front Left	641439 ③	--
KIA SEDONA					
02-05	6	3.5L	Front Manifold	641203 ③	--
02-05	6	3.5L	Rear Manifold	641208 ③	--
02-05	6	3.5L	Rear Main	642273 ③	608205 ③
06-10	6	3.8L	Rear Main Conv.	642066 ③	--
06-10	6	3.8L	Manifold Unit, Front	641310 ③	--
06-10	6	3.8L	Rear Manifold Conv.	641311 ③	--
KIA SEPHIA					
96-97	4	1.6L		--	608234 ③
1995	4	1.6L		--	608234 ③
1994	4	1.6L	SOHC	642403 ③	602204 ③
99-01	4	1.8L	Front, From 05/11/99	641186 ③	--
99-01	4	1.8L	Rear, From 05/11/99	642575 ③	608234 ③
98-99	4	1.8L	Front, To 05/11/99	641123 ③	--
98-99	4	1.8L	Rear, To 05/11/99	642553 ③	608204 ③
96-97	4	1.8L		--	608234 ③
1995	4	1.8L		--	608234 ③
KIA SORENTO					
11-13	4	2.4L	Rear	642052 ③	608414 ③
08-09	6	3.3L	Rear Left	642825 ③	--
08-09	6	3.3L	Rear Right	642825 ③	--
03-06	6	3.5L	Front Left	641287 ③	--
03-06	6	3.5L	Rear Conv.	642409 ③	--
03-06	6	3.5L	Front Right	641287 ③	--
07-09	6	3.8L	Rear Left	642825 ③	--

- ④ Discontinued, use until inventory is depleted.
- ③ Federal & California Emissions. Not For Sale or Use on vehicles licensed in the state of CA & NY (NY vehicles with CA Emissions). Check with your state authority for details.
- EPA OBDII By Design Unit
- EPA Enhanced OBDII By Design Unit



APPLICATION LISTINGS FEDERAL CONVERTERS

YR/YRS	CYL	LITER	DESCRIPTION	DIRECT FIT	UNIVERSAL
KIA SORENTO (Cont.)					
07-09	6	3.8L	Rear Right	642825 ③	--
KIA SOUL					
10-11	4	2.0L	Straight Outlet, Manifold Unit, Front	641344 ③	--
10-11	4	2.0L	Rear	642176 ③	--
KIA SPECTRA					
01-04	4	1.8L	Front, From 05/22/01	641230 ③	--
00-04	4	1.8L	w/Flat 2 Bolt Inlet Gasket, 13" OAL, Rear Conv.	642575 ③	608234 ③
00-01	4	1.8L	Front, To 05/22/01	641186 ③	--
08-09	4	2.0L	Front Manifold Conv., w/ Curved Outlet	641312 ③	--
07-09	4	2.0L	California Emissions, ULEV, 9-3/4" OAL, Rear	642227 ⑤	608264 ⑤
07-09	4	2.0L	Federal Emissions, 10-1/4" OAL, Rear	642195 ④	--
04-09	4	2.0L	Straight Outlet, Manifold Unit, Front	641344 ③	--
			Straight Outlet, Manifold Unit, Front	641252 ④⑥	--
			Straight Outlet, Manifold Unit, Front	641233 ⑤⑥	--
04-07	4	2.0L	Auto. Trans., Federal Emissions, Before 7/12/07, 14 3/4" OAL, Rear Conv.	642171 ④	--
05-06	4	2.0L	13" OAL, Rear Conv.	642575 ③	608234 ③
05-06	4	2.0L	Rear Conv.	642575 ③	608234 ③
KIA SPECTRA5					
08-09	4	2.0L	Front Manifold Conv., w/ Curved Outlet	641312 ③	--
06-09	4	2.0L	Straight Outlet, Manifold Unit, Front	641344 ③	--
06-07	4	2.0L	Auto. Trans., Federal Emissions, 14 3/4" OAL, Rear Conv.	642171 ④	--
KIA SPORTAGE					
05-10	4	2.0L	Rear	642064 ③	--
05-08	4	2.0L	Manifold Conv.	641313 ③	--
01-02	4	2.0L	Front, Manual Trans.	641148 ③	--
01-02	4	2.0L	Rear, Manual Trans.	--	608204 ③
01-02	4	2.0L	Front, Auto Trans.	641128 ③	--
01-02	4	2.0L	Rear, Auto Trans.	642596 ③	608235 ③
98-00	4	2.0L	Front, First Design System (2 piece)	641148 ③	--
98-00	4	2.0L	Rear, First Design System (2 piece)	642609 ③	608234 ③
98-00	4	2.0L	Front, Second Design System (3 piece)	641122 ③	--
98-00	4	2.0L	Rear, Second Design System (3 piece)	642708 ③	608234 ③
96-97	4	2.0L	Main Conv.	--	608234 ③
1995	4	All	All, (Exc. 14-5/8" Conv.)	--	602204 ③
1995	4	All	All 14-5/8" Conv.	642578 ③	602204 ③
05-10	6	2.7L	Rear	642065 ③	--
05-10	6	2.7L	FWD, Right Manifold Conv.	641327 ③	--
05-10	6	2.7L	AWD, Manifold Unit, Front Right	641441 ③	--
LADA SAMARA					
87-93	4	All	Samara (Canada Model)	--	602214 ③
LANCIA BETA					
1981	4	2.0L	Fuel Injection	--	602203 ③
1979	4	2.0L	California Emissions, w/Carb.	--	602203 ⑤
LANCIA ZAGATO					
81-82	4	2.0L	Fuel Injection	--	602203 ③
1979	4	2.0L	California Emissions, w/Carb.	--	602203 ⑤

⑥ Discontinued, use until inventory is depleted.

③ Federal & California Emissions. Not For Sale or Use on vehicles licensed in the state of CA & NY (NY vehicles with CA Emissions). Check with your state authority for details.

④ Federal Emissions. Not For Sale or Use on vehicles licensed in the state of CA. Check with your state authority.

⑤ California Emissions. Not For Sale or Use on vehicles licensed in the state of CA & NY. Check with your state authority.

APPLICATION LISTINGS

FEDERAL CONVERTERS



YR/YRS	CYL	LITER	DESCRIPTION	DIRECT FIT	UNIVERSAL
LAND ROVER DEFENDER 90					
94-95	8	3.9L	Right	--	608235③
94-95	8	3.9L	Left	--	608235③
LAND ROVER DEFENDER 110					
1993	8	3.9L	Left	--	609004③
1993	8	3.9L	Right	--	609004③
LAND ROVER DISCOVERY					
94-95	8	3.9L	Right	--	608235③
94-95	8	3.9L	Left	--	608235③
99-02	8	4.0L		645993 ③	--
96-98	8	4.0L		645992 ③	--
03-04	8	4.6L		645993 ③	--
LAND ROVER FREELANDER					
02-05	6	2.5L	Front	645465 ③	--
02-05	6	2.5L	Rear	645466 ③	--
LAND ROVER LR2					
08-12	8	3.2L	Manifold Unit, Right	641422 ③	--
08-12	8	3.2L	Manifold Unit, Left	641423 ③	--
LAND ROVER RANGE ROVER					
90-94	8	3.9L	Left	--	608235③
90-94	8	3.9L	Right	--	608235③
99-00	8	4.0L	Center	645786 ③	--
1995	8	4.0L	Left	--	608234③
1995	8	4.0L	Right	--	608234③
2006	8	4.2L	Left	645191 ③	--
2006	8	4.2L	Right	645192 ③	--
94-95	8	4.2L	LWB, Left Side	--	609004③
94-95	8	4.2L	LWB, Right Side	--	609004③
2006	8	4.4L	Right	645192 ③	--
2006	8	4.4L	Left	645191 ③	--
99-02	8	4.6L	Center	645786 ③	--
LEXUS ES250					
90-91	6	2.5L		642403 ③	602204③
LEXUS ES300					
02-03	6	3.0L	Manifold Unit, Front	641305 ③	--
02-03	6	3.0L	Rear Manifold Conv.	641307 ③	--
02-03	6	3.0L	Rear Main	643014 ③	608414③
99-01	6	3.0L	Front Manifold Conv., California Emissions	641204 ⑤	--
99-01	6	3.0L	Middle Conv., California Emissions	642259 ⑤	--
99-01	6	3.0L	Rear Conv.	643021 ③	608265③
97-99	6	3.0L	Auto Trans., Federal Emissions	642930 ④	608294④
97-99	6	3.0L	Manual Trans. Federal Emissions	--	608294④
96-98	6	3.0L	Front Manifold Conv., California Emissions	641204 ⑤	--
96-98	6	3.0L	Main Conv., U.S. Built, Calif. Emissions	642993 ⑤	--
1995	6	3.0L		--	608294③
92-94	6	3.0L		642334 ③	602296③
LEXUS ES330					
04-06	6	3.3L	Rear Main, USA Built, Auto Trans.	643014 ③	608414③○

- ③ Federal & California Emissions. Not For Sale or Use on vehicles licensed in the state of CA & NY (NY vehicles with CA Emissions). Check with your state authority for details.
- ④ Federal Emissions. Not For Sale or Use on vehicles licensed in the state of CA. Check with your state authority.
- ⑤ California Emissions. Not For Sale or Use on vehicles licensed in the state of CA & NY. Check with your state authority.
- EPA Enhanced OBDII By Design Unit



APPLICATION LISTINGS FEDERAL CONVERTERS

YR/YRS	CYL	LITER	DESCRIPTION	DIRECT FIT	UNIVERSAL
LEXUS ES330 (Cont.)					
04-06	6	3.3L	Rear Manifold Conv.	641308 ③	--
04-06	6	3.3L	Manifold Unit, Front	641306 ③	--
LEXUS ES350					
07-11	6	3.5L	Manifold Unit, Front	641295 ③	--
07-11	6	3.5L	To 08/2010, Rear Manifold Conv.	641293 ③	--
LEXUS GS300					
00-05	6	3.0L	w/42" Conv., Rear	642223 ③	608294 ③
98-05	6	3.0L	Manifold Conv.	642792 ③	--
93-97	6	3.0L		642270 ③	608285 ③
93-94	6	3.0L	Front	642271 ③	--
LEXUS GS400					
98-00	8	4.0L	Left	642702 ③	--
98-00	8	4.0L	Right	642702 ③	--
LEXUS GS430					
01-07	8	4.3L	Left	642702 ③	--
01-07	8	4.3L	Right	642702 ③	--
01-05	8	4.3L	Rear	642837 ③	--
LEXUS GX470					
05-09	8	4.7L	Rear Right	642010 ③	608414 ③
05-09	8	4.7L	Rear Left	642005 ③	608414 ③
05-09	8	4.7L	From 11/2004, Front Left	641330 ③	--
05-09	8	4.7L	From 11/2004, Front Right	641331 ③	--
03-05	8	4.7L	Manifold Unit, Front Right	641436 ③	--
03-05	8	4.7L	Manifold Unit, Front Left	641435 ③	--
03-04	8	4.7L	Rear Main	642186 ③	608415 ③○
LEXUS IS250					
06-12	6	2.5L	Rear Complete Assembly, RWD	643053 ③	--
06-12	6	2.5L	AWD, Manifold Unit, Front Left	641403 ③	--
06-12	6	2.5L	AWD, Manifold Unit, Front Right	641404 ③	--
LEXUS IS300					
01-05	6	3.0L	Manifold Conv.	642792 ③	--
01-05	6	3.0L	w/42" Conv., Rear	642223 ③	608294 ③
LEXUS IS350					
06-12	6	3.5L	RWD, Rear	643129 ③	--
LEXUS LS400					
99-00	8	4.0L	Right	642743 ③	--
99-00	8	4.0L	Left	642744 ③	--
1998	8	4.0L	Right	642852 ③	--
1998	8	4.0L	Left	642702 ③	--
95-97	8	4.0L	Rear	643121 ③	--
90-97	8	4.0L	Left	642690 ③	602214 ③
90-97	8	4.0L	Right	642690 ③	602214 ③
90-94	8	4.0L	Rear	642882 ③	--
LEXUS LS430					
01-06	8	4.3L	Left	642702 ③	--
01-06	8	4.3L	Right	642702 ③	--
01-03	8	4.3L	Rear Main Conv.	642100 ③	--

③ Federal & California Emissions. Not For Sale or Use on vehicles licensed in the state of CA & NY (NY vehicles with CA Emissions). Check with your state authority for details.

○ EPA Enhanced OBDII By Design Unit

APPLICATION LISTINGS

FEDERAL CONVERTERS



YR/YRS	CYL	LITER	DESCRIPTION	DIRECT FIT	UNIVERSAL
LEXUS LX450					
96-97	6	4.5L	Rear	645469 ③	609004 ③
96-97	6	4.5L	Front	645267 ③	608406 ③
LEXUS LX470					
98-02	8	4.7L	Left	645193 ③	--
98-02	8	4.7L	Right	645193 ③	--
LEXUS RX300					
99-03	6	3.0L	Front	641173 ③	--
99-03	6	3.0L	Center	641174 ③	--
99-03	6	3.0L	Rear, OE exhaust system is completely welded, P/N 7511 resonator pipe is required for installation.	645835 ③①	--
			Rear, OE exhaust system is completely welded, P/N 7511 resonator pipe is required for installation.	642817 ③ ¹	608416 ③
				--	--
LEXUS RX330					
04-06	6	3.3L	Manifold Unit, Front	641238 ③	--
04-06	6	3.3L	Rear Manifold Conv.	641240 ③	--
04-06	6	3.3L	Main Conv., Due to O.E. design, #8 bushing or sizing with aftermarket pipe may be required	645456 ③	--
				--	--
LEXUS RX350					
07-09	6	3.5L	Manifold Unit, Front	641298 ③	--
07-09	6	3.5L	Rear Manifold Conv.	641299 ③	--
07-09	6	3.5L	Rear, Requires Welded Assembly 7505 to complete installation as OE is complete welded assembly	645270 ③	--
				--	--
LEXUS RX400H					
06-08	6	3.3L	Rear, Requires Welded Assembly 7885 to Complete Installation	642024 ③	608414 ③
06-08	6	3.3L	Manifold Unit, Front Right	641399 ③	--
LEXUS SC300					
98-00	6	3.0L	Manifold Conv.	642792 ③	--
93-97	6	3.0L		642270 ③	608285 ③
93-94	6	3.0L	Front	642271 ③	--
LEXUS SC400					
92-97	8	4.0L	Left	642690 ③	--
92-97	8	4.0L	Right	642267 ③	--
92-97	8	4.0L	Rear	642882 ③	--
LEXUS SC430					
02-10	8	4.3L	Rear	642841 ③	--
02-09	8	4.3L	Left	642702 ③	--
02-09	8	4.3L	Right	642702 ③	--
LINCOLN AVIATOR					
03-05	8	4.6L	Rear Conv.	--	608226 ③
03-05	8	4.6L	Front Left	--	608265 ③
03-05	8	4.6L	Front Right	--	608265 ③
LINCOLN CONTINENTAL					
90-94	6	3.8L	From 12/89, Left	--	602204 ③
90-94	6	3.8L	Complete, From 12/89	642358 ③	602204 ③
90-94	6	3.8L	From 12/89, Right	--	602204 ③
88-90	6	3.8L	Rear, To 12/89	--	602204 ③
88-90	6	3.8L	Main & Pre-Cat, To 12/89	--	602204 ③
1982	6	3.8L	Rear	--	602005 ③

¹ OE system was a welded assembly. It is recommended that all parts noted [1] should be replaced.

③ Discontinued, use until inventory is depleted.

③ Federal & California Emissions. Not For Sale or Use on vehicles licensed in the state of CA & NY (NY vehicles with CA Emissions). Check with your state authority for details.



APPLICATION LISTINGS FEDERAL CONVERTERS

YR/YRS	CYL	LITER	DESCRIPTION	DIRECT FIT	UNIVERSAL
LINCOLN CONTINENTAL (Cont.)					
1982	6	3.8L	Main & Pre-Cat	--	602005③
95-02	8	4.6L	Front	642540 ③	--
95-02	8	4.6L		642552 ③	--
1987	8	5.0L	California Emissions, Models w/Dual Exhaust, Rear Left	--	602535⑤
1987	8	5.0L	California Emissions, Models w/Dual Exhaust, Front Right	--	602535⑤
1987	8	5.0L	California Emissions, Models w/Dual Exhaust, Front Left	--	602535⑤
1987	8	5.0L	California Emissions, Models w/Dual Exhaust, Rear Right	--	602535⑤
85-87	8	5.0L	Rear, (Exc. Dual Exhaust)	--	602005③
85-87	8	5.0L	(Exc. Dual Exhaust), Main & Pre-Cat	--	602005③
85-87	8	5.0L	w/Dual Exhaust, Front Left	--	602205③
85-87	8	5.0L	w/Dual Exhaust, Rear Left	--	609005③
85-87	8	5.0L	w/Dual Exhaust, Front Right	--	602205③
85-87	8	5.0L	w/Dual Exhaust, Rear Right	--	609005③
83-84	8	5.0L	Left	--	602005③
83-84	8	5.0L	Right	--	602005③
1982	8	5.0L		--	602005③
1980	8	5.0L	Left	--	602214③
1980	8	5.0L	Right	--	602214③
1980	8	5.8L	Left	--	602214③
1980	8	5.8L	Right	--	602214③
LINCOLN LS					
02-05	6	3.0L	Right	643026 ③	608274③
02-05	6	3.0L	Left	642230 ③	608274③
00-01	6	3.0L	Right, Auto Trans.	643026 ③	608274③
00-01	6	3.0L	Left, Auto Trans.	642230 ③	608274③
2004	8	3.9L	Complete Assembly, 07/03 to 07/04	642982 ③	--
2004	8	3.9L	Front Left, 07/03 to 07/04	--	608405③○
			Front Left, 07/03 to 07/04	--	608204③□
2004	8	3.9L	Front Right, 07/03 to 07/04	--	608405③○
			Front Right, 07/03 to 07/04	--	608204③□
2003	8	3.9L	Complete Assembly	643066 ③	--
00-01	8	3.9L	Right; To 7/16/01	642975 ③	608204③
00-01	8	3.9L	Left; To 7/16/01	642742 ③	608204③
LINCOLN MARK LT					
06-08	8	5.4L	2WD, Right	645843 ③	608316③
06-08	8	5.4L	2WD, Left	645461 ③	608316③
06-08	8	5.4L	4WD, Right	645829 ③	608316③
06-08	8	5.4L	4WD, Left	645471 ③	608316③
2006	8	5.4L	4WD, w/ 2 Converters, California Emissions, Base Payload, To 8/8/05, Left	645217 ⑤	--
				--	--
2006	8	5.4L	4WD, w/ 2 Converters, California Emissions, Base Payload, To 8/8/05, Right	645218 ⑤	--
				--	--
LINCOLN MARK Series					
97-98	8	4.6L	Mark "8", Left Conv. w/Manifold	645393 ③	--
97-98	8	4.6L	Mark "8", Right Conv. w/Single Inlet Muffler	645932 ③	--
97-98	8	4.6L	Mark "8", Right Conv. w/Dual Inlet Muffler	642944 ③	--
95-96	8	4.6L	Mark "8", Left Conv. w/Manifold	645371 ③	--

③ Federal & California Emissions. Not For Sale or Use on vehicles licensed in the state of CA & NY (NY vehicles with CA Emissions). Check with your state authority for details.

⑤ California Emissions. Not For Sale or Use on vehicles licensed in the state of CA & NY. Check with your state authority.

□ EPA OBDII By Design Unit

○ EPA Enhanced OBDII By Design Unit

APPLICATION LISTINGS

FEDERAL CONVERTERS



YR/YRS	CYL	LITER	DESCRIPTION	DIRECT FIT	UNIVERSAL
LINCOLN MARK Series (Cont.)					
95-96	8	4.6L	Mark "8", Right Conv. w/Single Inlet Muffler	645932 ③	--
95-96	8	4.6L	Mark "8", Right Conv. w/Dual Inlet Muffler	642944 ③	--
93-94	8	4.6L	Mark "8", Left Conv. w/Manifold	645371 ③	--
93-94	8	4.6L	Mark "8", Right Conv. w/Single Inlet Muffler	645932 ③	--
93-94	8	4.6L	Mark "8", Right Conv. w/Dual Inlet Muffler	642944 ③	--
88-92	8	5.0L	w/Dual Exhaust, Left	--	602205③
88-92	8	5.0L	Complete, Dual Exhaust	--	609005③
88-92	8	5.0L	w/Dual Exhaust, Right	--	602205③
87-91	8	5.0L	California Emissions, Exc. 1989, Rear Left	--	602535⑤
87-91	8	5.0L	California Emissions, Exc. 1989, Front Right	--	602535⑤
87-91	8	5.0L	California Emissions, Exc. 1989, Front Left	--	602535⑤
87-91	8	5.0L	California Emissions, Exc. 1989, Rear Right	--	602535⑤
86-87	8	5.0L	Rear	--	602005③
86-87	8	5.0L	Main & Pre-Cat	--	602005③
84-85	8	5.0L	Left	--	602005③
84-85	8	5.0L	Right	--	602005③
82-83	8	5.0L	Left	--	602004③
82-83	8	5.0L	Right	--	602004③
1981	8	5.0L	Left, (Exc. Dual Exhaust)	--	602004③
1981	8	5.0L	Right, (Exc. Dual Exhaust)	--	602004③
80-81	8	5.0L	w/Dual Exhaust, Rear Left	--	602004③
80-81	8	5.0L	w/Dual Exhaust, Rear Right	--	602004③
80-81	8	5.0L	w/Dual Exhaust, Front Right	--	602004③
80-81	8	5.0L	w/Dual Exhaust, Front Left	--	602004③
77-79	8	6.6L	Left	--	605004③
77-79	8	6.6L	Right	--	605004③
75-76	8	7.5L	Left	--	605004③
75-76	8	7.5L	Right	--	605004③
LINCOLN MKS					
09-10	6	3.7L	Front Conv.	642215 ③	--
09-10	6	3.7L	Rear Conv.	642214 ③	--
LINCOLN MKX					
07-10	6	3.5L	Front Conv.	642215 ③	--
07-10	6	3.5L	Rear Conv.	642214 ③	--
11-14	6	3.7L	Manifold Unit, Front Left	641388 ③	--
11-14	6	3.7L	Manifold Unit, Front Right	641389 ③	--
LINCOLN MKZ					
07-10	6	3.5L	Front Conv.	642215 ③	--
07-10	6	3.5L	Rear Conv.	642214 ③	--
LINCOLN NAVIGATOR					
07-14	8	5.4L	Left	645281 ③	--
07-14	8	5.4L	Right	645282 ③	--
05-06	8	5.4L	Left	645285 ③	608315③
05-06	8	5.4L	Right	645286 ③	608315③
03-04	8	5.4L	Left	645278 ③	--
03-04	8	5.4L	Right	645279 ③	--
01-02	8	5.4L	Right, 4WD	645445 ③	--

③ Federal & California Emissions. Not For Sale or Use on vehicles licensed in the state of CA & NY (NY vehicles with CA Emissions). Check with your state authority for details.
 ⑤ California Emissions. Not For Sale or Use on vehicles licensed in the state of CA & NY. Check with your state authority.



APPLICATION LISTINGS FEDERAL CONVERTERS

YR/YRS	CYL	LITER	DESCRIPTION	DIRECT FIT	UNIVERSAL
LINCOLN NAVIGATOR (Cont.)					
01-02	8	5.4L	Left, 4WD	645446 ③	--
01-02	8	5.4L	Front Left, 4WD	--	608294 ③
01-02	8	5.4L	Rear Left, 4WD	--	608206 ③
01-02	8	5.4L	Front Right, 4WD	--	608294 ③
01-02	8	5.4L	Rear Right, 4WD	--	608206 ③
98-00	8	5.4L	Front Left	--	608295 ③
98-00	8	5.4L	Rear Left	--	608235 ③
98-00	8	5.4L	Complete Right Assembly, 4WD, 4R100 Trans.	645384 ③	--
98-00	8	5.4L	Complete Left Assembly, 4WD, 4R100 Trans.	645385 ③	--
98-00	8	5.4L	Front Right	--	608295 ③
98-00	8	5.4L	Rear Right	--	608235 ③
LINCOLN TOWN CAR					
03-11	8	4.6L	Front Left	--	608274 ③
03-11	8	4.6L	Rear Left	--	608284 ③
03-11	8	4.6L	Right	642161 ③	--
03-11	8	4.6L	Left	642179 ③	--
03-11	8	4.6L	Front Right	--	608274 ③
03-11	8	4.6L	Rear Right	--	608284 ③
03-06	8	4.6L	Right	642733 ③①	--
03-06	8	4.6L	Left	642734 ③①	--
96-02	8	4.6L	Right	642550 ③	--
96-02	8	4.6L	Left	642549 ③	--
96-02	8	4.6L	Rear Left	--	608204 ③
96-02	8	4.6L	Rear Right	--	608204 ③
96-02	8	4.6L	Front Left	--	608294 ③
96-02	8	4.6L	Front Right	--	608294 ③
1995	8	4.6L	Right	642463 ③	608204 ③
1995	8	4.6L	Left	642462 ③	608204 ③
91-94	8	4.6L	Right, Main & Pre-Cat	642436 ③	602204 ③
91-94	8	4.6L	Left, Main & Pre-Cat	642437 ③	602204 ③
1990	8	5.0L	Right Side, Main & Pre-Cat	642390 ☆③	602004 ③
1990	8	5.0L	Left, Main & Pre-Cat	642391 ☆③	602004 ③
1990	8	5.0L	California Emissions, Right Side, Main & Pre-Cat	--	602534 ⑤
1990	8	5.0L	California Emissions, Left Side, Main & Pre-Cat	--	602534 ⑤
1989	8	5.0L	Right Side, Main & Pre-Cat	642390 ☆③	602004 ③
1989	8	5.0L	Left, Main & Pre-Cat	642391 ☆③	602004 ③
86-88	8	5.0L	Right Side	642390 ☆③	602004 ③
86-88	8	5.0L	Left Side	642391 ☆③	602004 ③
86-88	8	5.0L	California Emissions, Right Side, Main & Pre-Cat	--	602534 ⑤
86-88	8	5.0L	California Emissions, Left Side, Main & Pre-Cat	--	602534 ⑤
81-85	8	5.0L	Right Side	--	602004 ③
81-85	8	5.0L	Left	--	602004 ③
LINCOLN VERSAILLES					
1980	8	5.0L		--	602205 ③
1980	8	5.0L	Main & Pre-Cat	--	602005 ③
77-79	8	5.0L	18" Conv.	--	602205 ③
77-79	8	5.0L	(Exc. 18" Conv.)	--	602205 ③

① Discontinued, use until inventory is depleted.

☆ Air Tube kit 4948 may be required for installation.

③ Federal & California Emissions. Not For Sale or Use on vehicles licensed in the state of CA & NY (NY vehicles with CA Emissions). Check with your state authority for details.

⑤ California Emissions. Not For Sale or Use on vehicles licensed in the state of CA & NY. Check with your state authority.

APPLICATION LISTINGS

FEDERAL CONVERTERS



YR/YRS	CYL	LITER	DESCRIPTION	DIRECT FIT	UNIVERSAL
LINCOLN ZEPHYR					
2006	6	3.0L	Rear Manifold Conv.	641242 ③	--
2006	6	3.0L	Manifold Unit, Front Left	641329 ③	--
			Manifold Unit, Front Left	641241 ③④	--
2006	6	3.0L	Rear Main Conv.	642216 ③	608205 ③
LOTUS ELAN					
1991	4	All	Elan	--	602204 ③
LOTUS ESPRIT					
90-94	4	2.2L	Esprit	--	602204 ③
79-89	4	All	Esprit	--	602203 ③
MASERATI BITURBO					
85-87	6	2.5L		--	604006 ③
MASERATI BORA					
80-82	8	4.9L		--	604006 ③
MASERATI QUATTROPORTE					
80-82	8	4.9L		--	604006 ③
MAZDA 3					
10-12	4	2.0L	Rear Conv., For use with Aftermarket Pipe 58553	642038 ③	608294 ③
07-09	4	2.0L	Manifold Conv., Federal Emissions	642114 ④	--
07-09	4	2.0L	Rear Conv., For use with Aftermarket Pipe	642081 ④	608225 ③
07-09	4	2.0L	Rear Conv., For use with OE pipe, additional sizing, bushings, cutting may be required due to OE exhaust design.	642157 ⁹⁰⁰ ④	608225 ③
				--	--
04-06	4	2.0L	California Emissions, Manifold Unit, Front	641406 ⑤	--
04-06	4	2.0L	Federal Emissions, Manifold Unit, Front	641410 ④	--
2009	4	2.3L	Sedan, Exc. Turbo, Rear Conv., For use with Aftermarket Pipe	642081 ④	608225 ③
07-09	4	2.3L	Rear Conv., For use with OE pipe, additional sizing, bushings, cutting may be required due to OE exhaust design.	642157 ⁹⁰⁰ ④	608225 ③
				--	--
06-09	4	2.3L	Federal Emissions, Manifold Unit, Front	641405 ④	--
07-08	4	2.3L	Exc. Turbo, Rear Conv., For use with Aftermarket Pipe	642081 ④	608225 ③
MAZDA 3 SPORT					
2012	4	2.5L	Rear Conv., For use with Aftermarket Pipe 58553	642038 ③	608294 ③
MAZDA 323					
90-94	4	1.6L		--	602204 ③
88-89	4	1.6L	Turbo	642409 ③	602205 ③
86-89	4	1.6L	(Exc. Turbo), Reversible/Non-Directional Unit	--	602204 ③
MAZDA 5					
08-10	4	2.3L	Manifold Unit, Front	641405 ③	--
MAZDA 6					
2008	4	2.3L	Federal Emissions	642242 ④	608326 ④○
06-07	4	2.3L	Naturally Aspirated, Manual Trans., Calif. Emissions	642242 ⑤	608326 ⑤○
06-07	4	2.3L	Naturally Aspirated, Federal Emissions	642242 ④	608326 ④○
05-06	4	2.3L	Naturally Aspirated, California Emissions, Manifold Unit, Front	641408 ⑤	--
03-05	4	2.3L	Federal Emissions	642242 ④	608326 ④○
09-13	4	2.5L	Rear	642802 ③	--
06-08	6	3.0L	Manifold Unit, Front	641270 ③	--
06-08	6	3.0L	Rear Manifold Conv.	641267 ③	--
06-08	6	3.0L	Rear Main Conv.	642128 ③	--
03-05	6	3.0L	Manifold Unit, Front	641228 ③	--

③ Discontinued, use until inventory is depleted.
⁹⁰⁰ Direct fit converter may require resizing, cutting or bushing.
 ③ Federal & California Emissions. Not For Sale or Use on vehicles licensed in the state of CA & NY (NY vehicles with CA Emissions). Check with your state authority for details.
 ④ Federal Emissions. Not For Sale or Use on vehicles licensed in the state of CA. Check with your state authority.
 ⑤ California Emissions. Not For Sale or Use on vehicles licensed in the state of CA & NY. Check with your state authority.
 ○ EPA Enhanced OBDII By Design Unit



APPLICATION LISTINGS FEDERAL CONVERTERS

YR/YRS	CYL	LITER	DESCRIPTION	DIRECT FIT	UNIVERSAL
MAZDA 6 (Cont.)					
03-05	6	3.0L	Rear Manifold Conv.	641229 ③	--
03-05	6	3.0L	Front Main Conv.	642254 ③	608284 ③
03-05	6	3.0L	Rear Main Conv.	642253 ③	608264 ③
09-13	6	3.7L	Front Right	641393 ③	--
MAZDA 626					
00-02	4	2.0L	Front, California Emissions	641175 ⑤	--
00-02	4	2.0L	Rear, California Emissions	642794 ⑤	608204 ⑤
98-02	4	2.0L	Rear, Federal Emissions	642299 ④	608205 ④
98-99	4	2.0L	Front, California Emissions, Includes Head Pipe	641179 ⑤	--
98-99	4	2.0L	Rear, California Emissions	642794 ⑤	608204 ⑤
96-97	4	2.0L	Front, Includes Head Pipe	642659 ③	--
96-97	4	2.0L		642485 ③	608234 ③
93-95	4	2.0L		642409 ③	602205 ③
86-87	4	2.0L	Rear, Turbo, w/Female Flare Inlet, Reversible/Non-Directional Unit	--	602204 ③
83-87	4	2.0L	Rear, (Exc. Turbo), w/Female Flare Inlet, Reversible/Non-Directional Unit	--	602204 ③
80-81	4	2.0L		642403 ③	602204 ③
90-92	4	2.2L	(Exc. Turbo), Reversible/Non-Directional Unit	642485 ③	602204 ③
88-91	4	2.2L	Rear, Turbo	--	602205 ③
88-89	4	2.2L	Manual Trans., (Exc. Turbo)	--	602204 ③
88-89	4	2.2L	Auto Trans., (Exc. Turbo, Reversible/Non-Directional Unit)	642485 ③	602204 ③
01-02	6	2.5L	Rear Manifold, w/ Auto. Trans.	641283 ③	--
98-02	6	2.5L	Rear, Federal Emissions	642299 ④	608205 ④
96-97	6	2.5L		--	608234 ③
93-95	6	2.5L		642448 ③	602204 ③
MAZDA 929					
92-95	6	3.0L	Front Right	641125 ③	--
92-95	6	3.0L	Front Left	641126 ③	--
92-95	6	3.0L		--	602205 ③
90-91	6	3.0L	DOHC, Left	642403 ③	602204 ③
90-91	6	3.0L	DOHC, Right	642403 ③	602204 ③
88-91	6	3.0L	SOHC	642409 ③	602205 ③
MAZDA B-Series PICKUP					
86-87	4	2.0L	Rear	642403 ③	602204 ③
86-87	4	2.0L	Main & Pre-Cat	--	602004 ③
79-84	4	2.0L		642403 ③	602204 ③
90-93	4	2.2L	Rear, w/o Air Tube	642403 ③	602204 ③
90-93	4	2.2L	Rear, w/ Air Tube	--	602004 ③
87-89	4	2.2L		642403 ③	602204 ③
87-89	4	2.2L	Main & Pre-Cat	--	602004 ③
07-09	4	2.3L		645833 ③	--
01-06	4	2.3L	DF Conv., Front & Rear	645871 ③	--
01-06	4	2.3L	Front Universal	--	608285 ③○
01-06	4	2.3L	Rear Universal	--	608205 ③
96-97	4	2.3L		642531 ③	608235 ③
1995	4	2.3L		642531 ③	608235 ③
1994	4	2.3L		642472 ③	602205 ③

③ Federal & California Emissions. Not For Sale or Use on vehicles licensed in the state of CA & NY (NY vehicles with CA Emissions). Check with your state authority for details.

④ Federal Emissions. Not For Sale or Use on vehicles licensed in the state of CA. Check with your state authority.

⑤ California Emissions. Not For Sale or Use on vehicles licensed in the state of CA & NY. Check with your state authority.

○ EPA Enhanced OBDII By Design Unit

APPLICATION LISTINGS

FEDERAL CONVERTERS



YR/YRS	CYL	LITER	DESCRIPTION	DIRECT FIT	UNIVERSAL
MAZDA B-Series PICKUP (Cont.)					
98-01	4	2.5L		645897 ③	608226 ③
90-93	4	2.6L		--	609004 ③
87-89	4	2.6L	4WD, Middle	--	602205 ③
87-89	4	2.6L	4WD, Rear	642403 ③	602204 ③
87-89	4	2.6L	Main & Pre-Cat	--	602004 ③
77-78	4	All		--	602204 ③
04-06	6	3.0L	Front Conv.	641224 ③	--
04-06	6	3.0L	Rear Conv.	645442 ③	--
01-03	6	3.0L	Rear Conv.	645418 ③	--
98-00	6	3.0L	With 2 Converters, California Emissions, Front	642016 ⑤	--
98-99	6	3.0L	Front	--	608226 ③
98-99	6	3.0L		--	608226 ③
98-99	6	3.0L	Complete Assembly	645365 ③	--
96-97	6	3.0L	Front	--	608226 ③
96-97	6	3.0L		--	608226 ③
96-97	6	3.0L	Complete Assembly	642541 ③	--
94-95	6	3.0L	Front	--	609005 ③
94-95	6	3.0L		--	609005 ③
94-95	6	3.0L	Complete Assembly, OEM Y-Pipe must be trimmed 1/2" from face of flange for proper insertion into converter.	645339 ③	--
				--	--
04-06	6	4.0L	Rear	645442 ③	--
01-03	6	4.0L	Front	641178 ③	--
01-03	6	4.0L		645418 ③	--
98-99	6	4.0L	Front	--	608226 ③
98-99	6	4.0L		--	608226 ③
98-99	6	4.0L	Complete Assembly	645365 ③	--
96-97	6	4.0L	Front	--	608226 ③
96-97	6	4.0L		--	608226 ③
96-97	6	4.0L	Complete Assembly	642541 ③	--
94-95	6	4.0L	Front	--	609005 ③
94-95	6	4.0L		--	609005 ③
94-95	6	4.0L	Complete Assembly, OEM Y-Pipe must be trimmed 1/2" from face of flange for proper insertion into converter.	645339 ③	--
				--	--
MAZDA CX-7					
07-09	4	2.3L	Front, Federal Emissions, Up To 01/01/09	642160 ④	--
07-09	4	2.3L	Rear, Federal Emissions, Includes Resonator	643048 ④	--
11-12	4	2.5L	Touring, Front	642814 ③	--
10-12	4	2.5L	Sport & SV, Front	642814 ③	--
MAZDA CX-9					
2007	6	3.5L	Front Right	641393 ③	--
08-15	6	3.7L	Front Right	641393 ③	--
MAZDA GLC					
77-78	4	1.3L	14" Conv.	--	602203 ③
77-78	4	1.3L	(Exc. 14" Conv.)	--	602204 ③
79-80	4	1.4L	14" Conv.	--	602203 ③
79-80	4	1.4L	(Exc. 14" Conv.)	--	602204 ③
83-85	4	1.5L	Sedan or Hatchback, Rear	--	602204 ③

③ Federal & California Emissions. Not For Sale or Use on vehicles licensed in the state of CA & NY (NY vehicles with CA Emissions). Check with your state authority for details.

④ Federal Emissions. Not For Sale or Use on vehicles licensed in the state of CA. Check with your state authority.

⑤ California Emissions. Not For Sale or Use on vehicles licensed in the state of CA & NY. Check with your state authority.



APPLICATION LISTINGS FEDERAL CONVERTERS

YR/YRS	CYL	LITER	DESCRIPTION	DIRECT FIT	UNIVERSAL
MAZDA GLC (Cont.)					
1983	4	1.5L	Station Wagon, Rear	--	602294③
81-82	4	1.5L	Rear	--	602294③
MAZDA MIATA, MX5					
90-93	4	1.6L		642443 ③	602204③
99-02	4	1.8L		642953 ③	608215③
99-00	4	1.8L	Front, California Emissions	641316 ⑤	--
96-99	4	1.8L		--	608205③
1994	4	1.8L		--	602004③
2008	4	2.0L	Front, Manual Trans.	641291 ③	--
06-07	4	2.0L	Front Conv.	641291 ③	--
2006	4	2.0L	Rear Conv.	643059 ③	--
MAZDA MILLENIA					
96-02	6	2.3L	Rear Main Conv.	642661 ③	608224③
95-02	6	2.3L	Manifold Unit, Front	641145 ③	--
95-02	6	2.3L	Rear Manifold Conv.	641144 ③	--
1995	6	2.3L		--	608204③
97-02	6	2.5L		--	608264③○
97-01	6	2.5L	Manifold Unit, Front	641217 ③	--
97-01	6	2.5L	Rear Manifold Conv.	641218 ③	--
1996	6	2.5L		645440 ③	608264③
1995	6	2.5L		--	608204③
MAZDA MPV VAN					
89-94	4	2.6L		642403 ③	602204③
00-01	6	2.5L	Manifold Unit, Front	641159 ③	--
00-01	6	2.5L	Rear Manifold Conv.	641152 ③	--
00-01	6	2.5L	Rear	642187 ③	--
02-06	6	3.0L	Manifold Unit, Front	641205 ③	--
02-06	6	3.0L	Rear Manifold Conv.	641206 ③	--
02-06	6	3.0L	Right Rear Main Conv.	642266 ③	--
02-06	6	3.0L	Left Rear Main Conv.	642265 ③	608265③○
96-98	6	3.0L	Front	--	608214③
96-98	6	3.0L		--	608204③
96-97	6	3.0L	2WD, Front	642681 ③	--
94-95	6	3.0L	Front	--	602214③
94-95	6	3.0L		--	602204③
89-93	6	3.0L		642403 ③	602204③
MAZDA MX3					
1995	4	1.6L	Rear Main Conv.	--	602204③
92-94	4	1.6L		--	602204③
92-93	6	All		--	602004③
MAZDA MX6					
96-97	4	2.0L	Front, Includes Head Pipe	642659 ③	--
96-97	4	2.0L		642485 ③	608234③
93-95	4	2.0L		642409 ③	602204③
89-92	4	2.2L	Manual Trans., (Exc. Turbo)	--	602204③
88-92	4	2.2L	Auto Trans., (Exc. Turbo, Reversible/Non-Directional Unit)	642485 ③	602204③
96-97	6	2.5L	Main Conv.	--	608234③

③ Federal & California Emissions. Not For Sale or Use on vehicles licensed in the state of CA & NY (NY vehicles with CA Emissions). Check with your state authority for details.

⑤ California Emissions. Not For Sale or Use on vehicles licensed in the state of CA & NY. Check with your state authority.

○ EPA Enhanced OBDII By Design Unit

APPLICATION LISTINGS

FEDERAL CONVERTERS



YR/YRS	CYL	LITER	DESCRIPTION	DIRECT FIT	UNIVERSAL
MAZDA MX6 (Cont.)					
93-95	6	2.5L		642448 ③	602205 ③
MAZDA NAVAJO					
91-94	6	4.0L	Front	--	609005 ③
91-94	6	4.0L		--	609005 ③
91-94	6	4.0L	Complete Assembly, OEM Y-Pipe must be trimmed 1/2" from face of flange for proper insertion into converter.	645339 ③	--
MAZDA PROTÉGÉ					
97-98	4	1.5L		642556 ③	608214 ③
95-98	4	1.5L	Front, Includes Pipe Between Converters	641124 ③	--
95-96	4	1.5L		--	608214 ③
99-01	4	1.6L	Front	641156 ③	--
99-00	4	1.8L	Front	641156 ③	--
99-00	4	1.8L	California Emissions, Rear	642853 ⑤	--
95-97	4	1.8L		--	608204 ③
90-94	4	1.8L		642444 ③	602204 ③
90-92	4	1.8L	4WD	--	602204 ③
01-03	4	2.0L	Front	641156 ③	--
01-03	4	2.0L	Rear	642240 ③	608214 ③
MAZDA RX-7					
84-85	Rotary	1.1L		--	602004 ③
84-85	Rotary	1.1L	Main & Pre-Cat	--	602004 ③
81-83	Rotary	1.1L		--	602004 ③
81-83	Rotary	1.1L	Main & Pre-Cat	--	602004 ③
1980	Rotary	1.1L		--	602004 ③
86-91	Rotary	1.3L	Front, (Exc. Turbo)	--	602294 ③
86-91	Rotary	1.3L	Intermediate Conv., (Exc. Turbo)	--	602205 ③
86-91	Rotary	1.3L	Rear, (Exc. Turbo)	--	602005 ③
86-90	Rotary	1.3L	Rear, Turbo	--	602005 ③
86-90	Rotary	1.3L	Turbo, Main & Pre-Cat	--	602005 ③
84-85	Rotary	1.3L		--	602004 ③
84-85	Rotary	1.3L	Main & Pre-Cat	--	602004 ③
MAZDA RX-8					
04-08	R2	1.3L	Manual Trans.	642083 ③	--
04-06	R2	1.3L	To 2/14/06, Auto Trans.	642083 ③	--
MAZDA TRIBUTE					
2008	4	2.3L	Rear Main	645293 ③	--
2008	4	2.3L	Front Manifold Conv., i Submodel, Exc. Hybrid	641264 ③	--
2006	4	2.3L	Front Manifold Conv., From 10/03/05	641264 ③	--
05-06	4	2.3L	Rear Main	645293 ③	--
09-11	4	2.5L	i, GX; Exc. Hybrid; Requires Welded Assembly 60005 to Complete Assembly	645273 ③	--
09-11	6	3.0L	Manifold Unit, Front Left	641391 ③	--
09-11	6	3.0L	Manifold Unit, Front Right	641392 ③	--
2008	6	3.0L	Manifold Unit, Front Left	641386 ③	--
05-06	6	3.0L	Rear Main	645293 ③	--
01-06	6	3.0L	Manifold Unit, Front	641170 ③	--
01-06	6	3.0L	Rear Manifold Conv.	641169 ③	--

③ Federal & California Emissions. Not For Sale or Use on vehicles licensed in the state of CA & NY (NY vehicles with CA Emissions). Check with your state authority for details.
 ⑤ California Emissions. Not For Sale or Use on vehicles licensed in the state of CA & NY. Check with your state authority.



APPLICATION LISTINGS FEDERAL CONVERTERS

YR/YRS	CYL	LITER	DESCRIPTION	DIRECT FIT	UNIVERSAL
MAZDA TRIBUTE (Cont.)					
01-04	6	3.0L	Rear Main	645409 ③	608204 ③
MERCEDES-BENZ 190					
91-93	4	2.3L		--	609005 ③
86-88	4	2.3L	(Exc. 16 valve)	--	609004 ③
86-87	4	2.3L	16 valve	--	609004 ③
84-85	4	2.3L	Single Flange Inlet	--	609004 ③
84-85	4	2.3L	Dual Inlets	--	609004 ③
87-90	6	2.6L		--	609220 ③
MERCEDES-BENZ 260					
87-89	6	2.6L	260E	645965 ③	609220 ③
MERCEDES-BENZ 280					
78-79	6	2.8L	280CE, to Chassis # 016970	--	604051 ③
77-79	6	2.8L	280E, to Chassis # 063890	--	604051 ③
77-78	6	2.8L	280SE, to Chassis # 150379	--	604051 ③
MERCEDES-BENZ 300					
90-93	6	3.0L	300SL	--	609220 ③
88-93	6	3.0L	300TE	645965 ③	609220 ③
90-92	6	3.0L	300CE	--	609231 ③
88-91	6	3.0L	300SE / SEL	--	609231 ③
88-89	6	3.0L	300CE	645965 ③	609220 ③
86-89	6	3.0L	300E	645965 ③	609220 ③
MERCEDES-BENZ 380					
84-85	8	3.8L	SE, Single Cat System	--	605004 ③
81-85	8	3.8L	SL	--	609220 ③
81-83	8	3.8L	SEC / SEL, Single Cat System	--	605004 ③
1981	8	3.8L	SLC	--	609220 ③
MERCEDES-BENZ 400					
1993	8	4.2L	400SEL Models w/140 Chassis	645876 ③	--
1992	8	4.2L	400SE Models w/140 Chassis	645876 ③	--
MERCEDES-BENZ 420					
86-91	8	4.2L	420SEL	--	609220 ③
MERCEDES-BENZ 450					
77-80	8	4.5L	SEL, Left	--	605004 ③
77-80	8	4.5L	SEL, Right	--	605004 ③
77-79	8	4.5L	SL	--	604051 ③
MERCEDES-BENZ 500					
92-93	8	5.0L	500SEL & 500SEC w/140 Chassis	645876 ③	--
84-85	8	5.0L	500 Sedan / Coupe, SEL / SEC	--	605004 ③
MERCEDES-BENZ C220					
94-96	4	2.2L	111.944 Eng., Single Inlet Pipe	645839 ③	--
MERCEDES-BENZ C230					
1997	4	2.3L	111.944 Eng., Single Inlet Pipe	645839 ③	--
MERCEDES-BENZ C280					
94-97	6	2.8L		645838 ③	--
MERCEDES-BENZ C240					
03-04	6	2.6L	Base, Right	643049 ③	--
03-04	6	2.6L	Base, Left	643050 ③	--

③ Federal & California Emissions. Not For Sale or Use on vehicles licensed in the state of CA & NY (NY vehicles with CA Emissions). Check with your state authority for details.

APPLICATION LISTINGS

FEDERAL CONVERTERS



YR/YRS	CYL	LITER	DESCRIPTION	DIRECT FIT	UNIVERSAL
MERCEDES-BENZ C320					
03-04	6	3.2L	Base, Right	643049 ③	--
03-04	6	3.2L	Base, Left	643050 ③	--
MERCEDES-BENZ CL500					
00-03	8	5.0L	Right	642995 ③	--
00-03	8	5.0L	Left	642996 ③	--
MERCEDES-BENZ CLK320					
2003	6	3.2L	Convertible, Right	643124 ③	--
2003	6	3.2L	Convertible, Left	642885 ③	--
98-02	6	3.2L	Right	643124 ③	--
98-02	6	3.2L	Left	642885 ③	--
1998	6	3.2L	Right	643124 ③	--
1998	6	3.2L	Left	642885 ③	--
MERCEDES-BENZ CLK430					
2003	8	4.3L	Convertible, Single Outlet, Right	643124 ③	--
2003	8	4.3L	Convertible, Left	642885 ③	--
99-02	8	4.3L	Single Outlet, Right	643124 ③	--
99-02	8	4.3L	Left	642885 ③	--
MERCEDES-BENZ CLK55 AMG					
01-02	8	5.5L	Single Outlet, Right	643124 ③	--
01-02	8	5.5L	Single Outlet, Left	642885 ③	--
MERCEDES-BENZ E320					
04-05	6	3.2L	Base, RWD, Right	643116 ③	--
04-05	6	3.2L	Base, Left	643115 ③	--
04-05	6	3.2L	4Matic, Left	643107 ③	--
04-05	6	3.2L	4Matic, Right	643109 ③	--
2003	6	3.2L	4Matic Wagon, Left	643083 ③	--
2003	6	3.2L	4Matic Wagon, Right	643084 ③	--
2003	6	3.2L	Sedan, Right	643116 ③	--
2003	6	3.2L	Sedan, Left	643115 ③	--
98-02	6	3.2L	DF Right Side, (Exc. 4-Matic)	642998 ③	--
98-02	6	3.2L	Left	643083 ③	--
98-02	6	3.2L	Left	642999 ③①	--
98-02	6	3.2L	4Matic, Right	643084 ③	--
MERCEDES-BENZ E420					
1997	8	4.2L	Left Side Conv.	643046 ③	--
1997	8	4.2L	Right Side Conv.	643045 ③	--
MERCEDES-BENZ E430					
00-02	8	4.3L	Base & 4Matic, Left	642017 ③	--
00-02	8	4.3L	Base & 4Matic, Right	642020 ③	--
98-99	8	4.3L	Base, Left	642017 ③	--
98-99	8	4.3L	Base, Right	642020 ③	--
MERCEDES-BENZ GL450					
07-12	8	4.6L	Left	645787 ③	--
07-12	8	4.6L	Right	645788 ③	--
MERCEDES-BENZ GL550					
08-12	8	5.5L	Left	645787 ③	--
08-12	8	5.5L	Right	645788 ③	--

① Discontinued, use until inventory is depleted.

③ Federal & California Emissions. Not For Sale or Use on vehicles licensed in the state of CA & NY (NY vehicles with CA Emissions). Check with your state authority for details.



APPLICATION LISTINGS FEDERAL CONVERTERS

YR/YRS	CYL	LITER	DESCRIPTION	DIRECT FIT	UNIVERSAL
MERCEDES-BENZ ML320					
98-02	6	3.2L	SOHC & 163 Chassis, Right	642973 ③	--
98-02	6	3.2L	SOHC & 163 Chassis, Left	642974 ③	--
MERCEDES-BENZ ML350					
06-11	6	3.5L	Right	644001 ③	--
06-11	6	3.5L	Left	644000 ③	--
03-05	6	3.7L	Left	645263 ③	--
03-05	6	3.7L	Right	645264 ③	--
MERCEDES-BENZ ML430					
99-01	8	4.3L	Right Side	642204 ③	--
99-01	8	4.3L	Left Side	642203 ③	--
MERCEDES-BENZ ML550					
08-11	8	5.5L	Left	645787 ③	--
08-11	8	5.5L	Right	645788 ③	--
MERCEDES-BENZ R350					
06-12	6	3.5L	Right	643133 ③	--
MERCEDES-BENZ S420					
94-95	8	4.2L	w/140 Chassis	645876 ③	609220③
MERCEDES-BENZ S430					
03-06	8	4.3L	S430, 4Matic, Right	642839 ③	--
03-06	8	4.3L	S430, 4Matic, Left	642838 ③	--
00-02	8	4.3L	S430, Right	642995 ③	--
00-02	8	4.3L	S430, Left	642996 ③	--
MERCEDES-BENZ S500					
03-06	8	5.0L	4Matic, Left	642838 ③	--
03-06	8	5.0L	4Matic, Right	642839 ③	--
00-02	8	5.0L	Left	642996 ③	--
00-02	8	5.0L	Right	642995 ③	--
94-95	8	5.0L	w/140 Chassis	645876 ③	609220③
MERCEDES-BENZ SLK320					
01-04	6	3.2L	Right	642255 ③	608405③○
01-04	6	3.2L	Left	643016 ③	608405③○
MERCURY BOBCAT					
75-80	4	All	14" Conv.	--	602205③
75-80	4	All	19" Conv.	--	602205③
75-79	4	All	(Exc. 14" & 19" Conv.)	--	602204③
77-79	6	2.8L	14" Conv.	--	602205③
77-79	6	2.8L	19" Conv.	--	602205③
75-76	6	2.8L	Left	--	602214③
75-76	6	2.8L	Right	--	602214③
MERCURY CAPRI					
91-94	4	1.6L	13-3/4" Conv.	--	602294③
1991	4	1.6L	13-1/4" Conv.	642477 ③	602294③
84-86	4	2.3L	(Exc. Turbo)	--	602004③
1984	4	2.3L	Turbo	--	602205③
1983	4	2.3L	(Exc. Turbo)	--	602205③
1983	4	2.3L	California Emissions	--	602004⑤
1983	4	2.3L	Turbo	--	602205③
79-82	4	2.3L	w/o Air Tube	--	602205③

③ Federal & California Emissions. Not For Sale or Use on vehicles licensed in the state of CA & NY (NY vehicles with CA Emissions). Check with your state authority for details.

⑤ California Emissions. Not For Sale or Use on vehicles licensed in the state of CA & NY. Check with your state authority.

○ EPA Enhanced OBDII By Design Unit

APPLICATION LISTINGS

FEDERAL CONVERTERS



YR/YRS	CYL	LITER	DESCRIPTION	DIRECT FIT	UNIVERSAL
MERCURY CAPRI (Cont.)					
79-82	4	2.3L	w/Air Tube	--	602005③
76-77	6	2.8L	Dual Convs., Left	--	602214③
76-77	6	2.8L	Dual Convs., Right	--	602214③
1976	6	2.8L	(Exc. Dual Convs.)	--	602205③
84-86	6	3.8L	Underbody	--	602005③
84-86	6	3.8L	Main & Pre-Cat	--	602005③
1983	6	3.8L		--	602005③
1983	6	3.8L	Main & Pre-Cat	--	602004③
79-82	6	All	Rear	--	602204③
79-82	6	All	Main & Pre-Cat	--	602004③
1982	8	4.2L	Rear	--	602005③
1982	8	4.2L	Main & Pre-Cat	--	602004③
1981	8	4.2L	Rear	--	602005③
1981	8	4.2L	Main & Pre-Cat	--	602005③
1986	8	5.0L	Rear Left	--	602005③
1986	8	5.0L	Complete	642903 ③	--
1986	8	5.0L	Front Right	--	602005③
1986	8	5.0L	Front Left	--	602005③
1986	8	5.0L	Rear Right	--	602005③
84-85	8	5.0L	Rear, Manual Trans.	--	602006③
84-85	8	5.0L	Manual Trans., Main & Pre-Cat	--	602006③
84-85	8	5.0L	Auto Trans., Rear	--	602006③
84-85	8	5.0L	Auto Trans., Main & Pre-Cat	--	602006③
1983	8	5.0L	Auto Trans., Rear	--	602006③
1983	8	5.0L	Auto Trans., Main & Pre-Cat	--	602006③
1982	8	5.0L	25" Conv., Rear	--	602005③
1982	8	5.0L	25" Conv., Main & Pre-Cat	--	602004③
79-80	8	All	Rear	--	602204③
79-80	8	All	Main & Pre-Cat	--	602004③
MERCURY COMET					
75-76	6	All		--	602204③
75-76	8	All		--	602205③
1977	6,8	All	14-1/4" Conv.	--	602205③
1977	6,8	All	(Exc. 14-1/4" Conv.)	--	602205③
MERCURY COUGAR					
99-02	4	2.0L		642677 ③	--
84-86	4	2.3L	XR7 Models w/Turbo	--	602206③
99-00	6	2.5L	Rear Side Manifold Conv.	641129 ③	--
99-00	6	2.5L	Front Side Manifold Conv.	641127 ③	--
99-00	6	2.5L	Main Conv., Auto Trans, w/O2 Sensor	642683 ③	608204③
99-00	6	2.5L	Main Conv., Manual Trans.	642538 ③	608205③
80-82	6	3.3L	Rear	--	602204③
80-82	6	3.3L	Main & Pre-Cat	--	602004③
96-97	6	3.8L	Front Left	--	608274③
96-97	6	3.8L	Rear	--	608235③
96-97	6	3.8L	Complete	642922 ③	--
96-97	6	3.8L	Front Right	--	608274③

③ Federal & California Emissions. Not For Sale or Use on vehicles licensed in the state of CA & NY (NY vehicles with CA Emissions). Check with your state authority for details.



APPLICATION LISTINGS FEDERAL CONVERTERS

YR/YRS	CYL	LITER	DESCRIPTION	DIRECT FIT	UNIVERSAL
MERCURY COUGAR (Cont.)					
92-95	6	3.8L	w/O2 Sensor Ports, Front Left	--	602294 ^③
92-95	6	3.8L	Complete, w/O2 Sensor Ports	642950 ^③	--
92-95	6	3.8L	w/O2 Sensor Ports, Front Right	--	602294 ^③
91-95	6	3.8L	Exc. Conv. w/O2 Sensor Ports, Front Left	--	602294 ^③
91-95	6	3.8L	Exc. Conv. w/O2 Sensor Ports, Front Right	--	602294 ^③
89-90	6	3.8L	Left, (Exc. XR-7)	--	602204 ^③
89-90	6	3.8L	Right, (Exc. XR-7)	--	602204 ^③
84-88	6	3.8L	Rear	--	602005 ^③
84-88	6	3.8L	Main & Pre-Cat	--	602005 ^③
82-83	6	3.8L	Rear	--	602005 ^③
82-83	6	3.8L	Main & Pre-Cat	--	602004 ^③
96-97	8	4.6L	Front Left	--	608274 ^③ ○
96-97	8	4.6L		--	608240 ^③
96-97	8	4.6L	Complete	642961 ^③	--
96-97	8	4.6L	Front Right	--	608274 ^③ ○
94-95	8	4.6L	w/Post Conv. O2 Sensor, Front Left	--	608204 ^③
94-95	8	4.6L	Rear, w/Post Conv. O2 Sensor Port	--	608240 ^③
94-95	8	4.6L	Complete, w/Post Conv. O2 Sensor Port	642915 ^③	--
94-95	8	4.6L	w/o Post Conv. O2 Sensor Port, Front Left	--	602204 ^③
94-95	8	4.6L	Rear, w/out Post Conv. O2 Sensor Port	--	609244 ^③
94-95	8	4.6L	w/Post Conv. O2 Sensor, Front Right	--	608204 ^③
94-95	8	4.6L	w/o Post Conv. O2 Sensor Port, Front Right	--	602204 ^③
91-93	8	5.0L	Left	--	602204 ^③
91-93	8	5.0L	Right	--	602204 ^③
91-93	8	5.0L		--	609244 ^③
91-93	8	5.0L	Complete System	642958 ^③	--
86-88	8	5.0L	Rear, w/3 Conv. System	--	602005 ^③
86-88	8	5.0L	Main & Pre-Cat, w/3 Conv. System	--	602005 ^③
83-85	8	5.0L	Left	--	602005 ^③
83-85	8	5.0L	Right	--	602005 ^③
77-78	8	6.6L	Left	--	605004 ^③
77-78	8	6.6L	Right	--	605004 ^③
75-76	8	7.5L	Left	--	605004 ^③
75-76	8	7.5L	Right	--	605004 ^③
80-82	8	All		--	602005 ^③
80-82	8	All	Main & Pre-Cat	--	602005 ^③
77-79	8	All	Exc. 400 C.I.D., Left	--	602214 ^③
77-79	8	All	Exc. 400 C.I.D., Right	--	602214 ^③
MERCURY GRAND MARQUIS FULL SIZE					
03-11	8	4.6L	Rear Left	--	608284 ^③
03-11	8	4.6L	Front Left	--	608274 ^③
03-11	8	4.6L	Right	642161 ^③	--
03-11	8	4.6L	Left	642179 ^③	--
03-11	8	4.6L	Rear Right	--	608284 ^③
03-11	8	4.6L	Front Right	--	608274 ^③
03-06	8	4.6L	Left	642734 ^③ ○	--
03-06	8	4.6L	Right	642733 ^③ ○	--

○ Discontinued, use until inventory is depleted.

③ Federal & California Emissions. Not For Sale or Use on vehicles licensed in the state of CA & NY (NY vehicles with CA Emissions). Check with your state authority for details.

○ EPA Enhanced OBDII By Design Unit

APPLICATION LISTINGS

FEDERAL CONVERTERS



YR/YRS	CYL	LITER	DESCRIPTION	DIRECT FIT	UNIVERSAL
MERCURY GRAND MARQUIS FULL SIZE (Cont.)					
96-02	8	4.6L	Left	642549 ③	--
96-02	8	4.6L	Right	642550 ③	--
96-02	8	4.6L	Front Left	--	608294 ③
96-02	8	4.6L	Rear Left	--	608204 ③
96-02	8	4.6L	Front Right	--	608294 ③
96-02	8	4.6L	Rear Right	--	608204 ③
1995	8	4.6L	Left	642462 ③	608204 ③
1995	8	4.6L	Right	642463 ③	608204 ③
92-94	8	4.6L	Left	642437 ③	602204 ③
92-94	8	4.6L	Right	642436 ③	602204 ③
90-91	8	5.0L	Left, Main & Pre-Cat	642391 ☆③	602004 ③
90-91	8	5.0L	Right Side, Main & Pre-Cat	642390 ☆③	602004 ③
1989	8	5.0L	Left, Main & Pre-Cat	642391 ☆③	602004 ③
1989	8	5.0L	Right Side, Main & Pre-Cat	642390 ☆③	602004 ③
86-88	8	5.0L	Left, Main & Pre-Cat	642391 ☆③	602004 ③
86-88	8	5.0L	Right Side, Main & Pre-Cat	642390 ☆③	602004 ③
83-85	8	5.0L	Left	--	602004 ③
83-85	8	5.0L	Right	--	602004 ③
MERCURY LN7					
1983	4	1.6L		--	602004 ③
1982	4	1.6L		--	602004 ③
MERCURY LYNX					
83-85	4	1.6L		--	602004 ③
81-82	4	1.6L		--	602004 ③
1987	4	1.9L	C.F.I.	--	602294 ③
86-87	4	1.9L	E.F.I.	642362 ☆③	--
85-86	4	1.9L	2 bbl. Carb.	--	602004 ③
MERCURY MARAUDER					
03-04	8	4.6L	Right	642161 ③	--
03-04	8	4.6L	Right, Single Exhaust, Built From 6/3/02	642733 ③①	--
03-04	8	4.6L	Left	642179 ③	--
03-04	8	4.6L	Left, Single Exhaust, Built From 6/3/02	642734 ③①	--
03-04	8	4.6L	Front Left	--	608275 ③①
03-04	8	4.6L	Front Right	--	608275 ③①
03-04	8	4.6L	Rear Left	--	608405 ③①
03-04	8	4.6L	Rear Right	--	608405 ③①
MERCURY MARINER					
06-08	4	2.3L	Front Manifold Conv., From 10/03/05, Convenience & Base Submodels, Exc. Hybrid	641264 ③	--
05-08	4	2.3L	Rear Main	645293 ③	--
10-11	4	2.5L	Base, Premier; Exc. Hybrid; Requires Welded Assembly 60005 to Complete Assembly	645273 ③	--
10-11	6	3.0L	Manifold Unit, Front Right	641392 ③	--
09-11	6	3.0L	Rear	645197 ③	--
2008	6	3.0L	Manifold Unit, Front Left	641386 ③	--
05-06	6	3.0L	Manifold Unit, Front	641170 ③	--
05-06	6	3.0L	Rear Manifold Conv.	641169 ③	--

① Discontinued, use until inventory is depleted.

☆ Air Tube kit 4948 may be required for installation.

③ Federal & California Emissions. Not For Sale or Use on vehicles licensed in the state of CA & NY (NY vehicles with CA Emissions). Check with your state authority for details.

○ EPA Enhanced OBDII By Design Unit



APPLICATION LISTINGS FEDERAL CONVERTERS

YR/YRS	CYL	LITER	DESCRIPTION	DIRECT FIT	UNIVERSAL
MERCURY MARINER (Cont.)					
05-06	6	3.0L	Rear Main	645293 ③	--
MERCURY MARQUIS					
81-82	8	4.2L	Right	--	602004 ③
81-82	8	4.2L	Left	--	602004 ③
81-82	8	5.8L	Right	--	609004 ③
81-82	8	5.8L	Left	--	609004 ③
1978	8	5.8L	Right	--	602214 ③
1978	8	5.8L	Left	--	602214 ③
75-78	8	6.6L	Right	--	605004 ③
75-78	8	6.6L	Left	--	605004 ③
79-80	8	All	Right	--	602004 ③
79-80	8	All	Left	--	602004 ③
MERCURY MARQUIS MIDSIZE					
84-86	4	2.3L	39" Conv.	--	602004 ③
1983	4	2.3L	Front	--	602204 ③
1983	4	2.3L	Rear	--	602204 ③
1983	4	2.3L	Main & Pre-Cat	--	602004 ③
1983	6	3.3L	Rear	--	602204 ③
1983	6	3.3L	Main & Pre-Cat	--	602004 ③
84-86	6	3.8L	w/ Fuel Injection, Rear	--	602005 ③
84-86	6	3.8L	w/ Fuel Injection, Main & Pre-Cat	--	602005 ③
1984	6	3.8L	EEC, Rear	--	602004 ③
1984	6	3.8L	EEC, Main & Pre-Cat	--	602005 ③
1984	6	3.8L	Rear, (Exc. Fuel Injection & EEC)	--	602005 ③
1984	6	3.8L	(Exc. Fuel Injection & EEC), Main & Pre-Cat	--	602004 ③
1983	6	3.8L		--	602005 ③
1983	6	3.8L	Main & Pre-Cat	--	602004 ③
MERCURY MILAN					
07-09	4	2.3L	With Air Tube, Auto Trans., California Emissions, Front	641321 ⑤	--
10-11	6	3.0L	Front Right	641387 ③	--
06-11	6	3.0L	Manifold Unit, Front Left	641329 ③	--
			Manifold Unit, Front Left	641241 ③①	--
07-08	6	3.0L	Rear Manifold Conv., AWD, 09-04-06 to 12-03-07	641282 ③	--
06-08	6	3.0L	Rear Manifold Conv., FWD	641242 ③	--
06-08	6	3.0L	Rear Main Conv., FWD	642216 ③	608205 ③
MERCURY MONARCH					
1980	6	4.1L	(Exc. 14-1/4" Conv.), Rear	--	602004 ③
1980	6	4.1L	(Exc. 14-1/4" Conv.), Main & Pre-Cat	--	602004 ③
78-80	6	4.1L	14-1/4" Conv., Rear	--	602205 ③
77-79	6	4.1L	18" Conv.	--	602205 ③
75-76	6	All		--	602204 ③
77-79	8	5.0L	(Exc. 18" Conv.)	--	602205 ③
77-79	8	5.0L	18" Conv.	--	602205 ③
75-76	8	5.0L		--	602205 ③
1977	8	5.8L	Left	--	602214 ③
1977	8	5.8L	Right	--	602214 ③
75-76	8	5.8L	Left	--	602214 ③

① Discontinued, use until inventory is depleted.

③ Federal & California Emissions. Not For Sale or Use on vehicles licensed in the state of CA & NY (NY vehicles with CA Emissions). Check with your state authority for details.

⑤ California Emissions. Not For Sale or Use on vehicles licensed in the state of CA & NY. Check with your state authority.

APPLICATION LISTINGS

FEDERAL CONVERTERS



YR/YRS	CYL	LITER	DESCRIPTION	DIRECT FIT	UNIVERSAL
MERCURY MONARCH (Cont.)					
75-76	8	5.8L	Right	--	602214③
1980	8	All		--	602205③
MERCURY MONTEGO					
05-07	6	3.0L	Front, 2WD	642252 ③	--
05-07	6	3.0L	Front, AWD	642243 ③	--
05-07	6	3.0L	Rear	642251 ③	--
05-07	6	3.0L	Rear Main Conv.	642250 ③	608285③
75-76	8	5.8L	Left	--	602214③
75-76	8	5.8L	Right	--	602214③
75-76	8	6.6L	Left	--	605004③
75-76	8	6.6L	Right	--	605004③
75-76	8	7.5L	Left	--	605004③
75-76	8	7.5L	Right	--	605004③
MERCURY MONTEREY					
04-07	6	4.2L		642767 ③	--
MERCURY MOUNTAINEER					
06-10	6	4.0L	Complete Assembly	645430 ③	--
06-07	6	4.0L	Left	--	608265③○
06-07	6	4.0L	Right	--	608265③○
02-05	6	4.0L	Code "E" Eng., Front	--	608214③
02-05	6	4.0L	Code "E" Eng., Rear	--	608226③
02-05	6	4.0L	Code "E" Eng., Complete Assembly	645887 ③	--
98-01	6	4.0L	LEV Code "E" Eng., w/Single Inlet Pipe Muffler, Front Convs., California Emissions	641178 ⑤	--
98-01	6	4.0L	LEV Code "E" Eng., w/Single Inlet Pipe Muffler, Rear Convs., California Emissions	645420 ⑤	--
98-01	6	4.0L	Code "E", w/ Dual Inlet Pipe Muffler, Left	642590 ③	608215③
98-01	6	4.0L	Code "E", w/ Dual Inlet Pipe Muffler, Right Conv. w/Left Side Extension Pipe	642293 ③	608205③
98-01	6	4.0L	Code "E", w/ Dual Inlet Muffler, Right Conv. w/o Left Side Extension Pipe	642589 ③	608205③
06-10	8	4.6L	Complete Assembly	643056 ③	--
02-05	8	4.6L	Complete Assembly	645872 ③	--
02-05	8	4.6L	Front Left	--	608214③
02-05	8	4.6L	Rear Universal	--	608226③
02-05	8	4.6L	Front Right	--	608214③
98-00	8	5.0L	Left; From 2/98	642925 ③	--
98-00	8	5.0L	Right; From 2/98	642926 ③	--
97-98	8	5.0L	Front Right; To 1/98	642611 ③	--
97-98	8	5.0L	Front Left; To 1/98	642612 ③	--
97-98	8	5.0L	Rear Right; To 1/98	--	608225③
97-98	8	5.0L	Rear Left; To 1/98	--	608225③
97-98	8	5.0L	Complete Rear Assembly; To 1/98	645370 ③	--
MERCURY MYSTIQUE					
98-00	4	2.0L	(Exc. Eng. Code Z)	642677 ③	--
95-97	4	2.0L		642610 ③	--
95-00	6	2.5L	Rear Side Manifold Conv.	641129 ③	--

③ Federal & California Emissions. Not For Sale or Use on vehicles licensed in the state of CA & NY (NY vehicles with CA Emissions). Check with your state authority for details.

⑤ California Emissions. Not For Sale or Use on vehicles licensed in the state of CA & NY. Check with your state authority.

○ EPA Enhanced OBDII By Design Unit



APPLICATION LISTINGS FEDERAL CONVERTERS

YR/YRS	CYL	LITER	DESCRIPTION	DIRECT FIT	UNIVERSAL
MERCURY MYSTIQUE (Cont.)					
95-00	6	2.5L	Front Side Manifold Conv.	641127 ③	--
95-00	6	2.5L	Rear, Auto Trans., w/O2 Sensor	642683 ③	608204 ③
95-00	6	2.5L	Main Conv., Manual Trans.	642538 ③	608205 ③
95-96	6	2.5L	Main Conv., Without O2 Sensor, Auto Trans.	642492 ③	602204 ③
MERCURY SABLE					
00-05	6	3.0L	Front, 12 valve	642696 ③	--
00-05	6	3.0L	Rear, 12 valve	642697 ③	--
00-05	6	3.0L	Front Y Type Conv., 24 valve Eng.	641149 ③	--
00-05	6	3.0L	Rear Manifold Conv., 24 valve Eng.	641153 ③	--
00-05	6	3.0L	Rear Main Conv., 24 valve Eng.	642697 ③	--
96-99	6	3.0L	24 valve	642660 ③	--
96-99	6	3.0L	12 valve, Code "U", AX4S Trans	642581 ③	--
96-99	6	3.0L	12 valve, Code "U", AX4N Trans	642581 ③	--
96-99	6	3.0L	LEV Models, 12 valve	642726 ③	--
93-95	6	3.0L	w/Dual Convs.	642480 ③	602294 ③
86-94	6	3.0L	w/Single Conv.	642328 ③	--
08-09	6	3.5L	Rear, Federal Emissions	642214 ④	--
08-09	6	3.5L	Front, Federal Emissions	642215 ④	--
08-09	6	3.5L	FWD, Left	--	608275 ③○
08-09	6	3.5L	Rear, California Emissions	642056 ⑤	--
08-09	6	3.5L	FWD, Right	--	608275 ③○
91-95	6	3.8L		642358 ③	602204 ③
88-90	6	3.8L	Rear	--	602004 ③
88-90	6	3.8L	Main & Pre-Cat	--	602004 ③
MERCURY TOPAZ					
85-94	4	2.3L		642362 ☆③	--
1984	4	2.3L		--	602004 ③
92-94	6	3.0L		642441 ③	602204 ③
MERCURY TRACER					
88-89	4	1.6L	Reversible/Non-Directional Unit	--	602204 ③
1987	4	1.6L		--	602205 ③
91-95	4	1.8L		--	602204 ③
1996	4	1.9L		642701 ③	608294 ③
91-95	4	1.9L	EGR Port on Conv.	642468 ③	608294 ③
91-95	4	1.9L	w/o EGR Port on Conv.	642354 ③	608294 ③
97-99	4	2.0L		642548 ③	608294 ③
MERCURY VILLAGER					
96-98	6	3.0L	Front	642454 ③	608264 ③
96-98	6	3.0L		642455 ③	608205 ③
94-95	6	3.0L	Front	642454 ③	602215 ③
94-95	6	3.0L		642455 ③	602205 ③
1993	6	3.0L		642455 ③	602205 ③
01-02	6	3.3L	Manifold Unit, Front Left	641394 ③	--
99-02	6	3.3L		642455 ③	608205 ③
99-00	6	3.3L	California Emissions, Manifold Unit, Front Left	641394 ⑤	--

☆ Air Tube kit 4948 may be required for installation.

③ Federal & California Emissions. Not For Sale or Use on vehicles licensed in the state of CA & NY (NY vehicles with CA Emissions). Check with your state authority for details.

④ Federal Emissions. Not For Sale or Use on vehicles licensed in the state of CA. Check with your state authority.

⑤ California Emissions. Not For Sale or Use on vehicles licensed in the state of CA & NY. Check with your state authority.

○ EPA Enhanced OBDII By Design Unit

APPLICATION LISTINGS

FEDERAL CONVERTERS



YR/YRS	CYL	LITER	DESCRIPTION	DIRECT FIT	UNIVERSAL
MERCURY ZEPHYR					
1983	4	2.3L	39" Conv.	--	602004③
81-83	4	2.3L	(Exc. 39" Conv.)	--	602005③
78-80	4	2.3L	17" Conv.	--	602204③
78-83	6	3.3L	Rear	--	602204③
78-83	6	3.3L	Main & Pre-Cat	--	602004③
1982	8	4.2L	23" Conv., Rear	--	602005③
1982	8	4.2L	23" Conv., Main & Pre-Cat	--	602004③
1982	8	4.2L	25" Conv., Rear	--	602004③
1982	8	4.2L	25" Conv., Main & Pre-Cat	--	602004③
1981	8	4.2L		--	602005③
1981	8	4.2L	Main & Pre-Cat	--	602004③
1980	8	4.2L		--	602204③
1980	8	4.2L	Main & Pre-Cat	--	602004③
78-79	8	5.0L	Rear	--	602204③
MERKUR SCORPIO					
88-89	6	2.9L	Front	--	602204③
88-89	6	2.9L		--	602004③
88-89	6	2.9L	Main & Pre-Cat	--	602004③
MERKUR XR4TI					
85-89	4	All		--	602205③
MINI COOPER					
09-15	4	1.6L	Turbocharged, Convertible, Front	641440 ③	--
07-15	4	1.6L	Naturally Aspirated, Manifold Unit, Front	641420 ③	--
07-14	4	1.6L	Turbocharged, Hatchback, Front	641440 ③	--
2009	4	1.6L	S Model, Convertible, Rear	644009 ③	--
08-09	4	1.6L	S Clubman Model, Hatchback, Rear	644009 ③	--
07-09	4	1.6L	S Model, Hatchback, Rear	644009 ③	--
07-08	4	1.6L	Convertible, Manifold Unit, Front	641395 ③	--
02-06	4	1.6L	R50, R52 or R53	--	608225③
02-06	4	1.6L	Manifold Unit, Front	641395 ③	--
MITSUBISHI 3000GT					
91-99	6	3.0L		642409 ③	602005③
MITSUBISHI CORDIA, TREDIA					
83-88	4	All	Rear	642385 ③	602214③
83-88	4	All	Main & Pre-Cat	--	602004③
MITSUBISHI DIAMANTE					
94-95	6	3.0L	Front Left	--	602215③
94-95	6	3.0L		--	602205③
94-95	6	3.0L	Front Right	--	602215③
92-93	6	3.0L		642409 ③	602205③
99-02	6	3.5L	Front Side	641163 ③	--
99-02	6	3.5L	Rear Side	641164 ③	--
MITSUBISHI ECLIPSE					
95-98	4	2.0L		642755 ③	608205③
06-11	4	2.4L	Front Conv.	642249 ③	--
06-09	4	2.4L	Rear, Does NOT Include Resonator Pipe	642154 ⁹⁰⁰ ③	608265③○
00-05	4	2.4L	Rear, From 06/00	643011 ③	608205③

⁹⁰⁰ Direct fit converter may require resizing, cutting or bushing.

③ Federal & California Emissions. Not For Sale or Use on vehicles licensed in the state of CA & NY (NY vehicles with CA Emissions). Check with your state authority for details.

○ EPA Enhanced OBDII By Design Unit



APPLICATION LISTINGS FEDERAL CONVERTERS

YR/YRS	CYL	LITER	DESCRIPTION	DIRECT FIT	UNIVERSAL
MITSUBISHI ECLIPSE (Cont.)					
00-05	4	2.4L	Front, From 06/00	641207 ③	--
1999	4	2.4L	Front, Convertible Models, California Emissions; To 5/00	641165 ⑤	--
1999	4	2.4L	Rear, Convertible Models, California Emissions; To 5/00	642747 ⑤	608235 ⑤
96-98	4	2.4L		642755 ③	608205 ③
90-94	4	All		642403 ③	602204 ③
00-05	6	3.0L	Front Side	641163 ③	--
00-05	6	3.0L	Rear Side	641164 ③	--
00-05	6	3.0L	Main Rear, From 06/00	642987 ③	608235 ③
06-12	6	3.8L	With Curved Outlet Pipe, Manifold Unit, Front Right	641398 ③	--
06-10	6	3.8L	Manifold Unit, Front	641292 ③	--
06-10	6	3.8L	Without Curved Outlet Pipe, Rear Manifold Conv.	641289 ③	--
06-10	6	3.8L	Rear Main Conv.	642078 ③	--
MITSUBISHI ENDEAVOR					
10-11	6	3.8L	Rear, Requires resonator pipe 78295 (FWD) or 78294 (AWD) to complete installation as OE was a welded assembly	642823 ③	608405 ③
04-08	6	3.8L	Rear, Requires resonator pipe 78295 (FWD) or 78294 (AWD) to complete installation as OE was a welded assembly	642823 ③	608405 ③
2004	6	3.8L	AWD, Front Manifold Conv.	641222 ③	--
2004	6	3.8L	AWD, Rear Manifold Conv.	641223 ③	--
2004	6	3.8L	AWD, Rear Main Conv., To cut and fit with OE resonator pipe	645441 ③	608226 ③
MITSUBISHI EXPO					
92-95	4	All		642403 ③	602204 ③
92-94	4	All	4WD	--	602204 ③
MITSUBISHI EXPO VAN					
92-95	4	2.4L	Expo Models, 2WD	642403 ③	602204 ③
MITSUBISHI GALANT					
89-92	4	2.0L		642403 ③	602204 ③
04-12	4	2.4L	Rear, Cut as Required & Adapter 8909 Required to Mate to OE Resonator Pipe	642173 ③	--
04-12	4	2.4L	Front	642249 ③	--
00-03	4	2.4L	Front, From 06/00	641207 ③	--
00-03	4	2.4L	Rear, From 06/00	643011 ③	608205 ③
99-00	4	2.4L	Federal Emissions; To 5/00	643020 ④	608205 ④
99-00	4	2.4L	Front, California Emissions; To 5/00	641165 ⑤	--
99-00	4	2.4L	Rear, California Emissions; To 5/00	642747 ⑤	608235 ⑤
95-98	4	2.4L	SOHC, Rear	642755 ③	608204 ③
1994	4	2.4L	SOHC, Rear	642755 ③	602204 ③
85-87	4	2.4L	24" Conv.	--	602204 ③
00-03	6	3.0L	Rear Main Conv., From 06/00	642987 ③	608235 ③
99-03	6	3.0L	Front Side	641163 ③	--
99-03	6	3.0L	Rear Side	641164 ③	--
99-00	6	3.0L	Rear Main Conv., California Emissions, To 05/00	642987 ⑤	608235 ⑤
1988	6	3.0L	Sigma	--	602204 ③
07-09	6	3.8L	Manifold Unit, Front	641292 ③	--
07-09	6	3.8L	Without Curved Outlet Pipe, Rear Manifold Conv.	641289 ③	--
06-09	6	3.8L	Rear Main Conv.	642078 ③	--
04-09	6	3.8L	With Curved Outlet Pipe, Manifold Unit, Front Right	641398 ③	--

③ Federal & California Emissions. Not For Sale or Use on vehicles licensed in the state of CA & NY (NY vehicles with CA Emissions). Check with your state authority for details.

④ Federal Emissions. Not For Sale or Use on vehicles licensed in the state of CA. Check with your state authority.

⑤ California Emissions. Not For Sale or Use on vehicles licensed in the state of CA & NY. Check with your state authority.

APPLICATION LISTINGS

FEDERAL CONVERTERS



YR/YRS	CYL	LITER	DESCRIPTION	DIRECT FIT	UNIVERSAL
MITSUBISHI GALANT (Cont.)					
04-05	6	3.8L	Rear	642868 ③	--
MITSUBISHI LANCER					
2008	4	2.0L	Naturally Aspirated	642899 ③	--
05-07	4	2.0L	Rear, (Exc. Turbo)	642091 ③	--
02-07	4	2.0L	Naturally Aspirated, Manifold Unit, Front	641374 ③	--
			Naturally Aspirated, Manifold Unit, Front	641193 ③④	--
02-03	4	2.0L	Rear, (Exc. Turbo)	642297 ③	608204③
2004	4	2.4L		643103 ③	--
MITSUBISHI MIRAGE					
00-02	4	1.5L	Front, From 06/00	641239 ③	--
00-02	4	1.5L	Rear, From 06/00	642212 ③	--
97-00	4	1.5L	DE Models, To 05/00, Federal Emissions	642746 ④	608204④
97-00	4	1.5L	Front, California Emissions, To 05/00	641239 ⑤	--
97-00	4	1.5L	Rear, California Emissions; To 5/00	642212 ⑤	--
93-95	4	1.5L		--	602205③
87-88	4	1.5L		642385 ③	602214③
87-88	4	1.6L	Turbo	642385 ③	602214③
97-02	4	1.8L	Under Body Conv.	642059 ③	--
93-95	4	1.8L		--	602205③
89-92	4	All		642403 ③	602204③
85-86	4	All	Rear	--	602204③
85-86	4	All	Main & Pre-Cat	--	602004③
MITSUBISHI MONTERO					
87-89	4	2.6L		642385 ③	602204③
83-86	4	2.6L		--	602295③
95-00	6	3.0L		--	608235③
93-94	6	3.0L		--	608205③
89-92	6	3.0L		--	602204③
01-02	6	3.5L	Front, (Exc. Sport)	641225 ③	--
01-02	6	3.5L	Rear, (Exc. Sport)	645447 ③	608206③
99-00	6	3.5L	Federal Emissions, Exc. Sport Model	642287 ④	608205④
97-98	6	3.5L	Federal Emissions	642287 ④	608205④
94-96	6	3.5L		642287 ③	608205③
04-06	6	3.8L	Front Y-Pipe Conv.	644005 ③	--
03-06	6	3.8L	Center	644006 ③	--
MITSUBISHI MONTERO SPORT					
98-99	4	2.4L		--	608204③
01-03	6	3.0L	Front Right	641189 ③	--
01-03	6	3.0L	Front Left	641190 ③	--
01-03	6	3.0L	Rear	642298 ③	608205③
97-01	6	3.0L	Federal Emissions	642054 ④	--
99-00	6	3.0L	California Emissions, Right	642023 ⑤	--
99-00	6	3.0L	California Emissions, Front Left	642865 ⑤	--
99-01	6	3.5L	Federal Emissions	642054 ④	--
99-00	6	3.5L	Front Left	642866 ③	--
99-00	6	3.5L	California Emissions, Front Right	642867 ⑤	--

① Discontinued, use until inventory is depleted.

② Federal & California Emissions. Not For Sale or Use on vehicles licensed in the state of CA & NY (NY vehicles with CA Emissions). Check with your state authority for details.

③ Federal Emissions. Not For Sale or Use on vehicles licensed in the state of CA. Check with your state authority.

④ California Emissions. Not For Sale or Use on vehicles licensed in the state of CA & NY. Check with your state authority.



APPLICATION LISTINGS FEDERAL CONVERTERS

YR/YRS	CYL	LITER	DESCRIPTION	DIRECT FIT	UNIVERSAL
MITSUBISHI OUTLANDER					
08-09	4	2.4L	Center	643130 ③	--
03-06	4	2.4L	FWD	642022 ③	608254 ③
07-13	6	3.0L	Manifold Unit, Front Left	641411 ③	--
07-13	6	3.0L	Manifold Unit, Front Right	641412 ③	--
07-09	6	3.0L	AWD, Federal Emissions	642888 ④	--
MITSUBISHI PICKUP					
85-86	4	2.0L		--	602204 ③
90-95	4	2.4L		642403 ③	602204 ③
85-86	4	2.6L		--	602204 ③
87-89	4	All		--	602215 ③
83-84	4	All		--	602204 ③
90-94	6	3.0L	4WD	--	602204 ③
MITSUBISHI PRECIS					
90-94	4	1.5L		642403 ③	602204 ③
87-89	4	All	Rear	--	602204 ③
87-89	4	All	Main & Pre-Cat	--	602004 ③
MITSUBISHI SIGMA					
89-90	6	3.0L		--	602204 ③
MITSUBISHI STARION					
83-89	6	2.6L	Turbo, Rear	--	602204 ③
MITSUBISHI VAN					
87-90	4	2.4L		642403 ③	602204 ③
NISSAN 200SX					
97-98	4	1.6L	SE Models	642662 ③	--
95-96	4	1.6L	Underfloor	642574 ③	--
95-96	4	1.6L	Front, SE Models, California Emissions	642662 ⑤	--
1995	4	1.6L	Optional Converter, Underfloor	642409 ③	602205 ③
86-87	4	1.8L	Turbo Built After 1/86	--	602206 ③
84-86	4	1.8L	Turbo,	642409 ③	602205 ③
1998	4	2.0L		642202 ③	608205 ③
95-97	4	2.0L	SE-R Models, 16 Valve Twin Cam	642574 ③	--
1995	4	2.0L	Optional Conv.	642409 ③	602205 ③
86-88	4	2.0L	Built after 1/86	--	602206 ③
84-86	4	2.0L	Built before 1/86	642409 ③	602205 ③
81-83	4	All		642409 ③	602205 ③
1980	4	All		642403 ③	602204 ③
77-79	4	All	w/Conv.	642409 ③	602205 ③
87-88	6	3.0L		--	602206 ③
NISSAN 240SX					
95-98	4	2.4L	Front	642275 ③	608274 ③
95-98	4	2.4L		642793 ③	608295 ③
93-94	4	2.4L		642409 ③	602205 ③
89-92	4	All	Coupe, Hatchback	642334 ③	602206 ③
NISSAN 280Z, 280ZX					
81-83	6	2.8L	Turbo	642409 ③	602205 ③
1980	6	2.8L	(Exc. Turbo)	642403 ③	602204 ③
1979	6	All	Federal Emissions	642403 ④	602204 ④

③ Federal & California Emissions. Not For Sale or Use on vehicles licensed in the state of CA & NY (NY vehicles with CA Emissions). Check with your state authority for details.

④ Federal Emissions. Not For Sale or Use on vehicles licensed in the state of CA. Check with your state authority.

⑤ California Emissions. Not For Sale or Use on vehicles licensed in the state of CA & NY. Check with your state authority.

APPLICATION LISTINGS

FEDERAL CONVERTERS



YR/YRS	CYL	LITER	DESCRIPTION	DIRECT FIT	UNIVERSAL
NISSAN 280Z, 280ZX (Cont.)					
1979	6	All	California Emissions	642409 ⑤	602205 ⑤
75-78	6	All		642409 ③	602205 ③
NISSAN 300ZX					
90-95	6	3.0L	(Exc. Turbo), Right	--	602005 ③
90-95	6	3.0L	(Exc. Turbo), Left	--	602005 ③
90-95	6	3.0L	Turbo, Left	--	602006 ③
90-95	6	3.0L	Turbo, Right	--	602006 ③
90-94	6	3.0L	Manual Trans., Turbo, Right	--	602214 ③
90-94	6	3.0L	Manual Trans., Turbo, Left	--	602214 ③
84-89	6	3.0L		--	602206 ③
NISSAN 310					
79-80	4	1.4L	w/2-1/4" Exhaust Piping	642409 ③	602205 ③
81-82	4	1.5L	w/2" Exhaust Piping	642403 ③	602204 ③
NISSAN 350Z					
03-06	6	3.5L	Right	642713 ③	--
03-06	6	3.5L	Left	642714 ③	--
NISSAN 510, F-10					
79-81	4	All	w/2" Exhaust Piping, Federal Emissions	642403 ④	602204 ④
79-81	4	All	w/2-1/4" Exhaust Piping, California Emissions	642409 ⑤	602205 ⑤
NISSAN 810					
81-84	6	2.4L	w/2-1/4" Exhaust Piping	642409 ③	602205 ③
79-80	6	2.4L	w/2" Exhaust Piping	642403 ③	602204 ③
78-79	6	2.4L	w/2-1/4" Exhaust Piping, California Emissions	642409 ⑤	602205 ⑤
NISSAN ALTIMA					
00-01	4	2.4L	Front, California Emissions	641147 ⑤	--
00-01	4	2.4L	Rear, California Emissions	642793 ⑤	608295 ⑤
98-01	4	2.4L	GXE, GLE & XE, Federal Emissions	641147 ④	--
95-97	4	2.4L	Front	641161 ③	--
95-97	4	2.4L	Rear	642574 ③	--
93-94	4	2.4L	w/O2 Sensor in Conv.	642574 ③	--
93-94	4	2.4L	w/o O2 Sensor	642403 ③	602204 ③
13-15	4	2.5L	Manifold Unit, Front	641427 ③	--
07-15	4	2.5L	Rear, Exc. Hybrid	643090 ③	608415 ③
07-12	4	2.5L	Front	641302 ③	--
08-09	4	2.5L	Sedan, Rear	643077 ④①	608415 ③
2007	4	2.5L	Rear	643077 ④①	608415 ③
02-06	4	2.5L	Front, California Emissions	641198 ⑤	--
02-06	4	2.5L	Rear, California Emissions	642280 ⑤	608415 ⑤○
			Rear, California Emissions	--	608215 ⑤□
02-03	4	2.5L	Manifold Unit, Front	641320 ③	--
07-08	6	3.5L	Manifold Unit, Front	641265 ③	--
07-08	6	3.5L	Rear Manifold Conv.	641266 ③	--
07-08	6	3.5L	Rear Main Conv.	642156 ③	--
05-06	6	3.5L	Rear Manifold Conv.	641214 ③	--
04-06	6	3.5L	Rear Main Conv., Auto Trans., From 1/04	642244 ③	--
04-06	6	3.5L	Front Manifold Conv., Auto Trans., From 1/04	641245 ③	--
04-06	6	3.5L	Front Manifold Conv., Manual Trans., From 1/04	641199 ③	--

- ① Discontinued, use until inventory is depleted.
- ③ Federal & California Emissions. Not For Sale or Use on vehicles licensed in the state of CA & NY (NY vehicles with CA Emissions). Check with your state authority for details.
- ④ Federal Emissions. Not For Sale or Use on vehicles licensed in the state of CA. Check with your state authority.
- ⑤ California Emissions. Not For Sale or Use on vehicles licensed in the state of CA & NY. Check with your state authority.
- EPA OBDII By Design Unit
- EPA Enhanced OBDII By Design Unit



APPLICATION LISTINGS FEDERAL CONVERTERS

YR/YRS	CYL	LITER	DESCRIPTION	DIRECT FIT	UNIVERSAL
NISSAN ALTIMA (Cont.)					
04-06	6	3.5L	Rear Main Conv., Manual Trans., From 1/04	642264 ③	608265 ③
02-04	6	3.5L	Front Manifold Conv., To 1/04	641199 ③	--
02-04	6	3.5L	Rear Manifold Conv.	641214 ③	--
02-04	6	3.5L	Rear Main Conv., To 1/04	642264 ③	608265 ③○
NISSAN ARMADA					
07-15	8	5.6L	Rear Right	642115 ③	608405 ③
07-15	8	5.6L	Rear Left	642031 ③	608405 ③
05-06	8	5.6L	Right Manifold Conv.	642075 ③	--
05-06	8	5.6L	Manifold Unit, Left	642074 ③	--
05-06	8	5.6L	Without Flex, US EPA, BIN 8, SULEV Emissions, Right Rear	642115 ③	608405 ③
05-06	8	5.6L	Without Flex, US EPA, BIN 8, SULEV Emissions, Left Rear	642116 ③	608405 ③
NISSAN AXXESS VAN					
1990	4	2.4L		642409 ③	602205 ③
NISSAN B210, 210					
80-82	4	1.2L		642409 ③	602205 ③
80-82	4	1.4L		642409 ③	602205 ③
80-82	4	1.5L		642409 ③	602205 ③
77-79	4	All	Federal Emissions	642403 ④	602204 ④
77-79	4	All	California Emissions	642409 ⑤	602205 ⑤
NISSAN CUBE					
11-14	4	1.8L	Federal Emissions	642155 ③	--
09-10	4	1.8L		642155 ③	--
NISSAN FRONTIER					
01-04	4	2.4L	Front	641234 ③	--
98-04	4	2.4L	Rear, w/ 13-1/2" Converter	642028 ③	608405 ③
00-03	4	2.4L		--	608214 ③
05-16	4	2.5L	Manifold Unit, Front	641407 ③	--
02-04	6	3.3L	Front Right Manifold Conv.	641243 ③	--
02-04	6	3.3L	Front Left Manifold Conv.	641244 ③	--
99-04	6	3.3L	Main Right	642736 ③	608204 ③
99-04	6	3.3L	Main Left, w/ 26-3/4" Converter	642737 ③	608205 ③
99-04	6	3.3L	Main Left, w/ 41" Converter	642206 ③	--
99-01	6	3.3L	Front Right	641150 ③	--
99-01	6	3.3L	Front Left	641151 ③	--
2000	6	3.3L	From 1/00 To 9/00, Front Left	--	608204 ③
2000	6	3.3L	From 1/00 To 9/00, Front Right	--	608204 ③
05-10	6	4.0L	Left Front	642124 ③	--
05-10	6	4.0L	Right Front	642138 ③	--
05-10	6	4.0L	Right Rear	642150 ③	608405 ③
05-10	6	4.0L	Left Rear	642149 ③	608405 ③
NISSAN JUKE					
11-16	4	1.6L	FWD, Rear	642805 ③	--
NISSAN MAXIMA					
00-01	6	3.0L	Front, California Emissions	641167 ⑤	--
00-01	6	3.0L	Middle Conv., California Emissions	642779 ⑤	--
00-01	6	3.0L	Rear, California Emissions	642793 ⑤	608295 ⑤
95-00	6	3.0L	Main Conv., Federal Emissions	642574 ④	--

③ Federal & California Emissions. Not For Sale or Use on vehicles licensed in the state of CA & NY (NY vehicles with CA Emissions). Check with your state authority for details.

④ Federal Emissions. Not For Sale or Use on vehicles licensed in the state of CA. Check with your state authority.

⑤ California Emissions. Not For Sale or Use on vehicles licensed in the state of CA & NY. Check with your state authority.

○ EPA Enhanced OBDII By Design Unit

APPLICATION LISTINGS

FEDERAL CONVERTERS



YR/YRS	CYL	LITER	DESCRIPTION	DIRECT FIT	UNIVERSAL
NISSAN MAXIMA (Cont.)					
1999	6	3.0L	California Emissions, Center	642850 ⑤	--
95-99	6	3.0L	Front, Federal Emissions	642680 ④	--
1994	6	3.0L	24 valve, 12-3/8" Conv.	642561 ③	--
1994	6	3.0L	24 valve, (Exc. 12-3/8" Conv.)	642409 ③	602205 ③
86-93	6	3.0L	Built from 1/86	642409 ③	602205 ③
85-86	6	3.0L	Rear, Built to 1/86	--	602206 ③
10-15	6	3.5L	Federal Emissions, Front Left	641424 ④	--
10-15	6	3.5L	Federal Emissions, Front Right	641425 ④	--
2009	6	3.5L	Front Left	641424 ③	--
2009	6	3.5L	Front Right	641425 ③	--
2009	6	3.5L	Center	644003 ③	--
07-08	6	3.5L	Manifold Unit, Front	641315 ③	--
04-08	6	3.5L	Rear Manifold Conv.	641214 ③	--
2006	6	3.5L	Rear Main Conv., SE w/ 5 Speed Auto Trans.	642244 ③	608265 ③ □
05-06	6	3.5L	Front Manifold Conv., Manual Trans.	641315 ③	--
05-06	6	3.5L	Front Manifold, Auto Trans.	641314 ③	--
05-06	6	3.5L	Rear Main Conv., Auto Trans.	642244 ③	608265 ③ ○
2004	6	3.5L	Front Manifold Conv., 5 Speed Auto. Trans.	641314 ③	--
2004	6	3.5L	Front Manifold Conv., Manual Trans.	641315 ③	--
2004	6	3.5L	Front Manifold Conv., 4 Speed Auto Trans.	641315 ③	--
2004	6	3.5L	Rear Main Conv., 5 Speed Auto Trans.	642244 ③	608265 ③ ○
02-03	6	3.5L	Front Pre-Cat Conv.	641182 ③	--
02-03	6	3.5L	Rear Pre-Cat Conv.	641183 ③	--
02-03	6	3.5L	Rear Main Conv.	642764 ③	--
NISSAN MICRA					
88-91	4	All	(Canada Model)	642403 ③	602294 ③
84-87	4	All	(Canada Model)	--	602004 ③
NISSAN MULTI					
1988	4	2.0L	(Canada Model)	--	602204 ③
86-87	4	2.0L	(Canada Model)	642409 ③	602205 ③
NISSAN MURANO					
09-12	6	3.5L	Rear	642033 ③	--
03-07	6	3.5L	Manifold Unit, Front	641199 ③	--
03-07	6	3.5L	Rear Manifold Conv.	641226 ③	--
03-07	6	3.5L	Rear Main	642245 ③	608285 ③ ○
NISSAN NX					
91-93	4	All		642409 ③	602205 ③
NISSAN PATHFINDER					
87-88	4	2.4L	w/Air Tube	--	602005 ③
1995	6	3.0L	Front	--	602214 ③
1995	6	3.0L		--	602205 ③
90-94	6	3.0L		642455 ③	602205 ③
87-89	6	3.0L	w/Air Tube	--	602005 ③
98-00	6	3.3L	Rear Right, California Emissions	642283 ⑤	608204 ⑤
98-00	6	3.3L	Rear Left, California Emissions	642282 ⑤	608204 ⑤
96-00	6	3.3L	Front, Right	641134 ③	--
96-00	6	3.3L	Front, Left	641133 ③	--

③ Federal & California Emissions. Not For Sale or Use on vehicles licensed in the state of CA & NY (NY vehicles with CA Emissions). Check with your state authority for details.

④ Federal Emissions. Not For Sale or Use on vehicles licensed in the state of CA. Check with your state authority.

⑤ California Emissions. Not For Sale or Use on vehicles licensed in the state of CA & NY. Check with your state authority.

□ EPA OBDII By Design Unit

○ EPA Enhanced OBDII By Design Unit



APPLICATION LISTINGS FEDERAL CONVERTERS

YR/YRS	CYL	LITER	DESCRIPTION	DIRECT FIT	UNIVERSAL
NISSAN PATHFINDER (Cont.)					
01-04	6	3.5L	Front Right	641212 ③	--
01-04	6	3.5L	Front Left	641133 ③	--
2001	6	3.5L	Rear Right	642283 ③	608204 ③
2001	6	3.5L	Rear Left	642282 ③	608204 ③
05-10	6	4.0L	Right Front	642138 ③	--
05-10	6	4.0L	Left Front	642124 ③	--
05-10	6	4.0L	Right Rear	642150 ③	608405 ③
05-10	6	4.0L	Left Rear	642149 ③	608405 ③
2004	8	5.6L	Right Manifold Conv.	642075 ③	--
2004	8	5.6L	Manifold Unit, Left	642074 ③	--
NISSAN PICKUP					
1983	4	2.0L		642409 ③	602005 ③
1980	4	2.0L		642409 ③	602005 ③
81-83	4	2.2L		642409 ③	602005 ③
96-97	4	2.4L	w/ 16" Converter	642455 ③	608205 ③
96-97	4	2.4L	w/ 13-1/2" Converter	642028 ③	608405 ③
1995	4	2.4L	4WD	642455 ③	602205 ③
1995	4	2.4L	2WD	642334 ③	609006 ③
93-94	4	2.4L	2WD, Federal Emissions	642334 ④	602206 ④
90-94	4	2.4L	4WD	642403 ③	602204 ③
90-92	4	2.4L	2WD	642334 ③	602206 ③
88-89	4	2.4L	w/Air Tube, 4WD	--	602005 ③
88-89	4	2.4L	w/o Air Tube, 2WD, 2-1/2" Pipe	642334 ③	602206 ③
88-89	4	2.4L	w/o Air Tube, 2WD, 2-1/4" Pipe	642409 ③	602205 ③
86-87	4	2.4L	D21 (Hardbody) Pickup	642409 ③	602005 ③
83-86	4	2.4L	720 Pickup	642403 ③	602204 ③
94-95	6	3.0L	4WD, Front	--	602214 ③
94-95	6	3.0L	4WD, Rear	--	602205 ③
94-95	6	3.0L	2WD	642409 ③	602205 ③
90-93	6	3.0L		642409 ③	602205 ③
86-89	6	3.0L	w/Air Tube	--	602005 ③
86-89	6	3.0L	w/o Air Tube	642409 ③	602205 ③
NISSAN PULSAR					
88-90	4	All		642409 ③	602205 ③
1987	4	All	(Exc. 16 valve)	642409 ③	602205 ③
1987	4	All	w/16 valve	--	602205 ③
83-86	4	All	w/o Air Tube	642409 ③	602205 ③
83-86	4	All	w/Air Tube	--	602005 ③
NISSAN QUEST					
96-98	6	3.0L	Front	642454 ③	608264 ③
96-98	6	3.0L		642455 ③	608205 ③
94-95	6	3.0L	Front	642454 ③	602215 ③
94-95	6	3.0L		642455 ③	602205 ③
1993	6	3.0L		642455 ③	602205 ③
01-02	6	3.3L	Manifold Unit, Front Left	645295 ③⑩	--
			Manifold Unit, Front Left	641394 ③	--
99-02	6	3.3L	Rear	642455 ③	608205 ③

⑩ Discontinued, use until inventory is depleted.

③ Federal & California Emissions. Not For Sale or Use on vehicles licensed in the state of CA & NY (NY vehicles with CA Emissions). Check with your state authority for details.

④ Federal Emissions. Not For Sale or Use on vehicles licensed in the state of CA. Check with your state authority.

APPLICATION LISTINGS

FEDERAL CONVERTERS



YR/YRS	CYL	LITER	DESCRIPTION	DIRECT FIT	UNIVERSAL
NISSAN QUEST (Cont.)					
99-00	6	3.3L	California Emissions, Manifold Unit, Front Left	641394 ⑤	--
07-09	6	3.5L	Rear Main Conv.	642244 ③	608265 ③○
07-09	6	3.5L	Front Manifold Conv., Auto Trans.	641314 ③	--
04-09	6	3.5L	Rear Manifold Conv.	641214 ③	--
04-06	6	3.5L	Front Manifold Conv., 5 Speed Auto. Trans.	641314 ③	--
04-06	6	3.5L	Rear Main Conv., w/ 5 Speed Auto Trans.	642244 ③	608265 ③○
04-06	6	3.5L	Front Manifold Conv., 4 Speed Auto Trans.	641315 ③	--
04-06	6	3.5L	Rear Main Conv., 4 Speed Auto Trans.	642264 ③	608265 ③
NISSAN ROGUE					
08-13	4	2.5L	Rear	642053 ③	608415 ③
08-13	4	2.5L	Manifold Unit, Front	641428 ③	--
NISSAN ROGUE SELECT					
14-15	4	2.5L	Federal Emissions, Manifold Unit, Front	641428 ④	--
14-15	4	2.5L	Federal Emissions, Rear	642053 ④	608415 ③
NISSAN SENTRA					
97-99	4	1.6L	GLE, GXE, XE Models	642662 ③	--
95-96	4	1.6L	Front, GLE, GXE, XE Models, California Emissions	642662 ⑤	--
95-96	4	1.6L	Rear, w/O2 Sensor in Conv. Outlet	642574 ③	--
91-95	4	1.6L	w/O2 Sensor in Conv. Inlet	642561 ③	--
91-94	4	1.6L		--	602205 ③
87-90	4	1.6L	w/ Fuel Injection, (Exc. 4WD)	642409 ③	602205 ③
87-88	4	1.6L	w/Carb., 4WD	--	602005 ③
03-06	4	1.8L	Front	641200 ③	--
03-06	4	1.8L		643003 ③	608204 ③
2002	4	1.8L		642793 ③	--
00-02	4	1.8L	Manifold Conv., Exc. CA (Clean Air) Models	642753 ③	--
00-01	4	1.8L	Rear, California Emissions	642793 ③	--
09-12	4	2.0L	Federal Emissions	642800 ③	--
09-12	4	2.0L	California Emissions, Manifold Unit, Front	641432 ⑤	--
09-12	4	2.0L	California Emissions, Rear	642898 ⑤	--
07-08	4	2.0L		642800 ③	--
00-01	4	2.0L	Rear, From 01/00	642793 ③	--
98-00	4	2.0L	To 12/99	642202 ③	608205 ③
91-94	4	2.0L	w/O2 Sensor in Conv. Inlet	642561 ③	--
02-06	4	2.5L	Manifold Unit, Front	641320 ③	--
			Manifold Unit, Front	641198 ③	--
02-03	4	2.5L	Rear, Built to 04/03	642209 ③	--
82-86	4	All	Underbody	642409 ③	602205 ③
NISSAN STANZA					
82-84	4	2.0L		642409 ③	602205 ③
1992	4	2.4L		642409 ③	602205 ③
90-91	4	2.4L		642403 ③	602204 ③
85-89	4	All	w/2-1/4" Pipe, w/o Air Tube, (Exc. Station Wgn. or Van)	642409 ③	602205 ③
85-89	4	All	w/2-1/2" Pipe, w/o Air Tube, (Exc. Station Wgn. or Van)	--	602206 ③
86-88	4	All	Station Wgn. or Van, w/Air Tube	--	602005 ③

- ③ Federal & California Emissions. Not For Sale or Use on vehicles licensed in the state of CA & NY (NY vehicles with CA Emissions). Check with your state authority for details.
- ④ Federal Emissions. Not For Sale or Use on vehicles licensed in the state of CA. Check with your state authority.
- ⑤ California Emissions. Not For Sale or Use on vehicles licensed in the state of CA & NY. Check with your state authority.
- EPA Enhanced OBDII By Design Unit



APPLICATION LISTINGS FEDERAL CONVERTERS

YR/YRS	CYL	LITER	DESCRIPTION	DIRECT FIT	UNIVERSAL
NISSAN TITAN					
07-15	8	5.6L	Rear Right	642115 ③	608405 ③
07-15	8	5.6L	Rear Left	642031 ③	608405 ③
04-06	8	5.6L	Right Manifold Conv.	642075 ③	--
04-06	8	5.6L	Manifold Unit, Left	642074 ③	--
04-06	8	5.6L	Without Flex, US EPA, BIN 8, SULEV Emissions, Right Rear	642115 ③	608405 ③
04-06	8	5.6L	Without Flex, US EPA, BIN 8, SULEV Emissions, Left Rear	642116 ③	608405 ③
NISSAN VAN					
87-88	4	2.4L		--	602005 ③
NISSAN VERSA					
09-11	4	1.6L		642226 ③	608414 ③○
07-12	4	1.8L		642226 ③	608414 ③○
NISSAN X-TRAIL					
07-08	4	2.5L	Manifold Unit, Front	641428 ③	--
NISSAN XTERRA					
01-04	4	2.4L	Front	641234 ③	--
00-04	4	2.4L		642793 ③	608295 ③
02-04	6	3.3L	Front Right Manifold Conv.	641243 ③	--
02-04	6	3.3L	Front Left Manifold Conv.	641244 ③	--
00-04	6	3.3L	Main Right	642736 ③	608204 ③
00-04	6	3.3L	Main Left, w/ 26-3/4" Converter	642737 ③	608204 ③
00-04	6	3.3L	Main Left, w/ 41" Converter	642206 ③	--
00-01	6	3.3L	Front Right	641150 ③	--
00-01	6	3.3L	Front Left	641151 ③	--
2000	6	3.3L	From 1/00 To 9/00, Front Left	--	608204 ③
2000	6	3.3L	From 1/00 To 9/00, Front Right	--	608204 ③
05-10	6	4.0L	Right Front	642138 ③	--
05-10	6	4.0L	Left Front	642124 ③	--
05-10	6	4.0L	Left Rear	642149 ③	608405 ③
05-10	6	4.0L	Right Rear	642150 ③	608405 ③
OLDSMOBILE 98					
1985	6	3.0L		--	602004 ③
95-96	6	3.8L	Code "K" & "L" Eng., 1st Design Front Pipe & Conv. are 1 Piece, Additional sizing, bushings, cutting may be required due to OE exhaust design, # 3 bushing may be required.	642706 ②③	608215 ③
				--	--
				--	--
1995	6	3.8L		--	602205 ③
92-94	6	3.8L	For use with OE intermediate pipe, additional sizing, bushings, cutting may be required due to OE exhaust design, # 3 bushing may be required.	642475 ②③	602206 ③
				--	--
				--	--
92-94	6	3.8L		642771 ②③	602206 ③
1991	6	3.8L	Additional sizing, bushings, cutting may be required due to OE exhaust design.	642475 ②③	602206 ③
				--	--
88-90	6	3.8L	For use with OE intermediate pipe, # 6 bushing may be required with aftermarket pipe.	642360 ②③	602205 ③
				--	--
88-90	6	3.8L	For use with 2-3/8" I.D. aftermarket intermediate pipe.	642657 ③	602205 ③
86-87	6	3.8L	For use with OE intermediate pipe.	642426 ②③	602205 ③
86-87	6	3.8L	For use w/2-3/8" I.D. aftermarket intermediate piping.	--	602205 ③
1985	6	3.8L		--	602004 ③

- ② When using with aftermarket piping, direct fit converter may require INLET/OUTLET pipe resizing.
- ③ Federal & California Emissions. Not For Sale or Use on vehicles licensed in the state of CA & NY (NY vehicles with CA Emissions). Check with your state authority for details.
- EPA Enhanced OBDII By Design Unit

APPLICATION LISTINGS

FEDERAL CONVERTERS



YR/YRS	CYL	LITER	DESCRIPTION	DIRECT FIT	UNIVERSAL
OLDSMOBILE 98 (Cont.)					
81-83	6	4.1L		642352 ☆③	602005③
1984	8	5.0L		642359 ☆③	602005③
81-83	8	5.0L		642352 ☆③	602005③
1980	8	5.0L		--	602205③
1980	8	5.7L		--	602205③
77-79	8	5.7L		--	602206③
1975	8	6.6L		--	604006③
75-76	8	7.5L		--	604006③
OLDSMOBILE ACHIEVA					
93-95	4	2.3L	Quad 4	642490 ③	602214③
93-94	4	2.3L	Code "3", Semi Direct Fit Conv. Must Reuse Front Pipe.	--	602205③
1992	4	2.3L	Code "3" Eng.	--	602203③
1992	4	2.3L	Quad 4, Code "D" Eng.	--	602205③
96-98	4	2.4L	Auto Trans.	642545 ③	608214③
96-97	4	2.4L	Manual Trans.	642728 ③	608215③
1998	6	3.1L	W/Flat Gasket at Manifold	642520 ③	608215③
97-98	6	3.1L	W/Steel Crush Ring Gasket at Manifold	642570 ③	608214③
1996	6	3.1L		642546 ③	608214③
94-95	6	3.1L	Conv. w/Front Pipe	642515 ③	602204③
94-95	6	3.1L	Semi Direct Fit Conv. Must Reuse Front Pipe	--	602204③
92-93	6	3.3L		642456 ③	602205③
OLDSMOBILE ALERO					
02-04	4	2.2L		642730 ③	608214③
99-01	4	2.4L		642572 ③	608215③
99-04	6	3.4L		642547 ③	608215③
OLDSMOBILE AURORA					
01-02	6	3.5L	Use w/OE Pipe, Includes Resonator	645979 ③	--
01-03	8	4.0L	Use w/OE Pipe, Includes Resonator	645979 ③	--
96-99	8	4.0L	Models w/4 Bolt Flange Inlet, 2nd design front pipe & conv. separate, for use with OE intermediate pipe, additional sizing, bushings, cutting may be required due to OE exhaust design, # 3 bushing may be required.	645357 ②③	608226③
				--	--
				--	--
96-99	8	4.0L	Models w/4 Bolt Flange Inlet, 2nd design front pipe & conv. separate, for use with aftermarket intermediate pipe, additional sizing, bushings, cutting may be required due to OE exhaust design.	645410 ②③	608226③
				--	--
				--	--
1995	8	4.0L		642718 ③	608216③
OLDSMOBILE BRAVADA					
02-04	6	4.2L		645878 ③	608226③
00-01	6	4.3L	California Emissions	645890 ⑤	--
00-01	6	4.3L	Front, California Emissions	--	608416⑤
00-01	6	4.3L	Rear, California Emission	--	608227⑤
2000	6	4.3L	Federal Emissions	645891 ④	608227④
98-99	6	4.3L	Front, California Emissions	641166 ⑤	608294⑤
98-99	6	4.3L	Rear	642514 ③	608226③
96-97	6	4.3L		642514 ③	608226③
92-94	6	4.3L	Code "W"	645356 ③	609006③
91-92	6	4.3L	Code "Z"	642335 ③	609006③

☆ Air Tube kit 4948 may be required for installation.

② When using with aftermarket piping, direct fit converter may require INLET/OUTLET pipe resizing.

③ Federal & California Emissions. Not For Sale or Use on vehicles licensed in the state of CA & NY (NY vehicles with CA Emissions). Check with your state authority for details.

④ Federal Emissions. Not For Sale or Use on vehicles licensed in the state of CA. Check with your state authority.

⑤ California Emissions. Not For Sale or Use on vehicles licensed in the state of CA & NY. Check with your state authority.



APPLICATION LISTINGS FEDERAL CONVERTERS

YR/YRS	CYL	LITER	DESCRIPTION	DIRECT FIT	UNIVERSAL
OLDSMOBILE CALAIS					
90-91	4	2.3L		--	602205③
88-89	4	2.3L		--	602205③
90-91	4	2.5L		642459 ③	602204③
90-91	4	2.5L	Optional Direct Fit Converter	--	602204③
85-89	4	2.5L	Additional sizing, bushings, cutting may be required due to OE exhaust design, Two # 8 bushings may be required.	642357 ②③	602204③
85-88	6	3.0L	Additional sizing, bushings, cutting may be required due to OE exhaust design, Two # 8 bushings may be required.	642357 ②③	602204③
90-91	6	3.3L		642456 ③	602205③
1989	6	3.3L		--	602215③
OLDSMOBILE CIERA					
1996	4	2.2L	Ciera & Ciera Cruiser	642921 ③	608215③
93-95	4	2.2L	Ciera & Ciera Cruiser	642921 ③	602214③
86-92	4	2.5L	Conv. Only w/o Front Pipe	642374 ☆②③	602004③
86-92	4	2.5L	Conv. w/Front Pipe	642954 ③	602004③
82-85	4	2.5L		--	602004③
86-89	6	2.8L	Conv. Only w/o Front Pipe	642374 ☆②③	602004③
86-89	6	2.8L	Conv. w/Front Pipe	--	602004③
1996	6	3.1L		642971 ③	608215③
94-95	6	3.1L		642971 ③	602215③
89-93	6	3.3L		642416 ③	602205③
86-88	6	3.8L	Conv. Only w/o Front Pipe	642374 ☆②③	602004③
86-88	6	3.8L	Conv. w/Front Pipe, w/o Air Tube	--	602204③
82-85	6	All		--	602004③
OLDSMOBILE CUTLASS					
90-91	4	2.3L	For use with OE intermediate pipe, additional sizing, bushings, cutting may be required due to OE exhaust design, # 6 bushing may be required at inlet & # 8 bushing may be required at outlet for use w/aftermarket pipe.	642370 ②③	602205③
90-91	4	2.3L	For use w/2-1/8" I.D. aftermarket intermediate piping, additional sizing, bushings, cutting may be required due to OE exhaust design.	642524 ②③	602205③
88-89	6	2.8L	For use with OE intermediate pipe, additional sizing, bushings, cutting may be required due to OE exhaust design, # 6 bushing may be required at inlet & # 8 bushing may be required at outlet for use w/aftermarket pipe.	642370 ②③	602205③
88-89	6	2.8L	For use w/2-1/8" I.D. aftermarket intermediate piping, additional sizing, bushings, cutting may be required due to OE exhaust design.	642524 ②③	602205③
98-99	6	3.1L		642547 ③	608215③
1997	6	3.1L	Supreme	642949 ③	608215③
1997	6	3.1L		--	608215③
1996	6	3.1L		--	608215③
95-96	6	3.1L	Models w/Post Conv. O2 Sensor	642569 ③	608215③
94-95	6	3.1L	(Exc. Models w/Post Conv. O2 Sensor)	642474 ③	602214③
90-93	6	3.1L	Supreme, Dual Exhaust	642678 ③	609004③

☆ Air Tube kit 4948 may be required for installation.

② When using with aftermarket piping, direct fit converter may require INLET/OUTLET pipe resizing.

③ Federal & California Emissions. Not For Sale or Use on vehicles licensed in the state of CA & NY (NY vehicles with CA Emissions). Check with your state authority for details.

APPLICATION LISTINGS

FEDERAL CONVERTERS



YR/YRS	CYL	LITER	DESCRIPTION	DIRECT FIT	UNIVERSAL
OLDSMOBILE CUTLASS (Cont.)					
89-93	6	3.1L	(Exc. Dual Exhaust), For use with OE intermediate pipe, additional sizing, bushings, cutting may be required due to OE exhaust design, # 6 bushing may be required at inlet & # 8 bushing may be required at outlet for use w/aftermarket pipe.	642370 ②③ -- -- --	602205 ③ -- -- --
89-93	6	3.1L	(Exc. Dual Exhaust), For use w/2-1/8" I.D. aftermarket intermediate piping, additional sizing, bushings, cutting may be required due to OE exhaust design.	642524 ②③ -- --	602205 ③ -- --
1996	6	3.4L		642614 ③	608216 ③
91-95	6	3.4L		642509 ③	602206 ③
83-87	6	3.8L		642353 ☆③	602005 ③
1983	6	3.8L	California Emissions	642352 ☆⑤	602005 ⑤
81-82	6	3.8L		--	602005 ③
1980	6	3.8L		--	602206 ③
78-79	6	3.8L		642352 ☆③	602005 ③
1977	6	3.8L		--	602206 ③
75-76	6	4.1L		--	602206 ③
81-82	8	4.3L		642352 ☆③	602005 ③
1980	8	4.3L		--	602005 ③
78-79	8	4.3L		642352 ☆③	602005 ③
75-77	8	4.3L		--	602206 ③
83-88	8	5.0L		642353 ☆③	602005 ③
81-82	8	5.0L		642352 ☆③	602005 ③
1980	8	5.0L		--	602206 ③
78-79	8	5.0L	(Exc. '78 305 C.I.D., w/2 bbl Carb.)	--	602206 ③
1978	8	5.0L	w/2 bbl Carb.	--	602005 ③
1980	8	5.7L		--	602206 ③
78-79	8	5.7L		--	602206 ③
75-77	8	5.7L		--	602206 ③
1977	8	6.6L		--	604006 ③
1976	8	7.5L		--	604006 ③
OLDSMOBILE EIGHTY-EIGHT, DELTA 88					
1986	6	3.0L	For use with OE intermediate pipe.	642426 ②③	602205 ③
1986	6	3.0L	For use with 2-3/8" I.D. aftermarket intermediate pipe.	--	602205 ③
97-99	6	3.8L	Models w/4 Bolt Flange Inlet, front pipe & conv. separate, for use with OE intermediate pipe, additional sizing, bushings, cutting may be required due to OE exhaust design, # 3 bushing may be required.	645357 ②③ -- -- --	608226 ③ -- -- --
97-99	6	3.8L	Models w/4 Bolt Flange Inlet, front pipe & conv. separate, for use with aftermarket intermediate pipe, additional sizing, bushings, cutting may be required due to OE exhaust design.	645410 ②③ -- --	608226 ③ -- --
95-96	6	3.8L	Front Pipe & Conv. are 1 Piece, Code "K" Eng., Additional sizing, bushings, cutting may be required due to OE exhaust design, # 3 bushing may be required.	642706 ②③ -- --	608226 ③ -- --
92-94	6	3.8L	For use with OE intermediate pipe, additional sizing, bushings, cutting may be required due to OE exhaust design, # 3 bushing may be required.	642475 ②③ -- --	602206 ③ -- --
92-94	6	3.8L		642771 ②③	602206 ③

☆ Air Tube kit 4948 may be required for installation.

② When using with aftermarket piping, direct fit converter may require INLET/OUTLET pipe resizing.

③ Federal & California Emissions. Not For Sale or Use on vehicles licensed in the state of CA & NY (NY vehicles with CA Emissions). Check with your state authority for details.

⑤ California Emissions. Not For Sale or Use on vehicles licensed in the state of CA & NY. Check with your state authority.



APPLICATION LISTINGS FEDERAL CONVERTERS

YR/YRS	CYL	LITER	DESCRIPTION	DIRECT FIT	UNIVERSAL
OLDSMOBILE EIGHTY-EIGHT, DELTA 88 (Cont.)					
88-91	6	3.8L	For use with OE intermediate pipe, additional sizing, bushings, cutting may be required due to OE exhaust design, # 6 bushing may be required with aftermarket pipe.	642360 ②③ -- --	602205 ③ -- --
88-91	6	3.8L	For use with 2-3/8" I.D. aftermarket intermediate pipe.	642657 ③	602205 ③
86-87	6	3.8L	For use with OE intermediate pipe.	642426 ②③	602205 ③
86-87	6	3.8L	For use with 2-3/8" I.D. aftermarket intermediate pipe.	--	602205 ③
77-79	6	3.8L		--	602206 ③
83-84	6	All		642353 ☆③	602205 ③
81-82	6	All		642352 ☆③	602005 ③
1980	6	All	w/o Air Tube	--	602206 ③
1980	6	All	w/Air Tube	--	602006 ③
84-90	8	5.0L	Station Wgn.	--	609005 ③
84-90	8	5.0L	Optional Direct Fit Converter	642359 ☆③	602005 ③
84-85	8	5.0L	(Exc. Station Wgn.)	642359 ☆③	602005 ③
81-83	8	5.0L		642352 ☆③	602005 ③
1980	8	5.7L	Code "R"	--	602005 ③
75-76	8	7.5L		--	604006 ③
77-79	8	All		--	602206 ③
75-76	8	All	(Exc. 455 C.I.D.)	--	602206 ③
OLDSMOBILE FIRENZA					
82-86	4	All		--	602003 ③
1987	6	2.8L	Additional sizing, bushings, cutting may be required due to OE exhaust design.	642357 ②③ --	602204 ③ --
85-86	6	2.8L		--	602204 ③
OLDSMOBILE INTRIGUE					
99-02	6	3.5L		642787 ③	608215 ③
98-99	6	3.8L	Code "K" Eng. Code "K" Eng.	642583 ③ --	608416 ③○ 608214 ③□
OLDSMOBILE OMEGA					
82-84	4	2.5L		--	602004 ③
1981	4	2.5L		--	602003 ③
1980	4	2.5L		--	602004 ③
83-84	6	2.8L		--	602004 ③
1982	6	2.8L	(Exc. Code "Z" Eng.)	--	602004 ③
1982	6	2.8L	Code "Z" Eng.	642395 ☆③	602005 ③
1981	6	2.8L		--	602003 ③
1980	6	2.8L		--	602004 ③
75-79	6,8	All		--	602205 ③
OLDSMOBILE REGENCY					
97-98	6	3.8L	Models w/4 Bolt Flange Inlet, front pipe & conv. separate, for use with OE intermediate pipe, additional sizing, bushings, cutting may be required due to OE exhaust design, # 3 bushing may be required.	645357 ②③ -- -- --	608226 ③ -- -- --
97-98	6	3.8L	Models w/4 Bolt Flange Inlet, front pipe & conv. separate, for use with aftermarket intermediate pipe, additional sizing, bushings, cutting may be required due to OE exhaust design.	645410 ②③ -- --	608226 ③ -- --

☆ Air Tube kit 4948 may be required for installation.

② When using with aftermarket piping, direct fit converter may require INLET/OUTLET pipe resizing.

③ Federal & California Emissions. Not For Sale or Use on vehicles licensed in the state of CA & NY (NY vehicles with CA Emissions). Check with your state authority for details.

□ EPA OBDII By Design Unit

○ EPA Enhanced OBDII By Design Unit

APPLICATION LISTINGS

FEDERAL CONVERTERS



YR/YRS	CYL	LITER	DESCRIPTION	DIRECT FIT	UNIVERSAL
OLDSMOBILE SILHOUETTE					
93-94	6	3.1L		642972 ③	609005 ③
90-92	6	3.1L	Conv., w/Front Pipe	--	609005 ③
90-92	6	3.1L	Conv. Only	--	609005 ③
02-04	6	3.4L	FWD	642988 ③	608226 ③
2001	6	3.4L		643007 ③	608226 ③
97-00	6	3.4L		642941 ③	608215 ③
1996	6	3.4L		642920 ③	608226 ③
93-95	6	3.8L		642948 ③	609005 ③
OLDSMOBILE STARFIRE					
77-80	4	All		--	602205 ③
75-80	6,8	All		--	602205 ③
OLDSMOBILE TORONADO					
91-92	6	3.8L	For use with OE intermediate pipe, additional sizing, bushings, cutting may be required due to OE exhaust design.	--	602006 ③
91-92	6	3.8L		--	602006 ③
88-90	6	3.8L	Additional sizing, bushings, cutting may be required due to OE exhaust design, two # 6 bushings may be required (1 at inlet & 1 at outlet).	--	602204 ③
86-87	6	3.8L	For use with OE intermediate pipe, # 6 bushing may be required with aftermarket pipe.	642360 ②③	602205 ③
86-87	6	3.8L	For use with 2-3/8" I.D. aftermarket intermediate pipe.	642657 ③	602205 ③
1984	6	4.1L		642353 ☆③	602005 ③
81-83	6	4.1L		642352 ☆③	602005 ③
84-85	8	5.0L		642359 ☆③	602005 ③
81-83	8	5.0L		642352 ☆③	602005 ③
1980	8	5.7L	Code "R"	--	602205 ③
77-79	8	5.7L		--	602206 ③
77-78	8	6.6L		--	604006 ③
75-76	8	7.5L		--	604006 ③
OPEL OPEL					
76-78	4	1.8L		642380 ③	602206 ③
PASSPORT I-MARK					
85-89	4	1.5L	Rear, (Canada Model)	--	602206 ③
85-89	4	1.5L	Optional Direct Fit Converter (Canada Model)	642380 ③	--
PASSPORT IMPULSE					
90-92	4	1.6L	Rear, (Canada Model)	--	602206 ③
90-92	4	1.6L	Optional Direct Fit Converter (Canada Model)	642380 ③	--
PASSPORT OPTIMA					
88-91	4	1.6L	(Canada Model)	--	602204 ③
89-91	4	2.0L	(Canada Model)	--	602205 ③
PASSPORT STYLUS					
91-93	4	1.6L	(Canada Model)	642380 ③	602206 ③
PEUGEOT 405					
89-91	4	All	w/O2 Sensor in Pipe, Semi-Direct Fit, fabrication required	--	602205 ③
PEUGEOT 504					
77-79	4	2.0L		--	602203 ③

☆ Air Tube kit 4948 may be required for installation.

② When using with aftermarket piping, direct fit converter may require INLET/OUTLET pipe resizing.

③ Federal & California Emissions. Not For Sale or Use on vehicles licensed in the state of CA & NY (NY vehicles with CA Emissions). Check with your state authority for details.



APPLICATION LISTINGS FEDERAL CONVERTERS

YR/YRS	CYL	LITER	DESCRIPTION	DIRECT FIT	UNIVERSAL
PEUGEOT 505					
80-85	4	2.0L	w/28-3/4" Conv., (Exc. Turbo)	--	602203③
80-83	4	2.0L	21" Conv., (Exc. Turbo)	--	602204③
1991	4	2.2L		--	602204③
87-90	4	2.2L	Turbo Station Wgn.	--	602205③
87-89	6	2.8L		--	602205③
PEUGEOT 604					
77-78	6	2.7L	Left	--	602214③
77-78	6	2.7L	Right	--	602214③
79-81	6	2.8L		--	602204③
PLYMOUTH ACCLAIM					
90-95	4	2.5L	(Exc. Turbo)	642320 ☆③	602004③
1990	4	2.5L	Turbo	--	602005③
1989	4	2.5L	(Exc. Turbo), w/Auto Trans.	642320 ③	602004③
92-95	6	3.0L		642576 ③	602205③
89-91	6	3.0L	Conv. includes Resonator	642388 ③	602205③
PLYMOUTH ARROW					
78-80	4	All		--	602203③
PLYMOUTH ARROW PICKUP					
79-82	4	All		--	602204③
PLYMOUTH B-VAN					
80-83	6	3.7L	Underbody	--	609004③
75-79	6	3.7L	2" Outlet	--	602205③
80-83	8	5.2L	Underbody	--	609006③
80-83	8	5.2L	Main & Pre-Cat	--	609006③
80-83	8	5.9L	Underbody	--	609006③
80-83	8	5.9L	Main & Pre-Cat	--	609006③
80-81	8	All	w/o Pre-Cat	--	609005③
75-79	8	All		--	605006③
PLYMOUTH BREEZE					
98-00	4	2.0L		642768 ③	608204③
96-97	4	2.0L		642675 ③	608235③
98-00	4	2.4L		642533 ③	608235③
PLYMOUTH CARAVELLE					
1988	4	2.2L	Auto Trans., Built After 10/12/87, (Exc. Turbo)	642506 ☆③	602004③
87-88	4	2.2L	Turbo	--	602206③
1986	4	2.2L	Turbo	--	602205③
1986	4	2.2L	Auto Trans., (Exc. Turbo)	--	602004③
1985	4	2.2L	(Exc. Turbo)	--	602004③
1985	4	2.2L	Turbo	--	602205③
87-88	4	2.5L		642506 ☆③	602004③
1986	4	2.5L		642506 ☆③	602004③
1985	4	2.6L		--	602204③
PLYMOUTH CHAMP					
81-82	4	All	Rear	--	602204③
81-82	4	All	Main & Pre-Cat	--	602004③
79-80	4	All		--	602204③

☆ Air Tube kit 4948 may be required for installation.

③ Federal & California Emissions. Not For Sale or Use on vehicles licensed in the state of CA & NY (NY vehicles with CA Emissions). Check with your state authority for details.

APPLICATION LISTINGS

FEDERAL CONVERTERS



YR/YRS	CYL	LITER	DESCRIPTION	DIRECT FIT	UNIVERSAL
PLYMOUTH COLT					
81-84	4	1.4L		--	602204③
89-91	4	1.5L		642403 ③	602204③
87-88	4	1.5L		642385 ③	602214③
85-86	4	1.5L	Rear	--	602204③
89-90	4	1.6L		642403 ③	602204③
87-88	4	1.6L		642385 ③	602214③
81-86	4	1.6L		--	602204③
89-90	4	1.8L		--	602204③
89-91	4	2.0L	Vista	642403 ③	602204③
87-88	4	2.0L	Vista, Built After 12/86	642403 ③	602204③
1987	4	2.0L	Vista, Built Before 12/86	--	602204③
84-86	4	2.0L	Vista	--	602204③
92-94	4	All	Includes Vista	642403 ③	602204③
PLYMOUTH CONQUEST					
84-86	4	2.6L	Turbo, Rear	--	602204③
PLYMOUTH DUSTER					
75-76	6	3.7L		--	602204③
75-76	8	All		--	602205③
PLYMOUTH EXPO					
87-89	4	2.2L	(Canada Model)	--	602004③
PLYMOUTH FURY, GRAN FURY					
81-83	6	3.7L	Underbody	--	602004③
81-83	6	3.7L	Main & Pre-Cat	--	602004③
1980	6	3.7L	4 Dr., Rear	--	602004③
1980	6	3.7L	4 Dr., Main & Pre-Cat	--	602004③
1978	6	3.7L	2 Dr.	--	602205③
1978	6	3.7L	4 Dr. or Station Wgn.	--	602205③
81-89	8	5.2L	Underbody	--	602005③
81-89	8	5.2L	Main & Pre-Cat	--	602005③
1980	8	5.2L	4 Dr. or Station Wgn.	--	602205③
1980	8	5.2L	California Emissions	--	602205⑤
77-78	8	5.2L	2 Dr.	--	602205③
77-78	8	5.2L	4 Dr. or Station Wgn.	--	602205③
75-76	8	5.2L		--	609006③
1978	8	5.9L	2 Dr.	--	602205③
1978	8	5.9L	4 Dr. or Station Wgn.	--	602205③
75-76	8	5.9L		--	609006③
75-78	8	6.6L		--	609006③
75-76	8	7.2L	Single Exhaust	--	605006③
75-76	8	7.2L	Left, Dual Exhaust	--	605006③
75-76	8	7.2L	Right, Dual Exhaust	--	605006③
PLYMOUTH HORIZON					
83-86	4	1.6L	Front	--	602004③
83-84	4	1.6L		--	602204③
82-83	4	1.7L	Front	--	602004③
82-83	4	1.7L		--	602204③
1981	4	1.7L	Front	--	602004③

③ Federal & California Emissions. Not For Sale or Use on vehicles licensed in the state of CA & NY (NY vehicles with CA Emissions). Check with your state authority for details.
 ⑤ California Emissions. Not For Sale or Use on vehicles licensed in the state of CA & NY. Check with your state authority.



APPLICATION LISTINGS FEDERAL CONVERTERS

YR/YRS	CYL	LITER	DESCRIPTION	DIRECT FIT	UNIVERSAL
PLYMOUTH HORIZON (Cont.)					
80-81	4	1.7L		--	602004③
1980	4	1.7L	Front Mini-Ox Conv.	--	602214③
78-79	4	1.7L		--	602004③
88-90	4	2.2L	Semi-Direct Fit, fabrication required - Outlet Pipe	--	602004③
81-87	4	2.2L	Front	--	602004③
81-82	4	2.2L		--	602004③
PLYMOUTH LASER					
90-94	4	All		642403 ③	602204③
PLYMOUTH NEON					
00-01	4	2.0L	w/2-1/4" OD Outlet, Exc. ULEV	642594 ③	608215③
00-01	4	2.0L	w/2" OD Outlet, Federal Emissions TLEV, Exc. ULEV	642292 ④	608215④
00-01	4	2.0L	ULEV, VIN C, Rear	642843 ③	--
98-99	4	2.0L	OBDII Equipped, Federal Emissions, Exc. LEV	642478 ④	608205④
95-97	4	2.0L	OBDII Equipped, Federal Emissions	642478 ④	608205④
PLYMOUTH PROWLER					
97-99	6	3.5L	Code "F", Main Conv.	--	608234③
PLYMOUTH RELIANT					
1989	4	2.2L		--	602004③
1988	4	2.2L	Auto Trans, Built After 10/12/87	642506 ☆③	602004③
87-88	4	2.2L	Manual Trans.	642506 ☆③	602004③
1986	4	2.2L	Manual Trans.	--	602004③
1986	4	2.2L	Auto Trans.	--	602004③
1985	4	2.2L	Exc. Fuel Injection	--	602004③
1985	4	2.2L	Fuel Injection	--	602004③
81-84	4	2.2L	Front, w/ Air Tube	--	602004③
81-82	4	2.2L	Rear, w/Air Tube	--	602004③
81-82	4	2.2L	Front, w/o Air Tube	--	602204③
1989	4	2.5L	Auto Trans.	642506 ☆③	602004③
87-88	4	2.5L		642506 ☆③	602004③
1986	4	2.5L		642506 ☆③	602004③
83-85	4	2.6L		--	602204③
81-82	4	2.6L		--	602204③
PLYMOUTH SAPPORO					
78-79	4	1.6L		--	602204③
81-83	4	2.6L		--	602206③
PLYMOUTH SCAMP					
1983	4	2.2L		--	602204③
PLYMOUTH SUNDANCE, DUSTER					
1994	4	2.2L		642320 ☆③	602004③
90-93	4	2.2L		642320 ☆③	602004③
1989	4	2.2L		642320 ☆③	602004③
87-88	4	2.2L	(Exc. Turbo)	642320 ☆③	602004③
87-88	4	2.2L	Turbo	--	602205③
1994	4	2.5L		642320 ☆③	602004③
89-93	4	2.5L	(Exc. Turbo)	642320 ☆③	602004③
89-91	4	2.5L	Turbo	--	602205③
93-94	6	3.0L		642576 ③	602205③

☆ Air Tube kit 4948 may be required for installation.

③ Federal & California Emissions. Not For Sale or Use on vehicles licensed in the state of CA & NY (NY vehicles with CA Emissions). Check with your state authority for details.

④ Federal Emissions. Not For Sale or Use on vehicles licensed in the state of CA. Check with your state authority.

APPLICATION LISTINGS

FEDERAL CONVERTERS



YR/YRS	CYL	LITER	DESCRIPTION	DIRECT FIT	UNIVERSAL
PLYMOUTH TRAILDUSTER					
1980	6	3.7L	Underbody	--	609005 [ⓐ]
78-79	6	3.7L		--	602205 [ⓐ]
75-80	8	5.2L		--	609006 [ⓐ]
75-80	8	5.9L		--	609006 [ⓐ]
1976	8	6.6L		--	604006 [ⓐ]
80-81	8	All	2WD, Rear	--	609006 [ⓐ]
80-81	8	All	4WD, Rear	--	609006 [ⓐ]
PLYMOUTH TURISMO					
83-85	4	1.6L		--	602004 [ⓐ]
1983	4	1.6L		--	602004 [ⓐ]
PLYMOUTH VALIANT, SCAMP					
75-76	6	3.7L		--	602204 [ⓐ]
75-76	8	5.2L	2 Dr. Coupe	--	602205 [ⓐ]
1976	8	5.9L		--	602205 [ⓐ]
75-76	8	All	(Exc. 2 Dr. Coupe w/318 C.I.D.)	--	602205 [ⓐ]
PLYMOUTH VOLARE					
1980	6	3.7L	2 Dr., Rear	--	602204 [ⓐ]
1980	6	3.7L	2 Dr., Main & Pre-Cat	--	602004 [ⓐ]
1980	6	3.7L	4 Dr. or Station Wgn., Rear	--	602204 [ⓐ]
1980	6	3.7L	4 Dr. or Station Wgn., Main & Pre-Cat	--	602004 [ⓐ]
1979	6	3.7L	2 Dr., Rear	--	602004 [ⓐ]
1979	6	3.7L	2 Dr., Main & Pre-Cat	--	602004 [ⓐ]
1979	6	3.7L	4 Dr. or Station Wgn., Rear	--	602204 [ⓐ]
1979	6	3.7L	4 Dr. or Station Wgn., Main & Pre-Cat	--	602004 [ⓐ]
1978	6	3.7L	2 Dr.	--	602205 [ⓐ]
1978	6	3.7L	4 Dr. or Station Wgn.	--	602205 [ⓐ]
1977	6	3.7L	2 Dr., 2-1/4" Pipe	--	602205 [ⓐ]
1977	6	3.7L	2 Dr., 1-7/8" Pipe	--	602204 [ⓐ]
1977	6	3.7L	4 Dr. or Station Wgn., 2-1/4" Pipe	--	602205 [ⓐ]
1977	6	3.7L	4 Dr. or Station Wgn., 1-7/8" Pipe	--	602204 [ⓐ]
1976	6	3.7L	2 Dr.	--	602204 [ⓐ]
1976	6	3.7L	4 Dr. or Station Wgn.	--	602204 [ⓐ]
79-80	8	5.2L	2 Dr., Rear	--	602205 [ⓐ]
79-80	8	5.2L	2 Dr., Main Plus Pre-Cat	--	602005 [ⓐ]
79-80	8	5.2L	4 Dr. or Station Wgn., Rear	--	602205 [ⓐ]
79-80	8	5.2L	4 Dr. or Station Wgn., Main Plus Pre Cat	--	602005 [ⓐ]
76-78	8	5.2L	2 Dr.	--	602205 [ⓐ]
76-78	8	5.2L	4 Dr. or Station Wgn.	--	602205 [ⓐ]
79-80	8	5.9L	Left	--	602205 [ⓐ]
79-80	8	5.9L	Right	--	602205 [ⓐ]
76-78	8	5.9L	2 Dr.	--	602205 [ⓐ]
76-78	8	5.9L	4 Dr. or Station Wgn.	--	602205 [ⓐ]
PLYMOUTH VOYAGER					
84-87	4	2.2L		--	602204 [ⓐ]
96-00	4	2.4L		642969 [ⓐ]	608235 [ⓐ]
89-95	4	2.5L	(Exc. Turbo)	642521 [ⓐ]	602204 [ⓐ]
89-90	4	2.5L	Turbo	--	602205 [ⓐ]

[ⓐ] Federal & California Emissions. Not For Sale or Use on vehicles licensed in the state of CA & NY (NY vehicles with CA Emissions). Check with your state authority for details.



APPLICATION LISTINGS FEDERAL CONVERTERS

YR/YRS	CYL	LITER	DESCRIPTION	DIRECT FIT	UNIVERSAL
PLYMOUTH VOYAGER (Cont.)					
1988	4	2.5L		642521 ③	602204 ③
84-87	4	2.6L	w/Front Conv.	--	602204 ③
84-87	4	2.6L	w/Rear Conv.	--	602204 ③
96-00	6	3.0L		642951 ③	608235 ③
92-95	6	3.0L		642591 ③	609005 ③
89-91	6	3.0L		642505 ③	602205 ③
87-88	6	3.0L		--	602205 ③
96-00	6	3.3L	Federal Emissions	642969 ④	608235 ④
96-00	6	3.3L	California Emissions	642967 ⑤	608235 ⑤
94-95	6	3.3L	AWD	642932 ③	609006 ③
94-95	6	3.3L	(Exc. AWD or Flexible Fuel)	642591 ③	609005 ③
92-93	6	3.3L	(Exc. AWD)	642479 ③	602205 ③
91-93	6	3.3L	AWD	642932 ③	609006 ③
90-91	6	3.3L	(Exc. AWD)	642417 ③	602205 ③
96-99	6	3.8L	Federal Emissions	642969 ④	608235 ④
96-99	6	3.8L	California Emissions	642967 ⑤	608235 ⑤
94-95	6	3.8L	AWD	642932 ③	609006 ③
94-95	6	3.8L	(Exc. AWD or Flexible Fuel)	642591 ③	609005 ③
PONTIAC 6000					
86-91	4	2.5L	Conv. Only	642374 ☆②③	602004 ③
86-91	4	2.5L	Conv. w/Front Pipe, w/o Air Tube	642954 ③	602204 ③
82-85	4	2.5L		--	602004 ③
86-89	6	2.8L	Conv. Only	642374 ☆②③	602004 ③
86-89	6	2.8L	Conv. w/Front Pipe	--	602004 ③
82-85	6	2.8L		--	602004 ③
90-91	6	3.1L	(Exc. AWD), Converter Only	642374 ☆②③	602004 ③
1990	6	3.1L	AWD	--	602204 ③
PONTIAC ACADIAN					
81-87	4	1.6L		--	602004 ③
76-80	4	All		--	602205 ③
PONTIAC ASTRE					
76-77	4	2.3L		--	602205 ③
1975	4	2.3L	w/o Air Tube	--	602205 ③
1975	4	2.3L	w/Air Tube	--	602005 ③
1977	4	2.5L		--	602205 ③
PONTIAC AZTEK					
01-05	6	3.4L	AWD	642981 ③	608215 ③
01-05	6	3.4L	FWD	643055 ③	608265 ③
PONTIAC BONNEVILLE					
00-05	6	3.8L	(Exc. Supercharged, Use w/OE Pipe, Includes Resonator)	645979 ③	608227 ③
00-05	6	3.8L	For use with Aftermarket pipes, additional sizing, bushings, cutting may be required due to OE exhaust design.	645288 ③	608227 ③
98-99	6	3.8L	Supercharged	--	608227 ③
97-99	6	3.8L	Models w/4 Bolt Flange Inlet, front pipe & conv. separate, for use with OE intermediate pipe, additional sizing, bushings, cutting may be required due to OE exhaust design, # 3 bushing may be required.	645357 ②③	608226 ③
				--	--
				--	--
				--	--

☆ Air Tube kit 4948 may be required for installation.

② When using with aftermarket piping, direct fit converter may require INLET/OUTLET pipe resizing.

③ Federal & California Emissions. Not For Sale or Use on vehicles licensed in the state of CA & NY (NY vehicles with CA Emissions). Check with your state authority for details.

④ Federal Emissions. Not For Sale or Use on vehicles licensed in the state of CA. Check with your state authority.

202 ⑤ California Emissions. Not For Sale or Use on vehicles licensed in the state of CA & NY. Check with your state authority.

APPLICATION LISTINGS

FEDERAL CONVERTERS



YR/YRS	CYL	LITER	DESCRIPTION	DIRECT FIT	UNIVERSAL
PONTIAC BONNEVILLE (Cont.)					
97-99	6	3.8L	Models w/4 Bolt Flange Inlet, front pipe & conv. separate, for use with aftermarket intermediate pipe, additional sizing, bushings, cutting may be required due to OE exhaust design.	645410 ②③ -- --	608226 ③ -- --
95-96	6	3.8L	Code "K" Eng., front pipe & conv. 1 piece, additional sizing, bushings, cutting may be required due to OE exhaust design, # 3 bushing may be required.	642706 ②③ -- --	608226 ③ -- --
93-95	6	3.8L	Supercharged	--	609006 ③
92-94	6	3.8L	(Exc. Supercharged), For use with OE intermediate pipe, additional sizing, bushings, cutting may be required due to OE exhaust design, # 3 bushing may be required.	642475 ②③ -- --	602206 ③ -- --
92-94	6	3.8L	(Exc. Supercharged), For use with aftermarket intermediate pipe, additional sizing, bushings, cutting may be required due to OE exhaust design.	642771 ②③ -- --	602206 ③ -- --
92-93	6	3.8L	SSE, Additional sizing, bushings, cutting may be required due to OE exhaust design.	645375 ☆②③ --	609005 ③ --
88-91	6	3.8L	For use with OE intermediate pipe, # 6 bushing may be required with aftermarket pipe.	642360 ②③ --	602205 ③ --
88-91	6	3.8L	For use w/2-3/8" I.D. aftermarket intermediate piping.	642657 ③	602205 ③
1987	6	3.8L	For use with OE intermediate pipe.	642426 ②③	602205 ③
1987	6	3.8L	For use w/2-3/8" I.D. intermediate piping.	--	602205 ③
84-86	6	3.8L		642353 ☆③	602005 ③
1983	6	3.8L	California Emissions	642352 ☆⑤	602005 ⑤
1983	6	3.8L	Federal Emissions	642353 ☆④	602005 ④
1980	6	3.8L		--	602206 ③
1986	6	4.3L		642395 ☆③	602005 ③
81-82	6	All		--	602005 ③
04-05	8	4.6L	Use w/OE Pipe, Includes Resonator	645979 ③	608227 ③
1980	8	4.9L		--	602006 ③
84-86	8	5.0L		642355 ☆③	602005 ③
1980	8	5.7L	Code "X"	--	602006 ③
1980	8	5.7L	Code "R"	--	602005 ③
77-78	8	6.6L	400 C.I.D.	--	604006 ③
75-76	8	6.6L		--	604006 ③
75-76	8	7.5L		--	604006 ③
81-83	8	All		642352 ☆③	602005 ③
77-79	8	All	(Exc. 400 C.I.D.)	--	602206 ③
PONTIAC CATALINA					
1980	6	3.8L		--	602206 ③
77-79	6	3.8L		--	602206 ③
1981	6	All		642352 ☆③	602005 ③
1980	8	4.9L		--	602006 ③
1980	8	5.7L	Code "X"	--	602006 ③
1980	8	5.7L	Code "R"	--	602005 ③
1976	8	5.7L		--	602206 ③
77-78	8	6.6L	400 C.I.D.	--	604006 ③
75-76	8	6.6L		--	604006 ③
75-76	8	7.5L		--	604006 ③

☆ Air Tube kit 4948 may be required for installation.

② When using with aftermarket piping, direct fit converter may require INLET/OUTLET pipe resizing.

③ Federal & California Emissions. Not For Sale or Use on vehicles licensed in the state of CA & NY (NY vehicles with CA Emissions). Check with your state authority for details.

④ Federal Emissions. Not For Sale or Use on vehicles licensed in the state of CA. Check with your state authority.

⑤ California Emissions. Not For Sale or Use on vehicles licensed in the state of CA & NY. Check with your state authority.



APPLICATION LISTINGS FEDERAL CONVERTERS

YR/YRS	CYL	LITER	DESCRIPTION	DIRECT FIT	UNIVERSAL
PONTIAC CATALINA (Cont.)					
1981	8	All		642352 ☆③	602005③
77-79	8	All	(Exc. 400 C.I.D.)	--	602206③
PONTIAC FIERO					
87-88	4	2.5L		--	602004③
84-86	4	2.5L		--	602003③
87-88	6	2.8L		--	602004③
85-86	6	2.8L		--	602003③
PONTIAC FIREBIRD, TRANS AM, FORMULA					
82-85	4	2.5L		--	602004③
1982	6	2.8L		--	602005③
93-95	6	3.4L		642433 ③	602205③
00-01	6	3.8L		642994 ③	608226③
2000	6	3.8L	Federal Emissions	642994 ③	608226③
95-99	6	3.8L		642933 ③	608235③
1981	6	3.8L	231 C.I.D.	642352 ☆③	602005③
1980	6	3.8L	231 C.I.D.	--	602005③
77-79	6	3.8L		--	602205③
75-76	6	4.1L		--	602205③
83-92	6	All		642355 ☆③	602005③
1981	8	4.3L		642352 ☆③	602005③
1981	8	4.9L	Includes Turbo	642352 ☆③	602005③
1980	8	4.9L	(Exc. High Performance)	--	602206③
1980	8	4.9L	High Performance	--	604006③
1979	8	4.9L		--	604005③
1977	8	4.9L		--	604005③
90-92	8	5.0L	Code "E" & "F", (Exc. Dual Conv. System & 2 3/4" Ext. Pipe)	642355 ☆③	602005③
89-92	8	5.0L	Code "F", Dual Conv. System, Left, Additional sizing, bushings, cutting may be required due to OE exhaust design.	--	609005③
89-92	8	5.0L	Code "F", Dual Conv. System, Right, Additional sizing, bushings, cutting may be required due to OE exhaust design.	--	--
89-92	8	5.0L	Code "F", Dual Conv. System, Complete	--	609005③
86-89	8	5.0L	Code "F" & "G", (Exc. Dual Conv. System)	645307 ☆③	609007③
83-89	8	5.0L	Code "E" & "H", (83-87 Code H) & (88-89 Code E)	642355 ☆③	602005③
84-85	8	5.0L	Code "F" & "G"	642356 ☆③	602006③
1983	8	5.0L	Code "7"	642356 ☆③	602006③
1983	8	5.0L	Code "S"	642355 ☆③	602005③
1982	8	5.0L	Code "7"	642355 ☆③	602005③
1982	8	5.0L	Code "H", Angled Conv.	--	609005③
1982	8	5.0L	Code "H", Straight Conv.	--	609005③
1981	8	5.0L	(Exc. Trans Am)	642352 ☆③	602005③
1981	8	5.0L	Code "H", Trans Am	--	602205③
1980	8	5.0L		--	602206③
77-79	8	5.0L		--	602205③
00-02	8	5.7L	Left	645408 ③	--
00-02	8	5.7L	Right	645407 ③	--
98-99	8	5.7L	Left	645374 ③	--
98-99	8	5.7L	Right	645978 ③	--

☆ Air Tube kit 4948 may be required for installation.

③ Federal & California Emissions. Not For Sale or Use on vehicles licensed in the state of CA & NY (NY vehicles with CA Emissions). Check with your state authority for details.

APPLICATION LISTINGS

FEDERAL CONVERTERS



YR/YRS	CYL	LITER	DESCRIPTION	DIRECT FIT	UNIVERSAL
PONTIAC FIREBIRD, TRANS AM, FORMULA (Cont.)					
96-97	8	5.7L		645945 ③	608226 ③
96-97	8	5.7L	Front	645363 ③	--
1995	8	5.7L	Federal Emissions	645354 ④	605007 ④
1995	8	5.7L	Rear, California Emissions	645945 ⑤	604006 ⑤
1995	8	5.7L	Front, California Emissions	645363 ⑤	--
93-94	8	5.7L		645354 ③	605007 ③
89-92	8	5.7L	Code "8", Dual Conv. System, Left, Additional sizing, bushings, cutting may be required due to OE exhaust design.	--	609005 ③
89-92	8	5.7L	Code "8", Dual Conv. System, Right, Additional sizing, bushings, cutting may be required due to OE exhaust design.	--	609005 ③
89-92	8	5.7L	Code "8", Dual Conv. System, Complete	--	609005 ③
87-89	8	5.7L	(Exc. Dual Conv. System)	645307 ☆③	609007 ③
75-79	8	5.7L		--	604005 ③
78-79	8	6.6L	403 C.I.D., Single Exhaust	--	604005 ③
78-79	8	6.6L	403 C.I.D., Dual Exhaust	--	604005 ③
77-79	8	6.6L	400 C.I.D., Single Exhaust	--	604005 ③
77-79	8	6.6L	400 C.I.D., Dual Exhaust	--	604005 ③
75-77	8	6.6L	400 C.I.D.	--	604005 ③
PONTIAC FIREFLY					
1995	3	1.0L	Rear, (Canada Model)	642917 ③	602204 ③
1991	3	1.0L	(Exc. Turbo) (Canada Model)	642904 ③	602204 ③
89-91	3	1.0L	Turbo (Canada Model)	--	602204 ③
87-88	3	1.0L	Turbo (Canada Model)	--	602204 ③
85-88	3	1.0L	(Exc. Turbo) (Canada Model)	642904 ③	602204 ③
96-97	4	1.3L	(Canada Model)	642934 ③	602204 ③
93-95	4	1.3L	Rear, (Canada Model)	--	602204 ③
PONTIAC G3					
09-10	4	1.6L	Rear	642021 ③	--
PONTIAC G5					
08-09	4	2.2L	Manual Trans.	--	608265 ③○
08-09	4	2.2L	Auto Trans.	642061 ③	608265 ③
2007	4	2.2L	Auto Trans.	642780 ③	608264 ③○
2007	4	2.2L	Manual Trans.	--	608265 ③○
2008	4	2.4L	Auto Trans.	642061 ③	608265 ③○
2008	4	2.4L	Manual Trans.	--	608265 ③
2007	4	2.4L	Auto Trans.	642780 ③	608264 ③○
2007	4	2.4L	Manual Trans.	--	608265 ③○
PONTIAC G6					
09-10	4	2.4L	6 Speeds, Front	644013 ③	--
08-10	4	2.4L	Rear, OE exhaust system is completely welded, additional adapters or sizing of the OE pipe may be required to complete installation.	642060 ③	--
06-10	4	2.4L	Manifold Unit, Front	642198 ③⑩	--
			Manifold Unit, Front	641343 ③	--
08-10	6	3.5L	Front Manifold Conv., Exc. GT Convertible Models	641277 ③	--
08-10	6	3.5L	Rear Manifold Conv., Exc. GT Convertible Models	641278 ③	--
08-10	6	3.5L	Rear, OE exhaust system is completely welded, additional adapters or sizing of the OE pipe may be required to complete installation.	642080 ③	--

- ⑩ Discontinued, use until inventory is depleted.
- ☆ Air Tube kit 4948 may be required for installation.
- ③ Federal & California Emissions. Not For Sale or Use on vehicles licensed in the state of CA & NY (NY vehicles with CA Emissions). Check with your state authority for details.
- ④ Federal Emissions. Not For Sale or Use on vehicles licensed in the state of CA. Check with your state authority.
- ⑤ California Emissions. Not For Sale or Use on vehicles licensed in the state of CA & NY. Check with your state authority.
- EPA Enhanced OBDII By Design Unit



APPLICATION LISTINGS FEDERAL CONVERTERS

YR/YRS	CYL	LITER	DESCRIPTION	DIRECT FIT	UNIVERSAL
PONTIAC G6 (Cont.)					
2007	6	3.5L	Front Right	644012 ③	--
05-06	6	3.5L	Front	642229 ③	608274 ③
05-06	6	3.5L	Rear Conv.	642069 ③	--
07-08	6	3.6L	Front Conv.	642144 ③	--
07-08	6	3.6L	Rear Conv.	642093 ③	--
06-07	6	3.9L	Front Right	644012 ③	--
PONTIAC G8					
08-09	8	6.0L	Left	--	608326 ③
08-09	8	6.0L	Right	--	608326 ③
08-09	8	6.0L	Left	645182 ③	--
08-09	8	6.0L	Right	645183 ③	--
2009	8	6.2L	Left	--	608326 ③
2009	8	6.2L	Right	--	608326 ③
PONTIAC GRAND AM					
87-89	4	2.0L	Turbo	--	602005 ③
02-05	4	2.2L		642730 ③	608215 ③
93-95	4	2.3L	Quad 4, Code "D" Eng.	642490 ③	602214 ③
1992	4	2.3L	Code "3" Eng.	--	602203 ③
90-92	4	2.3L	Quad 4, Code "D" Eng.	--	602205 ③
1989	4	2.3L	Quad 4, Code "D" Eng., additional sizing, bushings, cutting may be required due to OE exhaust design, # 6 bushing may be required.	--	602205 ③
1988	4	2.3L	Quad 4, Code "D" Eng., additional sizing, bushings, cutting may be required due to OE exhaust design.	--	602205 ③
99-01	4	2.4L	SE Models, 2nd Design Built After 1/99 (inlet flange 3 bolt)	642572 ③	608215 ③
1999	4	2.4L	1st Design built up to 1/99 (Inlet flange 4 bolt)	642671 ③	608214 ③
96-98	4	2.4L	Auto Trans.	642545 ③	608214 ③
96-98	4	2.4L	Manual Trans.	642728 ③	608215 ③
90-91	4	2.5L		642459 ③	602204 ③
90-91	4	2.5L	Optional Direct Fit Converter	--	602204 ③
85-89	4	2.5L	Additional sizing, bushings, cutting may be required due to OE exhaust design, two # 8 bushings may be required.	642357 ②③	602204 ③
85-87	6	3.0L	Additional sizing, bushings, cutting may be required due to OE exhaust design, two # 8 bushings may be required.	642357 ②③	602204 ③
97-98	6	3.1L		642570 ③	608214 ③
1996	6	3.1L		642546 ③	608214 ③
94-95	6	3.1L		642515 ③	602214 ③
92-93	6	3.3L		642456 ③	602205 ③
2005	6	3.4L	GT	642547 ③	608214 ③
99-04	6	3.4L		642547 ③	608214 ③
78-79	8	4.9L		--	602205 ③
1979	8	5.0L	4 bbl. Carb.	--	602206 ③
1978	8	5.0L	2 bbl. Carb.	642352 ☆③	602205 ③
1980	8	All		--	602006 ③
1975	8	All		--	604006 ③

☆ Air Tube kit 4948 may be required for installation.

② When using with aftermarket piping, direct fit converter may require INLET/OUTLET pipe resizing.

③ Federal & California Emissions. Not For Sale or Use on vehicles licensed in the state of CA & NY (NY vehicles with CA Emissions). Check with your state authority for details.

APPLICATION LISTINGS

FEDERAL CONVERTERS



YR/YRS	CYL	LITER	DESCRIPTION	DIRECT FIT	UNIVERSAL
PONTIAC GRAND PRIX					
90-91	4	2.3L	For use with OE intermediate pipe, additional sizing, bushings, cutting may be required due to OE exhaust design, # 6 bushing may be required at inlet & # 8 bushing may be required at outlet for use w/aftermarket pipe.	642370 ②③ -- -- --	602205 ③ -- -- --
90-91	4	2.3L	For use w/2-1/8" I.D. intermediate piping, additional sizing, bushings, cutting may be required due to OE exhaust design.	642524 ②③ --	602205 ③ --
88-89	6	2.8L	For use with OE intermediate pipe, additional sizing, bushings, cutting may be required due to OE exhaust design, # 6 bushing may be required at inlet & # 8 bushing may be required at outlet for use w/aftermarket pipe.	642370 ②③ -- -- --	602205 ③ -- -- --
88-89	6	2.8L	For use w/2-1/8" I.D. intermediate piping, additional sizing, bushings, cutting may be required due to OE exhaust design.	642524 ②③ --	602205 ③ --
97-03	6	3.1L		642525 ③	608215 ③
95-96	6	3.1L	Models w/Post Conv. O2 Sensor	642569 ③	608215 ③
94-95	6	3.1L	(Exc. Models w/Post Conv. O2 Sensor)	642474 ③	602214 ③
1993	6	3.1L	California Emissions w/Dual Exhaust	--	602205 ⑤
90-93	6	3.1L	Dual Exhaust, 1990 2nd Design	642678 ③	609004 ③
89-93	6	3.1L	(Exc. Dual Exhaust), For use with OE intermediate pipe, additional sizing, bushings, cutting may be required due to OE exhaust design, # 6 bushing may be required at inlet & # 8 bushing may be required at outlet for use w/aftermarket pipe.	642370 ②③ -- -- --	602205 ③ -- -- --
89-93	6	3.1L	(Exc. Dual Exhaust), For use w/2-1/8" I.D. aftermarket intermediate piping, additional sizing, bushings, cutting may be required due to OE exhaust design.	642524 ②③ -- --	602205 ③ -- --
89-90	6	3.1L	Dual Exhaust, 1990 1st Design, For use with OE intermediate pipe, Additional sizing, bushings, cutting may be required due to OE exhaust design, # 6 bushing may be required at inlet & # 8 bushing may be required at outlet for use w/aftermarket pipe.	642370 ②③ -- -- --	602205 ③ -- -- --
89-90	6	3.1L	Dual Exhaust, 1990 1st Design, For use w/2-1/8" I.D. intermediate piping, Additional sizing, bushings, cutting may be required due to OE exhaust design.	642524 ②③ -- --	602205 ③ -- --
1996	6	3.4L		642614 ③	608216 ③
94-95	6	3.4L		642509 ③	602206 ③
91-93	6	3.4L		642509 ③	602206 ③
04-08	6	3.8L		642278 ③ --	608405 ③○ 608294 ③□
97-03	6	3.8L		642583 ③ --	608416 ③○ 608216 ③□
84-87	6	3.8L		642353 ☆③	602005 ③
1983	6	3.8L	Federal Emissions	642353 ☆④	602005 ④
1983	6	3.8L	California Emissions	642352 ☆⑤	602205 ⑤
1981	6	3.8L		642352 ☆③	602205 ③
1980	6	3.8L		--	602206 ③
1979	6	3.8L		--	602205 ③
86-87	6	4.3L		642395 ☆③	602005 ③
1982	6	All		642352 ☆③	602205 ③
78-79	8	4.9L		642352 ☆③	602205 ③

☆ Air Tube kit 4948 may be required for installation.

② When using with aftermarket piping, direct fit converter may require INLET/OUTLET pipe resizing.

③ Federal & California Emissions. Not For Sale or Use on vehicles licensed in the state of CA & NY (NY vehicles with CA Emissions). Check with your state authority for details.

④ Federal Emissions. Not For Sale or Use on vehicles licensed in the state of CA. Check with your state authority.

⑤ California Emissions. Not For Sale or Use on vehicles licensed in the state of CA & NY. Check with your state authority.

□ EPA OBDII By Design Unit

○ EPA Enhanced OBDII By Design Unit



APPLICATION LISTINGS FEDERAL CONVERTERS

YR/YRS	CYL	LITER	DESCRIPTION	DIRECT FIT	UNIVERSAL
PONTIAC GRAND PRIX (Cont.)					
84-87	8	5.0L	Code 'H' Eng.	642355 ☆③	602005③
1979	8	5.0L		--	602206③
1978	8	5.0L		--	602205③
05-08	8	5.3L	GXP Model	642101 ③	--
81-83	8	All		642352 ☆③	602205③
1980	8	All		--	602206③
76-77	8	All	(Exc. 400, 403, & 455 C.I.D.)	--	602206③
75-77	8	All	400, 403, & 455 C.I.D.	--	604006③
PONTIAC GRANDVILLE					
1975	8	6.6L		--	604006③
PONTIAC GTO					
2004	8	5.7L	Left	--	608265③○
2004	8	5.7L	Right	--	608265③○
05-06	8	6.0L	Right Side with Extension Pipe	642140 ③	--
05-06	8	6.0L	Left Side	642141 ③	--
PONTIAC J2000					
1984	4	1.8L	Turbo	--	602004③
82-84	4	1.8L	(Exc. Turbo)	--	602003③
PONTIAC LE MANS					
90-93	4	1.6L		--	602206③
88-89	4	1.6L	Auto Trans.	--	602004③
88-89	4	1.6L	Manual Trans.	--	602004③
1989	4	2.0L	Manual Trans.	--	602004③
1989	4	2.0L	Auto Trans.	--	602204③
1981	6	3.8L	(Exc. Canada)	642352 ☆③	602005③
1980	6	3.8L	231 C.I.D., (Exc. Canada)	--	602006③
1980	6	3.8L	229 C.I.D., (Exc. Canada)	--	602005③
78-79	6	3.8L	(Exc. Canada)	--	602205③
78-83	6	All	(Canada Model)	--	602005③
75-77	6	All	(Exc. Canada)	--	602206③
1981	8	4.3L	(Exc. Canada)	642352 ☆③	602005③
1976	8	4.3L	(Exc. Canada)	--	602206③
1979	8	4.9L	(Exc. Canada)	--	602005③
1977	8	4.9L	(Exc. Canada)	--	602206③
1979	8	5.0L	4 bbl. Carb. (Exc. Canada)	--	602206③
1978	8	5.0L	2 bbl. Carb. (Exc. Canada)	642352 ☆③	602005③
78-79	8	5.7L	(Exc. Canada)	--	602206③
75-77	8	5.7L	(Exc. Canada)	--	602206③
1977	8	6.6L	403 C.I.D., (Exc. Canada)	--	604006③
75-77	8	6.6L	400 C.I.D., (Exc. Canada)	--	604006③
75-76	8	7.5L	(Exc. Canada)	--	604006③
1980	8	All	(Exc. Canada)	--	602206③
PONTIAC MONTANA					
02-05	6	3.4L	FWD	642988 ③	608226③
2001	6	3.4L		643007 ③	608226③
99-00	6	3.4L		642941 ③	608215③
05-06	6	3.5L	FWD	643017 ③	608286③

☆ Air Tube kit 4948 may be required for installation.

③ Federal & California Emissions. Not For Sale or Use on vehicles licensed in the state of CA & NY (NY vehicles with CA Emissions). Check with your state authority for details.

○ EPA Enhanced OBDII By Design Unit

APPLICATION LISTINGS

FEDERAL CONVERTERS



YR/YRS	CYL	LITER	DESCRIPTION	DIRECT FIT	UNIVERSAL
PONTIAC MONTANA (Cont.)					
07-08	6	3.9L		643029 ③	608285 ③○
PONTIAC OPTIMA					
88-91	4	1.6L	(Canada Model)	--	602204 ③
88-90	4	2.0L	(Canada Model)	--	602205 ③
PONTIAC PARIISIENNE					
84-85	6	3.8L	(Exc. Canada)	642353 ☆③	602005 ③
1986	6	4.3L	(Exc. Canada)	642395 ☆③	602005 ③
77-82	6	All	(Canada Model)	--	602005 ③
1986	8	5.0L	Code "Y", (Exc. Station Wgn.), Recommended For Sound Control (Exc. Canada)	--	609005 ③
1986	8	5.0L	Code "Y", (Exc. Station Wgn.), Optional Direct Fit Converter (Exc. Canada)	642359 ③	602005 ③
85-86	8	5.0L	Code "H", Recommended For Sound Control (Exc. Canada)	645310 ③	609005 ③
85-86	8	5.0L	Code "H", Optional Direct Fit Converter (Exc. Canada)	642355 ③	602005 ③
76-80	8	All	(Canada Model)	--	602205 ③
PONTIAC PHOENIX					
82-84	4	2.5L		--	602004 ③
1981	4	2.5L		--	602003 ③
1980	4	2.5L		--	602204 ③
83-84	6	2.8L	Code "W", "X" & "Z" Eng.	--	602004 ③
1982	6	2.8L	(Exc. Code "Z" Eng.)	--	602004 ③
1982	6	2.8L	Code "Z" Eng.	642395 ☆③	602005 ③
1981	6	2.8L		--	602003 ③
1980	6	2.8L		--	602204 ③
77-79	6,8	All		--	602205 ③
PONTIAC SAFARI STATION WAGON					
87-89	8	5.0L		--	609005 ③
87-89	8	5.0L	Optional Direct Fit Converter	642359 ☆③	602005 ③
PONTIAC SUNBIRD					
85-86	4	1.8L	Turbo	--	602005 ③
85-86	4	1.8L	(Exc. Turbo)	--	602003 ③
90-94	4	2.0L	(Exc. 1990 Turbo)	642412 ③	602204 ③
90-94	4	2.0L	(Exc. 1990 Turbo), Optional Direct Fit Converter	--	602204 ③
1990	4	2.0L	Turbo	--	602004 ③
1989	4	2.0L	(Exc. Turbo), Additional sizing, bushings, cutting may be required due to OE exhaust design.	642357 ②③	602204 ③
87-89	4	2.0L	Turbo	--	602005 ③
87-88	4	2.0L	(Exc. Turbo)	--	602004 ③
78-80	4	2.5L		--	602205 ③
1977	4	2.5L		--	602205 ③
91-94	6	3.1L	Additional sizing, bushings, cutting may be required due to OE exhaust design.	642357 ②③	602204 ③
76-80	6	All		--	602205 ③
PONTIAC SUNBURST					
87-89	4	1.5L	Rear, (Exc. Turbo) (Canada Model)	--	602206 ③
85-86	4	1.5L	(Exc. Turbo) (Canada Model)	--	602206 ③

☆ Air Tube kit 4948 may be required for installation.

② When using with aftermarket piping, direct fit converter may require INLET/OUTLET pipe resizing.

③ Federal & California Emissions. Not For Sale or Use on vehicles licensed in the state of CA & NY (NY vehicles with CA Emissions). Check with your state authority for details.

○ EPA Enhanced OBDII By Design Unit



APPLICATION LISTINGS FEDERAL CONVERTERS

YR/YRS	CYL	LITER	DESCRIPTION	DIRECT FIT	UNIVERSAL
PONTIAC SUNFIRE					
03-05	4	2.2L		642730 ③	608214 ③
2002	4	2.2L	Code F Eng.	642730 ③	608214 ③
2002	4	2.2L	Code 4 Eng.	642924 ③	608214 ③
99-01	4	2.2L		642924 ③	608214 ③
96-98	4	2.2L		642476 ③	608204 ③
99-02	4	2.4L		642572 ③	608214 ③
96-98	4	2.4L		642671 ③	608214 ③
PONTIAC T1000					
81-87	4	1.6L		--	602004 ③
PONTIAC TEMPEST					
87-91	4	All	Manual Trans. (Canada Model)	--	602204 ③
87-91	4	All	Auto Trans. (Canada Model)	--	602204 ③
87-91	6	All	(Canada Model)	--	602004 ③
PONTIAC TORRENT					
06-09	6	3.4L		642754 ③	608226 ③
08-09	6	3.6L	Front Conv.	642221 ③	608405 ③○
08-09	6	3.6L	Rear Conv.	642220 ③	608405 ③○
PONTIAC TRANS SPORT					
93-95	6	3.1L		642972 ③	609005 ③
90-92	6	3.1L	Conv., w/Front Pipe	--	609005 ③
90-92	6	3.1L	Conv. Only	--	609005 ③
97-98	6	3.4L		642941 ③	608214 ③
1996	6	3.4L		642920 ③	608226 ③
93-95	6	3.8L		642948 ③	609005 ③
PONTIAC VENTURA					
1977	4	2.5L		--	602205 ③
75-77	6,8	All		--	602205 ③
PONTIAC VIBE					
05-08	4	1.8L	FWD, (Exc. GT), Requires Resonator Pipe #58494 to Complete Installation	642165 ③	--
05-08	4	1.8L	FWD, (Exc. GT), Front	--	608265 ③
05-08	4	1.8L	FWD, (Exc. GT), Rear	--	608265 ③
03-06	4	1.8L	AWD, Complete Assembly Including Resonator Pipe	643114 ③	--
03-04	4	1.8L	FWD, (Exc. GT), Complete Assembly Including Resonator Pipe	642985 ③	--
03-04	4	1.8L	FWD, (Exc. GT), Requires Resonator Pipe #68432 to Complete Installation	642165 ③	--
03-04	4	1.8L	FWD, (Exc. GT), Rear	--	608265 ③
03-04	4	1.8L	FWD, (Exc. GT), Front	--	608265 ③
2003	4	1.8L	GT, Complete Assembly Including Resonator Pipe	643120 ③	--
09-10	4	2.4L	Manifold Unit, Front	641400 ③	--
09-10	4	2.4L	Base, Rear, OE is a Welded Assembly, 68542 Pipe Required to Complete Installation	642820 ③	--
2009	4	2.4L		--	608265 ③○
PORSCHE 911					
78-83	6	3.0L		--	602205 ③
84-89	6	3.2L		--	602205 ③
86-89	6	3.3L	Turbo	--	602205 ③

③ Federal & California Emissions. Not For Sale or Use on vehicles licensed in the state of CA & NY (NY vehicles with CA Emissions). Check with your state authority for details.

○ EPA Enhanced OBDII By Design Unit

APPLICATION LISTINGS

FEDERAL CONVERTERS



YR/YRS	CYL	LITER	DESCRIPTION	DIRECT FIT	UNIVERSAL
PORSCHE 911 (Cont.)					
1995	6	3.6L	Left	--	608214 [Ⓢ]
1995	6	3.6L	Right	--	608214 [Ⓢ]
90-94	6	3.6L		--	602214 [Ⓢ]
PORSCHE 914					
1975	4	1.8L		--	602204 [Ⓢ]
PORSCHE 924					
80-82	4	2.0L	Turbo	--	602214 [Ⓢ]
80-82	4	2.0L	(Exc. Turbo)	--	602214 [Ⓢ]
77-79	4	2.0L		--	602214 [Ⓢ]
87-88	4	2.5L	"S" Models	--	602204 [Ⓢ]
PORSCHE 928					
78-82	8	4.5L		--	609005 [Ⓢ]
83-84	8	4.7L		--	609005 [Ⓢ]
90-91	8	5.0L	Left	--	602214 [Ⓢ]
90-91	8	5.0L	Right	--	602214 [Ⓢ]
87-89	8	5.0L		--	602005 [Ⓢ]
85-86	8	5.0L		--	602005 [Ⓢ]
93-95	8	5.4L	Left	--	602214 [Ⓢ]
93-95	8	5.4L	Right	--	602214 [Ⓢ]
PORSCHE 944					
86-88	4	2.5L	(Exc. Turbo)	--	602204 [Ⓢ]
1989	4	2.7L	(Exc. Turbo)	--	602204 [Ⓢ]
90-91	4	3.0L		--	609005 [Ⓢ]
PORSCHE 968					
92-94	4	3.0L		--	602205 [Ⓢ]
RAM 1500					
11-12	8	5.7L		645224 [Ⓢ]	--
RENAULT ALLIANCE					
83-87	4	1.4L		--	602204 [Ⓢ]
85-87	4	1.7L		--	602204 [Ⓢ]
1987	4	All	GTA	--	602204 [Ⓢ]
RENAULT ENCORE					
84-86	4	1.4L		--	602204 [Ⓢ]
85-86	4	1.7L		--	602204 [Ⓢ]
RENAULT FUEGO					
82-83	4	1.6L	(Exc. Turbo)	--	602204 [Ⓢ]
84-85	4	2.2L	(Exc. Turbo)	--	602204 [Ⓢ]
83-84	4	All	Turbo	--	602294 [Ⓢ]
RENAULT LECAR					
78-79	4	1.3L		--	602203 [Ⓢ]
80-84	4	1.4L		--	602203 [Ⓢ]
RENAULT R12, R15					
75-77	4	1.6L		--	602204 [Ⓢ]
RENAULT R17, GORDINI					
75-79	4	1.6L		--	602203 [Ⓢ]
RENAULT R18I					
81-83	4	1.6L		--	602204 [Ⓢ]
84-86	4	2.2L	Sportwagon	--	602204 [Ⓢ]

Ⓢ Federal & California Emissions. Not For Sale or Use on vehicles licensed in the state of CA & NY (NY vehicles with CA Emissions). Check with your state authority for details.



APPLICATION LISTINGS FEDERAL CONVERTERS

YR/YRS	CYL	LITER	DESCRIPTION	DIRECT FIT	UNIVERSAL
SAAB 9-2X					
2005	4	2.5L		642291 ③	--
SAAB 9-3					
10-11	4	2.0L	FWD, 4Dr., w/o Chrome Tailpipe, Rear	642873 ③	--
09-11	4	2.0L	FWD, Exc. 14mm Air Tube, Front	641401 ③	--
04-09	4	2.0L	Rear	642873 ③	--
05-08	4	2.0L	Chassis/VIN 51013750, Exc.14mm Air Tube, Front	641401 ③	--
03-05	4	2.0L	Turbo	--	608265 ③○
2003	4	2.0L	Arc, Linear & Vector, Rear	642873 ③	--
00-02	4	2.0L	From Chassis/VIN 17008105, California Emissions	642855 ⑤	--
00-02	4	2.3L		642855 ③	--
99-02	4	All	Turbo	645382 ③	--
2009	6	2.8L	FWD, Rear	642896 ③	--
06-08	6	2.8L	Rear	642896 ③	--
SAAB 9-5					
04-09	4	2.3L		--	608265 ③○
00-03	4	2.3L		642711 ③	--
1999	4	2.3L	Turbo	645387 ③	608234 ③
99-03	6	3.0L		642962 ③	--
SAAB 9-7X					
08-09	6	4.2L		645185 ③	--
06-07	6	4.2L		645864 ③	608206 ③
06-09	8	5.3L		645186 ③	--
2005	8	5.3L		645265 ③	608286 ③
08-09	8	6.0L		645186 ③	--
SAAB 900					
96-98	4	2.0L	Turbo	645382 ③	608235 ③
94-95	4	2.0L	Turbo	--	609004 ③
91-93	4	2.0L		642507 ③	602216 ③
88-90	4	2.0L	Turbo	--	602215 ③
88-90	4	2.0L	Turbo, Optional Direct Fit Converter	642507 ③	--
88-89	4	2.0L	DOHC 16 valve, (Exc. Turbo)	--	602213 ③
1988	4	2.0L	SOHC, (Exc. Turbo)	--	602214 ③
86-87	4	2.0L	DOHC, (Exc. Turbo)	--	602213 ③
85-87	4	2.0L	DOHC, Turbo	--	602215 ③
85-87	4	2.0L	DOHC, Turbo, Optional Direct Fit Converter	642507 ③	--
81-87	4	2.0L	SOHC	--	602214 ③
1994	4	2.1L	(Exc. Turbo)	--	609004 ③
91-93	4	2.1L		642507 ③	602216 ③
96-98	4	2.3L		--	608206 ③
94-95	4	2.3L	Auto Trans.	--	609004 ③
94-95	4	2.3L	Manual Trans.	--	609004 ③
79-80	4	All		--	602214 ③
1996	6	2.5L	24 valve	--	608235 ③
94-95	6	2.5L	24 valve	--	609005 ③
SAAB 9000					
86-90	4	2.0L		--	602204 ③
96-98	4	2.3L	Turbo w/DOHC, Eng. Codes "R" or "M"	642670 ③	608206 ③

③ Federal & California Emissions. Not For Sale or Use on vehicles licensed in the state of CA & NY (NY vehicles with CA Emissions). Check with your state authority for details.

⑤ California Emissions. Not For Sale or Use on vehicles licensed in the state of CA & NY. Check with your state authority.

○ EPA Enhanced OBDII By Design Unit

APPLICATION LISTINGS

FEDERAL CONVERTERS



YR/YRS	CYL	LITER	DESCRIPTION	DIRECT FIT	UNIVERSAL
SAAB 9000 (Cont.)					
93-95	4	2.3L	Turbo, DOHC	--	609005 [Ⓞ]
90-92	4	2.3L		--	602204 [Ⓞ]
96-97	6	3.0L		--	608234 [Ⓞ]
1995	6	3.0L		--	608234 [Ⓞ]
SAAB 99					
77-80	4	2.0L	(Exc. Turbo)	--	602204 [Ⓞ]
1978	4	2.0L	Turbo	--	602214 [Ⓞ]
75-76	4	2.0L		--	602204 [Ⓞ]
SATURN AURA					
08-09	4	2.4L	Rear, OE exhaust system is completely welded, additional adapters or sizing of the OE pipe may be required to complete installation.	642060 [Ⓞ]	--
07-09	4	2.4L	Manifold Unit, Front	642198 ^{ⓄⓄ}	--
			Manifold Unit, Front	641343 [Ⓞ]	--
2007	6	3.5L	Front Left	642229 [Ⓞ]	608274 [Ⓞ]
2007	6	3.5L	Front Right	644012 [Ⓞ]	--
07-08	6	3.6L	Front Conv.	642144 [Ⓞ]	--
07-08	6	3.6L	Rear Conv.	642093 [Ⓞ]	--
SATURN ION					
05-07	4	2.0L		642089 [Ⓞ]	--
05-07	4	2.2L	Auto Trans.	642780 [Ⓞ]	608264 ^{ⓄⓄ}
			Auto Trans.	--	608215 ^{Ⓞ□}
03-04	4	2.2L		642241 [Ⓞ]	608414 ^{ⓄⓄ}
06-07	4	2.4L	Auto Trans.	642780 [Ⓞ]	608264 ^{ⓄⓄ}
			Auto Trans.	--	608215 ^{Ⓞ□}
SATURN L100					
01-04	4	2.2L	Complete, Auto Trans.	642699 [Ⓞ]	608214 [Ⓞ]
01-02	4	2.2L	Standard Trans.	644010 [Ⓞ]	--
SATURN L200					
01-04	4	2.2L	Complete, Auto Trans.	642699 [Ⓞ]	608214 [Ⓞ]
01-03	4	2.2L	Standard Trans.	644010 [Ⓞ]	--
SATURN L300					
00-05	6	3.0L	Front	641192 [Ⓞ]	--
00-05	6	3.0L	Rear	642294 [Ⓞ]	--
SATURN LW200					
01-04	4	2.2L	Complete, Auto Trans.	642699 [Ⓞ]	608214 [Ⓞ]
01-03	4	2.2L	Standard Trans.	644010 [Ⓞ]	--
SATURN LW300					
00-05	6	3.0L	Front	641192 [Ⓞ]	--
00-05	6	3.0L	Rear	642294 [Ⓞ]	--
SATURN OUTLOOK					
09-10	6	3.6L	Rear Main Conv.	642044 [Ⓞ]	--
07-10	6	3.6L	Front Conv.	642125 [Ⓞ]	--
07-10	6	3.6L	Rear Conv.	642126 [Ⓞ]	--
SATURN RELAY					
05-06	6	3.5L	FWD	643017 [Ⓞ]	608286 ^{ⓄⓄ}
2007	6	3.9L		643029 [Ⓞ]	608285 ^{ⓄⓄ}
2006	6	3.9L	FWD	643017 [Ⓞ]	608286 ^{ⓄⓄ}

- Ⓞ Discontinued, use until inventory is depleted.
- Ⓞ Federal & California Emissions. Not For Sale or Use on vehicles licensed in the state of CA & NY (NY vehicles with CA Emissions). Check with your state authority for details.
- EPA OBDII By Design Unit
- EPA Enhanced OBDII By Design Unit



APPLICATION LISTINGS FEDERAL CONVERTERS

YR/YRS	CYL	LITER	DESCRIPTION	DIRECT FIT	UNIVERSAL
SATURN SC					
91-92	4	1.9L	For use with OE intermediate pipe, additional sizing, bushings, cutting may be required due to OE exhaust design.	--	602205 ^③
91-92	4	1.9L		--	602205 ^③
SATURN SC1					
01-02	4	1.9L	Semi Direct Fit Conv., SOHC, Must Reuse Front Pipe, additional sizing, bushings, cutting may be required due to OE exhaust design.	642795 ^③	608234 ^③
01-02	4	1.9L	Front, SOHC	641246 ^③	--
01-02	4	1.9L	Rear, SOHC, Includes Front Pipe	642239 ^③	608205 ^③
2000	4	1.9L	Semi Direct Fit Conv., SOHC, Must Reuse Front Pipe, additional sizing, bushings, cutting may be required due to OE exhaust design.	642795 ^③	608234 ^③
1999	4	1.9L	Semi Direct Fit Conv., Federal Emissions, SOHC, Use Aftermarket Front Pipe 38857 or Must Reuse Front Pipe, additional sizing, bushings, cutting may be required due to OE exhaust design.	642795 ^③ ✧	608234 ^③
98-99	4	1.9L	Complete Assembly, SOHC, Includes Front Pipe, California Emissions	642289 ^⑤	608204 ^⑤
96-99	4	1.9L	Complete Assembly, SOHC, Includes Front Pipe, Federal Emissions	642727 ^④	608204 ^④
1998	4	1.9L	2 Piece Design, Federal Emissions, SOHC, Use Aftermarket Front Pipe 38857 or Must Reuse Front Pipe, Additional sizing, bushings, cutting may be required due to OE exhaust design.	642795 ^④ ✧	608234 ^④
96-98	4	1.9L	2 Piece Design, SOHC, Use Aftermarket Front Pipe 38857 or Must Reuse Front Pipe, Additional sizing, bushings, cutting may be required due to OE exhaust design.	642795 ^③ ✧	608234 ^③
93-95	4	1.9L	Complete Assembly, SOHC, Includes Front Pipe	642666 ^③	602204 ^③
93-95	4	1.9L	2 Piece Design, SOHC, Use Aftermarket Front Pipe 38857 or Must Reuse Front Pipe, Additional sizing, bushings, cutting may be required due to OE exhaust design.	642795 ^③ ✧	602204 ^③
SATURN SC2					
2002	4	1.9L	Semi Direct Fit Conv., DOHC, Must Reuse Front Pipe, additional sizing, bushings, cutting may be required due to OE exhaust design.	642795 ^③	608234 ^③
01-02	4	1.9L	Front, DOHC	641211 ^③	--
01-02	4	1.9L	Rear, DOHC, Includes Front Pipe	642284 ^③	608204 ^③
2001	4	1.9L	Semi Direct Fit Conv., Late Models w/DOHC, Must Reuse Front Pipe, additional sizing, bushings, cutting may be required due to OE exhaust design.	642795 ^③	608234 ^③
2001	4	1.9L	Semi Direct Fit Conv., Early Models w/DOHC, Must Reuse Front Pipe, additional sizing, bushings, cutting may be required due to OE exhaust design.	642795 ^③	608234 ^③
2000	4	1.9L	Semi Direct Fit Conv., DOHC, Must Reuse Front Pipe, additional sizing, bushings, cutting may be required due to OE exhaust design.	642795 ^③	608234 ^③
99-00	4	1.9L	Front, DOHC, California Emissions	641211 ^⑤	--
1999	4	1.9L	Semi Direct Fit Conv., DOHC, Must Reuse Front Pipe, additional sizing, bushings, cutting may be required due to OE exhaust design.	642795 ^③	608234 ^③
1998	4	1.9L	2 Piece Design, Federal Emissions, DOHC, Use Aftermarket Front Pipe 38858 or Must Reuse Front Pipe, Additional sizing, bushings, cutting may be required due to OE exhaust design.	642795 ^④ ⊠	608234 ^④
96-98	4	1.9L	Complete Assembly, DOHC, Includes Front Pipe, Federal Emissions	642529 ^④	608204 ^④

③ Federal & California Emissions. Not For Sale or Use on vehicles licensed in the state of CA & NY (NY vehicles with CA Emissions). Check with your state authority for details.

④ Federal Emissions. Not For Sale or Use on vehicles licensed in the state of CA. Check with your state authority.

⑤ California Emissions. Not For Sale or Use on vehicles licensed in the state of CA & NY. Check with your state authority.

✧ Use Aftermarket Front Pipe 38857 or Must Reuse Front Pipe

⊠ Use Aftermarket Front Pipe 38858 or Must Reuse Front Pipe

APPLICATION LISTINGS

FEDERAL CONVERTERS



YR/YRS	CYL	LITER	DESCRIPTION	DIRECT FIT	UNIVERSAL
SATURN SC2 (Cont.)					
96-97	4	1.9L	Semi Direct Fit Conv., Federal Emissions & Calif. Emissions NB6, DOHC, Use Aftermarket Front Pipe 38858 or Must Reuse Front Pipe, additional sizing, bushings, cutting may be required due to OE exhaust design.	642795 ③⌘ -- -- --	608234 ③ -- -- --
93-95	4	1.9L	Complete Assembly, DOHC, Includes Front Pipe	642408 ③	602204 ③
93-95	4	1.9L	2 Piece Design, DOHC, Use Aftermarket Front Pipe 38858 or Must Reuse Front Pipe, Additional sizing, bushings, cutting may be required due to OE exhaust design.	642795 ③⌘ -- --	602204 ③ -- --
SATURN SL / SL1					
01-02	4	1.9L	Semi Direct Fit Conv., SOHC, Must Reuse Front Pipe, additional sizing, bushings, cutting may be required due to OE exhaust design.	642795 ③ --	608234 ③ --
01-02	4	1.9L	Front, SOHC	641246 ③	--
01-02	4	1.9L	Rear, SOHC, Includes Front Pipe	642239 ③	608205 ③
2000	4	1.9L	Semi Direct Fit Conv., SOHC, Must Reuse Front Pipe, additional sizing, bushings, cutting may be required due to OE exhaust design.	642795 ③ --	608234 ③ --
1999	4	1.9L	Semi Direct Fit Conv., Federal Emissions, SOHC, Use Aftermarket Front Pipe 38857 or Must Reuse Front Pipe, additional sizing, bushings, cutting may be required due to OE exhaust design.	642795 ④◇ -- --	608234 ④ -- --
98-99	4	1.9L	Complete Assembly, SOHC, Includes Front Pipe, California Emissions	642289 ⑤ --	608204 ⑤ --
96-99	4	1.9L	Complete Assembly, SOHC, SL1, Includes Front Pipe, Federal Emissions	642727 ④ --	608204 ③ --
1998	4	1.9L	2 Piece Design, Federal Emissions, SOHC, Use Aftermarket Front Pipe 38857 or Must Reuse Front Pipe, Additional sizing, bushings, cutting may be required due to OE exhaust design.	642795 ④◇ -- --	608234 ④ -- --
96-97	4	1.9L	2 Piece Design, SOHC, Use Aftermarket Front Pipe 38857 or Must Reuse Front Pipe, Additional sizing, bushings, cutting may be required due to OE exhaust design.	642795 ③◇ -- --	608234 ③ -- --
93-95	4	1.9L	Complete Assembly, SOHC, Includes Front Pipe	642666 ③	602204 ③
93-95	4	1.9L	2 Piece Design, SOHC, Use Aftermarket Front Pipe 38857 or Must Reuse Front Pipe, Additional sizing, bushings, cutting may be required due to OE exhaust design.	642795 ③◇ -- --	602204 ③ -- --
91-92	4	1.9L		--	602205 ③
SATURN SL2					
01-02	4	1.9L	Semi Direct Fit Conv., DOHC, Must Reuse Front Pipe, additional sizing, bushings, cutting may be required due to OE exhaust design.	642795 ③ --	608234 ③ --
01-02	4	1.9L	Front, DOHC	641211 ③	--
01-02	4	1.9L	Rear, DOHC, Includes Front Pipe	642284 ③	608204 ③
2000	4	1.9L	Semi Direct Fit Conv., DOHC, Must Reuse Front Pipe, additional sizing, bushings, cutting may be required due to OE exhaust design.	642795 ③ --	608234 ③ --
99-00	4	1.9L	Complete Assembly, DOHC, SL2, Includes Front Pipe, Federal Emissions	642723 ④ --	608214 ④ --
99-00	4	1.9L	Front, DOHC, California Emissions	641211 ⑤	--
1999	4	1.9L	Semi Direct Fit Conv., DOHC, Must Reuse Front Pipe, additional sizing, bushings, cutting may be required due to OE exhaust design.	642795 ③ --	608234 ③ --

③ Federal & California Emissions. Not For Sale or Use on vehicles licensed in the state of CA & NY (NY vehicles with CA Emissions). Check with your state authority for details.

④ Federal Emissions. Not For Sale or Use on vehicles licensed in the state of CA. Check with your state authority.

⑤ California Emissions. Not For Sale or Use on vehicles licensed in the state of CA & NY. Check with your state authority.

◇ Use Aftermarket Front Pipe 38857 or Must Reuse Front Pipe

⌘ Use Aftermarket Front Pipe 38858 or Must Reuse Front Pipe



APPLICATION LISTINGS FEDERAL CONVERTERS

YR/YRS	CYL	LITER	DESCRIPTION	DIRECT FIT	UNIVERSAL
SATURN SL2 (Cont.)					
1998	4	1.9L	2 Piece Design, Federal Emissions, DOHC, Use Aftermarket Front Pipe 38858 or Must Reuse Front Pipe, Additional sizing, bushings, cutting may be required due to OE exhaust design.	642795 ④✎	608234④
96-98	4	1.9L	Complete Assembly, DOHC, Includes Front Pipe, Federal Emissions	642529 ④	608204④
96-97	4	1.9L	Semi Direct Fit Conv., Federal Emissions & Calif. Emissions NB6, DOHC, Use Aftermarket Front Pipe 38858 or Must Reuse Front Pipe, additional sizing, bushings, cutting may be required due to OE exhaust design.	642795 ③✎	608234③
93-95	4	1.9L	Complete Assembly, DOHC, Includes Front Pipe	642408 ③	602204③
93-95	4	1.9L	2 Piece Design, DOHC, Use Aftermarket Front Pipe 38858 or Must Reuse Front Pipe, Additional sizing, bushings, cutting may be required due to OE exhaust design.	642795 ③✎	602204③
91-92	4	1.9L	For use with OE intermediate pipe, additional sizing, bushings, cutting may be required due to OE exhaust design.	--	602205③
91-92	4	1.9L		--	602205③
SATURN SW1					
1999	4	1.9L	Semi Direct Fit Conv., Federal Emissions, SOHC, Use Aftermarket Front Pipe 38857 or Must Reuse Front Pipe, additional sizing, bushings, cutting may be required due to OE exhaust design.	642795 ③✎	608234③
98-99	4	1.9L	Complete Assembly, SOHC, Includes Front Pipe, California Emissions	642289 ⑤	608204⑤
96-99	4	1.9L	Complete Assembly, SOHC, Includes Front Pipe, Federal Emissions	642727 ④	608204③
1998	4	1.9L	2 Piece Design, Federal Emissions, SOHC, Use Aftermarket Front Pipe 38857 or Must Reuse Front Pipe, Additional sizing, bushings, cutting may be required due to OE exhaust design.	642795 ④✎	608234④
96-97	4	1.9L	2 Piece Design, SOHC, Use Aftermarket Front Pipe 38857 or Must Reuse Front Pipe, Additional sizing, bushings, cutting may be required due to OE exhaust design.	642795 ③✎	608234③
93-95	4	1.9L	Complete Assembly, SOHC, Includes Front Pipe	642666 ③	602204③
93-95	4	1.9L	2 Piece Design, SOHC, Use Aftermarket Front Pipe 38857 or Must Reuse Front Pipe, Additional sizing, bushings, cutting may be required due to OE exhaust design.	642795 ③✎	602204③
SATURN SW2					
2001	4	1.9L	Semi Direct Fit Conv., DOHC, Must Reuse Front Pipe, additional sizing, bushings, cutting may be required due to OE exhaust design.	642795 ③	608234③
2001	4	1.9L	Front, DOHC	641211 ③	--
2001	4	1.9L	DOHC, Includes Front Pipe	642284 ③	608204③
2000	4	1.9L	Semi Direct Fit Conv., DOHC, Must Reuse Front Pipe, additional sizing, bushings, cutting may be required due to OE exhaust design.	642795 ③	608234③
99-00	4	1.9L	Front, DOHC, California Emissions	641211 ⑤	--
1999	4	1.9L	Semi Direct Fit Conv., DOHC, Must Reuse Front Pipe, additional sizing, bushings, cutting may be required due to OE exhaust design.	642795 ③	608234③
1998	4	1.9L	2 Piece Design, Federal Emissions, DOHC, Use Aftermarket Front Pipe 38858 or Must Reuse Front Pipe, Additional sizing, bushings, cutting may be required due to OE exhaust design.	642795 ④✎	608234④

③ Federal & California Emissions. Not For Sale or Use on vehicles licensed in the state of CA & NY (NY vehicles with CA Emissions). Check with your state authority for details.

④ Federal Emissions. Not For Sale or Use on vehicles licensed in the state of CA. Check with your state authority.

⑤ California Emissions. Not For Sale or Use on vehicles licensed in the state of CA & NY. Check with your state authority.

✎ Use Aftermarket Front Pipe 38857 or Must Reuse Front Pipe

✎ Use Aftermarket Front Pipe 38858 or Must Reuse Front Pipe

APPLICATION LISTINGS

FEDERAL CONVERTERS



YR/YRS	CYL	LITER	DESCRIPTION	DIRECT FIT	UNIVERSAL
SATURN SW2 (Cont.)					
96-98	4	1.9L	Complete Assembly, DOHC, Includes Front Pipe, Federal Emissions	642529 ④ --	608204 ④ --
96-97	4	1.9L	Semi Direct Fit Conv., Federal Emissions & Calif. Emissions NB6, DOHC, Use Aftermarket Front Pipe 38858 or Must Reuse Front Pipe, additional sizing, bushings, cutting may be required due to OE exhaust design.	642795 ③⌘ -- --	608234 ③ -- --
93-95	4	1.9L	Complete Assembly, DOHC, Includes Front Pipe	642408 ③	602204 ③
93-95	4	1.9L	2 Piece Design, DOHC, Use Aftermarket Front Pipe 38858 or Must Reuse Front Pipe, Additional sizing, bushings, cutting may be required due to OE exhaust design.	642795 ③⌘ -- --	602204 ③ -- --
SATURN VUE					
2006	4	2.2L	Manual Trans. Manual Trans.	642295 ③ --	608414 ③○ 608214 ③□
02-05	4	2.2L		642295 ③ --	608414 ③○ 608214 ③□
08-10	4	2.4L		644011 ③	--
2007	4	2.4L	Green Line Model	643134 ③	--
02-03	6	3.0L	Front Front	641318 ③ 641251 ③○	-- --
02-03	6	3.0L		642180 ③	--
04-07	6	3.5L	Front Right Front Right	641356 ③ 641258 ③○	-- --
04-07	6	3.5L	Front Left Front Left	641355 ③ 641257 ③○	-- --
2006	6	3.5L	Front Left	641355 ③	--
2006	6	3.5L	Front Right	641356 ③	--
SCION FR-S					
2013	4	2.0L	Rear	642891 ③	--
SCION TC					
07-10	4	2.4L	Manifold Unit, Front	641400 ③	--
05-10	4	2.4L	Rear	643098 ③	--
07-08	4	2.4L		--	608264 ③○
11-13	4	2.5L	Rear	643123 ③	--
11-13	4	2.5L	Manifold Unit, Front	641409 ③	--
SCION XA					
04-06	4	1.5L	XA	643006 ③	608264 ③○
SCION XB					
04-06	4	1.5L		642168 ③	--
08-12	4	2.4L	Front	641232 ③	--
2008	4	2.4L		--	608264 ③○
SCION XD					
08-12	4	1.8L		643111 ③	--
SMART FORTWO					
2009	3	1.0L		--	608314 ③○
STERLING 825					
87-88	6	2.5L		--	602214 ③

- Ⓞ Discontinued, use until inventory is depleted.
- ③ Federal & California Emissions. Not For Sale or Use on vehicles licensed in the state of CA & NY (NY vehicles with CA Emissions). Check with your state authority for details.
- ④ Federal Emissions. Not For Sale or Use on vehicles licensed in the state of CA. Check with your state authority.
- ⌘ Use Aftermarket Front Pipe 38858 or Must Reuse Front Pipe
- EPA OBDII By Design Unit
- EPA Enhanced OBDII By Design Unit



APPLICATION LISTINGS FEDERAL CONVERTERS

YR/YRS	CYL	LITER	DESCRIPTION	DIRECT FIT	UNIVERSAL
STERLING 827					
89-91	6	2.7L		--	602214 ^③
SUBARU B9 TRIBECA					
06-07	6	3.0L	Manifold Unit, Right	643113 ^③	--
06-07	6	3.0L	Manifold Unit, Left	643112 ^③	--
SUBARU BAJA					
03-06	4	2.5L	Naturally Aspirated	642291 ^③	--
2003	4	2.5L	Federal Emissions	642725 ^{④⑩}	--
SUBARU BRAT					
84-87	4	1.8L	(Exc. Turbo), Rear	--	602004 ^③
83-84	4	All	Turbo, Front	--	602294 ^③
SUBARU COUPE - 3 Dr.					
88-89	4	1.8L	Front, Turbo	--	602294 ^③
88-89	4	1.8L	Rear, Turbo, w/Air Tube	--	602004 ^③
88-89	4	1.8L	Rear, Turbo, w/o Air Tube	642470 ^③	602204 ^③
87-89	4	1.8L	Rear, (Exc. Turbo or California Emissions 4WD)	--	602204 ^③
87-89	4	1.8L	Rear, California Emissions, 4WD, (Exc. Turbo)	642470 ^⑤	602204 ^⑤
1986	4	1.8L	Front, Turbo	--	602294 ^③
1986	4	1.8L	Rear, 2WD, (Exc. Turbo)	--	602004 ^③
1986	4	1.8L	Rear, 4WD Turbo, w/Air Tube	--	602004 ^③
1986	4	1.8L	Rear, 4WD Turbo, w/o Air Tube	642470 ^③	602204 ^③
SUBARU FORESTER					
09-13	4	2.5L	Turbocharged, Rear	642864 ^③	--
06-10	4	2.5L	Naturally Aspirated, Manifold Unit, Front	642803 ^③	--
			Naturally Aspirated, Manifold Unit, Front	642222 ^{③⑩}	--
06-08	4	2.5L	Rear, (Exc. Turbo)	643028 ^③	608415 ^{③①}
99-05	4	2.5L	Naturally Aspirated	642725 ^{④⑩}	--
			Naturally Aspirated	642291 ^③	--
1998	4	2.5L	Front	642663 ^③	608274 ^{③①}
1998	4	2.5L		642763 ^③	608294 ^③
SUBARU HATCHBACK					
85-89	4	1.8L	Front	642936 ^③	--
83-89	4	All	Rear, w/Air Tube	--	602004 ^③
83-89	4	All	Rear, w/o Air Tube	--	602204 ^③
83-84	4	All	Front, w/Turbo	--	602294 ^③
80-82	4	All	Rear, (Exc. 4WD)	--	602204 ^③
80-82	4	All	Rear, 4WD	--	602004 ^③
SUBARU IMPREZA					
96-97	4	1.8L	Front	642762 ^③	608274 ^{③①}
96-97	4	1.8L		642580 ^③	608294 ^③
93-95	4	1.8L	Front	642579 ^③	--
93-95	4	1.8L		642580 ^③	602294 ^③
95-01	4	2.2L	Front	642762 ^③	608274 ^{③①}
95-01	4	2.2L		642763 ^③	608294 ^③
08-14	4	2.5L	Turbocharged, Rear	642864 ^③	--
08-12	4	2.5L	WRX Sti, Turbocharged, Front	642863 ^③	--
06-11	4	2.5L	Naturally Aspirated, Manifold Unit, Front	642803 ^③	--
			Naturally Aspirated, Manifold Unit, Front	642222 ^{③⑩}	--

- ⑩ Discontinued, use until inventory is depleted.
- ③ Federal & California Emissions. Not For Sale or Use on vehicles licensed in the state of CA & NY (NY vehicles with CA Emissions). Check with your state authority for details.
- ④ Federal Emissions. Not For Sale or Use on vehicles licensed in the state of CA. Check with your state authority.
- ⑤ California Emissions. Not For Sale or Use on vehicles licensed in the state of CA & NY. Check with your state authority.

APPLICATION LISTINGS

FEDERAL CONVERTERS



YR/YRS	CYL	LITER	DESCRIPTION	DIRECT FIT	UNIVERSAL
SUBARU IMPREZA (Cont.)					
06-07	4	2.5L	Rear, (Exc. Turbo)	643028 ③	608415 ③○
04-07	4	2.5L	WRX Sti, Turbo, Front	642013 ③	--
04-06	4	2.5L	WRX Sti, Turbo, Rear	642062 ③	--
99-05	4	2.5L	Naturally Aspirated	642291 ③	--
99-05	4	2.5L	Federal Emissions	642725 ④⑩	--
1998	4	2.5L	Front, RS Coupe	642762 ③	608274 ③○
1998	4	2.5L	Rear, RS Coupe	642763 ③	608294 ③
SUBARU JUSTY					
87-94	3	1.2L		--	602204 ③
SUBARU LEGACY					
95-99	4	2.2L	Front	642762 ③	608274 ③
95-99	4	2.2L		642763 ③	608294 ③
90-94	4	2.2L	Front, (Exc. Turbo)	642928 ③	--
90-94	4	2.2L	Rear, (Exc. Turbo)	642947 ③	602204 ③
06-09	4	2.5L	Naturally Aspirated, Manifold Unit, Front	642803 ③	--
05-09	4	2.5L	Turbocharged, Standard Trans., Rear	642864 ③	--
06-07	4	2.5L	Naturally Aspirated, Rear	643122 ③	--
04-05	4	2.5L	Naturally Aspirated, Vehicles w/ 3 Converter Bodies, California Emissions, Right	642019 ⑤	--
04-05	4	2.5L	Naturally Aspirated, Vehicles w/ 3 Converter Bodies, California Emissions, Left	--	--
04-05	4	2.5L	Naturally Aspirated, Vehicles w/ 3 Converter Bodies, California Emissions, Left	643085 ⑤	--
00-05	4	2.5L	Naturally Aspirated, Vehicles w/ 2 Converter Bodies	642291 ③	--
01-03	4	2.5L	Federal Emissions	642725 ④⑩	--
96-02	4	2.5L	Front	642762 ③	608274 ③
96-02	4	2.5L		642763 ③	608294 ③
SUBARU LOYALE					
90-94	4	1.8L	Front, (Exc. Turbo)	642936 ③	--
90-94	4	1.8L	Rear, (Exc. Turbo)	642470 ③	602204 ③
1990	4	1.8L	Front, Turbo	--	602294 ③
1990	4	1.8L	Rear, Turbo	--	602204 ③
SUBARU OUTBACK					
06-11	4	2.5L	Naturally Aspirated, Manifold Unit, Front	642803 ③	--
05-09	4	2.5L	Turbocharged, Standard Trans., Rear	642864 ③	--
06-07	4	2.5L	Naturally Aspirated, Rear	643122 ③	--
04-05	4	2.5L	Naturally Aspirated, Vehicles w/ 3 Converter Bodies, California Emissions, Right	642019 ⑤	--
04-05	4	2.5L	Naturally Aspirated, Vehicles w/ 3 Converter Bodies, California Emissions, Left	--	--
04-05	4	2.5L	Naturally Aspirated, Vehicles w/ 3 Converter Bodies, California Emissions, Left	643085 ⑤	--
00-05	4	2.5L	Naturally Aspirated, Vehicles w/ 2 Converter Bodies	642291 ③	--
01-03	4	2.5L	Federal Emissions	642725 ④⑩	--
2000	4	2.5L	Front Conv.	642762 ③	608274 ③○
2000	4	2.5L	Rear Conv.	642763 ③	608294 ③
05-07	6	3.0L	Manifold Unit, Right	643113 ③	--
05-07	6	3.0L	Manifold Unit, Left	643112 ③	--
01-04	6	3.0L	Right	642123 ③	--
01-04	6	3.0L	Left	642122 ③	--

⑩ Discontinued, use until inventory is depleted.
 ③ Federal & California Emissions. Not For Sale or Use on vehicles licensed in the state of CA & NY (NY vehicles with CA Emissions). Check with your state authority for details.
 ④ Federal Emissions. Not For Sale or Use on vehicles licensed in the state of CA. Check with your state authority.
 ⑤ California Emissions. Not For Sale or Use on vehicles licensed in the state of CA & NY. Check with your state authority.
 ○ EPA Enhanced OBDII By Design Unit



APPLICATION LISTINGS FEDERAL CONVERTERS

YR/YRS	CYL	LITER	DESCRIPTION	DIRECT FIT	UNIVERSAL
SUBARU SEDAN - 4 Dr.					
83-84	4	1.6L	Rear, California Emissions, 4WD, (Exc. Turbo)	--	602204⑤
87-89	4	1.8L	Rear, 2WD, (Exc. Turbo)	--	602204③
85-89	4	1.8L	Front, (Exc. Turbo)	642936 ③	--
85-89	4	1.8L	Front, Turbo	--	602294③
85-89	4	1.8L	Rear, California Emissions, 4WD, (Exc. Turbo)	642470 ⑤	602204⑤
85-89	4	1.8L	Rear, Turbo, 4WD	642470 ③	602204③
85-86	4	1.8L	Rear, California Emissions, 2WD, (Exc. Turbo)	--	602204⑤
85-86	4	1.8L	Rear, 2WD, (Exc. Turbo)	--	602004③
83-84	4	1.8L	Front, Turbo	--	602294③
83-84	4	1.8L	Rear, California Emissions, 4WD, (Exc. Turbo)	--	602204⑤
83-84	4	1.8L	Rear, Turbo, 4WD	--	602004③
1984	4	All	Rear, 2WD, (Exc. Turbo)	--	602204③
83-84	4	All	Rear, California Emissions, 2WD	--	602204⑤
1983	4	All	Rear, 2WD, (Exc. Turbo)	--	602004③
80-82	4	All	Rear, (Exc. 4WD)	--	602204③
SUBARU STATION WAGON					
83-84	4	1.6L	Rear, 4WD California Emissions, (Exc. Turbo)	--	602204⑤
87-89	4	1.8L	Rear, 2WD	--	602204③
85-89	4	1.8L	Front, (Exc. Turbo)	642936 ③	--
85-89	4	1.8L	Front, Turbo	--	602294③
85-89	4	1.8L	Rear, 4WD, Turbo	642470 ③	602204③
85-86	4	1.8L	Rear, 2WD, (Exc. Turbo)	--	602204③
85-86	4	1.8L	Rear, 2WD California Emissions, (Exc. Turbo)	--	602204⑤
83-84	4	1.8L	Front, Turbo	--	602294③
83-84	4	1.8L	Rear, Turbo, 4WD	--	602004③
1984	4	All	Rear, 2WD, (Exc. Turbo)	--	602204③
83-84	4	All	Rear, 2WD, California Emissions	--	602204⑤
83-84	4	All	Rear, 4WD, California Emissions, (Exc. Turbo)	--	602204⑤
1983	4	All	Rear, 2WD, (Exc. Turbo)	--	602004③
1982	4	All		--	602204③
80-81	4	All	Rear, 4WD	--	602204③
SUBARU SVX					
1996	6	3.3L	Front Right	--	608204③
1996	6	3.3L	Front Left	--	608204③
1996	6	3.3L		--	608240③
1995	6	3.3L	Front Right	--	608204③
1995	6	3.3L	Front Left	--	608204③
1995	6	3.3L		--	608240③
92-94	6	3.3L	Front Right	--	602214③
92-94	6	3.3L	Front Left	--	602214③
92-94	6	3.3L		--	603240③
SUBARU XT					
85-90	4	1.8L	Front, (Exc. Turbo)	642936 ③	--
85-90	4	1.8L	Rear, (Exc. Turbo)	642470 ③	602204③
85-87	4	1.8L	Front, Turbo	--	602204③
85-87	4	1.8L	Rear, Turbo	--	602204③
88-91	6	2.7L	XT-6, Rear	--	602204③

⑤ Federal & California Emissions. Not For Sale or Use on vehicles licensed in the state of CA & NY (NY vehicles with CA Emissions). Check with your state authority for details.

③ California Emissions. Not For Sale or Use on vehicles licensed in the state of CA & NY. Check with your state authority.

APPLICATION LISTINGS

FEDERAL CONVERTERS



YR/YRS	CYL	LITER	DESCRIPTION	DIRECT FIT	UNIVERSAL
SUZUKI AERIO					
02-03	4	2.0L	Front	--	608214③
02-03	4	2.0L		641317 ③	--
04-07	4	2.3L		--	608264③○
SUZUKI EQUATOR					
09-12	4	2.5L	Manifold Unit, Front	641407 ③	--
SUZUKI ESTEEM					
95-01	4	1.6L	Front	641196 ③	--
95-01	4	1.6L		642285 ③	608214③
99-02	4	1.8L	Front	641215 ③	--
99-02	4	1.8L		642285 ③	608214③
SUZUKI FORENZA					
04-08	4	2.0L	Front Conv.	642162 ③	--
04-05	4	2.0L	Rear Conv., Requires 38010 Front Pipe to Complete Installation	642049 ③	608415③
SUZUKI FORSA					
87-88	3	1.0L	Turbo (Canada Model)	--	602204③
86-88	3	1.0L	(Exc. Turbo) (Canada Model)	--	602204③
SUZUKI RENO					
05-08	4	2.0L	Front Conv.	642162 ③	--
2005	4	2.0L	Rear Conv., Requires 38010 Front Pipe to Complete Installation	642049 ③	608415③
SUZUKI SAMURAI					
86-94	4	1.3L		642393 ③	602204③
SUZUKI SIDEKICK					
96-98	4	1.6L		642595 ③	608234③
93-95	4	1.6L	16 valve, Hardtop Models	642535 ☆③	609004③
93-95	4	1.6L	4 Dr., (Exc. 16 valve)	--	609004③
89-92	4	1.6L		642418 ③	602205③
96-98	4	1.8L		642595 ③	608234③
SUZUKI SWIFT					
98-01	4	1.3L	Front, California Emissions, Includes Pipe Between Converters	641191 ⑤	--
98-01	4	1.3L	Rear, California Emissions	642300 ⑤	608294⑤
95-97	4	1.3L	SOHC	--	608204③
1994	4	1.3L	DOHC	--	602204③
89-94	4	1.3L	SOHC, Manual Trans.	642904 ③	602204③
1993	4	1.3L	DOHC, Federal Emissions	--	602204④
1993	4	1.3L	DOHC, California Emissions	--	602214⑤
89-92	4	1.3L	DOHC	--	602204③
89-92	4	1.3L	SOHC, Auto Trans.	642917 ③	602203③
SUZUKI SX4					
07-09	4	2.0L	Front	642860 ③	--
07-09	4	2.0L	Rear	643104 ③	--
SUZUKI VERONA					
04-06	6	2.5L	Manifold Unit, Right	641378 ③	--
04-06	6	2.5L	Manifold Unit, Left	641379 ③	--
SUZUKI VITARA, GRAND VITARA					
99-02	4	1.6L		642595 ③	608224③
99-01	4	1.6L	Front, California Emissions	641162 ⑤	--
99-03	4	2.0L		642595 ③	608224③

☆ Air Tube kit 4948 may be required for installation.

③ Federal & California Emissions. Not For Sale or Use on vehicles licensed in the state of CA & NY (NY vehicles with CA Emissions). Check with your state authority for details.

④ Federal Emissions. Not For Sale or Use on vehicles licensed in the state of CA. Check with your state authority.

⑤ California Emissions. Not For Sale or Use on vehicles licensed in the state of CA & NY. Check with your state authority.

○ EPA Enhanced OBDII By Design Unit



APPLICATION LISTINGS FEDERAL CONVERTERS

YR/YRS	CYL	LITER	DESCRIPTION	DIRECT FIT	UNIVERSAL
SUZUKI VITARA, GRAND VITARA (Cont.)					
99-03	4	2.0L	Front, California Emissions	641162 ⑤	--
99-05	6	2.5L	Right Manifold Conv.	641269 ③	--
99-05	6	2.5L	Manifold Unit, Left	641268 ③	--
99-00	6	2.5L	Grand Vitara Models	--	608235 ③
06-08	6	2.7L	Manifold Unit, Front Right	641417 ③	--
06-08	6	2.7L	Manifold Unit, Front Left	641416 ③	--
06-08	6	2.7L	Center	642895 ③	--
SUZUKI X90					
96-98	4	1.6L		642595 ③	608234 ③
SUZUKI XL-7					
04-06	6	2.7L	Manifold Unit, Front Right	641417 ③	--
04-06	6	2.7L	Manifold Unit, Front Left	641416 ③	--
04-06	6	2.7L	Center	644004 ③	--
02-03	6	2.7L	4WD, Auto. Trans., Federal Emissions, Rear Main Conv.	645470 ④	608226 ④
07-08	6	3.6L	Front Conv.	642221 ③	608405 ③○
07-08	6	3.6L	Rear Conv.	642220 ③	608405 ③○
TOYOTA 4 RUNNER					
1995	4	2.4L		--	609004 ③
90-94	4	2.4L		642403 ③	602204 ③
84-89	4	2.4L		642403 ③	602204 ③
99-00	4	2.7L	Federal Emissions	642029 ④	608404 ④
96-98	4	2.7L		642029 ③	608404 ③
94-95	6	3.0L		642409 ③	602205 ③
88-93	6	3.0L		642409 ③	602205 ③
01-02	6	3.4L	Federal Emissions, Rear	642858 ④	--
99-02	6	3.4L	Front, California Emissions	641188 ⑤	--
99-02	6	3.4L	Rear, California Emissions	645424 ⑤	--
96-00	6	3.4L	Federal Emissions	645359 ④	608235 ④
03-12	6	4.0L	To 08/12, Rear Left	642191 ③	--
03-12	6	4.0L	To 08/12, Rear Right	642192 ③	--
03-09	6	4.0L	Front Left	641255 ③	608415 ③○
03-09	6	4.0L	Front Right	641256 ③	608415 ③○
05-09	8	4.7L	Rear Right	642010 ③	608414 ③
05-09	8	4.7L	Rear Left	642005 ③	608414 ③
05-09	8	4.7L	Front Right	641331 ③	--
05-09	8	4.7L	Front Left	641330 ③	--
03-04	8	4.7L	Rear Main	642186 ③	608415 ③○
03-04	8	4.7L	Manifold Unit, Front Right	641436 ③	--
03-04	8	4.7L	Manifold Unit, Front Left	641435 ③	--
TOYOTA AVALON					
00-04	6	3.0L	Middle Conv.	642259 ③	--
00-04	6	3.0L		643013 ③	--
96-04	6	3.0L	Front Manifold Conv., California Emissions, USA Built	641204 ⑤	--
97-99	6	3.0L	Federal Emissions, USA Built	642930 ④	608294 ④
96-99	6	3.0L	California Emissions, USA Built	642993 ⑤	--
95-96	6	3.0L	Federal Emissions, USA Built; From 9/94 To 8/96	642707 ④	608294 ④
09-12	6	3.5L	To 11/2011, Front Manifold Conv.	641294 ③	--

③ Federal & California Emissions. Not For Sale or Use on vehicles licensed in the state of CA & NY (NY vehicles with CA Emissions). Check with your state authority for details.

④ Federal Emissions. Not For Sale or Use on vehicles licensed in the state of CA. Check with your state authority.

⑤ California Emissions. Not For Sale or Use on vehicles licensed in the state of CA & NY. Check with your state authority.

○ EPA Enhanced OBDII By Design Unit

APPLICATION LISTINGS

FEDERAL CONVERTERS



YR/YRS	CYL	LITER	DESCRIPTION	DIRECT FIT	UNIVERSAL
TOYOTA AVALON (Cont.)					
06-12	6	3.5L	To 11/2011, Rear Manifold Conv.	641293 ③	--
06-08	6	3.5L	With L31160 stamped in OE Conv. heat shield and straight bracket at outlet, Front Manifold Conv.	641295 ③	--
06-08	6	3.5L	With LOP040 stamped in OE Conv. heat shield and angled bracket at outlet, Front Manifold Conv.	641294 ③	--
05-07	6	3.5L	Rear Main Conv.	643051 ③	--
2005	6	3.5L	Manifold Unit, Front	641294 ③	--
2005	6	3.5L	Rear Manifold Conv.	641293 ③	--
TOYOTA CAMRY, (Inc. 1998 & Older SOLARA)					
88-91	4	2.0L	Front, All Trac	641119 ③	--
88-91	4	2.0L	Rear, All Trac	--	602215 ③
87-91	4	2.0L	Sedan & Station Wgn.	641119 ③	--
83-86	4	2.0L		642403 ③	602204 ③
97-01	4	2.2L	Federal Emissions	642940 ④	608215 ④
97-01	4	2.2L	US Built, California Emissions, Front	641132 ⑤	--
97-01	4	2.2L	US Built, California Emissions, Rear	642940 ⑤	608215 ⑤
94-96	4	2.2L	Front	641101 ③	--
94-96	4	2.2L	Rear, Sedan, Station Wgn.	642519 ③	602294 ③
92-93	4	2.2L		642334 ③	602206 ③
92-93	4	2.2L	Rear, California Emissions	642334 ⑤	602206 ⑤
07-09	4	2.4L	US Built, Rear	643001 ③	608265 ③○
07-09	4	2.4L	Federal Emissions, Front Manifold Conv.	641303 ④	--
07-09	4	2.4L	California Emissions, Front Manifold Conv.	641304 ⑤	--
03-06	4	2.4L	PZEV & SULEV, Rear	643089 ③	608416 ③
02-06	4	2.4L	US Built, California Emissions, Front	641197 ⑤	--
02-06	4	2.4L	US Built, California Emissions, ULEV Only, Rear	643001 ⑤	608265 ⑤
12-16	4	2.5L	Rear Conv., Requires Resonator Pipe 38015 to Complete Installation, As OE was a One Piece Welded Assembly	642037 ③	608405 ③
10-11	4	2.5L	U.S. Built, Federal Emissions, Rear	643073 ④	--
88-91	6	2.5L		642409 ③	602205 ③
02-06	6	3.0L	Rear Main, USA Built, Auto Trans.	643014 ③	608414 ③○
02-06	6	3.0L	Rear Main, USA Built, Auto Trans.	--	608264 ③□
02-06	6	3.0L	Manifold Unit, Front	641305 ③	--
02-06	6	3.0L	Rear Manifold Conv.	641307 ③	--
97-02	6	3.0L	Manual Trans., Federal Emissions	643015 ④	608226 ④
96-01	6	3.0L	Rear Main, US Built, Auto Trans., California Emissions	642993 ⑤	--
96-01	6	3.0L	Front Manifold Conv., California Emissions	641204 ⑤	--
97-00	6	3.0L	USA Built, Auto Trans., Federal Emissions; To 8/00	642930 ④	608216 ④
95-96	6	3.0L	USA Built, Auto Trans., Federal Emissions;	642707 ④	608294 ④
92-94	6	3.0L	To 8/94	642334 ③	602206 ③
04-06	6	3.3L	Rear Main, USA Built, Auto Trans.	643014 ③○	608414 ③○
04-06	6	3.3L	Rear Manifold Conv.	641308 ③	--
04-06	6	3.3L	Manifold Unit, Front	641306 ③	--
10-11	6	3.5L	Manifold Unit, Front	641294 ③	--
07-11	6	3.5L	Rear Manifold Conv.	641293 ③	--
07-09	6	3.5L	Manifold Unit, Front	641295 ③	--

- ③ Federal & California Emissions. Not For Sale or Use on vehicles licensed in the state of CA & NY (NY vehicles with CA Emissions). Check with your state authority for details.
- ④ Federal Emissions. Not For Sale or Use on vehicles licensed in the state of CA. Check with your state authority.
- ⑤ California Emissions. Not For Sale or Use on vehicles licensed in the state of CA & NY. Check with your state authority.
- EPA OBDII By Design Unit
- EPA Enhanced OBDII By Design Unit



APPLICATION LISTINGS FEDERAL CONVERTERS

YR/YRS	CYL	LITER	DESCRIPTION	DIRECT FIT	UNIVERSAL
TOYOTA CELICA					
90-93	4	1.6L		642334 ③	602206③
00-05	4	1.8L	GT	643087 ③	608415③
1997	4	1.8L	ST Liftback & Sport Coupe	642577 ③	608235③
1996	4	1.8L		642577 ③	608235③
94-95	4	1.8L		--	602214③
88-90	4	2.0L	All Trac; From 10/87	--	602215③
86-89	4	2.0L	DOHC, (Exc. All Trac)	642334 ③	602206③
1986	4	2.0L	SOHC	642403 ③	602204③
90-93	4	2.2L		641119 ③	--
84-85	4	2.4L		642403 ③	602204③
79-80	4	All		642403 ③	602204③
76-78	4	All		--	602204③
TOYOTA COROLLA					
96-97	4	1.6L		642577 ③	608234③
93-95	4	1.6L		642403 ③	602204③
90-92	4	1.6L	All Trac	--	602214③
88-91	4	1.6L	(Exc. All Trac)	642403 ③	602204③
87-88	4	1.6L	FX Models, w/o Air Tube	642403 ③	602204③
87-88	4	1.6L	FX Models, w/Air Tube	--	602004③
06-08	4	1.8L	USA Built, Requires Resonator Pipe #58494 to Complete Installation	642165 ③	--
2005	4	1.8L	XRS, Requires Resonator Pipe #58494 to Complete Installation	642165 ③	--
03-05	4	1.8L	To 04/05, Exc. XRS, Requires Resonator Pipe # 68432 to Complete Installation	642165 ③	--
03-04	4	1.8L	Complete Assembly including Resonator Pipe	642985 ③	--
98-02	4	1.8L		642939 ③	608214③
96-97	4	1.8L		642577 ③	608234③
93-95	4	1.8L		642403 ③	602204③
09-10	4	2.4L	Manifold Unit, Front	641400 ③	--
09-10	4	2.4L	US Built, XRS, Rear, OE is a Welded Assembly, 68542 Pipe Required to Complete Installation	642820 ③	--
83-89	4	All	w/Air Tube on Right	642326 ☆③	602004③
83-86	4	All	w/Air Tube on Left	--	602004③
83-86	4	All	w/o Air Tube	642403 ③	602204③
76-80	4	All	w/o Thermo Sensor Port	642403 ③	602204③
1975	4	All		--	602204③
TOYOTA CORONA					
79-80	4	2.2L		642403 ③	602204③
81-82	4	2.4L		642403 ③	602204③
TOYOTA CRESSIDA					
85-88	6	2.8L		642403 ③	602204③
83-84	6	2.8L	w/o Thermo Sensor Port	642403 ③	602204③
89-92	6	3.0L	(Exc. Manifold Mounted Conv.)	642334 ③	602206③
78-82	6	All		642403 ③	602204③
TOYOTA ECHO					
00-05	4	1.5L		643006 ③	608264③○

☆ Air Tube kit 4948 may be required for installation.

③ Federal & California Emissions. Not For Sale or Use on vehicles licensed in the state of CA & NY (NY vehicles with CA Emissions). Check with your state authority for details.

○ EPA Enhanced OBDII By Design Unit

APPLICATION LISTINGS

FEDERAL CONVERTERS



YR/YRS	CYL	LITER	DESCRIPTION	DIRECT FIT	UNIVERSAL
TOYOTA FJ CRUISER					
07-12	6	4.0L	Rear Right	642192 ③	--
07-12	6	4.0L	Rear Left	642191 ③	--
07-09	6	4.0L	Front Left	641255 ③	--
07-09	6	4.0L	Front Right	641256 ③	--
TOYOTA HIGHLANDER					
04-07	4	2.4L	Manifold Unit, Front	641414 ③	--
04-06	4	2.4L	Rear	642892 ③	--
01-03	4	2.4L		642094 ③	--
11-12	4	2.7L	Rear, Japan Built, Requires Welded Assembly 70002 to Complete Installation, As OE was a One Piece Welded Assembly	642046 ③	--
09-12	4	2.7L	Front	642048 ③	--
09-10	4	2.7L	Rear, Requires Welded Assembly 70002 to Complete Installation, As OE was a One Piece Welded Assembly	642046 ③	--
01-03	6	3.0L	Front Conv.	641173 ③	--
01-03	6	3.0L	Rear Conv.	641174 ③	--
01-03	6	3.0L	Rear Main	642990 ③	--
08-10	6	3.3L	Rear, Requires Welded Assembly 60006 to Complete Installation, As OE was a One Piece Welded Assembly	642045 ③	--
06-10	6	3.3L	Hybrid, Hybrid Limited, Manifold Unit, Front Right	641399 ③	--
06-07	6	3.3L	Front Manifold Conv., Exc. Hybrid Models	641238 ③	--
06-07	6	3.3L	Rear Manifold Conv., Exc. Hybrid Models	641240 ③	--
06-07	6	3.3L	Main Conv., Exc. Hybrid Models, Due to O.E. design, #8 bushing or sizing with aftermarket pipe may be required.	645456 ③	--
06-07	6	3.3L	Hybrid, Rear, Requires Welded Assembly 7885 to Complete Installation	642024 ③	608414 ③
04-05	6	3.3L	Manifold Unit, Front	641238 ③	--
04-05	6	3.3L	Rear Manifold Conv.	641240 ③	--
04-05	6	3.3L	Main Conv., Due to O.E. design, #8 bushing or sizing with aftermarket pipe may be required	645456 ③	--
08-13	6	3.5L	Rear, Exc. Hybrid, Requires Welded Assembly 7505 to complete installation as OE is complete welded assembly	645270 ③	--
08-10	6	3.5L	Rear Manifold Conv.	641299 ③	--
08-09	6	3.5L	Manifold Unit, Front	641297 ③	--
TOYOTA LAND CRUISER					
91-92	6	4.0L	Right	642751 ③	609004 ③
91-92	6	4.0L	Left	642752 ③	609004 ③
88-90	6	4.0L	Left	--	609004 ③
88-90	6	4.0L	Right	--	609004 ③
81-87	6	4.2L		--	609005 ③
95-97	6	4.5L	Rear	645469 ③	609004 ③
95-97	6	4.5L	Front	645267 ③	608406 ③
93-94	6	4.5L	Left	642207 ③	609004 ③
93-94	6	4.5L	Right	642207 ③	609004 ③
98-02	8	4.7L	Left	645193 ③	--
98-02	8	4.7L	Right	645193 ③	--

③ Federal & California Emissions. Not For Sale or Use on vehicles licensed in the state of CA & NY (NY vehicles with CA Emissions). Check with your state authority for details.



APPLICATION LISTINGS FEDERAL CONVERTERS

YR/YRS	CYL	LITER	DESCRIPTION	DIRECT FIT	UNIVERSAL
TOYOTA MATRIX					
05-08	4	1.8L	Exc. XRS Models, Rear	--	608414③○
05-08	4	1.8L	From 04/05, FWD, (Exc. XRS Models w/ 2ZZ-GE Eng.), Requires Resonator Pipe #58494 to Complete Installation.	642165 ③	--
05-08	4	1.8L	Exc. XRS Models, Front	--	608414③○
03-06	4	1.8L	AWD, Complete Assembly Including Resonator Pipe	643114 ③	--
03-05	4	1.8L	To 04/05, FWD, (Exc. XRS Models w/ 2ZZ-GE Eng.), Requires Resonator Pipe # 68432 to Compare Installation	642165 ③	--
03-04	4	1.8L	FWD, (Exc. XRS Models w/2ZZ-GE Eng.), Complete Assembly Including Resonator Pipe	642985 ③	--
2003	4	1.8L	XRS, 6 Speed Standard Trans., Complete Assembly Including Resonator Pipe	643120 ③	--
11-13	4	2.4L	FWD, Rear, OE is a Welded Assembly, 68542 Pipe Required to Complete Installation	642820 ③	--
09-13	4	2.4L	Manifold Unit, Front	641400 ③	--
09-10	4	2.4L	S, FWD, Rear, OE is a Welded Assembly, 68542 Pipe Required to Complete Installation	642820 ③	--
TOYOTA MR2					
85-89	4	1.6L		642403 ③	602204③
91-95	4	2.0L		--	602214③
91-95	4	2.2L		--	602214③
TOYOTA MR2 SPYDER					
00-05	4	1.8L	Manifold Unit, Front	641402 ③	--
00-05	4	1.8L	Rear	642874 ③	--
TOYOTA PASEO					
96-99	4	1.5L	Manual Trans.	642931 ③	608234③
96-97	4	1.5L	Auto Trans.	--	608234③
92-95	4	1.5L		642403 ③	602204③
TOYOTA PICKUP (ALL MODELS Exc. TACOMA & TUNDRA)					
93-95	4	2.4L	(Exc. Tacoma)	642334 ③	602206③
89-92	4	2.4L	4WD	642334 ③	602206③
89-92	4	2.4L	2WD	--	602205③
89-92	4	2.4L	4WD, California Emissions	642409 ⑤	602205⑤
84-88	4	2.4L		642409 ③	602205③
96-98	4	2.7L	T-100 Models	--	608204③
75-83	4	All	w/o Thermo Sensor Port	642403 ③	602204③
94-95	6	3.0L		642409 ③	602205③
93-94	6	3.0L	T-100 Models	--	609005③
88-93	6	3.0L	(Exc. T-100 Models)	642409 ③	602205③
96-98	6	3.4L	T-100 Models, 2WD, Ext. Cab, 1/2 Ton	645394 ③	--
96-98	6	3.4L	T-100 Models	--	608235③
TOYOTA PREVIA VAN					
94-97	4	2.4L	Front, Supercharged	642528 ③	608204③
94-95	4	2.4L	(Exc. Supercharged)	642449 ③	608204③
91-93	4	2.4L		642449 ③	602204③
TOYOTA PRIUS					
04-09	4	1.5L	Conv. includes Resonator	643044 ③	--
04-05	4	1.5L	Hybrid, Rear	--	X25③

③ Federal & California Emissions. Not For Sale or Use on vehicles licensed in the state of CA & NY (NY vehicles with CA Emissions). Check with your state authority for details.

⑤ California Emissions. Not For Sale or Use on vehicles licensed in the state of CA & NY. Check with your state authority.

○ EPA Enhanced OBDII By Design Unit

APPLICATION LISTINGS

FEDERAL CONVERTERS



YR/YRS	CYL	LITER	DESCRIPTION	DIRECT FIT	UNIVERSAL
TOYOTA PRIUS (Cont.)					
01-05	4	1.5L	Hybrid Front Conv.	--	X25 ^③
01-03	4	1.5L	Front, OE is a welded assembly, cut prior to exhaust valves	642030 ^③	--
10-15	4	1.8L	W/ Heat Exchanger, Rear	642889 ^③	--
TOYOTA PRIUS V					
12-14	4	1.8L	W/ Heat Exchanger, Rear	642889 ^③	--
TOYOTA RAV4					
01-03	4	2.0L	Complete Assembly	642277 ^③	--
01-03	4	2.0L	Left	--	608414 ^③ ○
01-03	4	2.0L	Right	--	608414 ^③ ○
98-00	4	2.0L		642750 ^③	608234 ^③
96-97	4	2.0L	Front	641168 ^③	--
96-97	4	2.0L		642721 ^③	608205 ^③
06-08	4	2.4L	Front	641232 ^③	--
06-08	4	2.4L	Rear, Requires Welded Assembly 7454 to complete installation, OE is a complete welded assembly	642237 ^③	608415 ^③ ○
06-08	4	2.4L	Rear, Complete Assembly Including Muffler	643070 ^③	--
04-05	4	2.4L	Rear	642842 ^③	--
09-13	4	2.5L	Rear, Requires Welded Assembly 7454 to complete installation, OE is a complete welded assembly	642237 ^③	608415 ^③ ○
09-12	4	2.5L	Manifold Unit, Front	641409 ^③	--
06-12	6	3.5L	Rear, Complete Assembly including Muffler, To 07/2011	643071 ^③	--
06-12	6	3.5L	Manifold Unit, Front	641298 ^③	--
06-12	6	3.5L	Rear Manifold Conv.	641301 ^③	--
06-12	6	3.5L	Rear, Requires Welded Assembly P/N 40007 to complete installation. OE is a completely welded assembly.	642063 ^③	--
TOYOTA SEQUOIA					
01-04	8	4.7L	Right	645414 ^③	608215 ^③
01-04	8	4.7L	Left	645883 ^③	608215 ^③
TOYOTA SIENNA					
01-03	6	3.0L	Manifold Unit, Front	641204 ^③	--
01-03	6	3.0L	Middle Conv.	645400 ^③	--
01-03	6	3.0L	Rear	645401 ^③	--
99-01	6	3.0L	California Emissions, Rear	643101 ^⑤	--
98-00	6	3.0L	Federal Emissions	643052 ^④	--
04-06	6	3.3L	AWD, Rear Converter, Requires 38938 Intermediate Pipe to Complete Installation	642043 ^③	--
04-06	6	3.3L	Manifold Unit, Front	641238 ^③	--
04-06	6	3.3L	Rear Manifold Conv., FWD	641290 ^③	--
04-06	6	3.3L	AWD, Rear Manifold Conv.	641240 ^③	--
04-06	6	3.3L	FWD, Rear Converter, Requires 68460 Resonator Pipe to Complete Installation	642082 ^③	--
07-10	6	3.5L	AWD, Front Manifold Conv.	641298 ^③	--
07-10	6	3.5L	FWD, Front Manifold Conv.	641297 ^③	--
07-10	6	3.5L	FWD, Rear Manifold Conv.	641300 ^③	--
07-10	6	3.5L	AWD, Rear Manifold Conv.	641299 ^③	--

③ Federal & California Emissions. Not For Sale or Use on vehicles licensed in the state of CA & NY (NY vehicles with CA Emissions). Check with your state authority for details.
 ④ Federal Emissions. Not For Sale or Use on vehicles licensed in the state of CA. Check with your state authority.
 ⑤ California Emissions. Not For Sale or Use on vehicles licensed in the state of CA & NY. Check with your state authority.
 ○ EPA Enhanced OBDII By Design Unit



APPLICATION LISTINGS FEDERAL CONVERTERS

YR/YRS	CYL	LITER	DESCRIPTION	DIRECT FIT	UNIVERSAL
TOYOTA SOLARA					
2001	4	2.2L	Front	641132 ③	--
99-01	4	2.2L	Rear Main Conv.	642940 ③	608215③
99-00	4	2.2L	California Emissions, Front	641132 ⑤	--
06-08	4	2.4L	From 05/2006, Front Manifold Conv.	641303 ③	--
02-08	4	2.4L	Rear Main	643001 ③	608265③○
02-06	4	2.4L	To 05/2006, Front Manifold Conv.	641197 ③	--
99-03	6	3.0L	Rear, Auto Trans., Federal Emissions	642930 ④	608216④
99-02	6	3.0L	Front Manifold Conv., California Emissions	641204 ⑤	--
99-02	6	3.0L	Rear Main, US Built, Auto Trans., California Emissions	642993 ⑤	--
04-08	6	3.3L	Manifold Unit, Front	641306 ③	--
04-08	6	3.3L	Rear Manifold Conv.	641308 ③	--
04-08	6	3.3L	Rear Main, USA Built, Auto Trans.	643014 ③	608414③○
TOYOTA STARLET					
83-84	4	1.3L	w/o Thermo Sensor Port	642403 ③	602204③
83-84	4	1.3L	w/Airtube	--	602004③
81-82	4	1.3L		642403 ③	602204③
TOYOTA SUPRA					
85-86	6	2.8L		642403 ③	602204③
82-84	6	2.8L	w/o Thermo Sensor Port	642403 ③	602204③
1981	6	2.8L		642403 ③	602204③
1998	6	3.0L	Manifold Conv., (Exc. Turbo)	642792 ③	--
96-97	6	3.0L	Front	--	608240③
96-97	6	3.0L		--	608235③
93-95	6	3.0L	Rear, Turbo; From 5/93	--	602205③
93-94	6	3.0L	Front, (Exc. Turbo)	--	602214③
93-94	6	3.0L	Rear, (Exc. Turbo)	--	602205③
87-93	6	3.0L	Front, Turbo; To 4/93	--	602214③
87-93	6	3.0L	Rear, Turbo; To 4/93	642409 ③	602205③
86-92	6	3.0L	(Exc. Turbo)	642334 ③	602206③
TOYOTA TACOMA					
01-04	4	2.4L	Front	641187 ③	--
01-04	4	2.4L	Rear	645419 ③	608264③
99-00	4	2.4L	Front, California Emissions	641187 ⑤	--
99-00	4	2.4L	Rear, California Emissions	645419 ⑤	608264⑤○
95-98	4	2.4L		--	608235③
05-11	4	2.7L	To 09/11	645803 ③	--
01-04	4	2.7L	Rear	645419 ③	608264③
01-04	4	2.7L	Front	642047 ③	--
2000	4	2.7L	Rear, California Emissions	645419 ⑤	608264⑤○
2000	4	2.7L	Federal Emissions	645355 ④	608235④
2000	4	2.7L	California Emissions, Front	642047 ⑤	--
95-99	4	2.7L		645355 ③	608235③
01-04	6	3.4L	Front Conv.	642194 ③	608416③○
01-04	6	3.4L	Rear Conv.	642181 ③	--
2000	6	3.4L	Federal Emissions	645355 ④	608235④
2000	6	3.4L	Front, California Emissions	642194 ⑤	608416⑤○
2000	6	3.4L	Rear, California Emissions	642181 ⑤	--

③ Federal & California Emissions. Not For Sale or Use on vehicles licensed in the state of CA & NY (NY vehicles with CA Emissions). Check with your state authority for details.

④ Federal Emissions. Not For Sale or Use on vehicles licensed in the state of CA. Check with your state authority.

⑤ California Emissions. Not For Sale or Use on vehicles licensed in the state of CA & NY. Check with your state authority.

○ EPA Enhanced OBDII By Design Unit

APPLICATION LISTINGS

FEDERAL CONVERTERS



YR/YRS	CYL	LITER	DESCRIPTION	DIRECT FIT	UNIVERSAL
TOYOTA TACOMA (Cont.)					
95-99	6	3.4L		645355 ③	608235 ③
05-11	6	4.0L	Rear Right	645196 ③	--
05-11	6	4.0L	4WD, Rear Left	645195 ③	--
05-08	6	4.0L	Manifold Unit, Left	641255 ③	608415 ③
05-08	6	4.0L	Right Manifold Conv.	641256 ③	608415 ③
TOYOTA TERCEL					
95-97	4	1.5L	4 Speed Auto Trans.	642931 ③	608214 ③
88-94	4	1.5L		642403 ③	602204 ③
83-88	4	All	w/Air Tube	--	602004 ③
86-87	4	All	(Canada Model)	--	602294 ③
80-86	4	All	w/o Thermo Sensor Port	642403 ③	602204 ③
TOYOTA TUNDRA					
01-04	6	3.4L	Front Conv.	642194 ③	608416 ③○
01-04	6	3.4L	Rear	643033 ③	608215 ③
2000	6	3.4L	Front, California Emissions	642194 ⑤	608416 ⑤○
2000	6	3.4L	Rear, California Emission	643033 ⑤	608215 ⑤
05-06	6	4.0L	Manifold Unit, Left	641255 ③	608415 ③
05-06	6	4.0L	Right Manifold Conv.	641256 ③	608415 ③
05-06	6	4.0L	Rear Right	645280 ③	--
07-09	8	4.7L	145.7" W.B., Left	643074 ③	--
07-09	8	4.7L	145.7" W.B., Front Left	--	608405 ③
07-09	8	4.7L	145.7" W.B., Rear Left	--	608295 ③
07-09	8	4.7L	Right	642040 ③	--
07-09	8	4.7L	Front Right	--	608405 ③
07-09	8	4.7L	Rear Right	--	608295 ③
05-06	8	4.7L	Right	645426 ③	608264 ③○
05-06	8	4.7L	Left	645877 ③	608214 ③
03-04	8	4.7L	Right	645266 ③	608264 ③
03-04	8	4.7L	Left	645257 ③	608264 ③
00-02	8	4.7L	Right	645397 ③	--
00-02	8	4.7L	Left	645398 ③	--
10-13	8	5.7L	145.7" W.B., Left	643119 ③	--
07-11	8	5.7L	Right	642109 ③	608405 ③○
07-09	8	5.7L	Left, Exc. Crew Max	642110 ③	608405 ③○
TOYOTA VAN					
88-89	4	2.2L		642334 ③	602206 ③
84-87	4	All		642403 ③	602204 ③
TOYOTA VENZA					
09-15	4	2.7L	Rear Converter, Requires Resonator Pipe #68526 to Complete Installation	643069 ③	--
09-15	6	3.5L	Rear Converter, Requires Resonator Pipe #68526 to Complete Installation	642076 ③	--
09-12	6	3.5L	To 05/2012, Front Manifold Conv.	641294 ③	--
09-12	6	3.5L	To 05/2012, Rear Manifold Conv.	641296 ③	--
TOYOTA YARIS					
2014	4	1.5L	Complete Assembly	643081 ③	--
2014	4	1.5L	Front	--	608414 ③

③ Federal & California Emissions. Not For Sale or Use on vehicles licensed in the state of CA & NY (NY vehicles with CA Emissions). Check with your state authority for details.

⑤ California Emissions. Not For Sale or Use on vehicles licensed in the state of CA & NY. Check with your state authority.

○ EPA Enhanced OBDII By Design Unit



APPLICATION LISTINGS FEDERAL CONVERTERS

YR/YRS	CYL	LITER	DESCRIPTION	DIRECT FIT	UNIVERSAL
TOYOTA YARIS (Cont.)					
2014	4	1.5L	Rear	--	608414 ^③
12-13	4	1.5L	Complete Assembly	643081 ^③	--
12-13	4	1.5L	Front	--	608414 ^③
12-13	4	1.5L	Rear	--	608414 ^③
06-11	4	1.5L	Hatchback	643078 ^③	--
TRIUMPH TR7					
77-79	4	2.0L		--	602214 ^③
80-81	4	All	w/51" Conv.	--	602214 ^③
TRIUMPH TR8					
80-81	8	3.5L	Left	--	602214 ^③
80-81	8	3.5L	Right	--	602214 ^③
VOLKSWAGEN BEETLE					
75-79	4	1.6L		--	602214 ^③
02-04	4	1.8L	Turbo	642765 ^③	--
99-01	4	1.8L	GLS Turbo	642765 ^③	--
98-04	4	1.9L		642883 ^③	--
03-05	4	2.0L		642766 ^③	--
01-02	4	2.0L	AVH Eng.	642766 ^③	--
2001	4	2.0L	AEG Eng.	645364 ^③	608235 ^③
98-00	4	2.0L	AEG Eng.	645364 ^③	608235 ^③
06-10	5	2.5L	With Single Oxygen Sensor in Assembly	643076 ^③	608314 ^③
VOLKSWAGEN CABRIOLET					
90-93	4	1.8L	w/34-1/2" Conv.	642585 ☆ ^③	609004 ^③
85-89	4	1.8L		--	602214 ^③
01-02	4	2.0L	GL, GLS, GLX, ABA Eng.	642672 ^③	608214 ^③
96-00	4	2.0L	ABA Eng.	642672 ^③	608214 ^③
1995	4	2.0L		--	608234 ^③
VOLKSWAGEN CORRADO					
90-92	4	1.8L	w/19-1/2" Conv & O2 Sensor Port in Conv. Body	--	608234 ^③
92-94	6	2.8L		--	602215 ^③
VOLKSWAGEN DASHER					
74-75	4	1.5L	From 8/74	--	602214 ^③
79-80	4	All	w/11-1/2" Conv.	--	602214 ^③
VOLKSWAGEN EOS					
07-08	4	2.0L		642007 ^③	--
VOLKSWAGEN EUROVAN					
93-95	4	2.5L		--	609005 ^③
97-00	6	2.8L	AES Eng.	645404 ^③	608225 ^③
VOLKSWAGEN FOX					
87-92	4	1.8L		--	602214 ^③
VOLKSWAGEN GOLF					
00-03	4	1.8L	GLS Turbo	642765 ^③	--
90-92	4	1.8L	8 valve, RV Eng., If 50mm O.D. Outlet Pipe Required Must Fabricate; From 1/90	--	602214 ^③
88-89	4	1.8L	RV Eng., If 50mm O.D. Outlet Pipe Required Must Fabricate	--	602214 ^③
87-89	4	1.8L	Golf GTI, PL Eng., 16 valve	--	602215 ^③
86-87	4	1.8L	w/2" Funnel Flange, w/2" OD Outlet, (Exc. RV or PL Eng.)	--	602204 ^③
86-87	4	1.8L	w/2" Funnel Flange, w/1-3/4" OD Outlet, (Exc. RV or PL Eng.)	--	602204 ^③

☆ Air Tube kit 4948 may be required for installation.

③ Federal & California Emissions. Not For Sale or Use on vehicles licensed in the state of CA & NY (NY vehicles with CA Emissions). Check with your state authority for details.

APPLICATION LISTINGS

FEDERAL CONVERTERS



YR/YRS	CYL	LITER	DESCRIPTION	DIRECT FIT	UNIVERSAL
VOLKSWAGEN GOLF (Cont.)					
86-87	4	1.8L	w/2" Funnel Flange, w/1-7/8" OD Outlet, (Exc. RV or PL Eng.)	--	602204③
1985	4	1.8L	GTI, w/2" Funnel Flange, w/2" OD Outlet	--	602204③
1985	4	1.8L	GTI, w/2" Funnel Flange, w/1-3/4" OD Outlet	--	602204③
1985	4	1.8L	GTI, w/2" Funnel Flange, w/1-7/8" OD Outlet	--	602204③
99-04	4	1.9L		642883 ③	--
03-06	4	2.0L		642766 ③	--
01-02	4	2.0L	AVH Eng.	642766 ③	--
99-01	4	2.0L	AEG Eng.	645364 ③	608214③
96-98	4	2.0L	GTI, ABA Eng., Manual Trans	642672 ③	608214③
94-95	4	2.0L		--	602215③
1993	4	2.0L		--	602214③
90-92	4	2.0L	16 valve	--	602214③
2010	5	2.5L		645194 ③	--
99-02	6	2.8L	AFP Eng.	642712 ③	--
96-98	6	2.8L	GTI VR6	645439 ③	608215③
2004	6	3.2L	R32	642859 ③	--
VOLKSWAGEN GTI					
06-08	4	2.0L		642007 ③	--
VOLKSWAGEN JETTA					
00-03	4	1.8L	GLS Turbo	642765 ③	--
90-92	4	1.8L	RV Eng., If 50mm O.D. Outlet Pipe Required Must Fabricate	--	602214③
90-92	4	1.8L	RV Eng. California Emissions	--	602214⑤
88-92	4	1.8L	PF Eng.	--	602214③
88-89	4	1.8L	RV Eng., If 50mm O.D. Outlet Pipe Required Must Fabricate	--	602214③
87-89	4	1.8L	Jetta GLI, 16 valve, PL Eng.	--	602215③
86-87	4	1.8L	RD Eng.	--	602214③
86-87	4	1.8L	GX Eng., If 50mm O.D. Outlet Pipe Required Must Fabricate	--	602214③
1985	4	1.8L	w/2" Funnel Flange, w/2" OD Outlet, (Exc. GLI)	--	602204③
1985	4	1.8L	w/2" Funnel Flange, w/1-3/4" OD Outlet, (Exc. GLI)	--	602204③
1985	4	1.8L	w/2" Funnel Flange, w/1-7/8" OD Outlet, (Exc. GLI)	--	602204③
99-04	4	1.9L		642883 ③	--
06-08	4	2.0L		642007 ③	--
04-05	4	2.0L	BBW Eng., California Emissions	642861 ⑤	--
02-05	4	2.0L	AVH & BEV Eng.	642766 ③	--
2001	4	2.0L		645364 ③	608214③
99-00	4	2.0L	AEG Eng.	645364 ③	608214③
96-98	4	2.0L	ABA Eng.	642672 ③	608214③
1995	4	2.0L		--	608234③
1994	4	2.0L	19-1/2" Conv., If 50mm O.D. Outlet Pipe Required Must Fabricate	--	602214③
90-93	4	2.0L		--	602214③
80-84	4	All		--	602214③
08-10	5	2.5L		645194 ③	--
05-07	5	2.5L	Eng. Code BGP	642218 ③	--
05-07	5	2.5L	BGQ Engine Designation	645194 ③	--
02-04	6	2.8L	BDF Eng., 6 Speed Manual Trans.	642197 ③	--
99-02	6	2.8L	AFP Eng.	642712 ③	--
96-97	6	2.8L		--	608215③

③ Federal & California Emissions. Not For Sale or Use on vehicles licensed in the state of CA & NY (NY vehicles with CA Emissions). Check with your state authority for details.

⑤ California Emissions. Not For Sale or Use on vehicles licensed in the state of CA & NY. Check with your state authority.



APPLICATION LISTINGS FEDERAL CONVERTERS

YR/YRS	CYL	LITER	DESCRIPTION	DIRECT FIT	UNIVERSAL
VOLKSWAGEN JETTA (Cont.)					
94-95	6	2.8L		--	602215 ^③
VOLKSWAGEN PASSAT					
98-05	4	1.8L	Turbo	642688 ^③	--
2008	4	2.0L	BPY Engine only	643068 ^{③①}	--
			BPY Engine only	642001 ^③	--
06-07	4	2.0L		643068 ^{③①}	--
				642001 ^③	--
1996	4	2.0L	Sedan & Wagon, ABA Eng.	642672 ^③	608214 ^③
00-05	6	2.8L	Right, Auto Trans.	642976 ^③	--
00-05	6	2.8L	Left, Auto Trans.	642977 ^③	--
00-05	6	2.8L	Right, Manual Trans.	643057 ^③	--
00-05	6	2.8L	Left, Manual Trans.	643061 ^③	--
98-99	6	2.8L	Right, Auto Trans.	643022 ^③	--
98-99	6	2.8L	Left, Auto Trans.	643027 ^③	--
96-97	6	2.8L		645439 ^③	608215 ^③
93-95	6	2.8L		--	602215 ^③
06-08	6	3.6L		643102 ^③	--
VOLKSWAGEN QUANTUM					
82-88	4,5	All		--	602214 ^③
VOLKSWAGEN R32					
2008	6	3.2L		643125 ^③	--
VOLKSWAGEN RABBIT					
82-84	4	1.7L	Exc. Fuel Injection	--	602004 ^③
82-84	4	1.7L	Fuel Injection	--	602214 ^③
83-84	4	1.8L		--	602214 ^③
75-81	4	All		--	602214 ^③
08-09	5	2.5L		645194 ^③	--
2008	5	2.5L	Eng. Code CBTA, To Chassis #1K-8B000 006, 1K-8P002 061, 1K-8U000 007 & 1K-8W004 974	642218 ^③	--
				--	--
06-07	5	2.5L	Eng. Code BGP	642218 ^③	--
06-07	5	2.5L	BGQ Engine Designation	645194 ^③	--
VOLKSWAGEN RABBIT PICKUP					
80-83	4	All		--	602214 ^③
VOLKSWAGEN ROUTAN					
09-10	6	3.8L		643032 ^③	608416 ^③
VOLKSWAGEN SCIROCCO					
87-88	4	1.8L	16 valve, Complete; From 6/86	--	602215 ^③
86-88	4	1.8L	(Exc. 16 valve)	--	602214 ^③
84-85	4	1.8L	8 valve	--	602214 ^③
75-83	4	All		--	602214 ^③
VOLKSWAGEN TOUAREG					
04-06	6	3.2L	Front	641236 ^③	--
04-06	6	3.2L	Rear	642217 ^③	608416 ^{③①}
2007	6	3.6L	Left	642875 ^③	--
2007	6	3.6L	Right	642876 ^③	--
2007	6	3.6L	Rear	642877 ^③	--
04-07	8	4.2L	Front Left	642869 ^③	--
04-07	8	4.2L	Front Right	642870 ^③	--

① Discontinued, use until inventory is depleted.

③ Federal & California Emissions. Not For Sale or Use on vehicles licensed in the state of CA & NY (NY vehicles with CA Emissions). Check with your state authority for details.

○ EPA Enhanced OBDII By Design Unit

APPLICATION LISTINGS

FEDERAL CONVERTERS



YR/YRS	CYL	LITER	DESCRIPTION	DIRECT FIT	UNIVERSAL
VOLKSWAGEN TOUAREG (Cont.)					
04-07	8	4.2L	Rear Left	642871 ③	--
04-07	8	4.2L	Rear Right	642872 ③	--
VOLKSWAGEN VANAGON					
83-85	4	1.9L		--	602214 ③
80-83	4	2.0L		--	602214 ③
86-91	4	2.1L		--	602214 ③
77-79	4	All	w/12" Conv.	--	602214 ③
77-79	4	All	w/11" Conv.	--	602294 ③
VOLVO 240					
1993	4	2.3L	w/EGR System	--	602204 ③
84-93	4	2.3L	w/o EGR System	642316 ③	602244 ③
82-83	4	All		--	602294 ③
82-83	4	All	Optional Direct Fit Converter	--	602294 ③
75-81	4	All		--	602294 ③
75-81	4	All	Optional Direct Fit Converter	--	602294 ③
VOLVO 260					
80-82	6	All	B28F Eng.	--	602294 ③
77-79	6	All	w/13" Conv.	--	602294 ③
77-79	6	All	w/13" Conv., Optional Direct Fit Converter	--	602294 ③
VOLVO 262					
78-79	6	2.7L	w/Chassis # 49070 - 262 Series	--	602294 ③
78-79	6	2.7L	w/Chassis # 49070 - 262 Series, Optional Direct Fit Conv.	--	602294 ③
VOLVO 264					
77-79	6	2.7L	w/Chassis # 66393 - 264 Series	--	602294 ③
77-79	6	2.7L	w/Chassis # 66393 - 264 Series, Optional Direct Fit Conv.	--	602294 ③
VOLVO 265					
77-79	6	2.7L	w/Chassis # 16957 - 265 Series	--	602294 ③
77-79	6	2.7L	w/Chassis # 16957 - 265 Series, Optional Direct Fit Conv.	--	602294 ③
VOLVO 740					
89-92	4	2.3L	SOHC, (Exc. Turbo)	642306 ③	602244 ③
85-92	4	2.3L	Turbo	642467 ③	602244 ③
89-91	4	2.3L	DOHC	642467 ③	602244 ③
85-88	4	2.3L	SOHC, (Exc. Turbo)	642306 ③	602244 ③
VOLVO 760					
84-90	4	2.3L	Turbo	642467 ③	602244 ③
87-90	6	2.8L		642467 ③	602244 ③
83-86	6	2.8L		--	602294 ③
VOLVO 780					
89-90	4	2.3L	Turbo	--	602244 ③
87-90	6	2.8L		642306 ③	602244 ③
VOLVO 850					
1996	5	2.3L	Sedan w/Turbo, Federal Emissions, w/out Spinning Inlet Flange	642963 ④	--
1996	5	2.3L	Sedan w/Turbo, Federal Emissions, w/Spinning Inlet Flange	642698 ④	--
94-95	5	2.3L	Sedan w/Turbo, w/out Spinning Inlet Flange	642963 ③	--
1997	5	2.4L	GLT Model	643030 ③	--
1995	5	2.4L	Auto Trans.	--	609005 ③
1995	5	2.4L	Manual Trans., Sedan & Station Wgn., w/2 Bolt Flange	642616 ☆③	609005 ③

☆ Air Tube kit 4948 may be required for installation.

③ Federal & California Emissions. Not For Sale or Use on vehicles licensed in the state of CA & NY (NY vehicles with CA Emissions). Check with your state authority for details.

④ Federal Emissions. Not For Sale or Use on vehicles licensed in the state of CA. Check with your state authority.



APPLICATION LISTINGS FEDERAL CONVERTERS

YR/YRS	CYL	LITER	DESCRIPTION	DIRECT FIT	UNIVERSAL
VOLVO 850 (Cont.)					
93-94	5	2.4L	Sedan & Station Wgn., w/2 Bolt Flange	642616 ☆③	609005③
VOLVO 940					
91-95	4	2.3L	(Exc. Turbo)	642306 ③	602244③
91-95	4	2.3L	Turbo	642467 ③	602244③
VOLVO 960					
1996	6	2.9L		--	608240③
94-95	6	2.9L		--	609240③
92-93	6	2.9L		--	609240③
VOLVO C30					
07-10	5	2.4L	ULEV Emissions	642890 ③	--
VOLVO S40/V40					
00-04	4	1.9L	Front	641210 ③	--
00-04	4	1.9L		642276 ③	608235③
04-10	5	2.4L	S40, ULEV Emissions, w/ 2 Converters	642890 ③	--
04-07	5	2.4L	S40, With One Converter	642213 ③	608265③
04-06	5	2.4L	S40, Manifold Unit, Front	641426 ③	--
VOLVO S60					
01-02	5	2.3L	Turbocharged	642851 ③	--
05-09	5	2.4L	Turbo	642090 ③	--
03-05	5	2.4L	Manifold Conv., B5244S Eng. Designation, (Exc. Turbo)	642201 ③	--
01-05	5	2.4L	Rear, Naturally Aspirated	642058 ③	--
01-02	5	2.4L	Manifold Conv., To Engine #2680829 (Exc. Turbo)	642201 ③	--
01-02	5	2.4L	Turbocharged	642851 ③	--
05-09	5	2.5L	Rear, Turbo, FWD, Exc. Model R	642090 ③	--
VOLVO S70/V70					
01-02	5	2.3L	V70, Turbocharged, FWD	642851 ③	--
2000	5	2.3L	V70, AWD Turbo, DF Front & Rear, Univ. Rear Only	642997 ③	608235③
03-07	5	2.4L	V70, Rear, Naturally Aspirated	642058 ③	--
2002	5	2.4L	V70, Manifold Conv., To Engine #2680829 (Exc. Turbo)	642201 ③	--
2001	5	2.4L	V70, Manifold Conv., (Exc. Turbo)	642201 ③	--
2001	5	2.4L	Turbo, AWD	642009 ③	--
2000	5	2.4L	S70, AWD Turbo, DF Front & Rear, Univ. Rear Only	642997 ③	608235③
2000	5	2.4L	V70, AWD Turbo, DF Front & Rear, Univ. Rear Only	642997 ③	608235③
2000	5	2.4L	V70, Naturally Aspirated	642884 ③	--
2000	5	2.4L	S70, Naturally Aspirated	642884 ③	--
98-99	5	2.4L	V70, AWD Turbo, 56-B5254T Engine	643054 ③	--
05-07	5	2.5L	V70, Rear, Turbo, Exc. Model R	642090 ③	--
VOLVO S80					
04-06	5	2.5L	Rear, Turbo	642090 ③	--
00-01	6	2.8L	Turbocharged, B6284T Engine Designation	642862 ③	--
02-05	6	2.9L	Turbocharged, B6294T Engine Designation	642840 ③	--
02-04	6	2.9L	Rear, Naturally Aspirated	643082 ③	--
02-04	6	2.9L	Naturally Aspirated, Manifold Unit, Front Right	641375 ③	--
02-04	6	2.9L	Naturally Aspirated, Manifold Unit, Front Left	641376 ③	--
99-01	6	2.9L	Naturally Aspirated, w/Precats, Center	642854 ③	--

☆ Air Tube kit 4948 may be required for installation.

③ Federal & California Emissions. Not For Sale or Use on vehicles licensed in the state of CA & NY (NY vehicles with CA Emissions). Check with your state authority for details.

APPLICATION LISTINGS

FEDERAL CONVERTERS



YR/YRS	CYL	LITER	DESCRIPTION	DIRECT FIT	UNIVERSAL
VOLVO V50					
05-10	5	2.4L	ULEV Emissions, w/ 2 Converters	642890 ③	--
05-07	5	2.4L	With One Converter	642213 ③	608265 ③○
05-06	5	2.4L	Manifold Unit, Front	641426 ③	--
VOLVO XC90					
07-10	6	3.2L	Manifold Unit, Right	641433 ③	--
07-10	6	3.2L	Manifold Unit, Left	641434 ③	--
07-10	6	3.2L	Center	644007 ③	--
05-11	8	4.4L	Center	644002 ③	--
WORKHORSE W42					
06-07	8	4.8L		645297 ③	--
YUGO CABRIO					
90-92	4	1.3L		--	602203 ③
YUGO GV					
86-89	4	1.1L		--	602203 ③
90-92	4	1.3L		--	602203 ③
YUGO GVL					
88-89	4	1.1L		--	602203 ③
YUGO GVS					
1988	4	1.1L		--	602203 ③
YUGO GVX					
88-89	4	1.3L		--	602203 ③

③ Federal & California Emissions. Not For Sale or Use on vehicles licensed in the state of CA & NY (NY vehicles with CA Emissions). Check with your state authority for details.
 ○ EPA Enhanced OBDII By Design Unit

641101

Inlet A: WELDED 5-BOLT FLANGE
Outlet A: WELDED 3-BOLT FLANGE
Length: 11.50"



1996-94 4 TOYOTA CAMRY, (Inc. 1998 & Older SOLARA)
2.2L

641119

Inlet A: WELDED 5-BOLT FLANGE
Outlet A: WELDED 3-BOLT FLANGE
Length: 8.63"



1991-87 4 TOYOTA CAMRY, (Inc. 1998 & Older SOLARA)
2.0L
1993-90 4 TOYOTA CELICA 2.2L

641112

Inlet A: LOOSE 2 BOLT FLANGE, W/ FEMALE FLARE
Outlet A: 1.88" O.D. PIPE
Length: 37.50"



1997-93 6 CHRYSLER CONCORDE 3.5L
1997-94 6 CHRYSLER LHS 3.5L
1996-94 6 CHRYSLER NEW YORKER 3.5L
1997-93 6 DODGE INTREPID 3.5L
1996-93 6 EAGLE VISION 3.5L

641122

Inlet A: WELDED 5-BOLT FLANGE W/ STUDS
Outlet A: WELDED 2-BOLT FLANGE W/ GASKET STUB
Length: 17.50"



2000-98 4 KIA SPORTAGE 2.0L

641113

Inlet A: LOOSE 2 BOLT FLANGE, W/ FEMALE FLARE
Outlet A: 1.88" O.D. PIPE
Length: 34.25"



1997-93 6 CHRYSLER CONCORDE 3.5L
1997-94 6 CHRYSLER LHS 3.5L
1996-94 6 CHRYSLER NEW YORKER 3.5L
1997-93 6 DODGE INTREPID 3.5L
1996-93 6 EAGLE VISION 3.5L

641123

Inlet A: WELDED 5-BOLT FLANGE W/ STUDS
Outlet A: WELDED 2-BOLT FLANGE W/ GASKET STUB
Length: 14.50"

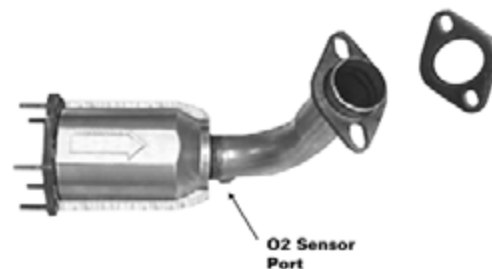

1999-98 4 KIA SEPHIA 1.8L

DIRECT FIT



641124

Inlet A: WELDED 5-BOLT FLANGE W/ STUDS
 Outlet A: WELDED 2-BOLT FLANGE W/ GASKET STUB
 Length: 12.75"

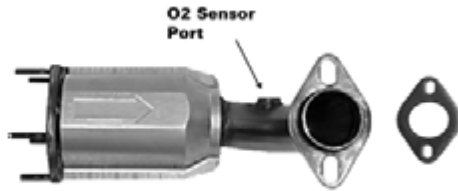

1998-95 4 MAZDA PROTÉGÉ 1.5L

641125

Inlet A: WELDED 2-BOLT FLANGE
 Outlet A: WELDED 2-BOLT FLANGE
 Length: 37.25"



1995-92 6 MAZDA 929 3.0L

641126

Inlet A: WELDED 2-BOLT FLANGE
 Outlet A: WELDED 2-BOLT FLANGE
 Length: 38.75"



1995-92 6 MAZDA 929 3.0L

641127

Inlet A: WELDED 6-BOLT FLANGE
 Outlet A: WELDED 2-BOLT FLANGE
 Length: 15"

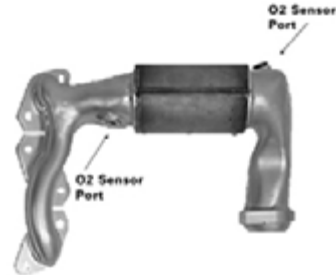

2000-95 6 FORD CONTOUR 2.5L
 2000-99 6 MERCURY COUGAR 2.5L
 2000-95 6 MERCURY MYSTIQUE 2.5L

641128

Inlet A: WELDED 5-BOLT FLANGE W/ STUDS
 Outlet A: WELDED 2.25" 3-BOLT FLANGE
 Length: 18.88"

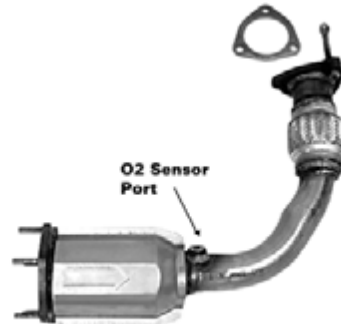

2002-01 4 KIA SPORTAGE 2.0L

641129

Inlet A: WELDED 6-BOLT FLANGE
 Outlet A: WELDED 2-BOLT FLANGE W/ STUDS
 Length: 12.75"

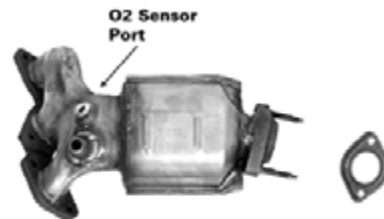

2000-95 6 FORD CONTOUR 2.5L
 2000-99 6 MERCURY COUGAR 2.5L
 2000-95 6 MERCURY MYSTIQUE 2.5L

641132

Inlet A: WELDED 6-BOLT FLANGE
Outlet A: WELDED 3-BOLT FLANGE
Length: 17.38"



2001-97 4 TOYOTA CAMRY, (Inc. 1998 & Older SOLARA) 2.2L
2001-99 4 TOYOTA SOLARA 2.2L

641133

Inlet A: WELDED 6-BOLT FLANGE
Outlet A: WELDED 3-BOLT FLANGE
Length: 9.75"



2000-97 6 INFiniti QX4 3.3L
2003-01 6 INFiniti QX4 3.5L
2000-96 6 NISSAN PATHFINDER 3.3L
2004-01 6 NISSAN PATHFINDER 3.5L

641134

Inlet A: WELDED 6-BOLT FLANGE
Outlet A: WELDED 3-BOLT FLANGE
Length: 9.75"



2000-97 6 INFiniti QX4 3.3L
2000-96 6 NISSAN PATHFINDER 3.3L

641135

Inlet A: WELDED 3-BOLT FLANGE W/ STUDS
Outlet A: WELDED 3-BOLT FLANGE W/ STUDS
Length: 7"

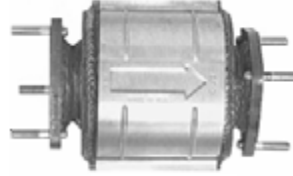

2002-99 4 DAEWOO NUBIRA 2.0L

641138

Inlet A: WELDED 3-BOLT FLANGE W/ STUDS
Outlet A: LOOSE 2-BOLT FLANGE W/ MALE BALL
Length: 21.25"



1996-93 6 CHRYSLER CONCORDE 3.3L
1996-93 6 DODGE INTREPID 3.3L
1996-93 6 EAGLE VISION 3.3L

641139

Inlet A: WELDED 3-BOLT FLANGE W/ STUDS
Outlet A: LOOSE 2-BOLT FLANGE W/ MALE BALL
Length: 24"



1996-93 6 CHRYSLER CONCORDE 3.3L
1996-93 6 DODGE INTREPID 3.3L
1996-93 6 EAGLE VISION 3.3L

641140

Inlet A: LOOSE 2-BOLT FLANGE W/ FEMALE FLARE
Outlet A: 1.88" O.D. PIPE
Length: 40"



1996-93 6 CHRYSLER CONCORDE 3.3L
1997-93 6 DODGE INTREPID 3.3L
1997-93 6 EAGLE VISION 3.3L

DIRECT FIT



641141

Inlet A: LOOSE 2-BOLT FLANGE W/ FEMALE FLARE
Outlet A: 1.88" O.D. PIPE
Length: 37.25"



1996-93 6 CHRYSLER CONCORDE 3.3L
1997-93 6 DODGE INTREPID 3.3L
1997-93 6 EAGLE VISION 3.3L

641145

Inlet A: WELDED 7-BOLT FLANGE
Outlet A: WELDED 3-BOLT FLANGE
Length: 11.50"

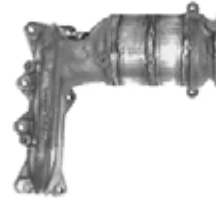

2002-95 6 MAZDA MILLENIA 2.3L

641142

Inlet A: 45 DEGREE FLARE
Outlet A: WELDED 2-BOLT FLANGE
Length: 14.25"



2003-02 6 JEEP LIBERTY 3.7L

641147

Inlet A: WELDED 6-BOLT FLANGE
Outlet A: WELDED 3-BOLT FLANGE
Length: 10.75"



2001-98 4 NISSAN ALTIMA 2.4L

641143

Inlet A: 45 DEGREE FLARE
Outlet A: WELDED 2-BOLT FLANGE W/ GASKET STUB
Length: 13.50"



2003-02 6 JEEP LIBERTY 3.7L

641148

Inlet A: WELDED 5-BOLT FLANGE
Outlet A: WELDED 3-BOLT FLANGE
Length: 6.38"



2002-98 4 KIA SPORTAGE 2.0L

641144

Inlet A: WELDED 7-BOLT FLANGE
Outlet A: WELDED 3-BOLT FLANGE
Length: 15.50"



2002-95 6 MAZDA MILLENIA 2.3L

641149

Inlet A: LOOSE 2-BOLT FLANGE W/ SPHERICAL FLARE
Inlet B: WELDED 2-BOLT FLANGE
Outlet A: WELDED 2-BOLT FLANGE
Length: 29"



2005-00 6 FORD TAURUS 3.0L
2005-00 6 MERCURY SABLE 3.0L

641150

Inlet A: WELDED 3-BOLT FLANGE
Outlet A: WELDED 3-BOLT FLANGE
Length: 13.75"



2001-99 6 NISSAN FRONTIER 3.3L
2001-00 6 NISSAN XTERRA 3.3L

641151

Inlet A: WELDED 3-BOLT FLANGE
Outlet A: WELDED 3-BOLT FLANGE
Length: 12.75"



2001-99 6 NISSAN FRONTIER 3.3L
2001-00 6 NISSAN XTERRA 3.3L

641152

Inlet A: WELDED 6-BOLT FLANGE
Outlet A: WELDED 2-BOLT FLANGE
Length: 13"

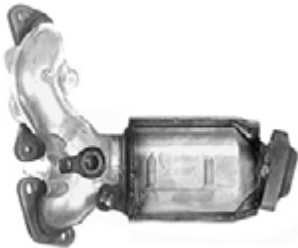

2001-00 6 MAZDA MPV VAN 2.5L

641153

Inlet A: WELDED 6-BOLT FLANGE
Outlet A: WELDED 2-BOLT FLANGE
Length: 14.25"



2005-00 6 FORD TAURUS 3.0L
2005-00 6 MERCURY SABLE 3.0L

641154

Inlet A: WELDED 5-BOLT FLANGE
Outlet A: WELDED 3-BOLT FLANGE
Length: 7"



2004-01 4 HYUNDAI SANTA FE 2.4L
2005-99 4 HYUNDAI SONATA 2.4L
2006-01 4 KIA OPTIMA 2.4L

641156

Inlet A: WELDED 5-BOLT FLANGE
Outlet A: WELDED 3-BOLT FLANGE
Length: 7.75"

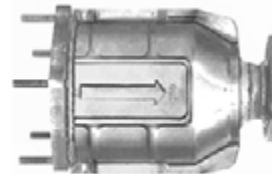

2000-99 4 MAZDA PROTÉGÉ 1.8L
2001-99 4 MAZDA PROTÉGÉ 1.6L
2003-01 4 MAZDA PROTÉGÉ 2.0L

DIRECT FIT



641157

Inlet A: WELDED 7-BOLT FLANGE
 Outlet A: WELDED 2-BOLT FLANGE
 Length: 15.25"



- 2001-99 6 HYUNDAI SONATA 2.5L
- 2005-02 6 HYUNDAI SONATA 2.7L
- 2005-03 6 HYUNDAI TIBURON 2.7L
- 2001 6 KIA OPTIMA 2.5L
- 2006-02 6 KIA OPTIMA 2.7L

641158

Inlet A: WELDED 7-BOLT FLANGE
 Outlet A: WELDED 2-BOLT FLANGE
 Length: 15.25"



- 2001-99 6 HYUNDAI SONATA 2.5L
- 2005-02 6 HYUNDAI SONATA 2.7L
- 2001 6 KIA OPTIMA 2.5L
- 2006-02 6 KIA OPTIMA 2.7L

641159

Inlet A: WELDED 6-BOLT FLANGE
 Outlet A: WELDED 2-BOLT FLANGE
 Length: 15.25"

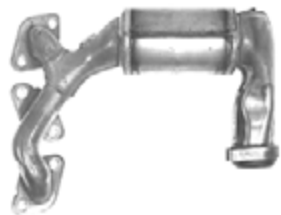

- 2001-00 6 MAZDA MPV VAN 2.5L

641160

Inlet A: WELDED 2-BOLT FLANGE W/ SPHERICAL FLARE
 Inlet B: WELDED 2-BOLT FLANGE W/ SPHERICAL FLARE
 Outlet A: WELDED 3-BOLT FLANGE
 Length: 27"



- 2003-00 6 JEEP WRANGLER 4.0L

641161

Inlet A: WELDED 6-BOLT FLANGE
 Outlet A: WELDED 3-BOLT FLANGE
 Length: 7.63"



- 1997-95 4 NISSAN ALTIMA 2.4L

641162

Inlet A: WELDED 3-BOLT FLANGE W/ GASKET STUB
 Outlet A: WELDED 2-BOLT FLANGE W/ GASKET STUB
 Length: 16"



- 2002-99 4 CHEVROLET TRACKER 1.6L
- 2004-99 4 CHEVROLET TRACKER 2.0L
- 2001-99 4 SUZUKI VITARA, GRAND VITARA 1.6L
- 2003-99 4 SUZUKI VITARA, GRAND VITARA 2.0L

641163

Inlet A: WELDED 3-BOLT FLANGE
 Outlet A: WELDED 2-BOLT FLANGE
 Length: 8.63"



- 2005-01 6 CHRYSLER SEBRING 3.0L
- 2005-01 6 DODGE STRATUS 3.0L
- 2002-99 6 MITSUBISHI DIAMANTE 3.5L

641163 (cont.)

2005-00 6 MITSUBISHI ECLIPSE 3.0L
2003-99 6 MITSUBISHI GALANT 3.0L

641164

Inlet A: WELDED 3-BOLT FLANGE
Outlet A: WELDED 2-BOLT FLANGE
Length: 13.75"



2005-01 6 CHRYSLER SEBRING 3.0L
2005-01 6 DODGE STRATUS 3.0L
2002-99 6 MITSUBISHI DIAMANTE 3.5L
2005-00 6 MITSUBISHI ECLIPSE 3.0L
2003-99 6 MITSUBISHI GALANT 3.0L

641165

Inlet A: WELDED 2-BOLT FLANGE
Outlet A: WELDED 2-BOLT FLANGE
Length: 14.50"



1999 4 MITSUBISHI ECLIPSE 2.4L
2000-99 4 MITSUBISHI GALANT 2.4L

641166

Inlet A: 3-BOLT FLANGE W/ SPHERICAL FLARE
Inlet B: 3-BOLT FLANGE W/ SPHERICAL FLARE
Outlet A: WELDED 3-BOLT FLANGE
Length: 34.75"



1999-98 6 CHEVROLET BLAZER S-Series 4.3L
1999-98 6 GMC S-15 JIMMY 4.3L
1999-98 6 OLDSMOBILE BRAVADA 4.3L

641167

Inlet A: WELDED 5-BOLT FLANGE
Outlet A: WELDED 3-BOLT FLANGE
Length: 10.50"



2001-00 6 INFINITI I30 3.0L
2001-00 6 NISSAN MAXIMA 3.0L

641168

Inlet A: WELDED 5-BOLT FLANGE
Outlet A: WELDED 3-BOLT FLANGE
Length: 8.63"



1997-96 4 TOYOTA RAV4 2.0L

641169

Inlet A: WELDED 6-BOLT FLANGE
Outlet A: WELDED 2-BOLT FLANGE
Length: 13"



2006-01 6 FORD ESCAPE 3.0L
2006-01 6 MAZDA TRIBUTE 3.0L
2006-05 6 MERCURY MARINER 3.0L

641170

Inlet A: WELDED 6-BOLT FLANGE
Outlet A: WELDED 2-BOLT FLANGE
Length: 16.25"



2006-01 6 FORD ESCAPE 3.0L
2006-01 6 MAZDA TRIBUTE 3.0L
2006-05 6 MERCURY MARINER 3.0L

DIRECT FIT



641172

Inlet A: WELDED 2-BOLT FLANGE W/ SPHERICAL FLARE
 Inlet B: WELDED 2-BOLT FLANGE W/ SPHERICAL FLARE
 Outlet A: WELDED 3-BOLT FLANGE
 Length: 22"



2001-00 6 JEEP CHEROKEE 4.0L

641173

Inlet A: WELDED 2-BOLT FLANGE W/ GASKET STUB
 Outlet A: WELDED 2-BOLT FLANGE W/ GASKET STUB
 Length: 12.25"



2003-99 6 LEXUS RX300 3.0L
 2003-01 6 TOYOTA HIGHLANDER 3.0L

641174

Inlet A: WELDED 2-BOLT FLANGE
 Inlet B: WELDED 2-BOLT FLANGE
 Outlet A: WELDED 2-BOLT FLANGE W/ GASKET STUB
 Length: 21.50"



2003-99 6 LEXUS RX300 3.0L
 2003-01 6 TOYOTA HIGHLANDER 3.0L

641175

Inlet A: WELDED 5-BOLT FLANGE
 Outlet A: WELDED 3-BOLT FLANGE
 Length: 7.25"

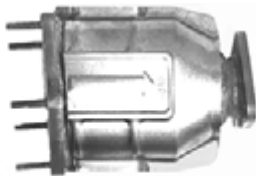

2002-00 4 MAZDA 626 2.0L

641176

Inlet A: WELDED 9-BOLT FLANGE W/ SPHERICAL FLARE
 Outlet A: WELDED 2-BOLT FLANGE
 Length: 19"

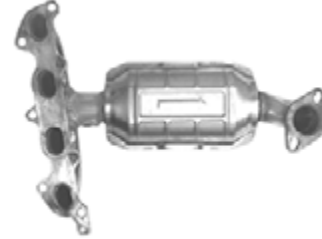

2005-03 4 KIA RIO 1.6L

641177

Inlet A: WELDED 2-BOLT FLANGE W/ SPHERICAL FLARE
 Inlet B: WELDED 2-BOLT FLANGE W/ SPHERICAL FLARE
 Outlet A: 2.50" O.D. PIPE
 Length: 41"



2004-01 6 JEEP GRAND CHEROKEE/GRAND WAGONEER 4.0L

641178

Inlet A: LOOSE 2-BOLT FLANGE W/ SPHERICAL FLARE
 Inlet B: LOOSE 2-BOLT FLANGE W/ SPHERICAL FLARE
 Outlet A: WELDED 3-BOLT FLANGE
 Length: 21.50"



2002-98 6 FORD EXPLORER 4.0L
 2003-01 6 FORD RANGER 4.0L
 2003-01 6 MAZDA B-Series PICKUP 4.0L
 2001-98 6 MERCURY MOUNTAINEER 4.0L

641179

Inlet A: WELDED 5-BOLT FLANGE
Outlet A: WELDED 2-BOLT FLANGE
Length: 35"



1999-98 4 MAZDA 626 2.0L

641180

Inlet A: WELDED 9-BOLT FLANGE
Outlet A: WELDED 2-BOLT FLANGE
Length: 20.25"



2005-01 4 HYUNDAI ELANTRA 2.0L
2006-03 4 HYUNDAI TIBURON 2.0L

641181

Inlet A: WELDED 4-BOLT FLANGE
Outlet A: WELDED 4-BOLT FLANGE
Length: 13.25"



1995-94 6 HONDA PASSPORT 3.2L
1995-93 6 ISUZU RODEO 3.2L

641182

Inlet A: WELDED 6-BOLT FLANGE
Outlet A: WELDED 3-BOLT FLANGE
Length: 10.50"



2004-02 6 INFiniti I35 3.5L

641182 (cont.)

2003-02 6 NISSAN MAXIMA 3.5L

641183

Inlet A: WELDED 4-BOLT FLANGE
Outlet A: WELDED 3-BOLT FLANGE
Length: 8.25"



2004-02 6 INFiniti I35 3.5L
2003-02 6 NISSAN MAXIMA 3.5L

641185

Inlet A: LOOSE 2-BOLT FLANGE W/ SPHERICAL FLARE
Inlet B: LOOSE 2-BOLT FLANGE W/ SPHERICAL FLARE
Outlet A: WELDED 3-BOLT FLANGE W/ GASKET STUB
Length: 25.50"



2000-99 6 FORD EXPLORER 4.0L

641186

Inlet A: WELDED 5-BOLT FLANGE
Outlet A: WELDED 3-BOLT FLANGE
Length: 5.75"



2001-99 4 KIA SEPHIA 1.8L
2001-00 4 KIA SPECTRA 1.8L

641187

Inlet A: WELDED 3-BOLT FLANGE W/ GASKET STUB
Outlet A: WELDED 2-BOLT FLANGE W/ GASKET STUB
Length: 25"

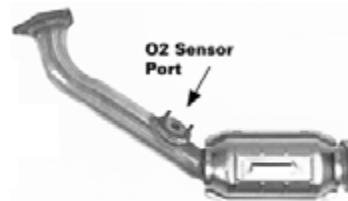

2004-99 4 TOYOTA TACOMA 2.4L

DIRECT FIT



641188

Inlet A: WELDED 3-BOLT FLANGE W/ GASKET STUB
 Outlet A: WELDED 2-BOLT FLANGE W/ GASKET STUB
 Length: 20"

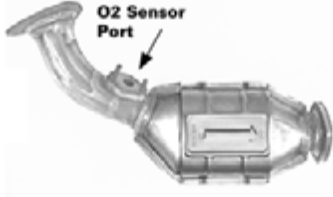

2002-99 6 TOYOTA 4 RUNNER 3.4L

641189

Inlet A: WELDED 2-BOLT FLANGE W/ GASKET STUB
 Inlet B: W/ RING GASKET
 Outlet A: WELDED 2-BOLT FLANGE W/ GASKET STUB
 Length: 23.75"



2003-01 6 MITSUBISHI MONTERO SPORT 3.0L

641190

Inlet A: WELDED 2-BOLT FLANGE W/ GASKET STUB
 Outlet A: LOOSE 2-BOLT FLANGE W/ SPHERICAL FLARE
 Length: 26.50"



2003-01 6 MITSUBISHI MONTERO SPORT 3.0L

641191

Inlet A: WELDED 9-BOLT FLANGE
 Outlet A: WELDED 2-BOLT FLANGE W/ GASKET STUB
 Length: 17.50"



2001-98 4 CHEVROLET METRO 1.3L
 1997 4 GEO METRO 1.3L
 2001-98 4 SUZUKI SWIFT 1.3L

641192

Inlet A: WELDED 3-BOLT FLANGE
 Outlet A: WELDED 3-BOLT FLANGE
 Length: 35"



2005-00 6 SATURN L300 3.0L
 2005-00 6 SATURN LW300 3.0L

641193

Inlet A: WELDED 9-BOLT FLANGE
 Outlet A: WELDED 2-BOLT FLANGE
 Length: 14.25"



2007-02 4 MITSUBISHI LANCER 2.0L

641194

Inlet A: WELDED 7-BOLT FLANGE
Outlet A: WELDED 3-BOLT FLANGE
Length: 14.25"



2002-01 4 KIA RIO 1.5L

641195

Inlet A: WELDED 3-BOLT FLANGE
Outlet A: WELDED 3-BOLT FLANGE
Length: 7"



2002-99 4 DAEWOO LEGANZA 2.2L

641196

Inlet A: WELDED 3-BOLT FLANGE
Outlet A: WELDED 2-BOLT FLANGE W/ GASKET STUB
Length: 22.25"



2001-95 4 SUZUKI ESTEEM 1.6L

641197

Inlet A: WELDED 5-BOLT FLANGE
Outlet A: WELDED 2-BOLT FLANGE
Length: 18.88"



2006-02 4 TOYOTA CAMRY, (Inc. 1998 & Older SOLARA)
2.4L
2006-02 4 TOYOTA SOLARA 2.4L

641198

Inlet A: WELDED 5-BOLT FLANGE
Outlet A: WELDED 2-BOLT FLANGE W/ GASKET STUB
Length: 18.88"



2006-02 4 NISSAN ALTIMA 2.5L
2006-02 4 NISSAN SENTRA 2.5L

641199

Inlet A: WELDED 6-BOLT FLANGE
Outlet A: WELDED 3-BOLT FLANGE
Length: 13"

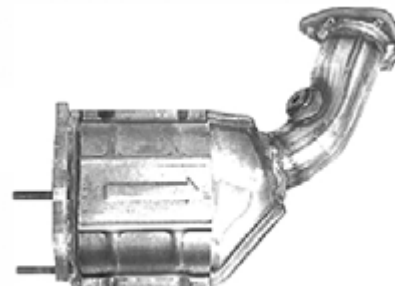

2006-02 6 NISSAN ALTIMA 3.5L
2007-03 6 NISSAN MURANO 3.5L

DIRECT FIT



641200

Inlet A: WELDED 6-BOLT FLANGE
 Outlet A: WELDED 3-BOLT FLANGE
 Length: 8.50"



2006-03 4 NISSAN SENTRA 1.8L

641201

Inlet A: WELDED 7-BOLT FLANGE
 Outlet A: WELDED 2-BOLT FLANGE
 Length: 15.25"



2005-03 6 HYUNDAI TIBURON 2.7L

641203

Inlet A: WELDED 5-BOLT FLANGE
 Outlet A: WELDED 2-BOLT FLANGE
 Length: 6"

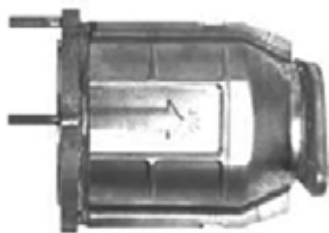

2001 6 HYUNDAI XG300 3.0L
 2003-02 6 HYUNDAI XG350 3.5L
 2005-02 6 KIA SEDONA 3.5L

641204

Inlet A: WELDED 6-BOLT FLANGE
 Outlet A: WELDED 2-BOLT FLANGE
 Length: 14"



2001-96 6 LEXUS ES300 3.0L
 2004-96 6 TOYOTA AVALON 3.0L
 2001-96 6 TOYOTA CAMRY, (Inc. 1998 & Older SOLARA) 3.0L
 2003-01 6 TOYOTA SIENNA 3.0L
 2002-99 6 TOYOTA SOLARA 3.0L

641205

Inlet A: WELDED 6-BOLT FLANGE
 Outlet A: WELDED 3-BOLT FLANGE
 Length: 16"

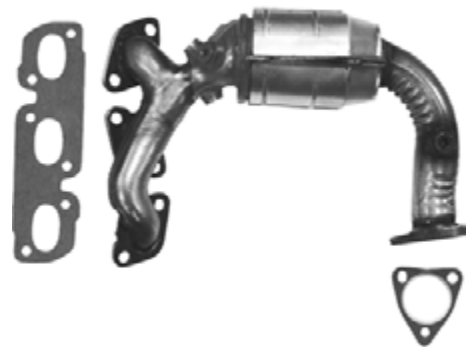

2006-02 6 MAZDA MPV VAN 3.0L

641206

Inlet A: WELDED 6-BOLT FLANGE
Outlet A: WELDED 3-BOLT FLANGE
Length: 13"



2006-02 6 MAZDA MPV VAN 3.0L

641207

Inlet A: WELDED 9-BOLT FLANGE
Outlet A: WELDED 2-BOLT FLANGE
Length: 17"



2005-01 4 CHRYSLER SEBRING 2.4L
2005-01 4 DODGE STRATUS 2.4L
2005-00 4 MITSUBISHI ECLIPSE 2.4L
2003-00 4 MITSUBISHI GALANT 2.4L

641208

Inlet A: WELDED 5-BOLT FLANGE
Outlet A: WELDED 2-BOLT FLANGE
Length: 6.25"

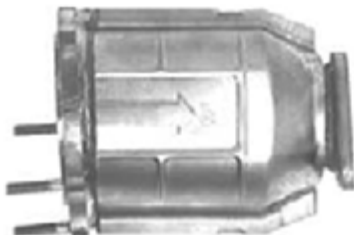

2001 6 HYUNDAI XG300 3.0L
2003-02 6 HYUNDAI XG350 3.5L
2005-02 6 KIA SEDONA 3.5L

641209

Inlet A: LOOSE 2-BOLT FLANGE W/ SPHERICAL FLARE
Inlet B: LOOSE 2-BOLT FLANGE W/ SPHERICAL FLARE
Outlet A: 2.50" O.D. PIPE
Length: 34.63"

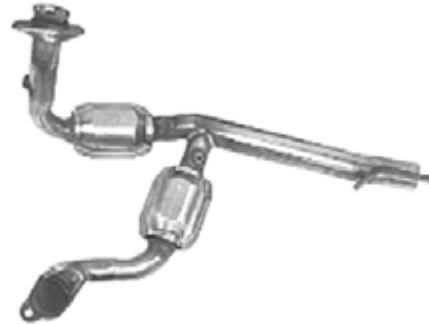

2001-99 8 JEEP GRAND CHEROKEE/GRAND WAGONEER 4.7L

641210

Inlet A: WELDED 3-BOLT FLANGE
Outlet A: WELDED 4-BOLT FLANGE
Length: 13.25"



2004-00 4 VOLVO S40/V40 1.9L

641211

Inlet A: WELDED 9-BOLT FLANGE
Outlet A: WELDED 3-BOLT FLANGE
Length: 11.50"



2002-99 4 SATURN SC2 1.9L
2002-99 4 SATURN SL2 1.9L

DIRECT FIT



641211 (cont.)

2001-99 4 SATURN SW2 1.9L

641212

Inlet A: WELDED 6-BOLT FLANGE
Outlet A: WELDED 3-BOLT FLANGE
Length: 9.50"



2003-01 6 INFINITI QX4 3.5L
2004-01 6 NISSAN PATHFINDER 3.5L

641213

Inlet A: WELDED 7-BOLT FLANGE
Outlet A: WELDED 2-BOLT FLANGE
Length: 11"



2000-95 6 CHRYSLER SEBRING 2.5L
2000-95 6 DODGE AVENGER 2.5L

641214

Inlet A: WELDED 4-BOLT FLANGE W/ GASKET STUB
Outlet A: WELDED 3-BOLT FLANGE
Length: 14"



2006-02 6 NISSAN ALTIMA 3.5L
2008-04 6 NISSAN MAXIMA 3.5L
2009-04 6 NISSAN QUEST 3.5L

641215

Inlet A: WELDED 3-BOLT FLANGE
Outlet A: WELDED 2-BOLT FLANGE W/ GASKET STUB
Length: 24"



2002-99 4 SUZUKI ESTEEM 1.8L

641216

Inlet A: WELDED 7-BOLT FLANGE
Outlet A: WELDED 3-BOLT FLANGE W/ GASKET STUB
Length: 24"

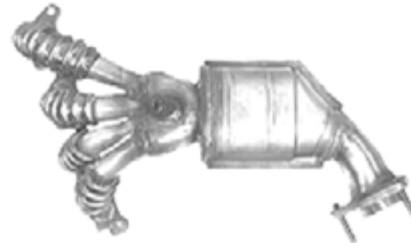

2006-04 4 CHEVROLET COLORADO 2.8L
2006-04 4 GMC CANYON 2.8L
2006 4 ISUZU I-280 2.8L

641217

Inlet A: WELDED 7-BOLT FLANGE
Outlet A: WELDED 3-BOLT FLANGE
Length: 10.50"

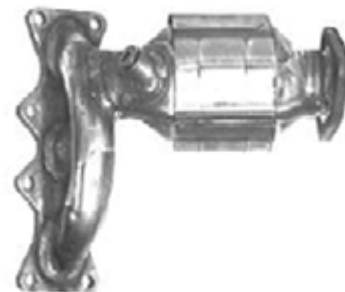

2001-97 6 MAZDA MILLENIA 2.5L

641218

Inlet A: WELDED 7-BOLT FLANGE
Outlet A: WELDED 3-BOLT FLANGE
Length: 9"

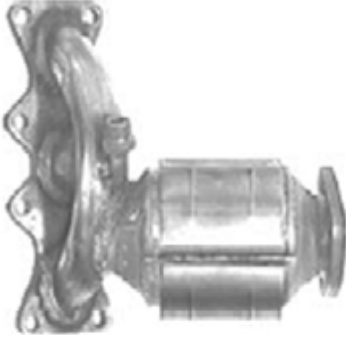

2001-97 6 MAZDA MILLENIA 2.5L

641219

Inlet A: LOOSE 2-BOLT FLANGE W/ SPHERICAL FLARE
Inlet B: LOOSE 2-BOLT FLANGE W/ SPHERICAL FLARE
Outlet A: WELDED 3-BOLT FLANGE
Length: 48"



2004-02 8 FORD E-150 VAN 1/2 TON 5.4L
2004-02 8 FORD E-250 VAN 3/4 TON 5.4L

641222

Inlet A: WELDED 7-BOLT FLANGE
Outlet A: WELDED 2-BOLT FLANGE
Length: 17"



2004 6 MITSUBISHI ENDEAVOR 3.8L

641223

Inlet A: WELDED 7-BOLT FLANGE
Inlet B: WELDED 2-BOLT FLANGE
Outlet A: WELDED 2-BOLT FLANGE W/ GASKET STUB
Length: 21.25"



2004 6 MITSUBISHI ENDEAVOR 3.8L

641224

Inlet A: LOOSE 2-BOLT FLANGE W/ SPHERICAL FLARE
Inlet B: LOOSE 2-BOLT FLANGE W/ SPHERICAL FLARE
Outlet A: WELDED 3-BOLT FLANGE
Length: 33.50"



2006-04 6 FORD RANGER 3.0L
2006-04 6 MAZDA B-Series PICKUP 3.0L

641225

Inlet A: WELDED 2-BOLT FLANGE
Inlet B: WELDED 2-BOLT FLANGE
Outlet A: WELDED 2-BOLT FLANGE W/ GASKET STUB
Length: 21"



2002-01 6 MITSUBISHI MONTERO 3.5L

DIRECT FIT



641226

Inlet A: WELDED 4-BOLT FLANGE
 Outlet A: WELDED 3-BOLT FLANGE
 Length: 14"



2007-03 6 NISSAN MURANO 3.5L

641227

Inlet A: 3-BOLT FLANGE W/ SPHERICAL FLARE
 Inlet B: 3-BOLT FLANGE W/ SPHERICAL FLARE
 Outlet A: WELDED 3-BOLT FLANGE
 Length: 36.50"



1999-98 6 CHEVROLET S-Series (2WD), T-Series (4WD)
 PICKUP 4.3L
 1999-98 6 GMC S-Series (2WD), T-Series (4WD) PICKUP
 (SONOMA) 4.3L
 1999-98 6 ISUZU PICKUP 4.3L

641228

Inlet A: WELDED 6-BOLT FLANGE
 Outlet A: WELDED 2-BOLT FLANGE W/ GASKET STUB
 Length: 16"



2005-03 6 MAZDA 6 3.0L

641229

Inlet A: WELDED 6-BOLT FLANGE
 Outlet A: WELDED 2-BOLT FLANGE W/ GASKET STUB
 Length: 13.25"



2005-03 6 MAZDA 6 3.0L

641230

Inlet A: WELDED 9-BOLT FLANGE
 Outlet A: WELDED 3-BOLT FLANGE
 Length: 12.50"



2004-01 4 KIA SPECTRA 1.8L

641231

Inlet A: WELDED 7-BOLT FLANGE
 Outlet A: WELDED 2-BOLT FLANGE
 Length: 15.75"



2007-06 4 HYUNDAI SONATA 2.4L
 2008-06 4 KIA OPTIMA 2.4L

641232

Inlet A: WELDED 5-BOLT FLANGE
Outlet A: WELDED 2-BOLT FLANGE W/ GASKET STUB
Length: 19.13"



2012-08 4 SCION XB 2.4L
2008-06 4 TOYOTA RAV4 2.4L

641233

Inlet A: WELDED 9-BOLT FLANGE
Outlet A: WELDED 2-BOLT FLANGE
Length: 16.25"



2009-04 4 KIA SPECTRA 2.0L

641234

Inlet A: WELDED 5-BOLT FLANGE
Outlet A: WELDED 3-BOLT FLANGE
Length: 11.63"



2004-01 4 NISSAN FRONTIER 2.4L
2004-01 4 NISSAN XTERRA 2.4L

641235

Inlet A: WELDED 10-BOLT FLANGE
Outlet A: WELDED 2-BOLT FLANGE W/ GASKET STUB
Length: 19"

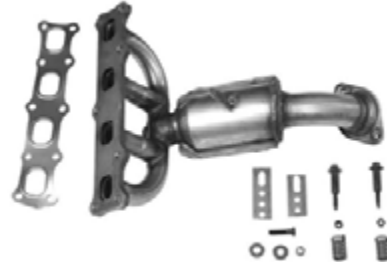

2008-07 4 DODGE CALIBER 2.4L
2008-07 4 JEEP COMPASS 2.0L
2010-07 4 JEEP COMPASS 2.4L
2008-07 4 JEEP PATRIOT 2.0L
2008-07 4 JEEP PATRIOT 2.4L

641236

Inlet A: WELDED 3-BOLT FLANGE
Inlet B: WELDED 3-BOLT FLANGE
Outlet A: WELDED 3-BOLT FLANGE
Length: 32"



2006-04 6 VOLKSWAGEN TOUAREG 3.2L

641237

Inlet A: WELDED 3-BOLT FLANGE
Outlet A: WELDED 2-BOLT FLANGE W/ GASKET STUB
Length: 13.50"



2001-00 3 HONDA INSIGHT 1.0L

DIRECT FIT



641238

Inlet A: WELDED 6-BOLT FLANGE
 Outlet A: WELDED 2-BOLT FLANGE
 Length: 17"



- 2006-04 6 LEXUS RX330 3.3L
- 2007-04 6 TOYOTA HIGHLANDER 3.3L
- 2006-04 6 TOYOTA SIENNA 3.3L

641239

Inlet A: WELDED 2-BOLT FLANGE W/ GASKET STUB
 Outlet A: WELDED 2-BOLT FLANGE
 Length: 13.75"



- 2002-97 4 MITSUBISHI MIRAGE 1.5L

641240

Inlet A: WELDED 6-BOLT FLANGE
 Outlet A: WELDED 2-BOLT FLANGE
 Length: 16.50"



- 2006-04 6 LEXUS RX330 3.3L
- 2007-04 6 TOYOTA HIGHLANDER 3.3L

641240 (cont.)

- 2006-04 6 TOYOTA SIENNA 3.3L

641241

Inlet A: WELDED 6-BOLT FLANGE
 Outlet A: WELDED 2-BOLT FLANGE W/ GASKET STUB
 Length: 22.50"



- 2012-06 6 FORD FUSION 3.0L
- 2006 6 LINCOLN ZEPHYR 3.0L
- 2011-06 6 MERCURY MILAN 3.0L

641242

Inlet A: WELDED 6-BOLT FLANGE
 Outlet A: WELDED 2-BOLT FLANGE
 Length: 17"



- 2008-06 6 FORD FUSION 3.0L
- 2006 6 LINCOLN ZEPHYR 3.0L
- 2008-06 6 MERCURY MILAN 3.0L

641243

Inlet A: WELDED 6-BOLT FLANGE
 Outlet A: WELDED 3-BOLT FLANGE
 Length: 18.50"



- 2004-02 6 NISSAN FRONTIER 3.3L
- 2004-02 6 NISSAN XTERRA 3.3L

641244

Inlet A: WELDED 6-BOLT FLANGE
Outlet A: WELDED 3-BOLT FLANGE
Length: 20.50"



2004-02 6 NISSAN FRONTIER 3.3L
2004-02 6 NISSAN XTERRA 3.3L

641245

Inlet A: WELDED 6-BOLT FLANGE
Outlet A: WELDED 3-BOLT FLANGE
Length: 10.25"



2006-04 6 NISSAN ALTIMA 3.5L

641246

Inlet A: WELDED 8-BOLT FLANGE
Outlet A: WELDED 3-BOLT FLANGE
Length: 12"



2002-01 4 SATURN SC1 1.9L
2002-01 4 SATURN SL / SL1 1.9L

641247

Inlet A: WELDED 7-BOLT FLANGE
Outlet A: WELDED 2-BOLT FLANGE
Length: 21.75"



2007-05 4 FORD FOCUS 2.0L
2007-05 4 FORD FOCUS 2.3L

641250

Inlet A: LOOSE 2-BOLT FLANGE W/ SPHERICAL FLARE
Inlet B: LOOSE 2-BOLT FLANGE W/ SPHERICAL FLARE
Outlet A: WELDED 3-BOLT FLANGE
Length: 20.25"



2002-01 6 FORD RANGER 3.0L

641251

Inlet A: WELDED 3-BOLT FLANGE
Outlet A: WELDED 2-BOLT FLANGE
Length: 33.50"



2003-02 6 SATURN VUE 3.0L

DIRECT FIT



641252

Inlet A: WELDED 9-BOLT FLANGE
 Outlet A: WELDED 2-BOLT FLANGE
 Length: 14.75"



2009-04 4 KIA SPECTRA 2.0L

641255

Inlet A: WELDED 6-BOLT FLANGE
 Outlet A: WELDED 3-BOLT FLANGE
 Length: 23.25"



2009-03 6 TOYOTA 4 RUNNER 4.0L
 2009-07 6 TOYOTA FJ CRUISER 4.0L
 2008-05 6 TOYOTA TACOMA 4.0L
 2006-05 6 TOYOTA TUNDRA 4.0L

641253

Inlet A: WELDED 7-BOLT FLANGE
 Outlet A: WELDED 2-BOLT FLANGE
 Length: 14.50"



2004-01 6 HYUNDAI SANTA FE 2.7L

641256

Inlet A: WELDED 6-BOLT FLANGE
 Outlet A: WELDED 3-BOLT FLANGE
 Length: 25"



2009-03 6 TOYOTA 4 RUNNER 4.0L
 2009-07 6 TOYOTA FJ CRUISER 4.0L
 2008-05 6 TOYOTA TACOMA 4.0L
 2006-05 6 TOYOTA TUNDRA 4.0L

641254

Inlet A: WELDED 7-BOLT FLANGE
 Outlet A: WELDED 2-BOLT FLANGE
 Length: 15.25"



2006-01 6 HYUNDAI SANTA FE 2.7L

641257

Inlet A: WELDED 4-BOLT FLANGE
 Outlet A: WELDED 3-BOLT FLANGE
 Length: 14"



2006-03 6 ACURA MDX 3.5L
 2009-07 6 ACURA MDX 3.7L
 2008-04 6 ACURA TL 3.2L
 2008-07 6 ACURA TL 3.5L
 2007-03 6 HONDA ACCORD 3.0L
 2010-05 6 HONDA ODYSSEY 3.5L
 2008-05 6 HONDA PILOT 3.5L
 2008-06 6 HONDA RIDGELINE 3.5L
 2007-04 6 SATURN VUE 3.5L

641258

Inlet A: WELDED 4-BOLT FLANGE
Outlet A: WELDED 3-BOLT FLANGE
Length: 13.50"



- 2006-03 6 ACURA MDX 3.5L
- 2009-07 6 ACURA MDX 3.7L
- 2008-04 6 ACURA TL 3.2L
- 2008-07 6 ACURA TL 3.5L
- 2007-03 6 HONDA ACCORD 3.0L
- 2010-05 6 HONDA ODYSSEY 3.5L
- 2008-05 6 HONDA PILOT 3.5L
- 2008-06 6 HONDA RIDGELINE 3.5L
- 2007-04 6 SATURN VUE 3.5L

641260

Inlet A: WELDED 5-BOLT FLANGE
Outlet A: WELDED 2-BOLT FLANGE
Length: 7"



- 2006-03 6 HYUNDAI SANTA FE 3.5L

641261

Inlet A: WELDED 5-BOLT FLANGE
Outlet A: WELDED 2-BOLT FLANGE
Length: 8.63"



- 2006-03 6 HYUNDAI SANTA FE 3.5L

641264

Inlet A: WELDED 7-BOLT FLANGE
Outlet A: WELDED 3-BOLT FLANGE
Length: 22"



- 2008-06 4 FORD ESCAPE 2.3L
- 2008-06 4 MAZDA TRIBUTE 2.3L
- 2008-06 4 MERCURY MARINER 2.3L

641265

Inlet A: WELDED 6-BOLT FLANGE
Outlet A: WELDED 3-BOLT FLANGE
Length: 10"



- 2008-07 6 NISSAN ALTIMA 3.5L

DIRECT FIT



641266

Inlet A: WELDED 4-BOLT FLANGE
 Outlet A: WELDED 3-BOLT FLANGE
 Length: 12.50"



2008-07 6 NISSAN ALTIMA 3.5L

641267

Inlet A: WELDED 6-BOLT FLANGE
 Outlet A: WELDED 2-BOLT FLANGE
 Length: 16.50"



2008-06 6 MAZDA 6 3.0L

641268

Inlet A: WELDED 9-BOLT FLANGE
 Outlet A: WELDED 3-BOLT FLANGE
 Length: 21"



2004-01 6 CHEVROLET TRACKER 2.5L
 2005-99 6 SUZUKI VITARA, GRAND VITARA 2.5L

641269

Inlet A: WELDED 9-BOLT FLANGE
 Outlet A: WELDED 3-BOLT FLANGE
 Length: 21"



2004-01 6 CHEVROLET TRACKER 2.5L
 2005-99 6 SUZUKI VITARA, GRAND VITARA 2.5L

641270

Inlet A: WELDED 6-BOLT FLANGE
 Outlet A: WELDED 2-BOLT FLANGE
 Length: 16.50"



2008-06 6 MAZDA 6 3.0L

641271

Inlet A: WELDED 9-BOLT FLANGE
 Outlet A: WELDED 2-BOLT FLANGE
 Length: 14.75"



2012-03 4 HYUNDAI ELANTRA 2.0L

641272

Inlet A: WELDED 7-BOLT FLANGE
Outlet A: WELDED 2-BOLT FLANGE
Length: 22"



2007-04 4 FORD FOCUS 2.3L
2008-05 4 FORD FOCUS 2.0L

641275

Inlet A: WELDED 7-BOLT FLANGE
Outlet A: WELDED 2-BOLT FLANGE
Length: 14.50"

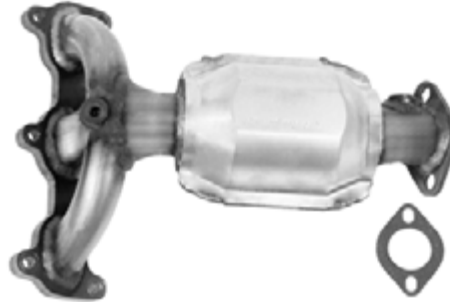

2009-07 6 HYUNDAI SANTA FE 2.7L

641273

Inlet A: WELDED 4-BOLT FLANGE
Outlet A: WELDED 3-BOLT FLANGE
Length: 14"



2010-08 6 HONDA ODYSSEY 3.5L

641274

Inlet A: WELDED 4-BOLT FLANGE
Outlet A: WELDED 3-BOLT FLANGE
Length: 14"



2010-08 6 HONDA ODYSSEY 3.5L

641276

Inlet A: WELDED 7-BOLT FLANGE
Outlet A: WELDED 2-BOLT FLANGE
Length: 12"



2009-07 6 HYUNDAI SANTA FE 2.7L

641277

Inlet A: WELDED 3-BOLT FLANGE
Outlet A: WELDED 2-BOLT FLANGE
Length: 40.25"



2010-08 6 PONTIAC G6 3.5L

DIRECT FIT



641278

Inlet A: WELDED 3-BOLT FLANGE
 Inlet B: WELDED 2-BOLT FLANGE
 Outlet A: WELDED 2-BOLT FLANGE
 Length: 29"



2010-08 6 PONTIAC G6 3.5L

641279

Inlet A: WELDED 7-BOLT FLANGE
 Outlet A: WELDED 2-BOLT FLANGE
 Length: 13.50"



2009-05 6 HYUNDAI TUCSON 2.7L

641280

Inlet A: WELDED 7-BOLT FLANGE
 Outlet A: WELDED 2-BOLT FLANGE
 Length: 14.50"



2009-05 6 HYUNDAI TUCSON 2.7L

641281

Inlet A: WELDED 6-BOLT FLANGE
 Outlet A: WELDED 2-BOLT FLANGE
 Length: 16"



2012-09 4 ACURA TSX 2.4L
 2012-08 4 HONDA ACCORD 2.4L

641282

Inlet A: WELDED 3-BOLT FLANGE
 Outlet A: WELDED 2-BOLT FLANGE
 Length: 14.50"



2008-07 6 FORD FUSION 3.0L
 2008-07 6 MERCURY MILAN 3.0L

641283

Inlet A: WELDED 7-BOLT FLANGE
 Outlet A: WELDED 3-BOLT FLANGE
 Length: 13.50"



2002-01 6 MAZDA 626 2.5L

641284

Inlet A: WELDED 5-BOLT FLANGE
Outlet A: WELDED 2-BOLT FLANGE
Length: 7.50"



2006-03 6 HYUNDAI SANTA FE 3.5L

641285

Inlet A: WELDED 5-BOLT FLANGE
Outlet A: WELDED 2-BOLT FLANGE
Length: 9"



2006-03 6 HYUNDAI SANTA FE 3.5L

641287

Inlet A: WELDED 5-BOLT FLANGE
Outlet A: WELDED 2-BOLT FLANGE
Length: 6.25"

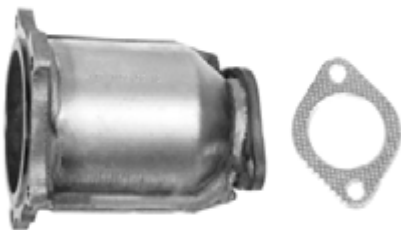

2006-03 6 KIA SORENTO 3.5L

641288

Inlet A: WELDED 12-BOLT FLANGE
Outlet A: WELDED 2-BOLT FLANGE
Length: 28.50"



2002 8 INFINITI Q45 4.5L

641289

Inlet A: WELDED 7-BOLT FLANGE
Outlet A: WELDED 2-BOLT FLANGE
Length: 12.50"



2010-06 6 MITSUBISHI ECLIPSE 3.8L
2009-07 6 MITSUBISHI GALANT 3.8L

641290

Inlet A: WELDED 6-BOLT FLANGE
Outlet A: WELDED 2-BOLT FLANGE
Length: 17"



2006-04 6 TOYOTA SIENNA 3.3L

DIRECT FIT



641291

Inlet A: WELDED 7-BOLT FLANGE
 Outlet A: WELDED 2-BOLT FLANGE
 Length: 26"



2008-06 4 MAZDA MIATA, MX5 2.0L

641292

Inlet A: WELDED 7-BOLT FLANGE
 Outlet A: WELDED 2-BOLT FLANGE
 Length: 16"



2010-06 6 MITSUBISHI ECLIPSE 3.8L
 2009-07 6 MITSUBISHI GALANT 3.8L

641293

Inlet A: WELDED 6-BOLT FLANGE
 Outlet A: WELDED 2-BOLT FLANGE
 Length: 14"



2011-07 6 LEXUS ES350 3.5L
 2012-05 6 TOYOTA AVALON 3.5L
 2011-07 6 TOYOTA CAMRY, (Inc. 1998 & Older SOLARA) 3.5L

641294

Inlet A: WELDED 6-BOLT FLANGE
 Outlet A: WELDED 2-BOLT FLANGE, BENT BRACKET
 Length: 15"

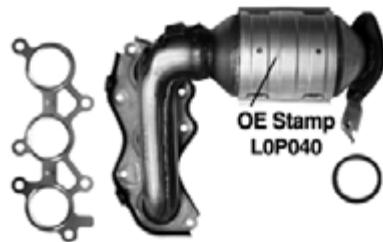

2012-05 6 TOYOTA AVALON 3.5L
 2011-10 6 TOYOTA CAMRY, (Inc. 1998 & Older SOLARA) 3.5L
 2012-09 6 TOYOTA VENZA 3.5L

641295

Inlet A: WELDED 6-BOLT FLANGE
 Outlet A: WELDED 2-BOLT FLANGE, STRAIGHT BRACKET
 Length: 15"

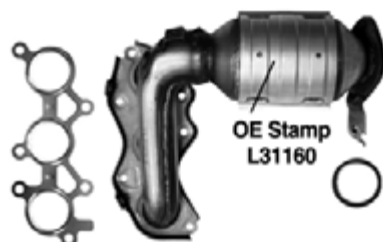

2011-07 6 LEXUS ES350 3.5L
 2008-06 6 TOYOTA AVALON 3.5L
 2009-07 6 TOYOTA CAMRY, (Inc. 1998 & Older SOLARA) 3.5L

641296

Inlet A: WELDED 6-BOLT FLANGE
 Outlet A: WELDED 2-BOLT FLANGE
 Length: 13.50"



2012-09 6 TOYOTA VENZA 3.5L

641297

Inlet A: WELDED 6-BOLT FLANGE
Outlet A: WELDED 2 BOLT FLANGE
Length: 13.50"



2009-08 6 TOYOTA HIGHLANDER 3.5L
2010-07 6 TOYOTA SIENNA 3.5L

641298

Inlet A: WELDED 6-BOLT FLANGE
Outlet A: WELDED 2-BOLT FLANGE
Length: 13.50"

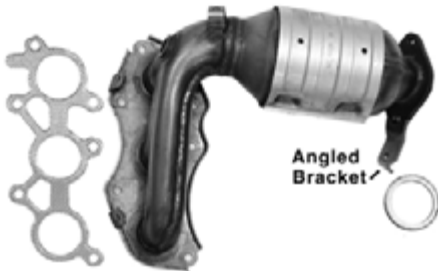

2009-07 6 LEXUS RX350 3.5L
2012-06 6 TOYOTA RAV4 3.5L
2010-07 6 TOYOTA SIENNA 3.5L

641299

Inlet A: WELDED 6-BOLT FLANGE
Outlet A: WELDED 2-BOLT FLANGE
Length: 16"



2009-07 6 LEXUS RX350 3.5L
2010-08 6 TOYOTA HIGHLANDER 3.5L
2010-07 6 TOYOTA SIENNA 3.5L

641300

Inlet A: WELDED 6-BOLT FLANGE
Outlet A: WELDED 2-BOLT FLANGE
Length: 14.50"

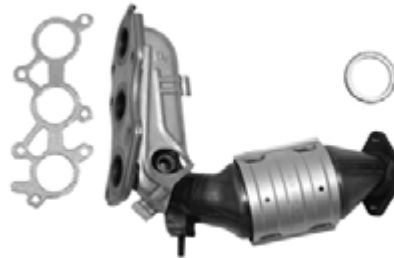

2010-07 6 TOYOTA SIENNA 3.5L

641301

Inlet A: WELDED 6-BOLT FLANGE
Outlet A: WELDED 2-BOLT FLANGE
Length: 14.50"



2012-06 6 TOYOTA RAV4 3.5L

641302

Inlet A: WELDED 5-BOLT FLANGE
Outlet A: WELDED 3-BOLT FLANGE
Length: 19"

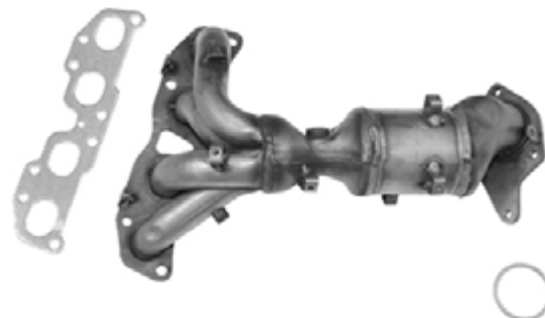

2012-07 4 NISSAN ALTIMA 2.5L

DIRECT FIT



641303

Inlet A: WELDED 5-BOLT FLANGE
 Outlet A: WELDED 2-BOLT FLANGE
 Length: 19.50"

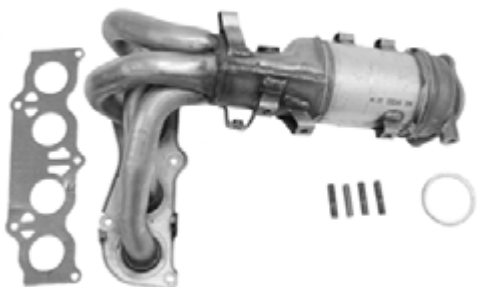

2009-07 4 TOYOTA CAMRY, (Inc. 1998 & Older SOLARA) 2.4L
 2008-06 4 TOYOTA SOLARA 2.4L

641306

Inlet A: WELDED 6-BOLT FLANGE
 Outlet A: WELDED 2-BOLT FLANGE
 Length: 14"



2006-04 6 LEXUS ES330 3.3L
 2006-04 6 TOYOTA CAMRY, (Inc. 1998 & Older SOLARA) 3.3L
 2008-04 6 TOYOTA SOLARA 3.3L

641304

Inlet A: WELDED 5-BOLT FLANGE
 Outlet A: WELDED 2-BOLT FLANGE
 Length: 19"



2009-07 4 TOYOTA CAMRY, (Inc. 1998 & Older SOLARA) 2.4L

641307

Inlet A: WELDED 6-BOLT FLANGE
 Outlet A: WELDED 2-BOLT FLANGE
 Length: 15.50"

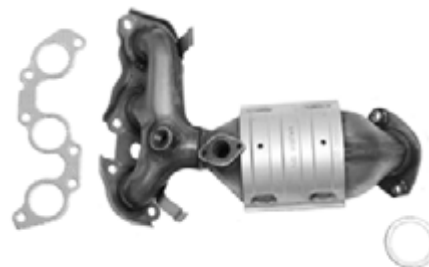

2003-02 6 LEXUS ES300 3.0L
 2006-02 6 TOYOTA CAMRY, (Inc. 1998 & Older SOLARA) 3.0L

641305

Inlet A: WELDED 6-BOLT FLANGE
 Outlet A: WELDED 2-BOLT FLANGE
 Length: 14.50"



2003-02 6 LEXUS ES300 3.0L
 2006-02 6 TOYOTA CAMRY, (Inc. 1998 & Older SOLARA) 3.0L

641308

Inlet A: WELDED 6-BOLT FLANGE
 Outlet A: WELDED 2-BOLT FLANGE
 Length: 15"



2006-04 6 LEXUS ES330 3.3L
 2006-04 6 TOYOTA CAMRY, (Inc. 1998 & Older SOLARA) 3.3L
 2008-04 6 TOYOTA SOLARA 3.3L

641310

Inlet A: WELDED 8-BOLT FLANGE
Outlet A: WELDED 2-BOLT FLANGE
Length: 13.50"

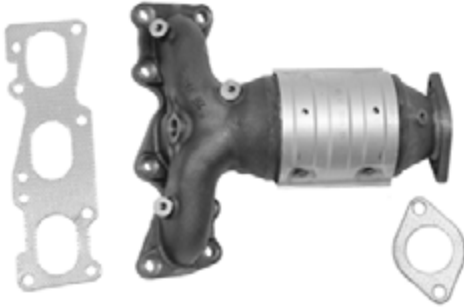

- 2008-07 6 HYUNDAI AZERA 3.3L
- 2010-06 6 HYUNDAI AZERA 3.8L
- 2008-07 6 HYUNDAI ENTOURAGE 3.8L
- 2007-06 6 HYUNDAI SONATA 3.3L
- 2009-07 6 KIA AMANTI 3.8L
- 2010-06 6 KIA SEDONA 3.8L

641311

Inlet A: WELDED 8-BOLT FLANGE
Outlet A: WELDED 2-BOLT FLANGE
Length: 13"



- 2008-07 6 HYUNDAI AZERA 3.3L
- 2010-06 6 HYUNDAI AZERA 3.8L
- 2008-07 6 HYUNDAI ENTOURAGE 3.8L
- 2007-06 6 HYUNDAI SONATA 3.3L
- 2009-07 6 KIA AMANTI 3.8L
- 2010-06 6 KIA SEDONA 3.8L

641312

Inlet A: WELDED 9-BOLT FLANGE
Outlet A: WELDED 2-BOLT FLANGE
Length: 20"



- 2010-06 4 HYUNDAI ELANTRA 2.0L

641312 (cont.)

- 2009-08 4 KIA SPECTRA 2.0L
- 2009-08 4 KIA SPECTRA5 2.0L

641313

Inlet A: WELDED 9-BOLT FLANGE
Outlet A: WELDED 2-BOLT FLANGE
Length: 15.25"

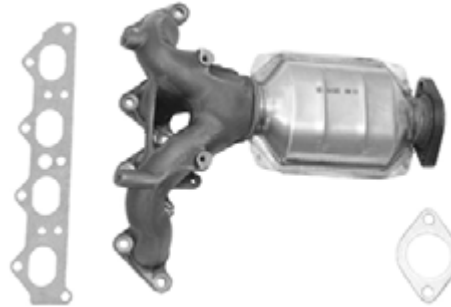

- 2006-05 4 HYUNDAI TUCSON 2.0L
- 2008-05 4 KIA SPORTAGE 2.0L

641314

Inlet A: WELDED 6-BOLT FLANGE
Outlet A: WELDED 3-BOLT FLANGE
Length: 10.50"



- 2006-04 6 NISSAN MAXIMA 3.5L
- 2009-04 6 NISSAN QUEST 3.5L

641315

Inlet A: WELDED 6-BOLT FLANGE
Outlet A: WELDED 3-BOLT FLANGE
Length: 12"



- 2008-04 6 NISSAN MAXIMA 3.5L
- 2006-04 6 NISSAN QUEST 3.5L

DIRECT FIT



641316

Inlet A: WELDED 4-BOLT FLANGE
Outlet A: WELDED 3-BOLT FLANGE
Length: 9"



2000-99 4 MAZDA MIATA, MX5 1.8L

641317

Inlet A: WELDED 3-BOLT FLANGE
Outlet A: WELDED 2-BOLT FLANGE W/ GASKET STUB
Length: 20"



2003-02 4 SUZUKI AERIO 2.0L

641318

Inlet A: WELDED 3-BOLT FLANGE
Outlet A: WELDED 2-BOLT FLANGE
Length: 33"



2003-02 6 SATURN VUE 3.0L

641320

Inlet A: WELDED 5-BOLT FLANGE
Outlet A: WELDED 2-BOLT FLANGE W/ GASKET STUB
Length: 19"



2003-02 4 NISSAN ALTIMA 2.5L
2006-02 4 NISSAN SENTRA 2.5L

641321

Inlet A: WELDED 7-BOLT FLANGE
Outlet A: WELDED 2-BOLT FLANGE
Length: 26"



2009-07 4 FORD FUSION 2.3L
2009-07 4 MERCURY MILAN 2.3L

641322

Inlet A: WELDED 4-BOLT FLANGE
Outlet A: WELDED 2-BOLT FLANGE W/ GASKET STUB
Length: 20.25"



2011-06 4 HONDA CIVIC 1.8L

641327

Inlet A: WELDED 7-BOLT FLANGE
Outlet A: WELDED 2-BOLT FLANGE
Length: 12.75"



2009-05 6 HYUNDAI TUCSON 2.7L
2010-05 6 KIA SPORTAGE 2.7L

641325

Inlet A: WELDED 4-BOLT FLANGE
Outlet A: WELDED 2-BOLT FLANGE
Length: 14.50"



2011-10 6 CHEVROLET EQUINOX 3.0L
2011-10 6 GMC TERRAIN 3.0L

641329

Inlet A: WELDED 6-BOLT FLANGE
Outlet A: WELDED 2-BOLT FLANGE W/ GASKET STUB
Length: 22.50"



2012-06 6 FORD FUSION 3.0L
2006 6 LINCOLN ZEPHYR 3.0L
2011-06 6 MERCURY MILAN 3.0L

641326

Inlet A: WELDED 4-BOLT FLANGE
Outlet A: WELDED 2-BOLT FLANGE
Length: 15.38"



2011-10 6 CHEVROLET EQUINOX 3.0L
2011-10 6 GMC TERRAIN 3.0L

641330

Inlet A: WELDED 8-BOLT FLANGE
Outlet A: WELDED 2-BOLT FLANGE
Length: 28.38"



2009-05 8 LEXUS GX470 4.7L
2009-05 8 TOYOTA 4 RUNNER 4.7L

DIRECT FIT



641331

Inlet A: WELDED 8-BOLT FLANGE
 Outlet A: WELDED 2-BOLT FLANGE
 Length: 28.75"



- 2009-05 8 LEXUS GX470 4.7L
- 2009-05 8 TOYOTA 4 RUNNER 4.7L

641334

Inlet A: WELDED 4-BOLT FLANGE
 Outlet A: WELDED 3-BOLT FLANGE
 Length: 13.75"

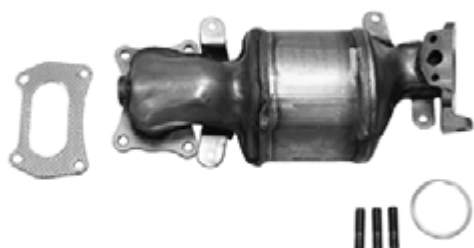

- 2014-13 6 ACURA RDX 3.5L
- 2009 6 ACURA RL 3.7L
- 2014-09 6 ACURA TL 3.5L
- 2014-09 6 ACURA TL 3.7L
- 2014-10 6 ACURA TSX 3.5L
- 2013-10 6 ACURA ZDX 3.7L
- 2011-10 6 HONDA ACCORD CROSSTOUR 3.5L
- 2015-08 6 HONDA ACCORD 3.5L
- 2014-12 6 HONDA CROSSTOUR 3.5L
- 2014-11 6 HONDA ODYSSEY 3.5L
- 2015-09 6 HONDA PILOT 3.5L
- 2014-09 6 HONDA RIDGELINE 3.5L

641332

Inlet A: WELDED 8-BOLT FLANGE
 Outlet A: WELDED 2-BOLT FLANGE
 Length: 13.50"



- 2009-07 6 HYUNDAI SANTA FE 3.3L
- 2012-07 6 HYUNDAI VERACRUZ 3.8L

641338

Inlet A: WELDED 9-BOLT FLANGE
 Outlet A: WELDED 3-BOLT FLANGE W/ GASKET STUB
 Length: 27.13"



- 2012-07 5 CHEVROLET COLORADO 3.7L
- 2012-07 5 GMC CANYON 3.7L
- 2008-07 5 HUMMER H3 3.7L
- 2008-07 5 ISUZU I-370 3.7L

641333

Inlet A: WELDED 8-BOLT FLANGE
 Outlet A: WELDED 2-BOLT FLANGE
 Length: 13.50"



- 2009-07 6 HYUNDAI SANTA FE 3.3L
- 2012-07 6 HYUNDAI VERACRUZ 3.8L

641339

Inlet A: WELDED 7-BOLT FLANGE
Outlet A: WELDED 3-BOLT FLANGE W/ GASKET STUB
Length: 24.25"



2012-07 4 CHEVROLET COLORADO 2.9L
2012-07 4 GMC CANYON 2.9L
2008-07 4 ISUZU I-290 2.9L

641340

Inlet A: WELDED 7-BOLT FLANGE
Outlet A: WELDED 2-BOLT FLANGE
Length: 12"



2009-07 6 HYUNDAI SANTA FE 2.7L

641343

Inlet A: WELDED 10-BOLT FLANGE
Outlet A: WELDED 3-BOLT FLANGE
Length: 17.75"



2008-04 4 CHEVROLET MALIBU 2.2L

641343 (cont.)

2010-08 4 CHEVROLET MALIBU 2.4L
2010-06 4 PONTIAC G6 2.4L
2009-07 4 SATURN AURA 2.4L

641344

Inlet A: WELDED 9-BOLT FLANGE
Outlet A: WELDED 2-BOLT FLANGE
Length: 15.13"

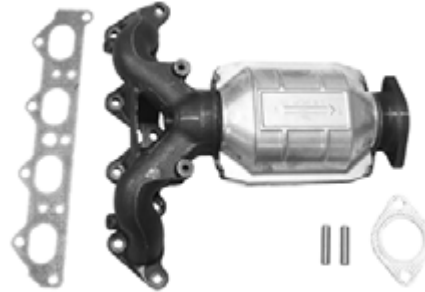

2012-03 4 HYUNDAI ELANTRA 2.0L
2008-07 4 HYUNDAI TIBURON 2.0L
2011-10 4 KIA SOUL 2.0L
2009-04 4 KIA SPECTRA 2.0L
2009-06 4 KIA SPECTRA5 2.0L

641355

Inlet A: WELDED 4-BOLT FLANGE
Outlet A: WELDED 3-BOLT FLANGE
Length: 13.75"



2006-03 6 ACURA MDX 3.5L
2009-07 6 ACURA MDX 3.7L
2008-04 6 ACURA TL 3.2L
2008-07 6 ACURA TL 3.5L
2007-03 6 HONDA ACCORD 3.0L
2010-05 6 HONDA ODYSSEY 3.5L
2008-05 6 HONDA PILOT 3.5L
2008-06 6 HONDA RIDGELINE 3.5L
2007-04 6 SATURN VUE 3.5L

DIRECT FIT



641356

Inlet A: WELDED 4-BOLT FLANGE
 Outlet A: WELDED 3-BOLT FLANGE
 Length: 13.90"

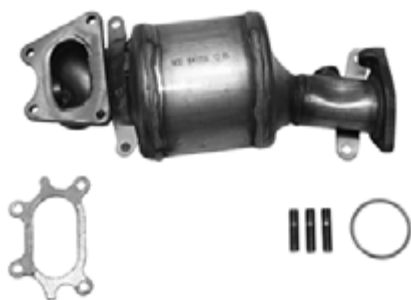

- 2006-03 6 ACURA MDX 3.5L
- 2009-07 6 ACURA MDX 3.7L
- 2008-04 6 ACURA TL 3.2L
- 2008-07 6 ACURA TL 3.5L
- 2007-03 6 HONDA ACCORD 3.0L
- 2010-05 6 HONDA ODYSSEY 3.5L
- 2008-05 6 HONDA PILOT 3.5L
- 2008-06 6 HONDA RIDGELINE 3.5L
- 2007-04 6 SATURN VUE 3.5L

641374

Inlet A: WELDED 9-BOLT FLANGE
 Outlet A: WELDED 3-BOLT FLANGE
 Length: 13.63"



- 2007-02 4 MITSUBISHI LANCER 2.0L

641375

Inlet A: WELDED 6-BOLT FLANGE
 Outlet A: WELDED 4-BOLT FLANGE
 Length: 15"



- 2004-02 6 VOLVO S80 2.9L

641376

Inlet A: WELDED 6-BOLT FLANGE
 Outlet A: WELDED 4-BOLT FLANGE
 Length: 15"



- 2004-02 6 VOLVO S80 2.9L

641377

Inlet A: WELDED 5-BOLT FLANGE
 Outlet A: WELDED 2-BOLT FLANGE W/GASKET STUB
 Length: 17.50"



- 2005-03 4 HONDA CIVIC 1.3L

641378

Inlet A: WELDED 6-BOLT FLANGE
 Outlet A: WELDED 3-BOLT FLANGE
 Length: 18"



- 2006-04 6 SUZUKI VERONA 2.5L

641379

Inlet A: WELDED 8-BOLT FLANGE
Outlet A: WELDED 3-BOLT FLANGE
Length: 17"



2006-04 6 SUZUKI VERONA 2.5L

641380

Inlet A: WELDED 3-BOLT FLANGE
Outlet A: WELDED 3-BOLT FLANGE
Length: 8.25"



2000-98 6 CHRYSLER SEBRING 2.5L
2000-98 6 DODGE AVENGER 2.5L

641381

Inlet A: WELDED 3-BOLT FLANGE
Outlet A: WELDED 3-BOLT FLANGE
Length: 12"



2000-98 6 CHRYSLER SEBRING 2.5L
2000-98 6 DODGE AVENGER 2.5L

641382

Inlet A: WELDED 6-BOLT FLANGE
Outlet A: WELDED 2-BOLT FLANGE W/GASKET STUB
Length: 19"



2007 6 CHRYSLER PACIFICA 4.0L

641383

Inlet A: WELDED 2-BOLT FLANGE
Outlet A: WELDED 2-BOLT FLANGE W/MALE BALL
Length: 18"



2016-11 6 CHRYSLER TOWN & COUNTRY 3.6L
2014-11 6 DODGE AVENGER 3.6L
2016-11 6 DODGE CARAVAN 3.6L
2014-11 6 DODGE JOURNEY 3.6L

641384

Inlet A: WELDED 2-BOLT FLANGE
Outlet A: WELDED 2-BOLT FLANGE
Length: 18"



2016-11 6 CHRYSLER TOWN & COUNTRY 3.6L
2014-11 6 DODGE AVENGER 3.6L
2016-11 6 DODGE CARAVAN 3.6L
2014-11 6 DODGE JOURNEY 3.6L

DIRECT FIT



641385

Inlet A: LOOSE 2-BOLT FLANGE W/ FLARE
 Inlet B: LOOSE 2-BOLT FLANGE W/ FLARE
 Outlet A: WELDED 3-BOLT FLANGE
 Length: 15.50"



2005-04 6 FORD EXPLORER 4.0L

641388

Inlet A: WELDED 6-BOLT FLANGE
 Outlet A: WELDED 2-BOLT FLANGE
 Length: 14"



2014-11 6 FORD EDGE 3.5L
 2014-11 6 FORD EDGE 3.7L
 2013-11 6 FORD EXPLORER 3.5L
 2014-11 6 LINCOLN MKX 3.7L

641386

Inlet A: WELDED 6-BOLT FLANGE
 Outlet A: WELDED 2-BOLT FLANGE W/MALE BALL
 Length: 16.5"



2008 6 FORD ESCAPE 3.0L
 2008 6 MAZDA TRIBUTE 3.0L
 2008 6 MERCURY MARINER 3.0L

641389

Inlet A: WELDED 4-BOLT FLANGE
 Outlet A: WELDED 2-BOLT FLANGE
 Length: 11.25"



2013-11 6 FORD EDGE 3.5L
 2013-11 6 FORD EXPLORER 3.5L
 2014-11 6 LINCOLN MKX 3.7L

641387

Inlet A: WELDED 3-BOLT FLANGE
 Outlet A: WELDED 2-BOLT FLANGE
 Length: 14.63"



2012-10 6 FORD FUSION 3.0L
 2011-10 6 MERCURY MILAN 3.0L

641390

Inlet A: WELDED 7-BOLT FLANGE
 Outlet A: WELDED 2-BOLT FLANGE
 Length: 32"



2010-09 4 FORD FOCUS 2.0L

641391

Inlet A: WELDED 6-BOLT FLANGE
Outlet A: WELDED 2-BOLT FLANGE W/MALE BALL
Length: 14.63"

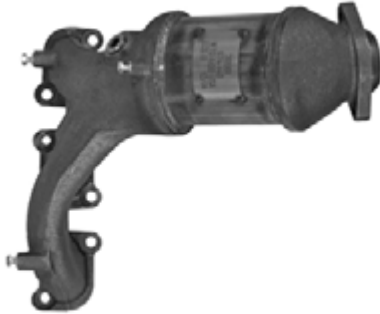

2012-09 6 FORD ESCAPE 3.0L
2011-09 6 MAZDA TRIBUTE 3.0L

641392

Inlet A: WELDED 3-BOLT FLANGE
Outlet A: WELDED 2-BOLT FLANGE
Length: 10"



2012-10 6 FORD ESCAPE 3.0L
2011-09 6 MAZDA TRIBUTE 3.0L
2011-10 6 MERCURY MARINER 3.0L

641393

Inlet A: WELDED 4-BOLT FLANGE
Outlet A: WELDED 2-BOLT FLANGE
Length: 11.50"



2013-09 6 MAZDA 6 3.7L
2007 6 MAZDA CX-9 3.5L
2015-08 6 MAZDA CX-9 3.7L

641394

Inlet A: WELDED 6-BOLT FLANGE
Inlet B: WELDED 3-BOLT FLANGE
Outlet A: WELDED 2-BOLT FLANGE
Length: 22"



2002-99 6 MERCURY VILLAGER 3.3L
2002-99 6 NISSAN QUEST 3.3L

641395

Inlet A: WELDED 8-BOLT FLANGE
Outlet A: WELDED 2-BOLT FLANGE
Length: 34"



2008-02 4 MINI COOPER 1.6L

641396

Inlet A: WELDED 8-BOLT FLANGE
Outlet A: WELDED 2-BOLT FLANGE
Length: 32"



2003-01 6 BMW 525 2.5L
2003-01 6 BMW 530 3.0L
2006-01 6 BMW X5 3.0L

DIRECT FIT



641397

Inlet A: WELDED 8-BOLT FLANGE
 Outlet A: WELDED 2-BOLT FLANGE
 Length: 23"



- 2003-01 6 BMW 525 2.5L
- 2003-01 6 BMW 530 3.0L
- 2006-01 6 BMW X5 3.0L

641398

Inlet A: WELDED 7-BOLT FLANGE
 Outlet A: WELDED 2-BOLT FLANGE
 Length: 18"



- 2012-06 6 MITSUBISHI ECLIPSE 3.8L
- 2009-04 6 MITSUBISHI GALANT 3.8L

641399

Inlet A: WELDED 6-BOLT FLANGE
 Outlet A: WELDED 2-BOLT FLANGE
 Length: 17"



- 2008-06 6 LEXUS RX400H 3.3L
- 2010-06 6 TOYOTA HIGHLANDER 3.3L

641400

Inlet A: WELDED 5-BOLT FLANGE
 Outlet A: WELDED 2-BOLT FLANGE W/MALE BALL
 Length: 21"



- 2010-09 4 PONTIAC VIBE 2.4L
- 2010-07 4 SCION TC 2.4L
- 2010-09 4 TOYOTA COROLLA 2.4L
- 2013-09 4 TOYOTA MATRIX 2.4L

641401

Inlet A: WELDED 3-BOLT FLANGE W/ MALE BALL
 Outlet A: WELDED 5-BOLT FLANGE
 Length: 14"



- 2011-05 4 SAAB 9-3 2.0L

641402

Inlet A: WELDED 5-BOLT FLANGE
 Outlet A: WELDED 3-BOLT FLANGE
 Length: 18"



- 2005-00 4 TOYOTA MR2 SPYDER 1.8L

641403

Inlet A: WELDED 6-BOLT FLANGE
Outlet A: WELDED 2-BOLT FLANGE
Length: 28.50"



2012-06 6 LEXUS IS250 2.5L

641404

Inlet A: WELDED 6-BOLT FLANGE
Outlet A: WELDED 2-BOLT FLANGE
Length: 28.50"



2012-06 6 LEXUS IS250 2.5L

641405

Inlet A: WELDED 6-BOLT FLANGE
Outlet A: WELDED 2-BOLT FLANGE
Length: 34"



2009-06 4 MAZDA 3 2.3L
2010-08 4 MAZDA 5 2.3L

641406

Inlet A: WELDED 8-BOLT FLANGE
Outlet A: WELDED 2-BOLT FLANGE
Length: 30"



2006-04 4 MAZDA 3 2.0L

641407

Inlet A: WELDED 5-BOLT FLANGE
Outlet A: WELDED 3-BOLT FLANGE
Length: 23"



2016-05 4 NISSAN FRONTIER 2.5L
2012-09 4 SUZUKI EQUATOR 2.5L

641408

Inlet A: WELDED 7-BOLT FLANGE
Outlet A: WELDED 2-BOLT FLANGE W/GASKET STUB
Length: 23"

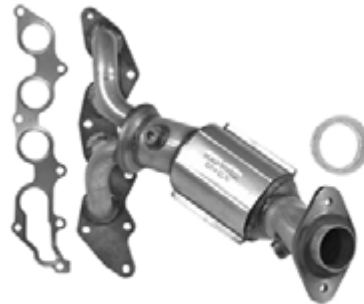

2006-05 4 MAZDA 6 2.3L

641409

Inlet A: WELDED 5-BOLT FLANGE
Outlet A: WELDED 2-BOLT FLANGE W/GASKET STUB
Length: 21"



2013-11 4 SCION TC 2.5L
2012-09 4 TOYOTA RAV4 2.5L

DIRECT FIT



641410

Inlet A: WELDED 7-BOLT FLANGE
 Outlet A: WELDED 2-BOLT FLANGE
 Length: 32.75"



2006-04 4 MAZDA 3 2.0L

641411

Inlet A: WELDED 4-BOLT FLANGE
 Outlet A: WELDED 3-BOLT FLANGE
 Length: 14"



2013-07 6 MITSUBISHI OUTLANDER 3.0L

641412

Inlet A: WELDED 4-BOLT FLANGE
 Outlet A: WELDED 2-BOLT FLANGE
 Length: 14"



2013-07 6 MITSUBISHI OUTLANDER 3.0L

641413

Inlet A: WELDED 4-BOLT FLANGE
 Outlet A: WELDED 3-BOLT FLANGE
 Length: 14"



2014-13 6 ACURA RDX 3.5L
 2009 6 ACURA RL 3.7L
 2014-09 6 ACURA TL 3.5L
 2014-09 6 ACURA TL 3.7L
 2014-10 6 ACURA TSX 3.5L
 2013-10 6 ACURA ZDX 3.7L
 2011-10 6 HONDA ACCORD CROSSTOUR 3.5L

641413 (cont.)

2015-08 6 HONDA ACCORD 3.5L
 2014-12 6 HONDA CROSSTOUR 3.5L
 2014-11 6 HONDA ODYSSEY 3.5L
 2011-09 6 HONDA PILOT 3.5L
 2011-09 6 HONDA RIDGELINE 3.5L

641414

Inlet A: WELDED 5-BOLT FLANGE
 Outlet A: WELDED 2-BOLT FLANGE W/GASKET STUB
 Length: 21"



2007-04 4 TOYOTA HIGHLANDER 2.4L

641415

Inlet A: WELDED 4-BOLT FLANGE
 Outlet A: WELDED 2-BOLT FLANGE W/GASKET STUB
 Length: 14"



2011-10 4 HONDA CRV 2.4L

641416

Inlet A: WELDED 9-BOLT FLANGE
 Outlet A: WELDED 4-BOLT FLANGE
 Length: 22"



2008-06 6 SUZUKI VITARA, GRAND VITARA 2.7L
 2006-04 6 SUZUKI XL-7 2.7L

641417

Inlet A: WELDED 9-BOLT FLANGE
Outlet A: WELDED 4-BOLT FLANGE
Length: 21"



2008-06 6 SUZUKI VITARA, GRAND VITARA 2.7L
2006-04 6 SUZUKI XL-7 2.7L

641418

Inlet A: WELDED 3-BOLT FLANGE
Outlet A: 2.25" O.D. PIPE
Length: 17"



2003-02 6 JAGUAR X-TYPE 2.5L
2003-02 6 JAGUAR X-TYPE 3.0L

641419

Inlet A: WELDED 3-BOLT FLANGE
Outlet A: 60MM I.D. PIPE
Length: 17"



2003-02 6 JAGUAR X-TYPE 2.5L
2003-02 6 JAGUAR X-TYPE 3.0L

641420

Inlet A: WELDED 10-BOLT FLANGE
Outlet A: FLARED PIPE
Length: 19.25"



2015-07 4 MINI COOPER 1.6L

641421

Inlet A: WELDED 6-BOLT FLANGE
Outlet A: WELDED 3-BOLT FLANGE W/GASKET STUB
Length: 14.75"



2011-06 4 HONDA CIVIC 1.3L

641422

Inlet A: WELDED 8-BOLT FLANGE
Outlet A: WELDED 4-BOLT FLANGE
Length: 13.50"



2012-08 8 LAND ROVER LR2 3.2L

DIRECT FIT



641423

Inlet A: WELDED 8-BOLT FLANGE
 Outlet A: WELDED 4-BOLT FLANGE
 Length: 13.50"



2012-08 8 LAND ROVER LR2 3.2L

641424

Inlet A: WELDED 6-BOLT FLANGE
 Outlet A: WELDED 3-BOLT FLANGE
 Length: 10.25"

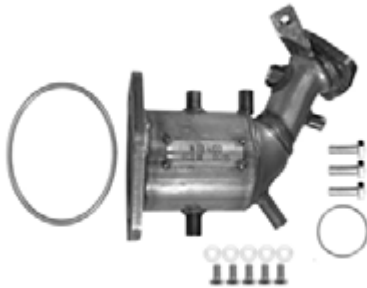

2015-09 6 NISSAN MAXIMA 3.5L

641425

Inlet A: WELDED 4-BOLT FLANGE
 Outlet A: WELDED 3-BOLT FLANGE
 Length: 11.50"



2015-09 6 NISSAN MAXIMA 3.5L

641426

Inlet A: WELDED 12-BOLT FLANGE
 Outlet A: WELDED 4-BOLT FLANGE
 Length: 20"



2006-04 5 VOLVO S40/V40 2.4L
 2006-05 5 VOLVO V50 2.4L

641427

Inlet A: WELDED 5-BOLT FLANGE
 Outlet A: WELDED 3-BOLT FLANGE
 Length: 21"



2015-13 4 NISSAN ALTIMA 2.5L

641428

Inlet A: WELDED 5-BOLT FLANGE
 Outlet A: WELDED 3-BOLT FLANGE
 Length: 17.75"



2015-14 4 NISSAN ROGUE SELECT 2.5L
 2013-08 4 NISSAN ROGUE 2.5L
 2008-07 4 NISSAN X-TRAIL 2.5L

641429

Inlet A: WELDED 3-BOLT FLANGE
Outlet A: WELDED 2-BOLT FLANGE
Length: 14"



2012-10 4 HYUNDAI GENESIS COUPE 2.0L

641430

Inlet A: V-BAND CLAMP
Outlet A: WELDED 2-BOLT FLANGE W/GASKET STUB
Length: 21"



2011-10 8 BMW 550I GT XDRIVE 4.4L
2011-10 8 BMW 550I GT 4.4L
2011 8 BMW 550I XDRIVE 4.4L
2011 8 BMW 550I 4.4L
2012 8 BMW 650I XDRIVE 4.4L
2012 8 BMW 650I 4.4L
2011-10 8 BMW 750I XDRIVE 4.4L
2011-09 8 BMW 750I 4.4L
2011-10 8 BMW 750LI XDRIVE 4.4L
2011-10 8 BMW 750LI 4.4L
2011-10 8 BMW X5 4.4L
2011-08 8 BMW X6 4.4L

641431

Inlet A: V-BAND CLAMP
Outlet A: WELDED 2-BOLT FLANGE W/GASKET STUB
Length: 22"



2011-10 8 BMW 550I GT XDRIVE 4.4L
2011-10 8 BMW 550I GT 4.4L

641431 (cont.)

2011 8 BMW 550I XDRIVE 4.4L
2011 8 BMW 550I 4.4L
2012 8 BMW 650I XDRIVE 4.4L
2012 8 BMW 650I 4.4L
2011-10 8 BMW 750I XDRIVE 4.4L
2011-09 8 BMW 750I 4.4L
2011-10 8 BMW 750LI XDRIVE 4.4L
2011-10 8 BMW 750LI 4.4L
2011-10 8 BMW X5 4.4L
2011-08 8 BMW X6 4.4L

641432

Inlet A: WELDED 5-BOLT FLANGE
Outlet A: WELDED 5-BOLT FLANGE W/MALE BALL
Length: 14"



2012-09 4 NISSAN SENTRA 2.0L

641433

Inlet A: WELDED 8-BOLT FLANGE
Outlet A: WELDED 4-BOLT FLANGE
Length: 13"



2010-07 6 VOLVO XC90 3.2L

DIRECT FIT



641434

Inlet A: WELDED 8-BOLT FLANGE
 Outlet A: WELDED 4-BOLT FLANGE
 Length: 15.50"



2010-07 6 VOLVO XC90 3.2L

641435

Inlet A: WELDED 8-BOLT FLANGE
 Outlet A: WELDED 2-BOLT FLANGE
 Length: 28"



2005-03 8 LEXUS GX470 4.7L
 2004-03 8 TOYOTA 4 RUNNER 4.7L

641436

Inlet A: WELDED 8-BOLT FLANGE
 Outlet A: WELDED 2-BOLT FLANGE
 Length: 28"



2005-03 8 LEXUS GX470 4.7L
 2004-03 8 TOYOTA 4 RUNNER 4.7L

641437

Inlet A: WELDED 8-BOLT FLANGE
 Outlet A: WELDED 2-BOLT FLANGE
 Length: 32"



2005-04 6 BMW 525 2.5L
 2005-04 6 BMW 530 3.0L

641438

Inlet A: WELDED 8-BOLT FLANGE
 Outlet A: WELDED 2-BOLT FLANGE
 Length: 21"



2005-04 6 BMW 525 2.5L
 2005-04 6 BMW 530 3.0L

641439

Inlet A: WELDED 7-BOLT FLANGE
 Outlet A: WELDED 2-BOLT FLANGE
 Length: 14"



2009-07 6 HYUNDAI SANTA FE 2.7L
 2008-06 6 KIA OPTIMA 2.7L
 2010-07 6 KIA RONDO 2.7L

641440

Inlet A: WELDED 3-BOLT FLANGE
Outlet A: 3.13" FLARE
Length: 23.50"



2015-07 4 MINI COOPER 1.6L

641441

Inlet A: WELDED 7-BOLT FLANGE
Outlet A: WELDED 2-BOLT FLANGE
Length: 15.25"



2008-05 6 HYUNDAI TUCSON 2.7L
2010-05 6 KIA SPORTAGE 2.7L

641442

Inlet A: WELDED 8-BOLT FLANGE
Outlet A: WELDED 2-BOLT FLANGE
Length: 29"



2009-04 8 CADILLAC SRX 4.6L
2010-05 8 CADILLAC STS 4.6L

641443

Inlet A: WELDED 8-BOLT FLANGE
Outlet A: WELDED 2-BOLT FLANGE
Length: 29"



2009-04 8 CADILLAC SRX 4.6L
2010-05 8 CADILLAC STS 4.6L

641444

Inlet A: WELDED 4-BOLT FLANGE
Outlet A: WELDED 2-BOLT FLANGE
Length: 16"



2010 6 BUICK ALLURE 3.0L
2010 6 BUICK LACROSSE 3.0L

641445

Inlet A: WELDED 4-BOLT FLANGE
Outlet A: WELDED 2-BOLT FLANGE
Length: 12.75"



2010 6 BUICK ALLURE 3.0L
2010 6 BUICK LACROSSE 3.0L

641447

Inlet A: WELDED 4-BOLT FLANGE
Outlet A: WELDED 2-BOLT FLANGE
Length: 19"



2013-12 6 CHEVROLET IMPALA FWD 3.6L

DIRECT FIT



641448

Inlet A: WELDED 4-BOLT FLANGE
 Outlet A: WELDED 2-BOLT FLANGE
 Length: 15.50"



2013-12 6 CHEVROLET IMPALA FWD 3.6L

641449

Inlet A: WELDED 9-BOLT FLANGE
 Outlet A: WELDED 3-BOLT FLANGE
 Length: 20"



2014-11 4 CHEVROLET CRUZE 1.8L
 2014-12 4 CHEVROLET SONIC 1.8L

641450

Inlet A: WELDED 4-BOLT FLANGE
 Outlet A: WELDED 2-BOLT FLANGE
 Length: 14"



2012 6 CHEVROLET EQUINOX 3.0L
 2015-13 6 CHEVROLET EQUINOX 3.6L
 2012 6 GMC TERRAIN 3.0L
 2015-13 6 GMC TERRAIN 3.6L

641900

Inlet A: LOOSE 3-BOLT FLANGE W/ 2.25" FEMALE FLARE
 Inlet B: LOOSE 3-BOLT FLANGE W/ 2.25" FEMALE FLARE
 Outlet A: 3" O.D. PIPE
 Length: 46.50"

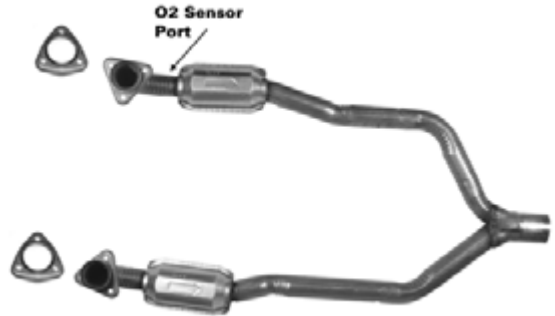

1991-86 8 CHEVROLET CORVETTE 5.7L

642000

Inlet A: WELDED 2-BOLT FLANGE
 Outlet A: 2.50" O.D. PIPE
 Length: 19.75"



2013-12 6 CHEVROLET IMPALA FWD 3.6L

642001

Inlet A: WELDED 4-BOLT FLANGE
 Outlet A: 2.38" O.D. PIPE
 Length: 67"



2008-06 4 VOLKSWAGEN PASSAT 2.0L

642003

Inlet A: WELDED 2-BOLT FLANGE
Outlet A: WELDED 3-BOLT FLANGE
Length: 30



2011-06 4 HONDA CIVIC 1.3L

642005

Inlet A: WELDED 2-BOLT FLANGE
Outlet A: WELDED 2-BOLT FLANGE W/ GASKET STUB
Length: 33.50"



2009-05 8 LEXUS GX470 4.7L
2009-05 8 TOYOTA 4 RUNNER 4.7L

642007

Inlet A: WELDED 4-BOLT FLANGE
Outlet A: 2.38" O.D. PIPE
Length: 68.38"

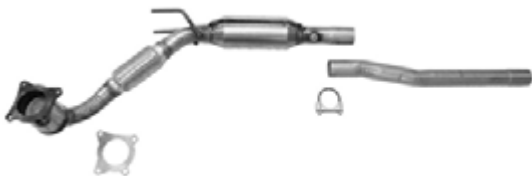

2008-06 4 AUDI A3 2.0L
2008-07 4 VOLKSWAGEN EOS 2.0L
2008-06 4 VOLKSWAGEN GTI 2.0L
2008-06 4 VOLKSWAGEN JETTA 2.0L

642009

Inlet A: WELDED 3-BOLT FLANGE
Outlet A: WELDED 2-BOLT FLANGE
Length: 42.50"



2001 5 VOLVO S70/V70 2.4L

642010

Inlet A: WELDED 2-BOLT FLANGE W/ GASKET STUB
Inlet B: WELDED 2-BOLT FLANGE
Outlet A: WELDED 2-BOLT FLANGE W/ GASKET STUB
Length: 32.25"



2009-05 8 LEXUS GX470 4.7L
2009-05 8 TOYOTA 4 RUNNER 4.7L

642011

Inlet A: WELDED 3-BOLT FLANGE
Outlet A: 2.13" O.D. PIPE
Length: 43.75"



2005-02 6 AUDI A4 3.0L

DIRECT FIT



642012

Inlet A: WELDED 3-BOLT FLANGE
 Outlet A: 2.13" O.D. PIPE
 Length: 45.50"



2005-02 6 AUDI A4 3.0L

642013

Inlet A: WELDED 5-BOLT FLANGE
 Outlet A: WELDED 2-BOLT FLANGE
 Length: 24.38"



2007-04 4 SUBARU IMPREZA 2.5L

642016

Inlet A: LOOSE 2-BOLT FLANGE W/ SPHERICAL FLARE
 Inlet B: LOOSE 2-BOLT FLANGE W/ SPHERICAL FLARE
 Outlet A: WELDED 3-BOLT FLANGE W/ GASKET STUB
 Length: 20.50"



2000-98 6 FORD RANGER 3.0L
 2000-98 6 MAZDA B-Series PICKUP 3.0L

642017

Inlet A: LOOSE 2-BOLT FLANGE W/ SPHERICAL FLARE
 Outlet A: 2" O.D. PIPE
 Length: 64.38"



2002-98 8 MERCEDES-BENZ E430 4.3L

642018

Inlet A: WELDED 4-BOLT FLANGE
 Outlet A: WELDED 3-BOLT FLANGE
 Length: 17.50"



2009-05 4 AUDI A4 2.0L

642019

Inlet A: WELDED 3-BOLT FLANGE
 Outlet A: WELDED 2-BOLT FLANGE
 Length: 45.25"



2005-04 4 SUBARU LEGACY 2.5L
 2005-04 4 SUBARU OUTBACK 2.5L

642020

Inlet A: LOOSE 2-BOLT FLANGE W/ SPHERICAL FLARE
 Outlet A: 2" I.D. PIPE
 Length: 69.75"



2002-98 8 MERCEDES-BENZ E430 4.3L

642021

Inlet A: WELDED 2-BOLT FLANGE
Outlet A: WELDED 2-BOLT FLANGE
Length: 13.75"



2011-09 6 CHEVROLET AVEO 1.6L
2011-09 4 CHEVROLET AVEO5 1.6L
2010-09 4 PONTIAC G3 1.6L

642022

Inlet A: WELDED 2-BOLT FLANGE
Outlet A: WELDED 2-BOLT FLANGE
Length: 18.50"



2006-03 4 MITSUBISHI OUTLANDER 2.4L

642023

Inlet A: WELDED 2-BOLT FLANGE W/ GASKET STUB
Inlet B: LOOSE 2-BOLT FLANGE W/ SPHERICAL FLARE
Outlet A: WELDED 2-BOLT FLANGE
Length: 21.75"



2000-99 6 MITSUBISHI MONTERO SPORT 3.0L

642024

Inlet A: WELDED 2-BOLT FLANGE W/ FEMALE FLARE
Outlet A: 2.12" O.D. PIPE
Length: 20.50"



2008-06 6 LEXUS RX400H 3.3L
2007-06 6 TOYOTA HIGHLANDER 3.3L

642026

Inlet A: WELDED 2-BOLT FLANGE
Outlet A: WELDED 3-BOLT FLANGE
Length: 31.75"



2004-02 4 ACURA RSX 2.0L

642027

Inlet A: LOOSE 2-BOLT FLANGE W/ FEMALE FLARE
Inlet B: LOOSE 2-BOLT FLANGE W/ FEMALE FLARE
Outlet A: 2.50" O.D. PIPE
Length: 35.75"



2004-02 8 JEEP GRAND CHEROKEE/GRAND WAGONEER 4.7L

DIRECT FIT



642028

Inlet A: WELDED 2-BOLT FLANGE
 Outlet A: WELDED 2-BOLT FLANGE
 Length: 13.50"



2004-98 4 NISSAN FRONTIER 2.4L
 1997-96 4 NISSAN PICKUP 2.4L

642029

Inlet A: WELDED 3-BOLT FLANGE
 Outlet A: WELDED 2-BOLT FLANGE
 Length: 35.25"



2000-96 4 TOYOTA 4 RUNNER 2.7L

642030

Inlet A: WELDED 2-BOLT FLANGE W/ SPHERICAL FLARE
 Outlet A: 1.70" I.D. PIPE
 Length: 16.13"



2003-01 4 TOYOTA PRIUS 1.5L

642031

Inlet A: WELDED 2-BOLT FLANGE W/ GASKET STUB
 Outlet A: WELDED 2-BOLT FLANGE
 Length: 29.13"



2010-07 8 INFiniti QX56 5.6L
 2015-07 8 NISSAN ARMADA 5.6L
 2015-07 8 NISSAN TITAN 5.6L

642033

Inlet A: WELDED 3-BOLT FLANGE W/ GASKET STUB
 Inlet B: WELDED 3-BOLT FLANGE W/ GASKET STUB
 Outlet A: WELDED 2-BOLT FLANGE
 Length: 43"



2012-09 6 NISSAN MURANO 3.5L

642035

Inlet A: WELDED 3-BOLT FLANGE
 Outlet A: WELDED 3-BOLT FLANGE
 Length: 10.75"



2014-13 6 ACURA RDX 3.5L
 2009 6 ACURA RL 3.7L
 2014-09 6 ACURA TL 3.5L
 2014-09 6 ACURA TL 3.7L
 2014-10 6 ACURA TSX 3.5L
 2013-10 6 ACURA ZDX 3.7L
 2011-10 6 HONDA ACCORD CROSSTOUR 3.5L
 2012-08 6 HONDA ACCORD 3.5L
 2014-11 6 HONDA ODYSSEY 3.5L
 2014-09 6 HONDA PILOT 3.5L

642035 (cont.)

2014-09 6 HONDA RIDGELINE 3.5L

642036

Inlet A: WELDED 2-BOLT FLANGE
Outlet A: 2" O.D. PIPE
Length: 15"



2014-12 4 HYUNDAI ACCENT 1.6L
2014-12 4 KIA RIO 1.6L

642037

Inlet A: WELDED 2-BOLT FLANGE W/ FEMALE FLARE
Outlet A: 2.56" O.D. PIPE
Length: 47"



2016-12 4 TOYOTA CAMRY, (Inc. 1998 & Older SOLARA) 2.5L

642038

Inlet A: WELDED 2-BOLT FLANGE
Outlet A: 2.13" O.D. PIPE
Length: 16"



2012 4 MAZDA 3 SPORT 2.5L
2012-10 4 MAZDA 3 2.0L

642039

Inlet A: WELDED 3-BOLT FLANGE
Outlet A: WELDED 3-BOLT FLANGE
Length: 18"



2008-04 4 ACURA TSX 2.4L

642040

Inlet A: WELDED 3-BOLT FLANGE
Outlet A: WELDED 2-BOLT FLANGE
Length: 42"



2009-07 8 TOYOTA TUNDRA 4.7L

642041

Inlet A: WELDED 2-BOLT FLANGE
Outlet A: 2.50" I.D. PIPE
Length: 39"



2012-10 6 CHEVROLET EQUINOX 3.0L
2012-10 6 GMC TERRAIN 3.0L

642042

Inlet A: WELDED 2-BOLT FLANGE
Outlet A: 2.25" I.D. PIPE
Length: 39"



2015-10 4 CHEVROLET EQUINOX 2.4L
2015-10 4 GMC TERRAIN 2.4L

DIRECT FIT



642043

Inlet A: WELDED 2-BOLT FLANGE
 Outlet A: 2.35" O.D. PIPE
 Length: 20"



2006-04 6 TOYOTA SIENNA 3.3L

642044

Inlet A: WELDED 2-BOLT FLANGE
 Outlet A: WELDED 2-BOLT FLANGE
 Length: 21.25"



2012-09 6 BUICK ENCLAVE 3.6L
 2015-09 6 CHEVROLET TRAVERSE 3.6L
 2012-09 6 GMC ACADIA 3.6L
 2010-09 6 SATURN OUTLOOK 3.6L

642045

Inlet A: WELDED 2-BOLT FLANGE
 Outlet A: 2.13" O.D. PIPE
 Length: 39"



2010-08 6 TOYOTA HIGHLANDER 3.3L

642046

Inlet A: WELDED 2-BOLT FLANGE
 Outlet A: 2.13" O.D. PIPE
 Length: 24"



2012-09 4 TOYOTA HIGHLANDER 2.7L

642047

Inlet A: WELDED 3-BOLT FLANGE
 Outlet A: WELDED 2-BOLT FLANGE
 Length: 24.25"



2004-00 4 TOYOTA TACOMA 2.7L

642048

Inlet A: WELDED 2-BOLT FLANGE
 Outlet A: WELDED 2-BOLT FLANGE
 Length: 43.25"



2012-09 4 TOYOTA HIGHLANDER 2.7L

642049

Inlet A: 2.13" OD PIPE
Outlet A: WELDED 3-BOLT FLANGE
Length: 20"



2005-04 4 SUZUKI FORENZA 2.0L
2005 4 SUZUKI RENO 2.0L

642050

Inlet A: WELDED 2-BOLT FLANGE
Outlet A: WELDED 2-BOLT FLANGE
Length: 28"



2013-10 4 FORD TRANSIT CONNECT 2.0L

642051

Inlet A: WELDED 2-BOLT FLANGE
Outlet A: 2" O.D. PIPE
Length: 44.50"



2013-10 4 FORD TRANSIT CONNECT 2.0L

642052

Inlet A: WELDED 2-BOLT FLANGE
Outlet A: WELDED 2-BOLT FLANGE
Length: 13"



2012-10 4 HYUNDAI SANTA FE 2.4L

642052 (cont.)

2013-11 4 KIA SORENTO 2.4L

642053

Inlet A: WELDED 2-BOLT FLANGE
Outlet A: WELDED 2-BOLT FLANGE
Length: 27"



2015-14 4 NISSAN ROGUE SELECT 2.5L
2013-08 4 NISSAN ROGUE 2.5L

642054

Inlet A: WELDED 2-BOLT FLANGE
Outlet A: WELDED 2-BOLT FLANGE
Length: 18"



2001-97 6 MITSUBISHI MONTERO SPORT 3.0L
2001-99 6 MITSUBISHI MONTERO SPORT 3.5L

642056

Inlet A: WELDED 2-BOLT FLANGE
Outlet A: 2.25" O.D. PIPE
Length: 19.25"



2009-08 6 FORD TAURUS X 3.5L
2009-08 6 FORD TAURUS 3.5L
2009-08 6 MERCURY SABLE 3.5L

DIRECT FIT



642057

Inlet A: WELDED 2-BOLT FLANGE
 Outlet A: WELDED 2-BOLT FLANGE
 Length: 16.50"



- 2009-07 6 HYUNDAI SANTA FE 3.3L
- 2008 6 HYUNDAI SONATA 3.3L
- 2012-07 6 HYUNDAI VERACRUZ 3.8L

642058

Inlet A: WELDED 4-BOLT FLANGE
 Outlet A: WELDED 2-BOLT FLANGE
 Length: 36.25"



- 2005-01 5 VOLVO S60 2.4L
- 2007-03 5 VOLVO S70/V70 2.4L

642059

Inlet A: LOOSE 2-BOLT FLANGE W/ FEMALE FLARE
 Outlet A: LOOSE 2-BOLT FLANGE W/ FLAT FLARE
 Length: 15.25"



- 2002-97 4 MITSUBISHI MIRAGE 1.8L

642060

Inlet A: WELDED 2-BOLT FLANGE
 Outlet A: 2.50" O.D. PIPE
 Length: 16"



- 2012-08 4 CHEVROLET MALIBU 2.4L
- 2010-08 4 PONTIAC G6 2.4L
- 2009-08 4 SATURN AURA 2.4L

642061

Inlet A: WELDED 3-BOLT FLANGE
 Outlet A: WELDED 2-BOLT FLANGE
 Length: 37.50"



- 2008 4 CHEVROLET COBALT 2.4L
- 2010-08 4 CHEVROLET COBALT 2.2L
- 2011-08 4 CHEVROLET HHR 2.2L
- 2011-08 4 CHEVROLET HHR 2.4L
- 2008 4 PONTIAC G5 2.4L
- 2009-08 4 PONTIAC G5 2.2L

642062

Inlet A: WELDED 2-BOLT FLANGE
 Outlet A: WELDED 2-BOLT FLANGE
 Length: 25"



- 2006-04 4 SUBARU IMPREZA 2.5L

642063

Inlet A: WELDED 2-BOLT FLANGE
Outlet A: 2.36" I.D. PIPE
Length: 22"



2012-06 6 TOYOTA RAV4 3.5L

642066

Inlet A: WELDED 2-BOLT FLANGE
Outlet A: WELDED 2-BOLT FLANGE
Length: 16"



2008-07 6 HYUNDAI ENTOURAGE 3.8L
2010-06 6 KIA SEDONA 3.8L

642064

Inlet A: WELDED 2-BOLT FLANGE
Outlet A: WELDED 2-BOLT FLANGE
Length: 13"



2008-05 4 HYUNDAI TUCSON 2.0L
2010-05 4 KIA SPORTAGE 2.0L

642067

Inlet A: WELDED 2-BOLT FLANGE
Outlet A: WELDED 2-BOLT FLANGE
Length: 17.50"



2010 4 HYUNDAI SONATA 2.4L
2012-10 4 KIA FORTE KOUP 2.4L
2012-10 4 KIA FORTE 2.4L
2010-09 4 KIA OPTIMA 2.4L
2010-09 4 KIA RONDO 2.4L

642065

Inlet A: WELDED 2-BOLT FLANGE
Outlet A: WELDED 2-BOLT FLANGE
Length: 18"



2008-05 6 HYUNDAI TUCSON 2.7L
2010-05 6 KIA SPORTAGE 2.7L

642068

Inlet A: WELDED 8-BOLT FLANGE
Outlet A: WELDED 2-BOLT FLANGE
Length: 30"



2008-03 8 INFiniti FX45 4.5L
2010-06 8 INFiniti M45 4.5L

DIRECT FIT



642069

Inlet A: WELDED 3-BOLT FLANGE
 Inlet B: WELDED 2-BOLT FLANGE
 Outlet A: WELDED 2-BOLT FLANGE
 Length: 28.25"



2006-05 6 PONTIAC G6 3.5L

642070

Inlet A: WELDED 8-BOLT FLANGE
 Outlet A: WELDED 2-BOLT FLANGE
 Length: 29.50"



2008-03 8 INFiniti FX45 4.5L
 2010-06 8 INFiniti M45 4.5L

642071

Inlet A: WELDED 2-BOLT FLANGE
 Outlet A: WELDED 3-BOLT FLANGE
 Length: 24"



2005-03 4 HONDA CIVIC 1.3L

642072

Inlet A: WELDED 2-BOLT FLANGE
 Outlet A: WELDED 2-BOLT FLANGE
 Length: 46.25"



2005-04 4 HYUNDAI ELANTRA 2.0L

642073

Inlet A: WELDED 2-BOLT FLANGE
 Outlet A: WELDED 2-BOLT FLANGE
 Length: 10.50"



2011-10 4 HYUNDAI ACCENT 1.6L

642074

Inlet A: WELDED 16-BOLT FLANGE
 Outlet A: WELDED 2-BOLT FLANGE
 Length: 28.25"



2006-04 V8 INFiniti QX56 5.6L
 2006-05 8 NISSAN ARMADA 5.6L
 2004 8 NISSAN PATHFINDER 5.6L
 2006-04 8 NISSAN TITAN 5.6L

642075

Inlet A: WELDED 16-BOLT FLANGE
 Outlet A: WELDED 2-BOLT FLANGE
 Length: 29.25"



2006-04 V8 INFiniti QX56 5.6L
 2006-05 8 NISSAN ARMADA 5.6L
 2004 8 NISSAN PATHFINDER 5.6L
 2006-04 8 NISSAN TITAN 5.6L

642076

Inlet A: WELDED 2-BOLT FLANGE
Outlet A: 2.38" O.D. PIPE
Length: 37.50"



2015-09 6 TOYOTA VENZA 3.5L

642077

Inlet A: LOOSE 2-BOLT FLANGE W/ FEMALE FLARE
Inlet B: LOOSE 2-BOLT FLANGE W/ FEMALE FLARE
Outlet A: WELDED 2-BOLT FLANGE
Length: 36"



2008 8 JEEP COMMANDER 5.7L

642078

Inlet A: WELDED 2-BOLT FLANGE
Outlet A: 2.25" O.D. PIPE
Length: 21.25"



2010-06 6 MITSUBISHI ECLIPSE 3.8L
2009-06 6 MITSUBISHI GALANT 3.8L

642080

Inlet A: WELDED 2-BOLT FLANGE
Outlet A: 2.36" O.D. PIPE
Length: 21"



2010-08 6 PONTIAC G6 3.5L

642081

Inlet A: WELDED 2-BOLT FLANGE
Outlet A: 2.13" O.D. PIPE
Length: 17.50"



2009-07 4 MAZDA 3 2.0L
2009-07 4 MAZDA 3 2.3L

642082

Inlet A: WELDED 2-BOLT FLANGE
Outlet A: 2.35" O.D. PIPE
Length: 16"



2006-04 6 TOYOTA SIENNA 3.3L

DIRECT FIT



642083

Inlet A: WELDED 3-BOLT FLANGE
 Outlet A: WELDED 2-BOLT FLANGE
 Length: 47"



2008-04 R MAZDA RX-8 1.3L

642084

Inlet A: LOOSE 3-BOLT FLANGE W/ FEMALE FLARE
 Inlet B: WELDED 3-BOLT FLANGE
 Outlet A: WELDED 2-BOLT FLANGE
 Length: 45.50"



2004 8 BUICK RAINIER 5.3L

642088

Inlet A: LOOSE 2-BOLT FLANGE
 Inlet B: LOOSE 2-BOLT FLANGE
 Outlet A: 2.50" O.D. PIPE
 Length: 41"



2004 6 DODGE DURANGO 3.7L
 2004 8 DODGE DURANGO 4.7L

642089

Inlet A: WELDED 3-BOLT FLANGE
 Outlet A: WELDED 2-BOLT FLANGE
 Length: 36.50"



2007-05 4 CHEVROLET COBALT 2.0L
 2007-05 4 SATURN ION 2.0L

642090

Inlet A: WELDED 3-BOLT FLANGE
 Outlet A: WELDED 2-BOLT FLANGE
 Length: 44"



2009-05 5 VOLVO S60 2.4L
 2009-05 5 VOLVO S60 2.5L
 2007-05 5 VOLVO S70/V70 2.5L
 2006-04 5 VOLVO S80 2.5L

642091

Inlet A: WELDED 2-BOLT FLANGE
 Outlet A: WELDED 2-BOLT FLANGE
 Length: 45.75"



2007-05 4 MITSUBISHI LANCER 2.0L

642093

Inlet A: WELDED 3-BOLT FLANGE
Inlet B: WELDED 2-BOLT FLANGE
Outlet A: WELDED 2-BOLT FLANGE
Length: 22"



2008	6	CHEVROLET MALIBU 3.6L
2008-07	6	PONTIAC G6 3.6L
2008-07	6	SATURN AURA 3.6L

642094

Inlet A: WELDED 5-BOLT FLANGE
Outlet A: WELDED 2-BOLT FLANGE
Length: 22"



2003-01	4	TOYOTA HIGHLANDER 2.4L
---------	---	------------------------

642095

Inlet A: WELDED 2-BOLT FLANGE
Outlet A: WELDED 2-BOLT FLANGE W/ GASKET STUB
Length: 18.50"



2011-08	6	CADILLAC CTS 3.6L
2009	6	CADILLAC SRX 3.6L
2011-08	6	CADILLAC STS 3.6L

642096

Inlet A: WELDED 2-BOLT FLANGE
Outlet A: WELDED 2-BOLT FLANGE
Length: 13"



2005	8	INFINITI FX45 4.5L
------	---	--------------------

642097

Inlet A: WELDED 2-BOLT FLANGE
Outlet A: WELDED 2-BOLT FLANGE
Length: 13"



2005	8	INFINITI FX45 4.5L
------	---	--------------------

DIRECT FIT



642098

Inlet A: WELDED 7-BOLT FLANGE
 Outlet A: WELDED 2-BOLT FLANGE
 Length: 15.25"



2010-08 6 DODGE AVENGER 2.7L

642103

Inlet A: LOOSE 2-BOLT FLANGE W/ 2.50" FEMALE FLARE
 Inlet B: LOOSE 2-BOLT FLANGE W/ 2.50" FEMALE FLARE
 Outlet A: WELDED 3-BOLT FLANGE
 Length: 30.50"



2005 6 FORD RANGER 4.0L

642100

Inlet A: WELDED 2-BOLT FLANGE
 Inlet B: WELDED 2-BOLT FLANGE
 Outlet A: 2.47" I.D. PIPE
 Length: 47.25"



2003-01 8 LEXUS LS430 4.3L

642105

Inlet A: WELDED 2-BOLT FLANGE
 Outlet A: WELDED 2-BOLT FLANGE W/ GASKET STUB
 Length: 21"



2011-08 6 CADILLAC CTS 3.6L
 2009 6 CADILLAC SRX 3.6L
 2011-08 6 CADILLAC STS 3.6L

642101

Inlet A: WELDED 2-BOLT FLANGE
 Outlet A: WELDED 2-BOLT FLANGE W/ GASKET STUB
 Length: 36"



2009-08 8 BUICK LACROSSE 5.3L
 2009-06 8 CHEVROLET IMPALA FWD 5.3L
 2007-06 8 CHEVROLET MONTE CARLO 5.3L
 2008-05 8 PONTIAC GRAND PRIX 5.3L

642106

Inlet A: WELDED 8-BOLT FLANGE
 Outlet A: WELDED 2-BOLT FLANGE
 Length: 32"



2007-06 6 BMW 525 3.0L
 2007-06 6 BMW 530 3.0L

642109

Inlet A: WELDED 3-BOLT FLANGE
Outlet A: WELDED 2-BOLT FLANGE
Length: 42.50"



2011-07 8 TOYOTA TUNDRA 5.7L

642110

Inlet A: WELDED 3-BOLT FLANGE
Outlet A: WELDED 2-BOLT FLANGE
Length: 56"



2009-07 8 TOYOTA TUNDRA 5.7L

642111

Inlet A: WELDED 3-BOLT FLANGE
Outlet A: WELDED 2-BOLT FLANGE
Length: 27.50"



2004 6 CHEVROLET MALIBU 3.5L

642112

Inlet A: WELDED 3-BOLT FLANGE
Outlet A: WELDED 2-BOLT FLANGE
Length: 15.50"



2004 6 CHEVROLET MALIBU 3.5L

642113

Inlet A: WELDED 2-BOLT FLANGE
Outlet A: WELDED 2-BOLT FLANGE
Length: 47.50"



2011 4 HYUNDAI SONATA 2.4L

642114

Inlet A: WELDED 7-BOLT FLANGE
Outlet A: WELDED 2-BOLT FLANGE
Length: 34"



2009-07 4 MAZDA 3 2.0L

642115

Inlet A: WELDED 2-BOLT FLANGE
Outlet A: WELDED 2-BOLT FLANGE
Length: 26"



2006-04 V8 INFINITI QX56 5.6L

DIRECT FIT



642115 (cont.)

2010-07 8 INFINITI QX56 5.6L
 2015-05 8 NISSAN ARMADA 5.6L
 2015-04 8 NISSAN TITAN 5.6L

642116

Inlet A: WELDED 2-BOLT FLANGE
 Outlet A: WELDED 2-BOLT FLANGE
 Length: 28.50"



2006-04 V8 INFINITI QX56 5.6L
 2006-05 8 NISSAN ARMADA 5.6L
 2006-04 8 NISSAN TITAN 5.6L

642117

Inlet A: WELDED 2-BOLT FLANGE
 Outlet A: WELDED 3-BOLT FLANGE
 Length: 25"



2008-07 4 HONDA FIT 1.5L

642118

Inlet A: WELDED 3- BOLT FLANGE
 Outlet A: WELDED 3-BOLT FLANGE
 Length: 10.50"



2012-09 4 ACURA TSX 2.4L
 2012-08 4 HONDA ACCORD 2.4L

642119

Inlet A: WELDED 8-BOLT FLANGE
 Outlet A: WELDED 2-BOLT FLANGE
 Length: 23"



2007-06 6 BMW 525 3.0L
 2007-06 6 BMW 530 3.0L

642120

Inlet A: WELDED 7-BOLT FLANGE
 Outlet A: WELDED 2-BOLT FLANGE
 Length: 17.50"



2010-08 6 DODGE AVENGER 2.7L

642121

Inlet A: WELDED 9-BOLT FLANGE
 Outlet A: WELDED 2-BOLT FLANGE
 Length: 18"



2010-06 4 HYUNDAI ACCENT 1.6L
 2010-06 4 KIA RIO 1.6L
 2010-06 4 KIA RIO5 1.6L

642122

Inlet A: WELDED 3-BOLT FLANGE
Inlet B: WELDED 2-BOLT FLANGE
Outlet A: WELDED 2-BOLT FLANGE
Length: 57"



2004-01 6 SUBARU OUTBACK 3.0L

642123

Inlet A: WELDED 3-BOLT FLANGE
Outlet A: WELDED 2-BOLT FLANGE
Length: 46.75"



2004-01 6 SUBARU OUTBACK 3.0L

642124

Inlet A: WELDED 3-BOLT FLANGE
Outlet A: WELDED 2-BOLT FLANGE
Length: 13"



2010-05 6 NISSAN FRONTIER 4.0L
2010-05 6 NISSAN PATHFINDER 4.0L
2010-05 6 NISSAN XTERRA 4.0L

642125

Inlet A: WELDED 3-BOLT FLANGE
Outlet A: WELDED 2-BOLT FLANGE
Length: 12.50"



2011-08 6 BUICK ENCLAVE 3.6L
2011-09 6 CHEVROLET TRAVERSE 3.6L

642125 (cont.)

2011-07 6 GMC ACADIA 3.6L
2010-07 6 SATURN OUTLOOK 3.6L

642126

Inlet A: WELDED 3-BOLT FLANGE
Outlet A: WELDED 2-BOLT FLANGE
Length: 15.50"



2011-08 6 BUICK ENCLAVE 3.6L
2011-09 6 CHEVROLET TRAVERSE 3.6L
2011-07 6 GMC ACADIA 3.6L
2010-07 6 SATURN OUTLOOK 3.6L

642127

Inlet A: WELDED 2-BOLT FLANGE
Outlet A: WELDED 3-BOLT FLANGE
Length: 32"



2009-07 4 HONDA CRV 2.4L

642128

Inlet A: WELDED 2-BOLT FLANGE
Outlet A: WELDED 2-BOLT FLANGE W/ GASKET STUB
Length: 28"



2008-06 6 MAZDA 6 3.0L

642130

Inlet A: WELDED 2-BOLT FLANGE
Outlet A: WELDED 2-BOLT FLANGE
Length: 15.50"



2009-07 6 HYUNDAI SANTA FE 2.7L
2007 4 KIA RONDO 2.7L

DIRECT FIT



642131

Inlet A: WELDED 2-BOLT FLANGE
 Outlet A: WELDED 2-BOLT FLANGE
 Length: 16"



- 2007-04 6 CADILLAC SRX 3.6L
- 2007-05 6 CADILLAC STS 3.6L

642132

Inlet A: WELDED 2-BOLT FLANGE
 Outlet A: WELDED 2-BOLT FLANGE
 Length: 16"



- 2007-04 6 CADILLAC SRX 3.6L
- 2007-05 6 CADILLAC STS 3.6L

642133

Inlet A: WELDED 8-BOLT FLANGE
 Outlet A: WELDED 2-BOLT FLANGE
 Length: 20.75"



- 2000 6 BMW 323CI 2.5L
- 2000-99 6 BMW 323I 2.5L
- 2000-99 6 BMW 328 2.8L
- 2000-99 6 BMW Z3 2.5L
- 2000-99 6 BMW Z3 2.8L

642134

Inlet A: WELDED 8-BOLT FLANGE
 Outlet A: WELDED 2-BOLT FLANGE
 Length: 29.75"



- 2000 6 BMW 323CI 2.5L
- 2000-99 6 BMW 323I 2.5L
- 2000-99 6 BMW 328 2.8L
- 2000-99 6 BMW 528 2.8L
- 2000-99 6 BMW Z3 2.5L
- 2000-99 6 BMW Z3 2.8L

642135

Inlet A: WELDED 8-BOLT FLANGE
 Outlet A: WELDED 2-BOLT FLANGE
 Length: 22.25"



- 2000-99 6 BMW 528 2.8L

642138

Inlet A: WELDED 3-BOLT FLANGE
 Outlet A: WELDED 2-BOLT FLANGE
 Length: 12.50"



- 2010-05 6 NISSAN FRONTIER 4.0L
- 2010-05 6 NISSAN PATHFINDER 4.0L
- 2010-05 6 NISSAN XTERRA 4.0L

642139

Inlet A: LOOSE 2-BOLT FLANGE W/ FEMALE FLARE
 Outlet A: WELDED 2-BOLT FLANGE
 Length: 35"



2004-01 6 CHEVROLET TRACKER 2.5L

642140

Inlet A: LOOSE 2-BOLT FLANGE
 Outlet A: WELDED 2-BOLT FLANGE
 Length: 46"



2006-05 8 PONTIAC GTO 6.0L

642141

Inlet A: LOOSE 2-BOLT FLANGE
 Outlet A: WELDED 2-BOLT FLANGE
 Length: 46"



2006-05 8 PONTIAC GTO 6.0L

642142

Inlet A: WELDED 2-BOLT FLANGE
 Outlet A: WELDED 2-BOLT FLANGE W/ 1.85" O.D. GASKET OUTLET
 Length: 19"



2007-04 6 CADILLAC CTS 3.6L
 2007-05 6 CADILLAC CTS 2.8L

642143

Inlet A: WELDED 2-BOLT FLANGE
 Outlet A: WELDED 2-BOLT FLANGE W/ 1.85" O.D. GASKET OUTLET
 Length: 19.50"



2007-04 6 CADILLAC CTS 3.6L
 2007-05 6 CADILLAC CTS 2.8L

642144

Inlet A: WELDED 3-BOLT FLANGE
 Outlet A: WELDED 2-BOLT FLANGE
 Length: 28.25"



2008 6 CHEVROLET MALIBU 3.6L
 2008-07 6 PONTIAC G6 3.6L
 2008-07 6 SATURN AURA 3.6L

642145

Inlet A: 1.75" PIPE
 Outlet A: WELDED 2-BOLT FLANGE
 Length: 40.50"



2007-06 6 BMW 525 3.0L
 2007-06 6 BMW 530 3.0L

642146

Inlet A: 1.75" PIPE
 Outlet A: WELDED 2-BOLT FLANGE
 Length: 43"



2007-06 6 BMW 525 3.0L

DIRECT FIT



642146 (cont.)

2007-06 6 BMW 530 3.0L

642147

Inlet A: WELDED 2-BOLT FLANGE
 Outlet A: WELDED 2-BOLT FLANGE
 Length: 41.50"



2003-01 4 HYUNDAI ELANTRA 2.0L
 2006-03 4 HYUNDAI TIBURON 2.0L

642148

Inlet A: WELDED 7-BOLT FLANGE
 Outlet A: WELDED 2-BOLT FLANGE
 Length: 22"



2009-06 4 FORD FUSION 2.3L

642149

Inlet A: WELDED 2-BOLT FLANGE
 Outlet A: WELDED 2-BOLT FLANGE
 Length: 27"



2010-05 6 NISSAN FRONTIER 4.0L
 2010-05 6 NISSAN PATHFINDER 4.0L
 2010-05 6 NISSAN XTERRA 4.0L

642150

Inlet A: WELDED 2-BOLT FLANGE
 Outlet A: WELDED 2-BOLT FLANGE
 Length: 27"



2010-05 6 NISSAN FRONTIER 4.0L
 2010-05 6 NISSAN PATHFINDER 4.0L
 2010-05 6 NISSAN XTERRA 4.0L

642151

Inlet A: LOOSE 2-BOLT FLANGE W/ SPHERICAL FLARE
 Inlet B: LOOSE 2-BOLT FLANGE W/ SPHERICAL FLARE
 Outlet A: WELDED 2-BOLT FLANGE
 Length: 46"



2006 6 JEEP COMMANDER 4.7L
 2006-05 8 JEEP GRAND CHEROKEE/GRAND WAGONEER 4.7L

642152

Inlet A: WELDED 3-BOLT FLANGE
 Outlet A: WELDED 2-BOLT FLANGE
 Length: 37"



2008 4 CHEVROLET HHR 2.4L

642153

Inlet A: WELDED 2-BOLT FLANGE W/ GASKET STUB
 Inlet B: WELDED 2-BOLT FLANGE W/ GASKET STUB
 Outlet A: WELDED 2-BOLT FLANGE
 Length: 46"



2004-03 8 INFiniti M45 4.5L
 2006-02 8 INFiniti Q45 4.5L

642154

Inlet A: WELDED 2-BOLT FLANGE
 Outlet A: 2" O.D. PIPE
 Length: 27.25"



2009-06 4 MITSUBISHI ECLIPSE 2.4L

642155

Inlet A: WELDED 2-BOLT FLANGE
Outlet A: WELDED 2-BOLT FLANGE
Length: 33"



2014-09 4 NISSAN CUBE 1.8L

642156

Inlet A: WELDED 3-BOLT FLANGE
Inlet B: WELDED 3-BOLT FLANGE
Outlet A: WELDED 2-BOLT FLANGE
Length: 43"



2008-07 6 NISSAN ALTIMA 3.5L

642157

Inlet A: WELDED 2-BOLT FLANGE
Outlet A: 2.25" O.D. PIPE
Length: 17.75"



2009-07 4 MAZDA 3 2.0L
2009-07 4 MAZDA 3 2.3L

642158

Inlet A: WELDED 8-BOLT FLANGE
Outlet A: WELDED 2-BOLT FLANGE
Length: 27"



2006-01 6 BMW 330 3.0L

642159

Inlet A: WELDED 8-BOLT FLANGE
Outlet A: WELDED 2-BOLT FLANGE
Length: 17"



2006-01 6 BMW 330 3.0L

642160

Inlet A: WELDED 5-BOLT FLANGE
Outlet A: WELDED 2-BOLT FLANGE W/ GASKET STUB
Length: 20.13"



2009-07 4 MAZDA CX-7 2.3L

642161

Inlet A: LOOSE 2-BOLT FLANGE W/ SPHERICAL FLARE
Outlet A: WELDED 2-BOLT FLANGE
Length: 37.50"



2011-03 8 FORD CROWN VICTORIA (Inc. Police, Taxi, Station Wagon) 4.6L
2011-03 8 LINCOLN TOWN CAR 4.6L
2011-03 8 MERCURY GRAND MARQUIS FULL SIZE 4.6L
2004-03 8 MERCURY MARAUDER 4.6L

DIRECT FIT



642162

Inlet A: WELDED 3-BOLT FLANGE
 Outlet A: WELDED 3-BOLT FLANGE
 Length: 6.75"



- 2008-04 4 SUZUKI FORENZA 2.0L
- 2008-05 4 SUZUKI RENO 2.0L

642170

Inlet A: WELDED 2-BOLT FLANGE
 Outlet A: WELDED 2-BOLT FLANGE
 Length: 16.50"

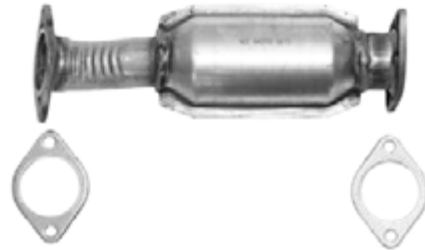

- 2007-06 6 HYUNDAI SONATA 3.3L

642165

Inlet A: WELDED 2-BOLT FLANGE
 Outlet A: 2.13" O.D. PIPE
 Length: 36"



- 2008-03 4 PONTIAC VIBE 1.8L
- 2008-03 4 TOYOTA COROLLA 1.8L
- 2008-03 4 TOYOTA MATRIX 1.8L

642171

Inlet A: WELDED 2-BOLT FLANGE
 Outlet A: WELDED 2-BOLT FLANGE
 Length: 14.75"



- 2005-04 4 HYUNDAI ELANTRA 2.0L
- 2007-04 4 KIA SPECTRA 2.0L
- 2007-06 4 KIA SPECTRA5 2.0L

642168

Inlet A: WELDED 2-BOLT FLANGE
 Outlet A: 1.88" O.D. PIPE W/ SPHERICAL RING
 Length: 84"

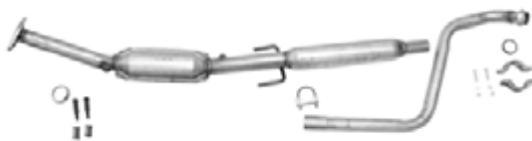

- 2006-04 4 SCION XB 1.5L

642173

Inlet A: WELDED 2-BOLT FLANGE
 Outlet A: 2.13" O.D. PIPE
 Length: 24.75"



- 2012-04 4 MITSUBISHI GALANT 2.4L

642176

Inlet A: WELDED 2-BOLT FLANGE
Outlet A: WELDED 2-BOLT FLANGE
Length: 13"



2008-07 4 HYUNDAI ELANTRA 2.0L
2011-10 4 KIA SOUL 2.0L

642178

Inlet A: WELDED 2-BOLT FLANGE
Outlet A: WELDED 2-BOLT FLANGE
Length: 13.50"



2009-06 4 HYUNDAI ACCENT 1.6L
2011-06 4 KIA RIO 1.6L
2009-06 4 KIA RIO5 1.6L

642179

Inlet A: LOOSE 2-BOLT FLANGE W/ SPHERICAL FLARE
Outlet A: WELDED 2-BOLT FLANGE
Length: 35.75"



2011-03 8 FORD CROWN VICTORIA (Inc. Police, Taxi, Station Wagon) 4.6L
2011-03 8 LINCOLN TOWN CAR 4.6L
2011-03 8 MERCURY GRAND MARQUIS FULL SIZE 4.6L
2004-03 8 MERCURY MARAUDER 4.6L

642180

Inlet A: WELDED 2-BOLT FLANGE
Inlet B: WELDED 3-BOLT FLANGE
Outlet A: WELDED 3-BOLT FLANGE
Length: 43"



2003-02 6 SATURN VUE 3.0L

642181

Inlet A: WELDED 2-BOLT FLANGE
Outlet A: WELDED 2-BOLT FLANGE
Length: 31.38"



2004-00 6 TOYOTA TACOMA 3.4L

642182

Inlet A: LOOSE 2-BOLT FLANGE
Inlet B: LOOSE 2-BOLT FLANGE
Outlet A: 2.50" FLAT FLARE
Length: 31.50"



1996-94 12 JAGUAR XJ12 6.0L

642184

Inlet A: WELDED 2-BOLT FLANGE
Outlet A: WELDED 2-BOLT FLANGE
Length: 34.75"



2011-03 4 HONDA ELEMENT 2.4L

DIRECT FIT



642185

Inlet A: WELDED 3-BOLT FLANGE
 Outlet A: WELDED 3-BOLT FLANGE
 Length: 10"



- 2006-03 6 ACURA MDX 3.5L
- 2008-04 6 ACURA TL 3.2L
- 2007-03 6 HONDA ACCORD 3.0L
- 2010-05 6 HONDA ODYSSEY 3.5L
- 2008-05 6 HONDA PILOT 3.5L
- 2008-06 6 HONDA RIDGELINE 3.5L

642186

Inlet A: WELDED 2-BOLT FLANGE
 Inlet B: WELDED 2-BOLT FLANGE
 Outlet A: WELDED 2-BOLT FLANGE W/ GASKET STUB
 Length: 29"



- 2004-03 8 LEXUS GX470 4.7L
- 2004-03 8 TOYOTA 4 RUNNER 4.7L

642187

Inlet A: WELDED 2-BOLT FLANGE
 Outlet A: WELDED 2-BOLT FLANGE
 Length: 22"



- 2001-00 6 MAZDA MPV VAN 2.5L

642188

Inlet A: WELDED 3-BOLT FLANGE
 Outlet A: WELDED 3-BOLT FLANGE
 Length: 13.50"



- 1998-95 5 ACURA TL 2.5L

642188 (cont.)

- 2001-97 4 HONDA PRELUDE 2.2L

642189

Inlet A: WELDED 3-BOLT FLANGE
 Outlet A: WELDED 3-BOLT FLANGE
 Length: 19"



- 2007-03 4 HONDA ACCORD 2.4L

642190

Inlet A: WELDED 2-BOLT FLANGE
 Outlet A: WELDED 2-BOLT FLANGE
 Length: 17"



- 2009 4 KIA RONDO 2.4L

642191

Inlet A: WELDED 2-BOLT FLANGE
 Outlet A: WELDED 2-BOLT FLANGE
 Length: 28"



- 2012-03 6 TOYOTA 4 RUNNER 4.0L
- 2012-07 6 TOYOTA FJ CRUISER 4.0L

642192

Inlet A: WELDED 2-BOLT FLANGE
Inlet B: WELDED 2-BOLT FLANGE
Outlet A: WELDED 2-BOLT FLANGE
Length: 31"



2012-03 6 TOYOTA 4 RUNNER 4.0L
2012-07 6 TOYOTA FJ CRUISER 4.0L

642195

Inlet A: WELDED 2-BOLT FLANGE
Outlet A: WELDED 2-BOLT FLANGE
Length: 10.25"



2009-07 4 KIA SPECTRA 2.0L

642193

Inlet A: LOOSE 2-BOLT FLANGE
Outlet A: WELDED 3-BOLT FLANGE
Length: 27.50"



2004-02 4 ACURA RSX 2.0L

642196

Inlet A: WELDED 9-BOLT FLANGE
Outlet A: WELDED 3-BOLT FLANGE
Length: 24"



2006-04 5 CHEVROLET COLORADO 3.5L
2006-04 5 GMC CANYON 3.5L
2006 5 HUMMER H3 3.5L
2006 5 ISUZU I-350 3.5L

642194

Inlet A: WELDED 3-BOLT FLANGE
Outlet A: WELDED 2-BOLT FLANGE
Length: 18"



2004-00 6 TOYOTA TACOMA 3.4L
2004-00 6 TOYOTA TUNDRA 3.4L

642197

Inlet A: WELDED 3-BOLT FLANGE
Inlet B: WELDED 3-BOLT FLANGE
Outlet A: 2" I.D. PIPE
Length: 42.50"



2004-02 6 VOLKSWAGEN JETTA 2.8L

DIRECT FIT



642198

Inlet A: WELDED 10-BOLT FLANGE
 Outlet A: WELDED 3-BOLT FLANGE
 Length: 17.50"



- 2008-04 4 CHEVROLET MALIBU 2.2L
- 2010-08 4 CHEVROLET MALIBU 2.4L
- 2010-06 4 PONTIAC G6 2.4L
- 2009-07 4 SATURN AURA 2.4L

642199

Inlet A: WELDED 3-BOLT FLANGE
 Outlet A: WELDED 2-BOLT FLANGE
 Length: 20.25"



- 2004-03 6 CADILLAC CTS 3.2L

642200

Inlet A: WELDED 3-BOLT FLANGE
 Outlet A: WELDED 2-BOLT FLANGE
 Length: 22.50"



- 2004-03 6 CADILLAC CTS 3.2L

642201

Inlet A: WELDED 10-BOLT FLANGE
 Outlet A: WELDED 4-BOLT FLANGE
 Length: 16.50"



- 2005-01 5 VOLVO S60 2.4L
- 2002-01 5 VOLVO S70/V70 2.4L

642202

Inlet A: WELDED 2-BOLT FLANGE
 Outlet A: WELDED 2-BOLT FLANGE
 Length: 13.63"



- 1998 4 NISSAN 200SX 2.0L
- 2000-98 4 NISSAN SENTRA 2.0L

642203

Inlet A: 2-BOLT FLANGE W/ 45 DEGREE FLARE
 Outlet A: 2.125" O.D. PIPE
 Length: 65"



- 2001-99 8 MERCEDES-BENZ ML430 4.3L

642204

Inlet A: 2-BOLT FLANGE W/ 45 DEGREE FLARE
Outlet A: 2.125" O.D. PIPE
Length: 63.25"



2001-99 8 MERCEDES-BENZ ML430 4.3L

642205

Inlet A: WELDED 2-BOLT FLANGE
Outlet A: WELDED 4-BOLT FLANGE
Length: 44.75"



1999-98 6 CHEVROLET LUMINA 3.8L
1999-98 6 CHEVROLET MONTE CARLO 3.8L

642206

Inlet A: WELDED 3-BOLT FLANGE W/ GASKET STUB
Outlet A: WELDED 2-BOLT FLANGE
Length: 41"



2004-99 6 NISSAN FRONTIER 3.3L
2004-00 6 NISSAN XTERRA 3.3L

642207

Inlet A: WELDED 2-BOLT FLANGE W/ GASKET STUB
Outlet A: WELDED 2-BOLT FLANGE
Length: 12.50"



1994-93 6 TOYOTA LAND CRUISER 4.5L

642208

Inlet A: WELDED 2-BOLT FLANGE
Outlet A: WELDED 2-BOLT FLANGE
Length: 16.50"



2009-06 6 HYUNDAI AZERA 3.8L
2009-07 6 KIA AMANTI 3.8L

642209

Inlet A: WELDED 2-BOLT FLANGE
Outlet A: WELDED 2-BOLT FLANGE
Length: 51.25"



2003-02 4 NISSAN SENTRA 2.5L

642210

Inlet A: WELDED 3-BOLT FLANGE
Outlet A: 2.165" O.D. PIPE
Length: 44.75"



2004-02 6 AUDI A4 3.0L

642211

Inlet A: WELDED 3-BOLT FLANGE
Outlet A: 2.165" O.D. PIPE
Length: 45.50"



2004-02 6 AUDI A4 3.0L

DIRECT FIT



642212

Inlet A: WELDED 2-BOLT FLANGE
 Outlet A: WELDED 2-BOLT FLANGE
 Length: 13.50"



2002-97 4 MITSUBISHI MIRAGE 1.5L

642213

Inlet A: WELDED 4-BOLT FLANGE
 Outlet A: WELDED 2-BOLT FLANGE
 Length: 32.50"



2007-04 5 VOLVO S40/V40 2.4L
 2007-05 5 VOLVO V50 2.4L

642214

Inlet A: WELDED 4-BOLT FLANGE
 Outlet A: WELDED 2-BOLT FLANGE W/ GASKET STUB
 Length: 12.50"



2010-07 6 FORD EDGE 3.5L
 2010-09 6 FORD FLEX 3.5L
 2010 6 FORD FUSION 3.5L
 2009-08 6 FORD TAURUS X 3.5L
 2012-08 6 FORD TAURUS 3.5L
 2010-09 6 LINCOLN MKS 3.7L
 2010-07 6 LINCOLN MKX 3.5L
 2010-07 6 LINCOLN MKZ 3.5L
 2009-08 6 MERCURY SABLE 3.5L

642215

Inlet A: WELDED 4-BOLT FLANGE
 Outlet A: WELDED 2-BOLT FLANGE
 Length: 10.75"



2010-07 6 FORD EDGE 3.5L
 2010-09 6 FORD FLEX 3.5L
 2010 6 FORD FUSION 3.5L
 2009-08 6 FORD TAURUS X 3.5L
 2010-08 6 FORD TAURUS 3.5L
 2010-09 6 LINCOLN MKS 3.7L
 2010-07 6 LINCOLN MKX 3.5L
 2010-07 6 LINCOLN MKZ 3.5L
 2009-08 6 MERCURY SABLE 3.5L

642216

Inlet A: WELDED 2-BOLT FLANGE
 Outlet A: 2.25" O.D. PIPE
 Length: 19.50"



2008-06 6 FORD FUSION 3.0L
 2006 6 LINCOLN ZEPHYR 3.0L
 2008-06 6 MERCURY MILAN 3.0L

642217

Inlet A: WELDED 3-BOLT FLANGE
 Outlet A: 2.570" O.D. PIPE
 Length: 27.88"



2006-04 6 VOLKSWAGEN TOUAREG 3.2L

642218

Inlet A: WELDED 4-BOLT FLANGE
Outlet A: 2.355" O.D. PIPE
Length: 40"



- 2007-05 5 VOLKSWAGEN JETTA 2.5L
- 2008-06 5 VOLKSWAGEN RABBIT 2.5L

642219

Inlet A: WELDED 2-BOLT FLANGE
Outlet A: WELDED 4-BOLT FLANGE
Length: 43.75"



- 1999-98 6 CHEVROLET LUMINA 3.8L
- 1999-98 6 CHEVROLET MONTE CARLO 3.8L

642220

Inlet A: WELDED 3-BOLT FLANGE
Outlet A: WELDED 3-BOLT FLANGE
Length: 17.75"



- 2009-08 6 CHEVROLET EQUINOX 3.6L
- 2009-08 6 PONTIAC TORRENT 3.6L
- 2008-07 6 SUZUKI XL-7 3.6L

642221

Inlet A: WELDED 3-BOLT FLANGE
Outlet A: WELDED 3-BOLT FLANGE
Length: 39"



- 2009-08 6 CHEVROLET EQUINOX 3.6L
- 2009-08 6 PONTIAC TORRENT 3.6L
- 2008-07 6 SUZUKI XL-7 3.6L

642222

Inlet A: WELDED 3-BOLT FLANGE
Inlet B: WELDED 3-BOLT FLANGE
Outlet A: WELDED 3-BOLT FLANGE
Length: 26.75"



- 2010-06 4 SUBARU FORESTER 2.5L
- 2011-06 4 SUBARU IMPREZA 2.5L

642223

Inlet A: WELDED 3-BOLT FLANGE
Outlet A: WELDED 2-BOLT FLANGE W/ GASKET STUB
Length: 42.25"



- 2005-00 6 LEXUS GS300 3.0L
- 2005-01 6 LEXUS IS300 3.0L

642224

Inlet A: WELDED 2-BOLT FLANGE
Outlet A: WELDED 3-BOLT FLANGE
Length: 30.25"



- 2011-06 4 HONDA CIVIC 2.0L

DIRECT FIT



642225

Inlet A: WELDED 2-BOLT FLANGE
 Outlet A: WELDED 3-BOLT FLANGE
 Length: 27.50"



2001-00 3 HONDA INSIGHT 1.0L

642226

Inlet A: WELDED 2-BOLT FLANGE
 Outlet A: WELDED 2-BOLT FLANGE W/ GASKET STUB
 Length: 33.75"



2011-09 4 NISSAN VERSA 1.6L
 2012-07 4 NISSAN VERSA 1.8L

642227

Inlet A: WELDED 2-BOLT FLANGE
 Outlet A: WELDED 2-BOLT FLANGE
 Length: 9.75"

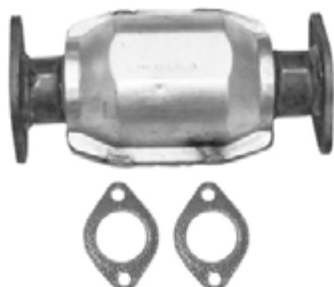

2009-07 4 KIA SPECTRA 2.0L

642228

Inlet A: WELDED 3-BOLT FLANGE
 Inlet B: WELDED 2-BOLT FLANGE
 Outlet A: WELDED 2-BOLT FLANGE
 Length: 28.63"



2006-05 6 CHEVROLET MALIBU 3.5L

642229

Inlet A: WELDED 3-BOLT FLANGE
 Outlet A: WELDED 2-BOLT FLANGE
 Length: 39.25"



2006-05 6 CHEVROLET MALIBU 3.5L
 2006-05 6 PONTIAC G6 3.5L
 2007 6 SATURN AURA 3.5L

642230

Inlet A: LOOSE 2-BOLT FLANGE W/ SPHERICAL FLARE
 Outlet A: 2.25" O.D. PIPE
 Length: 45"



2002-00 6 JAGUAR S-TYPE 3.0L
 2005-00 6 LINCOLN LS 3.0L

642231

Inlet A: WELDED 4-BOLT FLANGE
 Outlet A: 2.25" O.D. PIPE
 Length: 40"



2010-07 4 CHRYSLER SEBRING 2.4L
 2010-08 4 DODGE AVENGER 2.4L
 2009-07 4 DODGE CALIBER 1.8L
 2010-07 4 DODGE CALIBER 2.0L
 2010-07 4 DODGE CALIBER 2.4L
 2011-07 4 JEEP COMPASS 2.0L
 2011-07 4 JEEP COMPASS 2.4L
 2010-07 4 JEEP PATRIOT 2.4L
 2011-07 4 JEEP PATRIOT 2.0L

642232

Inlet A: WELDED 9-BOLT FLANGE
Outlet A: WELDED 2-BOLT FLANGE
Length: 18"



2005-01 4 HYUNDAI ACCENT 1.6L

642233

Inlet A: WELDED 8-BOLT FLANGE
Outlet A: WELDED 2-BOLT FLANGE
Length: 23.25"



2006-01 6 BMW 325 2.5L
2005-01 6 BMW 330 3.0L
2002-01 6 BMW Z3 2.5L
2002-01 6 BMW Z3 3.0L

642234

Inlet A: WELDED 8-BOLT FLANGE
Outlet A: WELDED 2-BOLT FLANGE
Length: 32"



2006-01 6 BMW 325 2.5L
2005-01 6 BMW 330 3.0L
2002-01 6 BMW Z3 2.5L
2002-01 6 BMW Z3 3.0L

642235

Inlet A: WELDED 2-BOLT FLANGE
Outlet A: WELDED 2-BOLT FLANGE
Length: 39"



2009-06 6 CHEVROLET IMPALA FWD 3.5L
2009-06 6 CHEVROLET IMPALA FWD 3.9L
2006 6 CHEVROLET MONTE CARLO 3.9L
2007-06 6 CHEVROLET MONTE CARLO 3.5L

642236

Inlet A: WELDED 2-BOLT FLANGE
Outlet A: WELDED 2-BOLT FLANGE
Length: 15.75"



2009-06 4 HYUNDAI SONATA 2.4L
2008-06 4 KIA OPTIMA 2.4L
2009-07 4 KIA RONDO 2.4L

642237

Inlet A: WELDED 2-BOLT FLANGE
Outlet A: 2.25" O.D. PIPE
Length: 24"



2008-06 4 TOYOTA RAV4 2.4L
2013-09 4 TOYOTA RAV4 2.5L

DIRECT FIT



642239

Inlet A: WELDED 3-BOLT FLANGE
 Outlet A: WELDED 3-BOLT FLANGE
 Length: 43.50"

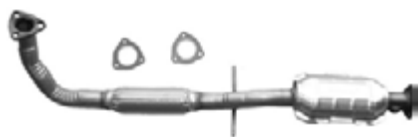

2002-01 4 SATURN SC1 1.9L
 2002-01 4 SATURN SL / SL1 1.9L

642240

Inlet A: WELDED 2-BOLT FLANGE
 Outlet A: WELDED 2-BOLT FLANGE
 Length: 40.50"



2003-01 4 MAZDA PROTÉGÉ 2.0L

642241

Inlet A: WELDED 3-BOLT FLANGE
 Outlet A: WELDED 3-BOLT FLANGE
 Length: 34.50"



2004-03 4 SATURN ION 2.2L

642242

Inlet A: WELDED 2-BOLT FLANGE
 Outlet A: WELDED 2-BOLT FLANGE W/ GASKET STUB
 Length: 29.50"



2008-03 4 MAZDA 6 2.3L

642243

Inlet A: WELDED 2-BOLT FLANGE
 Outlet A: WELDED 2-BOLT FLANGE
 Length: 19.50"



2007-05 6 FORD FIVE HUNDRED 3.0L
 2007-05 6 FORD FREESTYLE 3.0L
 2007-05 6 MERCURY MONTEGO 3.0L

642244

Inlet A: WELDED 3-BOLT FLANGE W/ GASKET STUB
 Inlet B: WELDED 3-BOLT FLANGE W/ GASKET STUB
 Outlet A: WELDED 2-BOLT FLANGE
 Length: 41.75"



2006-04 6 NISSAN ALTIMA 3.5L
 2006-04 6 NISSAN MAXIMA 3.5L
 2009-04 6 NISSAN QUEST 3.5L

642245

Inlet A: WELDED 3-BOLT FLANGE
 Inlet B: WELDED 3-BOLT FLANGE
 Outlet A: WELDED 2-BOLT FLANGE
 Length: 42"



2007-03 6 NISSAN MURANO 3.5L

642246

Inlet A: WELDED 4-BOLT FLANGE
Outlet A: 2-1/2" O.D. PIPE
Length: 34"



2008-05 6 CHRYSLER PACIFICA 3.8L

642247

Inlet A: WELDED 3-BOLT FLANGE W/ GASKET STUB
Outlet A: 1.770" O.D. PIPE
Length: 45"



1997-93 6 INFINITI J30 3.0L

642248

Inlet A: WELDED 3-BOLT FLANGE W/ GASKET STUB
Outlet A: WELDED 2-BOLT FLANGE
Length: 43.50"



1997-93 6 INFINITI J30 3.0L

642249

Inlet A: WELDED 6-BOLT FLANGE
Outlet A: WELDED 4-BOLT FLANGE
Length: 16.50"



2011-06 4 MITSUBISHI ECLIPSE 2.4L
2012-04 4 MITSUBISHI GALANT 2.4L

642250

Inlet A: WELDED 2-BOLT FLANGE
Outlet A: 2.25" O.D. PIPE
Length: 17.13"



2007-05 6 FORD FIVE HUNDRED 3.0L
2007-05 6 FORD FREESTYLE 3.0L
2007-05 6 MERCURY MONTEGO 3.0L

642251

Inlet A: WELDED 2-BOLT FLANGE
Outlet A: WELDED 2-BOLT FLANGE
Length: 18"



2007-05 6 FORD FIVE HUNDRED 3.0L
2007-05 6 FORD FREESTYLE 3.0L
2007-05 6 MERCURY MONTEGO 3.0L

642252

Inlet A: WELDED 2-BOLT FLANGE
Outlet A: WELDED 2-BOLT FLANGE
Length: 20"



2007-05 6 FORD FIVE HUNDRED 3.0L
2007-05 6 MERCURY MONTEGO 3.0L

DIRECT FIT



642253

Inlet A: WELDED 3-BOLT FLANGE W/ GASKET STUB
 Outlet A: WELDED 2-BOLT FLANGE W/ GASKET STUB
 Length: 22.50"



2005-03 6 MAZDA 6 3.0L

642254

Inlet A: WELDED 2-BOLT FLANGE
 Outlet A: WELDED 2-BOLT FLANGE W/ GASKET STUB
 Length: 30"



2005-03 6 MAZDA 6 3.0L

642255

Inlet A: LOOSE 2-BOLT FLANGE W/ FLARE
 Outlet A: LOOSE 2-BOLT FLANGE W/ FLARE
 Length: 39.25"



2008-04 6 CHRYSLER CROSSFIRE 3.2L
 2004-01 6 MERCEDES-BENZ SLK320 3.2L

642256

Inlet A: 2.50" I.D. PIPE
 Outlet A: WELDED 3-BOLT FLANGE
 Length: 30.50"

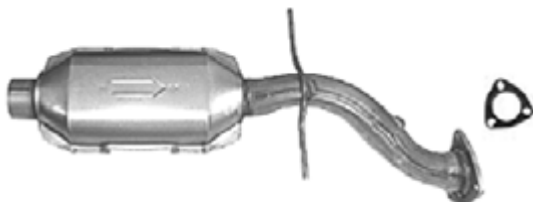

1995 6 CHEVROLET BLAZER S-Series 4.3L
 1995 6 GMC S-15 JIMMY 4.3L

642257

Inlet A: 2.50" I.D. PIPE
 Outlet A: WELDED 3-BOLT FLANGE
 Length: 28"

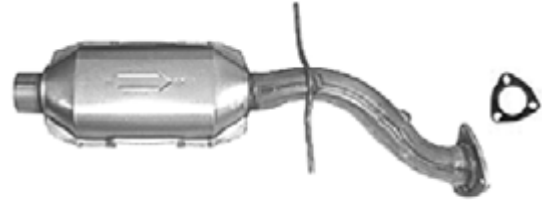

1995 6 CHEVROLET BLAZER S-Series 4.3L
 1995 6 GMC S-15 JIMMY 4.3L

642258

Inlet A: 45 DEGREE FLARE
 Outlet A: 2.25" O.D. PIPE
 Length: 46.63"



2001-98 6 CHRYSLER CONCORDE 3.2L
 2004-02 6 CHRYSLER CONCORDE 3.5L
 2001-99 6 CHRYSLER LHS 3.5L
 2001-98 6 DODGE INTREPID 3.2L
 2004-02 6 DODGE INTREPID 3.5L

642259

Inlet A: WELDED 2-BOLT FLANGE W/ GASKET STUB
 Inlet B: WELDED 2-BOLT FLANGE W/ GASKET STUB
 Outlet A: WELDED 2-BOLT FLANGE W/ GASKET STUB
 Length: 35"



2001-99 6 LEXUS ES300 3.0L
 2004-00 6 TOYOTA AVALON 3.0L

642260

Inlet A: LOOSE 2-BOLT FLANGE W/ FEMALE FLARE
 Outlet A: 1.965" O.D. PIPE
 Length: 27.50"



2003-00 8 BMW X5 4.4L

642261

Inlet A: LOOSE 2-BOLT FLANGE W/ FEMALE FLARE
 Outlet A: 1.965" O.D. PIPE
 Length: 27.50"



2003-00 8 BMW X5 4.4L
 2003-02 8 BMW X5 4.6L

642262

Inlet A: WELDED 3-BOLT FLANGE
 Outlet A: WELDED 3-BOLT FLANGE
 Length: 17"

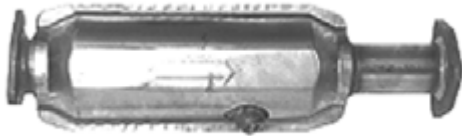

2002-01 6 ACURA MDX 3.5L
 2004-03 6 HONDA PILOT 3.5L

642263

Inlet A: WELDED 3-BOLT FLANGE
 Outlet A: WELDED 3-BOLT FLANGE
 Length: 6.88"



2008-04 4 CHEVROLET AVEO 1.6L
 2008-07 4 CHEVROLET AVEO5 1.6L
 2002-99 4 DAEWOO LANOS 1.6L

642264

Inlet A: WELDED 3-BOLT FLANGE W/ GASKET STUB
 Inlet B: WELDED 3-BOLT FLANGE W/ GASKET STUB
 Outlet A: WELDED 2-BOLT FLANGE
 Length: 38.25"



2006-02 6 NISSAN ALTIMA 3.5L
 2006-04 6 NISSAN QUEST 3.5L

642265

Inlet A: WELDED 2-BOLT FLANGE
 Outlet A: WELDED 2-BOLT FLANGE W/ GASKET STUB
 Length: 19.50"

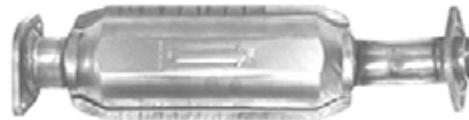

2006-02 6 MAZDA MPV VAN 3.0L

642266

Inlet A: WELDED 3-BOLT FLANGE
 Outlet A: WELDED 2-BOLT FLANGE
 Length: 40.50"



2006-02 6 MAZDA MPV VAN 3.0L

642267

Inlet A: WELDED 3-BOLT FLANGE W/ GASKET STUB
 Outlet A: WELDED 2-BOLT FLANGE
 Length: 10.13"



1997-92 8 LEXUS SC400 4.0L

DIRECT FIT



642268

Inlet A: 45 DEGREE FLARE
 Outlet A: 2.25" O.D. PIPE
 Length: 46.63"



2004-02 6 CHRYSLER CONCORDE 2.7L
 2004-02 6 DODGE INTREPID 2.7L

642273

Inlet A: WELDED 2-BOLT FLANGE
 Outlet A: WELDED 2-BOLT FLANGE
 Length: 25.50"

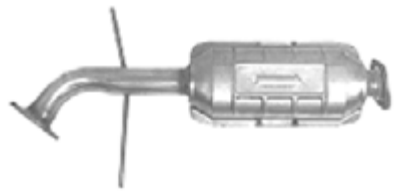

2005-02 6 KIA SEDONA 3.5L

642269

Inlet A: WELDED 2-BOLT FLANGE
 Outlet A: 1.88" O.D. PIPE
 Length: 19"

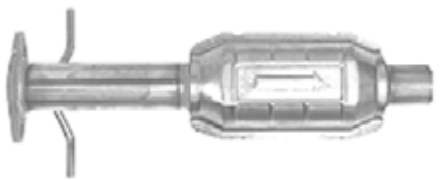

2007-03 4 FORD FOCUS 2.3L
 2007-05 4 FORD FOCUS 2.0L
 2009 4 FORD FUSION 2.3L

642274

Inlet A: WELDED 2-BOLT FLANGE W/ GASKET STUB
 Inlet B: WELDED 2-BOLT FLANGE W/ GASKET STUB
 Outlet A: WELDED 2-BOLT FLANGE
 Length: 47"



2005-03 6 HYUNDAI TIBURON 2.7L

642270

Inlet A: WELDED 2-BOLT FLANGE
 Outlet A: WELDED 2-BOLT FLANGE W/ GASKET STUB
 Length: 38.13"



1997-93 6 LEXUS GS300 3.0L
 1997-93 6 LEXUS SC300 3.0L

642275

Inlet A: WELDED 3-BOLT FLANGE W/ GASKET STUB
 Outlet A: WELDED 2-BOLT FLANGE
 Length: 30"



1998-95 4 NISSAN 240SX 2.4L

642271

Inlet A: WELDED 2-BOLT FLANGE W/ GASKET STUB
 Inlet B: WELDED 2-BOLT FLANGE W/ GASKET STUB
 Outlet A: WELDED 2-BOLT FLANGE W/ GASKET STUB
 Length: 24.50"

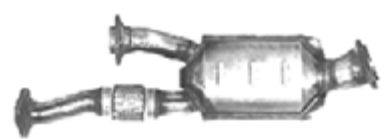

1994-93 6 LEXUS GS300 3.0L
 1994-93 6 LEXUS SC300 3.0L

642276

Inlet A: WELDED 4-BOLT FLANGE
 Outlet A: 2.355" O.D. PIPE
 Length: 40.50"



2004-00 4 VOLVO S40/V40 1.9L

642277

Inlet A: WELDED 5-BOLT FLANGE
Outlet A: WELDED 2-BOLT FLANGE
Length: 20"



2003-01 4 TOYOTA RAV4 2.0L

642278

Inlet A: WELDED 2-BOLT FLANGE
Outlet A: WELDED 2-BOLT FLANGE W/ GASKET STUB
Length: 37.88"



2009-05 6 BUICK LACROSSE 3.8L
2008-04 6 PONTIAC GRAND PRIX 3.8L

642279

Inlet A: WELDED 3-BOLT FLANGE
Outlet A: 2.50" O.D. PIPE
Length: 32.25"



2006-04 6 CHRYSLER PACIFICA 3.5L

642280

Inlet A: WELDED 2-BOLT FLANGE
Outlet A: WELDED 2-BOLT FLANGE
Length: 41.75"



2006-02 4 NISSAN ALTIMA 2.5L

642281

Inlet A: WELDED 6-BOLT FLANGE
Outlet A: WELDED 2-BOLT FLANGE W/ GASKET STUB
Length: 15.38"



2003-01 4 ACURA EL 1.7L
2005-01 4 HONDA CIVIC 1.7L

642282

Inlet A: WELDED 3-BOLT FLANGE W/ GASKET STUB
Outlet A: WELDED 2-BOLT FLANGE
Length: 25.25"



2000-98 6 INFiniti QX4 3.3L
2001 6 INFiniti QX4 3.5L
2000-98 6 NISSAN PATHFINDER 3.3L
2001 6 NISSAN PATHFINDER 3.5L

642283

Inlet A: WELDED 3-BOLT FLANGE W/ GASKET STUB
Outlet A: WELDED 2-BOLT FLANGE
Length: 25.25"



2000-98 6 INFiniti QX4 3.3L
2001 6 INFiniti QX4 3.5L
2000-98 6 NISSAN PATHFINDER 3.3L
2001 6 NISSAN PATHFINDER 3.5L

DIRECT FIT



642284

Inlet A: WELDED 3-BOLT FLANGE
 Outlet A: WELDED 3-BOLT FLANGE
 Length: 41.50"



- 2002-01 4 SATURN SC2 1.9L
- 2002-01 4 SATURN SL2 1.9L
- 2001 4 SATURN SW2 1.9L

642288

Inlet A: WELDED 2-BOLT FLANGE
 Outlet A: WELDED 3-BOLT FLANGE
 Length: 28.50"



- 2006-02 4 HONDA CRV 2.4L

642285

Inlet A: WELDED 2-BOLT FLANGE
 Outlet A: WELDED 2-BOLT FLANGE W/ GASKET STUB
 Length: 30.50"



- 2001-95 4 SUZUKI ESTEEM 1.6L
- 2002-99 4 SUZUKI ESTEEM 1.8L

642289

Inlet A: WELDED 3-BOLT FLANGE
 Outlet A: WELDED 3-BOLT FLANGE
 Length: 43.75"



- 1999-98 4 SATURN SC1 1.9L
- 1999-98 4 SATURN SL / SL1 1.9L
- 1999-98 4 SATURN SW1 1.9L

642286

Inlet A: WELDED 4-BOLT FLANGE
 Outlet A: 2.25" O.D. PIPE
 Length: 35.88"



- 2010-01 4 CHRYSLER PT CRUISER 2.4L

642290

Inlet A: WELDED 2-BOLT FLANGE
 Outlet A: WELDED 2-BOLT FLANGE
 Length: 41.50"



- 2003 4 HYUNDAI ELANTRA 2.0L
- 2006-03 4 HYUNDAI TIBURON 2.0L

642287

Inlet A: LOOSE 2-BOLT FLANGE W/ SPHERICAL FLARE
 Outlet A: WELDED 2-BOLT FLANGE
 Length: 18.13"



- 2000-94 6 MITSUBISHI MONTERO 3.5L

642291

Inlet A: WELDED 2-BOLT FLANGE
 Outlet A: WELDED 2-BOLT FLANGE W/ GASKET STUB
 Length: 36"



- 2005 4 SAAB 9-2X 2.5L
- 2006-03 4 SUBARU BAJA 2.5L

642291 (cont.)

- 2005-99 4 SUBARU FORESTER 2.5L
- 2005-99 4 SUBARU IMPREZA 2.5L
- 2005-00 4 SUBARU LEGACY 2.5L
- 2005-00 4 SUBARU OUTBACK 2.5L

642292

Inlet A: WELDED 4-BOLT FLANGE
 Outlet A: 2" O.D. PIPE
 Length: 33.25"



- 2001-00 4 DODGE NEON 2.0L
- 2001-00 4 PLYMOUTH NEON 2.0L

642293

Inlet A: LOOSE 2-BOLT FLANGE W/ SPHERICAL FLARE
 Outlet A: 2.25" O.D. PIPE
 Outlet B: LOOSE 2-BOLT FLANGE W/ MALE BALL
 Length: 46"



- 2001-97 6 FORD EXPLORER 4.0L
- 2001-98 6 MERCURY MOUNTAINEER 4.0L

642294

Inlet A: WELDED 3-BOLT FLANGE
 Inlet B: WELDED 3-BOLT FLANGE
 Outlet A: WELDED 3-BOLT FLANGE
 Length: 42.25"



- 2005-00 6 SATURN L300 3.0L
- 2005-00 6 SATURN LW300 3.0L

642295

Inlet A: WELDED 3-BOLT FLANGE
 Outlet A: WELDED 3-BOLT FLANGE W/ GASKET STUB
 Length: 46.38"



- 2006-02 4 SATURN VUE 2.2L

642296

Inlet A: WELDED 2-BOLT FLANGE
 Outlet A: WELDED 2-BOLT FLANGE
 Length: 13.25"



- 2002-01 4 KIA RIO 1.5L

642297

Inlet A: WELDED 2-BOLT FLANGE
 Outlet A: WELDED 2-BOLT FLANGE
 Length: 15.50"

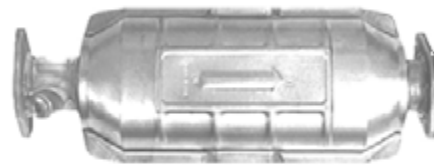

- 2003-02 4 MITSUBISHI LANCER 2.0L

642298

Inlet A: WELDED 2-BOLT FLANGE
 Outlet A: WELDED 2-BOLT FLANGE
 Length: 27.38"



- 2003-01 6 MITSUBISHI MONTERO SPORT 3.0L

DIRECT FIT



642299

Inlet A: WELDED 2-BOLT FLANGE
 Outlet A: WELDED 2-BOLT FLANGE
 Length: 19.13"

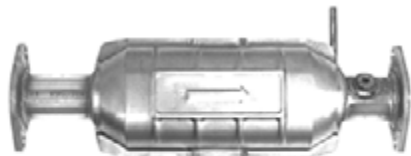

- 2002-98 4 MAZDA 626 2.0L
- 2002-98 6 MAZDA 626 2.5L

642300

Inlet A: WELDED 2-BOLT FLANGE
 Outlet A: WELDED 2-BOLT FLANGE W/ GASKET STUB
 Length: 45"



- 2001-98 4 CHEVROLET METRO 1.3L
- 1997 4 GEO METRO 1.3L
- 2001-98 4 SUZUKI SWIFT 1.3L

642301

Inlet A: 2.50" I.D. PIPE
 Outlet A: 2.50" O.D. PIPE
 Length: 24.75"



- 1980-77 6 CHECKER MARATHON All
- 1985 6 CHEVROLET ASTRO VAN 4.3L
- 1982-75 6 CHEVROLET BLAZER FULL SIZE 4.1L
- 1982-75 8 CHEVROLET BLAZER FULL SIZE All
- 1982-75 6 CHEVROLET C-(2WD), K-(4WD) PICKUP 1/2 TON, (Inc. SILVERADO & AVALANCHE) All
- 1986-83 8 CHEVROLET C-(2WD), K-(4WD) PICKUP 1/2 TON, (Inc. SILVERADO & AVALANCHE) 5.0L
- 1982-75 8 CHEVROLET C-(2WD), K-(4WD) PICKUP 1/2 TON, (Inc. SILVERADO & AVALANCHE) All
- 1984-83 6 CHEVROLET G -VAN 1/2 & 3/4 TON (Inc. Express Van) 4.1L
- 1976-75 8 CHEVROLET G -VAN 1/2 & 3/4 TON (Inc. Express Van) 5.7L
- 1982-79 8 CHEVROLET G -VAN 1/2 & 3/4 TON (Inc. Express Van) All
- 1982-75 6 GMC C-(2WD), K-(4WD) PICKUP 1/2 TON, (Inc. SIERRA) All
- 1986-83 8 GMC C-(2WD), K-(4WD) PICKUP 1/2 TON, (Inc. SIERRA) 5.0L
- 1982-75 8 GMC C-(2WD), K-(4WD) PICKUP 1/2 TON, (Inc. SIERRA) All

642301 (cont.)

- 1976-75 8 GMC G -VAN 1/2 & 3/4 TON (Inc. Savana Van) 5.7L
- 1982-79 8 GMC G -VAN 1/2 & 3/4 TON (Inc. Savana Van) All
- 1984-83 6 GMC G -VAN 1/2 & 3/4 TON (Inc. Savana Van) 4.1L
- 1982-75 6 GMC JIMMY FULL SIZE 4.1L
- 1982-75 8 GMC JIMMY FULL SIZE All
- 1985 6 GMC SAFARI VAN 4.3L

642304

Inlet A: 2.25" I.D. PIPE
 Outlet A: LOOSE GM FLANGE W/ 2.25" MALE BALL
 Length: 20.50"



- 1987-83 6 CHEVROLET BLAZER S-Series 2.8L
- 1988-83 4 CHEVROLET BLAZER S-Series All
- 1980 6 CHEVROLET EL CAMINO 3.8L
- 1993-87 4 CHEVROLET LLV 2.5L
- 1980 6 CHEVROLET MALIBU 3.8L
- 1980 6 CHEVROLET MONTE CARLO 3.8L
- 1984-82 4 CHEVROLET S-Series (2WD), T-Series (4WD) PICKUP 1.9L
- 1984-83 4 CHEVROLET S-Series (2WD), T-Series (4WD) PICKUP 2.0L
- 1987-82 6 CHEVROLET S-Series (2WD), T-Series (4WD) PICKUP 2.8L
- 1993-85 4 CHEVROLET S-Series (2WD), T-Series (4WD) PICKUP 2.5L
- 1980 6 GMC CABALLERO/SPRINT 3.8L
- 1987-83 6 GMC S-15 JIMMY 2.8L
- 1988-83 4 GMC S-15 JIMMY All
- 1984-82 4 GMC S-Series (2WD), T-Series (4WD) PICKUP (SONOMA) 1.9L
- 1984-83 4 GMC S-Series (2WD), T-Series (4WD) PICKUP (SONOMA) 2.0L
- 1993-85 4 GMC S-Series (2WD), T-Series (4WD) PICKUP (SONOMA) 2.5L
- 1987-82 6 GMC S-Series (2WD), T-Series (4WD) PICKUP (SONOMA) 2.8L

642306

Inlet A: LOOSE 3-BOLT FLANGE W/ 45 DEGREE FLARE
 Outlet A: 2.13" O.D. PIPE
 Length: 26.25"

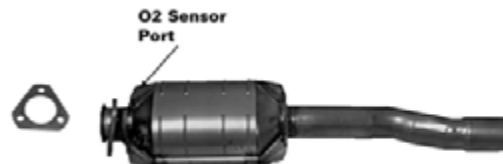

- 1992-85 4 VOLVO 740 2.3L
- 1990-87 6 VOLVO 780 2.8L
- 1995-91 4 VOLVO 940 2.3L

642311

Inlet A: LOOSE 4-BOLT FLANGE W/ FLAT FLARE
Outlet A: 2.25" O.D. PIPE
Length: 22"



- 1992-90 6 DODGE MONACO 3.0L
- 1989-88 4 EAGLE PREMIER 2.5L
- 1992-88 6 EAGLE PREMIER 3.0L
- 1992-86 4 JEEP CHEROKEE 2.5L
- 1992-87 6 JEEP CHEROKEE 4.0L
- 1986 4 JEEP COMANCHE 2.5L
- 1992-87 4,6 JEEP COMANCHE All
- 1987-86 4 JEEP WAGONEER 2.5L
- 1990-87 6 JEEP WAGONEER 4.0L
- 1992-87 4 JEEP WRANGLER 2.5L
- 1992-91 6 JEEP WRANGLER 4.0L

642316

Inlet A: LOOSE 3-BOLT FLANGE W/ FLAT FLARE
Outlet A: 2" O.D. PIPE
Length: 36.25"



- 1993-84 4 VOLVO 240 2.3L

642320

Inlet A: LOOSE 2-BOLT CHRYSLER FLANGE W/ CHRYSLER FLARE
Outlet A: 1.88" O.D. PIPE
Length: 35.25"



- 1993-89 4 CHRYSLER DAYTONA 2.5L
- 1993-88 4 CHRYSLER DYNASTY 2.5L
- 1986-84 4 CHRYSLER LASER All
- 1989 4 CHRYSLER LEBARON 2.2L
- 1993-89 4 CHRYSLER LEBARON 2.5L
- 1984 4 DODGE DAYTONA 2.2L
- 1986-85 4 DODGE DAYTONA All
- 1993-87 4 DODGE DAYTONA 2.5L
- 1993-88 4 DODGE DYNASTY 2.5L
- 1989-88 4 DODGE LANCER 2.2L
- 1989-88 4 DODGE LANCER 2.5L
- 1994-87 4 DODGE SHADOW 2.2L
- 1994-89 4 DODGE SHADOW 2.5L
- 1995-89 4 DODGE SPIRIT 2.5L

642320 (cont.)

- 1995-89 4 PLYMOUTH ACCLAIM 2.5L
- 1994-87 4 PLYMOUTH SUNDANCE, DUSTER 2.2L
- 1994-89 4 PLYMOUTH SUNDANCE, DUSTER 2.5L

642326

Inlet A: LOOSE 2-BOLT FLANGE W/ 2" FLAT FLARE
Outlet A: LOOSE 2-BOLT FLANGE W/ 2" FLAT FLARE
Length: 16.50"



- 1988-85 4 CHEVROLET NOVA 1.6L
- 1989-83 4 TOYOTA COROLLA All

642328

Inlet A: LOOSE 2-BOLT FLANGE W/ FEMALE FLARE
Inlet B: LOOSE 2-BOLT FLANGE W/ FEMALE FLARE
Outlet A: WELDED 2-BOLT FLANGE W/ GASKET STUB
Length: 27"

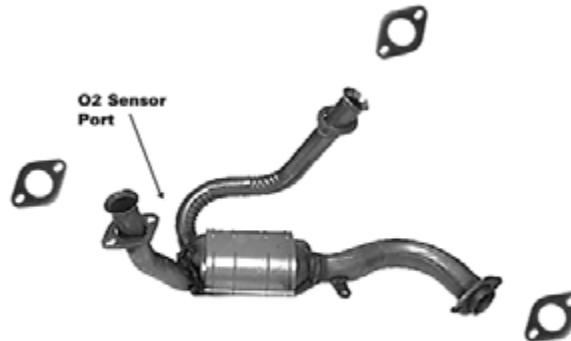

- 1993-86 6 FORD TAURUS 3.0L
- 1994-86 6 MERCURY SABLE 3.0L

642334

Inlet A: LOOSE 2-BOLT FLANGE W/ 2.50" FLAT FLARE
Outlet A: LOOSE 2-BOLT FLANGE W/ 2.50" FLAT FLARE
Length: 12.50"



- 1994-92 6 LEXUS ES300 3.0L
- 1992-89 4 NISSAN 240SX All
- 1995-88 4 NISSAN PICKUP 2.4L
- 1993-92 4 TOYOTA CAMRY, (Inc. 1998 & Older SOLARA) 2.2L

DIRECT FIT



642334 (cont.)

1994-92	6	TOYOTA CAMRY, (Inc. 1998 & Older SOLARA) 3.0L
1989-86	4	TOYOTA CELICA 2.0L
1993-90	4	TOYOTA CELICA 1.6L
1992-89	6	TOYOTA CRESSIDA 3.0L
1995-89	4	TOYOTA PICKUP (ALL MODELS Exc. TACOMA & TUNDRA) 2.4L
1992-86	6	TOYOTA SUPRA 3.0L
1989-88	4	TOYOTA VAN 2.2L

642335

Inlet A: 2.50" I.D. PIPE
Outlet A: WELDED 4-BOLT GM FLANGE W/ 2.50" MALE BALL
Length: 21.38"



1991-88	6	CHEVROLET BLAZER S-Series All
1994-92	6	CHEVROLET BLAZER S-Series 4.3L
1993-88	6	CHEVROLET S-Series (2WD), T-Series (4WD) PICKUP 2.8L
1994-88	6	CHEVROLET S-Series (2WD), T-Series (4WD) PICKUP 4.3L
1991-88	6	GMC S-15 JIMMY All
1994-92	6	GMC S-15 JIMMY 4.3L
1993-88	6	GMC S-Series (2WD), T-Series (4WD) PICKUP (SONOMA) 2.8L
1994-88	6	GMC S-Series (2WD), T-Series (4WD) PICKUP (SONOMA) 4.3L
1992-91	6	OLDSMOBILE BRAVADA 4.3L

642352

Inlet A: 2.25" I.D. PIPE
Outlet A: LOOSE 4-BOLT GM FLANGE W/ 2.25" MALE BALL
Length: 22"



1978	8	BUICK CENTURY 5.0L
1979-78	6	BUICK CENTURY All
1981	6	BUICK CENTURY 3.8L
1981	8	BUICK CENTURY 4.3L
1983-81	6	BUICK ELECTRA - (Inc. Park Avenue) 4.1L
1983-81	8	BUICK ELECTRA - (Inc. Park Avenue) 5.0L
1982-81	6	BUICK LESABRE All
1983-81	8	BUICK LESABRE 5.0L
1979-78	6	BUICK REGAL 3.8L
1982-80	8	BUICK REGAL All
1982-81	6	BUICK REGAL All
1983-81	6	BUICK RIVIERA 4.1L
1983-81	8	BUICK RIVIERA 5.0L
1982-81	6	CADILLAC DEVILLE 4.1L

642352 (cont.)

1983-82	8	CADILLAC DEVILLE 4.1L
1982-81	6	CADILLAC ELDORADO 4.1L
1983-82	8	CADILLAC ELDORADO 4.1L
1982-81	6	CADILLAC FLEETWOOD 4.1L
1983-82	8	CADILLAC FLEETWOOD 4.1L
1982-81	6	CADILLAC SEVILLE 4.1L
1983-82	8	CADILLAC SEVILLE 4.1L
1980	8	CHEVROLET CAMARO 4.4L
1981	6	CHEVROLET CAMARO 3.8L
1981	8	CHEVROLET CAMARO All
1978	8	CHEVROLET EL CAMINO 5.0L
1979-78	6	CHEVROLET EL CAMINO All
1979	8	CHEVROLET EL CAMINO 4.4L
1982-81	8	CHEVROLET EL CAMINO All
1983-80	6	CHEVROLET EL CAMINO 3.8L
1983	6	CHEVROLET FULL SIZE (Inc. Impala RWD, Caprice, Belair, Police, Taxi, Station Wagon) 3.8L
1982-81	8	CHEVROLET FULL SIZE (Inc. Impala RWD, Caprice, Belair, Police, Taxi, Station Wagon) All
1979-78	6	CHEVROLET MALIBU All
1979	8	CHEVROLET MALIBU 4.4L
1982-81	8	CHEVROLET MALIBU All
1983-80	6	CHEVROLET MALIBU 3.8L
1978	8	CHEVROLET MONTE CARLO 5.0L
1979	8	CHEVROLET MONTE CARLO 4.4L
1982-81	8	CHEVROLET MONTE CARLO All
1983-80	6	CHEVROLET MONTE CARLO 3.8L
1978	8	GMC CABALLERO/SPRINT 5.0L
1979-78	6	GMC CABALLERO/SPRINT All
1979	8	GMC CABALLERO/SPRINT 4.4L
1982-81	8	GMC CABALLERO/SPRINT All
1983-80	6	GMC CABALLERO/SPRINT 3.8L
1983-81	6	OLDSMOBILE 98 4.1L
1983-81	8	OLDSMOBILE 98 5.0L
1982-78	8	OLDSMOBILE CUTLASS 4.3L
1982-81	8	OLDSMOBILE CUTLASS 5.0L
1983-78	6	OLDSMOBILE CUTLASS 3.8L
1982-81	6	OLDSMOBILE EIGHTY-EIGHT, DELTA 88 All
1983-81	8	OLDSMOBILE EIGHTY-EIGHT, DELTA 88 5.0L
1983-81	6	OLDSMOBILE TORONADO 4.1L
1983-81	8	OLDSMOBILE TORONADO 5.0L
1983-81	8	PONTIAC BONNEVILLE All
1983	6	PONTIAC BONNEVILLE 3.8L
1981	6	PONTIAC CATALINA All
1981	8	PONTIAC CATALINA All
1981	6	PONTIAC FIREBIRD, TRANS AM, FORMULA 3.8L
1981	8	PONTIAC FIREBIRD, TRANS AM, FORMULA 4.3L
1981	8	PONTIAC FIREBIRD, TRANS AM, FORMULA 4.9L
1981	8	PONTIAC FIREBIRD, TRANS AM, FORMULA 5.0L
1978	8	PONTIAC GRAND AM 5.0L
1979-78	8	PONTIAC GRAND PRIX 4.9L
1982	6	PONTIAC GRAND PRIX All
1983-81	6	PONTIAC GRAND PRIX 3.8L
1983-81	8	PONTIAC GRAND PRIX All
1978	8	PONTIAC LE MANS 5.0L
1981	6	PONTIAC LE MANS 3.8L
1981	8	PONTIAC LE MANS 4.3L

642353

Inlet A: LOOSE 4-BOLT FLANGE W/ 2.25" FLAT FLARE
Outlet A: LOOSE 4-BOLT GM FLANGE W/ 2.25" MALE BALL
Length: 21"



- 1984 6 BUICK ELECTRA - (Inc. Park Avenue) 4.1L
- 1985-83 6 BUICK LESABRE All
- 1984-83 6 BUICK REGAL 4.1L
- 1987-83 6 BUICK REGAL 3.8L
- 1987-86 8 BUICK REGAL 5.0L
- 1984 6 BUICK RIVIERA 4.1L
- 1985-81 6 BUICK RIVIERA 3.8L
- 1984 6 CHEVROLET EL CAMINO 3.8L
- 1984-83 6 CHEVROLET FULL SIZE (Inc. Impala RWD, Caprice, Belair, Police, Taxi, Station Wagon) 3.8L
- 1984-81 6 CHEVROLET MONTE CARLO 3.8L
- 1984 6 GMC CABALLERO/SPRINT 3.8L
- 1987-83 6 OLDSMOBILE CUTLASS 3.8L
- 1988-83 8 OLDSMOBILE CUTLASS 5.0L
- 1984-83 6 OLDSMOBILE EIGHTY-EIGHT, DELTA 88 All
- 1984 6 OLDSMOBILE TORONADO 4.1L
- 1986-83 6 PONTIAC BONNEVILLE 3.8L
- 1987-83 6 PONTIAC GRAND PRIX 3.8L
- 1985-84 6 PONTIAC PARISIENNE 3.8L

642354

Inlet A: LOOSE 2-BOLT FLANGE W/ 2" FEMALE FLARE
Outlet A: LOOSE 2-BOLT FLANGE W/ FLAT FLARE
Length: 24"



- 1995-91 4 FORD ESCORT 1.9L
- 1995-91 4 MERCURY TRACER 1.9L

642355

Inlet A: 2.25" I.D. PIPE
Outlet A: LOOSE 4-BOLT GM FLANGE W/ 2.50" MALE BALL
Length: 23"



- 1985-83 8 BUICK REGAL 5.0L

642355 (cont.)

- 1991 8 BUICK ROADMASTER 5.0L
- 1993-92 8 BUICK ROADMASTER 5.7L
- 1992-82 8 CHEVROLET CAMARO 5.0L
- 1992-83 6 CHEVROLET CAMARO All
- 1984-83 6 CHEVROLET EL CAMINO 3.8L
- 1987-83 8 CHEVROLET EL CAMINO All
- 1984-83 6 CHEVROLET FULL SIZE (Inc. Impala RWD, Caprice, Belair, Police, Taxi, Station Wagon) 3.8L
- 1993-92 6 CHEVROLET FULL SIZE (Inc. Impala RWD, Caprice, Belair, Police, Taxi, Station Wagon) 4.3L
- 1993-83 8 CHEVROLET FULL SIZE (Inc. Impala RWD, Caprice, Belair, Police, Taxi, Station Wagon) 5.0L
- 1990-83 8 CHEVROLET FULL SIZE (Inc. Impala RWD, Caprice, Belair, Police, Taxi, Station Wagon) 5.7L
- 1983 6 CHEVROLET MALIBU 3.8L
- 1983 8 CHEVROLET MALIBU 5.0L
- 1984-83 6 CHEVROLET MONTE CARLO 3.8L
- 1988-83 8 CHEVROLET MONTE CARLO All
- 1984-83 6 GMC CABALLERO/SPRINT 3.8L
- 1987-83 8 GMC CABALLERO/SPRINT All
- 1986-84 8 PONTIAC BONNEVILLE 5.0L
- 1992-82 8 PONTIAC FIREBIRD, TRANS AM, FORMULA 5.0L
- 1992-83 6 PONTIAC FIREBIRD, TRANS AM, FORMULA All
- 1987-84 8 PONTIAC GRAND PRIX 5.0L
- 1986-85 8 PONTIAC PARISIENNE 5.0L

642356

Inlet A: WELDED 4-BOLT FLANGE
Outlet A: WELDED 4-BOLT FLANGE
Length: 16.13"



- 1985-83 8 CHEVROLET CAMARO 5.0L
- 1988-83 8 CHEVROLET MONTE CARLO 5.0L
- 1985-83 8 PONTIAC FIREBIRD, TRANS AM, FORMULA 5.0L

642357

Inlet A: 2" O.D. PIPE
Outlet A: 2" O.D. PIPE
Length: 27"



- 1989-87 4 BUICK SKYHAWK 2.0L
- 1989-86 4 BUICK SKYLARK 2.5L
- 1989-86 6 BUICK SKYLARK All
- 1987-85 4,6 BUICK SOMERSET - SOMERSET REGAL All
- 1988-87 6 CADILLAC CIMARRON 2.8L
- 1993 6 CHEVROLET BERETTA 3.1L
- 1989-87 4 CHEVROLET CAVALIER 2.0L

DIRECT FIT



642357 (cont.)

1989-87	6	CHEVROLET CAVALIER 2.8L
1994-90	6	CHEVROLET CAVALIER 3.1L
1993	6	CHEVROLET CORSICA 3.1L
1981	8	JEEP CJ 5.0L
1988-85	6	OLDSMOBILE CALAIS 3.0L
1989-85	4	OLDSMOBILE CALAIS 2.5L
1987	6	OLDSMOBILE FIRENZA 2.8L
1987-85	6	PONTIAC GRAND AM 3.0L
1989-85	4	PONTIAC GRAND AM 2.5L
1989	4	PONTIAC SUNBIRD 2.0L
1994-91	6	PONTIAC SUNBIRD 3.1L

642358

Inlet A: LOOSE 2-BOLT FLANGE, W/ 2" FEMALE FLARE
Inlet B: LOOSE 2-BOLT FLANGE, W/ 2" FEMALE FLARE
Outlet A: WELDED 2-BOLT FLANGE
Length: 41.50"



1995-91	6	FORD TAURUS 3.8L
1994-90	6	LINCOLN CONTINENTAL 3.8L
1995-91	6	MERCURY SABLE 3.8L

642359

Inlet A: 2.25" I.D. PIPE
Outlet A: LOOSE 4-BOLT GM FLANGE W/ 2.25" MALE BALL
Length: 23"



1989-84	8	BUICK ELECTRA - (Inc. Park Avenue) 5.0L
1990-84	8	BUICK LESABRE 5.0L
1985-84	8	BUICK RIVIERA 5.0L
1984	8	CADILLAC DEVILLE 4.1L
1980	8	CHEVROLET CAMARO 4.4L
1984	8	OLDSMOBILE 98 5.0L
1990-84	8	OLDSMOBILE EIGHTY-EIGHT, DELTA 88 5.0L
1985-84	8	OLDSMOBILE TORONADO 5.0L
1986	8	PONTIAC PARISIENNE 5.0L
1989-87	8	PONTIAC SAFARI STATION WAGON 5.0L

642360

Inlet A: LOOSE 2-BOLT FLANGE W/ 2.25" FEMALE FLARE
Outlet A: 2.25" O.D. PIPE
Length: 37.25"



1990-88	6	BUICK ELECTRA - (Inc. Park Avenue) 3.8L
1991-88	6	BUICK LESABRE 3.8L
1987-86	6	BUICK RIVIERA 3.8L
1987-86	8	CADILLAC COMMERCIAL CHASSIS - FUNERAL COACH, LIMOUSINE 4.1L
1987-86	8	CADILLAC DEVILLE 4.1L
1987-86	8	CADILLAC FLEETWOOD 4.1L
1990-88	6	OLDSMOBILE 98 3.8L
1991-88	6	OLDSMOBILE EIGHTY-EIGHT, DELTA 88 3.8L
1987-86	6	OLDSMOBILE TORONADO 3.8L
1991-88	6	PONTIAC BONNEVILLE 3.8L

642362

Inlet A: LOOSE 2-BOLT FLANGE W/ 2.25" FEMALE FLARE
Outlet A: 2" O.D. PIPE
Length: 25.75"



1990-86	4	FORD ESCORT 1.9L
1994-85	4	FORD TEMPO 2.3L
1987-86	4	MERCURY LYNX 1.9L
1994-85	4	MERCURY TOPAZ 2.3L

642370

Inlet A: 2.25" O.D. PIPE
Outlet A: 2" O.D. PIPE
Length: 34.75"



1989-88	6	BUICK REGAL 2.8L
1993-89	6	BUICK REGAL 3.1L
1992-90	4	CHEVROLET LUMINA 2.5L
1993-90	6	CHEVROLET LUMINA 3.1L
1989-88	6	OLDSMOBILE CUTLASS 2.8L
1991-90	4	OLDSMOBILE CUTLASS 2.3L
1993-89	6	OLDSMOBILE CUTLASS 3.1L
1989-88	6	PONTIAC GRAND PRIX 2.8L
1991-90	4	PONTIAC GRAND PRIX 2.3L
1993-89	6	PONTIAC GRAND PRIX 3.1L

642374

Inlet A: 2" I.D. PIPE
Outlet A: WELDED 4-BOLT GM FLANGE
Length: 22.25"



- 1988-86 6 BUICK CENTURY 3.8L
- 1989-84 6 BUICK CENTURY 2.8L
- 1992-86 4 BUICK CENTURY 2.5L
- 1990-86 4 CHEVROLET CELEBRITY 2.5L
- 1990-86 6 CHEVROLET CELEBRITY All
- 1988-86 6 OLDSMOBILE CIERA 3.8L
- 1989-86 6 OLDSMOBILE CIERA 2.8L
- 1992-86 4 OLDSMOBILE CIERA 2.5L
- 1989-86 6 PONTIAC 6000 2.8L
- 1991-86 4 PONTIAC 6000 2.5L
- 1991-90 6 PONTIAC 6000 3.1L

642378

Inlet A: LOOSE 3-BOLT FLANGE W/ FLAT FLARE
Outlet A: LOOSE 3-BOLT FLANGE W/ FLAT FLARE
Length: 12.50"



- 1987-86 4 ACURA INTEGRA 1.6L
- 1983-80 4 HONDA ACCORD 1.8L
- 1989-86 4 HONDA ACCORD 2.0L
- 1983-80 4 HONDA CIVIC 1.3L
- 1983-80 4 HONDA CIVIC 1.5L
- 1982-80 4 HONDA PRELUDE 1.8L
- 1991-88 4 HONDA PRELUDE 2.0L

642380

Inlet A: LOOSE 4-BOLT FLANGE W/ 2.50" FLAT FLARE
Outlet A: LOOSE 4-BOLT FLANGE W/ 2.50" FLAT FLARE
Length: 22"



- 1988-87 4 CHEVROLET SPECTRUM 1.5L
- 1993-90 4 GEO STORM All
- 1995-94 6 HONDA PASSPORT 3.2L
- 1993-89 4 ISUZU AMIGO 2.3L
- 1994-89 4 ISUZU AMIGO 2.6L
- 1985-81 4 ISUZU I-MARK 1.8L

642380 (cont.)

- 1989-85 4 ISUZU I-MARK 1.5L
- 1986-83 4 ISUZU IMPULSE 1.9L
- 1989-85 4 ISUZU IMPULSE 2.0L
- 1989-88 4 ISUZU IMPULSE 2.3L
- 1992-90 4 ISUZU IMPULSE 1.6L
- 1992 4 ISUZU IMPULSE 1.8L
- 1987-81 4 ISUZU PICKUP All
- 1994-91 6 ISUZU PICKUP 3.1L
- 1995-86 4 ISUZU PICKUP 2.3L
- 1995-88 4 ISUZU PICKUP 2.6L
- 1992-91 6 ISUZU RODEO 3.1L
- 1995-91 4 ISUZU RODEO 2.6L
- 1995-93 6 ISUZU RODEO 3.2L
- 1991-89 6 ISUZU TROOPER 2.8L
- 1978-76 4 OPEL OPEL 1.8L
- 1989-85 4 PASSPORT I-MARK 1.5L
- 1992-90 4 PASSPORT IMPULSE 1.6L
- 1993-91 4 PASSPORT STYLUS 1.6L

642382

Inlet A: WELDED 2-BOLT FLANGE
Outlet A: LOOSE 3-BOLT FLANGE W/ FLAT FLARE
Length: 15.63"



- 1989-88 4 ACURA INTEGRA 1.6L
- 1989-88 4 HONDA CIVIC All
- 1991-88 4 HONDA CIVIC 1.5L
- 1991-89 4 HONDA CIVIC 1.6L
- 1991-88 4 HONDA CRX 1.5L
- 1991-88 4 HONDA CRX 1.6L

642385

Inlet A: LOOSE 2-BOLT FLANGE W/ 2" FEMALE FLARE
Outlet A: LOOSE 2-BOLT FLANGE W/ 2" FLAT FLARE
Length: 15.25"



- 1988-87 4 DODGE COLT 1.5L
- 1988-87 4 DODGE COLT 1.6L
- 1989-87 4 DODGE RAIDER 2.6L
- 1989-87 4 DODGE RAM 50 PICKUP 2.0L
- 1989-87 4 DODGE RAM 50 PICKUP 2.6L
- 1994-90 4 HYUNDAI EXCEL 1.5L
- 1995-91 4 HYUNDAI SCOUPE 1.5L
- 1988-83 4 MITSUBISHI CORDIA, TREDIA All
- 1988-87 4 MITSUBISHI MIRAGE 1.5L
- 1988-87 4 MITSUBISHI MIRAGE 1.6L
- 1989-87 4 MITSUBISHI MONTERO 2.6L
- 1988-87 4 PLYMOUTH COLT 1.5L

DIRECT FIT



642385 (cont.)

1988-87 4 PLYMOUTH COLT 1.6L

642386

Inlet A: 2.50" O.D. PIPE
 Outlet A: 2.50" I.D. PIPE
 Length: 24"



1991 6 BUICK REATTA 3.8L
 1990-88 8 CADILLAC COMMERCIAL CHASSIS -
 FUNERAL COACH, LIMOUSINE 4.5L
 1993-92 8 CADILLAC DEVILLE 4.9L

642388

Inlet A: 2.50" I.D. PIPE
 Outlet A: 1.88" O.D. PIPE
 Length: 65.50"



1990 6 CHRYSLER IMPERIAL 3.3L
 1990-88 6 CHRYSLER NEW YORKER 3.0L
 1991-88 6 DODGE DYNASTY 3.0L
 1991-89 6 DODGE SPIRIT 3.0L
 1991-89 6 PLYMOUTH ACCLAIM 3.0L

642390

Inlet A: LOOSE 2-BOLT FLANGE W/ FEMALE FLARE
 Outlet A: LOOSE 2-BOLT FLANGE W/ FLAT FLARE
 Length: 33"



1991-86 8 FORD CROWN VICTORIA (Inc. Police, Taxi,
 Station Wagon) 5.0L
 1990-86 8 LINCOLN TOWN CAR 5.0L
 1991-86 8 MERCURY GRAND MARQUIS FULL SIZE 5.0L

642391

Inlet A: LOOSE 2-BOLT FLANGE W/ FEMALE FLARE
 Outlet A: LOOSE 2-BOLT FLANGE W/ FLAT FLARE
 Length: 30.50"



1991-86 8 FORD CROWN VICTORIA (Inc. Police, Taxi,
 Station Wagon) 5.0L
 1990-86 8 LINCOLN TOWN CAR 5.0L
 1991-86 8 MERCURY GRAND MARQUIS FULL SIZE 5.0L

642393

Inlet A: LOOSE 2-BOLT FLANGE W/ 2" FEMALE FLARE
 Outlet A: WELDED 2-BOLT FLANGE W/ 1.75" MALE BALL
 Length: 47.38"



1994-86 4 SUZUKI SAMURAI 1.3L

642394

Inlet A: LOOSE 2-BOLT FLANGE W/ 2.50" FEMALE FLARE
 Outlet A: WELDED 4-BOLT FLANGE
 Length: 41"



1993-90 6 BUICK REGAL 3.8L

642395

Inlet A: LOOSE 2-BOLT FLANGE W/ 2.25" FEMALE FLARE
 Outlet A: 2.25" O.D. PIPE
 Length: 24"



1982 6 BUICK SKYLARK 2.8L
 1985 8 CADILLAC DEVILLE 4.1L

642395 (cont.)

1987-86	8	CADILLAC ELDORADO 4.1L
1987-86	8	CADILLAC SEVILLE 4.1L
1982	6	CHEVROLET CITATION 2.8L
1987-85	6	CHEVROLET EL CAMINO 4.3L
1990-85	6	CHEVROLET FULL SIZE (Inc. Impala RWD, Caprice, Belair, Police, Taxi, Station Wagon) 4.3L
1988-85	6	CHEVROLET MONTE CARLO 4.3L
1987-85	6	GMC CABALLERO/SPRINT 4.3L
1982	6	OLDSMOBILE OMEGA 2.8L
1986	6	PONTIAC BONNEVILLE 4.3L
1987-86	6	PONTIAC GRAND PRIX 4.3L
1986	6	PONTIAC PARISIENNE 4.3L
1982	6	PONTIAC PHOENIX 2.8L

642396

Inlet A: 2" I.D. PIPE
Outlet A: 2" I.D. PIPE
Length: 27"



1989-87	4	CHEVROLET BERETTA 2.0L
1992-87	6	CHEVROLET BERETTA All
1992-90	4	CHEVROLET BERETTA 2.2L
1992-87	4	CHEVROLET CORSICA All
1992-87	6	CHEVROLET CORSICA All

642403

Inlet A: LOOSE 2-BOLT FLANGE W/ 2" FLAT FLARE
Outlet A: LOOSE 2-BOLT FLANGE W/ 2" FLAT FLARE
Length: 17.50"



1988	4	CHEVROLET NOVA 1.6L
1990-89	4	DODGE 2000 GTX All
1990-89	4	DODGE COLT 1.6L
1991-87	4	DODGE COLT 2.0L
1991-89	4	DODGE COLT 1.5L
1994-92	4	DODGE COLT All
1989	6	DODGE RAIDER 3.0L
1992-90	4	DODGE RAM 50 PICKUP 2.4L
1995-91	6	DODGE STEALTH 3.0L
1990-89	4	EAGLE SUMMIT 1.6L
1994-93	4	EAGLE SUMMIT 1.8L
1995-89	4	EAGLE SUMMIT 1.5L
1994-90	4	EAGLE TALON All
1992-89	4	EAGLE VISTA 1.5L
1989-88	4	FORD FESTIVA 1.3L
1995-90	4	GEO PRIZM 1.6L
1995-93	4	GEO PRIZM 1.8L
1994-93	4	HYUNDAI ELANTRA 1.8L
1995-92	4	HYUNDAI ELANTRA 1.6L

642403 (cont.)

1995-93	4	HYUNDAI SCOUPE 1.5L
1991-89	4	HYUNDAI SONATA 2.4L
1995-92	4	HYUNDAI SONATA 2.0L
1994	4	KIA SEPHIA 1.6L
1991-90	6	LEXUS ES250 2.5L
1981-80	4	MAZDA 626 2.0L
1991-90	6	MAZDA 929 3.0L
1987-79	4	MAZDA B-Series PICKUP 2.0L
1989-87	4	MAZDA B-Series PICKUP 2.6L
1993-87	4	MAZDA B-Series PICKUP 2.2L
1993-89	6	MAZDA MPV VAN 3.0L
1994-89	4	MAZDA MPV VAN 2.6L
1994-90	4	MAZDA MPV VAN 2.6L
1995-92	4	MAZDA MPV VAN 2.4L
1995-92	4	MAZDA MPV VAN 2.4L
1992-89	4	MAZDA MPV VAN 2.4L
1992-89	4	MAZDA MPV VAN 2.4L
1995-90	4	MAZDA MPV VAN 2.4L
1994-90	4	MAZDA MPV VAN 2.4L
1990-87	4	MAZDA MPV VAN 2.4L
1980	4	MAZDA MPV VAN 2.4L
1979	6	MAZDA MPV VAN 2.4L
1980	6	MAZDA MPV VAN 2.4L
1982-81	4	MAZDA MPV VAN 2.4L
1981-79	4	MAZDA MPV VAN 2.4L
1980-79	6	MAZDA MPV VAN 2.4L
1994-93	4	MAZDA MPV VAN 2.4L
1979-77	4	MAZDA MPV VAN 2.4L
1991-88	4	MAZDA MPV VAN 2.4L
1994-83	4	MAZDA MPV VAN 2.4L
1991-90	4	MAZDA MPV VAN 2.4L
1990-89	4	MAZDA MPV VAN 2.4L
1991-87	4	MAZDA MPV VAN 2.4L
1991-89	4	MAZDA MPV VAN 2.4L
1994-92	4	MAZDA MPV VAN 2.4L
1994-90	4	MAZDA MPV VAN 2.4L
1994-84	4	MAZDA MPV VAN 2.4L
1986-83	4	MAZDA MPV VAN 2.4L
1980-79	4	MAZDA MPV VAN 2.4L
1985-84	4	MAZDA MPV VAN 2.4L
1986	4	MAZDA MPV VAN 2.4L
1986-76	4	MAZDA MPV VAN 2.4L
1995-87	4	MAZDA MPV VAN 2.4L
1995-93	4	MAZDA MPV VAN 2.4L
1980-79	4	MAZDA MPV VAN 2.4L
1982-81	4	MAZDA MPV VAN 2.4L
1982-78	6	MAZDA MPV VAN 2.4L
1988-83	6	MAZDA MPV VAN 2.4L
1989-85	4	MAZDA MPV VAN 2.4L
1995-92	4	MAZDA MPV VAN 2.4L
1983-75	4	MAZDA MPV VAN 2.4L
1984-81	4	MAZDA MPV VAN 2.4L
1986-81	6	MAZDA MPV VAN 2.4L
1986-80	4	MAZDA MPV VAN 2.4L
1994-88	4	MAZDA MPV VAN 2.4L
1987-84	4	MAZDA MPV VAN 2.4L

DIRECT FIT



642408

Inlet A: WELDED 3-BOLT FLANGE
Outlet A: LOOSE 3-BOLT FLANGE W/ FLAT FLARE
Length: 43"



- 1995-93 4 SATURN SC2 1.9L
- 1995-93 4 SATURN SL2 1.9L
- 1995-93 4 SATURN SW2 1.9L

642409

Inlet A: LOOSE 2-BOLT FLANGE W/ 2.25" FLAT FLARE
Outlet A: LOOSE 2-BOLT FLANGE W/ 2.25" FLAT FLARE
Length: 17.50"



- 1995-93 4 FORD PROBE 2.0L
- 1994-91 4 INFINITI G20 2.0L
- 2006-03 6 KIA SORENTO 3.5L
- 1989-88 4 MAZDA 323 1.6L
- 1995-93 4 MAZDA 626 2.0L
- 1991-88 6 MAZDA 929 3.0L
- 1995-93 4 MAZDA MX6 2.0L
- 1999-91 6 MITSUBISHI 3000GT 3.0L
- 1993-92 6 MITSUBISHI DIAMANTE 3.0L
- 1983-77 4 NISSAN 200SX All
- 1986-84 4 NISSAN 200SX 1.8L
- 1995-84 4 NISSAN 200SX 2.0L
- 1995 4 NISSAN 200SX 1.6L
- 1994-93 4 NISSAN 240SX 2.4L
- 1979-75 6 NISSAN 280Z, 280ZX All
- 1983-81 6 NISSAN 280Z, 280ZX 2.8L
- 1980-79 4 NISSAN 310 1.4L
- 1981-79 4 NISSAN 510, F-10 All
- 1984-78 6 NISSAN 810 2.4L
- 1990 4 NISSAN AXXESS VAN 2.4L
- 1979-77 4 NISSAN B210, 210 All
- 1982-80 4 NISSAN B210, 210 1.2L
- 1982-80 4 NISSAN B210, 210 1.4L
- 1982-80 4 NISSAN B210, 210 1.5L
- 1994-86 6 NISSAN MAXIMA 3.0L
- 1987-86 4 NISSAN MULTI 2.0L
- 1993-91 4 NISSAN NX All
- 1983-80 4 NISSAN PICKUP 2.0L
- 1983-81 4 NISSAN PICKUP 2.2L
- 1989-86 4 NISSAN PICKUP 2.4L
- 1995-86 6 NISSAN PICKUP 3.0L
- 1990-83 4 NISSAN PULSAR All
- 1986-82 4 NISSAN SENTRA All

642409 (cont.)

- 1990-87 4 NISSAN SENTRA 1.6L
- 1984-82 4 NISSAN STANZA 2.0L
- 1989-85 4 NISSAN STANZA All
- 1992 4 NISSAN STANZA 2.4L
- 1995-88 6 TOYOTA 4 RUNNER 3.0L
- 1991-88 6 TOYOTA CAMRY, (Inc. 1998 & Older SOLARA) 2.5L
- 1992-84 4 TOYOTA PICKUP (ALL MODELS Exc. TACOMA & TUNDRA) 2.4L
- 1995-88 6 TOYOTA PICKUP (ALL MODELS Exc. TACOMA & TUNDRA) 3.0L
- 1993-87 6 TOYOTA SUPRA 3.0L

642412

Inlet A: WELDED 3-BOLT FLANGE
Outlet A: WELDED 3-BOLT FLANGE W/ GASKET STUB
Length: 17.88"



- 1994-93 4 CHEVROLET BERETTA 2.3L
- 1995-93 4 CHEVROLET BERETTA 2.2L
- 1995-90 4 CHEVROLET CAVALIER 2.2L
- 1995-93 4 CHEVROLET CORSICA 2.2L
- 1994-90 4 PONTIAC SUNBIRD 2.0L

642415

Inlet A: 1.88" I.D. PIPE
Inlet B: 1.88" I.D. PIPE
Outlet A: 2.50" I.D. PIPE
Length: 36.50"



- 1997-93 6 CHRYSLER CONCORDE 3.5L
- 1995-93 6 CHRYSLER INTREPID 3.5L
- 1997-94 6 CHRYSLER LHS 3.5L
- 1996-94 6 CHRYSLER NEW YORKER 3.5L
- 1997-93 6 DODGE INTREPID 3.5L
- 1996-93 6 EAGLE VISION 3.5L

642416

Inlet A: LOOSE 2-BOLT FLANGE W/ 2.25" FEMALE FLARE
Outlet A: WELDED 4-BOLT FLANGE
Length: 45.50"



1993-89 6 BUICK CENTURY 3.3L
1993-89 6 OLDSMOBILE CIERA 3.3L

642417

Inlet A: LOOSE 2-BOLT FLANGE W/ 2.50" CHRYSLER FLARE
Outlet A: 2.25" O.D. PIPE
Length: 40"



1991-90 6 CHRYSLER TOWN & COUNTRY 3.3L
1991-90 6 DODGE CARAVAN 3.3L
1991-90 6 PLYMOUTH VOYAGER 3.3L

642418

Inlet A: WELDED 3-BOLT FLANGE
Outlet A: LOOSE 2-BOLT FLANGE W/ 2" MALE BALL
Length: 36.50"



1993-89 4 ASUNA SUNRUNNER All
1994-89 4 GEO TRACKER 1.6L
1992-89 4 SUZUKI SIDEKICK 1.6L

642420

Inlet A: LOOSE 4-BOLT FLANGE W/ FLAT FLARE
Outlet A: 2" O.D. PIPE
Length: 25"



1985-84 4 JEEP CHEROKEE 2.5L
1986-84 6 JEEP CHEROKEE 2.8L
1986 6 JEEP COMANCHE 2.8L

642420 (cont.)

1985-84 4 JEEP WAGONEER 2.5L
1986-84 6 JEEP WAGONEER 2.8L
1990-87 6 JEEP WRANGLER 4.2L

642421

Inlet A: LOOSE 3-BOLT FLANGE W/ FLAT FLARE
Outlet A: LOOSE 3-BOLT FLANGE W/ FLAT FLARE
Length: 13"



1993-90 4 HONDA ACCORD 2.2L
1987-85 4 HONDA PRELUDE 2.0L

642422

Inlet A: LOOSE 3-BOLT FLANGE W/ FLAT FLARE
Outlet A: LOOSE 3-BOLT FLANGE W/ FLAT FLARE
Length: 14"



1993-91 4 HONDA ACCORD 2.2L

642426

Inlet A: LOOSE 2-BOLT FLANGE W/ 2" FEMALE FLARE
Outlet A: 2.25" O.D. PIPE
Length: 38"



1987-86 6 BUICK ELECTRA - (Inc. Park Avenue) 3.8L
1987-86 6 BUICK LESABRE All
1987-86 6 OLDSMOBILE 98 3.8L
1986 6 OLDSMOBILE EIGHTY-EIGHT, DELTA 88 3.0L
1987-86 6 OLDSMOBILE EIGHTY-EIGHT, DELTA 88 3.8L
1987 6 PONTIAC BONNEVILLE 3.8L

642429

Inlet A: WELDED 2-BOLT FLANGE
Outlet A: WELDED 3-BOLT FLANGE
Length: 17.50"

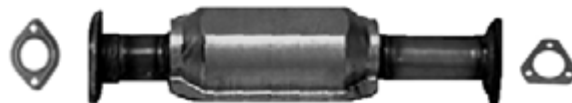

1993-92 4 ACURA INTEGRA 1.7L

DIRECT FIT



642429 (cont.)

1995-92 4 ACURA INTEGRA 1.8L

642430

Inlet A: WELDED 2-BOLT FLANGE
 Outlet A: WELDED 3-BOLT FLANGE
 Length: 16.63"



1991-90 4 ACURA INTEGRA 1.8L

642432

Inlet A: WELDED 2-BOLT FLANGE W/ FEMALE FLARE
 Outlet A: 2.50" O.D. PIPE
 Length: 23.50"



- 1992-89 8 CADILLAC ALLANTE 4.5L
- 1993 8 CADILLAC ALLANTE 4.6L
- 1995-94 8 CADILLAC DEVILLE 4.6L
- 1990 8 CADILLAC ELDORADO 4.5L
- 1992-91 8 CADILLAC ELDORADO 4.9L
- 1995-93 8 CADILLAC ELDORADO 4.6L
- 1990 8 CADILLAC SEVILLE 4.5L
- 1992-91 8 CADILLAC SEVILLE 4.9L
- 1995-93 8 CADILLAC SEVILLE 4.6L

642433

Inlet A: 2.50" I.D. PIPE
 Outlet A: LOOSE 4-BOLT GM FLANGE W/ 2.50" MALE BALL
 Length: 20.50"



- 1995-93 6 CHEVROLET CAMARO 3.4L
- 1995-93 6 PONTIAC FIREBIRD, TRANS AM, FORMULA 3.4L

642436

Inlet A: LOOSE 2-BOLT FLANGE W/ FEMALE FLARE
 Outlet A: LOOSE 2-BOLT FLANGE W/ FLAT FLARE
 Length: 30.50"



- 1994-92 8 FORD CROWN VICTORIA (Inc. Police, Taxi, Station Wagon) 4.6L
- 1994-91 8 LINCOLN TOWN CAR 4.6L
- 1994-92 8 MERCURY GRAND MARQUIS FULL SIZE 4.6L

642437

Inlet A: LOOSE 2-BOLT FLANGE W/ FEMALE FLARE
 Outlet A: LOOSE 2-BOLT FLANGE W/ FLAT FLARE
 Length: 31"



- 1994-92 8 FORD CROWN VICTORIA (Inc. Police, Taxi, Station Wagon) 4.6L
- 1994-91 8 LINCOLN TOWN CAR 4.6L
- 1994-92 8 MERCURY GRAND MARQUIS FULL SIZE 4.6L

642441

Inlet A: LOOSE 2-BOLT FLANGE W/ FEMALE FLARE
 Outlet A: 2" O.D. PIPE
 Length: 25.75"



- 1994-92 6 FORD TEMPO 3.0L
- 1994-92 6 MERCURY TOPAZ 3.0L

642443

Inlet A: WELDED 2-BOLT FLANGE
Outlet A: WELDED 2-BOLT FLANGE
Length: 14.63"



1993-90 4 MAZDA MIATA, MX5 1.6L

642444

Inlet A: WELDED 2-BOLT FLANGE
Outlet A: WELDED 2-BOLT FLANGE
Length: 25.50"



1994-90 4 MAZDA PROTÉGÉ 1.8L

642448

Inlet A: LOOSE 2-BOLT FLANGE W/ 3" FLAT FLARE
Outlet A: LOOSE 2-BOLT FLANGE W/ 3" FLAT FLARE
Length: 17.25"



1995-93 6 FORD PROBE 2.5L
1995-93 6 MAZDA 626 2.5L
1995-93 6 MAZDA MX6 2.5L

642449

Inlet A: WELDED 3-BOLT FLANGE W/ DUAL GASKET STUB
Outlet A: WELDED 2-BOLT FLANGE
Length: 35.75"

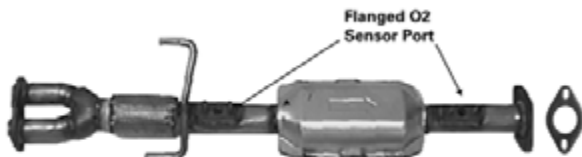

1995-91 4 TOYOTA PREVIA VAN 2.4L

642450

Inlet A: LOOSE 2-BOLT FLANGE W/ FEMALE FLARE
Inlet B: LOOSE 2-BOLT FLANGE W/ FEMALE FLARE
Outlet A: WELDED 2-BOLT FLANGE W/ GASKET STUB
Length: 44.50"



1996-95 6 FORD WINDSTAR 3.8L

642451

Inlet A: 2.25" I.D. PIPE
Outlet A: 2.25" O.D. PIPE
Length: 23.88"



1995-93 4 JEEP CHEROKEE 2.5L
1995-93 6 JEEP CHEROKEE 4.0L
1995-93 6 JEEP GRAND CHEROKEE/GRAND WAGONEER 4.0L

642453

Inlet A: WELDED 2-BOLT FLANGE
Outlet A: WELDED 3-BOLT FLANGE
Length: 16.50"



1995-94 4 HONDA ACCORD 2.2L

DIRECT FIT



642454

Inlet A: WELDED 3-BOLT FLANGE
 Outlet A: WELDED 2-BOLT FLANGE
 Length: 21"

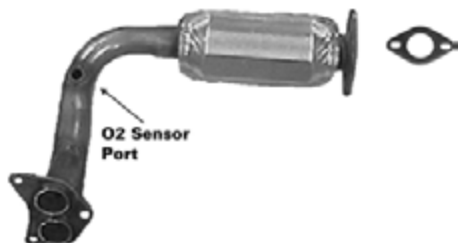

- 1998-94 6 MERCURY VILLAGER 3.0L
- 1998-94 6 NISSAN QUEST 3.0L

642455

Inlet A: WELDED 2-BOLT FLANGE
 Outlet A: WELDED 2-BOLT FLANGE
 Length: 16"



- 1998-93 6 MERCURY VILLAGER 3.0L
- 2002-99 6 MERCURY VILLAGER 3.3L
- 1994-90 6 NISSAN PATHFINDER 3.0L
- 1997-95 4 NISSAN PICKUP 2.4L
- 1998-93 6 NISSAN QUEST 3.0L
- 2002-99 6 NISSAN QUEST 3.3L

642456

Inlet A: LOOSE 2-BOLT FLANGE W/ FEMALE FLARE
 Outlet A: WELDED 3-BOLT FLANGE
 Length: 43.50"



- 1993-90 6 BUICK SKYLARK 3.3L
- 1993-92 6 OLDSMOBILE ACHIEVA 3.3L
- 1991-90 6 OLDSMOBILE CALAIS 3.3L
- 1993-92 6 PONTIAC GRAND AM 3.3L

642458

Inlet A: LOOSE 2-BOLT FLANGE W/ FEMALE FLARE
 Inlet B: LOOSE 2-BOLT FLANGE W/ FEMALE FLARE
 Outlet A: LOOSE 2-BOLT FLANGE W/ 2.50" MALE BALL
 Length: 50"

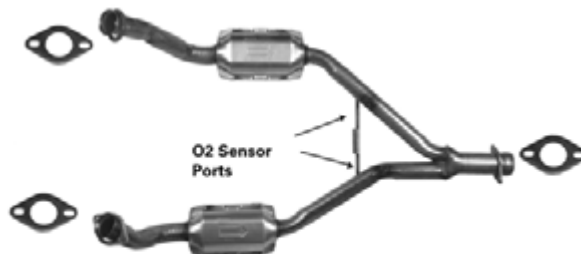

- 1995-94 6 FORD MUSTANG 3.8L

642459

Inlet A: WELDED 3-BOLT FLANGE
 Outlet A: WELDED 3-BOLT FLANGE W/ GASKET STUB
 Length: 20.25"



- 1991-90 4 BUICK SKYLARK 2.5L
- 1991-90 4 OLDSMOBILE CALAIS 2.5L
- 1991-90 4 PONTIAC GRAND AM 2.5L

642460

Inlet A: 1.88" I.D. PIPE
 Inlet B: 1.88" I.D. PIPE
 Outlet A: 2" I.D. PIPE
 Length: 23.75"



- 1996-93 6 CHRYSLER CONCORDE 3.3L
- 1995-93 6 CHRYSLER INTREPID 3.3L
- 1997-93 6 DODGE INTREPID 3.3L
- 1997-93 6 EAGLE VISION 3.3L

642462

Inlet A: LOOSE 2-BOLT FLANGE W/ 2.25" FEMALE FLARE
Outlet A: LOOSE 2-BOLT FLANGE W/ 2" FLAT FLARE
Length: 33.50"



- 1995 8 FORD CROWN VICTORIA (Inc. Police, Taxi, Station Wagon) 4.6L
- 1995 8 LINCOLN TOWN CAR 4.6L
- 1995 8 MERCURY GRAND MARQUIS FULL SIZE 4.6L

642463

Inlet A: LOOSE 2-BOLT FLANGE W/ 2.25" FEMALE FLARE
Outlet A: LOOSE 2-BOLT FLANGE W/ 2" FLAT FLARE
Length: 32.50"



- 1995 8 FORD CROWN VICTORIA (Inc. Police, Taxi, Station Wagon) 4.6L
- 1995 8 LINCOLN TOWN CAR 4.6L
- 1995 8 MERCURY GRAND MARQUIS FULL SIZE 4.6L

642466

Inlet A: WELDED 2-BOLT FLANGE
Outlet A: WELDED 2-BOLT FLANGE
Length: 16.50"



- 1999-95 4 DODGE AVENGER 2.0L

642467

Inlet A: LOOSE 3-BOLT FLANGE W/ 45 DEGREE FLARE
Outlet A: 2.320" O.D. PIPE
Length: 28.75"



- 1992-85 4 VOLVO 740 2.3L

642467 (cont.)

- 1990-84 4 VOLVO 760 2.3L
- 1990-87 6 VOLVO 760 2.8L
- 1995-91 4 VOLVO 940 2.3L

642468

Inlet A: LOOSE 2-BOLT FLANGE W/ FEMALE FLARE
Outlet A: WELDED 2-BOLT FLANGE
Length: 22.25"



- 1995-91 4 FORD ESCORT 1.9L
- 1995-91 4 MERCURY TRACER 1.9L

642470

Inlet A: LOOSE 2-BOLT FLANGE W/ FEMALE FLARE
Outlet A: WELDED 2-BOLT FLANGE
Length: 61"



- 1989-86 4 SUBARU COUPE - 3 Dr. 1.8L
- 1994-90 4 SUBARU LOYALE 1.8L
- 1989-85 4 SUBARU SEDAN - 4 Dr. 1.8L
- 1989-85 4 SUBARU STATION WAGON 1.8L
- 1990-85 4 SUBARU XT 1.8L

642471

Inlet A: 2" I.D. PIPE
Outlet A: LOOSE GM FLANGE W/ 2.25" MALE BALL
Length: 17.25"



- 1995-94 4 CHEVROLET LLV 2.2L
- 1995-94 4 CHEVROLET S-Series (2WD), T-Series (4WD) PICKUP 2.2L
- 1995-94 4 GMC S-Series (2WD), T-Series (4WD) PICKUP (SONOMA) 2.2L

DIRECT FIT



642472

Inlet A: LOOSE 2-BOLT FLANGE W/ FEMALE FLARE
 Outlet A: LOOSE 2-BOLT FLANGE W/ GASKET STUB
 Length: 39.25"



- 1994-86 4 FORD RANGER 2.3L
- 1994 4 MAZDA B-Series PICKUP 2.3L

642473

Inlet A: 2.50" I.D. PIPE
 Outlet A: WELDED 3-BOLT FLANGE
 Length: 26.38"

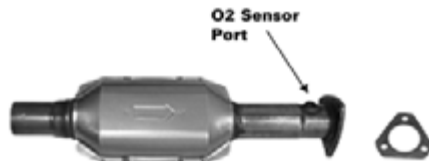

- 1995 6 CHEVROLET S-Series (2WD), T-Series (4WD) PICKUP 4.3L
- 1995 6 GMC S-Series (2WD), T-Series (4WD) PICKUP (SONOMA) 4.3L

642474

Inlet A: LOOSE 2-BOLT FLANGE W/ SPECIAL FLARE
 Outlet A: WELDED 4-BOLT FLANGE
 Length: 46"



- 1995-94 6 BUICK REGAL 3.1L
- 1995-94 6 CHEVROLET LUMINA 3.1L
- 1995 6 CHEVROLET MONTE CARLO 3.1L
- 1995-94 6 OLDSMOBILE CUTLASS 3.1L
- 1995-94 6 PONTIAC GRAND PRIX 3.1L

642475

Inlet A: LOOSE 2-BOLT FLANGE W/ 2.25" FEMALE FLARE
 Outlet A: 2.50" O.D. PIPE
 Length: 38"



- 1994-92 6 BUICK LESABRE 3.8L
- 1994-91 6 BUICK PARK AVENUE 3.8L
- 1994-91 6 OLDSMOBILE 98 3.8L
- 1994-92 6 OLDSMOBILE EIGHTY-EIGHT, DELTA 88 3.8L
- 1994-92 6 PONTIAC BONNEVILLE 3.8L

642476

Inlet A: WELDED 3-BOLT FLANGE
 Outlet A: WELDED 3-BOLT FLANGE
 Length: 20.25"



- 1998-96 4 CHEVROLET CAVALIER 2.2L
- 1998-96 4 PONTIAC SUNFIRE 2.2L

642477

Inlet A: LOOSE 2-BOLT FLANGE W/ FEMALE FLARE
 Outlet A: LOOSE 2-BOLT FLANGE W/ FLAT FLARE
 Length: 13.25"



- 1997-94 4 FORD ASPIRE 1.3L
- 1991 4 MERCURY CAPRI 1.6L

642478

Inlet A: LOOSE 2-BOLT CHRYSLER FLANGE
Outlet A: 2.25" O.D. PIPE
Length: 33.50"



- 1999-95 4 DODGE NEON 2.0L
- 1999-95 4 PLYMOUTH NEON 2.0L

642479

Inlet A: LOOSE 2-BOLT CHRYSLER FLANGE
Outlet A: 2.25" O.D. PIPE
Length: 42.75"



- 1993-92 6 DODGE CARAVAN 3.3L
- 1993-92 6 PLYMOUTH VOYAGER 3.3L

642480

Inlet A: LOOSE 2-BOLT FLANGE W/ FEMALE FLARE
Inlet B: LOOSE 2-BOLT FLANGE W/ FEMALE FLARE
Outlet A: WELDED 2-BOLT FLANGE
Length: 40"

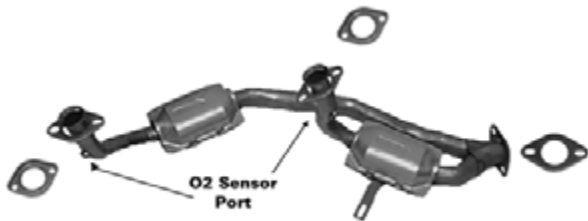

- 1995-94 6 FORD TAURUS 3.0L
- 1995-93 6 MERCURY SABLE 3.0L

642483

Inlet A: 2.25" I.D. PIPE
Outlet A: 2.25" O.D. PIPE
Length: 22"



- 1995-93 4 JEEP WRANGLER 2.5L

642485

Inlet A: LOOSE 2-BOLT FLANGE W/ 2" FLAT FLARE
Outlet A: LOOSE 2-BOLT FLANGE W/ 2.25" FLAT FLARE
Length: 17"



- 1992-89 4 FORD PROBE 2.2L
- 1997-96 4 FORD PROBE 2.0L
- 1992-88 4 MAZDA 626 2.2L
- 1997-96 4 MAZDA 626 2.0L
- 1992-88 4 MAZDA MX6 2.2L
- 1997-96 4 MAZDA MX6 2.0L

642487

Inlet A: WELDED 2-BOLT FLANGE
Outlet A: WELDED 3-BOLT FLANGE
Length: 16.63"



- 1995-93 4 HONDA CIVIC DEL SOL 1.5L
- 1995-93 4 HONDA CIVIC DEL SOL 1.6L
- 1995-92 4 HONDA CIVIC 1.5L
- 1995-93 4 HONDA CIVIC 1.6L

642490

Inlet A: LOOSE 2-BOLT FLANGE W/ SPECIAL FLARE
Outlet A: WELDED 3-BOLT FLANGE
Length: 38.25"



- 1995-93 4 BUICK SKYLARK 2.3L
- 1995-93 4 OLDSMOBILE ACHIEVA 2.3L
- 1995-93 4 PONTIAC GRAND AM 2.3L

DIRECT FIT



642492

Inlet A: WELDED 3-BOLT FLANGE W/ STUDS
 Outlet A: WELDED 2-BOLT FLANGE
 Length: 21.25"



- 1996-95 6 FORD CONTOUR 2.5L
- 1996-95 6 MERCURY MYSTIQUE 2.5L

642505

Inlet A: LOOSE 2-BOLT FLANGE W/ CHRYSLER FLARE
 Outlet A: 2.25" O.D. PIPE
 Length: 41.88"



- 1991-89 6 DODGE CARAVAN 3.0L
- 1991-89 6 PLYMOUTH VOYAGER 3.0L

642506

Inlet A: LOOSE 2-BOLT FLANGE W/ CHRYSLER FLARE
 Outlet A: 1-7/8" O.D. PIPE
 Length: 40.50"



- 1988-86 4 CHRYSLER LEBARON 2.5L
- 1987-86 4 CHRYSLER NEW YORKER 2.5L
- 1988-87 4 DODGE ARIES, 400, 600 2.2L
- 1989-86 4 DODGE ARIES, 400, 600 2.5L
- 1988-86 4 DODGE LANCER 2.5L
- 1988-86 4 PLYMOUTH CARAVELLE 2.5L
- 1988 4 PLYMOUTH CARAVELLE 2.2L
- 1988-87 4 PLYMOUTH RELIANT 2.2L
- 1989-86 4 PLYMOUTH RELIANT 2.5L

642507

Inlet A: LOOSE 4-BOLT FLANGE W/ 45 DEGREE FLARE
 Outlet A: LOOSE 4-BOLT FLANGE W/ 2.25" FLAT FLARE
 Length: 17.50"



- 1993-85 4 SAAB 900 2.0L
- 1993-91 4 SAAB 900 2.1L

642509

Inlet A: WELDED 2-BOLT FLANGE W/ FEMALE FLARE
 Outlet A: WELDED 4-BOLT FLANGE
 Length: 40.75"



- 1995-91 6 CHEVROLET LUMINA 3.4L
- 1995 6 CHEVROLET MONTE CARLO 3.4L
- 1995-91 6 OLDSMOBILE CUTLASS 3.4L
- 1995-91 6 PONTIAC GRAND PRIX 3.4L

642514

Inlet A: WELDED 3-BOLT FLANGE
 Outlet A: WELDED 3-BOLT FLANGE
 Length: 27.75"

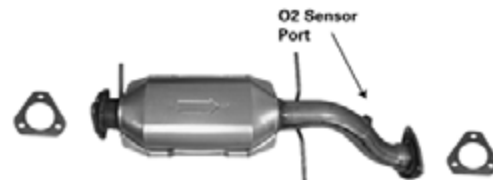

- 1999-96 6 CHEVROLET BLAZER S-Series 4.3L
- 1999-96 6 GMC S-15 JIMMY 4.3L
- 1999-96 6 OLDSMOBILE BRAVADA 4.3L

642515

Inlet A: LOOSE 2-BOLT FLANGE W/ SPHERICAL FLARE
 Outlet A: WELDED 3-BOLT FLANGE
 Length: 39.50"



- 1995-94 6 BUICK SKYLARK 3.1L
- 1995-94 6 CHEVROLET BERETTA 3.1L
- 1995-94 6 CHEVROLET CORSICA 3.1L
- 1995-94 6 OLDSMOBILE ACHIEVA 3.1L

642515 (cont.)

1995-94 6 PONTIAC GRAND AM 3.1L

642519

Inlet A: WELDED 3-BOLT FLANGE W/ GASKET STUB
Outlet A: WELDED 2-BOLT FLANGE
Length: 45.25"



1996-94 4 TOYOTA CAMRY, (Inc. 1998 & Older SOLARA) 2.2L

642520

Inlet A: WELDED 2-BOLT FLANGE
Outlet A: WELDED 3-BOLT FLANGE
Length: 40"



1998 6 OLDSMOBILE ACHIEVA 3.1L

642521

Inlet A: LOOSE 2-BOLT FLANGE W/ CHRYSLER FLARE
Outlet A: 2" O.D. PIPE
Length: 42"



1988 4 DODGE CARAVAN All
1995-89 4 DODGE CARAVAN 2.5L
1995-88 4 PLYMOUTH VOYAGER 2.5L

642524

Inlet A: 2.25" O.D. PIPE
Outlet A: 2.13" O.D. PIPE
Length: 34.75"



1989-88 6 BUICK REGAL 2.8L
1993-89 6 BUICK REGAL 3.1L

642524 (cont.)

1992-90 4 CHEVROLET LUMINA 2.5L
1993-90 6 CHEVROLET LUMINA 3.1L
1989-88 6 OLDSMOBILE CUTLASS 2.8L
1991-90 4 OLDSMOBILE CUTLASS 2.3L
1993-89 6 OLDSMOBILE CUTLASS 3.1L
1989-88 6 PONTIAC GRAND PRIX 2.8L
1991-90 4 PONTIAC GRAND PRIX 2.3L
1993-89 6 PONTIAC GRAND PRIX 3.1L

642525

Inlet A: WELDED 2-BOLT FLANGE
Outlet A: WELDED 2-BOLT FLANGE
Length: 41.50"



2005-97 6 BUICK CENTURY 3.1L
2005-00 6 CHEVROLET IMPALA FWD 3.4L
2005-00 6 CHEVROLET MONTE CARLO 3.4L
2003-97 6 PONTIAC GRAND PRIX 3.1L

642526

Inlet A: 45 DEGREE FLARE
Outlet A: 2.25" O.D. PIPE
Length: 44"



2004-99 6 CHRYSLER 300M 3.5L
2001-98 6 CHRYSLER CONCORDE 3.2L
2004-02 6 CHRYSLER CONCORDE 3.5L
2004-98 6 CHRYSLER CONCORDE 2.7L
2001-99 6 CHRYSLER LHS 3.5L
2001-98 6 DODGE INTREPID 3.2L
2004-00 6 DODGE INTREPID 3.5L
2004-98 6 DODGE INTREPID 2.7L

642527

Inlet A: 45 DEGREE FLARE
Outlet A: 2.25" O.D. PIPE
Length: 26"



2001-98 6 CHRYSLER CONCORDE 2.7L

DIRECT FIT



642527 (cont.)

2001-98 6 DODGE INTREPID 2.7L

642528

Inlet A: WELDED 3-BOLT FLANGE W/ DUAL GASKET STUB
 Outlet A: WELDED 2-BOLT FLANGE
 Length: 41.75"

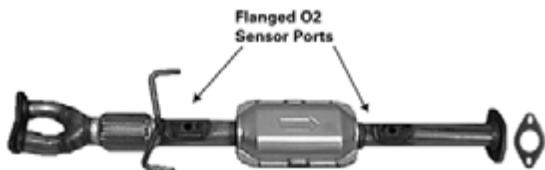

1997-94 4 TOYOTA PREVIA VAN 2.4L

642529

Inlet A: WELDED 3-BOLT FLANGE
 Outlet A: LOOSE 3-BOLT FLANGE W/ FLAT FLARE
 Length: 42"



1998-96 4 SATURN SC2 1.9L
 1998-96 4 SATURN SL2 1.9L
 1998-96 4 SATURN SW2 1.9L

642531

Inlet A: LOOSE 2-BOLT FLANGE W/ FEMALE FLARE
 Outlet A: LOOSE 2-BOLT FLANGE W/ GASKET STUB
 Length: 47.50"



1997-95 4 FORD RANGER 2.3L
 1997-95 4 MAZDA B-Series PICKUP 2.3L

642532

Inlet A: LOOSE 2-BOLT FLANGE W/ FEMALE FLARE
 Inlet B: LOOSE 2-BOLT FLANGE W/ FEMALE FLARE
 Outlet A: WELDED 2-BOLT FLANGE
 Length: 46"



1998-97 6 FORD WINDSTAR 3.0L

642533

Inlet A: WELDED 4-BOLT FLANGE
 Outlet A: 2.25" O.D. PIPE
 Length: 39"

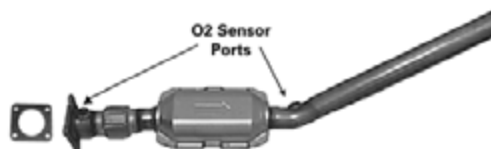

2000-95 4 CHRYSLER CIRRUS 2.4L
 2000-95 6 CHRYSLER CIRRUS 2.5L
 1998-96 4 CHRYSLER SEBRING 2.4L
 2000-96 6 CHRYSLER SEBRING 2.5L
 2000-95 4 DODGE STRATUS 2.4L
 2000-95 6 DODGE STRATUS 2.5L
 2000-98 4 PLYMOUTH BREEZE 2.4L

642535

Inlet A: LOOSE 2-BOLT FLANGE W/ FEMALE FLARE
 Outlet A: WELDED 2-BOLT FLANGE W/ GASKET STUB
 Length: 36.13"



1995-94 4 GEO TRACKER 1.6L
 1995-93 4 SUZUKI SIDEKICK 1.6L

642536

Inlet A: 2.50" I.D. PIPE
Outlet A: 2.25" O.D. PIPE
Length: 21.75"



1995-93 8 JEEP GRAND CHEROKEE/GRAND WAGONEER 5.2L

642538

Inlet A: WELDED 2-BOLT FLANGE
Outlet A: WELDED 2-BOLT FLANGE
Length: 29.50"



2000-95 6 FORD CONTOUR 2.5L
2000-99 6 MERCURY COUGAR 2.5L
2000-95 6 MERCURY MYSTIQUE 2.5L

642539

Inlet A: LOOSE 2-BOLT FLANGE W/ FEMALE FLARE
Inlet B: LOOSE 2-BOLT FLANGE W/ FEMALE FLARE
Outlet A: WELDED 2-BOLT FLANGE
Length: 44.50"

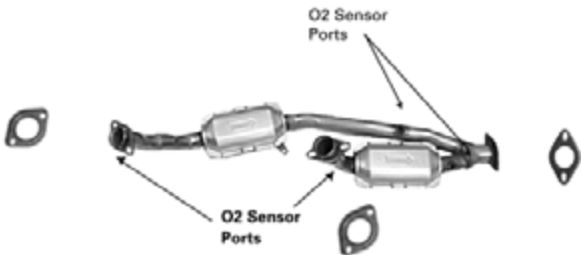

1998-97 6 FORD WINDSTAR 3.8L

642540

Inlet A: LOOSE 2-BOLT FLANGE W/ FEMALE FLARE
Inlet B: LOOSE 2-BOLT FLANGE W/ FEMALE FLARE
Outlet A: WELDED 2-BOLT FLANGE
Length: 42.50"

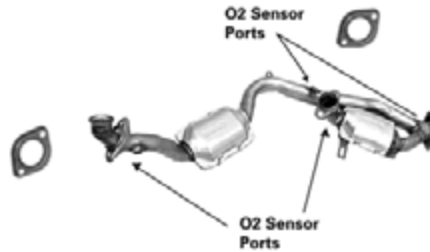

2002-95 8 LINCOLN CONTINENTAL 4.6L

642541

Inlet A: WELDED 3-BOLT FLANGE
Outlet A: WELDED 2-BOLT FLANGE W/ GASKET STUB
Length: 34.50"



1997-96 6 FORD RANGER 3.0L
1997-96 6 FORD RANGER 4.0L
1997-96 6 MAZDA B-Series PICKUP 3.0L
1997-96 6 MAZDA B-Series PICKUP 4.0L

642542

Inlet A: WELDED 3-BOLT FLANGE
Outlet A: WELDED 3-BOLT FLANGE
Length: 24"



1996 4 CHEVROLET BERETTA 2.2L
1996 4 CHEVROLET CORSICA 2.2L

DIRECT FIT



642543

Inlet A: WELDED 3-BOLT FLANGE
 Outlet A: WELDED 3-BOLT FLANGE W/ GASKET STUB
 Length: 27.50"

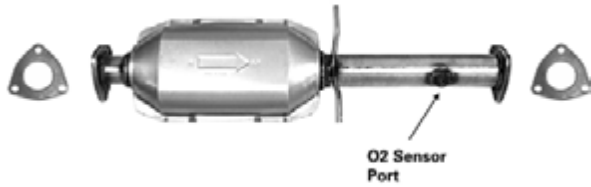

- 2003-96 4 CHEVROLET S-Series (2WD), T-Series (4WD) PICKUP 2.2L
- 2003-96 4 GMC S-Series (2WD), T-Series (4WD) PICKUP (SONOMA) 2.2L
- 2000-96 4 ISUZU PICKUP 2.2L

642544

Inlet A: WELDED 3-BOLT FLANGE
 Outlet A: WELDED 3-BOLT FLANGE
 Length: 17.25"



- 1997-95 6 HONDA ACCORD 2.7L

642545

Inlet A: WELDED 4-BOLT FLANGE
 Outlet A: WELDED 3-BOLT FLANGE W/ GASKET STUB
 Length: 38.25"



- 1998-96 4 BUICK SKYLARK 2.4L
- 1998-96 4 OLDSMOBILE ACHIEVA 2.4L
- 1998-96 4 PONTIAC GRAND AM 2.4L

642546

Inlet A: LOOSE 2-BOLT FLANGE W/ FEMALE FLARE
 Outlet A: WELDED 2-BOLT FLANGE
 Length: 39.50"



- 1996 6 BUICK SKYLARK 3.1L
- 1996 6 CHEVROLET BERETTA 3.1L
- 1996 6 CHEVROLET CORSICA 3.1L
- 1996 6 OLDSMOBILE ACHIEVA 3.1L
- 1996 6 PONTIAC GRAND AM 3.1L

642547

Inlet A: WELDED 2-BOLT FLANGE
 Outlet A: WELDED 3-BOLT FLANGE
 Length: 40.75"



- 2003-98 6 CHEVROLET MALIBU 3.1L
- 2004-99 6 OLDSMOBILE ALERO 3.4L
- 1999-98 6 OLDSMOBILE CUTLASS 3.1L
- 2005-99 6 PONTIAC GRAND AM 3.4L

642548

Inlet A: WELDED 4-BOLT FLANGE W/ GASKET STUB
 Outlet A: WELDED 2-BOLT FLANGE
 Length: 17.25"



- 2002-97 4 FORD ESCORT 2.0L
- 1999-97 4 MERCURY TRACER 2.0L

642549

Inlet A: LOOSE 2-BOLT FLANGE W/ FEMALE FLARE
Outlet A: LOOSE 2-BOLT FLANGE W/ FLAT FLARE
Length: 34"



- 2002-96 8 FORD CROWN VICTORIA (Inc. Police, Taxi, Station Wagon) 4.6L
- 2002-96 8 LINCOLN TOWN CAR 4.6L
- 2002-96 8 MERCURY GRAND MARQUIS FULL SIZE 4.6L

642550

Inlet A: LOOSE 2-BOLT FLANGE W/ FEMALE FLARE
Outlet A: LOOSE 2-BOLT FLANGE W/ FLAT FLARE
Length: 32.75"



- 2002-96 8 FORD CROWN VICTORIA (Inc. Police, Taxi, Station Wagon) 4.6L
- 2002-96 8 LINCOLN TOWN CAR 4.6L
- 2002-96 8 MERCURY GRAND MARQUIS FULL SIZE 4.6L

642552

Inlet A: WELDED 2-BOLT FLANGE
Outlet A: 2.25" O.D. PIPE
Length: 14.63"



- 2002-95 8 LINCOLN CONTINENTAL 4.6L

642553

Inlet A: WELDED 2-BOLT FLANGE W/ STUDS
Outlet A: WELDED 2-BOLT FLANGE
Length: 13"



- 1999-98 4 KIA SEPHIA 1.8L

642555

Inlet A: 2.50" O.D. PIPE
Outlet A: 2.75" O.D. PIPE
Length: 24.50"



- 1991 8 CADILLAC DEVILLE 4.9L
- 1991 8 CADILLAC FLEETWOOD 4.9L

642556

Inlet A: WELDED 2-BOLT FLANGE W/ GASKET STUB
Outlet A: WELDED 2-BOLT FLANGE W/ GASKET STUB
Length: 36"



- 1998-97 4 MAZDA PROTÉGÉ 1.5L

642561

Inlet A: WELDED 2-BOLT FLANGE
Outlet A: WELDED 2-BOLT FLANGE
Length: 12.38"



- 1994 6 NISSAN MAXIMA 3.0L
- 1994-91 4 NISSAN SENTRA 2.0L
- 1995-91 4 NISSAN SENTRA 1.6L

642565

Inlet A: WELDED 4-BOLT FLANGE
Outlet A: 2.50" I.D. PIPE
Length: 26.25"



- 1999-96 8 CADILLAC DEVILLE 4.6L
- 1999-96 8 CADILLAC ELDORADO 4.6L
- 1997-96 8 CADILLAC SEVILLE 4.6L

DIRECT FIT



642569

Inlet A: LOOSE 2-BOLT FLANGE W/ SPECIAL FLARE
 Outlet A: WELDED 4-BOLT FLANGE
 Length: 47"



- 1996-95 6 BUICK REGAL 3.1L
- 1996-95 6 CHEVROLET LUMINA 3.1L
- 1996-95 6 CHEVROLET MONTE CARLO 3.1L
- 1996-95 6 OLDSMOBILE CUTLASS 3.1L
- 1996-95 6 PONTIAC GRAND PRIX 3.1L

642570

Inlet A: WELDED 2-BOLT FLANGE
 Outlet A: WELDED 3-BOLT FLANGE W/ GASKET STUB
 Length: 40.13"



- 1998-97 6 BUICK SKYLARK 3.1L
- 1998-97 6 OLDSMOBILE ACHIEVA 3.1L
- 1998-97 6 PONTIAC GRAND AM 3.1L

642571

Inlet A: LOOSE 2-BOLT FLANGE W/ FEMALE FLARE
 Outlet A: 2.25" O.D. PIPE
 Length: 22"



- 1995-94 8 CADILLAC DEVILLE 4.9L
- 1993 8 CADILLAC ELDORADO 4.9L
- 1993 8 CADILLAC SEVILLE 4.9L

642572

Inlet A: WELDED 3-BOLT FLANGE
 Outlet A: WELDED 3-BOLT FLANGE W/ GASKET STUB
 Length: 38.50"



- 2002-99 4 CHEVROLET CAVALIER 2.4L

642572 (cont.)

- 1999 4 CHEVROLET MALIBU 2.4L
- 2001-99 4 OLDSMOBILE ALERO 2.4L
- 2001-99 4 PONTIAC GRAND AM 2.4L
- 2002-99 4 PONTIAC SUNFIRE 2.4L

642573

Inlet A: LOOSE 2-BOLT FLANGE W/ FEMALE FLARE
 Outlet A: WELDED 3-BOLT FLANGE
 Length: 32.50"



- 1995-91 6 ACURA LEGEND 3.2L

642574

Inlet A: WELDED 2-BOLT FLANGE
 Outlet A: WELDED 2-BOLT FLANGE
 Length: 12.50"



- 1999-96 6 INFINITI I30 3.0L
- 1996-95 4 NISSAN 200SX 1.6L
- 1997-95 4 NISSAN 200SX 2.0L
- 1997-93 4 NISSAN ALTIMA 2.4L
- 2000-95 6 NISSAN MAXIMA 3.0L
- 1996-95 4 NISSAN SENTRA 1.6L

642575

Inlet A: WELDED 2-BOLT FLANGE
 Outlet A: WELDED 2-BOLT FLANGE
 Length: 13"



- 2001-99 4 KIA SEPHIA 1.8L
- 2004-00 4 KIA SPECTRA 1.8L
- 2006-05 4 KIA SPECTRA 2.0L

642576

Inlet A: LOOSE 2-BOLT FLANGE W/ CHRYSLER FLARE
Outlet A: 2.25" O.D. PIPE
Length: 33"



- 1995-92 6 CHRYSLER LEBARON 3.0L
- 1993-92 6 DODGE DAYTONA 3.0L
- 1993-92 6 DODGE DYNASTY 3.0L
- 1994-92 6 DODGE SHADOW 3.0L
- 1995-92 6 DODGE SPIRIT 3.0L
- 1995-92 6 PLYMOUTH ACCLAIM 3.0L
- 1994-93 6 PLYMOUTH SUNDANCE, DUSTER 3.0L

642577

Inlet A: WELDED 2-BOLT FLANGE
Outlet A: WELDED 2-BOLT FLANGE
Length: 12.63"



- 1997-96 4 GEO PRIZM 1.6L
- 1997-96 4 GEO PRIZM 1.8L
- 1997-96 4 TOYOTA CELICA 1.8L
- 1997-96 4 TOYOTA COROLLA 1.6L
- 1997-96 4 TOYOTA COROLLA 1.8L

642578

Inlet A: LOOSE 2-BOLT FLANGE W/ FLAT FLARE
Outlet A: LOOSE 3-BOLT FLANGE W/ FLAT FLARE
Length: 14.63"

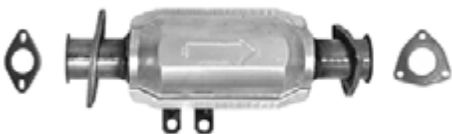

- 1997-95 4 HYUNDAI ACCENT 1.5L
- 1998-96 4 HYUNDAI ELANTRA 1.8L
- 2000-99 4 HYUNDAI ELANTRA 2.0L
- 1997 4 HYUNDAI TIBURON 1.8L
- 2001-98 4 HYUNDAI TIBURON 2.0L

642578 (cont.)

1995 4 KIA SPORTAGE All

642579

Inlet A: WELDED 2-BOLT FLANGE
Outlet A: WELDED 2-BOLT FLANGE
Length: 15.25"



1995-93 4 SUBARU IMPREZA 1.8L

642580

Inlet A: WELDED 2-BOLT FLANGE
Outlet A: WELDED 2-BOLT FLANGE W/ GASKET STUB
Length: 22"



1997-93 4 SUBARU IMPREZA 1.8L

642581

Inlet A: LOOSE 2-BOLT FLANGE W/ 2.25" FEMALE FLARE
Inlet B: LOOSE 2-BOLT FLANGE W/ 2.25" FEMALE FLARE
Outlet A: LOOSE 2-BOLT FLANGE W/ 2" FEMALE FLARE
Length: 41"

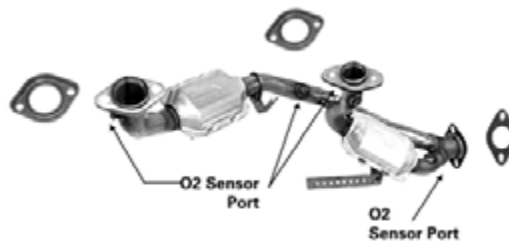

- 1999-96 6 FORD TAURUS 3.0L
- 1999-96 6 MERCURY SABLE 3.0L

642582

Inlet A: WELDED 2-BOLT FLANGE
Outlet A: WELDED 3-BOLT FLANGE
Length: 16.63"

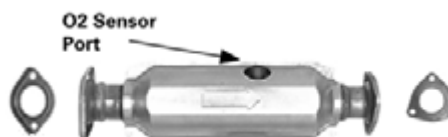

2000-99 4 HONDA CIVIC 1.6L

DIRECT FIT



642583

Inlet A: WELDED 2-BOLT FLANGE
 Outlet A: WELDED 2-BOLT FLANGE
 Length: 37.38"



- 2004-97 6 BUICK REGAL 3.8L
- 2005-00 6 CHEVROLET IMPALA FWD 3.8L
- 2005-00 6 CHEVROLET MONTE CARLO 3.8L
- 1999-98 6 OLDSMOBILE INTRIGUE 3.8L
- 2003-97 6 PONTIAC GRAND PRIX 3.8L

642585

Inlet A: WELDED 4-BOLT FLANGE
 Outlet A: 2.165" O.D. PIPE
 Length: 34.50"



- 1993-90 4 VOLKSWAGEN CABRIOLET 1.8L

642586

Inlet A: WELDED 3-BOLT FLANGE
 Outlet A: WELDED 3-BOLT FLANGE
 Length: 35.50"



- 1994-92 6 AUDI 100 2.8L

642589

Inlet A: LOOSE 2-BOLT FLANGE W/ FEMALE FLARE
 Outlet A: 2.25" O.D. PIPE
 Length: 45.50"



- 2001-97 6 FORD EXPLORER 4.0L
- 2001-98 6 MERCURY MOUNTAINEER 4.0L

642590

Inlet A: LOOSE 2-BOLT FLANGE W/ FEMALE FLARE
 Outlet A: WELDED 2-BOLT FLANGE
 Length: 27.50"



- 2001-97 6 FORD EXPLORER 4.0L
- 2001-98 6 MERCURY MOUNTAINEER 4.0L

642591

Inlet A: LOOSE 2-BOLT FLANGE W/ CHRYSLER FLARE
 Outlet A: 2.25" O.D. PIPE
 Length: 41.25"



- 1993-92 6 CHRYSLER TOWN & COUNTRY 3.3L
- 1995-94 6 CHRYSLER TOWN & COUNTRY 3.8L
- 1995-92 6 DODGE CARAVAN 3.0L
- 1995-94 6 DODGE CARAVAN 3.3L
- 1995-94 6 DODGE CARAVAN 3.8L
- 1995-92 6 PLYMOUTH VOYAGER 3.0L
- 1995-94 6 PLYMOUTH VOYAGER 3.3L
- 1995-94 6 PLYMOUTH VOYAGER 3.8L

642594

Inlet A: WELDED 4-BOLT FLANGE
 Outlet A: 2.25" O.D. PIPE
 Length: 33.13"



- 2004-00 4 DODGE NEON All
- 2001-00 4 PLYMOUTH NEON 2.0L

642595

Inlet A: LOOSE 2-BOLT FLANGE W/ FEMALE FLARE
Outlet A: WELDED 2-BOLT FLANGE
Length: 36.13"



- 2002-98 4 CHEVROLET TRACKER 1.6L
- 2003-99 4 CHEVROLET TRACKER 2.0L
- 1997-96 4 GEO TRACKER All
- 1998-96 4 SUZUKI SIDEKICK 1.6L
- 1998-96 4 SUZUKI SIDEKICK 1.8L
- 2002-99 4 SUZUKI VITARA, GRAND VITARA 1.6L
- 2003-99 4 SUZUKI VITARA, GRAND VITARA 2.0L
- 1998-96 4 SUZUKI X90 1.6L

642596

Inlet A: WELDED 3-BOLT FLANGE
Outlet A: WELDED 2-BOLT FLANGE
Length: 24.50"



- 2002-01 4 KIA SPORTAGE 2.0L

642597

Inlet A: WELDED 9-BOLT FLANGE
Outlet A: WELDED 3-BOLT FLANGE
Length: 13.75"



- 1997-96 4 HONDA CIVIC DEL SOL 1.6L
- 2000-96 4 HONDA CIVIC 1.6L

642605

Inlet A: WELDED 2-BOLT FLANGE
Outlet A: WELDED 3-BOLT FLANGE
Length: 17.50"



- 1995-93 4 HONDA CIVIC DEL SOL 1.5L
- 1995-93 4 HONDA CIVIC DEL SOL 1.6L
- 1989-88 4 HONDA CIVIC All
- 1995-88 4 HONDA CIVIC 1.5L
- 1995-89 4 HONDA CIVIC 1.6L
- 1991-88 4 HONDA CRX 1.5L
- 1991-88 4 HONDA CRX 1.6L
- 1995 4 HONDA ODYSSEY 2.2L

642606

Inlet A: WELDED 3-BOLT FLANGE
Outlet A: WELDED 3-BOLT FLANGE
Length: 14"



- 1993-90 4 HONDA ACCORD 2.2L
- 1987-85 4 HONDA PRELUDE 2.0L
- 1995-92 4 HONDA PRELUDE 2.2L
- 1995-92 4 HONDA PRELUDE 2.3L

642609

Inlet A: WELDED 3-BOLT FLANGE
Outlet A: WELDED 2-BOLT FLANGE
Length: 27.50"

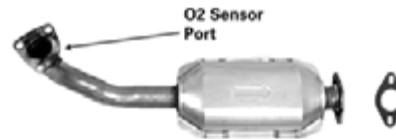

- 2000-98 4 KIA SPORTAGE 2.0L

642610

Inlet A: WELDED 4-BOLT FLANGE W/ STUDS
Outlet A: WELDED 2-BOLT FLANGE
Length: 41.25"



- 1997-95 4 FORD CONTOUR 2.0L

DIRECT FIT



642610 (cont.)

1997-95 4 MERCURY MYSTIQUE 2.0L

642611

Inlet A: LOOSE 2-BOLT FLANGE W/ FEMALE FLARE
 Outlet A: WELDED 2-BOLT FLANGE
 Length: 28.25"

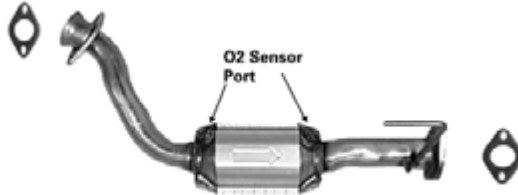

1998-96 8 FORD EXPLORER 5.0L
 1998-97 8 MERCURY MOUNTAINEER 5.0L

642612

Inlet A: LOOSE 2-BOLT FLANGE W/ FEMALE FLARE
 Outlet A: WELDED 2-BOLT FLANGE
 Length: 35.63"



1998-96 8 FORD EXPLORER 5.0L
 1998-97 8 MERCURY MOUNTAINEER 5.0L

642614

Inlet A: LOOSE 2-BOLT FLANGE W/ SPHERICAL FLARE
 Outlet A: WELDED 4-BOLT FLANGE
 Length: 43.25"



1996 6 BUICK REGAL 3.8L
 1996 6 CHEVROLET LUMINA 3.4L
 1996 6 CHEVROLET MONTE CARLO 3.4L
 1996 6 OLDSMOBILE CUTLASS 3.4L
 1996 6 PONTIAC GRAND PRIX 3.4L

642616

Inlet A: LOOSE 2-BOLT FLANGE W/ FEMALE FLARE
 Outlet A: 1.75" MALE BALL
 Length: 44.38"



1995-93 5 VOLVO 850 2.4L

642640

Inlet A: LOOSE 2-BOLT FLANGE W/ FEMALE FLARE
 Outlet A: 2.50" O.D. PIPE
 Length: 37.50"



1990-88 8 CADILLAC COMMERCIAL CHASSIS - FUNERAL COACH, LIMOUSINE 4.5L
 1987-86 8 CADILLAC FLEETWOOD 4.1L
 1990-88 8 CADILLAC FLEETWOOD 4.5L

642657

Inlet A: LOOSE 2-BOLT FLANGE W/ 2.25" FEMALE FLARE
 Outlet A: 2.38" O.D. PIPE
 Length: 36.75"



1990-88 6 BUICK ELECTRA - (Inc. Park Avenue) 3.8L
 1991-88 6 BUICK LESABRE 3.8L
 1987-86 6 BUICK RIVIERA 3.8L
 1987-86 8 CADILLAC COMMERCIAL CHASSIS - FUNERAL COACH, LIMOUSINE 4.1L
 1987-86 8 CADILLAC DEVILLE 4.1L
 1987-86 8 CADILLAC FLEETWOOD 4.1L
 1990-88 6 OLDSMOBILE 98 3.8L
 1991-88 6 OLDSMOBILE EIGHTY-EIGHT, DELTA 88 3.8L
 1987-86 6 OLDSMOBILE TORONADO 3.8L
 1991-88 6 PONTIAC BONNEVILLE 3.8L

642659

Inlet A: WELDED 5-BOLT FLANGE
Outlet A: WELDED 2-BOLT FLANGE
Length: 35"



- 1997-96 4 FORD PROBE 2.0L
- 1997-96 4 MAZDA 626 2.0L
- 1997-96 4 MAZDA MX6 2.0L

642660

Inlet A: LOOSE 2-BOLT FLANGE W/ FEMALE FLARE
Inlet B: LOOSE 2-BOLT FLANGE W/ FEMALE FLARE
Outlet A: WELDED 2-BOLT FLANGE
Length: 43"

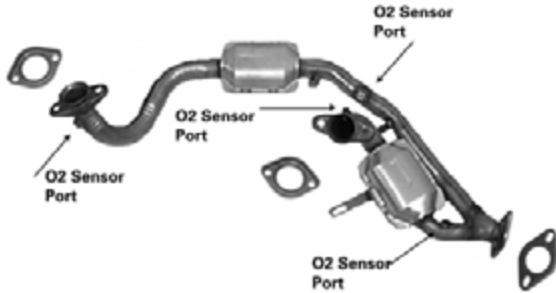

- 1999-96 6 FORD TAURUS 3.0L
- 1999-96 6 MERCURY SABLE 3.0L

642661

Inlet A: WELDED 2-BOLT FLANGE W/ GASKET STUB
Outlet A: WELDED 2-BOLT FLANGE W/ GASKET STUB
Length: 40.50"



- 2002-96 6 MAZDA MILLENIA 2.3L

642662

Inlet A: WELDED 4-BOLT FLANGE
Inlet B: WELDED 4-BOLT FLANGE
Outlet A: WELDED 3-BOLT FLANGE
Length: 18"

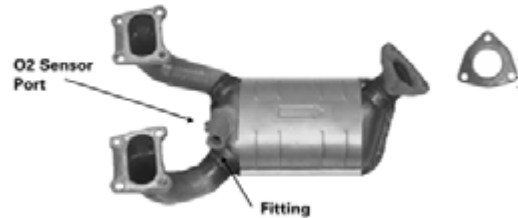

- 1998-95 4 NISSAN 200SX 1.6L
- 1999-95 4 NISSAN SENTRA 1.6L

642663

Inlet A: WELDED 2-BOLT FLANGE
Outlet A: WELDED 2-BOLT FLANGE
Length: 14.25"



- 1998 4 SUBARU FORESTER 2.5L

642666

Inlet A: WELDED 3-BOLT FLANGE
Outlet A: WELDED 3-BOLT FLANGE
Length: 42.75"



- 1995-93 4 SATURN SC1 1.9L
- 1995-93 4 SATURN SL / SL1 1.9L
- 1995-93 4 SATURN SW1 1.9L

DIRECT FIT



642670

Inlet A: LOOSE 3-BOLT FLANGE W/ 45 DEGREE FLARE
 Outlet A: WELDED 2-BOLT FLANGE
 Length: 32"

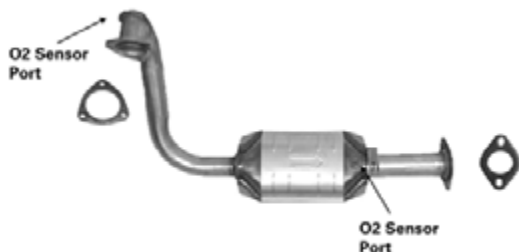

1998-96 4 SAAB 9000 2.3L

642671

Inlet A: WELDED 4-BOLT FLANGE
 Outlet A: WELDED 3-BOLT FLANGE W/ GASKET STUB
 Length: 40.13"



1998-96 4 CHEVROLET CAVALIER 2.4L
 1998-97 4 CHEVROLET MALIBU 2.4L
 1999 4 PONTIAC GRAND AM 2.4L
 1998-96 4 PONTIAC SUNFIRE 2.4L

642672

Inlet A: WELDED 3-BOLT FLANGE
 Outlet A: 2.165" O.D. PIPE
 Length: 19.75"



2002-96 4 VOLKSWAGEN CABRIOLET 2.0L
 1998-96 4 VOLKSWAGEN GOLF 2.0L
 1998-96 4 VOLKSWAGEN JETTA 2.0L
 1996 4 VOLKSWAGEN PASSAT 2.0L

642675

Inlet A: LOOSE 2-BOLT FLANGE W/ GASKET STUB
 Outlet A: 2.25" O.D. PIPE
 Length: 41"



1997-96 4 DODGE STRATUS 2.0L
 1997-96 4 PLYMOUTH BREEZE 2.0L

642676

Inlet A: LOOSE 2-BOLT FLANGE W/ FEMALE FLARE
 Outlet A: WELDED 3-BOLT FLANGE
 Length: 32.50"

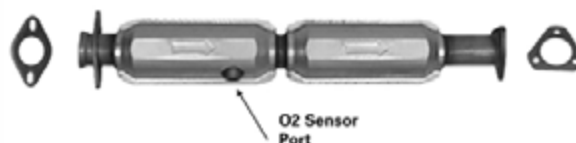

2004-96 6 ACURA RL 3.5L
 1998-96 6 ACURA TL 3.2L

642677

Inlet A: WELDED 4-BOLT FLANGE
 Outlet A: WELDED 2-BOLT FLANGE
 Length: 40.38"



2000-98 4 FORD CONTOUR 2.0L
 2002-99 4 MERCURY COUGAR 2.0L
 2000-98 4 MERCURY MYSTIQUE 2.0L

642678

Inlet A: LOOSE 2-BOLT FLANGE W/ FEMALE FLARE
 Outlet A: WELDED 4-BOLT FLANGE
 Length: 45.25"



1994 6 CHEVROLET LUMINA 3.1L
 1993-90 6 OLDSMOBILE CUTLASS 3.1L
 1993-90 6 PONTIAC GRAND PRIX 3.1L

642680

Inlet A: WELDED 3-BOLT FLANGE
Inlet B: WELDED 3-BOLT FLANGE
Outlet A: WELDED 2-BOLT FLANGE
Length: 47.25"

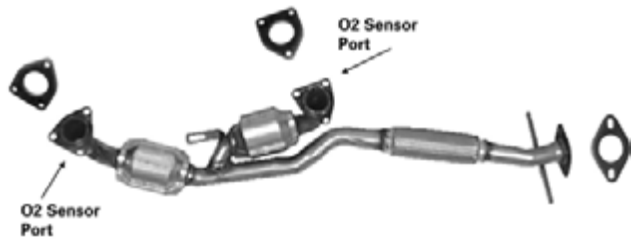

1998-96 6 INFINITI I30 3.0L
1999-95 6 NISSAN MAXIMA 3.0L

642683

Inlet A: WELDED 3-BOLT FLANGE W/ STUDS
Outlet A: WELDED 2-BOLT FLANGE
Length: 21.25"

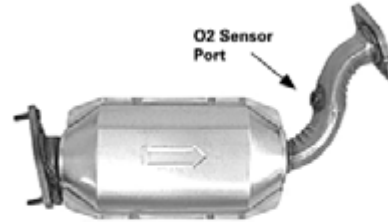

2000-95 6 FORD CONTOUR 2.5L
2000-99 6 MERCURY COUGAR 2.5L
2000-95 6 MERCURY MYSTIQUE 2.5L

642681

Inlet A: WELDED 2-BOLT FLANGE
Outlet A: WELDED 2-BOLT FLANGE
Length: 26"

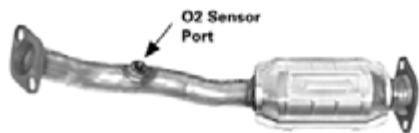

1997-96 6 MAZDA MPV VAN 3.0L

642687

Inlet A: WELDED 4-BOLT FLANGE
Outlet A: 2.165" O.D. PIPE
Length: 41.88"



2006-00 4 AUDI TT 1.8L

642682

Inlet A: WELDED 3-BOLT FLANGE
Outlet A: WELDED 3-BOLT FLANGE
Length: 15.50"



2002-98 4 HONDA ACCORD 2.3L

642688

Inlet A: WELDED 3-BOLT FLANGE
Outlet A: WELDED 3-BOLT FLANGE
Length: 17"



2006-97 4 AUDI A4 1.8L
2005-98 4 VOLKSWAGEN PASSAT 1.8L

642690

Inlet A: WELDED 3-BOLT FLANGE W/ GASKET STUB
Outlet A: WELDED 2-BOLT FLANGE W/ GASKET STUB
Length: 10"



1997-90 8 LEXUS LS400 4.0L

DIRECT FIT



642690 (cont.)

1997-92 8 LEXUS SC400 4.0L

642691

Inlet A: LOOSE 2-BOLT FLANGE W/ FLARE
 Inlet B: LOOSE 2-BOLT FLANGE W/ FLARE
 Outlet A: WELDED 2-BOLT FLANGE
 Length: 44.75"



2000-98 6 FORD WINDSTAR 3.8L

642692

Inlet A: WELDED 4-BOLT FLANGE W/ STUDS
 Outlet A: LOOSE 2-BOLT FLANGE W/ FEMALE FLARE
 Length: 12.50"



2006-01 6 CHRYSLER SEBRING 2.7L
 2006-01 6 DODGE STRATUS 2.7L

642693

Inlet A: WELDED 4-BOLT FLANGE W/ STUDS
 Outlet A: WELDED 2-BOLT FLANGE
 Length: 8.25"



2006-01 6 CHRYSLER SEBRING 2.7L
 2006-01 6 DODGE STRATUS 2.7L

642695

Inlet A: WELDED 2-BOLT FLANGE W/ GASKET STUB
 Inlet B: WELDED 2-BOLT FLANGE W/ GASKET STUB
 Outlet A: WELDED 2-BOLT FLANGE
 Length: 44.88"

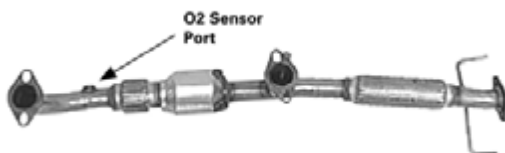

2000-95 6 CHRYSLER SEBRING 2.5L
 2000-95 6 DODGE AVENGER 2.5L

642696

Inlet A: WELDED 2-BOLT FLANGE
 Inlet B: 2-BOLT FLANGE W/ SPHERICAL FLARE
 Outlet A: WELDED 2-BOLT FLANGE
 Length: 29.75"

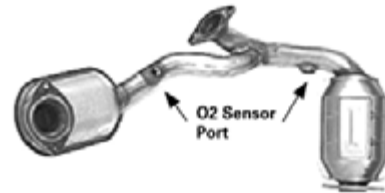

2007-00 6 FORD TAURUS 3.0L
 2005-00 6 MERCURY SABLE 3.0L

642697

Inlet A: WELDED 2-BOLT FLANGE
 Outlet A: 2.25" O.D. PIPE
 Length: 32.50"



2007-00 6 FORD TAURUS 3.0L
 2005-00 6 MERCURY SABLE 3.0L

642698

Inlet A: WELDED 4-BOLT FLANGE
 Outlet A: 1.75" MALE BALL
 Length: 44.50"



1996 5 VOLVO 850 2.3L

642699

Inlet A: WELDED 3-BOLT FLANGE
 Outlet A: WELDED 3-BOLT FLANGE
 Length: 40"



2004-01 4 SATURN L100 2.2L
 2004-01 4 SATURN L200 2.2L
 2004-01 4 SATURN LW200 2.2L

642700

Inlet A: WELDED 2-BOLT FLANGE
Outlet A: WELDED 2-BOLT FLANGE
Length: 16.13"



2000-95 6 CHRYSLER SEBRING 2.5L
2000-95 6 DODGE AVENGER 2.5L

642701

Inlet A: LOOSE 2-BOLT FLANGE W/ FEMALE FLARE
Outlet A: WELDED 2-BOLT FLANGE
Length: 22.25"

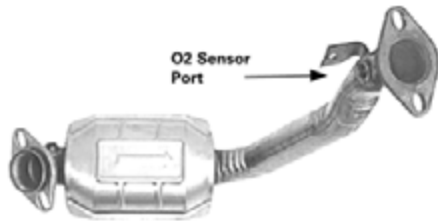

1996 4 FORD ESCORT 1.9L
1996 4 MERCURY TRACER 1.9L

642702

Inlet A: WELDED 3-BOLT FLANGE W/ GASKET STUB
Outlet A: WELDED 2-BOLT FLANGE W/ GASKET STUB
Length: 10"



2000-98 8 LEXUS GS400 4.0L
2007-01 8 LEXUS GS430 4.3L
1998 8 LEXUS LS400 4.0L
2006-01 8 LEXUS LS430 4.3L
2009-02 8 LEXUS SC430 4.3L

642703

Inlet A: WELDED 4-BOLT FLANGE W/ GASKET STUB
Outlet A: WELDED 2-BOLT FLANGE
Length: 23"

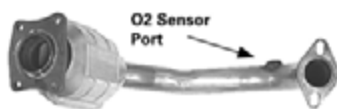

2004-00 4 FORD FOCUS 2.0L

642704

Inlet A: WELDED 2-BOLT FLANGE
Outlet A: WELDED 3-BOLT FLANGE
Length: 19.50"



2003-00 4 HONDA S2000 2.0L
2005-04 4 HONDA S2000 2.2L

642705

Inlet A: WELDED 2-BOLT FLANGE
Outlet A: WELDED 3-BOLT FLANGE
Length: 17.63"



1999-96 4 ACURA INTEGRA 1.8L

642706

Inlet A: LOOSE 2-BOLT FLANGE W/ SPHERICAL FLARE
Outlet A: 2.50" O.D. PIPE
Length: 38.38"



1997-95 6 BUICK LESABRE 3.8L
1996-95 6 BUICK PARK AVENUE 3.8L
1996-95 6 BUICK RIVIERA 3.8L
1996-95 6 OLDSMOBILE 98 3.8L
1996-95 6 OLDSMOBILE EIGHTY-EIGHT, DELTA 88 3.8L
1996-95 6 PONTIAC BONNEVILLE 3.8L

642707

Inlet A: WELDED 2-BOLT FLANGE W/ GASKET STUB
Inlet B: WELDED 2-BOLT FLANGE W/ GASKET STUB
Outlet A: WELDED 2-BOLT FLANGE
Length: 48"



1996-95 6 TOYOTA AVALON 3.0L
1996-95 6 TOYOTA CAMRY, (Inc. 1998 & Older SOLARA) 3.0L

DIRECT FIT



642708

Inlet A: WELDED 2-BOLT FLANGE W/ STUDS
 Outlet A: WELDED 2-BOLT FLANGE
 Length: 16.25"



2000-98 4 KIA SPORTAGE 2.0L

642709

Inlet A: WELDED 3-BOLT FLANGE
 Inlet B: WELDED 3-BOLT FLANGE
 Outlet A: 2.575" O.D. PIPE
 Length: 31.50"



2006-01 4 AUDI TT 1.8L

642710

Inlet A: WELDED 3-BOLT FLANGE
 Outlet A: WELDED 3-BOLT FLANGE
 Length: 31.50"

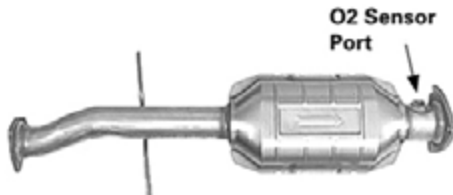

1999-98 6 CHEVROLET S-Series (2WD), T-Series (4WD) PICKUP 4.3L
 1999-98 6 GMC S-Series (2WD), T-Series (4WD) PICKUP (SONOMA) 4.3L
 1999-98 6 ISUZU PICKUP 4.3L

642711

Inlet A: 3-BOLT FLANGE W/ 45 DEGREE FLARE
 Outlet A: WELDED 2-BOLT FLANGE
 Length: 36"



2003-00 4 SAAB 9-5 2.3L

642712

Inlet A: WELDED 3-BOLT FLANGE
 Inlet B: WELDED 3-BOLT FLANGE
 Outlet A: 2.18" O.D. PIPE
 Length: 45"



2002-99 6 VOLKSWAGEN GOLF 2.8L
 2002-99 6 VOLKSWAGEN JETTA 2.8L

642713

Inlet A: WELDED 3-BOLT FLANGE
 Outlet A: WELDED 2-BOLT FLANGE
 Length: 20.50"



2008-03 V6 INFiniti FX35 3.5L
 2007-03 6 INFiniti G35 3.5L
 2008-06 6 INFiniti M35 3.5L
 2006-03 6 NISSAN 350Z 3.5L

642714

Inlet A: WELDED 3-BOLT FLANGE
 Outlet A: WELDED 2-BOLT FLANGE
 Length: 22.38"



2008-03 V6 INFiniti FX35 3.5L
 2007-03 6 INFiniti G35 3.5L
 2008-06 6 INFiniti M35 3.5L
 2006-03 6 NISSAN 350Z 3.5L

642716

Inlet A: WELDED 2-BOLT FLANGE W/ GASKET STUB
 Outlet A: WELDED 2-BOLT FLANGE
 Length: 27.50"

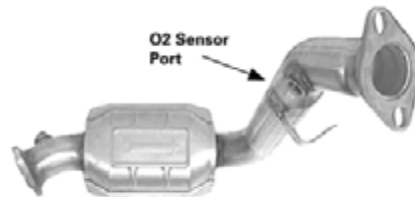

2003-98 4 FORD ESCORT 2.0L

642717

Inlet A: WELDED 3-BOLT FLANGE
Outlet A: WELDED 3-BOLT FLANGE
Length: 16.88"



2003-01 6 ACURA CL 3.2L
2003-00 6 ACURA TL 3.2L
2002-00 6 HONDA ACCORD 3.0L
2004-99 6 HONDA ODYSSEY 3.5L

642718

Inlet A: LOOSE 2-BOLT FLANGE W/ SPHERICAL FLARE
Outlet A: 2.50" O.D. PIPE
Length: 31.75"



1995 8 OLDSMOBILE AURORA 4.0L

642719

Inlet A: WELDED 3-BOLT FLANGE
Outlet A: WELDED 2-BOLT FLANGE
Length: 21.50"



2004-00 4 FORD FOCUS 2.0L

642720

Inlet A: WELDED 3-BOLT FLANGE W/ GASKET STUB
Outlet A: WELDED 2-BOLT FLANGE
Length: 43"



1997-96 6 HONDA PASSPORT 3.2L
1997-96 6 ISUZU RODEO 3.2L

642721

Inlet A: WELDED 2-BOLT FLANGE
Outlet A: WELDED 2-BOLT FLANGE
Length: 28.50"



1997-96 4 TOYOTA RAV4 2.0L

642723

Inlet A: WELDED 3-BOLT FLANGE
Outlet A: WELDED 3-BOLT FLANGE
Length: 44"



2000-99 4 SATURN SL2 1.9L

642725

Inlet A: WELDED 2-BOLT FLANGE
Outlet A: WELDED 2-BOLT FLANGE
Length: 36"



2003 4 SUBARU BAJA 2.5L
2005-99 4 SUBARU FORESTER 2.5L
2005-99 4 SUBARU IMPREZA 2.5L
2003-01 4 SUBARU LEGACY 2.5L
2003-01 4 SUBARU OUTBACK 2.5L

642726

Inlet A: WELDED 2-BOLT FLANGE
Inlet B: WELDED 2-BOLT FLANGE
Outlet A: WELDED 2-BOLT FLANGE
Length: 43.75"



1999-96 6 FORD TAURUS 3.0L
1999-96 6 MERCURY SABLE 3.0L

DIRECT FIT



642727

Inlet A: WELDED 3-BOLT FLANGE
 Outlet A: WELDED 3-BOLT FLANGE
 Length: 42.75"



- 1999-96 4 SATURN SC1 1.9L
- 1999-96 4 SATURN SL / SL1 1.9L
- 1999-96 4 SATURN SW1 1.9L

642731

Inlet A: WELDED 3-BOLT FLANGE
 Outlet A: WELDED 3-BOLT FLANGE
 Length: 13"

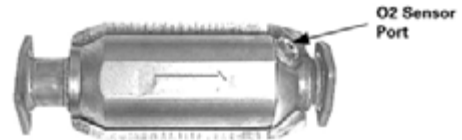

- 1999-97 6 ACURA CL 3.0L
- 1999 6 ACURA TL 3.2L
- 1999-98 6 HONDA ACCORD 3.0L

642728

Inlet A: WELDED 4-BOLT FLANGE
 Outlet A: WELDED 3-BOLT FLANGE
 Length: 38.25"



- 1997-96 4 OLDSMOBILE ACHIEVA 2.4L
- 1998-96 4 PONTIAC GRAND AM 2.4L

642732

Inlet A: WELDED 2-BOLT FLANGE
 Outlet A: WELDED 3-BOLT FLANGE
 Length: 17.63"



- 2001-97 4 HONDA CRV 2.0L
- 1997-96 4 HONDA ODYSSEY 2.2L
- 1997-96 4 ISUZU OASIS 2.2L

642729

Inlet A: 45 DEGREE FLARE
 Outlet A: 2.25" O.D. PIPE
 Length: 23"

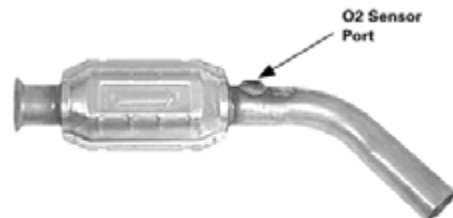

- 2004-99 6 CHRYSLER 300M 3.5L
- 2001-99 6 CHRYSLER LHS 3.5L
- 2000 6 DODGE INTREPID 3.5L

642733

Inlet A: LOOSE 2-BOLT FLANGE W/ SPHERICAL FLARE
 Outlet A: WELDED 2-BOLT FLANGE
 Length: 37.50"



- 2006-03 8 FORD CROWN VICTORIA (Inc. Police, Taxi, Station Wagon) 4.6L
- 2006-03 8 LINCOLN TOWN CAR 4.6L
- 2006-03 8 MERCURY GRAND MARQUIS FULL SIZE 4.6L
- 2004-03 8 MERCURY MARAUDER 4.6L

642730

Inlet A: WELDED 3-BOLT FLANGE
 Outlet A: WELDED 3-BOLT FLANGE
 Length: 39"



- 2005-02 4 CHEVROLET CAVALIER 2.2L
- 2005-04 4 CHEVROLET MALIBU 2.2L
- 2004-02 4 OLDSMOBILE ALERO 2.2L
- 2005-02 4 PONTIAC GRAND AM 2.2L
- 2005-02 4 PONTIAC SUNFIRE 2.2L

642734

Inlet A: LOOSE 2-BOLT FLANGE W/ SPHERICAL FLARE
 Outlet A: WELDED 2-BOLT FLANGE
 Length: 36.25"



- 2006-03 8 FORD CROWN VICTORIA (Inc. Police, Taxi, Station Wagon) 4.6L
- 2006-03 8 LINCOLN TOWN CAR 4.6L

642734 (cont.)

2006-03 8 MERCURY GRAND MARQUIS FULL SIZE 4.6L
2004-03 8 MERCURY MARAUDER 4.6L

642736

Inlet A: WELDED 3-BOLT FLANGE W/ GASKET STUB
Outlet A: WELDED 2-BOLT FLANGE
Length: 26.50"

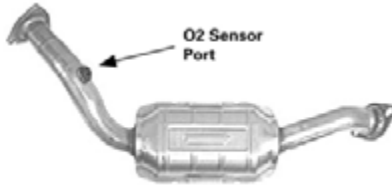

2004-99 6 NISSAN FRONTIER 3.3L
2004-00 6 NISSAN XTERRA 3.3L

642737

Inlet A: WELDED 3-BOLT FLANGE W/ GASKET STUB
Outlet A: WELDED 2-BOLT FLANGE
Length: 26.75"



2004-99 6 NISSAN FRONTIER 3.3L
2004-00 6 NISSAN XTERRA 3.3L

642738

Inlet A: WELDED 2-BOLT FLANGE
Outlet A: WELDED 3-BOLT FLANGE
Length: 16"

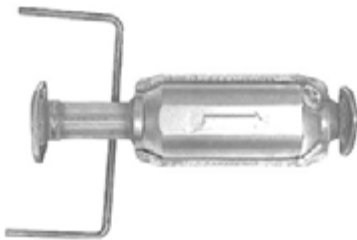

1997 4 ACURA CL 2.2L
1997-96 4 HONDA ACCORD 2.2L

642739

Inlet A: 2-BOLT FLANGE W/ SPHERICAL FLARE
Inlet B: 2-BOLT FLANGE W/ SPHERICAL FLARE
Outlet A: WELDED 2-BOLT FLANGE
Length: 42.50"



1999-96 8 FORD TAURUS 3.4L

642740

Inlet A: WELDED 2-BOLT FLANGE
Outlet A: 2.25" O.D. PIPE
Length: 11"



1999-96 8 FORD TAURUS 3.4L

642741

Inlet A: WELDED 4-BOLT FLANGE
Outlet A: 2.50" O.D. PIPE
Length: 25"



2000-97 6 BUICK PARK AVENUE 3.8L
1999-97 6 BUICK RIVIERA 3.8L

642742

Inlet A: LOOSE 2-BOLT FLANGE W/ SPHERICAL FLARE
Outlet A: 2.25" O.D. PIPE
Length: 46.75"



2002-00 8 JAGUAR S-TYPE 4.0L
2001-00 8 LINCOLN LS 3.9L

642743

Inlet A: WELDED 3-BOLT FLANGE
Outlet A: WELDED 2-BOLT FLANGE
Length: 10.25"



2000-99 8 LEXUS LS400 4.0L

DIRECT FIT



642744

Inlet A: WELDED 3-BOLT FLANGE
 Outlet A: WELDED 2-BOLT FLANGE
 Length: 10.25"



2000-99 8 LEXUS LS400 4.0L

642745

Inlet A: WELDED 9-BOLT FLANGE
 Outlet A: WELDED 2-BOLT FLANGE
 Length: 20.25"

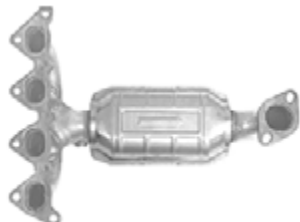

1998 4 HYUNDAI ELANTRA 1.8L
 2000-99 4 HYUNDAI ELANTRA 2.0L
 2001-98 4 HYUNDAI TIBURON 2.0L

642746

Inlet A: WELDED 2-BOLT FLANGE
 Outlet A: WELDED 2-BOLT FLANGE
 Length: 15"



2000-97 4 MITSUBISHI MIRAGE 1.5L

642747

Inlet A: WELDED 2-BOLT FLANGE
 Outlet A: WELDED 2-BOLT FLANGE
 Length: 43"

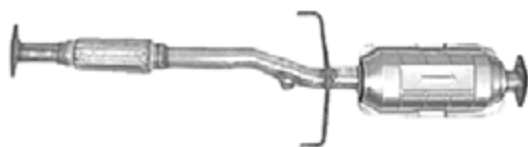

1999 4 MITSUBISHI ECLIPSE 2.4L
 2000-99 4 MITSUBISHI GALANT 2.4L

642748

Inlet A: WELDED 4-BOLT FLANGE
 Outlet A: 1.965" O.D. PIPE
 Length: 43.25"



2002-00 6 AUDI A6 2.7L
 2002-01 6 AUDI ALL ROAD 2.7L

642749

Inlet A: WELDED 2-BOLT FLANGE
 Outlet A: WELDED 2-BOLT FLANGE W/ GASKET STUB
 Length: 43.75"



1995-94 6 BUICK REGAL 3.8L

642750

Inlet A: WELDED 2-BOLT FLANGE
 Outlet A: WELDED 2-BOLT FLANGE W/ GASKET STUB
 Length: 35.25"



2000-98 4 TOYOTA RAV4 2.0L

642751

Inlet A: WELDED 2-BOLT FLANGE W/ GASKET STUB
 Outlet A: WELDED 2-BOLT FLANGE
 Length: 36"

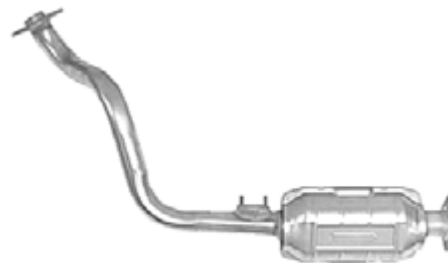

1992-91 6 TOYOTA LAND CRUISER 4.0L

642752

Inlet A: WELDED 2-BOLT FLANGE W/ GASKET STUB
Outlet A: WELDED 2-BOLT FLANGE
Length: 45"

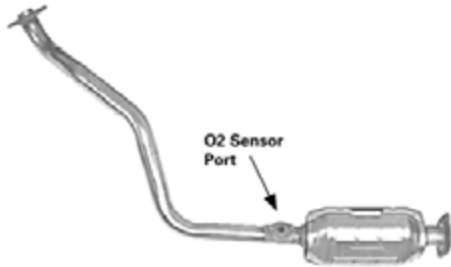

1992-91 6 TOYOTA LAND CRUISER 4.0L

642753

Inlet A: WELDED 6-BOLT FLANGE
Outlet A: WELDED 3-BOLT FLANGE
Length: 12.50"

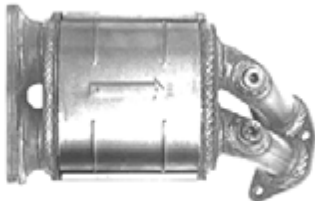

2002-00 4 NISSAN SENTRA 1.8L

642754

Inlet A: WELDED 2-BOLT FLANGE
Outlet A: WELDED 3-BOLT FLANGE
Length: 47"



2009-05 6 CHEVROLET EQUINOX 3.4L
2009-06 6 PONTIAC TORRENT 3.4L

642755

Inlet A: LOOSE 2-BOLT FLANGE W/ FLAT FLARE
Outlet A: LOOSE 2-BOLT FLANGE W/ FLAT FLARE
Length: 16.25"

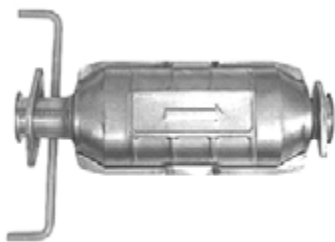

1999-95 4 CHRYSLER SEBRING 2.0L
1998-95 4 EAGLE TALON 2.0L
1998-95 4 MITSUBISHI ECLIPSE 2.0L

642755 (cont.)

1998-96 4 MITSUBISHI ECLIPSE 2.4L
1998-94 4 MITSUBISHI GALANT 2.4L

642757

Inlet A: WELDED 2-BOLT FLANGE
Outlet A: WELDED 3-BOLT FLANGE
Length: 17.50"



1999-96 4 ACURA INTEGRA 1.8L

642759

Inlet A: WELDED 2-BOLT FLANGE
Outlet A: WELDED 3-BOLT FLANGE
Length: 16.13"

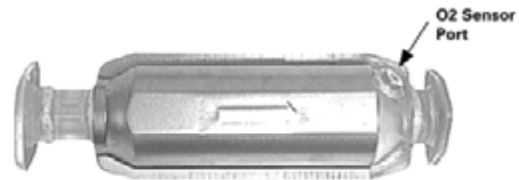

1998 4 HONDA ODYSSEY 2.3L
1999-98 4 ISUZU OASIS 2.3L

642760

Inlet A: WELDED 3-BOLT FLANGE W/ GASKET STUB
Outlet A: WELDED 2-BOLT FLANGE
Length: 36"



2002-98 6 HONDA PASSPORT 3.2L
2002-98 6 ISUZU RODEO 3.2L

642761

Inlet A: WELDED 3-BOLT FLANGE W/ GASKET STUB
Outlet A: WELDED 2-BOLT FLANGE
Length: 42"



2002-98 6 HONDA PASSPORT 3.2L

DIRECT FIT



642761 (cont.)

2002-98 6 ISUZU RODEO 3.2L

642762

Inlet A: WELDED 2-BOLT FLANGE
 Outlet A: WELDED 2-BOLT FLANGE
 Length: 15.25"



- 1997-96 4 SUBARU IMPREZA 1.8L
- 1998 4 SUBARU IMPREZA 2.5L
- 2001-95 4 SUBARU IMPREZA 2.2L
- 1999-95 4 SUBARU LEGACY 2.2L
- 2002-96 4 SUBARU LEGACY 2.5L
- 2000 4 SUBARU OUTBACK 2.5L

642763

Inlet A: WELDED 2-BOLT FLANGE
 Outlet A: WELDED 2-BOLT FLANGE W/ GASKET STUB
 Length: 23.25"



- 1998 4 SUBARU FORESTER 2.5L
- 1998 4 SUBARU IMPREZA 2.5L
- 2001-95 4 SUBARU IMPREZA 2.2L
- 1999-95 4 SUBARU LEGACY 2.2L
- 2002-96 4 SUBARU LEGACY 2.5L
- 2000 4 SUBARU OUTBACK 2.5L

642764

Inlet A: WELDED 2-BOLT FLANGE
 Outlet A: WELDED 2-BOLT FLANGE
 Length: 12.38"



- 2004-02 6 INFiniti I35 3.5L
- 2003-02 6 NISSAN MAXIMA 3.5L

642765

Inlet A: WELDED 4-BOLT FLANGE
 Outlet A: 2.165" O.D. PIPE
 Length: 42"



- 2004-99 4 VOLKSWAGEN BEETLE 1.8L
- 2003-00 4 VOLKSWAGEN GOLF 1.8L
- 2003-00 4 VOLKSWAGEN JETTA 1.8L

642766

Inlet A: WELDED 4-BOLT FLANGE
 Outlet A: 2.165" O.D. PIPE
 Length: 42"



- 2005-01 4 VOLKSWAGEN BEETLE 2.0L
- 2006-01 4 VOLKSWAGEN GOLF 2.0L
- 2005-02 4 VOLKSWAGEN JETTA 2.0L

642767

Inlet A: LOOSE 2-BOLT FLANGE W/ SPHERICAL FLARE
 Inlet B: LOOSE 2-BOLT FLANGE W/ SPHERICAL FLARE
 Outlet A: WELDED 2-BOLT FLANGE
 Length: 45"



- 2007-04 6 FORD FREESTAR 3.9L
- 2007-04 6 FORD FREESTAR 4.2L
- 2003-01 6 FORD WINDSTAR 3.8L
- 2007-04 6 MERCURY MONTEREY 4.2L

642768

Inlet A: WELDED 4-BOLT FLANGE
 Outlet A: 2.25" O.D. PIPE
 Length: 39.50"

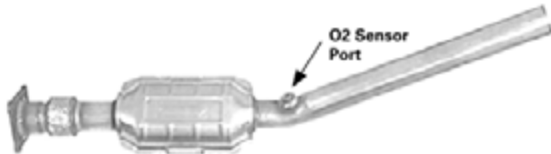

- 2000-98 4 DODGE STRATUS 2.0L
- 2000-98 4 PLYMOUTH BREEZE 2.0L

642770

Inlet A: WELDED 3-BOLT FLANGE
 Outlet A: WELDED 3-BOLT FLANGE
 Length: 16.88"

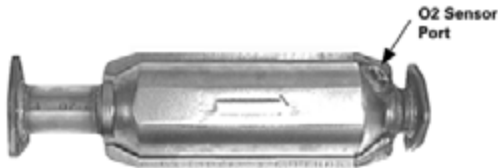

- 1999-97 6 ACURA CL 3.0L
- 1999 6 ACURA TL 3.2L
- 1999-98 6 HONDA ACCORD 3.0L

642771

Inlet A: LOOSE 2-BOLT FLANGE W/ 2.50" FEMALE FLARE
 Outlet A: 2.63" O.D. PIPE
 Length: 38"



- 1994-92 6 BUICK LESABRE 3.8L
- 1994-91 6 BUICK PARK AVENUE 3.8L

642771 (cont.)

- 1994-92 6 OLDSMOBILE 98 3.8L
- 1994-92 6 OLDSMOBILE EIGHTY-EIGHT, DELTA 88 3.8L
- 1994-92 6 PONTIAC BONNEVILLE 3.8L

642774

Inlet A: LOOSE 2-BOLT FLANGE W/ FEMALE FLARE
 Outlet A: 2.38" O.D. PIPE
 Length: 22"



- 1995-94 8 CADILLAC DEVILLE 4.9L
- 1993 8 CADILLAC ELDORADO 4.9L
- 1993 8 CADILLAC SEVILLE 4.9L

642775

Inlet A: WELDED 2-BOLT FLANGE W/ FEMALE FLARE
 Outlet A: 2.63" O.D. PIPE
 Length: 23.50"



- 1990 8 CADILLAC ELDORADO 4.5L
- 1992-91 8 CADILLAC ELDORADO 4.9L
- 1995-93 8 CADILLAC ELDORADO 4.6L
- 1990 8 CADILLAC SEVILLE 4.5L
- 1992-91 8 CADILLAC SEVILLE 4.9L
- 1994-93 8 CADILLAC SEVILLE 4.6L

642777

Inlet A: 1.88" I.D. PIPE
 Inlet B: 1.88" I.D. PIPE
 Outlet A: 2" O.D. PIPE
 Length: 23.75"



- 1996-93 6 CHRYSLER CONCORDE 3.3L
- 1995-93 6 CHRYSLER INTREPID 3.3L
- 1997-93 6 DODGE INTREPID 3.3L
- 1997-93 6 EAGLE VISION 3.3L

DIRECT FIT



642779

Inlet A: WELDED 3-BOLT FLANGE W/ GASKET STUB
 Inlet B: WELDED 3-BOLT FLANGE W/ GASKET STUB
 Outlet A: WELDED 2-BOLT FLANGE
 Length: 38.50"



- 2001-00 6 INFINITI I30 3.0L
- 2001-00 6 NISSAN MAXIMA 3.0L

642780

Inlet A: WELDED 3-BOLT FLANGE
 Outlet A: WELDED 2-BOLT FLANGE
 Length: 36.75"



- 2007-05 4 CHEVROLET COBALT 2.2L
- 2007-06 4 CHEVROLET COBALT 2.4L
- 2007-06 4 CHEVROLET HHR 2.2L
- 2007-06 4 CHEVROLET HHR 2.4L
- 2007 4 PONTIAC G5 2.2L
- 2007 4 PONTIAC G5 2.4L
- 2007-05 4 SATURN ION 2.2L
- 2007-06 4 SATURN ION 2.4L

642782

Inlet A: LOOSE 2-BOLT FLANGE W/ SPHERICAL FLARE
 Inlet B: LOOSE 2-BOLT FLANGE W/ SPHERICAL FLARE
 Outlet A: WELDED 2-BOLT FLANGE
 Length: 45"



- 2000-98 6 FORD WINDSTAR 3.8L

642785

Inlet A: WELDED 2-BOLT FLANGE
 Outlet A: WELDED 3-BOLT FLANGE
 Length: 40"



- 2005-01 4 HONDA CIVIC 1.7L

642786

Inlet A: WELDED 2-BOLT FLANGE
 Outlet A: WELDED 3-BOLT FLANGE
 Length: 16.50"



- 1998-96 4 HONDA CIVIC 1.6L

642787

Inlet A: WELDED 2-BOLT FLANGE
 Outlet A: WELDED 2-BOLT FLANGE
 Length: 36"



- 2002-99 6 OLDSMOBILE INTRIGUE 3.5L

642788

Inlet A: WELDED 9-BOLT FLANGE
 Outlet A: WELDED 2-BOLT FLANGE
 Length: 17.50"

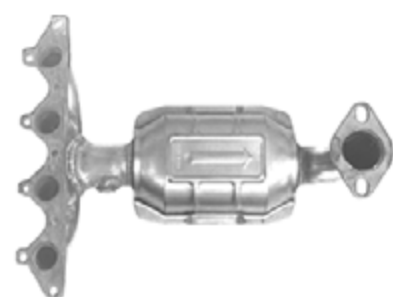

- 2002-00 4 HYUNDAI ACCENT 1.5L

642789

Inlet A: LOOSE 2-BOLT FLANGE W/ FLAT FLARE
Outlet A: LOOSE 2-BOLT FLANGE W/ FLAT FLARE
Length: 17"



1996 6 HYUNDAI SONATA 3.0L
1998-96 4 HYUNDAI SONATA 2.0L

642791

Inlet A: WELDED 4-BOLT FLANGE
Outlet A: 2.25" O.D. PIPE
Length: 38.75"



2006-01 4 CHRYSLER SEBRING 2.4L
2006-01 4 DODGE STRATUS 2.4L

642792

Inlet A: WELDED 8-BOLT FLANGE
Outlet A: WELDED 3-BOLT FLANGE W/ GASKET STUB
Length: 33.25"



2005-98 6 LEXUS GS300 3.0L
2005-01 6 LEXUS IS300 3.0L
2000-98 6 LEXUS SC300 3.0L
1998 6 TOYOTA SUPRA 3.0L

642793

Inlet A: WELDED 2-BOLT FLANGE
Outlet A: WELDED 2-BOLT FLANGE
Length: 12.38"



2002-00 4 INFiniti G20 2.0L
2001-00 6 INFiniti I30 3.0L
1998-95 4 NISSAN 240SX 2.4L

642793 (cont.)

2001-00 4 NISSAN ALTIMA 2.4L
2001-00 6 NISSAN MAXIMA 3.0L
2001-00 4 NISSAN SENTRA 2.0L
2002-00 4 NISSAN SENTRA 1.8L
2004-00 4 NISSAN XTERRA 2.4L

642794

Inlet A: WELDED 2-BOLT FLANGE
Outlet A: WELDED 2-BOLT FLANGE
Length: 19"



2002-98 4 MAZDA 626 2.0L

642795

Inlet A: 2.13" I.D. PIPE
Outlet A: LOOSE 3-BOLT FLANGE W/ FLAT FLARE
Length: 21.50"



2002-93 4 SATURN SC1 1.9L
2002-93 4 SATURN SC2 1.9L
2002-93 4 SATURN SL / SL1 1.9L
2002-93 4 SATURN SL2 1.9L
1999-93 4 SATURN SW1 1.9L
2001-93 4 SATURN SW2 1.9L

642796

Inlet A: WELDED 5-BOLT FLANGE
Outlet A: WELDED 2-BOLT FLANGE
Length: 12.13"



1999-98 4 HYUNDAI ACCENT 1.5L

DIRECT FIT



642797

Inlet A: WELDED 2-BOLT FLANGE
 Inlet B: WELDED 2-BOLT FLANGE
 Outlet A: WELDED 2-BOLT FLANGE
 Length: 43.38"



1996-95 6 FORD WINDSTAR 3.0L

642798

Inlet A: WELDED 2-BOLT FLANGE W/ CHRYSLER BEAD
 Outlet A: 2.25" O.D. PIPE
 Length: 33.50"



1993-92 6 CHRYSLER FIFTH AVENUE 3.3L
 1993-92 6 CHRYSLER FIFTH AVENUE 3.8L
 1993-92 6 CHRYSLER IMPERIAL 3.8L
 1993-92 6 CHRYSLER NEW YORKER 3.3L
 1993-92 6 DODGE DYNASTY 3.3L

642799

Inlet A: WELDED 3-BOLT FLANGE
 Outlet A: WELDED 2-BOLT FLANGE
 Length: 22"



2004-00 4 FORD FOCUS 2.0L

642800

Inlet A: WELDED 2-BOLT FLANGE
 Outlet A: WELDED 2-BOLT FLANGE W/ GASKET STUB
 Length: 31.13"



2012-07 4 NISSAN SENTRA 2.0L

642802

Inlet A: WELDED 2-BOLT FLANGE W/ SPHERICAL FLARE
 Outlet A: 2.24" O.D. PIPE
 Length: 30.63"



2013-09 4 MAZDA 6 2.5L

642803

Inlet A: WELDED 3-BOLT FLANGE
 Inlet B: WELDED 3-BOLT FLANGE
 Outlet A: WELDED 2-BOLT FLANGE
 Length: 26"



2010-06 4 SUBARU FORESTER 2.5L
 2011-06 4 SUBARU IMPREZA 2.5L
 2009-06 4 SUBARU LEGACY 2.5L
 2011-06 4 SUBARU OUTBACK 2.5L

642805

Inlet A: WELDED 2-BOLT FLANGE
 Outlet A: WELDED 2-BOLT FLANGE W/ GASKET STUB
 Length: 30"



2016-11 4 NISSAN JUKE 1.6L

642811

Inlet A: WELDED 2-BOLT FLANGE
Outlet A: 2.50" O.D. PIPE W/ SPHERICAL BALL
Length: 20.25"



2014-11 8 FORD MUSTANG 5.0L

642812

Inlet A: WELDED 2-BOLT FLANGE
Outlet A: 2.50" O.D. PIPE W/ SPHERICAL BALL
Length: 20.50"



2014-11 8 FORD MUSTANG 5.0L

642814

Inlet A: WELDED 2-BOLT FLANGE W/ SPHERICAL FLARE
Outlet A: WELDED 3-BOLT FLANGE W/ GASKET STUB
Length: 19.50"



2012-10 4 MAZDA CX-7 2.5L

642817

Inlet A: WELDED 2-BOLT FLANGE W/ SPHERICAL FLARE
Outlet A: 2.42" O.D. PIPE
Length: 19.25"



2003-99 6 LEXUS RX300 3.0L

642820

Inlet A: WELDED 2-BOLT FLANGE
Outlet A: 2.25" O.D. PIPE
Length: 22.38"



2010-09 4 PONTIAC VIBE 2.4L
2010-09 4 TOYOTA COROLLA 2.4L
2013-09 4 TOYOTA MATRIX 2.4L

642823

Inlet A: WELDED 2-BOLT FLANGE W/ SPHERICAL FLARE
Outlet A: 2.24" O.D. PIPE
Length: 26.38"



2011-04 6 MITSUBISHI ENDEAVOR 3.8L

DIRECT FIT



642824

Inlet A: WELDED 2-BOLT FLANGE W/ SPHERICAL FLARE
 Outlet A: WELDED 3-BOLT FLANGE
 Length: 26.75"



2012-07 4 ACURA RDX 2.3L

642825

Inlet A: WELDED 2-BOLT FLANGE
 Outlet A: WELDED 2-BOLT FLANGE
 Length: 11"



2009-07 6 KIA SORENTO 3.8L
 2009-08 6 KIA SORENTO 3.3L

642827

Inlet A: WELDED 2-BOLT FLANGE
 Outlet A: WELDED 2-BOLT FLANGE
 Length: 16.50"



2008-06 4 HYUNDAI ELANTRA 2.0L

642828

Inlet A: WELDED 2-BOLT FLANGE
 Outlet A: WELDED 2-BOLT FLANGE
 Length: 15.88"



2014-09 4 HYUNDAI SONATA 2.4L
 2013-10 4 KIA FORTE KOUP 2.4L
 2014-10 4 KIA FORTE KOUP 2.0L
 2013-10 4 KIA FORTE 2.0L
 2013-10 4 KIA FORTE 2.4L
 2014-13 4 KIA OPTIMA 2.4L

642830

Inlet A: WELDED 2-BOLT FLANGE
 Outlet A: WELDED 2-BOLT FLANGE
 Length: 13.13"



2010-09 6 HYUNDAI SONATA 3.3L

642837

Inlet A: WELDED 2-BOLT FLANGE
 Inlet B: WELDED 2-BOLT FLANGE
 Outlet A: WELDED 2-BOLT FLANGE
 Length: 47"



2005-01 8 LEXUS GS430 4.3L

642838

Inlet A: LOOSE 2-BOLT FLANGE W/ FLARE
Outlet A: LOOSE 2-BOLT FLANGE W/ FLARE
Length: 60"



2006-03 8 MERCEDES-BENZ S430 4.3L
2006-03 8 MERCEDES-BENZ S500 5.0L

642839

Inlet A: LOOSE 2-BOLT FLANGE W/ FLARE
Outlet A: 2.13" O.D. PIPE
Length: 64.50"



2006-03 8 MERCEDES-BENZ S430 4.3L
2006-03 8 MERCEDES-BENZ S500 5.0L

642840

Inlet A: WELDED 3-BOLT FLANGE
Inlet B: WELDED 3-BOLT FLANGE
Outlet A: WELDED 2-BOLT FLANGE
Length: 43"



2005-02 6 VOLVO S80 2.9L

642841

Inlet A: WELDED 2-BOLT FLANGE
Inlet B: WELDED 2-BOLT FLANGE
Outlet A: WELDED 2-BOLT FLANGE
Length: 43"



2010-02 8 LEXUS SC430 4.3L

642842

Inlet A: WELDED 2-BOLT FLANGE
Outlet A: 2.15" I.D. PIPE
Length: 40.25"



2005-04 4 TOYOTA RAV4 2.4L

642843

Inlet A: WELDED 4-BOLT FLANGE
Outlet A: 1.80" I.D. PIPE
Length: 30"



2002-00 4 DODGE NEON 2.0L
2001-00 4 PLYMOUTH NEON 2.0L

642844

Inlet A: 45 DEGREE FLARE
Outlet A: 3" O.D. PIPE
Length: 30"



2006-03 10 DODGE VIPER 8.3L

642845

Inlet A: 45 DEGREE FLARE
Outlet A: 3" O.D. PIPE
Length: 29.25"



2006-03 10 DODGE VIPER 8.3L

642846

Inlet A: 45 DEGREE FLARE
Outlet A: 2.25" O.D. PIPE
Length: 44"



2004-99 6 CHRYSLER 300M 3.5L

DIRECT FIT



642847

Inlet A: WELDED 4-BOLT FLANGE
 Outlet A: 2.25" O.D. PIPE
 Length: 33.50"



2005-01 4 DODGE NEON 2.0L

642848

Inlet A: WELDED 3-BOLT FLANGE
 Outlet A: WELDED 2-BOLT FLANGE
 Length: 25.50"



2004-02 4 FORD FOCUS 2.0L

642849

Inlet A: WELDED 2-BOLT FLANGE W/ FEMALE FLARE
 Outlet A: WELDED 3-BOLT FLANGE
 Length: 33"



1998-96 6 ACURA TL 3.2L

642850

Inlet A: WELDED 3-BOLT FLANGE
 Inlet B: WELDED 3-BOLT FLANGE
 Outlet A: WELDED 2-BOLT FLANGE
 Length: 39"



1999 6 INFiniti I30 3.0L
 1999 6 NISSAN MAXIMA 3.0L

642851

Inlet A: WELDED 3-BOLT FLANGE
 Outlet A: WELDED 2-BOLT FLANGE
 Length: 48"



2002-01 5 VOLVO S60 2.3L
 2002-01 5 VOLVO S60 2.4L
 2002-01 5 VOLVO S70/V70 2.3L

642852

Inlet A: WELDED 3-BOLT FLANGE
 Outlet A: WELDED 2-BOLT FLANGE
 Length: 10"



1998 8 LEXUS LS400 4.0L

642853

Inlet A: WELDED 2-BOLT FLANGE
 Outlet A: WELDED 2-BOLT FLANGE
 Length: 37.25"

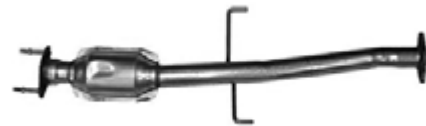

2000-99 4 MAZDA PROTÉGÉ 1.8L

642854

Inlet A: WELDED 4-BOLT FLANGE
 Inlet B: WELDED 4-BOLT FLANGE
 Outlet A: WELDED 2-BOLT FLANGE
 Length: 41.25"



2001-99 6 VOLVO S80 2.9L

642855

Inlet A: LOOSE 3-BOLT FLANGE W/ FLARE
Outlet A: FEMALE FLARE
Length: 35"



2002-00 4 SAAB 9-3 2.0L
2002-00 4 SAAB 9-3 2.3L

642856

Inlet A: WELDED 2-BOLT FLANGE
Outlet A: 2" I.D. PIPE
Length: 48"



2006 6 BMW 325 3.0L
2012-07 6 BMW 328 3.0L
2006 6 BMW 330 3.0L

642857

Inlet A: WELDED 2-BOLT FLANGE
Outlet A: 2" I.D. PIPE
Length: 48"



2006 6 BMW 325 3.0L
2012-07 6 BMW 328 3.0L
2006 6 BMW 330 3.0L

642858

Inlet A: WELDED 2-BOLT FLANGE
Outlet A: WELDED 2-BOLT FLANGE
Length: 31"



2002-01 6 TOYOTA 4 RUNNER 3.4L

642859

Inlet A: WELDED 6-BOLT FLANGE
Outlet A: 2.50" O.D. PIPE
Length: 41.25"



2006-04 6 AUDI TT 3.2L
2004 6 VOLKSWAGEN GOLF 3.2L

642860

Inlet A: WELDED 3-BOLT FLANGE
Outlet A: WELDED 2-BOLT FLANGE W/GASKET STUB
Length: 21"



2009-07 4 SUZUKI SX4 2.0L

642861

Inlet A: WELDED 4-BOLT FLANGE
Outlet A: 2.17" O.D. PIPE
Length: 42.25"



2005-04 4 VOLKSWAGEN JETTA 2.0L

642862

Inlet A: WELDED 4-BOLT FLANGE
Inlet B: WELDED 4-BOLT FLANGE
Outlet A: WELDED 2-BOLT FLANGE
Length: 38.50"



2001-00 6 VOLVO S80 2.8L

DIRECT FIT



642863

Inlet A: WELDED 5-BOLT FLANGE
 Outlet A: WELDED 2-BOLT FLANGE
 Length: 20.50"



2012-08 4 SUBARU IMPREZA 2.5L

642864

Inlet A: WELDED 2-BOLT FLANGE
 Outlet A: WELDED 2-BOLT FLANGE
 Length: 34"



2013-09 4 SUBARU FORESTER 2.5L
 2014-08 4 SUBARU IMPREZA 2.5L
 2009-05 4 SUBARU LEGACY 2.5L
 2009-05 4 SUBARU OUTBACK 2.5L

642865

Inlet A: WELDED 2-BOLT FLANGE
 Outlet A: WELDED 2-BOLT FLANGE
 Length: 28"



2000-99 6 MITSUBISHI MONTERO SPORT 3.0L

642866

Inlet A: WELDED 2-BOLT FLANGE
 Outlet A: WELDED 2-BOLT FLANGE
 Length: 29"



2000-99 6 MITSUBISHI MONTERO SPORT 3.5L

642867

Inlet A: WELDED 2-BOLT FLANGE
 Inlet B: LOOSE 2-BOLT FLANGE W/ MALE BALL
 Outlet A: WELDED 2-BOLT FLANGE
 Length: 24.88"



2000-99 6 MITSUBISHI MONTERO SPORT 3.5L

642868

Inlet A: WELDED 2-BOLT FLANGE
 Outlet A: 2.25" O.D. PIPE
 Length: 22.75"



2005-04 6 MITSUBISHI GALANT 3.8L

642869

Inlet A: LOOSE 3-BOLT FLANGE W/ FLARE
 Outlet A: WELDED 3-BOLT FLANGE
 Length: 19.25"



2007-04 8 VOLKSWAGEN TOUAREG 4.2L

642870

Inlet A: LOOSE 3-BOLT FLANGE W/ FLARE
 Outlet A: WELDED 3-BOLT FLANGE
 Length: 22.50"



2007-04 8 VOLKSWAGEN TOUAREG 4.2L

642871

Inlet A: WELDED 3-BOLT FLANGE
 Outlet A: 2.38" O.D. PIPE
 Length: 28.50"



2007-04 8 VOLKSWAGEN TOUAREG 4.2L

642872

Inlet A: WELDED 3-BOLT FLANGE
Outlet A: 2.38" O.D. PIPE
Length: 28.13"



2007-04 8 VOLKSWAGEN TOUAREG 4.2L

642873

Inlet A: WELDED 3-BOLT FLANGE
Outlet A: 2.50" O.D. PIPE
Length: 42.50"



2011-03 4 SAAB 9-3 2.0L

642874

Inlet A: WELDED 3-BOLT FLANGE W/GASKET STUBS
Outlet A: WELDED 2-BOLT FLANGE W/GASKET STUB
Length: 25.25"



2005-00 4 TOYOTA MR2 SPYDER 1.8L

642875

Inlet A: WELDED 3-BOLT FLANGE
Outlet A: WELDED 3-BOLT FLANGE
Length: 35"



2007 6 AUDI Q7 3.6L
2007 6 VOLKSWAGEN TOUAREG 3.6L

642876

Inlet A: WELDED 3-BOLT FLANGE
Outlet A: WELDED 3-BOLT FLANGE
Length: 40"



2007 6 AUDI Q7 3.6L

642876 (cont.)

2007 6 VOLKSWAGEN TOUAREG 3.6L

642877

Inlet A: WELDED 6-BOLT FLANGE
Outlet A: 2.17" O.D. PIPE
Outlet B: 2.17" O.D. PIPE
Length: 39"



2007 6 VOLKSWAGEN TOUAREG 3.6L

642878

Inlet A: WELDED 4-BOLT FLANGE
Outlet A: 1.95" O.D. PIPE
Length: 44.75"



2004-00 6 AUDI A6 2.7L
2005-01 6 AUDI ALLROAD QUATTRO 2.7L

642879

Inlet A: WELDED 4-BOLT FLANGE
Outlet A: 1.95" O.D. PIPE
Length: 42"



2004-00 6 AUDI A6 2.7L
2005-01 6 AUDI ALLROAD QUATTRO 2.7L

642880

Inlet A: WELDED 2-BOLT FLANGE W/GASKET STUB
Outlet A: WELDED 2-BOLT FLANGE
Length: 13"



2008-07 8 INFiniti FX45 4.5L

DIRECT FIT



642881

Inlet A: WELDED 2-BOLT FLANGE W/GASKET STUB
 Outlet A: WELDED 2-BOLT FLANGE
 Length: 13"



2008-07 8 INFINITI FX45 4.5L

642882

Inlet A: WELDED 2-BOLT FLANGE
 Inlet B: WELDED 2-BOLT FLANGE
 Outlet A: WELDED 2-BOLT FLANGE
 Length: 47"



1994-90 8 LEXUS LS400 4.0L
 1997-92 8 LEXUS SC400 4.0L

642883

Inlet A: WELDED 3-BOLT FLANGE
 Outlet A: 2.18" O.D. PIPE
 Length: 46"



2004-98 4 VOLKSWAGEN BEETLE 1.9L
 2004-99 4 VOLKSWAGEN GOLF 1.9L
 2004-99 4 VOLKSWAGEN JETTA 1.9L

642884

Inlet A: WELDED 4-BOLT FLANGE
 Outlet A: 2.14" O.D. PIPE
 Length: 47"



2000 5 VOLVO S70/V70 2.4L

642885

Inlet A: LOOSE 3-BOLT FLANGE W/ FLARE
 Outlet A: LOOSE 3-BOLT FLANGE W/ FLARE
 Length: 21.44"



2003-98 6 MERCEDES-BENZ CLK320 3.2L
 2003-99 8 MERCEDES-BENZ CLK430 4.3L
 2002-01 8 MERCEDES-BENZ CLK55 AMG 5.5L

642886

Inlet A: LOOSE 3-BOLT FLANGE W/ FLARE
 Outlet A: 2.16" O.D. PIPE
 Length: 44.50"



2009-04 8 AUDI S4 4.2L

642887

Inlet A: LOOSE 3-BOLT FLANGE W/ FLARE
 Outlet A: 2.16" O.D. PIPE
 Length: 45.50"



2009-04 8 AUDI S4 4.2L

642888

Inlet A: WELDED 2-BOLT FLANGE
 Outlet A: 2.25" O.D. PIPE
 Length: 41.19"



2009-07 6 MITSUBISHI OUTLANDER 3.0L

642889

Inlet A: WELDED 2-BOLT FLANGE W/FLARE
Outlet A: 2.23" O.D. PIPE
Length: 21.13"

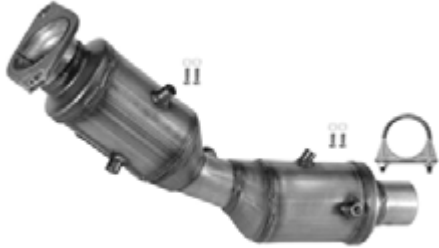

2014-12 4 TOYOTA PRIUS V 1.8L
2015-10 4 TOYOTA PRIUS 1.8L

642890

Inlet A: WELDED 4-BOLT FLANGE
Outlet A: WELDED 2-BOLT FLANGE
Length: 31.25"



2010-07 5 VOLVO C30 2.4L
2010-04 5 VOLVO S40/V40 2.4L
2010-05 5 VOLVO V50 2.4L

642891

Inlet A: WELDED 2-BOLT FLANGE
Outlet A: WELDED 2-BOLT FLANGE W/GASKET STUB
Length: 38.13"



2013 4 SCION FR-S 2.0L

642892

Inlet A: WELDED 2-BOLT FLANGE
Outlet A: 2.03" O.D. PIPE
Length: 22"



2006-04 4 TOYOTA HIGHLANDER 2.4L

642893

Inlet A: WELDED 4-BOLT FLANGE
Outlet A: 1.97" O.D. PIPE
Length: 44"



2004-03 6 AUDI A6 2.7L
2005-03 6 AUDI ALLROAD QUATTRO 2.7L

642894

Inlet A: WELDED 4-BOLT FLANGE
Outlet A: 1.97" O.D. PIPE
Length: 43.50"



2004-03 6 AUDI A6 2.7L
2005-03 6 AUDI ALLROAD QUATTRO 2.7L

642895

Inlet A: WELDED 2-BOLT FLANGE
Outlet A: WELDED 2-BOLT FLANGE W/GASKET STUB
Length: 45.75"



2008-06 6 SUZUKI VITARA, GRAND VITARA 2.7L

642896

Inlet A: WELDED 3-BOLT FLANGE
Outlet A: 2.50" O.D. PIPE
Length: 42.25"



2009-06 6 SAAB 9-3 2.8L

DIRECT FIT



642897

Inlet A: WELDED 2-BOLT FLANGE W/FLARE
 Outlet A: WELDED 3-BOLT FLANGE
 Length: 26"



2014-10 4 HONDA INSIGHT 1.3L

642898

Inlet A: WELDED 2-BOLT FLANGE W/FLARE
 Outlet A: LOOSE 2-BOLT FLANGE W/GASKET STUB
 Length: 25.50"



2012-09 4 NISSAN SENTRA 2.0L

642899

Inlet A: WELDED 2-BOLT FLANGE
 Outlet A: 2.13" I.D. PIPE
 Length: 35"



2008 4 MITSUBISHI LANCER 2.0L

642903

Inlet A: LOOSE 2-BOLT FLANGE W/ 2.25" FEMALE FLARE
 Inlet B: LOOSE 2-BOLT FLANGE W/ 2.25" FEMALE FLARE
 Outlet A: LOOSE 2-BOLT FLANGE W/ 2.25" MALE BALL
 Outlet B: LOOSE 2-BOLT FLANGE W/ 2.25" MALE BALL
 Length: 54"

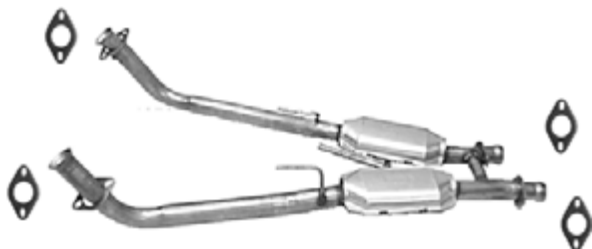

1993-86 8 FORD MUSTANG 5.0L
 1986 8 MERCURY CAPRI 5.0L

642904

Inlet A: WELDED 2-BOLT FLANGE
 Outlet A: WELDED 2-BOLT FLANGE
 Length: 52"



1988-85 3 CHEVROLET SPRINT All
 1994-89 3 GEO METRO All
 1991-85 3 PONTIAC FIREFLY 1.0L
 1994-89 4 SUZUKI SWIFT 1.3L

642910

Inlet A: 2.25" O.D. PIPE
 Outlet A: 2" O.D. PIPE
 Length: 55.50"



1989-87 6 DODGE DAKOTA 3.9L

642912

Inlet A: 2.50" I.D. PIPE
 Outlet A: 2.50" O.D. PIPE
 Length: 59"



1995-94 6 DODGE DAKOTA 3.9L
 1995-94 8 DODGE DAKOTA 5.2L

642913

Inlet A: LOOSE 2-BOLT FLANGE W/ FEMALE FLARE
 Outlet A: LOOSE 2-BOLT FLANGE W/ 2" MALE BALL
 Length: 51.25"



1993-87 4 FORD MUSTANG 2.3L

642915

Inlet A: LOOSE 2-BOLT FLANGE W/ FEMALE FLARE
 Inlet B: LOOSE 2-BOLT FLANGE W/ FEMALE FLARE
 Outlet A: 2.25" O.D. PIPE
 Length: 51.25"

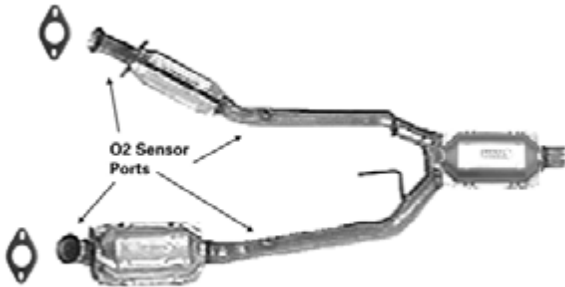

1995-94 8 FORD THUNDERBIRD 4.6L
 1995-94 8 MERCURY COUGAR 4.6L

642916

Inlet A: LOOSE 2-BOLT FLANGE W/ 2.50" FEMALE FLARE
 Inlet B: LOOSE 2-BOLT FLANGE W/ 2.50" FEMALE FLARE
 Outlet A: LOOSE 2-BOLT FLANGE W/ 2.50" MALE BALL
 Outlet B: LOOSE 2-BOLT FLANGE W/ 2.50" MALE BALL
 Length: 55"

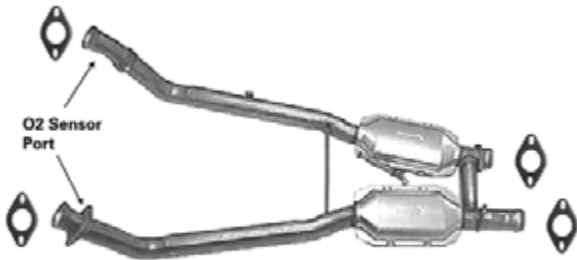

1995-94 8 FORD MUSTANG 5.0L

642917

Inlet A: WELDED 2-BOLT FLANGE
 Outlet A: WELDED 2-BOLT FLANGE
 Length: 51.25"



1991-89 3 CHEVROLET SPRINT All
 1995 3 GEO METRO 1.0L
 1995 3 PONTIAC FIREFLY 1.0L
 1992-89 4 SUZUKI SWIFT 1.3L

642919

Inlet A: 2.25" O.D. PIPE
 Outlet A: 2.25" O.D. PIPE
 Length: 57"



1989-87 6 DODGE DAKOTA 3.9L

642920

Inlet A: LOOSE 2-BOLT FLANGE W/ SPECIAL FLARE
 Outlet A: 2.25" O.D. PIPE
 Length: 57.50"



1996 6 CHEVROLET LUMINA APV 3.4L
 1996 6 OLDSMOBILE SILHOUETTE 3.4L
 1996 6 PONTIAC TRANS SPORT 3.4L

642921

Inlet A: WELDED 2-BOLT FLANGE
 Outlet A: WELDED 4-BOLT FLANGE
 Length: 67.25"



1996-93 4 BUICK CENTURY 2.2L
 1996-93 4 OLDSMOBILE CIERA 2.2L

642922

Inlet A: LOOSE 2-BOLT FLANGE W/ FEMALE FLARE
 Inlet B: LOOSE 2-BOLT FLANGE W/ FEMALE FLARE
 Outlet A: 2.25" O.D. PIPE
 Length: 51.50"

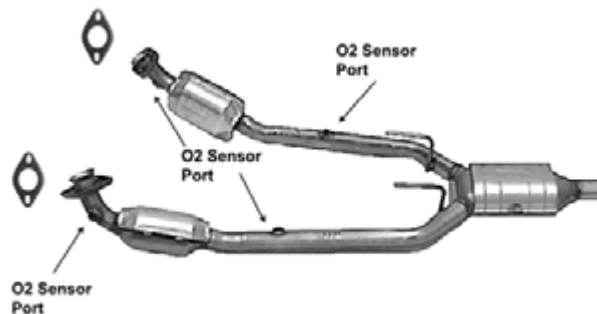

1997-96 6 FORD THUNDERBIRD 3.8L

DIRECT FIT



642922 (cont.)

1997-96 6 MERCURY COUGAR 3.8L

642924

Inlet A: WELDED 2-BOLT FLANGE W/ GASKET STUB
 Outlet A: WELDED 3-BOLT FLANGE W/ GASKET STUB
 Length: 58.88"



2002-99 4 CHEVROLET CAVALIER 2.2L
 2002-99 4 PONTIAC SUNFIRE 2.2L

642925

Inlet A: LOOSE 2-BOLT FLANGE W/ FEMALE FLARE
 Outlet A: LOOSE 2-BOLT FLANGE W/ MALE BALL
 Length: 55"

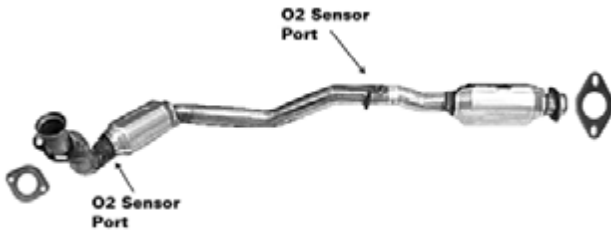

2000-98 8 FORD EXPLORER 5.0L
 2000-98 8 MERCURY MOUNTAINEER 5.0L

642926

Inlet A: LOOSE 2-BOLT FLANGE W/ FEMALE FLARE
 Outlet A: 2.50" O.D. PIPE
 Length: 49.75"

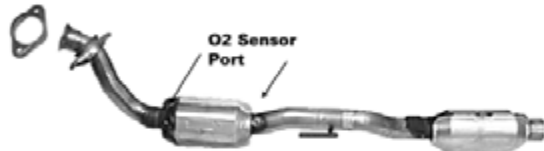

2000-98 8 FORD EXPLORER 5.0L
 2000-98 8 MERCURY MOUNTAINEER 5.0L

642927

Inlet A: WELDED 2-BOLT FLANGE W/ 2.25" FEMALE FLARE
 Inlet B: LOOSE 2-BOLT FLANGE W/ 2.25" FEMALE FLARE
 Outlet A: WELDED 2-BOLT FLANGE W/ 2.25" MALE BALL
 Outlet B: WELDED 2-BOLT FLANGE W/ 2.25" MALE BALL
 Length: 53.75"

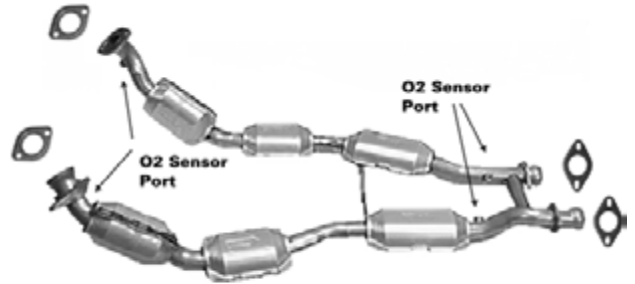

1998-96 8 FORD MUSTANG 4.6L

642928

Inlet A: WELDED 3-BOLT FLANGE
 Inlet B: WELDED 3-BOLT FLANGE
 Outlet A: WELDED 2-BOLT FLANGE W/ GASKET STUB
 Length: 51.50"



1994-90 4 SUBARU LEGACY 2.2L

642930

Inlet A: WELDED 2-BOLT FLANGE W/ GASKET STUB
 Inlet B: WELDED 2-BOLT FLANGE W/ GASKET STUB
 Outlet A: WELDED 2-BOLT FLANGE W/ GASKET STUB
 Length: 49"



1999-97 6 LEXUS ES300 3.0L
 1999-97 6 TOYOTA AVALON 3.0L
 2000-97 6 TOYOTA CAMRY, (Inc. 1998 & Older SOLARA) 3.0L
 2003-99 6 TOYOTA SOLARA 3.0L

642931

Inlet A: LOOSE 2-BOLT FLANGE W/ FEMALE FLARE
Outlet A: 1.75" PIPE W/ SPECIAL RING
Length: 109"

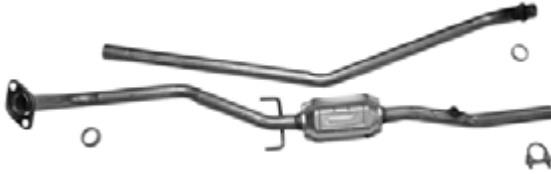

1999-96 4 TOYOTA PASEO 1.5L
1997-95 4 TOYOTA TERCEL 1.5L

642932

Inlet A: LOOSE 2-BOLT FLANGE W/ CHRYSLER FLARE
Outlet A: 2.25" O.D. PIPE
Length: 72"



1993-92 6 CHRYSLER TOWN & COUNTRY 3.3L
1995-94 6 CHRYSLER TOWN & COUNTRY 3.8L
1994-91 6 DODGE CARAVAN 3.3L
1995-94 6 DODGE CARAVAN 3.8L
1995-91 6 PLYMOUTH VOYAGER 3.3L
1995-94 6 PLYMOUTH VOYAGER 3.8L

642933

Inlet A: LOOSE 2-BOLT FLANGE W/ FEMALE FLARE
Inlet B: LOOSE 2-BOLT FLANGE W/ FEMALE FLARE
Outlet A: 2.25" O.D. PIPE
Length: 54.50"

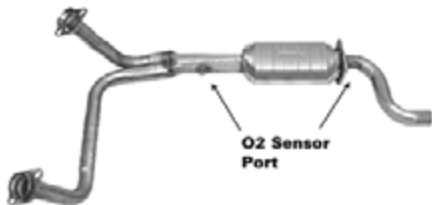

1999-95 6 CHEVROLET CAMARO 3.8L
1999-95 6 PONTIAC FIREBIRD, TRANS AM, FORMULA 3.8L

642934

Inlet A: WELDED 2-BOLT FLANGE
Outlet A: WELDED 2-BOLT FLANGE W/ GASKET STUB
Length: 54.25"

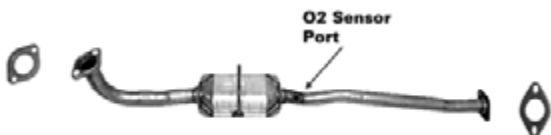

1996 3 GEO METRO 1.0L

642934 (cont.)

1997-96 4 PONTIAC FIREFLY 1.3L

642936

Inlet A: WELDED 1.75" 2-BOLT FLANGE
Inlet B: WELDED 1.75" 2-BOLT FLANGE
Outlet A: WELDED 2-BOLT FLANGE W/ GASKET STUB
Length: 48"



1989-85 4 SUBARU HATCHBACK 1.8L
1994-90 4 SUBARU LOYALE 1.8L
1989-85 4 SUBARU SEDAN - 4 Dr. 1.8L
1989-85 4 SUBARU STATION WAGON 1.8L
1990-85 4 SUBARU XT 1.8L

642938

Inlet A: WELDED 3-BOLT FLANGE
Inlet B: LOOSE 3-BOLT FLANGE W/ 45 DEGREE FLARE
Outlet A: LOOSE 3-BOLT FLANGE W/ 45 DEGREE FLARE
Length: 48.63"

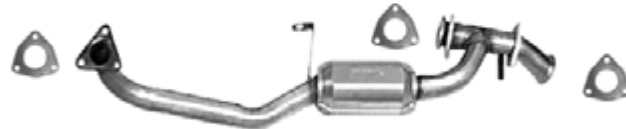

1994-92 6 AUDI 100 2.8L

642939

Inlet A: SPHERICAL FLARE
Outlet A: WELDED 2-BOLT FLANGE
Length: 95.25"

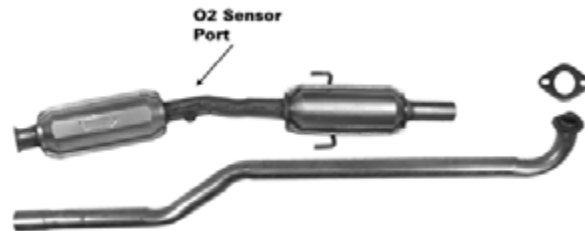

2002-98 4 CHEVROLET PRIZM 1.8L
2002-98 4 TOYOTA COROLLA 1.8L

DIRECT FIT



642940

Inlet A: WELDED 3-BOLT FLANGE W/ GASKET STUB
 Outlet A: WELDED 2-BOLT FLANGE W/ GASKET STUB
 Length: 50.50"



- 2001-97 4 TOYOTA CAMRY, (Inc. 1998 & Older SOLARA) 2.2L
- 2001-99 4 TOYOTA SOLARA 2.2L

642941

Inlet A: WELDED 2-BOLT FLANGE
 Outlet A: WELDED 2-BOLT FLANGE
 Length: 64.25"

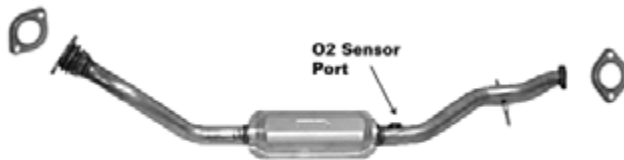

- 2000-97 6 CHEVROLET VENTURE 3.4L
- 2000-97 6 OLDSMOBILE SILHOUETTE 3.4L
- 2000-99 6 PONTIAC MONTANA 3.4L
- 1998-97 6 PONTIAC TRANS SPORT 3.4L

642942

Inlet A: LOOSE 2-BOLT FLANGE W/ SPHERICAL FLARE
 Inlet B: LOOSE 2-BOLT FLANGE W/ SPHERICAL FLARE
 Outlet A: LOOSE 2-BOLT FLANGE W/ 2.65" MALE BALL
 Length: 56"

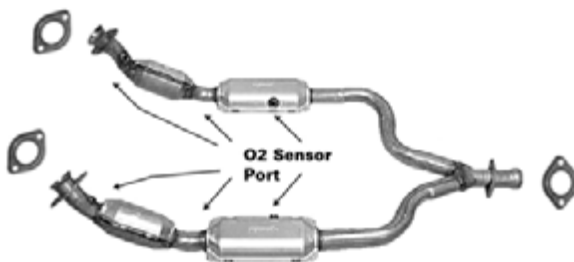

- 2004-99 6 FORD MUSTANG 3.8L
- 2004 6 FORD MUSTANG 3.9L

642943

Inlet A: LOOSE 2-BOLT FLANGE W/ FEMALE FLARE
 Inlet B: LOOSE 2-BOLT FLANGE W/ FEMALE FLARE
 Outlet A: LOOSE 2-BOLT FLANGE W/ 2.50" MALE BALL
 Length: 60.50"

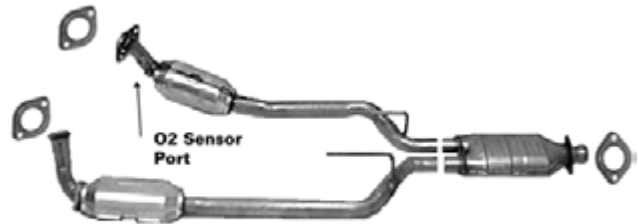

- 1993-89 6 FORD THUNDERBIRD 3.8L

642944

Inlet A: LOOSE 2-BOLT FLANGE W/ 2.25" FEMALE FLARE
 Inlet B: LOOSE 2-BOLT FLANGE W/ 2.25" FEMALE FLARE
 Outlet A: LOOSE 2-BOLT FLANGE W/ MALE BALL
 Outlet B: 2" O.D. PIPE
 Length: 62.75"

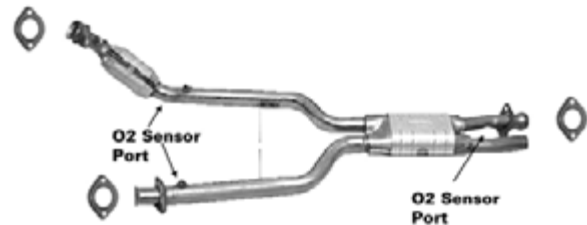

- 1998-93 8 LINCOLN MARK Series 4.6L

642947

Inlet A: LOOSE 2-BOLT FLANGE W/ FEMALE FLARE
 Outlet A: WELDED 2-BOLT FLANGE W/ GASKET STUB
 Length: 55.50"



- 1994-90 4 SUBARU LEGACY 2.2L

642948

Inlet A: LOOSE 2-BOLT FLANGE W/ FEMALE FLARE
 Outlet A: 2.25" O.D. PIPE
 Length: 54.38"



- 1995-93 6 CHEVROLET LUMINA APV 3.8L

642948 (cont.)

1995-93 6 OLDSMOBILE SILHOUETTE 3.8L
1995-93 6 PONTIAC TRANS SPORT 3.8L

642949

Inlet A: WELDED 2-BOLT FLANGE
Outlet A: WELDED 4-BOLT FLANGE
Length: 46.38"

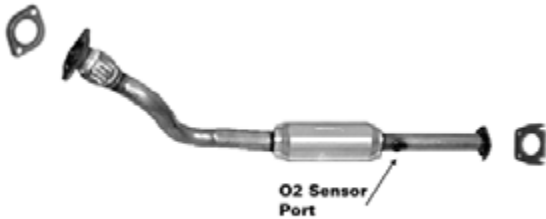

2001-97 6 CHEVROLET LUMINA 3.1L
1999-97 6 CHEVROLET MONTE CARLO 3.1L
1997 6 OLDSMOBILE CUTLASS 3.1L

642950

Inlet A: LOOSE 2-BOLT FLANGE W/ FEMALE FLARE
Inlet B: LOOSE 2-BOLT FLANGE W/ FEMALE FLARE
Outlet A: LOOSE 2-BOLT FLANGE W/ MALE BALL
Length: 60.50"

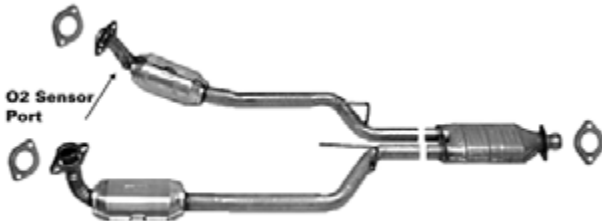

1995-92 6 FORD THUNDERBIRD 3.8L
1995-92 6 MERCURY COUGAR 3.8L

642951

Inlet A: WELDED 4-BOLT FLANGE
Outlet A: 2.25" O.D. PIPE
Length: 68"

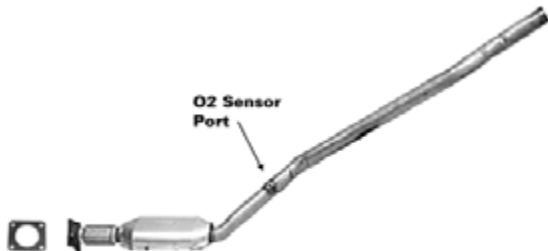

2000 6 CHRYSLER VOYAGER, GRAND VOYAGER 3.0L
2000-96 6 DODGE CARAVAN 3.0L
2000-96 6 PLYMOUTH VOYAGER 3.0L

642953

Inlet A: WELDED 2-BOLT FLANGE
Outlet A: WELDED 2-BOLT FLANGE
Length: 68.25"

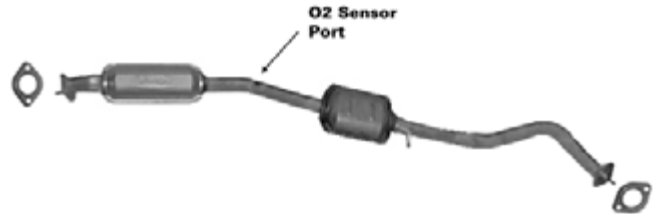

2002-99 4 MAZDA MIATA, MX5 1.8L

642954

Inlet A: LOOSE 2-BOLT FLANGE W/ FEMALE FLARE
Outlet A: WELDED 4-BOLT FLANGE
Length: 65.25"



1992-86 4 BUICK CENTURY 2.5L
1990-86 4 CHEVROLET CELEBRITY 2.5L
1992-86 4 OLDSMOBILE CIERA 2.5L
1991-86 4 PONTIAC 6000 2.5L

642956

Inlet A: WELDED 4-BOLT FLANGE
Outlet A: LOOSE 2-BOLT FLANGE W/ SPECIAL BALL
Length: 56"

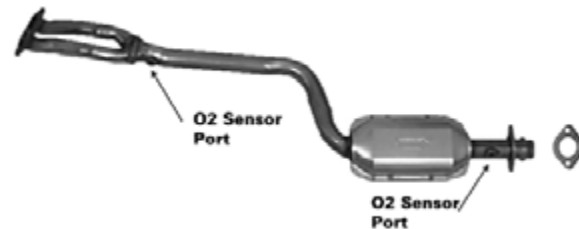

1998-96 4 BMW 318 1.9L

642957

Inlet A: WELDED 2-BOLT FLANGE
Outlet A: WELDED 2-BOLT FLANGE W/ GASKET STUB
Length: 51.13"



2000-98 3 CHEVROLET METRO 1.0L
2000-98 4 CHEVROLET METRO 1.3L

DIRECT FIT



642957 (cont.)

1997-96 3 GEO METRO 1.0L
 1997-96 4 GEO METRO 1.3L

642958

Inlet A: LOOSE 2-BOLT FLANGE W/ FEMALE FLARE
 Inlet B: LOOSE 2-BOLT FLANGE W/ FEMALE FLARE
 Outlet A: 2.25" O.D. PIPE
 Length: 50.63"

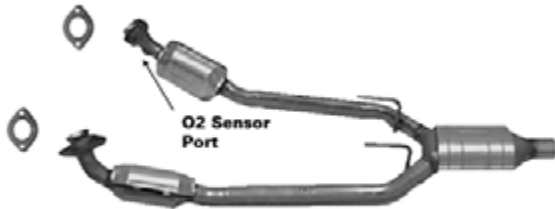

1993-91 8 FORD THUNDERBIRD 5.0L
 1993-91 8 MERCURY COUGAR 5.0L

642961

Inlet A: LOOSE 2-BOLT FLANGE W/ FEMALE FLARE
 Inlet B: LOOSE 2-BOLT FLANGE W/ FEMALE FLARE
 Outlet A: 2.25" O.D. PIPE
 Length: 51.50"



1997-96 8 FORD THUNDERBIRD 4.6L
 1997-96 8 MERCURY COUGAR 4.6L

642962

Inlet A: WELDED 2-BOLT FLANGE
 Inlet B: LOOSE 3-BOLT FLANGE W/ 45 DEGREE FLARE
 Outlet A: WELDED 2-BOLT FLANGE
 Length: 54.50"



2003-99 6 SAAB 9-5 3.0L

642963

Inlet A: WELDED 3-BOLT FLANGE
 Outlet A: 2.7" MALE BALL
 Length: 50.50"



1996-94 5 VOLVO 850 2.3L

642964

Inlet A: WELDED 3-BOLT FLANGE
 Outlet A: WELDED 3-BOLT FLANGE
 Length: 54.50"



2002-99 4 DAEWOO NUBIRA 2.0L

642965

Inlet A: 2-BOLT FLANGE W/ FEMALE FLARE
 Inlet B: 2-BOLT FLANGE W/ FEMALE FLARE
 Outlet A: LOOSE 2-BOLT FLANGE W/ 2.25" MALE BALL
 Length: 56.88"



1998-96 6 FORD MUSTANG 3.8L

642966

Inlet A: WELDED 2-BOLT FLANGE
 Inlet B: WELDED 2-BOLT FLANGE
 Outlet A: 1.88" O.D. PIPE
 Length: 53.00"



2006-01 6 HYUNDAI SANTA FE 2.7L

642967

Inlet A: WELDED 4-BOLT FLANGE
Outlet A: 2.25" O.D. PIPE
Length: 70.25"



- 2000-96 6 CHRYSLER TOWN & COUNTRY 3.3L
- 2000-96 6 CHRYSLER TOWN & COUNTRY 3.8L
- 2000 6 CHRYSLER VOYAGER, GRAND VOYAGER 3.3L
- 2000-96 6 DODGE CARAVAN 3.3L
- 2000-96 6 DODGE CARAVAN 3.8L
- 1999-96 6 PLYMOUTH VOYAGER 3.8L
- 2000-96 6 PLYMOUTH VOYAGER 3.3L

642969

Inlet A: WELDED 4-BOLT FLANGE
Outlet A: 2.25" O.D. PIPE
Length: 71"



- 2000-96 6 CHRYSLER TOWN & COUNTRY 3.3L
- 2000-96 6 CHRYSLER TOWN & COUNTRY 3.8L
- 2000 4 CHRYSLER VOYAGER, GRAND VOYAGER 2.4L
- 2000 6 CHRYSLER VOYAGER, GRAND VOYAGER 3.3L
- 2000-96 4 DODGE CARAVAN 2.4L
- 2000-96 6 DODGE CARAVAN 3.3L
- 2000-96 6 DODGE CARAVAN 3.8L
- 1999-96 6 PLYMOUTH VOYAGER 3.8L
- 2000-96 4 PLYMOUTH VOYAGER 2.4L
- 2000-96 6 PLYMOUTH VOYAGER 3.3L

642970

Inlet A: WELDED 2-BOLT FLANGE
Inlet B: WELDED 3-BOLT FLANGE W/ GASKET STUB
Outlet A: WELDED 2-BOLT FLANGE
Length: 49.50"



- 1997-96 6 HONDA PASSPORT 3.2L

642970 (cont.)

- 1997-96 6 ISUZU RODEO 3.2L

642971

Inlet A: LOOSE 2-BOLT FLANGE W/ SPHERICAL FLARE
Outlet A: WELDED 4-BOLT FLANGE
Length: 49"



- 1996-94 6 BUICK CENTURY 3.1L
- 1996-94 6 OLDSMOBILE CIERA 3.1L

642972

Inlet A: LOOSE 2-BOLT FLANGE W/ SPHERICAL FLARE
Outlet A: 2.25" O.D. PIPE
Length: 58.38"



- 1995-93 6 CHEVROLET LUMINA APV 3.1L
- 1994-93 6 OLDSMOBILE SILHOUETTE 3.1L
- 1995-93 6 PONTIAC TRANS SPORT 3.1L

642973

Inlet A: 2-BOLT FLANGE
Outlet A: 2.13" O.D. PIPE
Length: 59.63"



- 2002-98 6 MERCEDES-BENZ ML320 3.2L

642974

Inlet A: 2-BOLT FLANGE
Outlet A: 2.13" O.D. PIPE
Length: 60.25"

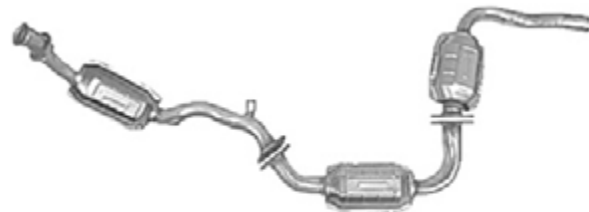

- 2002-98 6 MERCEDES-BENZ ML320 3.2L

DIRECT FIT



642975

Inlet A: LOOSE 2-BOLT FLANGE W/ SPHERICAL FLARE
 Outlet A: 2.25" O.D. PIPE
 Length: 48.25"



2002-00 8 JAGUAR S-TYPE 4.0L
 2001-00 8 LINCOLN LS 3.9L

642976

Inlet A: WELDED 3-BOLT FLANGE
 Outlet A: 2" O.D. PIPE
 Length: 50"



2001-00 6 AUDI A6 2.8L
 2001-00 8 AUDI A6 4.2L
 2005-00 6 VOLKSWAGEN PASSAT 2.8L

642977

Inlet A: WELDED 3-BOLT FLANGE
 Outlet A: 2" O.D. PIPE
 Length: 51.25"



2001-00 6 AUDI A6 2.8L
 2001-00 8 AUDI A6 4.2L
 2005-00 6 VOLKSWAGEN PASSAT 2.8L

642978

Inlet A: WELDED 4-BOLT FLANGE
 Outlet A: 1.965" O.D. PIPE
 Length: 50.25"



2002-00 6 AUDI A6 2.7L
 2002-01 6 AUDI ALL ROAD 2.7L

642979

Inlet A: WELDED 4-BOLT FLANGE
 Outlet A: 2.50" O.D. PIPE
 Length: 72"



2007-05 6 CHRYSLER TOWN & COUNTRY 3.3L
 2007-05 6 CHRYSLER TOWN & COUNTRY 3.8L
 2007-05 6 DODGE CARAVAN 3.3L
 2007-05 6 DODGE CARAVAN 3.8L

642980

Inlet A: WELDED 2-BOLT FLANGE W/ SPHERICAL FLARE
 Inlet B: WELDED 2-BOLT FLANGE W/ SPHERICAL FLARE
 Outlet A: WELDED 2-BOLT FLANGE
 Length: 49"



2001-99 6 HYUNDAI SONATA 2.5L

642981

Inlet A: WELDED 2-BOLT FLANGE W/ SPHERICAL FLARE
 Outlet A: WELDED 2-BOLT FLANGE
 Length: 59"



2005-02 6 BUICK RENDEZVOUS 3.4L
 2005-01 6 PONTIAC AZTEK 3.4L

642982

Inlet A: LOOSE 2-BOLT FLANGE W/ SPHERICAL FLARE
 Inlet B: LOOSE 2-BOLT FLANGE W/ SPHERICAL FLARE
 Outlet A: 1.965" O.D. PIPE
 Outlet B: 1.965" O.D. PIPE
 Length: 54.50"



2005-04 8 FORD THUNDERBIRD 3.9L
 2004 8 LINCOLN LS 3.9L

642983

Inlet A: WELDED 2-BOLT FLANGE W/ GASKET STUB
 Outlet A: LOOSE 2-BOLT FLANGE W/ MALE BALL
 Length: 48.50"



2001-97 6 CADILLAC CATERA 3.0L

642984

Inlet A: WELDED 2-BOLT FLANGE W/ GASKET STUB
 Outlet A: LOOSE 2-BOLT FLANGE W/ MALE BALL
 Length: 49"

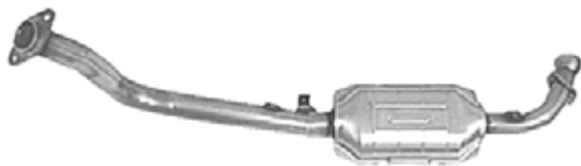

2001-97 6 CADILLAC CATERA 3.0L

642985

Inlet A: WELDED 2-BOLT FLANGE W/ SPHERICAL FLARE
 Outlet A: LOOSE 2-BOLT FLANGE W/ GASKET STUB
 Length: 87.50"

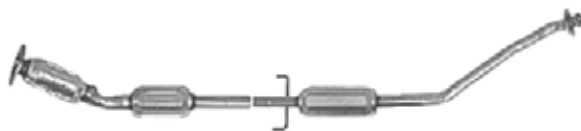

2004-03 4 PONTIAC VIBE 1.8L
 2004-03 4 TOYOTA COROLLA 1.8L
 2004-03 4 TOYOTA MATRIX 1.8L

642986

Inlet A: WELDED 3-BOLT FLANGE
 Outlet A: WELDED 2-BOLT FLANGE
 Length: 48.25"



2005-99 4 HYUNDAI SONATA 2.4L
 2006-01 4 KIA OPTIMA 2.4L

642987

Inlet A: WELDED 2-BOLT FLANGE
 Inlet B: WELDED 2-BOLT FLANGE
 Outlet A: WELDED 2-BOLT FLANGE
 Length: 54.25"



2005-01 6 CHRYSLER SEBRING 3.0L
 2005-01 6 DODGE STRATUS 3.0L
 2005-00 6 MITSUBISHI ECLIPSE 3.0L
 2003-99 6 MITSUBISHI GALANT 3.0L

642988

Inlet A: WELDED 2-BOLT FLANGE
 Outlet A: WELDED 2-BOLT FLANGE
 Length: 60"



2005-02 6 CHEVROLET VENTURE 3.4L
 2004-02 6 OLDSMOBILE SILHOUETTE 3.4L
 2005-02 6 PONTIAC MONTANA 3.4L

642989

Inlet A: WELDED 3-BOLT FLANGE
 Outlet A: 1.88" O.D. PIPE
 Length: 50.50"



2004-01 4 HYUNDAI SANTA FE 2.4L

DIRECT FIT



642990

Inlet A: WELDED 2-BOLT FLANGE
 Outlet A: WELDED 2-BOLT FLANGE W/ GASKET STUB
 Length: 94.50"

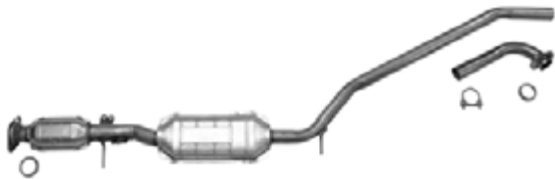

2003-01 6 TOYOTA HIGHLANDER 3.0L

642991

Inlet A: WELDED 4-BOLT FLANGE
 Outlet A: 2.50" O.D. PIPE
 Length: 72"



2004-01 6 CHRYSLER TOWN & COUNTRY 3.8L
 2004-01 6 DODGE CARAVAN 3.8L

642992

Inlet A: WELDED 4-BOLT FLANGE
 Outlet A: 2.25" O.D. PIPE
 Length: 72"



2007-01 6 CHRYSLER TOWN & COUNTRY 3.3L
 2003-01 6 CHRYSLER VOYAGER, GRAND VOYAGER 3.3L
 2007-01 6 DODGE CARAVAN 3.3L

642993

Inlet A: WELDED 2-BOLT FLANGE W/ GASKET STUB
 Inlet B: WELDED 2-BOLT FLANGE W/ GASKET STUB
 Outlet A: WELDED 2-BOLT FLANGE
 Length: 49.50"



1998-96 6 LEXUS ES300 3.0L
 1999-96 6 TOYOTA AVALON 3.0L
 2001-96 6 TOYOTA CAMRY, (Inc. 1998 & Older SOLARA) 3.0L
 2002-99 6 TOYOTA SOLARA 3.0L

642994

Inlet A: LOOSE 2-BOLT FLANGE W/ FEMALE FLARE
 Inlet B: LOOSE 2-BOLT FLANGE W/ FEMALE FLARE
 Outlet A: 2.25" O.D. PIPE
 Length: 51.75"

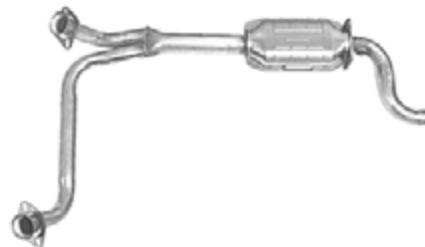

2002-00 6 CHEVROLET CAMARO 3.8L
 2001-00 6 PONTIAC FIREBIRD, TRANS AM, FORMULA 3.8L

642995

Inlet A: LOOSE 2-BOLT FLANGE W/ 45 DEGREE FLARE
 Outlet A: 2.165" O.D. PIPE
 Length: 64.75"



2003-00 8 MERCEDES-BENZ CL500 5.0L
 2002-00 8 MERCEDES-BENZ S430 4.3L
 2002-00 8 MERCEDES-BENZ S500 5.0L

642996

Inlet A: LOOSE 2-BOLT FLANGE W/ 45 DEGREE FLARE
 Outlet A: LOOSE 2-BOLT FLANGE W/ 45 DEGREE FLARE
 Length: 61.50"



2003-00 8 MERCEDES-BENZ CL500 5.0L
 2002-00 8 MERCEDES-BENZ S430 4.3L
 2002-00 8 MERCEDES-BENZ S500 5.0L

642997

Inlet A: WELDED 3-BOLT FLANGE
 Outlet A: 2.50" MALE BALL
 Length: 57.75"



2000 5 VOLVO S70/V70 2.3L
 2000 5 VOLVO S70/V70 2.4L

642998

Inlet A: LOOSE 2-BOLT FLANGE W/ 45 DEGREE FLARE
Outlet A: 2.165" O.D. PIPE
Length: 67"



2002-98 6 MERCEDES-BENZ E320 3.2L

642999

Inlet A: LOOSE 2-BOLT FLANGE W/ 45 DEGREE FLARE
Outlet A: LOOSE 2-BOLT FLANGE W/ 45 DEGREE FLARE
Length: 64.75"



2002-98 6 MERCEDES-BENZ E320 3.2L

643000

Inlet A: WELDED 3-BOLT FLANGE
Outlet A: WELDED 3-BOLT FLANGE
Length: 53.63"



2002-99 4 DAEWOO LEGANZA 2.2L

643001

Inlet A: WELDED 2-BOLT FLANGE W/ GASKET STUB
Outlet A: WELDED 2-BOLT FLANGE W/ GASKET STUB
Length: 49"



2009-02 4 TOYOTA CAMRY, (Inc. 1998 & Older SOLARA) 2.4L
2008-02 4 TOYOTA SOLARA 2.4L

643002

Inlet A: WELDED 2-BOLT FLANGE W/ GASKET STUB
Inlet B: LOOSE 2-BOLT FLANGE W/ SPHERICAL FLARE
Outlet A: LOOSE 2-BOLT FLANGE W/ MALE BALL
Outlet B: LOOSE 2-BOLT FLANGE W/ MALE BALL
Length: 53.75"

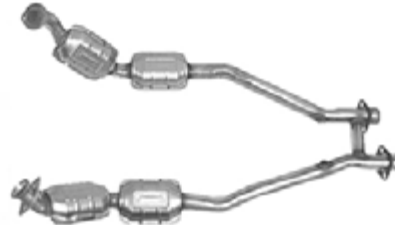

2003-99 8 FORD MUSTANG 4.6L

643003

Inlet A: WELDED 3-BOLT FLANGE W/ GASKET STUB
Outlet A: WELDED 2-BOLT FLANGE
Length: 50.50"



2006-03 4 NISSAN SENTRA 1.8L

643004

Inlet A: LOOSE 2-BOLT FLANGE W/ SPHERICAL FLARE
Inlet B: LOOSE 2-BOLT FLANGE W/ SPHERICAL FLARE
Outlet A: 2.50" O.D. PIPE
Length: 53.88"

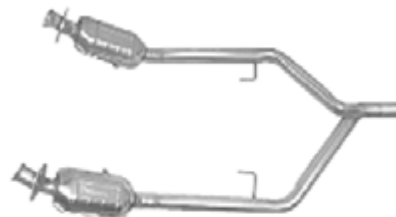

2010-05 6 FORD MUSTANG 4.0L

643006

Inlet A: WELDED 2-BOLT FLANGE
Outlet A: SPHERICAL RING
Length: 77.25"



2006-04 4 SCION XA 1.5L

DIRECT FIT



643006 (cont.)

2005-00 4 TOYOTA ECHO 1.5L

643007

Inlet A: WELDED 2-BOLT FLANGE
 Outlet A: WELDED 2-BOLT FLANGE
 Length: 65"



2001 6 CHEVROLET VENTURE 3.4L
 2001 6 OLDSMOBILE SILHOUETTE 3.4L
 2001 6 PONTIAC MONTANA 3.4L

643008

Inlet A: LOOSE 2-BOLT FLANGE W/ FEMALE FLARE
 Inlet B: LOOSE 2-BOLT FLANGE W/ FEMALE FLARE
 Outlet A: 2.50" O.D. PIPE
 Outlet B: 2.50" O.D. PIPE
 Length: 50.50"

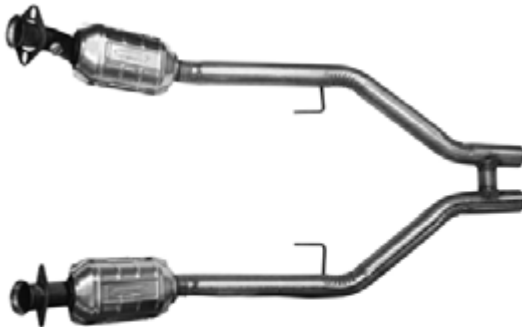

2007-05 8 FORD MUSTANG 4.6L

643009

Inlet A: WELDED 2-BOLT FLANGE
 Outlet A: 2.25" O.D. PIPE
 Length: 52.50"



2010-05 6 CHRYSLER 300 2.7L
 2010-05 6 CHRYSLER 300 3.5L
 2010-09 6 DODGE CHALLENGER 3.5L
 2010-06 6 DODGE CHARGER 2.7L
 2010-06 6 DODGE CHARGER 3.5L
 2008-05 6 DODGE MAGNUM 2.7L
 2008-05 6 DODGE MAGNUM 3.5L

643010

Inlet A: WELDED 2-BOLT FLANGE
 Outlet A: 2.25" O.D. PIPE
 Length: 52.50"



2010-05 6 CHRYSLER 300 2.7L
 2010-05 6 CHRYSLER 300 3.5L
 2010-09 6 DODGE CHALLENGER 3.5L
 2010-06 6 DODGE CHARGER 2.7L
 2010-06 6 DODGE CHARGER 3.5L
 2008-05 6 DODGE MAGNUM 2.7L
 2008-05 6 DODGE MAGNUM 3.5L

643011

Inlet A: WELDED 2-BOLT FLANGE
 Outlet A: WELDED 2-BOLT FLANGE
 Length: 52.63"



2005-01 4 CHRYSLER SEBRING 2.4L
 2005-01 4 DODGE STRATUS 2.4L
 2005-00 4 MITSUBISHI ECLIPSE 2.4L
 2003-00 4 MITSUBISHI GALANT 2.4L

643013

Inlet A: WELDED 2-BOLT FLANGE
 Outlet A: WELDED 2-BOLT FLANGE W/ GASKET STUB
 Length: 103.50"



2004-00 6 TOYOTA AVALON 3.0L

643014

Inlet A: WELDED 2-BOLT FLANGE
 Inlet B: WELDED 2-BOLT FLANGE
 Outlet A: WELDED 2-BOLT FLANGE
 Length: 49.75"



2003-02 6 LEXUS ES300 3.0L

643014 (cont.)

- 2006-04 6 LEXUS ES330 3.3L
- 2006-02 6 TOYOTA CAMRY, (Inc. 1998 & Older SOLARA) 3.0L
- 2006-04 6 TOYOTA CAMRY, (Inc. 1998 & Older SOLARA) 3.3L
- 2008-04 6 TOYOTA SOLARA 3.3L

643015

Inlet A: WELDED 2-BOLT FLANGE
 Inlet B: WELDED 2-BOLT FLANGE
 Outlet A: WELDED 2-BOLT FLANGE
 Length: 51.25"



- 2002-97 6 TOYOTA CAMRY, (Inc. 1998 & Older SOLARA) 3.0L

643016

Inlet A: LOOSE 2-BOLT FLANGE W/ FLARE
 Inlet B: LOOSE 2-BOLT FLANGE W/ FLARE
 Outlet A: LOOSE 3-BOLT FLANGE W/ FLARE
 Length: 59.50"



- 2008-04 6 CHRYSLER CROSSFIRE 3.2L
- 2004-01 6 MERCEDES-BENZ SLK320 3.2L

643017

Inlet A: WELDED 2-BOLT FLANGE
 Outlet A: WELDED 2-BOLT FLANGE
 Length: 60.50"



- 2006-05 6 BUICK TERRAZA 3.5L
- 2006-05 6 CHEVROLET UPLANDER 3.5L
- 2006-05 6 PONTIAC MONTANA 3.5L
- 2006-05 6 SATURN RELAY 3.5L
- 2006 6 SATURN RELAY 3.9L

643018

Inlet A: WELDED 2-BOLT FLANGE
 Outlet A: 2-1/2" O.D. PIPE
 Length: 48.75"



- 2007-05 8 CHRYSLER 300 5.7L
- 2007-06 8 DODGE CHARGER 5.7L
- 2007-05 8 DODGE MAGNUM 5.7L

643019

Inlet A: WELDED 2-BOLT FLANGE
 Outlet A: 2-1/2" O.D. PIPE
 Length: 49.75"



- 2007-05 8 CHRYSLER 300 5.7L
- 2007-06 8 DODGE CHARGER 5.7L
- 2007-05 8 DODGE MAGNUM 5.7L

643020

Inlet A: WELDED 3-BOLT FLANGE W/ GASKET STUB
 Outlet A: WELDED 2-BOLT FLANGE
 Length: 54"



- 2000-99 4 MITSUBISHI GALANT 2.4L

643021

Inlet A: WELDED 2-BOLT FLANGE
 Outlet A: WELDED 2-BOLT FLANGE W/ GASKET STUB
 Length: 101.50"



- 2001-99 6 LEXUS ES300 3.0L

DIRECT FIT



643022

Inlet A: WELDED 3-BOLT FLANGE
 Outlet A: 1.965" O.D. PIPE
 Length: 49.25"



- 1999-97 6 AUDI A4 2.8L
- 1999-98 6 AUDI A6 2.8L
- 1999-98 6 VOLKSWAGEN PASSAT 2.8L

643023

Inlet A: WELDED 3-BOLT FLANGE
 Outlet A: 1.965" O.D. PIPE
 Length: 62.75"



- 1999-97 6 AUDI A4 2.8L

643024

Inlet A: LOOSE 2-BOLT FLANGE W/ SPHERICAL FLARE
 Inlet B: LOOSE 2-BOLT FLANGE W/ SPHERICAL FLARE
 Outlet A: 2.165" O.D. PIPE
 Length: 52.75"



- 1998-97 8 BMW 540 4.4L
- 1998-96 8 BMW 740 4.4L

643025

Inlet A: LOOSE 2-BOLT FLANGE W/ SPHERICAL FLARE
 Inlet B: LOOSE 2-BOLT FLANGE W/ SPHERICAL FLARE
 Outlet A: 2.165" O.D. PIPE
 Length: 52.75"



- 1998-97 8 BMW 540 4.4L
- 1998-96 8 BMW 740 4.4L

643026

Inlet A: LOOSE 2-BOLT FLANGE W/ SPHERICAL FLARE
 Outlet A: 2.25" O.D. PIPE
 Length: 47.88"



- 2002-00 6 JAGUAR S-TYPE 3.0L
- 2005-00 6 LINCOLN LS 3.0L

643027

Inlet A: WELDED 3-BOLT FLANGE
 Outlet A: 1.965" O.D. PIPE
 Length: 50.25"



- 1999-98 6 AUDI A6 2.8L
- 1999-98 6 VOLKSWAGEN PASSAT 2.8L

643028

Inlet A: WELDED 3-BOLT FLANGE
 Outlet A: WELDED 2-BOLT FLANGE W/ GASKET STUB
 Length: 53.50"



- 2008-06 4 SUBARU FORESTER 2.5L
- 2007-06 4 SUBARU IMPREZA 2.5L

643029

Inlet A: WELDED 2-BOLT FLANGE
 Outlet A: WELDED 2-BOLT FLANGE
 Length: 57.75"



- 2007 6 BUICK TERRAZA 3.9L
- 2008-07 6 CHEVROLET UPLANDER 3.9L
- 2008-07 6 PONTIAC MONTANA 3.9L
- 2007 6 SATURN RELAY 3.9L

643030

Inlet A: WELDED 3-BOLT FLANGE
 Outlet A: 2.7" MALE BALL
 Length: 51"



- 1997 5 VOLVO 850 2.4L

643031

Inlet A: WELDED 2-BOLT FLANGE
 Inlet B: WELDED 2-BOLT FLANGE
 Outlet A: WELDED 2-BOLT FLANGE
 Length: 51.25"



- 2001 6 HYUNDAI XG300 3.0L

643031 (cont.)

2005-02 6 HYUNDAI XG350 3.5L
2006-04 6 KIA AMANTI 3.5L

643032

Inlet A: WELDED 4-BOLT FLANGE
Outlet A: 2.50" O.D. PIPE
Length: 78.75"



2010-08 6 CHRYSLER TOWN & COUNTRY 3.3L
2010-08 6 CHRYSLER TOWN & COUNTRY 3.8L
2010-08 6 DODGE CARAVAN 3.3L
2010-08 6 DODGE CARAVAN 3.8L
2010-09 6 VOLKSWAGEN ROUTAN 3.8L

643033

Inlet A: WELDED 2-BOLT FLANGE
Outlet A: 2.24" O.D. PIPE
Length: 52"



2004-00 6 TOYOTA TUNDRA 3.4L

643036

Inlet A: WELDED 4-BOLT FLANGE
Outlet A: WELDED 2-BOLT FLANGE
Length: 51.50"



2000-98 4 ISUZU AMIGO 2.2L
2000-98 4 ISUZU RODEO 2.2L

643037

Inlet A: 2.50" FEMALE FLARE
Inlet B: 2.50" FEMALE FLARE
Outlet A: 2" O.D. PIPE
Outlet B: 2" O.D. PIPE
Length: 54"



1996-94 12 JAGUAR XJ12 6.0L

643040

Inlet A: WELDED 2-BOLT FLANGE W/ GASKET STUB
Inlet B: WELDED 2-BOLT FLANGE
Outlet A: WELDED 2-BOLT FLANGE
Length: 49.50"



2003-02 6 JEEP LIBERTY 3.7L

643043

Inlet A: WELDED 2-BOLT FLANGE
Inlet B: WELDED 2-BOLT FLANGE
Outlet A: WELDED 2-BOLT FLANGE
Length: 79"



2006-03 6 HYUNDAI SANTA FE 3.5L

643044

Inlet A: WELDED 2-BOLT FLANGE
Outlet A: WELDED 2-BOLT FLANGE
Length: 85.50"



2009-04 4 TOYOTA PRIUS 1.5L

643045

Inlet A: 2-BOLT FLANGE W/ SPHERICAL FLARE
Outlet A: 2.15" O.D. PIPE
Length: 65"



1997 8 MERCEDES-BENZ E420 4.2L

DIRECT FIT



643046

Inlet A: LOOSE 2-BOLT FLANGE W/ SPHERICAL FLARE
 Outlet A: LOOSE 2-BOLT FLANGE W/ FLAT FLARE
 Length: 66"



1997 8 MERCEDES-BENZ E420 4.2L

643047

Inlet A: LOOSE 2-BOLT FLANGE W/ SPHERICAL FLARE
 Inlet B: LOOSE 2-BOLT FLANGE W/ SPHERICAL FLARE
 Outlet A: WELDED 4-BOLT FLANGE
 Length: 53"



2007-05 8 FORD F-250 PICKUP 3/4 TON 5.4L

643048

Inlet A: WELDED 3-BOLT FLANGE W/ GASKET STUB
 Outlet A: WELDED 2-BOLT FLANGE
 Length: 105"



2009-07 4 MAZDA CX-7 2.3L

643049

Inlet A: WELDED 2-BOLT FLANGE
 Outlet A: 2" O.D. PIPE
 Length: 59"



2004-03 6 MERCEDES-BENZ C240 2.6L
 2004-03 6 MERCEDES-BENZ C320 3.2L

643050

Inlet A: WELDED 2-BOLT FLANGE
 Inlet B: LOOSE 2-BOLT FLANGE
 Outlet A: LOOSE 3-BOLT FLANGE W/ FLAT FLARE
 Length: 65.50"



2004-03 6 MERCEDES-BENZ C240 2.6L
 2004-03 6 MERCEDES-BENZ C320 3.2L

643051

Inlet A: WELDED 2-BOLT FLANGE
 Inlet B: WELDED 2-BOLT FLANGE
 Outlet A: WELDED 2-BOLT FLANGE W/ GASKET STUB
 Length: 50"



2007-05 6 TOYOTA AVALON 3.5L

643052

Inlet A: WELDED 2-BOLT FLANGE
 Inlet B: WELDED 2-BOLT FLANGE
 Outlet A: WELDED 2-BOLT FLANGE
 Length: 74"



2000-98 6 TOYOTA SIENNA 3.0L

643053

Inlet A: WELDED 2-BOLT FLANGE
 Inlet B: WELDED 2-BOLT FLANGE
 Outlet A: WELDED 2-BOLT FLANGE
 Length: 75"



2012-06 6 LEXUS IS250 2.5L

643054

Inlet A: WELDED 3-BOLT FLANGE
Outlet A: 2.50" MALE BALL
Length: 58"



1999-98 5 VOLVO S70/V70 2.4L

643055

Inlet A: WELDED 2-BOLT FLANGE
Outlet A: WELDED 2-BOLT FLANGE
Length: 59"



2005-02 6 BUICK RENDEZVOUS 3.4L
2007-06 6 BUICK RENDEZVOUS 3.5L
2005-01 6 PONTIAC AZTEK 3.4L

643056

Inlet A: LOOSE 2-BOLT FLANGE W/ SPHERICAL FLARE
Inlet B: LOOSE 2-BOLT FLANGE W/ SPHERICAL FLARE
Outlet A: WELDED 2-BOLT FLANGE
Length: 50"



2010-06 8 FORD EXPLORER 4.6L
2010-06 8 MERCURY MOUNTAINEER 4.6L

643057

Inlet A: WELDED 3-BOLT FLANGE
Outlet A: 2.00" O.D. PIPE
Length: 49"



2001 6 AUDI A4 2.8L
2005-00 6 VOLKSWAGEN PASSAT 2.8L

643058

Inlet A: WELDED 3-BOLT FLANGE
Outlet A: 2.00" O.D. PIPE
Length: 63.50"



2001 6 AUDI A4 2.8L

643059

Inlet A: WELDED 2-BOLT FLANGE
Outlet A: WELDED 2-BOLT FLANGE
Length: 85"



2006 4 MAZDA MIATA, MX5 2.0L

643061

Inlet A: WELDED 3-BOLT FLANGE
Outlet A: 2.00" O.D. PIPE
Length: 51.50"



2005-00 6 VOLKSWAGEN PASSAT 2.8L

DIRECT FIT



643062

Inlet A: WELDED 2-BOLT FLANGE
 Inlet B: WELDED 2-BOLT FLANGE
 Outlet A: WELDED 2-BOLT FLANGE
 Length: 78"



2004 6 HYUNDAI SANTA FE 3.5L

643063

Inlet A: WELDED 2-BOLT FLANGE
 Outlet A: 2.00" O.D. PIPE
 Length: 51"



2003 6 AUDI A6 3.0L

643064

Inlet A: WELDED 2-BOLT FLANGE
 Outlet A: 2.00" O.D. PIPE
 Length: 52"



2003 6 AUDI A6 3.0L

643065

Inlet A: LOOSE 2-BOLT FLANGE W/ FLARE
 Outlet A: 2.20" O.D. PIPE
 Length: 52"



2012-11 6 CHRYSLER 300 3.6L
 2012-11 6 DODGE CHALLENGER 3.6L
 2012-11 6 DODGE CHARGER 3.6L

643066

Inlet A: LOOSE 2-BOLT FLANGE W/ FLARE
 Inlet B: LOOSE 2-BOLT FLANGE W/ FLARE
 Outlet A: 2" O.D. PIPE
 Outlet B: 2" O.D. PIPE
 Length: 54.50"



2003 8 FORD THUNDERBIRD 3.9L
 2003 8 LINCOLN LS 3.9L

643067

Inlet A: LOOSE 2-BOLT FLANGE W/ FLARE
 Outlet A: 2.20" O.D. PIPE
 Length: 52"



2012-11 6 CHRYSLER 300 3.6L
 2012-11 6 DODGE CHALLENGER 3.6L
 2012-11 6 DODGE CHARGER 3.6L

643068

Inlet A: WELDED 4-BOLT FLANGE
 Outlet A: 2.25" O.D. PIPE
 Length: 66.25"



2008-06 4 VOLKSWAGEN PASSAT 2.0L

643069

Inlet A: WELDED 2-BOLT FLANGE
Outlet A: 2.38" O.D. PIPE
Length: 49.50"



2015-09 4 TOYOTA VENZA 2.7L

643070

Inlet A: WELDED 2-BOLT FLANGE
Outlet A: WELDED 2-BOLT FLANGE
Length: 79.25"

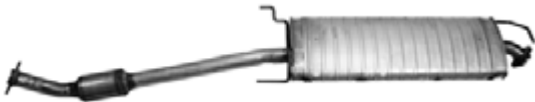

2008-06 4 TOYOTA RAV4 2.4L

643071

Inlet A: WELDED 2-BOLT FLANGE
Outlet A: WELDED 2-BOLT FLANGE
Length: 66.50"



2012-06 6 TOYOTA RAV4 3.5L

643073

Inlet A: WELDED 2-BOLT FLANGE W/ GASKET STUB
Outlet A: WELDED 2-BOLT FLANGE W/ GASKET STUB
Length: 49.50"



2011-10 4 TOYOTA CAMRY, (Inc. 1998 & Older SOLARA) 2.5L

643074

Inlet A: WELDED 3-BOLT FLANGE
Outlet A: WELDED 2-BOLT FLANGE
Length: 49"



2009-07 8 TOYOTA TUNDRA 4.7L

643076

Inlet A: WELDED 4-BOLT FLANGE
Outlet A: 2.18" O.D. PIPE
Length: 38.25"



2010-06 5 VOLKSWAGEN BEETLE 2.5L

643077

Inlet A: WELDED 3-BOLT FLANGE W/ GASKET STUB
Outlet A: WELDED 2-BOLT FLANGE
Length: 48.50"



2009-07 4 NISSAN ALTIMA 2.5L

643078

Inlet A: WELDED 2-BOLT FLANGE W/ SPHERICAL FLARE
Outlet A: WELDED 2-BOLT FLANGE W/ GASKET STUB
Length: 86"



2011-06 4 TOYOTA YARIS 1.5L

DIRECT FIT



643079

Inlet A: WELDED 3-BOLT FLANGE W/ GASKET STUB
 Inlet B: WELDED 2-BOLT FLANGE
 Outlet A: WELDED 2-BOLT FLANGE
 Length: 49.50"



- 1999-98 6 ACURA SLX 3.5L
- 2002-98 6 ISUZU TROOPER 3.5L
- 2001-99 6 ISUZU VEHICROSS 3.5L

643080

Inlet A: WELDED 3-BOLT FLANGE
 Outlet A: WELDED 2-BOLT FLANGE
 Length: 46.75"



- 2002-98 6 ISUZU TROOPER 3.5L

643081

Inlet A: WELDED 2-BOLT FLANGE
 Outlet A: WELDED 2-BOLT FLANGE W/ GASKET STUB
 Length: 86.50"

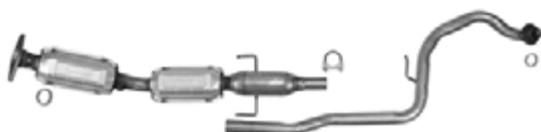

- 2014-12 4 TOYOTA YARIS 1.5L

643082

Inlet A: WELDED 4-BOLT FLANGE
 Inlet B: WELDED 4-BOLT FLANGE
 Outlet A: WELDED 2-BOLT FLANGE
 Length: 52.13"



- 2004-02 6 VOLVO S80 2.9L

643083

Inlet A: LOOSE 2-BOLT FLANGE W/ SPHERICAL FLARE
 Outlet A: LOOSE 2-BOLT FLANGE W/ SPHERICAL FLARE
 Length: 64"



- 2003-98 6 MERCEDES-BENZ E320 3.2L

643084

Inlet A: LOOSE 2-BOLT FLANGE W/ SPHERICAL FLARE
 Outlet A: 2" O.D. PIPE
 Length: 66.25"



- 2003-98 6 MERCEDES-BENZ E320 3.2L

643085

Inlet A: WELDED 3-BOLT FLANGE
 Inlet B: WELDED 2-BOLT FLANGE
 Outlet A: WELDED 2-BOLT FLANGE
 Length: 56"



- 2005-04 4 SUBARU LEGACY 2.5L

643085 (cont.)

2005-04 4 SUBARU OUTBACK 2.5L

643087

Inlet A: WELDED 2-BOLT FLANGE
Outlet A: WELDED 2-BOLT FLANGE W/ GASKET STUB
Length: 89"

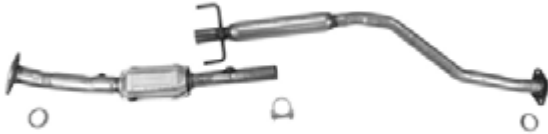

2005-00 4 TOYOTA CELICA 1.8L

643089

Inlet A: WELDED 2-BOLT FLANGE W/ GASKET STUB
Outlet A: WELDED 2-BOLT FLANGE
Length: 56.75"



2006-03 4 TOYOTA CAMRY, (Inc. 1998 & Older SOLARA) 2.4L

643090

Inlet A: WELDED 3-BOLT FLANGE W/ GASKET STUB
Outlet A: WELDED 2-BOLT FLANGE
Length: 48.50"



2015-07 4 NISSAN ALTIMA 2.5L

643091

Inlet A: WELDED 3-BOLT FLANGE
Outlet A: WELDED 2-BOLT FLANGE
Length: 50.38"



2015-11 4 CHEVROLET CRUZE 1.4L

643097

Inlet A: WELDED 2-BOLT FLANGE
Inlet B: LOOSE 2-BOLT FLANGE W/ FLARE
Outlet A: LOOSE 2-BOLT FLANGE W/ MALE BALL
Outlet B: 2 BOLT LOOSE FLANGE W/ FLARE
Length: 55"



2004 8 FORD MUSTANG 4.6L

643098

Inlet A: WELDED 2-BOLT FLANGE
Outlet A: WELDED 2-BOLT FLANGE
Length: 81.50"



2010-05 4 SCION TC 2.4L

643099

Inlet A: WELDED 2-BOLT FLANGE
Outlet A: 2.25" O.D. PIPE
Length: 51"



2007 6 DODGE CHARGER 2.7L
2007 6 DODGE MAGNUM 2.7L

DIRECT FIT



643100

Inlet A: WELDED 2-BOLT FLANGE
 Outlet A: 2.25" O.D. PIPE
 Length: 51.13"



2007 6 DODGE CHARGER 2.7L
 2007 6 DODGE MAGNUM 2.7L

643104

Inlet A: WELDED 2-BOLT FLANGE
 Outlet A: 1.90" O.D. PIPE
 Length: 78.50"



2009-07 4 SUZUKI SX4 2.0L

643101

Inlet A: WELDED 2-BOLT FLANGE
 Inlet B: WELDED 2-BOLT FLANGE
 Outlet A: WELDED 2-BOLT FLANGE
 Length: 72"



2001-99 6 TOYOTA SIENNA 3.0L

643105

Inlet A: WELDED 2-BOLT FLANGE
 Outlet A: 2.38" O.D. PIPE
 Length: 48"



2003-99 8 BMW 540 4.4L
 2001-99 8 BMW 740 4.4L

643102

Inlet A: WELDED 3-BOLT FLANGE
 Inlet B: WELDED 3-BOLT FLANGE
 Outlet A: 2.50" O.D. PIPE
 Length: 66"



2008-06 6 VOLKSWAGEN PASSAT 3.6L

643106

Inlet A: WELDED 2-BOLT FLANGE
 Outlet A: 2.38" O.D. PIPE
 Length: 48"



2003-99 8 BMW 540 4.4L
 2001-99 8 BMW 740 4.4L

643103

Inlet A: WELDED 3-BOLT FLANGE
 Outlet A: WELDED 2-BOLT FLANGE
 Length: 51.75"



2004 4 MITSUBISHI LANCER 2.4L

643107

Inlet A: LOOSE 2-BOLT FLANGE W/ FLARE
 Outlet A: LOOSE 2-BOLT FLANGE W/ FLARE
 Length: 67.25"



2005-04 6 MERCEDES-BENZ E320 3.2L

643108

Inlet A: WELDED 4-BOLT FLANGE
 Outlet A: WELDED 2-BOLT FLANGE
 Length: 52"



2003-01 4 ISUZU RODEO SPORT 2.2L
 2003-01 4 ISUZU RODEO 2.2L

643109

Inlet A: LOOSE 2-BOLT FLANGE W/ FLARE
Outlet A: 2.19" O.D. PIPE
Length: 70"



2005-04 6 MERCEDES-BENZ E320 3.2L

643110

Inlet A: WELDED 3-BOLT FLANGE
Inlet B: WELDED 3-BOLT FLANGE
Outlet A: 2.50" O.D. PIPE
Length: 70"



2009-06 6 AUDI A3 QUATTRO 3.2L

643111

Inlet A: WELDED 2-BOLT FLANGE
Outlet A: WELDED 2-BOLT FLANGE
Length: 82.50"



2012-08 4 SCION XD 1.8L

643112

Inlet A: WELDED 5-BOLT FLANGE
Inlet B: WELDED 2-BOLT FLANGE
Outlet A: WELDED 2-BOLT FLANGE
Length: 62.50"



2007-06 6 SUBARU B9 TRIBECA 3.0L
2007-05 6 SUBARU OUTBACK 3.0L

643113

Inlet A: WELDED 5-BOLT FLANGE
Outlet A: WELDED 2-BOLT FLANGE
Length: 51.25"



2007-06 6 SUBARU B9 TRIBECA 3.0L
2007-05 6 SUBARU OUTBACK 3.0L

643114

Inlet A: WELDED 2-BOLT FLANGE
Outlet A: 1.75" O.D. PIPE W/ GASKET STUD
Length: 98"



2006-03 4 PONTIAC VIBE 1.8L
2006-03 4 TOYOTA MATRIX 1.8L

643115

Inlet A: LOOSE 2-BOLT FLANGE W/ FLARE
Outlet A: LOOSE 2-BOLT W/ MALE BALL
Length: 67"



2005-03 6 MERCEDES-BENZ E320 3.2L

643116

Inlet A: LOOSE 2-BOLT FLANGE W/ FLARE
Outlet A: 2.19" O.D. PIPE
Length: 72"



2005-03 6 MERCEDES-BENZ E320 3.2L

643117

Inlet A: WELDED 3-BOLT FLANGE W/ FLARE
Outlet A: 2" O.D. PIPE
Length: 63.75"



2001-00 6 AUDI A4 2.8L

643118

Inlet A: WELDED 3-BOLT FLANGE W/ FLARE
Outlet A: 2" O.D. PIPE
Length: 50"



2001-00 6 AUDI A4 2.8L

DIRECT FIT



643119

Inlet A: WELDED 3-BOLT FLANGE
 Outlet A: WELDED 2-BOLT FLANGE
 Length: 68"



2013-10 8 TOYOTA TUNDRA 5.7L

643120

Inlet A: WELDED 2-BOLT FLANGE
 Outlet A: WELDED 2-BOLT FLANGE W/GASKET STUB
 Length: 90"



2003 4 PONTIAC VIBE 1.8L
 2003 4 TOYOTA MATRIX 1.8L

643121

Inlet A: WELDED 2-BOLT FLANGE
 Inlet B: WELDED 2-BOLT FLANGE
 Outlet A: 2.50" I.D. PIPE
 Length: 59.50"



1997-95 8 LEXUS LS400 4.0L

643122

Inlet A: WELDED 3-BOLT FLANGE
 Outlet A: WELDED 2-BOLT FLANGE
 Length: 59.25"



2007-06 4 SUBARU LEGACY 2.5L
 2007-06 4 SUBARU OUTBACK 2.5L

643123

Inlet A: WELDED 2-BOLT FLANGE
 Outlet A: WELDED 2-BOLT FLANGE
 Length: 105"



2013-11 4 SCION TC 2.5L

643124

Inlet A: LOOSE 2-BOLT FLANGE W/ FLARE
 Inlet B: LOOSE 2-BOLT FLANGE W/ FLARE
 Outlet A: LOOSE 3-BOLT FLANGE W/ FLARE
 Length: 62"



2003-98 6 MERCEDES-BENZ CLK320 3.2L
 2003-99 8 MERCEDES-BENZ CLK430 4.3L
 2002-01 8 MERCEDES-BENZ CLK55 AMG 5.5L

643125

Inlet A: WELDED 3-BOLT FLANGE
 Inlet B: WELDED 3-BOLT FLANGE
 Outlet A: 2.38" O.D. PIPE
 Length: 73"



2008 6 VOLKSWAGEN R32 3.2L

643126

Inlet A: WELDED 2-BOLT FLANGE
 Outlet A: WELDED 2-BOLT FLANGE
 Length: 75.25"



2015-12 4 HYUNDAI VELOSTER 1.6L

643127

Inlet A: LOOSE 3-BOLT FLANGE W/ FLARE
 Outlet A: 1.97" O.D. PIPE
 Length: 51.38"



2005-03 8 AUDI ALLROAD QUATTRO 4.2L

643128

Inlet A: LOOSE 3-BOLT FLANGE W/ FLARE
Outlet A: 1.97" O.D. PIPE
Length: 50.50"



2005-03 8 AUDI ALLROAD QUATTRO 4.2L

643129

Inlet A: WELDED 2-BOLT FLANGE
Inlet B: WELDED 2-BOLT FLANGE
Outlet A: WELDED 2-BOLT FLANGE W/GASKET STUB
Length: 75.75"



2012-06 6 LEXUS IS350 3.5L

643130

Inlet A: WELDED 2-BOLT FLANGE
Outlet A: WELDED 2-BOLT FLANGE W/GASKET STUB
Length: 104"



2009-08 4 MITSUBISHI OUTLANDER 2.4L

643131

Inlet A: WELDED 3-BOLT FLANGE
Outlet A: 2" O.D. PIPE
Length: 67"



2008-05 6 AUDI A6 3.2L

643132

Inlet A: WELDED 3-BOLT FLANGE
Outlet A: 2" O.D. PIPE
Length: 65.50"



2008-05 6 AUDI A6 3.2L

643133

Inlet A: LOOSE 2-BOLT FLANGE W/ FLARE
Outlet A: 2.16" O.D. PIPE
Length: 51"



2012-06 6 MERCEDES-BENZ R350 3.5L

643134

Inlet A: WELDED 3-BOLT FLANGE
Outlet A: WELDED 3-BOLT FLANGE
Length: 49"



2007 4 SATURN VUE 2.4L

643135

Inlet A: WELDED 2-BOLT FLANGE
Inlet B: WELDED 2-BOLT FLANGE
Outlet A: WELDED 2-BOLT FLANGE
Length: 54.63"



2010 6 BUICK ALLURE 3.0L

2010 6 BUICK LACROSSE 3.0L

644000

Inlet A: LOOSE 2-BOLT FLANGE W/ FLARE
Outlet A: 2.50" O.D. PIPE
Length: 51"



2011-06 6 MERCEDES-BENZ ML350 3.5L

644001

Inlet A: LOOSE 2-BOLT FLANGE W/ FLARE
Outlet A: 2.17" O.D. PIPE
Length: 52.13"



2011-06 6 MERCEDES-BENZ ML350 3.5L

DIRECT FIT



644002

Inlet A: WELDED 2-BOLT FLANGE
Inlet B: WELDED 2-BOLT FLANGE
Outlet A: WELDED 2-BOLT FLANGE
Length: 25.75"



2011-05 8 VOLVO XC90 4.4L

644003

Inlet A: WELDED 3-BOLT FLANGE W/GASKET STUB
Inlet B: WELDED 3-BOLT FLANGE W/GASKET STUB
Outlet A: WELDED 2-BOLT FLANGE
Length: 41.50"



2009 6 NISSAN MAXIMA 3.5L

644004

Inlet A: WELDED 2-BOLT FLANGE
Outlet A: WELDED 2-BOLT FLANGE
Length: 44"



2006-04 6 SUZUKI XL-7 2.7L

644005

Inlet A: WELDED 2-BOLT FLANGE
Inlet B: WELDED 2-BOLT FLANGE
Outlet A: WELDED 2-BOLT FLANGE W/GASKET STUB
Length: 22.50"



2006-04 6 MITSUBISHI MONTERO 3.8L

644006

Inlet A: WELDED 2-BOLT FLANGE
Outlet A: WELDED 2-BOLT FLANGE W/FLARE
Length: 17.50"



2006-03 6 MITSUBISHI MONTERO 3.8L

644007

Inlet A: WELDED 4-BOLT FLANGE
Inlet B: WELDED 4-BOLT FLANGE
Outlet A: WELDED 4-BOLT FLANGE
Length: 36"

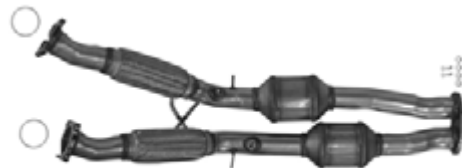

2010-07 6 VOLVO XC90 3.2L

644008

Inlet A: WELDED 3-BOLT FLANGE
Inlet B: WELDED 3-BOLT FLANGE
Outlet A: WELDED 3-BOLT FLANGE
Length: 44.07"



2014-13 6 HONDA ACCORD 3.5L

644009

Inlet A: 3.11" FLARE
Outlet A: 2.05" O.D. PIPE
Length: 43.50"



2009-07 4 MINI COOPER 1.6L

644010

Inlet A: WELDED 3-BOLT FLANGE
Outlet A: WELDED 3-BOLT FLANGE
Length: 42"



2002-01 4 SATURN L100 2.2L
2003-01 4 SATURN L200 2.2L
2003-01 4 SATURN LW200 2.2L

644011

Inlet A: WELDED 3-BOLT FLANGE
Outlet A: WELDED 3-BOLT FLANGE
Length: 41"



2010-08 4 SATURN VUE 2.4L

644012

Inlet A: WELDED 3-BOLT FLANGE
Inlet B: WELDED 2-BOLT FLANGE
Outlet A: WELDED 2-BOLT FLANGE
Length: 28.25"



2007-06 6 CHEVROLET MALIBU 3.9L
2008-07 6 CHEVROLET MALIBU 3.5L
2007-06 6 PONTIAC G6 3.9L
2007 6 PONTIAC G6 3.5L
2007 6 SATURN AURA 3.5L

644013

Inlet A: WELDED 3-BOLT FLANGE
Outlet A: WELDED 2-BOLT FLANGE
Length: 18.25"



2012-08 4 CHEVROLET MALIBU 2.4L
2010-09 4 PONTIAC G6 2.4L

644014

Inlet A: WELDED 2-BOLT FLANGE
Outlet A: WELDED 2-BOLT FLANGE
Length: 22.81"



2008-06 6 BUICK LUCERNE 3.8L

644015

Inlet A: WELDED 3-BOLT FLANGE
Outlet A: WELDED 2-BOLT FLANGE
Length: 25.75"



2015-10 4 CHEVROLET EQUINOX 2.4L

DIRECT FIT



644015 (cont.)

2015-10 4 GMC TERRAIN 2.4L

644016

Inlet A: WELDED 2-BOLT FLANGE
 Outlet A: WELDED 2-BOLT FLANGE
 Length: 26"



2011-09 6 BUICK LUCERNE 3.9L

644017

Inlet A: WELDED 2-BOLT FLANGE
 Outlet A: WELDED 2-BOLT FLANGE
 Length: 38.50"



2011-10 6 CHEVROLET IMPALA FWD 3.9L

644018

Inlet A: WELDED 2-BOLT FLANGE
 Outlet A: 2.48" O.D. PIPE
 Length: 34"



2011-10 6 CHEVROLET CAMARO 3.6L

644019

Inlet A: WELDED 2-BOLT FLANGE
 Outlet A: 2.48" O.D. PIPE
 Length: 34"



2011-10 6 CHEVROLET CAMARO 3.6L

645177

Inlet A: LOOSE 2-BOLT FLANGE W/ FLARE
 Outlet A: 2.47" O.D. PIPE
 Length: 27"



2010-09 8 FORD F-150 PICKUP 1/2 TON 4.6L

645178

Inlet A: LOOSE 2-BOLT FLANGE W/ SPHERICAL FLARE
 Inlet B: 2.50" I.D. PIPE
 Outlet A: LOOSE 2-BOLT FLANGE
 Length: 44.25"

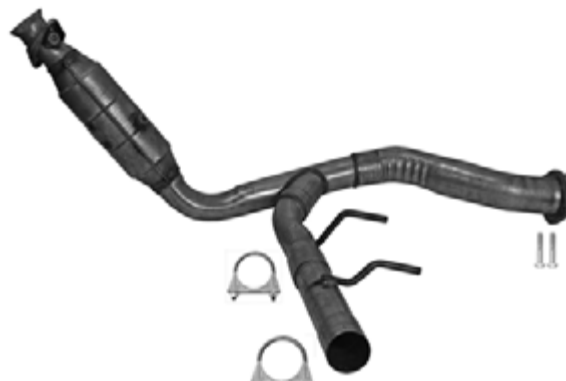

2010-09 8 FORD F-150 PICKUP 1/2 TON 4.6L

645179

Inlet A: WELDED 3-BOLT FLANGE
 Outlet A: 2.48" O.D. PIPE
 Length: 45"



2012-09 8 CHEVROLET COLORADO 5.3L
 2012-09 8 GMC CANYON 5.3L
 2010-08 8 HUMMER H3 5.3L

645180

Inlet A: LOOSE 3-BOLT FLANGE W/ FLARE
Outlet A: WELDED 2-BOLT FLANGE W/GASKET STUB
Length: 51.13"



- 2012-09 8 CHEVROLET COLORADO 5.3L
- 2012-09 8 GMC CANYON 5.3L
- 2010-08 8 HUMMER H3 5.3L

645182

Inlet A: WELDED 2-BOLT FLANGE
Outlet A: WELDED 2-BOLT FLANGE W/GASKET STUB
Length: 16.75"



- 2009-08 8 PONTIAC G8 6.0L

645183

Inlet A: WELDED 2-BOLT FLANGE
Outlet A: WELDED 2-BOLT FLANGE W/GASKET STUB
Length: 16.75"



- 2009-08 8 PONTIAC G8 6.0L

645184

Inlet A: WELDED 3-BOLT FLANGE
Inlet B: LOOSE 3-BOLT FLANGE W/ FLARE
Outlet A: WELDED 2-BOLT FLANGE
Length: 34"



- 2013-11 8 CHEVROLET C-(2WD), K-(4WD) PICKUP 1 TON, (Inc. SILVERADO) 6.0L
- 2013-11 8 CHEVROLET C-(2WD), K-(4WD) PICKUP 3/4 TON, (Inc. SILVERADO & AVALANCHE) 6.0L
- 2013-11 8 GMC C-(2WD), K-(4WD) PICKUP 1 TON, (Inc.

645184 (cont.)

- 2013-11 8 SIERRA) 6.0L
- 2013-11 8 GMC C-(2WD), K-(4WD) PICKUP 3/4 TON, (Inc. SIERRA) 6.0L

645185

Inlet A: LOOSE 3-BOLT FLANGE W/ FLARE
Outlet A: WELDED 2-BOLT FLANGE
Length: 47"



- 2009-08 6 CHEVROLET TRAILBLAZER 4.2L
- 2009-08 6 GMC ENVOY 4.2L
- 2009-08 6 SAAB 9-7X 4.2L

645186

Inlet A: WELDED 3-BOLT FLANGE
Inlet B: LOOSE 3-BOLT FLANGE W/ FLARE
Outlet A: WELDED 2-BOLT FLANGE
Length: 39"



- 2007-06 8 BUICK RAINIER 5.3L
- 2008-06 8 CHEVROLET TRAILBLAZER 5.3L
- 2009-06 8 CHEVROLET TRAILBLAZER 6.0L
- 2009-06 8 GMC ENVOY 5.3L
- 2006 8 ISUZU ASCENDER 5.3L
- 2009-06 8 SAAB 9-7X 5.3L
- 2009-08 8 SAAB 9-7X 6.0L

645187

Inlet A: WELDED 3-BOLT FLANGE
Outlet A: 2.57" O.D. PIPE
Outlet B: 2.57" O.D. PIPE
Length: 35"



- 2000-96 8 CHEVROLET C-(2WD), K-(4WD) PICKUP 1 TON, (Inc. SILVERADO) 7.4L
- 2000-96 8 GMC C-(2WD), K-(4WD) PICKUP 1 TON, (Inc. SIERRA) 7.4L

DIRECT FIT



645188

Inlet A: WELDED 4-BOLT FLANGE
 Outlet A: 2.50" O.D. PIPE
 Outlet B: 2.50" O.D. PIPE
 Length: 44.75"



1999-97 8 CHEVROLET P30, P30 SERIES, P30 VAN 5.7L

645189

Inlet A: LOOSE 2-BOLT FLANGE W/ FLARE
 Outlet A: 2.11" O.D. PIPE
 Length: 26.50"



2006-04 6 JAGUAR VANDEN PLAS 4.2L
 2006-04 6 JAGUAR XJ8 4.2L

645190

Inlet A: LOOSE 2-BOLT FLANGE W/ FLARE
 Outlet A: 2.11" O.D. PIPE
 Length: 26.50"



2006-04 6 JAGUAR VANDEN PLAS 4.2L
 2006-04 6 JAGUAR XJ8 4.2L

645191

Inlet A: LOOSE 2-BOLT FLANGE W/ FLARE
 Outlet A: 2" O.D. PIPE
 Length: 34.25"



2006 8 LAND ROVER RANGE ROVER 4.2L
 2006 8 LAND ROVER RANGE ROVER 4.4L

645192

Inlet A: LOOSE 2-BOLT FLANGE W/ FLARE
 Outlet A: 2" O.D. PIPE
 Length: 35.50"



2006 8 LAND ROVER RANGE ROVER 4.2L
 2006 8 LAND ROVER RANGE ROVER 4.4L

645193

Inlet A: WELDED 3-BOLT FLANGE
 Outlet A: WELDED 2-BOLT FLANGE
 Length: 37"



2002-98 8 LEXUS LX470 4.7L
 2002-98 8 TOYOTA LAND CRUISER 4.7L

645194

Inlet A: WELDED 4-BOLT FLANGE
 Outlet A: 2.38" O.D. PIPE
 Length: 39"



2010 5 VOLKSWAGEN GOLF 2.5L
 2010-05 5 VOLKSWAGEN JETTA 2.5L
 2009-06 5 VOLKSWAGEN RABBIT 2.5L

645195

Inlet A: WELDED 2-BOLT FLANGE W/GASKET STUB
 Inlet B: WELDED 2-BOLT FLANGE
 Outlet A: WELDED 2-BOLT FLANGE W/GASKET STUB
 Length: 36"



2011-05 6 TOYOTA TACOMA 4.0L

645196

Inlet A: WELDED 2-BOLT FLANGE W/GASKET STUB
 Outlet A: WELDED 2-BOLT FLANGE
 Length: 23.50"



2011-05 6 TOYOTA TACOMA 4.0L

645197

Inlet A: WELDED 2-BOLT FLANGE W/ FEMALE FLARE
 Outlet A: 2.25" O.D. PIPE
 Length: 20"



2012-09 6 FORD ESCAPE 3.0L
 2011-09 6 MERCURY MARINER 3.0L

645198

Inlet A: LOOSE 2-BOLT FLANGE W/ FLARE
 Outlet A: 2.46" O.D. PIPE
 Length: 28.50"



2014-11 8 FORD F-150 PICKUP 1/2 TON 5.0L

645199

Inlet A: LOOSE 2-BOLT FLANGE W/ FLARE
 Outlet A: LOOSE 2-BOLT FLANGE W/ FLARE
 Length: 44.13"



2014-11 8 FORD F-150 PICKUP 1/2 TON 5.0L

645200

Inlet A: LOOSE 2-BOLT FLANGE W/ FLARE
 Outlet A: 2.50" O.D. PIPE
 Length: 36.25"



2008-06 8 FORD F-150 PICKUP 1/2 TON 4.6L

645201

Inlet A: LOOSE 2-BOLT FLANGE W/ FLARE
 Inlet B: 2.50" I.D. PIPE
 Outlet A: 2.50" O.D. PIPE
 Length: 49.50"



2008-06 8 FORD F-150 PICKUP 1/2 TON 4.6L

645202

Inlet A: LOOSE 2-BOLT FLANGE W/ FLARE
 Outlet A: 2" O.D. PIPE
 Length: 28.75"



2014-11 6 FORD F-150 PICKUP 1/2 TON 3.7L

645203

Inlet A: LOOSE 2-BOLT FLANGE W/ FLARE
 Inlet B: 2" I.D. PIPE
 Outlet A: LOOSE 2-BOLT FLANGE W/ FLARE
 Length: 49.50"



2014-11 6 FORD F-150 PICKUP 1/2 TON 3.7L

DIRECT FIT



645204

Inlet A: LOOSE 2-BOLT FLANGE W/ FLARE
Outlet A: 2.47" O.D. PIPE
Length: 27.75"



2010-09 8 FORD F-150 PICKUP 1/2 TON 4.6L

645205

Inlet A: LOOSE 2-BOLT FLANGE W/ FLARE
Inlet B: 2.49" O.D. PIPE
Outlet A: LOOSE 2-BOLT FLANGE W/ FLARE
Length: 44"



2010-09 8 FORD F-150 PICKUP 1/2 TON 4.6L

645206

Inlet A: LOOSE 2-BOLT FLANGE W/ FLARE
Outlet A: 2.50" O.D. PIPE
Length: 49"



2004-01 8 FORD F-150 PICKUP 1/2 TON 5.4L

645207

Inlet A: LOOSE 2-BOLT FLANGE W/ FLARE
Outlet A: 2.50" O.D. PIPE
Length: 41.63"



2004-01 8 FORD F-150 PICKUP 1/2 TON 5.4L

645208

Inlet A: LOOSE 2-BOLT FLANGE W/ FLARE
Outlet A: 2.5" O.D. PIPE
Length: 37"



2008-04 8 FORD F-150 PICKUP 1/2 TON 4.6L

645209

Inlet A: LOOSE 2-BOLT FLANGE W/ FLARE
Inlet B: 2.67" O.D. PIPE
Outlet A: 2" O.D. PIPE
Length: 44"



2008-04 8 FORD F-150 PICKUP 1/2 TON 4.6L

645210

Inlet A: LOOSE 2-BOLT FLANGE W/ FLARE
Outlet A: 2.25" O.D. PIPE
Length: 39"



2000-99 6 FORD F-150 PICKUP 1/2 TON 4.2L

645211

Inlet A: LOOSE 2-BOLT FLANGE W/ FLARE
Inlet B: 2.25" I.D. PIPE
Outlet A: 2.25" O.D. PIPE
Length: 46"



2000-99 6 FORD F-150 PICKUP 1/2 TON 4.2L

645212

Inlet A: LOOSE 2-BOLT FLANGE W/ FLARE
 Inlet B: LOOSE 2-BOLT FLANGE W/ FLARE
 Outlet A: WELDED 2-BOLT FLANGE W/MALE BALL
 Length: 39"



2010-08 10 FORD F-250 PICKUP 3/4 TON 6.8L
 2010-08 8 FORD F-250 PICKUP 3/4 TON 5.4L
 2010-08 10 FORD F-350 PICKUP 1 TON 6.8L
 2010-08 8 FORD F-350 PICKUP 1 TON 5.4L

645213

Inlet A: LOOSE 2-BOLT FLANGE W/ FLARE
 Outlet A: 2.50" O.D. PIPE
 Length: 35.50"



2002-01 8 FORD EXPEDITION 4.6L
 2002-01 8 FORD F-150 PICKUP 1/2 TON 4.6L

645214

Inlet A: LOOSE 2-BOLT FLANGE W/ FLARE
 Inlet B: 2.50" I.D. PIPE
 Outlet A: 2.50" O.D. PIPE
 Length: 46"



2002-01 8 FORD EXPEDITION 4.6L
 2002-01 8 FORD F-150 PICKUP 1/2 TON 4.6L

645215

Inlet A: LOOSE 2-BOLT FLANGE W/ FLARE
 Outlet A: 2.50" O.D. PIPE
 Length: 35"



2005-04 8 FORD F-150 PICKUP 1/2 TON 5.4L

645216

Inlet A: LOOSE 2-BOLT FLANGE W/ FLARE
 Inlet B: 2.50" I.D. PIPE
 Outlet A: 2.50" O.D. PIPE
 Length: 49"



2005-04 8 FORD F-150 PICKUP 1/2 TON 5.4L

645217

Inlet A: LOOSE 2-BOLT FLANGE W/ FLARE
 Outlet A: 2.50" O.D. PIPE
 Length: 35"



2006-04 8 FORD F-150 PICKUP 1/2 TON 5.4L
 2006 8 LINCOLN MARK LT 5.4L

645218

Inlet A: LOOSE 2-BOLT FLANGE W/ FLARE
 Inlet B: 2.50" I.D. PIPE
 Outlet A: 2.50" O.D. PIPE
 Length: 49"



2006-04 8 FORD F-150 PICKUP 1/2 TON 5.4L
 2006 8 LINCOLN MARK LT 5.4L

645219

Inlet A: WELDED 3-BOLT FLANGE
 Outlet A: WELDED 2-BOLT FLANGE W/MALE BALL
 Length: 30.50"



2005-04 6 FORD EXPLORER 4.0L

DIRECT FIT



645220

Inlet A: LOOSE 2-BOLT FLANGE W/ FLARE
 Outlet A: 2.50" O.D. PIPE
 Length: 36"



2004-00 6 FORD F-150 PICKUP 1/2 TON 4.2L

645221

Inlet A: LOOSE 2-BOLT FLANGE W/ FLARE
 Inlet B: 2.50" I.D. PIPE
 Outlet A: 2.50" O.D. PIPE
 Length: 46.50"



2004-00 6 FORD F-150 PICKUP 1/2 TON 4.2L

645222

Inlet A: LOOSE 2-BOLT FLANGE W/ FLARE
 Outlet A: 2.50" O.D. PIPE
 Length: 35.50"



1998-97 6 FORD F-150 PICKUP 1/2 TON 4.2L

645223

Inlet A: LOOSE 2-BOLT FLANGE W/ FLARE
 Inlet B: 2.50" I.D. PIPE
 Outlet A: 2.50" O.D. PIPE
 Length: 47.50"



1998-97 6 FORD F-150 PICKUP 1/2 TON 4.2L

645224

Inlet A: LOOSE 2-BOLT FLANGE W/ FLARE
 Inlet B: LOOSE 2-BOLT FLANGE W/ FLARE
 Outlet A: 2.98" O.D. PIPE
 Length: 37.63"



2010-09 8 DODGE RAM (2WD & 4WD) PICKUP 1/2 & 3/4 TON 5.7L
 2012-11 8 RAM 1500 5.7L

645225

Inlet A: LOOSE 2-BOLT FLANGE W/ FLARE
 Inlet B: LOOSE 2-BOLT FLANGE W/ FLARE
 Outlet A: 2.75" O.D. PIPE
 Length: 24"



2008 8 DODGE DAKOTA 4.7L

645226

Inlet A: LOOSE 2-BOLT FLANGE W/ FLARE
 Inlet B: LOOSE 2-BOLT FLANGE W/ FLARE
 Outlet A: WELDED 2-BOLT FLANGE
 Length: 44"



2010-08 6 JEEP COMMANDER 3.7L
 2009-07 6 JEEP GRAND CHEROKEE/GRAND WAGONEER 3.7L

645227

Inlet A: LOOSE 2-BOLT FLANGE W/ FLARE
 Inlet B: LOOSE 2-BOLT FLANGE W/ FLARE
 Outlet A: 3" O.D. PIPE
 Length: 29.50"



2007-06 8 DODGE RAM (2WD & 4WD) PICKUP 1/2 & 3/4 TON 5.7L

645230

Inlet A: LOOSE 2-BOLT FLANGE W/ FLARE
 Inlet B: LOOSE 2-BOLT FLANGE W/ FLARE
 Outlet A: 3" O.D. PIPE
 Length: 60"



2009 8 DODGE RAM (2WD & 4WD) PICKUP 1 TON 5.7L
 2009 8 DODGE RAM (2WD & 4WD) PICKUP 1/2 & 3/4 TON 5.7L

645228

Inlet A: LOOSE 2-BOLT FLANGE W/ FLARE
 Inlet B: LOOSE 2-BOLT FLANGE W/ FLARE
 Outlet A: 3" O.D. PIPE
 Length: 37.88"



2008 8 DODGE RAM (2WD & 4WD) PICKUP 1/2 & 3/4 TON 4.7L

645231

Inlet A: LOOSE 2-BOLT FLANGE W/ FLARE
 Inlet B: LOOSE 2-BOLT FLANGE W/ FLARE
 Outlet A: 3" O.D. PIPE
 Length: 29"



2010-09 8 DODGE RAM (2WD & 4WD) PICKUP 1/2 & 3/4 TON 4.7L

645229

Inlet A: LOOSE 2-BOLT FLANGE W/ FLARE
 Inlet B: LOOSE 2-BOLT FLANGE W/ FLARE
 Outlet A: 2.25" O.D. PIPE
 Length: 39.25"



2008 8 DODGE RAM (2WD & 4WD) PICKUP 1/2 & 3/4 TON 5.7L

645232

Inlet A: LOOSE 2-BOLT FLANGE W/ FLARE
 Inlet B: LOOSE 2-BOLT FLANGE W/ FLARE
 Outlet A: WELDED 2-BOLT FLANGE
 Length: 39"



2007-06 8 JEEP COMMANDER 5.7L
 2010-05 8 JEEP GRAND CHEROKEE/GRAND WAGONEER 5.7L

DIRECT FIT



645236

Inlet A: LOOSE 3-BOLT FLANGE W/ SPHERICAL FLARE
 Inlet B: WELDED 3-BOLT FLANGE
 Outlet A: WELDED 2-BOLT FLANGE
 Length: 37.25"



- 2005-02 8 CADILLAC ESCALADE 5.3L
- 2006-00 6 CHEVROLET C-(2WD), K-(4WD) PICKUP 1/2 TON, (Inc. SILVERADO & AVALANCHE) 4.3L
- 2006-00 8 CHEVROLET C-(2WD), K-(4WD) PICKUP 1/2 TON, (Inc. SILVERADO & AVALANCHE) 4.8L
- 2006-00 8 CHEVROLET C-(2WD), K-(4WD) PICKUP 1/2 TON, (Inc. SILVERADO & AVALANCHE) 5.3L
- 2000 8 CHEVROLET C-(2WD), K-(4WD) PICKUP 3/4 TON, (Inc. SILVERADO & AVALANCHE) 5.3L
- 2005-00 8 CHEVROLET SUBURBAN/TAHOE 4.8L
- 2005-00 8 CHEVROLET SUBURBAN/TAHOE 5.3L
- 2006-00 6 GMC C-(2WD), K-(4WD) PICKUP 1/2 TON, (Inc. SIERRA) 4.3L
- 2006-00 8 GMC C-(2WD), K-(4WD) PICKUP 1/2 TON, (Inc. SIERRA) 4.8L
- 2006-00 8 GMC C-(2WD), K-(4WD) PICKUP 1/2 TON, (Inc. SIERRA) 5.3L
- 2000 8 GMC C-(2WD), K-(4WD) PICKUP 3/4 TON, (Inc. SIERRA) 5.3L
- 2005-01 8 GMC SUBURBAN/YUKON 4.8L
- 2005-01 8 GMC SUBURBAN/YUKON 5.3L

645255

Inlet A: LOOSE 2-BOLT FLANGE W/ SPHERICAL FLARE
 Inlet B: 2.50" I.D. PIPE
 Outlet A: 2.50" O.D. PIPE
 Length: 47"



2004-97 6 FORD F-150 PICKUP 1/2 TON 4.2L

645256

Inlet A: LOOSE 3-BOLT FLANGE W/ SPHERICAL FLARE
 Inlet B: WELDED 3-BOLT FLANGE
 Outlet A: WELDED 2-BOLT FLANGE
 Length: 40"



2004-97 6 FORD F-150 PICKUP 1/2 TON 4.2L

645257

Inlet A: WELDED 3-BOLT FLANGE W/ GASKET STUB
 Outlet A: WELDED 2-BOLT FLANGE W/ GASKET STUB
 Length: 49.50"



2004-03 8 TOYOTA TUNDRA 4.7L

645259

Inlet A: LOOSE 2-BOLT FLANGE W/ SPHERICAL FLARE
 Inlet B: 2.50" I.D. PIPE
 Outlet A: 2.50" O.D. PIPE
 Length: 48.13"



2003-99 6 FORD E-150 VAN 1/2 TON 4.2L
 2003-99 6 FORD E-250 VAN 3/4 TON 4.2L

645260

Inlet A: LOOSE 2-BOLT FLANGE W/ SPHERICAL FLARE
 Outlet A: 2.50" O.D. PIPE
 Length: 37.38"



2003-99 6 FORD E-150 VAN 1/2 TON 4.2L
 2003-99 6 FORD E-250 VAN 3/4 TON 4.2L

645261

Inlet A: LOOSE 2-BOLT FLANGE W/ SPHERICAL FLARE
 Outlet A: 2.50" O.D. PIPE
 Length: 38.13"



1999-97 8 FORD E-150 VAN 1/2 TON 4.6L

645262

Inlet A: LOOSE 2-BOLT FLANGE W/ SPHERICAL FLARE
 Inlet B: 2.50" I.D. PIPE
 Outlet A: 2.50" O.D. PIPE
 Length: 47.63"



1999-97 8 FORD E-150 VAN 1/2 TON 4.6L

645263

Inlet A: LOOSE 2-BOLT FLANGE W/ SPHERICAL FLARE
 Outlet A: 2" O.D. PIPE
 Length: 64"



2005-03 6 MERCEDES-BENZ ML350 3.7L

645264

Inlet A: LOOSE 2-BOLT FLANGE W/ SPHERICAL FLARE
 Outlet A: 2" O.D. PIPE
 Length: 62"



2005-03 6 MERCEDES-BENZ ML350 3.7L

645265

Inlet A: LOOSE 3-BOLT FLANGE w/ SPHERICAL FLARE
 Inlet B: WELDED 3-BOLT FLANGE
 Outlet A: WELDED 2-BOLT FLANGE
 Length: 40"



2006-05 8 BUICK RAINIER 5.3L
 2007-06 8 CHEVROLET TRAILBLAZER 5.3L
 2006-05 8 GMC ENVOY 5.3L
 2005 8 SAAB 9-7X 5.3L

DIRECT FIT



645266

Inlet A: WELDED 3-BOLT FLANGE W/ GASKET STUB
 Outlet A: WELDED 2-BOLT FLANGE W/ GASKET STUB
 Length: 29.75"



2004-03 8 TOYOTA TUNDRA 4.7L

645267

Inlet A: WELDED 2-BOLT FLANGE W/ GASKET STUB
 Inlet B: WELDED 2-BOLT FLANGE W/ GASKET STUB
 Outlet A: WELDED 2-BOLT FLANGE
 Length: 43.75"



1997-96 6 LEXUS LX450 4.5L
 1997-95 6 TOYOTA LAND CRUISER 4.5L

645269

Inlet A: LOOSE 2-BOLT FLANGE W/ SPHERICAL FLARE
 Inlet B: LOOSE 2-BOLT FLANGE W/ SPHERICAL FLARE
 Outlet A: 2.50" O.D. PIPE
 Length: 44"



2009-07 6 JEEP WRANGLER 3.8L

645270

Inlet A: WELDED 2-BOLT FLANGE
 Outlet A: 2.13" O.D. PIPE
 Length: 23.25"



2009-07 6 LEXUS RX350 3.5L
 2013-08 6 TOYOTA HIGHLANDER 3.5L

645272

Inlet A: WELDED 2-BOLT FLANGE
 Outlet A: 3" O.D. PIPE
 Length: 33"



2001-99 8 CHEVROLET C-(2WD), K-(4WD) PICKUP 3/4 TON, (Inc. SILVERADO & AVALANCHE) 6.0L
 2001-99 8 GMC C-(2WD), K-(4WD) PICKUP 3/4 TON, (Inc. SIERRA) 6.0L

645273

Inlet A: WELDED 2-BOLT FLANGE
 Outlet A: 2.25" I.D. PIPE
 Length: 22.25"



2012-09 4 FORD ESCAPE 2.5L
 2011-09 4 MAZDA TRIBUTE 2.5L
 2011-10 4 MERCURY MARINER 2.5L

645276

Inlet A: WELDED 2-BOLT FLANGE
Outlet A: 2.80" I.D. PIPE
Length: 18.75"



- 2002-01 8 CHEVROLET C-(2WD), K-(4WD) PICKUP 3/4 TON, (Inc. SILVERADO & AVALANCHE) 6.0L
- 2002-01 8 GMC C-(2WD), K-(4WD) PICKUP 3/4 TON, (Inc. SIERRA) 6.0L

645277

Inlet A: LOOSE 3-BOLT FLANGE w/ SPHERICAL FLARE
Inlet B: WELDED 3-BOLT FLANGE
Outlet A: WELDED 2-BOLT FLANGE
Length: 46"



- 2007 8 HUMMER H2 6.0L
- 2008 8 HUMMER H2 6.2L

645278

Inlet A: LOOSE 2-BOLT FLANGE W/ FEMALE FLARE
Outlet A: 2.50" O.D. PIPE
Length: 38"



- 2004-03 8 LINCOLN NAVIGATOR 5.4L

645279

Inlet A: LOOSE 2-BOLT FLANGE W/ FEMALE FLARE
Inlet B: 2.50" I.D. PIPE
Outlet A: 2.50" I.D. PIPE W/ SPHERICAL FLARE
Length: 45"



- 2004-03 8 LINCOLN NAVIGATOR 5.4L

645280

Inlet A: WELDED 2-BOLT FLANGE W/ GASKET STUB
Outlet A: WELDED 2-BOLT FLANGE W/ GASKET STUB
Length: 32"



- 2006-05 6 TOYOTA TUNDRA 4.0L

645281

Inlet A: LOOSE 2-BOLT FLANGE W/ FEMALE FLARE
Outlet A: 2.50" O.D. PIPE
Length: 27"



- 2014-07 8 FORD EXPEDITION 5.4L
- 2010-09 8 FORD F-150 PICKUP 1/2 TON 5.4L
- 2014-07 8 LINCOLN NAVIGATOR 5.4L

DIRECT FIT



645282

Inlet A: LOOSE 2-BOLT FLANGE W/ FEMALE FLARE
 Inlet B: 2.50" I.D. PIPE
 Outlet A: LOOSE 2-BOLT FLANGE W/ FEMALE FLARE
 Length: 44"



- 2014-07 8 FORD EXPEDITION 5.4L
- 2010-09 8 FORD F-150 PICKUP 1/2 TON 5.4L
- 2014-07 8 LINCOLN NAVIGATOR 5.4L

645283

Inlet A: LOOSE 2-BOLT FLANGE W/ FEMALE FLARE
 Outlet A: 2.50" O.D. PIPE
 Length: 37.50"



- 2007-00 8 FORD E-150 VAN 1/2 TON 4.6L
- 2007-03 8 FORD E-250 VAN 3/4 TON 4.6L

645284

Inlet A: LOOSE 2-BOLT FLANGE W/ FEMALE FLARE
 Inlet B: 2.50" I.D. PIPE
 Outlet A: 2.50" O.D. PIPE
 Length: 46.50"



- 2007-00 8 FORD E-150 VAN 1/2 TON 4.6L
- 2007-03 8 FORD E-250 VAN 3/4 TON 4.6L

645285

Inlet A: LOOSE 2-BOLT FLANGE W/ FLARE
 Outlet A: 2.50" O.D. PIPE
 Length: 36.50"



- 2006-05 8 LINCOLN NAVIGATOR 5.4L

645286

Inlet A: LOOSE 2-BOLT FLANGE W/ FLARE
 Inlet B: 2.50" I.D. PIPE
 Outlet A: LOOSE 2-BOLT FLANGE W/ FLARE
 Length: 45"



- 2006-05 8 LINCOLN NAVIGATOR 5.4L

645287

Inlet A: WELDED 3-BOLT FLANGE
 Outlet A: 2.85" O.D. PIPE
 Length: 17"



- 2000 8 CHEVROLET SUBURBAN/TAHOE 6.0L
- 2000 8 GMC SUBURBAN/YUKON 6.0L

645288

Inlet A: WELDED 4-BOLT FLANGE
Outlet A: 2.57" O.D. PIPE
Length: 20"



- 2005-00 6 BUICK LESABRE 3.8L
- 2005-00 6 BUICK PARK AVENUE 3.8L
- 2005-00 8 CADILLAC DEVILLE 4.6L
- 2005-00 6 PONTIAC BONNEVILLE 3.8L

645289

Inlet A: LOOSE 2-BOLT FLANGE W/ SPHERICAL FLARE
Inlet B: 2.50" I.D. PIPE
Outlet A: LOOSE 2-BOLT FLANGE W/ SPHERICAL FLARE
Length: 46"



- 2006-05 8 FORD EXPEDITION 5.4L

645290

Inlet A: LOOSE 2-BOLT FLANGE W/ SPHERICAL FLARE
Outlet A: 2.50" O.D. PIPE
Length: 35"



- 2006-05 8 FORD EXPEDITION 5.4L

645291

Inlet A: LOOSE 2-BOLT FLANGE
Inlet B: WELDED 2-BOLT FLANGE
Outlet A: WELDED 2-BOLT FLANGE
Length: 34"



- 2010-07 8 CADILLAC ESCALADE 6.2L
- 2010-09 8 CHEVROLET C-(2WD), K-(4WD) PICKUP 1/2 TON, (Inc. SILVERADO & AVALANCHE) 6.2L
- 2010-09 8 GMC C-(2WD), K-(4WD) PICKUP 1/2 TON, (Inc. SIERRA) 6.2L

645292

Inlet A: LOOSE 2-BOLT FLANGE W/ SPHERICAL FLARE
Inlet B: LOOSE 2-BOLT FLANGE W/ SPHERICAL FLARE
Outlet A: WELDED 4-BOLT FLANGE
Length: 41"



- 2006-05 8 FORD F-350 PICKUP 1 TON 5.4L

645293

Inlet A: WELDED 2-BOLT FLANGE
Outlet A: 2.25" I.D. PIPE
Length: 30.50"



- 2006-05 6 FORD ESCAPE 3.0L
- 2008-05 4 FORD ESCAPE 2.3L
- 2006-05 6 MAZDA TRIBUTE 3.0L
- 2008-05 4 MAZDA TRIBUTE 2.3L
- 2006-05 6 MERCURY MARINER 3.0L
- 2008-05 4 MERCURY MARINER 2.3L

DIRECT FIT



645294

Inlet A: WELDED 2-BOLT FLANGE
 Outlet A: 2-3/4" O.D. PIPE
 Length: 47"



2007 8 DODGE CHARGER 6.1L

645295

Inlet A: WELDED 6-BOLT FLANGE
 Inlet B: WELDED 3-BOLT FLANGE
 Outlet A: WELDED 2-BOLT FLANGE
 Length: 19.88"



2002-01 6 NISSAN QUEST 3.3L

645296

Inlet A: LOOSE 2-BOLT FLANGE
 Outlet A: 2-1/2" I.D. PIPE
 Length: 36"



2005-04 8 DODGE DURANGO 5.7L

645297

Inlet A: WELDED 4-BOLT FLANGE
 Outlet A: 2.50" I.D. PIPE
 Outlet B: 2.50" I.D. PIPE
 Length: 43.50"



2007-06 8 WORKHORSE W42 4.8L

645301

Inlet A: 2.50" I.D. PIPE
 Outlet A: 2.50" O.D. PIPE
 Length: 24.75"



- 1980-75 8 CHECKER MARATHON All
- 1991-86 6 CHEVROLET ASTRO VAN 4.3L
- 1978-75 8 CHEVROLET BLAZER FULL SIZE 6.6L
- 1987-83 8 CHEVROLET BLAZER FULL SIZE All
- 1986-83 6 CHEVROLET C-(2WD), K-(4WD) PICKUP 1/2 TON, (Inc. SILVERADO & AVALANCHE) All
- 1986-83 8 CHEVROLET C-(2WD), K-(4WD) PICKUP 1/2 TON, (Inc. SILVERADO & AVALANCHE) 5.7L
- 1979-75 8 CHEVROLET C-(2WD), K-(4WD) PICKUP 1/2 TON, (Inc. SILVERADO & AVALANCHE) 7.4L
- 1984-75 6 CHEVROLET C-(2WD), K-(4WD) PICKUP 3/4 TON, (Inc. SILVERADO & AVALANCHE) 4.1L
- 1986-85 6 CHEVROLET C-(2WD), K-(4WD) PICKUP 3/4 TON, (Inc. SILVERADO & AVALANCHE) 4.3L
- 1986-83 8 CHEVROLET C-(2WD), K-(4WD) PICKUP 3/4 TON, (Inc. SILVERADO & AVALANCHE) 5.0L
- 1986-83 8 CHEVROLET C-(2WD), K-(4WD) PICKUP 3/4 TON, (Inc. SILVERADO & AVALANCHE) 5.7L
- 1982-75 8 CHEVROLET C-(2WD), K-(4WD) PICKUP 3/4 TON, (Inc. SILVERADO & AVALANCHE) All
- 1979-78 8 CHEVROLET G -VAN 1 TON (Inc. Express Van) All
- 1986-80 8 CHEVROLET G -VAN 1 TON (Inc. Express Van) 5.7L
- 1990-78 6 CHEVROLET G -VAN 1 TON (Inc. Express Van) All
- 1994-91 6 CHEVROLET G -VAN 1 TON (Inc. Express Van) 4.3L
- 1982-75 6 CHEVROLET G -VAN 1/2 & 3/4 TON (Inc. Express Van) 4.1L
- 1994-85 6 CHEVROLET G -VAN 1/2 & 3/4 TON (Inc. Express Van) 4.3L
- 1994-87 8 CHEVROLET G -VAN 1/2 & 3/4 TON (Inc. Express Van) 5.0L
- 1980-79 8 CHEVROLET G -VAN 1/2 & 3/4 TON (Inc.

645301 (cont.)

1986-83	8	Express Van) 6.6L CHEVROLET G -VAN 1/2 & 3/4 TON (Inc. Express Van) All
1987	6	CHEVROLET R-(2WD), V-(4WD) PICKUP 4.3L
1982-75	8	CHEVROLET SUBURBAN/TAHOE All
1986-83	8	CHEVROLET SUBURBAN/TAHOE 5.7L
1987-83	8	CHEVROLET SUBURBAN/TAHOE 5.0L
1986-83	6	GMC C-(2WD), K-(4WD) PICKUP 1/2 TON, (Inc. SIERRA) All
1986-83	8	GMC C-(2WD), K-(4WD) PICKUP 1/2 TON, (Inc. SIERRA) 5.7L
1979-75	8	GMC C-(2WD), K-(4WD) PICKUP 1/2 TON, (Inc. SIERRA) 7.4L
1984-75	6	GMC C-(2WD), K-(4WD) PICKUP 3/4 TON, (Inc. SIERRA) 4.1L
1986-85	6	GMC C-(2WD), K-(4WD) PICKUP 3/4 TON, (Inc. SIERRA) 4.3L
1986-83	8	GMC C-(2WD), K-(4WD) PICKUP 3/4 TON, (Inc. SIERRA) 5.0L
1986-83	8	GMC C-(2WD), K-(4WD) PICKUP 3/4 TON, (Inc. SIERRA) 5.7L
1982-75	8	GMC C-(2WD), K-(4WD) PICKUP 3/4 TON, (Inc. SIERRA) All
1979-78	8	GMC G -VAN 1 TON (Inc. Savana Van) All
1986-80	8	GMC G -VAN 1 TON (Inc. Savana Van) 5.7L
1990-78	6	GMC G -VAN 1 TON (Inc. Savana Van) All
1994-91	6	GMC G -VAN 1 TON (Inc. Savana Van) 4.3L
1980-79	8	GMC G -VAN 1/2 & 3/4 TON (Inc. Savana Van) 6.6L
1982-75	6	GMC G -VAN 1/2 & 3/4 TON (Inc. Savana Van) 4.1L
1986-83	8	GMC G -VAN 1/2 & 3/4 TON (Inc. Savana Van) All
1994-85	6	GMC G -VAN 1/2 & 3/4 TON (Inc. Savana Van) 4.3L
1994-87	8	GMC G -VAN 1/2 & 3/4 TON (Inc. Savana Van) 5.0L
1978-75	8	GMC JIMMY FULL SIZE 6.6L
1987-83	8	GMC JIMMY FULL SIZE All
1991-86	6	GMC SAFARI VAN 4.3L
1982-75	8	GMC SUBURBAN/YUKON All
1986-83	8	GMC SUBURBAN/YUKON 5.7L
1987-83	8	GMC SUBURBAN/YUKON 5.0L

645302

Inlet A: LOOSE 2-BOLT FLANGE W/ FEMALE FLARE
Inlet B: LOOSE 2-BOLT FLANGE W/ FEMALE FLARE
Outlet A: LOOSE 2-BOLT FLANGE W/ FLAT FLARE
Length: 52"

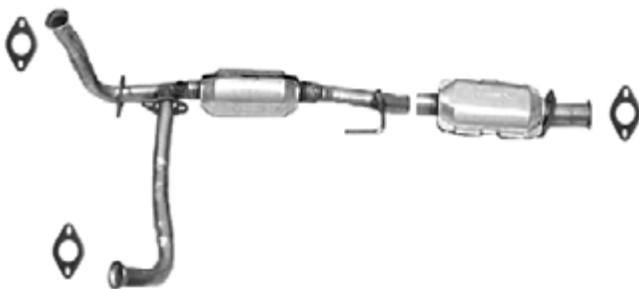

1993-86 6 FORD AEROSTAR 3.0L

645307

Inlet A: 3" I.D. PIPE
Outlet A: LOOSE 4-BOLT FLANGE W/ 3" MALE BALL
Length: 21"



1989-86	8	CHEVROLET CAMARO 5.0L
1989-87	8	CHEVROLET CAMARO 5.7L
1991-86	8	CHEVROLET CORVETTE 5.7L
1995-92	8	CHEVROLET FULL SIZE (Inc. Impala RWD, Caprice, Belair, Police, Taxi, Station Wagon) 5.7L
1989-86	8	PONTIAC FIREBIRD, TRANS AM, FORMULA 5.0L
1989-87	8	PONTIAC FIREBIRD, TRANS AM, FORMULA 5.7L

645308

Inlet A: LOOSE 3-BOLT FLANGE W/ FEMALE FLARE
Outlet A: 2.75" O.D. PIPE
Length: 29.63"

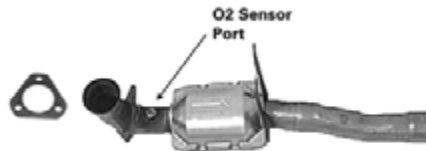

1996-92 8 CHEVROLET CORVETTE 5.7L

645309

Inlet A: LOOSE 3-BOLT FLANGE W/ FEMALE FLARE
Outlet A: LOOSE 3-BOLT FLANGE W/ MALE BALL
Length: 16"



1996-92 8 CHEVROLET CORVETTE 5.7L

DIRECT FIT



645310

Inlet A: 2.25" I.D. PIPE
Outlet A: LOOSE 4-BOLT GM FLANGE W/ 2.50" MALE BALL
Length: 23"



- 1991 8 BUICK ROADMASTER 5.0L
- 1993-92 8 BUICK ROADMASTER 5.7L
- 1993 8 CADILLAC COMMERCIAL CHASSIS - FUNERAL COACH, LIMOUSINE All
- 1986 8 CADILLAC FLEETWOOD 5.0L
- 1993 8 CADILLAC FLEETWOOD 5.7L
- 1992-90 8 CHEVROLET CAMARO 5.7L
- 1993-88 8 CHEVROLET FULL SIZE (Inc. Impala RWD, Caprice, Belair, Police, Taxi, Station Wagon) 5.0L
- 1990-83 8 CHEVROLET FULL SIZE (Inc. Impala RWD, Caprice, Belair, Police, Taxi, Station Wagon) 5.7L
- 1986-85 8 PONTIAC PARISIENNE 5.0L

645315

Inlet A: 2.50" O.D. PIPE
Outlet A: 2.50" O.D. PIPE
Length: 25"



- 1991-84 8 JEEP GRAND CHEROKEE/GRAND WAGONEER 5.9L

645316

Inlet A: 3" I.D. PIPE
Outlet A: 3" O.D. PIPE
Length: 26.25"



- 1993-92 6 CHEVROLET ASTRO VAN 4.3L
- 1994-87 8 CHEVROLET BLAZER FULL SIZE 5.7L
- 1995-88 8 CHEVROLET C-(2WD), K-(4WD) PICKUP 1 TON, (Inc. SILVERADO) All
- 1993-88 8 CHEVROLET C-(2WD), K-(4WD) PICKUP 1/2 TON, (Inc. SILVERADO & AVALANCHE) 5.7L
- 1992-90 8 CHEVROLET C-(2WD), K-(4WD) PICKUP 1/2 TON, (Inc. SILVERADO & AVALANCHE) 7.4L
- 1993-91 6 CHEVROLET C-(2WD), K-(4WD) PICKUP 3/4 TON, (Inc. SILVERADO & AVALANCHE) 4.3L
- 1993-88 8 CHEVROLET C-(2WD), K-(4WD) PICKUP 3/4 TON, (Inc. SILVERADO & AVALANCHE) 5.7L
- 1995-91 8 CHEVROLET C-(2WD), K-(4WD) PICKUP 3/4

645316 (cont.)

- 1991-87 8 TON, (Inc. SILVERADO & AVALANCHE) 7.4L
- 1991-87 8 CHEVROLET G -VAN 1 TON (Inc. Express Van) 5.7L
- 1994-92 8 CHEVROLET G -VAN 1 TON (Inc. Express Van) All
- 1994-87 8 CHEVROLET G -VAN 1/2 & 3/4 TON (Inc. Express Van) 5.7L
- 1989-87 8 CHEVROLET R-(2WD), V-(4WD) PICKUP 5.7L
- 1993-87 8 CHEVROLET SUBURBAN/TAHOE 5.7L
- 1995-87 8 CHEVROLET SUBURBAN/TAHOE 7.4L
- 1995-88 8 GMC C-(2WD), K-(4WD) PICKUP 1 TON, (Inc. SIERRA) All
- 1993-88 8 GMC C-(2WD), K-(4WD) PICKUP 1/2 TON, (Inc. SIERRA) 5.7L
- 1993-91 6 GMC C-(2WD), K-(4WD) PICKUP 3/4 TON, (Inc. SIERRA) 4.3L
- 1993-88 8 GMC C-(2WD), K-(4WD) PICKUP 3/4 TON, (Inc. SIERRA) 5.7L
- 1995-91 8 GMC C-(2WD), K-(4WD) PICKUP 3/4 TON, (Inc. SIERRA) 7.4L
- 1991-87 8 GMC G -VAN 1 TON (Inc. Savana Van) 5.7L
- 1994-92 8 GMC G -VAN 1 TON (Inc. Savana Van) All
- 1994-87 8 GMC G -VAN 1/2 & 3/4 TON (Inc. Savana Van) 5.7L
- 1991-87 8 GMC JIMMY FULL SIZE 5.7L
- 1993-92 6 GMC SAFARI VAN 4.3L
- 1993-87 8 GMC SUBURBAN/YUKON 5.7L
- 1995-87 8 GMC SUBURBAN/YUKON 7.4L

645317

Inlet A: 3" I.D. PIPE
Outlet A: 3" O.D. PIPE
Length: 20"



- 1995-88 8 CHEVROLET C-(2WD), K-(4WD) PICKUP 1 TON, (Inc. SILVERADO) All
- 1993-88 8 CHEVROLET C-(2WD), K-(4WD) PICKUP 3/4 TON, (Inc. SILVERADO & AVALANCHE) 5.7L
- 1995-91 8 CHEVROLET C-(2WD), K-(4WD) PICKUP 3/4 TON, (Inc. SILVERADO & AVALANCHE) 7.4L
- 1991-87 8 CHEVROLET G -VAN 1 TON (Inc. Express Van) 5.7L
- 1994-87 8 CHEVROLET G -VAN 1/2 & 3/4 TON (Inc. Express Van) 5.7L
- 1995-88 8 GMC C-(2WD), K-(4WD) PICKUP 1 TON, (Inc. SIERRA) All
- 1993-88 8 GMC C-(2WD), K-(4WD) PICKUP 3/4 TON, (Inc. SIERRA) 5.7L
- 1995-91 8 GMC C-(2WD), K-(4WD) PICKUP 3/4 TON, (Inc. SIERRA) 7.4L
- 1991-87 8 GMC G -VAN 1 TON (Inc. Savana Van) 5.7L
- 1994-87 8 GMC G -VAN 1/2 & 3/4 TON (Inc. Savana Van) 5.7L

645320

Inlet A: LOOSE 2-BOLT FLANGE W/ FEMALE FLARE
Inlet B: LOOSE 2-BOLT FLANGE W/ FEMALE FLARE
Outlet A: 2.25" O.D. PIPE
Length: 57.75"

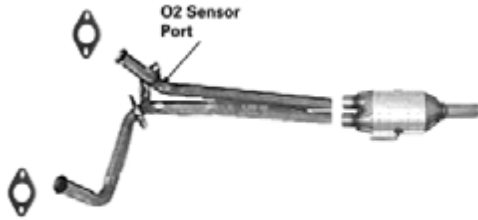

1995-91 8 FORD BRONCO 5.0L

645322

Inlet A: 3.02" O.D. PIPE
Outlet A: 2.75" O.D. PIPE
Length: 24.75"



1993-92 6 DODGE B-VAN 3.9L
1993-92 8 DODGE B-VAN All
1993-92 6 DODGE D-(2WD) & W-(4WD) PICKUP 1/2 & 3/4 TON 3.9L
1993-92 8 DODGE D-(2WD) & W-(4WD) PICKUP 1/2 & 3/4 TON 5.2L
1993-92 8 DODGE D-(2WD) & W-(4WD) PICKUP 1/2 & 3/4 TON 5.9L

645327

Inlet A: 2.50" I.D. PIPE
Outlet A: 2.25" O.D. PIPE
Length: 21.50"



2000-96 4 JEEP CHEROKEE 2.5L
2000-96 6 JEEP CHEROKEE 4.0L
1998-96 8 JEEP GRAND CHEROKEE/GRAND WAGONEER 5.2L
1998 8 JEEP GRAND CHEROKEE/GRAND WAGONEER 5.9L
2000-96 6 JEEP GRAND CHEROKEE/GRAND WAGONEER 4.0L

645328

Inlet A: LOOSE 3-BOLT FLANGE W/ FEMALE FLARE
Inlet B: LOOSE 3-BOLT FLANGE W/ FEMALE FLARE
Outlet A: WELDED 3-BOLT FLANGE
Length: 48.75"

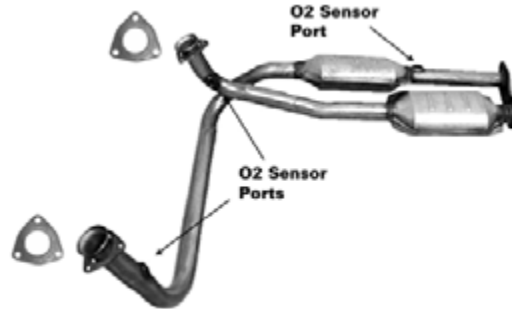

2000-99 8 CADILLAC ESCALADE 5.7L
1999-96 8 CHEVROLET C-(2WD), K-(4WD) PICKUP 1/2 TON, (Inc. SILVERADO & AVALANCHE) 5.7L
1998-96 8 CHEVROLET C-(2WD), K-(4WD) PICKUP 3/4 TON, (Inc. SILVERADO & AVALANCHE) 5.7L
2000-96 8 CHEVROLET SUBURBAN/TAHOE 5.7L
1998-96 8 GMC C-(2WD), K-(4WD) PICKUP 1/2 TON, (Inc. SIERRA) 5.7L
1998-96 8 GMC C-(2WD), K-(4WD) PICKUP 3/4 TON, (Inc. SIERRA) 5.7L
2000-96 8 GMC SUBURBAN/YUKON 5.7L

645332

Inlet A: 2.50" I.D. PIPE
Outlet A: 2.25" O.D. PIPE
Length: 26.25"



1991-87 8 DODGE B-VAN All
1991-88 6 DODGE B-VAN 3.9L

645336

Inlet A: WELDED 3-BOLT FLANGE
Outlet A: LOOSE 6-BOLT FLANGE W/ MALE BALL
Length: 30"

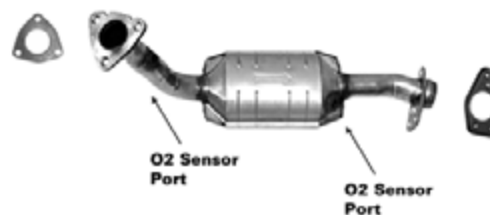

1996-94 8 BUICK ROADMASTER 5.7L
1995-94 8 CADILLAC COMMERCIAL CHASSIS - FUNERAL COACH, LIMOUSINE 5.7L
1996-94 8 CADILLAC FLEETWOOD 5.7L

DIRECT FIT



645336 (cont.)

1996-94 8 CHEVROLET FULL SIZE (Inc. Impala RWD, Caprice, Belair, Police, Taxi, Station Wagon) All

645337

Inlet A: WELDED 3-BOLT FLANGE
Outlet A: LOOSE 6-BOLT FLANGE W/ MALE BALL
Length: 26.75"

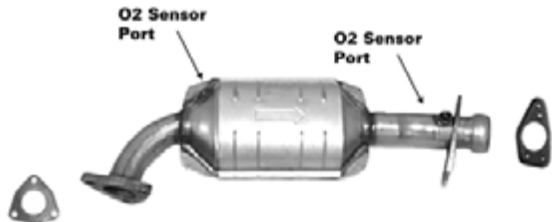

1996-94 8 BUICK ROADMASTER 5.7L
1995-94 8 CADILLAC COMMERCIAL CHASSIS - FUNERAL COACH, LIMOUSINE 5.7L
1996-94 8 CADILLAC FLEETWOOD 5.7L
1996-94 8 CHEVROLET FULL SIZE (Inc. Impala RWD, Caprice, Belair, Police, Taxi, Station Wagon) All

645339

Inlet A: WELDED 3-BOLT FLANGE
Outlet A: LOOSE 2-BOLT FLANGE W/ MALE BALL
Length: 28.50"



1990 6 FORD BRONCO II 2.9L
1994-91 6 FORD EXPLORER 4.0L
1995-90 6 FORD RANGER 4.0L
1995-91 6 FORD RANGER 3.0L
1995-94 6 MAZDA B-Series PICKUP 3.0L
1995-94 6 MAZDA B-Series PICKUP 4.0L
1994-91 6 MAZDA NAVAJO 4.0L

645340

Inlet A: WELDED 3-BOLT FLANGE
Outlet A: LOOSE 2-BOLT FLANGE W/ FLAT FLARE
Length: 28.50"



1989-88 6 FORD BRONCO II 2.9L
1988 6 FORD RANGER 2.9L

645341

Inlet A: 2.50" I.D. PIPE
Outlet A: 2.50" O.D. PIPE
Length: 27.50"



1992 6 CHEVROLET ASTRO VAN 4.3L
1986 8 CHEVROLET C-(2WD), K-(4WD) PICKUP 1 TON, (Inc. SILVERADO) 5.7L
1993-88 6 CHEVROLET C-(2WD), K-(4WD) PICKUP 1/2 TON, (Inc. SILVERADO & AVALANCHE) 4.3L
1993-88 8 CHEVROLET C-(2WD), K-(4WD) PICKUP 1/2 TON, (Inc. SILVERADO & AVALANCHE) 5.0L
1993-88 6 CHEVROLET C-(2WD), K-(4WD) PICKUP 3/4 TON, (Inc. SILVERADO & AVALANCHE) 4.3L
1993-88 8 CHEVROLET C-(2WD), K-(4WD) PICKUP 3/4 TON, (Inc. SILVERADO & AVALANCHE) 5.0L
1987 8 CHEVROLET R-(2WD), V-(4WD) PICKUP 5.0L
1986 8 GMC C-(2WD), K-(4WD) PICKUP 1 TON, (Inc. SIERRA) 5.7L
1993-88 6 GMC C-(2WD), K-(4WD) PICKUP 1/2 TON, (Inc. SIERRA) 4.3L
1993-88 8 GMC C-(2WD), K-(4WD) PICKUP 1/2 TON, (Inc. SIERRA) 5.0L
1993-88 6 GMC C-(2WD), K-(4WD) PICKUP 3/4 TON, (Inc. SIERRA) 4.3L
1993-88 8 GMC C-(2WD), K-(4WD) PICKUP 3/4 TON, (Inc. SIERRA) 5.0L
1992 6 GMC SAFARI VAN 4.3L

645342

Inlet A: LOOSE 3-BOLT FLANGE W/ 45 DEGREE FLARE
Inlet B: LOOSE 3-BOLT FLANGE W/ 45 DEGREE FLARE
Outlet A: LOOSE 2-BOLT FLANGE W/ MALE BALL
Length: 46"



1994 8 CHEVROLET BLAZER FULL SIZE 5.7L
1995-94 6 CHEVROLET C-(2WD), K-(4WD) PICKUP 1/2 TON, (Inc. SILVERADO & AVALANCHE) 4.3L
1995-94 8 CHEVROLET C-(2WD), K-(4WD) PICKUP 1/2 TON, (Inc. SILVERADO & AVALANCHE) 5.0L

645342 (cont.)

1995-94	8	CHEVROLET C-(2WD), K-(4WD) PICKUP 1/2 TON, (Inc. SILVERADO & AVALANCHE) 5.7L
1995-94	6	CHEVROLET C-(2WD), K-(4WD) PICKUP 3/4 TON, (Inc. SILVERADO & AVALANCHE) 4.3L
1995-94	8	CHEVROLET C-(2WD), K-(4WD) PICKUP 3/4 TON, (Inc. SILVERADO & AVALANCHE) 5.0L
1995-94	8	CHEVROLET C-(2WD), K-(4WD) PICKUP 3/4 TON, (Inc. SILVERADO & AVALANCHE) 5.7L
1995-94	8	CHEVROLET SUBURBAN/TAHOE 5.7L
1995-94	6	GMC C-(2WD), K-(4WD) PICKUP 1/2 TON, (Inc. SIERRA) 4.3L
1995-94	8	GMC C-(2WD), K-(4WD) PICKUP 1/2 TON, (Inc. SIERRA) 5.0L
1995-94	8	GMC C-(2WD), K-(4WD) PICKUP 1/2 TON, (Inc. SIERRA) 5.7L
1995-94	6	GMC C-(2WD), K-(4WD) PICKUP 3/4 TON, (Inc. SIERRA) 4.3L
1995-94	8	GMC C-(2WD), K-(4WD) PICKUP 3/4 TON, (Inc. SIERRA) 5.0L
1995-94	8	GMC C-(2WD), K-(4WD) PICKUP 3/4 TON, (Inc. SIERRA) 5.7L
1995-94	8	GMC SUBURBAN/YUKON 5.7L

645343

Inlet A: WELDED 4-BOLT FLANGE W/ STUDS
Outlet A: 2.50" O.D. PIPE
Length: 29.25"



1993-87	8	FORD E-250 VAN 3/4 TON 7.5L
1995-88	8	FORD E-250 VAN 3/4 TON 5.8L
1995-87	8	FORD E-350 VAN 1 TON 7.5L
1995-88	8	FORD E-350 VAN 1 TON 5.8L
1997-87	8	FORD F-250 PICKUP 3/4 TON 5.8L
1997-87	8	FORD F-250 PICKUP 3/4 TON 7.5L
1997-87	8	FORD F-350 PICKUP 1 TON 5.8L
1997-87	8	FORD F-350 PICKUP 1 TON 7.5L

645344

Inlet A: 3" I.D. PIPE
Outlet A: 3" O.D. PIPE
Length: 30"



1995-87	8	FORD F-250 PICKUP 3/4 TON 5.8L
1995-87	8	FORD F-250 PICKUP 3/4 TON 7.5L
1997-88	8	FORD F-350 PICKUP 1 TON 5.8L
1997-88	8	FORD F-350 PICKUP 1 TON 7.5L

645345

Inlet A: WELDED 4-BOLT FLANGE W/ STUDS
Outlet A: 3" O.D. PIPE
Length: 29.25"



1997-87	8	FORD F-250 PICKUP 3/4 TON 5.8L
1997-87	8	FORD F-250 PICKUP 3/4 TON 7.5L
1997-88	8	FORD F-350 PICKUP 1 TON 5.8L
1997-88	8	FORD F-350 PICKUP 1 TON 7.5L

645346

Inlet A: LOOSE 2-BOLT FLANGE W/ FEMALE FLARE
Outlet A: 2.50" O.D. PIPE
Length: 38.75"



1999-97	6	FORD E-150 VAN 1/2 TON 4.2L
1999-97	6	FORD E-250 VAN 3/4 TON 4.2L

645347

Inlet A: 2.50" I.D. PIPE
Outlet A: WELDED 3-BOLT FLANGE W/ GASKET STUB
Length: 23.25"

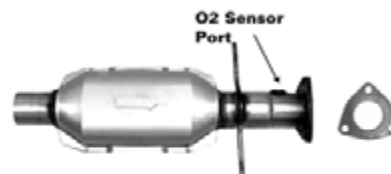

1995	6	CHEVROLET S-Series (2WD), T-Series (4WD) PICKUP 4.3L
1995	6	GMC S-Series (2WD), T-Series (4WD) PICKUP (SONOMA) 4.3L

645348

Inlet A: WELDED 3-BOLT FLANGE
Outlet A: WELDED 3-BOLT FLANGE
Length: 25.25"



1997-96	6	CHEVROLET S-Series (2WD), T-Series (4WD)
---------	---	--

DIRECT FIT



645348 (cont.)

- PICKUP 4.3L
- 1997-96 6 GMC S-Series (2WD), T-Series (4WD) PICKUP (SONOMA) 4.3L
- 1997 6 ISUZU PICKUP 4.3L

645349

Inlet A: 2.25" I.D. PIPE
 Outlet A: 2.25" O.D. PIPE
 Length: 23.88"

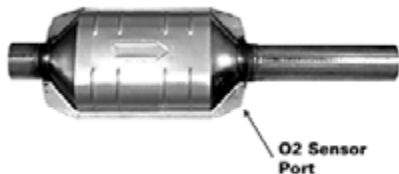

- 1995-93 6 JEEP WRANGLER 4.0L

645350

Inlet A: LOOSE 3-BOLT FLANGE W/ 45 DEGREE FLARE
 Inlet B: LOOSE 3-BOLT FLANGE W/ 45 DEGREE FLARE
 Outlet A: 3" O.D. PIPE
 Length: 41.75"

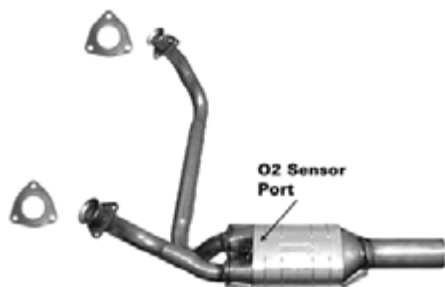

- 1995 6 CHEVROLET G -VAN 1/2 & 3/4 TON (Inc. Express Van) 4.3L
- 1995 8 CHEVROLET G -VAN 1/2 & 3/4 TON (Inc. Express Van) 5.0L
- 1995 8 CHEVROLET G -VAN 1/2 & 3/4 TON (Inc. Express Van) 5.7L
- 1995 6 GMC G -VAN 1/2 & 3/4 TON (Inc. Savana Van) 4.3L
- 1995 8 GMC G -VAN 1/2 & 3/4 TON (Inc. Savana Van) 5.0L
- 1995 8 GMC G -VAN 1/2 & 3/4 TON (Inc. Savana Van) 5.7L

645354

Inlet A: LOOSE 3-BOLT FLANGE W/ FEMALE FLARE
 Inlet B: LOOSE 3-BOLT FLANGE W/ FEMALE FLARE
 Outlet A: LOOSE 4-BOLT FLANGE W/ MALE BALL
 Length: 46.75"

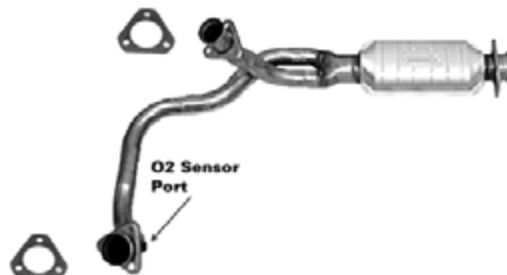

- 1995-93 8 CHEVROLET CAMARO 5.7L
- 1995-93 8 PONTIAC FIREBIRD, TRANS AM, FORMULA 5.7L

645355

Inlet A: WELDED 2-BOLT FLANGE
 Outlet A: WELDED 2-BOLT FLANGE
 Length: 17.63"



- 2000-95 4 TOYOTA TACOMA 2.7L
- 2000-95 6 TOYOTA TACOMA 3.4L

645356

Inlet A: 2.50" I.D. PIPE
 Outlet A: LOOSE 4-BOLT FLANGE W/ MALE BALL
 Length: 17"



- 1994-92 6 CHEVROLET BLAZER S-Series 4.3L
- 1994-92 6 GMC S-15 JIMMY 4.3L
- 1994-92 6 OLDSMOBILE BRAVADA 4.3L

645357

Inlet A: WELDED 4-BOLT FLANGE
Outlet A: 2.50" O.D. PIPE
Length: 23"



- 1999-97 6 BUICK LESABRE 3.8L
- 1999-97 6 BUICK PARK AVENUE 3.8L
- 1997 6 BUICK RIVIERA 3.8L
- 1999-96 8 OLDSMOBILE AURORA 4.0L
- 1999-97 6 OLDSMOBILE EIGHTY-EIGHT, DELTA 88 3.8L
- 1998-97 6 OLDSMOBILE REGENCY 3.8L
- 1999-97 6 PONTIAC BONNEVILLE 3.8L

645358

Inlet A: WELDED 3-BOLT FLANGE
Outlet A: LOOSE 2-BOLT FLANGE W/ MALE BALL
Length: 23.50"



- 2003-00 6 JEEP WRANGLER 4.0L

645359

Inlet A: WELDED 4-BOLT FLANGE
Outlet A: WELDED 2-BOLT FLANGE
Length: 34"

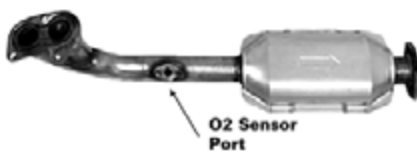

- 2000-96 6 TOYOTA 4 RUNNER 3.4L

645360

Inlet A: WELDED 3-BOLT FLANGE
Outlet A: WELDED 2-BOLT FLANGE W/ GASKET STUB
Length: 33"



- 1998-95 6 FORD EXPLORER 4.0L

645363

Inlet A: WELDED 3-BOLT FLANGE
Outlet A: LOOSE 2-BOLT FLANGE W/ MALE BALL
Length: 27.50"



- 1997-95 8 CHEVROLET CAMARO 5.7L
- 1997-95 8 PONTIAC FIREBIRD, TRANS AM, FORMULA 5.7L

645364

Inlet A: WELDED 6-BOLT FLANGE
Outlet A: 2.16" O.D. PIPE
Length: 42.50"



- 2001-98 4 VOLKSWAGEN BEETLE 2.0L
- 2001-99 4 VOLKSWAGEN GOLF 2.0L
- 2001-99 4 VOLKSWAGEN JETTA 2.0L

645365

Inlet A: WELDED 3-BOLT FLANGE
Outlet A: WELDED 2-BOLT FLANGE W/ GASKET STUB
Length: 36.25"



- 2000-98 6 FORD RANGER 3.0L
- 2000-98 6 FORD RANGER 4.0L
- 1999-98 6 MAZDA B-Series PICKUP 3.0L

DIRECT FIT



645365 (cont.)

1999-98 6 MAZDA B-Series PICKUP 4.0L

645366

Inlet A: 2.50" I.D. PIPE
 Outlet A: 2.50" O.D. PIPE
 Length: 47.50"



1990-86 8 DODGE D-(2WD) & W-(4WD) PICKUP 1/2 & 3/4 TON 5.2L

645370

Inlet A: WELDED 2-BOLT FLANGE
 Inlet B: WELDED 2-BOLT FLANGE
 Outlet A: WELDED 3-BOLT FLANGE
 Length: 21.25"



1998-96 8 FORD EXPLORER 5.0L
 1998-97 8 MERCURY MOUNTAINEER 5.0L

645371

Inlet A: (4) WELDED 2-BOLT FLANGES
 Outlet A: LOOSE 2-BOLT FLANGE W/ 2.25" MALE BALL
 Length: 28"

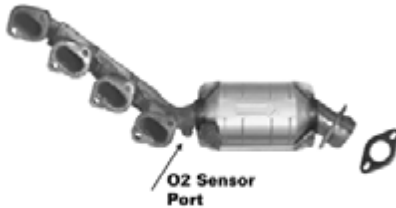

1996-93 8 LINCOLN MARK Series 4.6L

645372

Inlet A: WELDED 3-BOLT FLANGE
 Outlet A: WELDED 3-BOLT FLANGE
 Length: 21.75"



1999-96 6 CHEVROLET S-Series (2WD), T-Series (4WD) PICKUP 4.3L
 1999-96 6 GMC S-Series (2WD), T-Series (4WD) PICKUP (SONOMA) 4.3L
 1999-98 6 ISUZU PICKUP 4.3L

645373

Inlet A: WELDED 3-BOLT FLANGE W/ STUDS
 Outlet A: WELDED 2-BOLT FLANGE
 Length: 24.75"

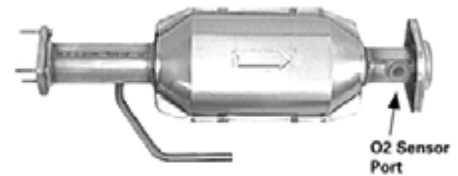

2002-01 4 JEEP WRANGLER 2.5L
 2003-00 6 JEEP WRANGLER 4.0L

645374

Inlet A: WELDED 3-BOLT FLANGE
 Outlet A: LOOSE 2-BOLT FLANGE W/ 2.25" MALE BALL
 Length: 18"



1999-98 8 CHEVROLET CAMARO 5.7L
 1999-98 8 PONTIAC FIREBIRD, TRANS AM, FORMULA 5.7L

645375

Inlet A: LOOSE 2-BOLT FLANGE W/ FEMALE FLARE
 Outlet A: 2.50" O.D. PIPE
 Length: 38"



1992 8 CADILLAC COMMERCIAL CHASSIS -

645375 (cont.)

FUNERAL COACH, LIMOUSINE 4.9L
 1990-88 8 CADILLAC DEVILLE 4.5L
 1992 8 CADILLAC FLEETWOOD 4.9L
 1993-92 6 PONTIAC BONNEVILLE 3.8L

645382

Inlet A: LOOSE 3-BOLT FLANGE W/ 45 DEGREE FLARE
 Outlet A: FEMALE FLARE
 Length: 31.25"



2002-99 4 SAAB 9-3 All
 1998-96 4 SAAB 900 2.0L

645384

Inlet A: LOOSE 2-BOLT FLANGE W/ FEMALE FLARE
 Inlet B: 2.50" I.D. PIPE
 Outlet A: 2.50" O.D. PIPE
 Length: 47.38"



2000-97 8 FORD EXPEDITION 5.4L
 2000-98 8 FORD F-150 PICKUP 1/2 TON 5.4L
 1999-98 8 FORD F-250 PICKUP 3/4 TON 5.4L
 2000-98 8 LINCOLN NAVIGATOR 5.4L

645385

Inlet A: LOOSE 2-BOLT FLANGE W/ FEMALE FLARE
 Outlet A: 2.50" O.D. PIPE
 Length: 46"



2000-97 8 FORD EXPEDITION 5.4L
 2000-98 8 FORD F-150 PICKUP 1/2 TON 5.4L
 1999-98 8 FORD F-250 PICKUP 3/4 TON 5.4L
 2000-98 8 LINCOLN NAVIGATOR 5.4L

645387

Inlet A: LOOSE 3-BOLT FLANGE W/ 45 DEGREE FLARE
 Outlet A: WELDED 2-BOLT FLANGE
 Length: 35.75"



1999 4 SAAB 9-5 2.3L

645388

Inlet A: LOOSE 2-BOLT FLANGE W/ SPHERICAL FLARE
 Inlet B: 2.50" I.D. PIPE
 Outlet A: 2.50" O.D. PIPE
 Length: 46.75"



2003-97 6 FORD F-150 PICKUP 1/2 TON 4.2L

645389

Inlet A: LOOSE 2-BOLT FLANGE W/ SPHERICAL FLARE
 Outlet A: 2.50" O.D. PIPE
 Length: 36"



2003-97 6 FORD F-150 PICKUP 1/2 TON 4.2L

645391

Inlet A: WELDED 3-BOLT FLANGE W/ SPECIAL FLANGE
 Outlet A: WELDED 2-BOLT FLANGE
 Length: 32"



2000-99 6 FORD EXPLORER 4.0L

DIRECT FIT



645392

Inlet A: WELDED 3-BOLT FLANGE
 Outlet A: 2.550" O.D. PIPE
 Outlet B: 2.550" O.D. PIPE
 Length: 37.50"



- 1999-96 8 CHEVROLET C-(2WD), K-(4WD) PICKUP 1 TON, (Inc. SILVERADO) 5.7L
- 1999-96 8 CHEVROLET C-(2WD), K-(4WD) PICKUP 3/4 TON, (Inc. SILVERADO & AVALANCHE) 5.7L
- 1999-96 8 GMC C-(2WD), K-(4WD) PICKUP 1 TON, (Inc. SIERRA) 5.7L
- 1999-96 8 GMC C-(2WD), K-(4WD) PICKUP 3/4 TON, (Inc. SIERRA) 5.7L

645393

Inlet A: (4) WELDED 2-BOLT FLANGES
 Outlet A: 2-BOLT FLANGE W/ MALE BALL
 Length: 28"



- 1998-97 8 LINCOLN MARK Series 4.6L

645394

Inlet A: WELDED 2-BOLT FLANGE
 Outlet A: WELDED 2-BOLT FLANGE W/ GASKET STUB
 Length: 32.88"



- 1998-96 6 TOYOTA PICKUP (ALL MODELS Exc. TACOMA & TUNDRA) 3.4L

645395

Inlet A: LOOSE 2-BOLT FLANGE W/ SPHERICAL FLARE
 Inlet B: 2.50" I.D. PIPE
 Outlet A: 2.50" O.D. PIPE
 Length: 45.25"



- 2000-97 8 FORD F-150 PICKUP 1/2 TON 4.6L
- 1998-97 8 FORD F-250 PICKUP 3/4 TON 4.6L

645396

Inlet A: LOOSE 2-BOLT FLANGE W/ SPHERICAL FLARE
 Outlet A: 2.50" O.D. PIPE
 Length: 35"



- 2000-97 8 FORD F-150 PICKUP 1/2 TON 4.6L
- 1998-97 8 FORD F-250 PICKUP 3/4 TON 4.6L

645397

Inlet A: WELDED 3-BOLT FLANGE W/ GASKET STUB
 Outlet A: WELDED 2-BOLT FLANGE W/ GASKET STUB
 Length: 27"



- 2002-00 8 TOYOTA TUNDRA 4.7L

645398

Inlet A: WELDED 3-BOLT FLANGE W/ GASKET STUB
 Outlet A: WELDED 2-BOLT FLANGE W/ GASKET STUB
 Length: 49.75"

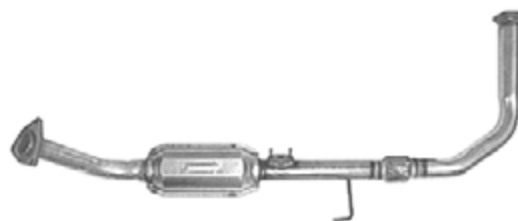

- 2002-00 8 TOYOTA TUNDRA 4.7L

645399

Inlet A: LOOSE 2-BOLT FLANGE W/ SPHERICAL FLARE
Outlet A: 2.50" O.D. PIPE
Length: 35.50"



2004-01 8 FORD F-150 PICKUP 1/2 TON 5.4L

645400

Inlet A: WELDED 2-BOLT FLANGE W/ GASKET STUB
Inlet B: WELDED 2-BOLT FLANGE W/ GASKET STUB
Outlet A: WELDED 2-BOLT FLANGE W/ GASKET STUB
Length: 37"



2003-01 6 TOYOTA SIENNA 3.0L

645401

Inlet A: WELDED 2-BOLT FLANGE W/ SPHERICAL FLARE
Outlet A: WELDED 2-BOLT FLANGE
Length: 35.50"

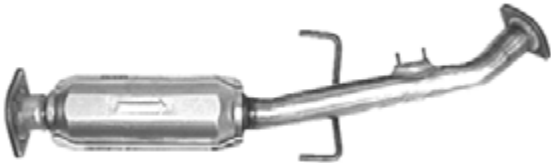

2003-01 6 TOYOTA SIENNA 3.0L

645402

Inlet A: LOOSE 2-BOLT FLANGE W/ SPHERICAL FLARE
Inlet B: 2.50" I.D. PIPE
Outlet A: 2.50" O.D. PIPE
Length: 47"



2000-99 8 FORD EXPEDITION 4.6L

645402 (cont.)

2000-97 8 FORD F-150 PICKUP 1/2 TON 4.6L

645403

Inlet A: LOOSE 2-BOLT FLANGE W/ SPHERICAL FLARE
Outlet A: 2.50" O.D. PIPE
Length: 34"



2000-99 8 FORD EXPEDITION 4.6L
2000-97 8 FORD F-150 PICKUP 1/2 TON 4.6L

645404

Inlet A: WELDED 3-BOLT FLANGE
Outlet A: 2.165" O.D. PIPE
Length: 43.50"



2000-97 6 VOLKSWAGEN EUROVAN 2.8L

645405

Inlet A: LOOSE 2-BOLT FLANGE W/ SPHERICAL FLARE
Outlet A: 2.25" O.D. PIPE
Length: 47.25"



1998-97 4 JEEP WRANGLER 2.5L

645406

Inlet A: LOOSE 2-BOLT FLANGE W/ SPHERICAL FLARE
Outlet A: 2.25" O.D. PIPE
Length: 47.75"

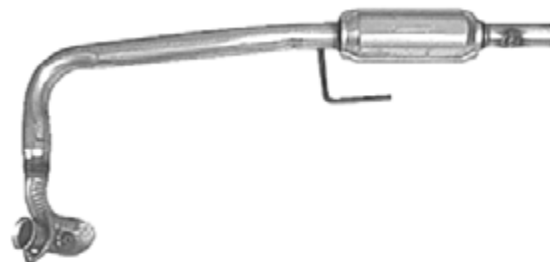

2000-99 4 JEEP WRANGLER 2.5L

DIRECT FIT



645407

Inlet A: WELDED 3-BOLT FLANGE
 Outlet A: LOOSE 2-BOLT FLANGE W/ MALE BALL
 Length: 25.38"



- 2002-00 8 CHEVROLET CAMARO 5.7L
- 2002-00 8 PONTIAC FIREBIRD, TRANS AM, FORMULA 5.7L

645408

Inlet A: WELDED 3-BOLT FLANGE
 Outlet A: LOOSE 2-BOLT FLANGE W/ MALE BALL
 Length: 18"



- 2002-00 8 CHEVROLET CAMARO 5.7L
- 2002-00 8 PONTIAC FIREBIRD, TRANS AM, FORMULA 5.7L

645409

Inlet A: WELDED 2-BOLT FLANGE
 Outlet A: 2" O.D. PIPE
 Length: 30.50"



- 2004-01 6 FORD ESCAPE 3.0L
- 2004-01 6 MAZDA TRIBUTE 3.0L

645410

Inlet A: WELDED 4-BOLT FLANGE
 Outlet A: 2.63" O.D. PIPE
 Length: 23.38"



- 1999-97 6 BUICK LESABRE 3.8L

645410 (cont.)

- 1999-97 6 BUICK PARK AVENUE 3.8L
- 1997 6 BUICK RIVIERA 3.8L
- 1999-96 8 OLDSMOBILE AURORA 4.0L
- 1999-97 6 OLDSMOBILE EIGHTY-EIGHT, DELTA 88 3.8L
- 1998-97 6 OLDSMOBILE REGENCY 3.8L
- 1999-97 6 PONTIAC BONNEVILLE 3.8L

645412

Inlet A: LOOSE 2-BOLT FLANGE W/ SPHERICAL FLARE
 Inlet B: 2.50" I.D. PIPE
 Outlet A: 2.50" O.D. PIPE
 Length: 47.13"



- 2000 8 FORD EXPEDITION 4.6L
- 2003-01 8 FORD F-150 PICKUP 1/2 TON 4.6L

645413

Inlet A: LOOSE 2-BOLT FLANGE W/ SPHERICAL FLARE
 Outlet A: 2.50" O.D. PIPE
 Length: 35.50"



- 2000 8 FORD EXPEDITION 4.6L
- 2003-01 8 FORD F-150 PICKUP 1/2 TON 4.6L

645414

Inlet A: WELDED 3-BOLT FLANGE W/ GASKET STUB
 Outlet A: WELDED 2-BOLT FLANGE
 Length: 42"



- 2004-01 8 TOYOTA SEQUOIA 4.7L

645415

Inlet A: LOOSE 2-BOLT FLANGE W/ SPHERICAL FLARE
Inlet B: 2.63" O.D. PIPE
Outlet A: 2.50" O.D. PIPE
Length: 47"



2002-01 8 FORD F-150 PICKUP 1/2 TON 5.4L

645416

Inlet A: LOOSE 2-BOLT FLANGE W/ SPHERICAL FLARE
Outlet A: 2.50" O.D. PIPE
Length: 34.25"



2002-01 8 FORD F-150 PICKUP 1/2 TON 5.4L

645417

Inlet A: 2.50" I.D. PIPE
Outlet A: 2.50" O.D. PIPE
Length: 32"



2004-02 6 JEEP GRAND CHEROKEE/GRAND WAGONEER 4.0L

2004-02 8 JEEP GRAND CHEROKEE/GRAND WAGONEER 4.7L

645418

Inlet A: WELDED 3-BOLT FLANGE
Outlet A: WELDED 2-BOLT FLANGE W/ GASKET STUB
Length: 36.13"



2003-01 6 FORD RANGER 3.0L
2003-01 6 FORD RANGER 4.0L
2003-01 6 MAZDA B-Series PICKUP 3.0L

645418 (cont.)

2003-01 6 MAZDA B-Series PICKUP 4.0L

645419

Inlet A: WELDED 2-BOLT FLANGE
Outlet A: WELDED 2-BOLT FLANGE W/ GASKET STUB
Length: 31.75"



2004-00 4 TOYOTA TACOMA 2.7L

2004-99 4 TOYOTA TACOMA 2.4L

645420

Inlet A: WELDED 3-BOLT FLANGE
Outlet A: WELDED 2-BOLT FLANGE W/ GASKET STUB
Length: 32.50"



2002-98 6 FORD EXPLORER 4.0L

2001-98 6 MERCURY MOUNTAINEER 4.0L

645421

Inlet A: 2.50" I.D. PIPE
Outlet A: 2.25" O.D. PIPE
Length: 28"



1999-97 4 JEEP WRANGLER 2.5L

1999-97 6 JEEP WRANGLER 4.0L

645422

Inlet A: 2.50" I.D. PIPE
Outlet A: 2.25" O.D. PIPE
Length: 34.13"



2001-99 8 JEEP GRAND CHEROKEE/GRAND WAGONEER 4.7L

2001 6 JEEP GRAND CHEROKEE/GRAND

DIRECT FIT



645422 (cont.)

WAGONEER 4.0L

645423

Inlet A: WELDED 3-BOLT FLANGE
 Outlet A: WELDED 2-BOLT FLANGE
 Length: 18.50"



2001-00 6 JEEP CHEROKEE 4.0L

645424

Inlet A: WELDED 2-BOLT FLANGE
 Outlet A: WELDED 2-BOLT FLANGE W/ GASKET STUB
 Length: 31.25"



2002-99 6 TOYOTA 4 RUNNER 3.4L

645425

Inlet A: WELDED 3-BOLT FLANGE
 Outlet A: 2.3" O.D. PIPE
 Outlet B: 2.610" O.D. PIPE
 Length: 33.50"

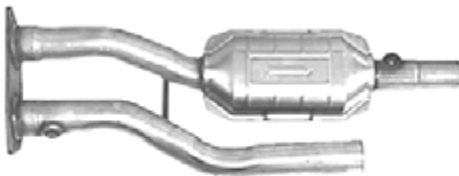

- 1999-96 8 CHEVROLET C-(2WD), K-(4WD) PICKUP 1 TON, (Inc. SILVERADO) 5.7L
- 1999-96 8 CHEVROLET C-(2WD), K-(4WD) PICKUP 3/4 TON, (Inc. SILVERADO & AVALANCHE) 5.7L
- 1999-96 8 GMC C-(2WD), K-(4WD) PICKUP 1 TON, (Inc. SIERRA) 5.7L
- 1999-96 8 GMC C-(2WD), K-(4WD) PICKUP 3/4 TON, (Inc. SIERRA) 5.7L

645426

Inlet A: WELDED 3-BOLT FLANGE W/ GASKET STUB
 Outlet A: WELDED 2-BOLT FLANGE W/ GASKET STUB
 Length: 33.38"



2006-05 8 TOYOTA TUNDRA 4.7L

645427

Inlet A: LOOSE 3-BOLT FLANGE W/ FLARE
 Inlet B: WELDED 3-BOLT FLANGE
 Outlet A: WELDED 2-BOLT FLANGE
 Length: 42"

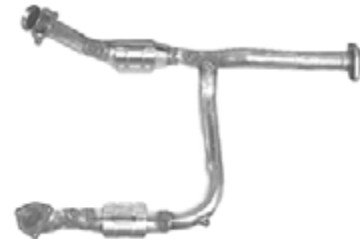

2004-03 8 CHEVROLET SSR 5.3L

645428

Inlet A: LOOSE 2-BOLT FLANGE W/ SPHERICAL FLARE
 Inlet B: LOOSE 2-BOLT FLANGE W/ SPHERICAL FLARE
 Outlet A: 2.50" O.D. PIPE
 Length: 32.75"



- 2005 8 DODGE DAKOTA 4.7L
- 2008-06 6 DODGE DAKOTA 3.7L

645429

Inlet A: WELDED 3-BOLT FLANGE
Outlet A: WELDED 2-BOLT FLANGE
Length: 39.75"



2006-03 8 HUMMER H2 6.0L

645430

Inlet A: LOOSE 2-BOLT FLANGE W/ SPHERICAL FLARE
Inlet B: LOOSE 2-BOLT FLANGE W/ SPHERICAL FLARE
Outlet A: WELDED 2-BOLT FLANGE W/ GASKET STUB
Length: 44.75"



2010-06 6 FORD EXPLORER 4.0L
2010-06 6 MERCURY MOUNTAINEER 4.0L

645431

Inlet A: LOOSE 2-BOLT FLANGE W/ SPHERICAL FLARE
Inlet B: 2.50" I.D. PIPE
Outlet A: LOOSE 2-BOLT FLANGE W/ SPHERICAL FLARE
Length: 45"

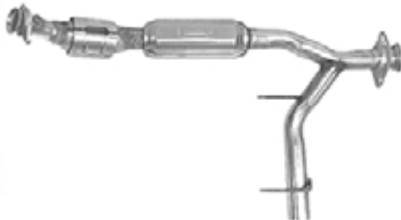

2004-03 8 FORD EXPEDITION 4.6L

645432

Inlet A: LOOSE 2-BOLT FLANGE W/ SPHERICAL FLARE
Inlet B: 2.50" I.D. PIPE
Outlet A: 2.50" O.D. PIPE
Length: 49"



1998-97 6 FORD F-150 PICKUP 1/2 TON 4.2L

645433

Inlet A: LOOSE 2-BOLT FLANGE W/ SPHERICAL FLARE
Outlet A: 2.50" O.D. PIPE
Length: 36.50"



2004-03 8 FORD EXPEDITION 4.6L

645434

Inlet A: LOOSE 2-BOLT FLANGE W/ SPHERICAL FLARE
Outlet A: 2.50" O.D. PIPE
Length: 36.75"



1998-97 6 FORD F-150 PICKUP 1/2 TON 4.2L

645435

Inlet A: 45 DEGREE SPHERICAL FLARE
Outlet A: WELDED 2-BOLT FLANGE
Length: 23.50"



2004 6 JEEP LIBERTY 3.7L

DIRECT FIT



645436

Inlet A: LOOSE 2-BOLT FLANGE W/ FLARE
 Outlet A: 2.25" O.D. PIPE
 Length: 45.75"



2005-04 8 DODGE RAM (2WD & 4WD) PICKUP 1/2 & 3/4 TON 5.7L

645437

Inlet A: WELDED 2-BOLT FLANGE
 Outlet A: 2.650" O.D. PIPE
 Length: 23.75"



2008-05 8 GMC C5500 8.1L

645438

Inlet A: LOOSE 2-BOLT FLANGE W/ FLARE
 Outlet A: 2.25" O.D. PIPE
 Length: 45"



2005-04 6 DODGE RAM (2WD & 4WD) PICKUP 1/2 & 3/4 TON 3.7L

2005-04 8 DODGE RAM (2WD & 4WD) PICKUP 1/2 & 3/4 TON 4.7L

645439

Inlet A: WELDED 3-BOLT FLANGE
 Outlet A: 2.165" O.D. PIPE
 Length: 19.38"



1998-96 6 VOLKSWAGEN GOLF 2.8L

1997-96 6 VOLKSWAGEN PASSAT 2.8L

645440

Inlet A: WELDED 2-BOLT FLANGE W/ GASKET STUB
 Outlet A: LOOSE 2-BOLT FLANGE W/ FLAT FLARE
 Length: 17.25"



1996 6 MAZDA MILLENIA 2.5L

645441

Inlet A: WELDED 2-BOLT FLANGE
 Outlet A: 2.25" O.D. PIPE
 Length: 24.75"



2004 6 MITSUBISHI ENDEAVOR 3.8L

645442

Inlet A: WELDED 3-BOLT FLANGE
 Outlet A: WELDED 2-BOLT FLANGE W/ GASKET STUB
 Length: 18.75" (W/ STUDS)



2006-04 6 FORD RANGER 3.0L

2006-04 6 FORD RANGER 4.0L

2006-04 6 MAZDA B-Series PICKUP 3.0L

2006-04 6 MAZDA B-Series PICKUP 4.0L

645443

Inlet A: LOOSE 2-BOLT FLANGE W/ SPHERICAL FLARE
 Inlet B: 2-1/2" I.D. PIPE
 Outlet A: LOOSE 2-BOLT FLANGE W/ SPHERICAL FLARE
 Length: 45.50"



2004-03 8 FORD EXPEDITION 5.4L

645446

Inlet A: LOOSE 2-BOLT FLANGE W/ SPHERICAL FLARE
 Outlet A: 2.50" O.D. PIPE
 Length: 45.25"



2002-01 8 FORD EXPEDITION 5.4L
 2002-01 8 LINCOLN NAVIGATOR 5.4L

645444

Inlet A: LOOSE 2-BOLT FLANGE W/ SPHERICAL FLARE
 Outlet A: 2-1/2" O.D. PIPE
 Length: 35.25"



2004-03 8 FORD EXPEDITION 5.4L

645447

Inlet A: WELDED 2-BOLT FLANGE
 Outlet A: WELDED 2-BOLT FLANGE
 Length: 20.50"



2002-01 6 MITSUBISHI MONTERO 3.5L

645445

Inlet A: LOOSE 2-BOLT FLANGE W/ SPHERICAL FLARE
 Inlet B: 2.50" I.D. PIPE
 Outlet A: 2.50" O.D. PIPE
 Length: 46.25"



2002-01 8 FORD EXPEDITION 5.4L
 2002-01 8 LINCOLN NAVIGATOR 5.4L

645448

Inlet A: WELDED 3-BOLT FLANGE
 Outlet A: WELDED 2-BOLT FLANGE
 Length: 40.50"



2006-02 8 CADILLAC ESCALADE 6.0L
 2006-03 8 CHEVROLET C-(2WD), K-(4WD) PICKUP 1/2 TON, (Inc. SILVERADO & AVALANCHE) 6.0L
 2006-01 8 GMC SUBURBAN/YUKON 6.0L

DIRECT FIT



645449

Inlet A: LOOSE 2-BOLT FLANGE W/ SPHERICAL FLARE
 Outlet A: 2.50" O.D. PIPE
 Length: 36.75"



2005-04 8 FORD F-150 PICKUP 1/2 TON 4.6L

645450

Inlet A: LOOSE 2-BOLT FLANGE W/ SPHERICAL FLARE
 Inlet B: LOOSE 2-BOLT FLANGE W/ SPHERICAL FLARE
 Outlet A: WELDED 2-BOLT FLANGE
 Length: 38.25"



2007-06 6 JEEP COMMANDER 3.7L
 2006-05 6 JEEP GRAND CHEROKEE/GRAND WAGONEER 3.7L

645451

Inlet A: WELDED 2-BOLT FLANGE
 Outlet A: 2.580" O.D. PIPE
 Length: 26.25"



2000-99 8 CHEVROLET C-(2WD), K-(4WD) PICKUP 3/4 TON, (Inc. SILVERADO & AVALANCHE) 6.0L
 2000-99 8 GMC C-(2WD), K-(4WD) PICKUP 3/4 TON, (Inc. SIERRA) 6.0L

645452

Inlet A: WELDED 2-BOLT FLANGE
 Outlet A: 2.25" O.D. PIPE
 Length: 29.50"



2008-07 4 DODGE CALIBER 2.4L
 2008-07 4 JEEP COMPASS 2.0L
 2009-07 4 JEEP COMPASS 2.4L
 2008-07 4 JEEP PATRIOT 2.0L
 2008-07 4 JEEP PATRIOT 2.4L

645453

Inlet A: WELDED 2-BOLT FLANGE
 Outlet A: 2.4" O.D. PIPE
 Length: 22.38"



2002-01 8 CHEVROLET SUBURBAN/TAHOE 6.0L

645454

Inlet A: WELDED 2-BOLT FLANGE
 Outlet A: 2.85" O.D. PIPE
 Length: 30.50"



2006-04 8 CHEVROLET C-(2WD), K-(4WD) PICKUP 1 TON, (Inc. SILVERADO) 6.0L
 2006-04 8 CHEVROLET C-(2WD), K-(4WD) PICKUP 1 TON, (Inc. SILVERADO) 8.1L
 2006-02 8 CHEVROLET C-(2WD), K-(4WD) PICKUP 1/2 TON, (Inc. SILVERADO & AVALANCHE) 6.0L
 2006-01 8 CHEVROLET C-(2WD), K-(4WD) PICKUP 3/4 TON, (Inc. SILVERADO & AVALANCHE) 6.0L
 2006-01 8 CHEVROLET C-(2WD), K-(4WD) PICKUP 3/4 TON, (Inc. SILVERADO & AVALANCHE) 8.1L
 2007 8 CHEVROLET SILVERADO 2500 HD CLASSIC

645454 (cont.)

		6.0L
2007	8	CHEVROLET SILVERADO 2500 HD CLASSIC 8.1L
2007	8	CHEVROLET SILVERADO 3500 CLASSIC 6.0L
2007	8	CHEVROLET SILVERADO 3500 CLASSIC 8.1L
2006-02	8	GMC C-(2WD), K-(4WD) PICKUP 1/2 TON, (Inc. SIERRA) 6.0L
2006-01	8	GMC C-(2WD), K-(4WD) PICKUP 3/4 TON, (Inc. SIERRA) 6.0L
2006-01	8	GMC C-(2WD), K-(4WD) PICKUP 3/4 TON, (Inc. SIERRA) 8.1L
2007	8	GMC SIERRA 2500 HD CLASSIC 6.0L
2007	8	GMC SIERRA 2500 HD CLASSIC 8.1L
2007	8	GMC SIERRA 3500 CLASSIC 6.0L
2007	8	GMC SIERRA 3500 CLASSIC 8.1L

645455

Inlet A: WELDED 3-BOLT FLANGE
Outlet A: 3" O.D. PIPE
Length: 57"



2006-04	8	CHEVROLET C-(2WD), K-(4WD) PICKUP 1 TON, (Inc. SILVERADO) 6.0L
2006-04	8	CHEVROLET C-(2WD), K-(4WD) PICKUP 1 TON, (Inc. SILVERADO) 8.1L
2006-02	8	CHEVROLET C-(2WD), K-(4WD) PICKUP 1/2 TON, (Inc. SILVERADO & AVALANCHE) 6.0L
2006-01	8	CHEVROLET C-(2WD), K-(4WD) PICKUP 3/4 TON, (Inc. SILVERADO & AVALANCHE) 6.0L
2006-01	8	CHEVROLET C-(2WD), K-(4WD) PICKUP 3/4 TON, (Inc. SILVERADO & AVALANCHE) 8.1L
2007	8	CHEVROLET SILVERADO 2500 HD CLASSIC 6.0L
2007	8	CHEVROLET SILVERADO 2500 HD CLASSIC 8.1L
2007	8	CHEVROLET SILVERADO 3500 CLASSIC 6.0L
2007	8	CHEVROLET SILVERADO 3500 CLASSIC 8.1L
2006-02	8	GMC C-(2WD), K-(4WD) PICKUP 1/2 TON, (Inc. SIERRA) 6.0L
2006-01	8	GMC C-(2WD), K-(4WD) PICKUP 3/4 TON, (Inc. SIERRA) 6.0L
2006-01	8	GMC C-(2WD), K-(4WD) PICKUP 3/4 TON, (Inc. SIERRA) 8.1L
2007	8	GMC SIERRA 2500 HD CLASSIC 6.0L
2007	8	GMC SIERRA 2500 HD CLASSIC 8.1L
2007	8	GMC SIERRA 3500 CLASSIC 6.0L
2007	8	GMC SIERRA 3500 CLASSIC 8.1L

645456

Inlet A: WELDED 2-BOLT FLANGE
Outlet A: 2" O.D. PIPE
Length: 21.38"



2006-04	6	LEXUS RX330 3.3L
2007-04	6	TOYOTA HIGHLANDER 3.3L

645457

Inlet A: LOOSE 3-BOLT FLANGE W/ SPHERICAL FLARE
Inlet B: LOOSE 3-BOLT FLANGE W/ SPHERICAL FLARE
Outlet A: WELDED 2-BOLT FLANGE
Length: 59.25"



2000	6	CHEVROLET S-Series (2WD), T-Series (4WD) PICKUP 4.3L
2000	6	GMC S-Series (2WD), T-Series (4WD) PICKUP (SONOMA) 4.3L

645458

Inlet A: LOOSE 3-BOLT FLANGE W/ SPHERICAL FLARE
Inlet B: LOOSE 3-BOLT FLANGE W/ SPHERICAL FLARE
Outlet A: WELDED 2-BOLT FLANGE
Length: 56"



2000	6	CHEVROLET S-Series (2WD), T-Series (4WD) PICKUP 4.3L
2000	6	GMC S-Series (2WD), T-Series (4WD) PICKUP (SONOMA) 4.3L

DIRECT FIT



645459

Inlet A: LOOSE 3-BOLT FLANGE W/ SPHERICAL FLARE
 Inlet B: WELDED 3-BOLT FLANGE
 Outlet A: WELDED 2-BOLT FLANGE
 Length: 36"



- 2008 6 CHEVROLET C-(2WD), K-(4WD) PICKUP 1/2 TON, (Inc. SILVERADO & AVALANCHE) 4.3L
- 2008-07 8 CHEVROLET C-(2WD), K-(4WD) PICKUP 1/2 TON, (Inc. SILVERADO & AVALANCHE) 4.8L
- 2008-07 8 CHEVROLET C-(2WD), K-(4WD) PICKUP 1/2 TON, (Inc. SILVERADO & AVALANCHE) 5.3L
- 2008-07 8 CHEVROLET C-(2WD), K-(4WD) PICKUP 1/2 TON, (Inc. SILVERADO & AVALANCHE) 6.0L
- 2008-07 8 CHEVROLET SUBURBAN/TAHOE 4.8L
- 2008-07 8 CHEVROLET SUBURBAN/TAHOE 5.3L
- 2008-07 8 CHEVROLET SUBURBAN/TAHOE 6.0L
- 2008 6 GMC C-(2WD), K-(4WD) PICKUP 1/2 TON, (Inc. SIERRA) 4.3L
- 2008-07 8 GMC C-(2WD), K-(4WD) PICKUP 1/2 TON, (Inc. SIERRA) 4.8L
- 2008-07 8 GMC C-(2WD), K-(4WD) PICKUP 1/2 TON, (Inc. SIERRA) 5.3L
- 2008-07 8 GMC C-(2WD), K-(4WD) PICKUP 1/2 TON, (Inc. SIERRA) 6.0L
- 2008-07 8 GMC SUBURBAN/YUKON 4.8L
- 2008-07 8 GMC SUBURBAN/YUKON 5.3L
- 2008-07 8 GMC SUBURBAN/YUKON 6.0L

645461

Inlet A: LOOSE 2-BOLT FLANGE W/ SPHERICAL FLARE
 Outlet A: 2.50" O.D. PIPE
 Length: 36.50"



- 2008-05 8 FORD F-150 PICKUP 1/2 TON 5.4L
- 2008-06 8 LINCOLN MARK LT 5.4L

645462

Inlet A: LOOSE 2-BOLT FLANGE W/ SPHERICAL FLARE
 Outlet A: 2.50" O.D. PIPE
 Length: 40"



- 2008-05 6 FORD F-150 PICKUP 1/2 TON 4.2L

645463

Inlet A: LOOSE 2-BOLT FLANGE W/ SPHERICAL FLARE
 Inlet B: LOOSE 2-BOLT FLANGE W/ SPHERICAL FLARE
 Outlet A: 3" O.D. PIPE
 Length: 42"



- 2008-05 8 FORD E-150 VAN 1/2 TON 5.4L
- 2009-05 8 FORD E-250 VAN 3/4 TON 5.4L
- 2009-05 8 FORD E-350 VAN 1 TON 5.4L

645464

Inlet A: LOOSE 2-BOLT FLANGE W/ SPHERICAL FLARE
 Inlet B: LOOSE 2-BOLT FLANGE W/ SPHERICAL FLARE
 Outlet A: 2.50" O.D. PIPE
 Length: 48.25"



- 2008-07 8 FORD E-150 VAN 1/2 TON 4.6L
- 2008-07 8 FORD E-250 VAN 3/4 TON 4.6L

645465

Inlet A: WELDED 4-BOLT FLANGE
 Outlet A: WELDED 2-BOLT FLANGE
 Length: 24"



- 2005-02 6 LAND ROVER FREELANDER 2.5L

645466

Inlet A: WELDED 2-BOLT FLANGE W/ GASKET STUB
 Outlet A: 1.770" O.D. PIPE
 Length: 32.50"



2005-02 6 LAND ROVER FREELANDER 2.5L

645467

Inlet A: LOOSE 2-BOLT FLANGE W/ SPHERICAL FLARE
 Inlet B: 2.50" I.D. PIPE
 Outlet A: 2.50" O.D. PIPE
 Length: 46.75"



2000-98 8 FORD F-150 PICKUP 1/2 TON 5.4L
 1999-98 8 FORD F-250 PICKUP 3/4 TON 5.4L

645468

Inlet A: LOOSE 2-BOLT FLANGE W/ SPHERICAL FLARE
 Outlet A: 2.50" O.D. PIPE
 Length: 35"



2000-98 8 FORD F-150 PICKUP 1/2 TON 5.4L
 1999-98 8 FORD F-250 PICKUP 3/4 TON 5.4L

645469

Inlet A: WELDED 2-BOLT FLANGE
 Outlet A: WELDED 2-BOLT FLANGE
 Length: 11.50"



1997-96 6 LEXUS LX450 4.5L
 1997-95 6 TOYOTA LAND CRUISER 4.5L

645470

Inlet A: LOOSE 2-BOLT FLANGE W/ SPHERICAL FLARE
 Outlet A: WELDED 2-BOLT FLANGE W/ GASKET STUB
 Length: 36"



2003-02 6 SUZUKI XL-7 2.7L

645471

Inlet A: LOOSE 2-BOLT FLANGE W/ SPHERICAL FLARE
 Outlet A: 2.50" O.D. PIPE
 Length: 35.25"



2008-04 8 FORD F-150 PICKUP 1/2 TON 5.4L
 2008-06 8 LINCOLN MARK LT 5.4L

DIRECT FIT



645472

Inlet A: LOOSE 2-BOLT FLANGE W/ SPHERICAL FLARE
 Inlet B: LOOSE 2-BOLT FLANGE W/ SPHERICAL FLARE
 Outlet A: 2.50" O.D. PIPE
 Length: 19"



2007	8	CHRYSLER ASPEN 4.7L
2007-05	6	DODGE DURANGO 3.7L
2007-05	8	DODGE DURANGO 4.7L

645473

Inlet A: WELDED 2-BOLT FLANGE
 Outlet A: 3" O.D. PIPE
 Length: 25"



2006-04	8	CHEVROLET C-(2WD), K-(4WD) PICKUP 1 TON, (Inc. SILVERADO) 6.0L
2006-04	8	CHEVROLET C-(2WD), K-(4WD) PICKUP 1 TON, (Inc. SILVERADO) 8.1L
2006-01	8	CHEVROLET C-(2WD), K-(4WD) PICKUP 3/4 TON, (Inc. SILVERADO & AVALANCHE) 6.0L
2006-01	8	CHEVROLET C-(2WD), K-(4WD) PICKUP 3/4 TON, (Inc. SILVERADO & AVALANCHE) 8.1L
2007	8	CHEVROLET SILVERADO 2500 HD CLASSIC 6.0L
2007	8	CHEVROLET SILVERADO 2500 HD CLASSIC 8.1L
2007	8	CHEVROLET SILVERADO 3500 CLASSIC 6.0L
2007	8	CHEVROLET SILVERADO 3500 CLASSIC 8.1L
2006-01	8	GMC C-(2WD), K-(4WD) PICKUP 3/4 TON, (Inc. SIERRA) 6.0L
2006-01	8	GMC C-(2WD), K-(4WD) PICKUP 3/4 TON, (Inc.

645473 (cont.)

		SIERRA) 8.1L
2007	8	GMC SIERRA 2500 HD CLASSIC 6.0L
2007	8	GMC SIERRA 2500 HD CLASSIC 8.1L
2007	8	GMC SIERRA 3500 CLASSIC 6.0L
2007	8	GMC SIERRA 3500 CLASSIC 8.1L

645774

Inlet A: LOOSE 3-BOLT FLANGE W/ FLARE
 Inlet B: LOOSE 3-BOLT FLANGE W/ FLARE
 Outlet A: WELDED 2-BOLT FLANGE
 Outlet B: 3" O.D. PIPE
 Length: 58"



2009-03	8	CHEVROLET C4500 KODIAK 8.1L
2009-03	8	GMC C4500 TOPKICK 8.1L

645775

Inlet A: WELDED 2-BOLT FLANGE
 Inlet B: 3" I.D. PIPE
 Outlet A: 3" O.D. PIPE
 Length: 67.50"



2009-03	8	CHEVROLET C4500 KODIAK 8.1L
2009-03	8	GMC C4500 TOPKICK 8.1L

645776

Inlet A: WELDED 3-BOLT FLANGE
 Inlet B: LOOSE 3-BOLT FLANGE W/ FLARE
 Outlet A: WELDED 2-BOLT FLANGE
 Length: 56"



2006-05	8	CHEVROLET TRAILBLAZER EXT 5.3L
2006-05	8	GMC ENVOY XL 5.3L
2005	8	GMC ENVOY XUV 5.3L

645777

Inlet A: WELDED 3-BOLT FLANGE
Inlet B: LOOSE 3-BOLT FLANGE W/ FLARE
Outlet A: WELDED 2-BOLT FLANGE
Length: 60"



- 2011-10 8 CHEVROLET G -VAN 1 TON (Inc. Express Van) 4.8L
- 2011-10 8 CHEVROLET G -VAN 1 TON (Inc. Express Van) 6.0L
- 2014-09 6 CHEVROLET G -VAN 1/2 & 3/4 TON (Inc. Express Van) 4.3L
- 2011-10 8 CHEVROLET G -VAN 1/2 & 3/4 TON (Inc. Express Van) 4.8L
- 2014-09 8 CHEVROLET G -VAN 1/2 & 3/4 TON (Inc. Express Van) 5.3L
- 2011-10 8 CHEVROLET G -VAN 1/2 & 3/4 TON (Inc. Express Van) 6.0L
- 2011-10 8 GMC G -VAN 1 TON (Inc. Savana Van) 4.8L
- 2011-10 8 GMC G -VAN 1 TON (Inc. Savana Van) 6.0L
- 2011-10 8 GMC G -VAN 1/2 & 3/4 TON (Inc. Savana Van) 4.8L
- 2011-10 8 GMC G -VAN 1/2 & 3/4 TON (Inc. Savana Van) 6.0L
- 2014-09 6 GMC G -VAN 1/2 & 3/4 TON (Inc. Savana Van) 4.3L
- 2014-09 8 GMC G -VAN 1/2 & 3/4 TON (Inc. Savana Van) 5.3L

645778

Inlet A: WELDED 3-BOLT FLANGE
Inlet B: LOOSE 3-BOLT FLANGE W/ FLARE
Outlet A: WELDED 2-BOLT FLANGE
Length: 53.25"



- 2009-07 8 CHEVROLET C-(2WD), K-(4WD) PICKUP 1 TON, (Inc. SILVERADO) 6.0L
- 2009-07 8 CHEVROLET C-(2WD), K-(4WD) PICKUP 3/4 TON, (Inc. SILVERADO & AVALANCHE) 6.0L
- 2009-07 8 GMC C-(2WD), K-(4WD) PICKUP 1 TON, (Inc. SIERRA) 6.0L
- 2009-07 8 GMC C-(2WD), K-(4WD) PICKUP 3/4 TON, (Inc. SIERRA) 6.0L

645779

Inlet A: WELDED 3-BOLT FLANGE
Outlet A: 2.94" O.D. PIPE
Length: 66"



- 2010-06 8 CHEVROLET G -VAN 1 TON (Inc. Express Van) 4.8L
- 2010-06 8 CHEVROLET G -VAN 1 TON (Inc. Express Van) 6.0L
- 2010-06 8 CHEVROLET G -VAN 1/2 & 3/4 TON (Inc. Express Van) 4.8L
- 2010-06 8 CHEVROLET G -VAN 1/2 & 3/4 TON (Inc. Express Van) 6.0L
- 2010-06 8 GMC G -VAN 1 TON (Inc. Savana Van) 4.8L
- 2010-06 8 GMC G -VAN 1 TON (Inc. Savana Van) 6.0L
- 2010-06 8 GMC G -VAN 1/2 & 3/4 TON (Inc. Savana Van) 4.8L
- 2010-06 8 GMC G -VAN 1/2 & 3/4 TON (Inc. Savana Van) 6.0L

645780

Inlet A: WELDED 3-BOLT FLANGE
Outlet A: WELDED 3-BOLT FLANGE
Length: 57.75"



- 2010-06 8 CHEVROLET G -VAN 1 TON (Inc. Express Van) 4.8L
- 2010-06 8 CHEVROLET G -VAN 1 TON (Inc. Express Van) 6.0L
- 2010-06 8 CHEVROLET G -VAN 1/2 & 3/4 TON (Inc. Express Van) 4.8L
- 2010-06 8 CHEVROLET G -VAN 1/2 & 3/4 TON (Inc. Express Van) 6.0L
- 2010-06 8 GMC G -VAN 1 TON (Inc. Savana Van) 4.8L
- 2010-06 8 GMC G -VAN 1 TON (Inc. Savana Van) 6.0L
- 2010-06 8 GMC G -VAN 1/2 & 3/4 TON (Inc. Savana Van) 4.8L
- 2010-06 8 GMC G -VAN 1/2 & 3/4 TON (Inc. Savana Van) 6.0L

DIRECT FIT



645781

Inlet A: WELDED 3-BOLT FLANGE
 Outlet A: 2.94" O.D. PIPE
 Length: 62"



- 2013-08 8 CHEVROLET G -VAN 1 TON (Inc. Express Van) 4.8L
- 2013-08 8 CHEVROLET G -VAN 1 TON (Inc. Express Van) 6.0L
- 2013-08 8 CHEVROLET G -VAN 1/2 & 3/4 TON (Inc. Express Van) 4.8L
- 2013-08 8 CHEVROLET G -VAN 1/2 & 3/4 TON (Inc. Express Van) 6.0L
- 2013-08 8 GMC G -VAN 1 TON (Inc. Savana Van) 4.8L
- 2013-08 8 GMC G -VAN 1 TON (Inc. Savana Van) 6.0L
- 2013-08 8 GMC G -VAN 1/2 & 3/4 TON (Inc. Savana Van) 4.8L
- 2013-08 8 GMC G -VAN 1/2 & 3/4 TON (Inc. Savana Van) 6.0L

645782

Inlet A: WELDED 3-BOLT FLANGE
 Outlet A: 3" O.D. PIPE
 Length: 56"



- 2006-03 8 CHEVROLET C-(2WD), K-(4WD) PICKUP 1 TON, (Inc. SILVERADO) 6.0L
- 2006-03 8 CHEVROLET C-(2WD), K-(4WD) PICKUP 1 TON, (Inc. SILVERADO) 8.1L
- 2006-03 8 CHEVROLET C-(2WD), K-(4WD) PICKUP 3/4 TON, (Inc. SILVERADO & AVALANCHE) 6.0L
- 2006-03 8 GMC C-(2WD), K-(4WD) PICKUP 1 TON, (Inc. SIERRA) 6.0L
- 2006-03 8 GMC C-(2WD), K-(4WD) PICKUP 1 TON, (Inc. SIERRA) 8.1L
- 2006-03 8 GMC C-(2WD), K-(4WD) PICKUP 3/4 TON, (Inc. SIERRA) 6.0L

645783

Inlet A: WELDED 3-BOLT FLANGE
 Outlet A: 3" O.D. PIPE
 Length: 88"



- 2006-03 8 CHEVROLET C-(2WD), K-(4WD) PICKUP 1 TON, (Inc. SILVERADO) 6.0L
- 2006-03 8 CHEVROLET C-(2WD), K-(4WD) PICKUP 1 TON, (Inc. SILVERADO) 8.1L
- 2006-03 8 CHEVROLET C-(2WD), K-(4WD) PICKUP 3/4 TON, (Inc. SILVERADO & AVALANCHE) 6.0L
- 2006-03 8 CHEVROLET C-(2WD), K-(4WD) PICKUP 3/4 TON, (Inc. SILVERADO & AVALANCHE) 8.1L
- 2006-03 8 GMC C-(2WD), K-(4WD) PICKUP 1 TON, (Inc. SIERRA) 6.0L
- 2006-03 8 GMC C-(2WD), K-(4WD) PICKUP 1 TON, (Inc. SIERRA) 8.1L
- 2006-03 8 GMC C-(2WD), K-(4WD) PICKUP 3/4 TON, (Inc. SIERRA) 6.0L
- 2006-03 8 GMC C-(2WD), K-(4WD) PICKUP 3/4 TON, (Inc. SIERRA) 8.1L

645784

Inlet A: WELDED 3-BOLT FLANGE
 Inlet B: LOOSE 3-BOLT FLANGE W/ FLARE
 Outlet A: WELDED 2-BOLT FLANGE
 Length: 55"



- 2004 8 BUICK RAINIER 5.3L
- 2004-03 8 GMC ENVOY XL 5.3L

645785

Inlet A: LOOSE 3-BOLT FLANGE W/ FLARE
 Inlet B: LOOSE 3-BOLT FLANGE W/ FLARE
 Outlet A: WELDED 2-BOLT FLANGE
 Length: 70"



- 2002-00 8 CHEVROLET G -VAN 1 TON (Inc. Express Van) 5.7L
- 2002-00 8 CHEVROLET G -VAN 1/2 & 3/4 TON (Inc. Express Van) 5.7L
- 2002-00 8 GMC G -VAN 1 TON (Inc. Savana Van) 5.7L
- 2002-00 8 GMC G -VAN 1/2 & 3/4 TON (Inc. Savana Van) 5.7L

645786

Inlet A: WELDED 3-BOLT FLANGE
 Inlet B: WELDED 3-BOLT FLANGE
 Outlet A: LOOSE 2-BOLT FLANGE W/MALE BALL
 Length: 53.50"



- 2000-99 8 LAND ROVER RANGE ROVER 4.0L
- 2002-99 8 LAND ROVER RANGE ROVER 4.6L

645787

Inlet A: LOOSE 2-BOLT FLANGE W/ FLARE
 Outlet A: 2.92" O.D. PIPE
 Length: 51"



- 2012-07 8 MERCEDES-BENZ GL450 4.6L
- 2012-08 8 MERCEDES-BENZ GL550 5.5L
- 2011-08 8 MERCEDES-BENZ ML550 5.5L

645788

Inlet A: LOOSE 2-BOLT FLANGE W/ FLARE
 Outlet A: 2.38" O.D. PIPE
 Length: 52.50"



- 2012-07 8 MERCEDES-BENZ GL450 4.6L
- 2012-08 8 MERCEDES-BENZ GL550 5.5L
- 2011-08 8 MERCEDES-BENZ ML550 5.5L

645789

Inlet A: LOOSE 2-BOLT FLANGE W/ FLARE
 Inlet B: LOOSE 2-BOLT FLANGE W/ FLARE
 Outlet A: 2.50" O.D. PIPE
 Length: 55.50"



- 2014-09 8 FORD E-150 VAN 1/2 TON 4.6L
- 2014-09 8 FORD E-250 VAN 3/4 TON 4.6L

645790

Inlet A: LOOSE 2-BOLT FLANGE W/ FLARE
 Inlet B: LOOSE 2-BOLT FLANGE W/ FLARE
 Outlet A: 2.50" O.D. PIPE
 Length: 63"



- 2003-01 8 DODGE DURANGO 5.9L

DIRECT FIT



645791

Inlet A: LOOSE 2-BOLT FLANGE
 Inlet B: LOOSE 2-BOLT FLANGE
 Outlet A: 2.50" O.D. PIPE
 Length: 55"



2003-00 8 DODGE DAKOTA 4.7L

645792

Inlet A: LOOSE 2-BOLT FLANGE W/ FLARE
 Inlet B: LOOSE 2-BOLT FLANGE W/ FLARE
 Outlet A: 2.50" O.D. PIPE
 Length: 51"



2003-00 8 DODGE B-VAN 5.9L

645797

Inlet A: LOOSE 3-BOLT FLANGE W/ SPHERICAL FLARE
 Inlet B: WELDED 3-BOLT FLANGE
 Outlet A: 2.50" OD PIPE W/ SPHERICAL BALL
 Length: 42.75"



- 2013-09 6 CHEVROLET C-(2WD), K-(4WD) PICKUP 1/2 TON, (Inc. SILVERADO & AVALANCHE) 4.3L
- 2013-09 8 CHEVROLET C-(2WD), K-(4WD) PICKUP 1/2 TON, (Inc. SILVERADO & AVALANCHE) 4.8L
- 2013-09 8 CHEVROLET C-(2WD), K-(4WD) PICKUP 1/2 TON, (Inc. SILVERADO & AVALANCHE) 5.3L
- 2009 8 CHEVROLET SUBURBAN/TAHOE 4.8L
- 2014-09 8 CHEVROLET SUBURBAN/TAHOE 5.3L
- 2013-09 6 GMC C-(2WD), K-(4WD) PICKUP 1/2 TON, (Inc. SIERRA) 4.3L
- 2013-09 8 GMC C-(2WD), K-(4WD) PICKUP 1/2 TON, (Inc.

645797 (cont.)

- SIERRA) 4.8L
- 2013-09 8 GMC C-(2WD), K-(4WD) PICKUP 1/2 TON, (Inc. SIERRA) 5.3L
- 2009 8 GMC SUBURBAN/YUKON 4.8L
- 2014-09 8 GMC SUBURBAN/YUKON 5.3L

645798

Inlet A: LOOSE 2-BOLT FLANGE W/ SPHERICAL FLARE
 Inlet B: LOOSE 2-BOLT FLANGE W/ SPHERICAL FLARE
 Outlet A: WELDED 2-BOLT FLANGE
 Length: 50.13"



2007-05 6 JEEP LIBERTY 3.7L

645800

Inlet A: LOOSE 2-BOLT FLANGE W/ SPHERICAL FLARE
 Inlet B: LOOSE 2-BOLT FLANGE W/ SPHERICAL FLARE
 Outlet A: 2.39" O.D. PIPE
 Length: 53"



2003-02 8 DODGE RAM (2WD & 4WD) PICKUP 1/2 & 3/4 TON 5.9L

645803

Inlet A: WELDED 2-BOLT FLANGE W/ FEMALE FLARE
 Outlet A: WELDED 2-BOLT FLANGE W/ GASKET STUB
 Length: 47.50"



2011-05 4 TOYOTA TACOMA 2.7L

645804

Inlet A: LOOSE 3-BOLT FLANGE W/ SPHERICAL FLARE
Outlet A: WELDED 2-BOLT FLANGE
Length: 61.25"



- 2005-02 6 CHEVROLET TRAILBLAZER EXT 4.2L
- 2005-02 6 GMC ENVOY XL 4.2L
- 2005-04 6 GMC ENVOY XUV 4.2L
- 2005-04 6 ISUZU ASCENDER 4.2L

645805

Inlet A: LOOSE 2-BOLT FLANGE W/ SPHERICAL FLARE
Inlet B: LOOSE 2-BOLT FLANGE W/ SPHERICAL FLARE
Outlet A: 2.50" O.D. PIPE
Length: 50"

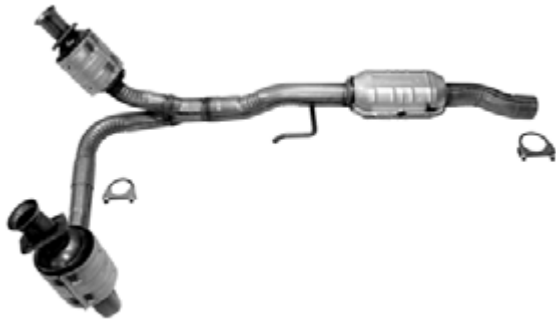

- 2002-00 8 DODGE DAKOTA 4.7L

645806

Inlet A: LOOSE 3-BOLT FLANGE W/ SPHERICAL FLARE
Inlet B: LOOSE 3-BOLT FLANGE W/ SPHERICAL FLARE
Outlet A: WELDED 2-BOLT FLANGE
Length: 46"



- 2003-01 6 CHEVROLET S-Series (2WD), T-Series (4WD) PICKUP 4.3L

645807

Inlet A: LOOSE 2-BOLT FLANGE w/ SPHERICAL FLARE
Inlet B: WELDED 3-BOLT FLANGE
Outlet A: 3.00" I.D. PIPE
Length: 54"



- 2003 8 DODGE RAM (2WD & 4WD) PICKUP 1 TON 5.7L
- 2003 8 DODGE RAM (2WD & 4WD) PICKUP 1/2 & 3/4 TON 5.7L

645811

Inlet A: LOOSE 3-BOLT FLANGE W/ FEMALE FLARE
Outlet A: 3" O.D. PIPE
Length: 71"



- 2002-01 8 CHEVROLET G -VAN 1 TON (Inc. Express Van) 5.7L
- 2002-01 8 CHEVROLET G -VAN 1/2 & 3/4 TON (Inc. Express Van) 5.7L
- 2002-01 8 GMC G -VAN 1 TON (Inc. Savana Van) 5.7L
- 2002-01 8 GMC G -VAN 1/2 & 3/4 TON (Inc. Savana Van) 5.7L

645812

Inlet A: LOOSE 3-BOLT FLANGE W/ FEMALE FLARE
Outlet A: WELDED 3-BOLT FLANGE
Length: 61"



- 2002-01 8 CHEVROLET G -VAN 1 TON (Inc. Express Van) 5.7L
- 2002-01 8 CHEVROLET G -VAN 1/2 & 3/4 TON (Inc. Express Van) 5.7L
- 2002-01 8 GMC G -VAN 1 TON (Inc. Savana Van) 5.7L

DIRECT FIT



645812 (cont.)

2002-01 8 GMC G -VAN 1/2 & 3/4 TON (Inc. Savana Van) 5.7L

645813

Inlet A: LOOSE 3-BOLT FLANGE W/ FEMALE FLARE
 Inlet B: WELDED 3-BOLT FLANGE
 Outlet A: WELDED 2-BOLT FLANGE
 Length: 59"



2006-03 6 CHEVROLET G -VAN 1/2 & 3/4 TON (Inc. Express Van) 4.3L
 2005-03 8 CHEVROLET G -VAN 1/2 & 3/4 TON (Inc. Express Van) 5.3L
 2005-03 8 GMC G -VAN 1/2 & 3/4 TON (Inc. Savana Van) 5.3L
 2006-03 6 GMC G -VAN 1/2 & 3/4 TON (Inc. Savana Van) 4.3L

645814

Inlet A: WELDED 3-BOLT FLANGE
 Outlet A: 3" O.D. PIPE
 Length: 63"



2005-03 8 CHEVROLET G -VAN 1 TON (Inc. Express Van) 6.0L
 2005-03 8 CHEVROLET G -VAN 1/2 & 3/4 TON (Inc. Express Van) 4.8L
 2005-03 8 CHEVROLET G -VAN 1/2 & 3/4 TON (Inc. Express Van) 6.0L
 2005-03 8 GMC G -VAN 1 TON (Inc. Savana Van) 6.0L
 2005-03 8 GMC G -VAN 1/2 & 3/4 TON (Inc. Savana Van) 4.8L
 2005-03 8 GMC G -VAN 1/2 & 3/4 TON (Inc. Savana Van) 6.0L

645815

Inlet A: WELDED 3-BOLT FLANGE
 Outlet A: WELDED 3-BOLT FLANGE
 Length: 61.25"



2005-03 8 CHEVROLET G -VAN 1 TON (Inc. Express Van) 6.0L
 2005-03 8 CHEVROLET G -VAN 1/2 & 3/4 TON (Inc. Express Van) 4.8L
 2005-03 8 CHEVROLET G -VAN 1/2 & 3/4 TON (Inc. Express Van) 6.0L
 2005-03 8 GMC G -VAN 1 TON (Inc. Savana Van) 6.0L
 2005-03 8 GMC G -VAN 1/2 & 3/4 TON (Inc. Savana Van) 4.8L
 2005-03 8 GMC G -VAN 1/2 & 3/4 TON (Inc. Savana Van) 6.0L

645816

Inlet A: WELDED 3-BOLT FLANGE
 Outlet A: WELDED 3-BOLT FLANGE
 Length: 60"



2009-06 8 CHEVROLET G -VAN 1 TON (Inc. Express Van) 6.0L
 2009-06 8 CHEVROLET G -VAN 1/2 & 3/4 TON (Inc. Express Van) 4.8L
 2009-06 8 CHEVROLET G -VAN 1/2 & 3/4 TON (Inc. Express Van) 6.0L
 2009-06 8 GMC G -VAN 1 TON (Inc. Savana Van) 6.0L
 2009-06 8 GMC G -VAN 1/2 & 3/4 TON (Inc. Savana Van) 4.8L
 2009-06 8 GMC G -VAN 1/2 & 3/4 TON (Inc. Savana Van) 6.0L

645817

Inlet A: WELDED 3-BOLT FLANGE
Outlet A: 3" O.D. PIPE
Length: 61"



- 2009-06 8 CHEVROLET G -VAN 1 TON (Inc. Express Van) 6.0L
- 2009-06 8 CHEVROLET G -VAN 1/2 & 3/4 TON (Inc. Express Van) 4.8L
- 2009-06 8 CHEVROLET G -VAN 1/2 & 3/4 TON (Inc. Express Van) 6.0L
- 2009-06 8 GMC G -VAN 1 TON (Inc. Savana Van) 6.0L
- 2009-06 8 GMC G -VAN 1/2 & 3/4 TON (Inc. Savana Van) 4.8L
- 2009-06 8 GMC G -VAN 1/2 & 3/4 TON (Inc. Savana Van) 6.0L

645818

Inlet A: WELDED 3-BOLT FLANGE
Outlet A: 3" O.D. PIPE
Length: 55.75"



- 2002-01 8 CHEVROLET C-(2WD), K-(4WD) PICKUP 3/4 TON, (Inc. SILVERADO & AVALANCHE) 6.0L
- 2002-01 8 GMC C-(2WD), K-(4WD) PICKUP 3/4 TON, (Inc. SIERRA) 6.0L

645819

Inlet A: LOOSE 3-BOLT FLANGE
Inlet B: WELDED 3-BOLT FLANGE
Outlet A: WELDED 2-BOLT FLANGE
Length: 69"



- 2012-11 8 CHEVROLET G -VAN 1 TON (Inc. Express Van)

645819 (cont.)

- 2012-11 8 6.0L
CHEVROLET G -VAN 1/2 & 3/4 TON (Inc. Express Van) 6.0L
- 2012-11 8 GMC G -VAN 1 TON (Inc. Savana Van) 6.0L
- 2012-11 8 GMC G -VAN 1/2 & 3/4 TON (Inc. Savana Van) 6.0L

645820

Inlet A: LOOSE 3-BOLT FLANGE W/ FLARE
Inlet B: LOOSE 3-BOLT FLANGE W/ FLARE
Outlet A: WELDED 2-BOLT FLANGE
Length: 57.50"



- 2002 8 CHEVROLET G -VAN 1/2 & 3/4 TON (Inc. Express Van) 5.7L
- 2002 8 GMC G -VAN 1/2 & 3/4 TON (Inc. Savana Van) 5.7L

645821

Inlet A: LOOSE 3-BOLT FLANGE W/ FLARE
Inlet B: WELDED 3-BOLT FLANGE
Outlet A: 3" MALE BALL
Length: 55"



- 2013-09 6 CHEVROLET C-(2WD), K-(4WD) PICKUP 1/2 TON, (Inc. SILVERADO & AVALANCHE) 4.3L
- 2013-09 8 CHEVROLET C-(2WD), K-(4WD) PICKUP 1/2 TON, (Inc. SILVERADO & AVALANCHE) 4.8L
- 2013-09 8 CHEVROLET C-(2WD), K-(4WD) PICKUP 1/2 TON, (Inc. SILVERADO & AVALANCHE) 5.3L
- 2009 8 CHEVROLET SUBURBAN/TAHOE 4.8L
- 2014-09 8 CHEVROLET SUBURBAN/TAHOE 5.3L
- 2013-09 6 GMC C-(2WD), K-(4WD) PICKUP 1/2 TON, (Inc. SIERRA) 4.3L
- 2013-09 8 GMC C-(2WD), K-(4WD) PICKUP 1/2 TON, (Inc. SIERRA) 4.8L
- 2013-09 8 GMC C-(2WD), K-(4WD) PICKUP 1/2 TON, (Inc. SIERRA) 5.3L
- 2009 8 GMC SUBURBAN/YUKON 4.8L
- 2014-09 8 GMC SUBURBAN/YUKON 5.3L

DIRECT FIT



645822

Inlet A: LOOSE 2-BOLT FLANGE
 Inlet B: 2.50" O.D. PIPE
 Outlet A: 2.75" O.D. PIPE
 Length: 55"



2005-04 8 DODGE DURANGO 5.7L

645828

Inlet A: WELDED 3-BOLT FLANGE
 Outlet A: 2.550" O.D. PIPE
 Outlet B: 2.550" O.D. PIPE
 Length: 48.75"



- 2000-96 8 CHEVROLET C-(2WD), K-(4WD) PICKUP 1 TON, (Inc. SILVERADO) 5.7L
- 2000-96 8 CHEVROLET C-(2WD), K-(4WD) PICKUP 3/4 TON, (Inc. SILVERADO & AVALANCHE) 5.7L
- 2000-96 8 GMC C-(2WD), K-(4WD) PICKUP 1 TON, (Inc. SIERRA) 5.7L
- 2000-96 8 GMC C-(2WD), K-(4WD) PICKUP 3/4 TON, (Inc. SIERRA) 5.7L

645829

Inlet A: LOOSE 2-BOLT FLANGE W/ SPHERICAL FLARE
 Inlet B: 2.50" I.D. PIPE
 Outlet A: 2.50" O.D. PIPE
 Length: 49.50"



- 2008-04 8 FORD F-150 PICKUP 1/2 TON 5.4L
- 2008-06 8 LINCOLN MARK LT 5.4L

645830

Inlet A: LOOSE 2-BOLT FLANGE W/ SPHERICAL FLARE
 Inlet B: LOOSE 2-BOLT FLANGE W/ SPHERICAL FLARE
 Outlet A: 2.50" O.D. PIPE
 Length: 56.25"



- 2008 6 DODGE NITRO 3.7L
- 2008 6 JEEP LIBERTY 3.7L

645831

Inlet A: LOOSE 2-BOLT FLANGE W/ SPHERICAL FLARE
 Inlet B: 2.50" I.D. PIPE
 Outlet A: 2.50" O.D. PIPE
 Length: 49.50"



- 2005-04 8 FORD F-150 PICKUP 1/2 TON 4.6L

645832

Inlet A: LOOSE 2-BOLT FLANGE W/ SPHERICAL FLARE
 Inlet B: 2.50" I.D. PIPE
 Outlet A: 2.50" O.D. PIPE
 Length: 48.75"



- 2008-05 6 FORD F-150 PICKUP 1/2 TON 4.2L

645833

Inlet A: LOOSE 2-BOLT FLANGE W/ SPHERICAL FLARE
 Outlet A: WELDED 2-BOLT FLANGE W/ GASKET STUB
 Length: 48.75"



2011-07 4 FORD RANGER 2.3L
 2009-07 4 MAZDA B-Series PICKUP 2.3L

645835

Inlet A: WELDED 2-BOLT FLANGE
 Outlet A: WELDED 2-BOLT FLANGE W/ GASKET STUB
 Length: 80.75"



2003-99 6 LEXUS RX300 3.0L

645836

Inlet A: LOOSE 3-BOLT FLANGE W/ SPHERICAL FLARE
 Inlet B: LOOSE 3-BOLT FLANGE W/ SPHERICAL FLARE
 Outlet A: WELDED 2-BOLT FLANGE
 Length: 56"

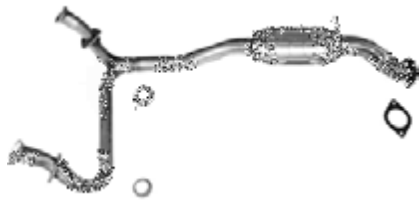

2000 6 CHEVROLET BLAZER S-Series 4.3L
 2000 6 GMC S-15 JIMMY 4.3L

645837

Inlet A: LOOSE 3-BOLT FLANGE W/ SPHERICAL FLARE
 Inlet B: LOOSE 3-BOLT FLANGE W/ SPHERICAL FLARE
 Outlet A: WELDED 2-BOLT FLANGE
 Length: 54.50"



2000 6 CHEVROLET BLAZER S-Series 4.3L
 2000 6 GMC S-15 JIMMY 4.3L

645838

Inlet A: 2-BOLT FLANGE W/ SPHERICAL FLARE
 Inlet B: 2-BOLT FLANGE W/ SPHERICAL FLARE
 Outlet A: 3-BOLT FLANGE W/ 45 DEGREE FLARE
 Length: 67"



1997-94 6 MERCEDES-BENZ C280 2.8L

645839

Inlet A: LOOSE 2-BOLT FLANGE W/ SPHERICAL FLARE
 Outlet A: LOOSE 3-BOLT FLANGE W/ 45 DEGREE FLARE
 Length: 58.25"



1996-94 4 MERCEDES-BENZ C220 2.2L
 1997 4 MERCEDES-BENZ C230 2.3L

645840

Inlet A: LOOSE 3-BOLT FLANGE W/ SPHERICAL FLARE
 Inlet B: LOOSE 3-BOLT FLANGE W/ SPHERICAL FLARE
 Outlet A: WELDED 2-BOLT FLANGE
 Length: 58.50"



2000 6 CHEVROLET BLAZER S-Series 4.3L
 2000 6 GMC S-15 JIMMY 4.3L

645841

Inlet A: LOOSE 3-BOLT FLANGE W/ SPHERICAL FLARE
 Inlet B: LOOSE 3-BOLT FLANGE W/ SPHERICAL FLARE
 Outlet A: WELDED 2-BOLT FLANGE
 Length: 58"



2005-00 6 CHEVROLET BLAZER S-Series 4.3L
 2002-00 6 GMC S-15 JIMMY 4.3L

DIRECT FIT



645842

Inlet A: WELDED 3-BOLT FLANGE
 Outlet A: 2.75" O.D. PIPE
 Length: 63.50"



- 2001-99 8 CHEVROLET C-(2WD), K-(4WD) PICKUP 3/4 TON, (Inc. SILVERADO & AVALANCHE) 6.0L
- 2002-01 8 CHEVROLET SUBURBAN/TAHOE 6.0L
- 2001-99 8 GMC C-(2WD), K-(4WD) PICKUP 3/4 TON, (Inc. SIERRA) 6.0L

645843

Inlet A: LOOSE 2-BOLT FLANGE W/ SPHERICAL FLARE
 Inlet B: 2.50" I.D. PIPE
 Outlet A: 2.50" O.D. PIPE
 Length: 48.50"



- 2008-05 8 FORD F-150 PICKUP 1/2 TON 5.4L
- 2008-06 8 LINCOLN MARK LT 5.4L

645844

Inlet A: WELDED 3-BOLT FLANGE
 Outlet A: 2.50" O.D. PIPE
 Length: 51.25"



- 2006-02 8 CADILLAC ESCALADE 6.0L
- 2006-03 8 CHEVROLET C-(2WD), K-(4WD) PICKUP 1/2 TON, (Inc. SILVERADO & AVALANCHE) 6.0L
- 2006-01 8 GMC SUBURBAN/YUKON 6.0L

645845

Inlet A: LOOSE 3-BOLT FLANGE W/ SPHERICAL FLARE
 Outlet A: WELDED 2-BOLT FLANGE
 Length: 60"



- 2005-02 6 CHEVROLET TRAILBLAZER EXT 4.2L
- 2005-02 6 GMC ENVOY XL 4.2L
- 2005-04 6 GMC ENVOY XUV 4.2L

645846

Inlet A: LOOSE 2-BOLT FLANGE W/ SPHERICAL FLARE
 Inlet B: LOOSE 2-BOLT FLANGE W/ SPHERICAL FLARE
 Outlet A: 2-1/2" O.D. PIPE
 Length: 60.50"

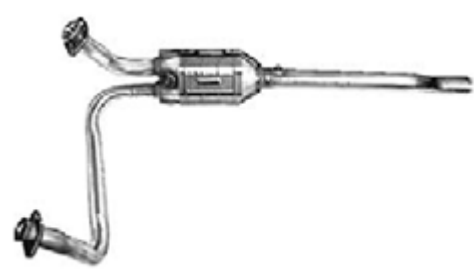

- 2003-02 8 DODGE RAM (2WD & 4WD) PICKUP 1/2 & 3/4 TON 4.7L

645847

Inlet A: LOOSE 2-BOLT FLANGE W/ SPHERICAL FLARE
 Inlet B: LOOSE 2-BOLT FLANGE W/ SPHERICAL FLARE
 Outlet A: 2-1/2" O.D. PIPE
 Length: 59.25"



- 2003-00 6 DODGE DAKOTA 3.9L

645848

Inlet A: LOOSE 2-BOLT FLANGE W/ SPHERICAL FLARE
 Inlet B: LOOSE 2-BOLT FLANGE W/ SPHERICAL FLARE
 Outlet A: 2-1/2" O.D. PIPE
 Length: 61.75"



2003-00 8 DODGE DURANGO 4.7L
 2003-00 8 DODGE DURANGO 4.7L

645849

Inlet A: LOOSE 3-BOLT FANGE W/ SPHERICAL FLARE
 Inlet B: LOOSE 3-BOLT FANGE W/ SPHERICAL FLARE
 Outlet A: WELDED 2-BOLT FLANGE
 Length: 57.25"

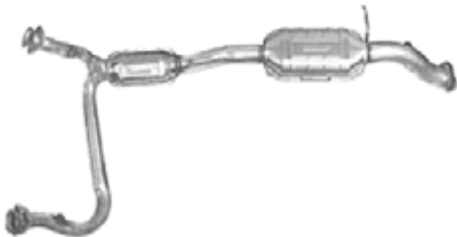

2005-01 6 CHEVROLET BLAZER S-Series 4.3L
 2002-01 6 GMC S-15 JIMMY 4.3L

645850

Inlet A: LOOSE 3-BOLT FLANGE W/ SPHERICAL FLARE
 Inlet B: LOOSE 3-BOLT FLANGE W/ SPHERICAL FLARE
 Outlet A: WELDED 2-BOLT FLANGE
 Length: 57.25"



2005-01 6 CHEVROLET BLAZER S-Series 4.3L
 2002-01 6 GMC S-15 JIMMY 4.3L

645851

Inlet A: WELDED 4-BOLT FLANGE
 Outlet A: 2.25" O.D. PIPE
 Length: 74.25"



2003-01 4 CHRYSLER VOYAGER, GRAND VOYAGER
 2.4L
 2007-01 4 DODGE CARAVAN 2.4L

645852

Inlet A: LOOSE 3-BOLT FLANGE W/ SPHERICAL FLARE
 Outlet A: WELDED 2-BOLT FLANGE
 Length: 58.50"



2006-04 4 CHEVROLET COLORADO 2.8L
 2006-04 5 CHEVROLET COLORADO 3.5L
 2006-04 4 GMC CANYON 2.8L
 2006-04 5 GMC CANYON 3.5L
 2007 5 HUMMER H3 3.7L
 2006 4 ISUZU I-280 2.8L
 2006 5 ISUZU I-350 3.5L

645853

Inlet A: WELDED 3-BOLT FLANGE
 Outlet A: WELDED 3-BOLT FLANGE
 Length: 68.25"



2005-03 8 CHEVROLET G -VAN 1 TON (Inc. Express Van)
 6.0L
 2005-03 8 CHEVROLET G -VAN 1/2 & 3/4 TON (Inc.
 Express Van) 4.8L
 2005-03 8 CHEVROLET G -VAN 1/2 & 3/4 TON (Inc.
 Express Van) 6.0L
 2005-03 8 GMC G -VAN 1 TON (Inc. Savana Van) 6.0L
 2005-03 8 GMC G -VAN 1/2 & 3/4 TON (Inc. Savana Van)
 4.8L
 2005-03 8 GMC G -VAN 1/2 & 3/4 TON (Inc. Savana Van)
 6.0L

DIRECT FIT



645854

Inlet A: LOOSE 2-BOLT FLANGE W/ FLARE
 Inlet B: 2.25" I.D. PIPE
 Outlet A: 2.50" O.D. PIPE
 Length: 55.50"



- 2005-04 6 DODGE RAM (2WD & 4WD) PICKUP 1/2 & 3/4 TON 3.7L
- 2005-04 8 DODGE RAM (2WD & 4WD) PICKUP 1/2 & 3/4 TON 4.7L

645855

Inlet A: 2.50" I.D. PIPE
 Outlet A: 2.50" O.D. PIPE
 Length: 59.50"



- 1996 6 DODGE DAKOTA 3.9L
- 1996 8 DODGE DAKOTA 5.2L

645856

Inlet A: WELDED 3-BOLT FLANGE W/ FLARE
 Inlet B: WELDED 3-BOLT FLANGE W/ FLARE
 Outlet A: WELDED 2-BOLT FLANGE
 Outlet B: WELDED 2-BOLT FLANGE
 Length: 81.50"



- 2004-00 8 CHEVROLET CORVETTE 5.7L

645857

Inlet A: LOOSE 2-BOLT FLANGE W/ FLARE
 Inlet B: LOOSE 2-BOLT FLANGE W/ FLARE
 Outlet A: 3" O.D. PIPE
 Length: 62.75"



- 2003 8 DODGE RAM (2WD & 4WD) PICKUP 1/2 & 3/4 TON 5.7L

645858

Inlet A: LOOSE 2-BOLT FLANGE W/ SPHERICAL FLARE
 Inlet B: LOOSE 2-BOLT FLANGE W/ SPHERICAL FLARE
 Outlet A: 2.50" O.D. PIPE
 Length: 57.50"

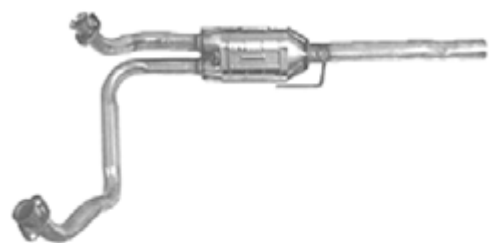

- 2001-00 8 DODGE RAM (2WD & 4WD) PICKUP 1 TON 5.9L
- 2001-00 8 DODGE RAM (2WD & 4WD) PICKUP 1/2 & 3/4 TON 5.2L
- 2001-00 8 DODGE RAM (2WD & 4WD) PICKUP 1/2 & 3/4 TON 5.9L

645859

Inlet A: LOOSE 2-BOLT FLANGE W/ SPHERICAL FLARE
 Inlet B: LOOSE 2-BOLT FLANGE W/ SPHERICAL FLARE
 Outlet A: 2.50" O.D. PIPE
 Length: 59"

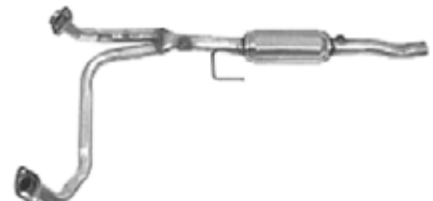

- 2003-00 6 DODGE DAKOTA 3.9L

645860

Inlet A: LOOSE 2-BOLT FLANGE W/ SPHERICAL FLARE
 Inlet B: LOOSE 2-BOLT FLANGE W/ SPHERICAL FLARE
 Outlet A: 2.50" O.D. PIPE
 Length: 59"



2003-00 6 DODGE DAKOTA 3.9L

645861

Inlet A: LOOSE 3-BOLT FLANGE W/ SPHERICAL FLARE
 Inlet B: LOOSE 3-BOLT FLANGE W/ SPHERICAL FLARE
 Outlet A: WELDED 2-BOLT FLANGE
 Outlet B: 3" O.D. PIPE
 Length: 56.63"



2008-05 8 GMC C5500 8.1L

645862

Inlet A: WELDED 3-BOLT FLANGE
 Outlet A: 3" O.D. PIPE
 Length: 63"



2005-03 8 CHEVROLET G -VAN 1 TON (Inc. Express Van) 6.0L
 2005-03 8 CHEVROLET G -VAN 1/2 & 3/4 TON (Inc. Express Van) 4.8L
 2005-03 8 CHEVROLET G -VAN 1/2 & 3/4 TON (Inc. Express Van) 6.0L
 2005-03 8 GMC G -VAN 1 TON (Inc. Savana Van) 6.0L
 2005-03 8 GMC G -VAN 1/2 & 3/4 TON (Inc. Savana Van) 4.8L
 2005-03 8 GMC G -VAN 1/2 & 3/4 TON (Inc. Savana Van) 6.0L

645863

Inlet A: WELDED 3-BOLT FLANGE
 Outlet A: WELDED 3-BOLT FLANGE
 Length: 60.75"



2005-03 8 CHEVROLET G -VAN 1 TON (Inc. Express Van) 6.0L
 2005-03 8 CHEVROLET G -VAN 1/2 & 3/4 TON (Inc. Express Van) 4.8L
 2005-03 8 CHEVROLET G -VAN 1/2 & 3/4 TON (Inc. Express Van) 6.0L
 2005-03 8 GMC G -VAN 1 TON (Inc. Savana Van) 6.0L
 2005-03 8 GMC G -VAN 1/2 & 3/4 TON (Inc. Savana Van) 4.8L
 2005-03 8 GMC G -VAN 1/2 & 3/4 TON (Inc. Savana Van) 6.0L

645864

Inlet A: LOOSE 3-BOLT FLANGE W/ FLARE
 Outlet A: WELDED 2-BOLT FLANGE
 Length: 48.13"



2007-06 6 BUICK RAINIER 4.2L
 2007-06 6 CHEVROLET TRAILBLAZER 4.2L
 2007-06 6 GMC ENVOY 4.2L
 2007-06 6 ISUZU ASCENDER 4.2L
 2007-06 6 SAAB 9-7X 4.2L

645865

Inlet A: LOOSE 2-BOLT FLANGE W/ SPHERICAL FLARE
 Inlet B: LOOSE 2-BOLT FLANGE W/ SPHERICAL FLARE
 Outlet A: WELDED 2-BOLT FLANGE W/ FLARE
 Length: 50.25"



2006-04 6 JEEP WRANGLER 4.0L

DIRECT FIT



645866

Inlet A: LOOSE 2-BOLT FLANGE W/ FLARE
Inlet B: 2.25" I.D. PIPE
Outlet A: 2.75" O.D. PIPE
Length: 54.38"



2005-04 8 DODGE RAM (2WD & 4WD) PICKUP 1/2 & 3/4 TON 5.7L

645870

Inlet A: LOOSE 2-BOLT FLANGE W/ SPHERICAL FLARE
Inlet B: LOOSE 2-BOLT FLANGE W/ SPHERICAL FLARE
Outlet A: 2.50" O.D. PIPE
Length: 59.25"



2003-01 8 DODGE DAKOTA 4.7L

645867

Inlet A: WELDED 2-BOLT FLANGE W/ GASKET STUB
Inlet B: 45 DEGREE FLARE
Outlet A: WELDED 2-BOLT FLANGE
Length: 57"



2004 6 JEEP LIBERTY 3.7L

645871

Inlet A: LOOSE 2-BOLT FLANGE W/ SPHERICAL FLARE
Outlet A: WELDED 2-BOLT FLANGE W/ GASKET STUB
Length: 48.50"



2006-01 4 FORD RANGER 2.3L
2006-01 4 MAZDA B-Series PICKUP 2.3L

645868

Inlet A: LOOSE 3-BOLT FLANGE W/ SPHERICAL FLARE
Inlet B: LOOSE 3-BOLT FLANGE W/ SPHERICAL FLARE
Outlet A: WELDED 2-BOLT FLANGE W/ GASKET STUB
Outlet B: WELDED 2-BOLT FLANGE W/ GASKET STUB
Length: 81.50"



2004-00 8 CHEVROLET CORVETTE 5.7L

645872

Inlet A: LOOSE 2-BOLT FLANGE W/ SPHERICAL FLARE
Inlet B: LOOSE 2-BOLT FLANGE W/ SPHERICAL FLARE
Outlet A: WELDED 2-BOLT FLANGE W/ GASKET STUB
Length: 58.50"



2005-02 8 FORD EXPLORER 4.6L
2005-02 8 MERCURY MOUNTAINEER 4.6L

645869

Inlet A: LOOSE 2-BOLT FLANGE W/ SPHERICAL FLARE
Inlet B: LOOSE 2-BOLT FLANGE W/ SPHERICAL FLARE
Outlet A: 2.50" O.D. PIPE
Length: 59.25"



2003-01 8 DODGE DAKOTA 4.7L

645873

Inlet A: WELDED 3-BOLT FLANGE
Outlet A: 2.50" O.D. PIPE
Length: 51.25"



2006-03 8 HUMMER H2 6.0L

645874

Inlet A: LOOSE 2-BOLT FLANGE W/ SPHERICAL FLARE
Inlet B: LOOSE 2-BOLT FLANGE W/ SPHERICAL FLARE
Outlet A: WELDED 2-BOLT FLANGE
Length: 56.38"



2007-05 6 JEEP LIBERTY 3.7L

645875

Inlet A: LOOSE 2-BOLT FLANGE W/ SPHERICAL FLARE
Inlet B: LOOSE 2-BOLT FLANGE W/ SPHERICAL FLARE
Outlet A: 2.50" O.D. PIPE
Length: 68.75"



1996 6 FORD E-150 VAN 1/2 TON 4.9L
1996 6 FORD E-250 VAN 3/4 TON 4.9L
1996 6 FORD E-350 VAN 1 TON 4.9L

645876

Inlet A: LOOSE 2-BOLT FLANGE W/ SPHERICAL FLARE
Inlet B: LOOSE 2-BOLT FLANGE W/ SPHERICAL FLARE
Outlet A: 2.365" O.D. PIPE
Outlet B: LOOSE 2-BOLT FLANGE W/ 45 DEGREE FLARE
Length: 72.25"



1993-92 8 MERCEDES-BENZ 400 4.2L
1993-92 8 MERCEDES-BENZ 500 5.0L
1995-94 8 MERCEDES-BENZ S420 4.2L
1995-94 8 MERCEDES-BENZ S500 5.0L

645877

Inlet A: WELDED 3-BOLT FLANGE W/ GASKET STUB
Outlet A: WELDED 2-BOLT FLANGE W/ GASKET STUB
Length: 49.75"



2006-05 8 TOYOTA TUNDRA 4.7L

645878

Inlet A: LOOSE 3-BOLT FLANGE W/ SPHERICAL FLARE
Outlet A: WELDED 2-BOLT FLANGE
Length: 50.50"



2005-04 6 BUICK RAINIER 4.2L
2005-02 6 CHEVROLET TRAILBLAZER 4.2L
2005-02 6 GMC ENVOY 4.2L
2005-04 6 ISUZU ASCENDER 4.2L
2004-02 6 OLDSMOBILE BRAVADA 4.2L

DIRECT FIT



645879

Inlet A: LOOSE 3-BOLT FLANGE W/ FLARE
 Inlet B: LOOSE 3-BOLT FLANGE W/ FLARE
 Outlet A: WELDED 3-BOLT FLANGE
 Length: 59.75"



2005-00 6 CHEVROLET ASTRO VAN 4.3L
 2005-00 6 GMC SAFARI VAN 4.3L

645880

Inlet A: 2" I.D. PIPE
 Outlet A: 2" O.D. PIPE
 Length: 50.50"



1998-97 4 DODGE DAKOTA 2.5L

645881

Inlet A: 2-BOLT FLANGE W/ SPHERICAL FLARE
 Inlet B: 2-BOLT FLANGE W/ SPHERICAL FLARE
 Outlet A: 2.50" O.D. PIPE
 Length: 57.50"



1996-92 8 FORD E-150 VAN 1/2 TON 5.0L

645882

Inlet A: LOOSE 3-BOLT FLANGE W/ SPHERICAL FLARE
 Inlet B: LOOSE 3-BOLT FLANGE W/ SPHERICAL FLARE
 Outlet A: WELDED 3-BOLT FLANGE
 Length: 68.25"



1999-96 6 CHEVROLET G -VAN 1/2 & 3/4 TON (Inc.

645882 (cont.)

Express Van) 4.3L
 1999-96 6 GMC G -VAN 1/2 & 3/4 TON (Inc. Savana Van)
 4.3L

645883

Inlet A: WELDED 3-BOLT FLANGE W/ GASKET STUB
 Outlet A: WELDED 2-BOLT FLANGE
 Length: 57.75"



2004-01 8 TOYOTA SEQUOIA 4.7L

645884

Inlet A: LOOSE 2-BOLT FLANGE W/ SPHERICAL FLARE
 Inlet B: LOOSE 2-BOLT FLANGE W/ SPHERICAL FLARE
 Outlet A: 2.50" O.D. PIPE
 Length: 61.50"



2003-00 8 DODGE DURANGO 5.9L

645887

Inlet A: LOOSE 2-BOLT FLANGE W/ SPHERICAL FLARE
 Inlet B: LOOSE 2-BOLT FLANGE W/ SPHERICAL FLARE
 Outlet A: WELDED 2-BOLT FLANGE W/ GASKET STUB
 Length: 57.50"



2005-02 6 FORD EXPLORER 4.0L
 2005-02 6 MERCURY MOUNTAINEER 4.0L

645888

Inlet A: LOOSE 2-BOLT FLANGE W/ SPHERICAL FLARE
 Inlet B: LOOSE 2-BOLT FLANGE W/ SPHERICAL FLARE
 Outlet A: 2.50" O.D. PIPE
 Length: 61.50"



2003-00 8 DODGE DURANGO 4.7L

645889

Inlet A: LOOSE 3-BOLT FLANGE W/ SPHERICAL FLARE
 Inlet B: LOOSE 3-BOLT FLANGE W/ SPHERICAL FLARE
 Outlet A: WELDED 2-BOLT FLANGE
 Length: 61.50"

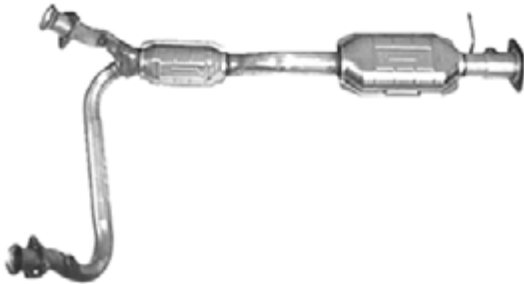

2003-01 6 CHEVROLET S-Series (2WD), T-Series (4WD)
 PICKUP 4.3L
 2003-01 6 GMC S-Series (2WD), T-Series (4WD) PICKUP
 (SONOMA) 4.3L

645890

Inlet A: LOOSE 3-BOLT FLANGE W/ SPHERICAL FLARE
 Inlet B: LOOSE 3-BOLT FLANGE W/ SPHERICAL FLARE
 Outlet A: WELDED 2-BOLT FLANGE
 Length: 59.25"

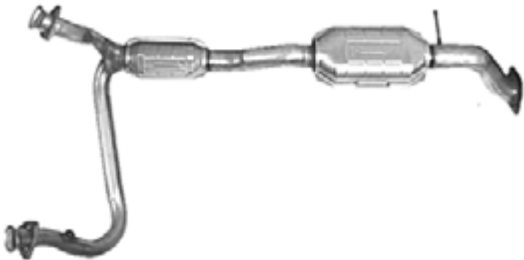

2005-00 6 CHEVROLET BLAZER S-Series 4.3L
 2004-01 6 CHEVROLET S-Series (2WD), T-Series (4WD)
 PICKUP 4.3L
 2002-00 6 GMC S-15 JIMMY 4.3L
 2004-01 6 GMC S-Series (2WD), T-Series (4WD) PICKUP
 (SONOMA) 4.3L
 2001-00 6 OLDSMOBILE BRAVADA 4.3L

645891

Inlet A: LOOSE 3-BOLT FLANGE W/ SPHERICAL FLARE
 Inlet B: LOOSE 3-BOLT FLANGE W/ SPHERICAL FLARE
 Outlet A: WELDED 2-BOLT FLANGE
 Length: 59.25"



2000 6 CHEVROLET BLAZER S-Series 4.3L
 2000 6 GMC ENVOY 4.3L
 2000 6 GMC S-15 JIMMY 4.3L
 2000 6 OLDSMOBILE BRAVADA 4.3L

645892

Inlet A: LOOSE 2-BOLT FLANGE W/ SPHERICAL FLARE
 Outlet A: 2.25" O.D. PIPE
 Length: 52"



2000-97 6 JEEP WRANGLER 4.0L

645893

Inlet A: LOOSE 2-BOLT FLANGE W/ SPHERICAL FLARE
 Outlet A: 2.25" O.D. PIPE
 Length: 52"



2000-97 6 JEEP WRANGLER 4.0L

DIRECT FIT



645894

Inlet A: LOOSE 3-BOLT FLANGE W/ SPHERICAL FLARE
 Inlet B: LOOSE 3-BOLT FLANGE W/ SPHERICAL FLARE
 Outlet A: WELDED 2-BOLT FLANGE
 Length: 52"

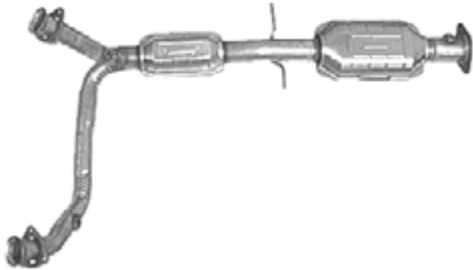

- 2002-00 6 CHEVROLET S-Series (2WD), T-Series (4WD) PICKUP 4.3L
- 2002-00 6 GMC S-Series (2WD), T-Series (4WD) PICKUP (SONOMA) 4.3L

645895

Inlet A: LOOSE 2-BOLT FLANGE W/ SPHERICAL FLARE
 Inlet B: 2.50" I.D. PIPE
 Outlet A: 2.50" O.D. PIPE
 Length: 49.50"



- 2004-01 8 FORD F-150 PICKUP 1/2 TON 5.4L

645896

Inlet A: LOOSE 3-BOLT FLANGE W/ SPHERICAL FLARE
 Inlet B: LOOSE 3-BOLT FLANGE W/ SPHERICAL FLARE
 Outlet A: WELDED 2-BOLT FLANGE
 Length: 69.75"

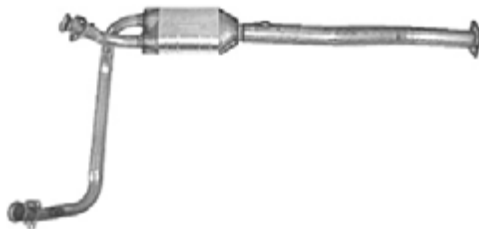

- 2002-00 6 CHEVROLET G -VAN 1/2 & 3/4 TON (Inc. Express Van) 4.3L
- 2002-00 8 CHEVROLET G -VAN 1/2 & 3/4 TON (Inc. Express Van) 5.0L
- 2002-00 6 GMC G -VAN 1/2 & 3/4 TON (Inc. Savana Van) 4.3L
- 2002-00 8 GMC G -VAN 1/2 & 3/4 TON (Inc. Savana Van) 5.0L

645897

Inlet A: LOOSE 2-BOLT FLANGE W/ FEMALE FLARE
 Outlet A: WELDED 2-BOLT FLANGE W/ GASKET STUB
 Length: 49"



- 2001-98 4 FORD RANGER 2.5L
- 2001-98 4 MAZDA B-Series PICKUP 2.5L

645898

Inlet A: LOOSE 2-BOLT FLANGE W/ SPHERICAL FLARE
 Inlet B: LOOSE 2-BOLT FLANGE W/ SPHERICAL FLARE
 Outlet A: 2.25" O.D. PIPE
 Length: 70.75"



- 1996 6 FORD F-150 PICKUP 1/2 TON 4.9L
- 1996 6 FORD F-250 PICKUP 3/4 TON 4.9L
- 1996 6 FORD F-350 PICKUP 1 TON 4.9L

645899

Inlet A: LOOSE 2-BOLT FLANGE W/ SPHERICAL FLARE
 Inlet B: LOOSE 2-BOLT FLANGE W/ SPHERICAL FLARE
 Outlet A: 2.50" O.D. PIPE
 Length: 60"



- 2003-00 6 DODGE DAKOTA 3.9L

645900

Inlet A: 2.50" I.D. PIPE
 Outlet A: 2.50" O.D. PIPE
 Length: 53"



- 1991-88 8 DODGE D-(2WD) & W-(4WD) PICKUP 1 TON 5.9L
- 1992-88 6 DODGE D-(2WD) & W-(4WD) PICKUP 1/2 & 3/4 TON 3.9L
- 1992-88 8 DODGE D-(2WD) & W-(4WD) PICKUP 1/2 & 3/4 TON 5.9L

645911

Inlet A: LOOSE 2-BOLT FLANGE W/ FEMALE FLARE
 Inlet B: LOOSE 2-BOLT FLANGE W/ FEMALE FLARE
 Outlet A: 2.25" O.D. PIPE
 Length: 58.50"



1995-85 8 FORD F-150 PICKUP 1/2 TON 5.0L
 1995-85 8 FORD F-250 PICKUP 3/4 TON 5.0L

645917

Inlet A: LOOSE 2-BOLT FLANGE W/ SPHERICAL FLARE
 Inlet B: LOOSE 2-BOLT FLANGE W/ SPHERICAL FLARE
 Outlet A: 2.50" O.D. PIPE
 Length: 64.50"

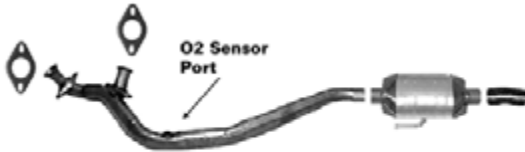

1995-87 6 FORD E-150 VAN 1/2 TON 4.9L
 1995-87 6 FORD E-250 VAN 3/4 TON 4.9L
 1995-87 6 FORD E-350 VAN 1 TON 4.9L

645922

Inlet A: LOOSE 2-BOLT FLANGE W/ FEMALE FLARE
 Inlet B: LOOSE 2-BOLT FLANGE W/ FEMALE FLARE
 Outlet A: 2.50" O.D. PIPE
 Length: 53"

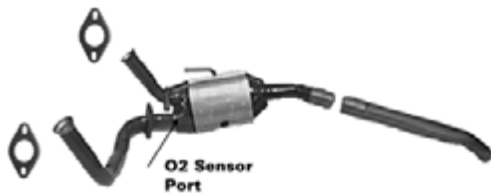

1991-86 8 FORD E-150 VAN 1/2 TON 5.0L
 1991-86 8 FORD E-250 VAN 3/4 TON 5.0L

645923

Inlet A: LOOSE 2-BOLT FLANGE W/ SPHERICAL FLARE
 Inlet B: LOOSE 2-BOLT FLANGE W/ SPHERICAL FLARE
 Outlet A: 2.25" O.D. PIPE
 Length: 61.50"



1996 8 FORD F-150 PICKUP 1/2 TON 5.0L
 1996 8 FORD F-250 PICKUP 3/4 TON 5.0L

645924

Inlet A: LOOSE 3-BOLT FLANGE W/ FEMALE FLARE
 Inlet B: LOOSE 3-BOLT FLANGE W/ FEMALE FLARE
 Outlet A: LOOSE 4-BOLT FLANGE W/ MALE BALL
 Length: 64.50"



1991-86 8 CHEVROLET CORVETTE 5.7L

645925

Inlet A: LOOSE 3-BOLT FLANGE W/ FEMALE FLARE
 Inlet B: LOOSE 3-BOLT FLANGE W/ FEMALE FLARE
 Outlet A: 3" O.D. PIPE
 Length: 46.50"

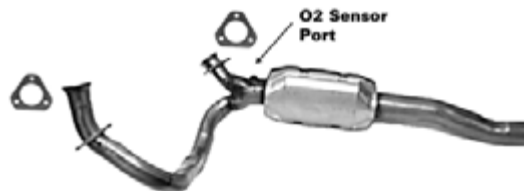

1995-94 6 CHEVROLET ASTRO VAN 4.3L
 1995-94 6 GMC SAFARI VAN 4.3L

DIRECT FIT



645926

Inlet A: LOOSE 2-BOLT FLANGE W/ FEMALE FLARE
 Inlet B: LOOSE 2-BOLT FLANGE W/ FEMALE FLARE
 Outlet A: 2.50" O.D. PIPE
 Length: 57.25"

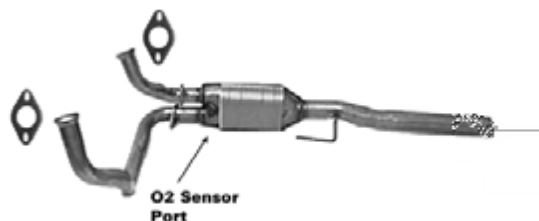

- 1995-94 6 DODGE RAM (2WD & 4WD) PICKUP 1/2 & 3/4 TON 3.9L
- 1995-94 8 DODGE RAM (2WD & 4WD) PICKUP 1/2 & 3/4 TON 5.2L
- 1995-94 8 DODGE RAM (2WD & 4WD) PICKUP 1/2 & 3/4 TON 5.9L

645927

Inlet A: LOOSE 3-BOLT FLANGE W/ 45 DEGREE FLARE
 Inlet B: LOOSE 3-BOLT FLANGE W/ 45 DEGREE FLARE
 Outlet A: WELDED 3-BOLT FLANGE
 Length: 69.25"

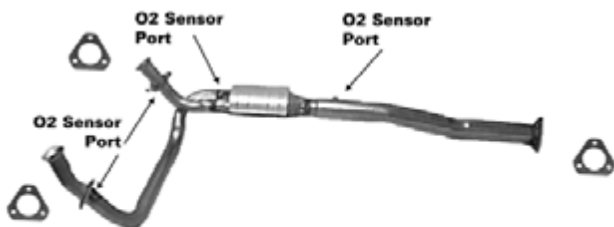

- 1999-96 6 CHEVROLET G -VAN 1/2 & 3/4 TON (Inc. Express Van) 4.3L
- 1999-96 8 CHEVROLET G -VAN 1/2 & 3/4 TON (Inc. Express Van) 5.0L
- 1999-96 8 CHEVROLET G -VAN 1/2 & 3/4 TON (Inc. Express Van) 5.7L
- 1999-96 6 GMC G -VAN 1/2 & 3/4 TON (Inc. Savana Van) 4.3L
- 1999-96 8 GMC G -VAN 1/2 & 3/4 TON (Inc. Savana Van) 5.0L
- 1999-96 8 GMC G -VAN 1/2 & 3/4 TON (Inc. Savana Van) 5.7L

645928

Inlet A: LOOSE 2-BOLT FLANGE W/ FEMALE FLARE
 Inlet B: LOOSE 2-BOLT FLANGE W/ FEMALE FLARE
 Outlet A: 2.25" O.D. PIPE
 Length: 69.75"

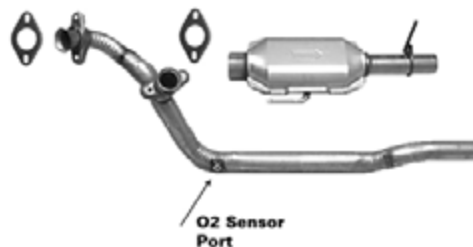

- 1990-87 6 FORD BRONCO 4.9L
- 1995-87 6 FORD F-150 PICKUP 1/2 TON 4.9L
- 1995-87 6 FORD F-250 PICKUP 3/4 TON 4.9L
- 1995-87 6 FORD F-350 PICKUP 1 TON 4.9L

645931

Inlet A: LOOSE 3-BOLT FLANGE W/ 45 DEGREE FLARE
 Inlet B: LOOSE 3-BOLT FLANGE W/ 45 DEGREE FLARE
 Outlet A: WELDED 3-BOLT FLANGE
 Length: 49"

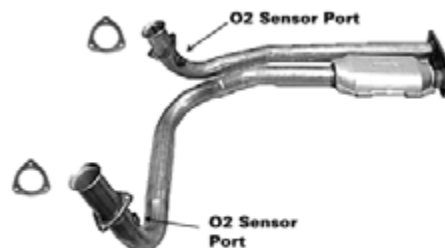

- 2000-96 8 CHEVROLET C-(2WD), K-(4WD) PICKUP 1 TON, (Inc. SILVERADO) 7.4L
- 2000-96 8 CHEVROLET C-(2WD), K-(4WD) PICKUP 3/4 TON, (Inc. SILVERADO & AVALANCHE) 7.4L
- 1999-96 8 CHEVROLET SUBURBAN/TAHOE 7.4L
- 2000-96 8 GMC C-(2WD), K-(4WD) PICKUP 1 TON, (Inc. SIERRA) 7.4L
- 2000-96 8 GMC C-(2WD), K-(4WD) PICKUP 3/4 TON, (Inc. SIERRA) 7.4L
- 1999-96 8 GMC SUBURBAN/YUKON 7.4L

645932

Inlet A: LOOSE 2-BOLT FLANGE W/ 2.25" FEMALE FLARE
 Inlet B: LOOSE 2-BOLT FLANGE W/ 2" FEMALE FLARE
 Outlet A: 2.25" O.D. PIPE
 Length: 52.50"



1998-93 8 LINCOLN MARK Series 4.6L

645933

Inlet A: LOOSE 2-BOLT FLANGE W/ 2.25" FEMALE FLARE
 Inlet B: LOOSE 2-BOLT FLANGE W/ 2-1/2" FEMALE FLARE
 Outlet A: 2.25" O.D. PIPE
 Length: 57"



1995-88 8 FORD F-150 PICKUP 1/2 TON 5.8L
 1995-88 8 FORD F-250 PICKUP 3/4 TON 5.8L

645935

Inlet A: LOOSE 2-BOLT FLANGE W/ FEMALE FLARE
 Inlet B: 2.50" I.D. PIPE
 Outlet A: 2.50" O.D. PIPE
 Length: 49"



1999-97 6 FORD E-150 VAN 1/2 TON 4.2L
 1999-97 6 FORD E-250 VAN 3/4 TON 4.2L

645937

Inlet A: LOOSE 2-BOLT FLANGE W/ FEMALE FLARE
 Inlet B: LOOSE 2-BOLT FLANGE W/ FEMALE FLARE
 Outlet A: 2.50" O.D. PIPE
 Length: 57.25"



1999-96 8 DODGE RAM (2WD & 4WD) PICKUP 1 TON 5.9L
 1999-96 6 DODGE RAM (2WD & 4WD) PICKUP 1/2 & 3/4 TON 3.9L
 1999-96 8 DODGE RAM (2WD & 4WD) PICKUP 1/2 & 3/4 TON 5.2L
 1999-96 8 DODGE RAM (2WD & 4WD) PICKUP 1/2 & 3/4 TON 5.9L

645938

Inlet A: LOOSE 2-BOLT FLANGE W/ FEMALE FLARE
 Inlet B: LOOSE 2-BOLT FLANGE W/ FEMALE FLARE
 Outlet A: 2.50" O.D. PIPE
 Length: 53.25"

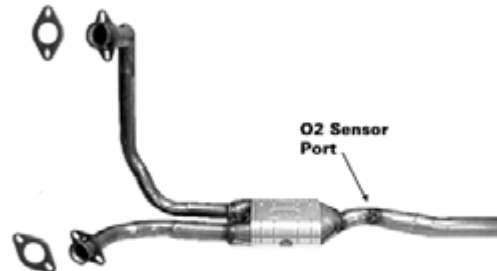

1997-95 6 DODGE B-VAN 3.9L
 1997-95 8 DODGE B-VAN 5.2L
 1997-95 8 DODGE B-VAN 5.9L

645939

Inlet A: WELDED 3-BOLT FLANGE
 Inlet B: WELDED 3-BOLT FLANGE
 Outlet A: 1.89" O.D. PIPE
 Outlet B: LOOSE 2-BOLT FLANGE W/ 45 DEGREE FLARE
 Length: 79.75"

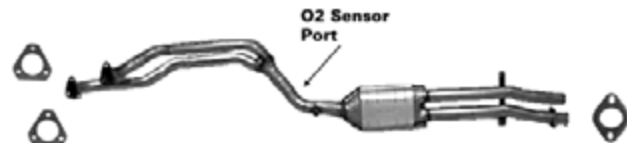

1995-92 6 BMW 325 2.5L
 1998-96 6 BMW 328 2.8L
 1998-96 6 BMW M3 3.2L

DIRECT FIT



645940

Inlet A: 3" I.D. PIPE
 Outlet A: 2.75" O.D. PIPE
 Length: 59.25"



1993-92 6 DODGE DAKOTA 3.9L
 1993-92 8 DODGE DAKOTA 5.2L

645944

Inlet A: 2.50" O.D. PIPE
 Outlet A: 2.50" O.D. PIPE
 Length: 57"



1991-90 6 DODGE DAKOTA 3.9L

645945

Inlet A: LOOSE 2-BOLT FLANGE W/ SPHERICAL FLARE
 Inlet B: WELDED 3-BOLT FLANGE
 Outlet A: 2.71" O.D. PIPE
 Length: 53"



1997-95 8 CHEVROLET CAMARO 5.7L
 1997-95 8 PONTIAC FIREBIRD, TRANS AM, FORMULA 5.7L

645946

Inlet A: LOOSE 3-BOLT FLANGE W/ 45 DEGREE FLARE
 Inlet B: LOOSE 3-BOLT FLANGE W/ 45 DEGREE FLARE
 Outlet A: WELDED 2-BOLT FLANGE
 Length: 48.63"

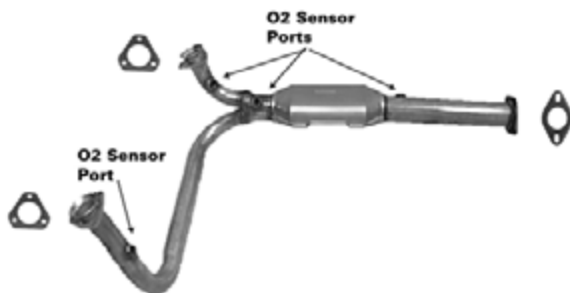

1998-96 6 CHEVROLET C-(2WD), K-(4WD) PICKUP 1/2 TON, (Inc. SILVERADO & AVALANCHE) 4.3L

645946 (cont.)

1999-96 8 CHEVROLET C-(2WD), K-(4WD) PICKUP 1/2 TON, (Inc. SILVERADO & AVALANCHE) 5.0L
 1999-96 8 CHEVROLET C-(2WD), K-(4WD) PICKUP 1/2 TON, (Inc. SILVERADO & AVALANCHE) 5.7L
 1998-96 8 CHEVROLET C-(2WD), K-(4WD) PICKUP 3/4 TON, (Inc. SILVERADO & AVALANCHE) 5.0L
 1998-96 6 GMC C-(2WD), K-(4WD) PICKUP 1/2 TON, (Inc. SIERRA) 4.3L
 1998-96 8 GMC C-(2WD), K-(4WD) PICKUP 1/2 TON, (Inc. SIERRA) 5.0L
 1998-96 8 GMC C-(2WD), K-(4WD) PICKUP 1/2 TON, (Inc. SIERRA) 5.7L
 1998-96 8 GMC C-(2WD), K-(4WD) PICKUP 3/4 TON, (Inc. SIERRA) 5.0L

645947

Inlet A: LOOSE 3-BOLT FLANGE W/ FEMALE FLARE
 Inlet B: WELDED 3-BOLT FLANGE
 Outlet A: WELDED 2-BOLT FLANGE
 Length: 50.50"

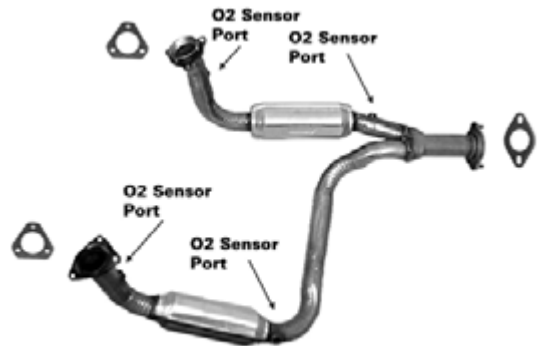

2000-99 6 CHEVROLET C-(2WD), K-(4WD) PICKUP 1/2 TON, (Inc. SILVERADO & AVALANCHE) 4.3L
 2000-99 8 CHEVROLET C-(2WD), K-(4WD) PICKUP 1/2 TON, (Inc. SILVERADO & AVALANCHE) 4.8L
 2000-99 8 CHEVROLET C-(2WD), K-(4WD) PICKUP 1/2 TON, (Inc. SILVERADO & AVALANCHE) 5.3L
 2000-99 8 CHEVROLET C-(2WD), K-(4WD) PICKUP 3/4 TON, (Inc. SILVERADO & AVALANCHE) 5.3L
 2000-98 6 GMC C-(2WD), K-(4WD) PICKUP 1/2 TON, (Inc. SIERRA) 4.3L
 2000-99 8 GMC C-(2WD), K-(4WD) PICKUP 1/2 TON, (Inc. SIERRA) 4.8L
 2000-99 8 GMC C-(2WD), K-(4WD) PICKUP 1/2 TON, (Inc. SIERRA) 5.3L
 2000-99 8 GMC C-(2WD), K-(4WD) PICKUP 3/4 TON, (Inc. SIERRA) 5.3L

645949

Inlet A: WELDED 4-BOLT FLANGE
Outlet A: LOOSE 2-BOLT FLANGE W/ SPECIAL RING
Length: 56"



1994-91 4 BMW 318 1.8L

645955

Inlet A: LOOSE 3-BOLT FLANGE W/ 45 DEGREE FLARE
Inlet B: LOOSE 3-BOLT FLANGE W/ 45 DEGREE FLARE
Outlet A: WELDED 3-BOLT FLANGE
Length: 54.75"

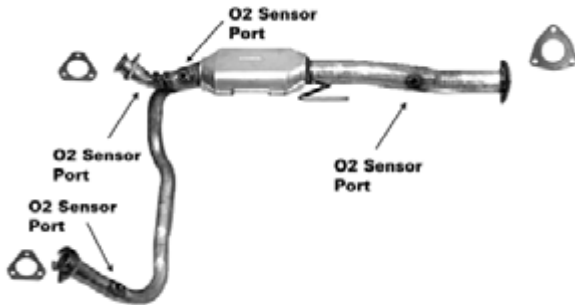

1999-96 6 CHEVROLET ASTRO VAN 4.3L
1999-96 6 GMC SAFARI VAN 4.3L

645959

Inlet A: LOOSE 3-BOLT FLANGE W/ 45 DEGREE FLARE
Inlet B: LOOSE 3-BOLT FLANGE W/ 45 DEGREE FLARE
Outlet A: WELDED 3-BOLT FLANGE
Length: 53.50"

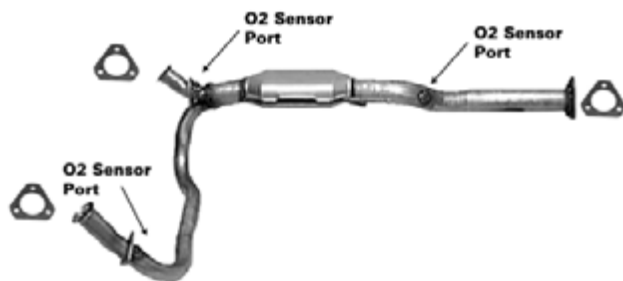

2001-00 6 CHEVROLET ASTRO VAN 4.3L
2001-00 6 GMC SAFARI VAN 4.3L

645961

Inlet A: 2.50" I.D. PIPE
Outlet A: 2.50" O.D. PIPE
Length: 59.25"



1999-97 6 DODGE DAKOTA 3.9L
1999 6 DODGE DURANGO 3.9L

645962

Inlet A: LOOSE 2-BOLT FLANGE W/ 2.50" FEMALE FLARE
Inlet B: LOOSE 2-BOLT FLANGE W/ 2.50" FEMALE FLARE
Outlet A: 2.50" O.D. PIPE
Length: 57"



1995-88 8 FORD E-150 VAN 1/2 TON 5.8L
1995-88 8 FORD E-250 VAN 3/4 TON 5.8L

645965

Inlet A: LOOSE 2-BOLT FLANGE W/ FEMALE FLARE
Inlet B: LOOSE 2-BOLT FLANGE W/ FEMALE FLARE
Outlet A: 1.965" O.D. PIPE
Outlet B: LOOSE 2-BOLT FLANGE W/ 45 DEGREE FLARE
Length: 75.63"

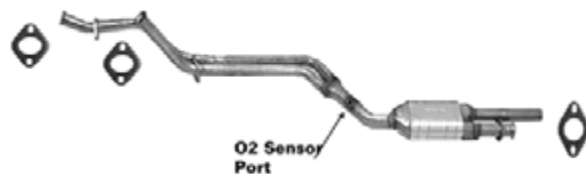

1989-87 6 MERCEDES-BENZ 260 2.6L
1993-86 6 MERCEDES-BENZ 300 3.0L

DIRECT FIT



645973

Inlet A: LOOSE 2-BOLT FLANGE W/ FEMALE FLARE
 Inlet B: LOOSE 2-BOLT FLANGE W/ FEMALE FLARE
 Outlet A: WELDED 2-BOLT FLANGE
 Length: 53.75"

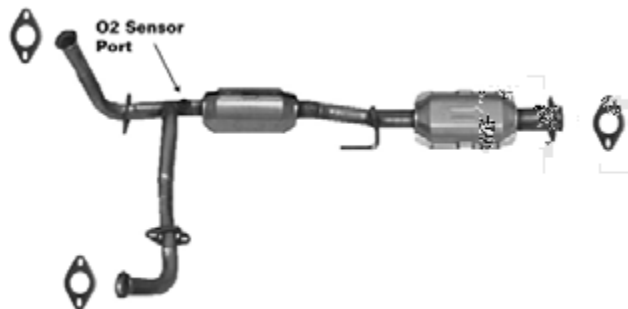

1997-90 6 FORD AEROSTAR 4.0L

645978

Inlet A: WELDED 3-BOLT FLANGE
 Inlet B: 2-BOLT FLANGE W/ FEMALE FLARE
 Outlet A: 2.75" O.D. PIPE
 Length: 51.50"



1999-98 8 CHEVROLET CAMARO 5.7L
 1999-98 8 PONTIAC FIREBIRD, TRANS AM, FORMULA 5.7L

645974

Inlet A: LOOSE 3-BOLT FLANGE W/ FEMALE FLARE
 Inlet B: LOOSE 3-BOLT FLANGE W/ FEMALE FLARE
 Outlet A: 3" O.D. PIPE
 Length: 50.25"

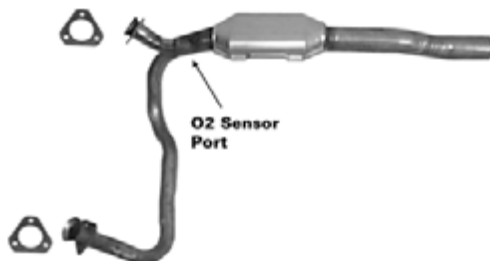

1995-94 6 CHEVROLET ASTRO VAN 4.3L
 1995-94 6 GMC SAFARI VAN 4.3L

645979

Inlet A: WELDED 4-BOLT FLANGE
 Outlet A: 2.125" O.D. PIPE
 Length: 64.75"



2005-00 6 BUICK LESABRE 3.8L
 2005-00 6 BUICK PARK AVENUE 3.8L
 2005-00 8 CADILLAC DEVILLE 4.6L
 2011-06 8 CADILLAC DTS 4.6L
 2002-01 6 OLDSMOBILE AURORA 3.5L
 2003-01 8 OLDSMOBILE AURORA 4.0L
 2005-00 6 PONTIAC BONNEVILLE 3.8L
 2005-04 8 PONTIAC BONNEVILLE 4.6L

645977

Inlet A: 3-BOLT FLANGE W/ 45 DEGREE FLARE
 Inlet B: 3-BOLT FLANGE W/ 45 DEGREE FLARE
 Outlet A: WELDED 2-BOLT FLANGE
 Outlet B: WELDED 2-BOLT FLANGE
 Length: 79.50"



1999-97 8 CHEVROLET CORVETTE 5.7L

645980

Inlet A: 3-BOLT FLANGE W/ FEMALE FLARE
 Outlet A: 3" O.D. PIPE
 Length: 60.75"



1996 8 CHEVROLET G -VAN 1 TON (Inc. Express Van) 5.7L
 1999-96 8 CHEVROLET G -VAN 1/2 & 3/4 TON (Inc. Express Van) 5.7L
 1996 8 GMC G -VAN 1 TON (Inc. Savana Van) 5.7L
 1999-96 8 GMC G -VAN 1/2 & 3/4 TON (Inc. Savana Van) 5.7L

645981

Inlet A: 3-BOLT FLANGE W/ FEMALE FLARE
Outlet A: WELDED 3-BOLT FLANGE
Length: 66.25"



- 1996 8 CHEVROLET G -VAN 1 TON (Inc. Express Van) 5.7L
- 1999-96 8 CHEVROLET G -VAN 1/2 & 3/4 TON (Inc. Express Van) 5.7L
- 1996 8 GMC G -VAN 1 TON (Inc. Savana Van) 5.7L
- 1999-96 8 GMC G -VAN 1/2 & 3/4 TON (Inc. Savana Van) 5.7L

645986

Inlet A: LOOSE 2-BOLT FLANGE W/ FEMALE FLARE
Inlet B: LOOSE 2-BOLT FLANGE W/ FEMALE FLARE
Outlet A: 2.50" O.D. PIPE
Length: 54.50"

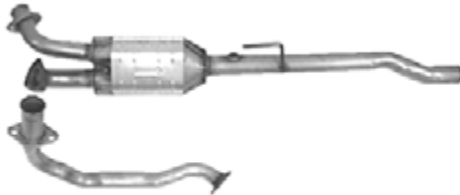

- 2003-02 6 DODGE RAM (2WD & 4WD) PICKUP 1/2 & 3/4 TON 3.7L
- 2003-02 8 DODGE RAM (2WD & 4WD) PICKUP 1/2 & 3/4 TON 4.7L
- 2003-02 8 DODGE RAM (2WD & 4WD) PICKUP 1/2 & 3/4 TON 5.9L

645988

Inlet A: LOOSE 3-BOLT FLANGE W/ SPHERICAL FLARE
Inlet B: WELDED 3-BOLT FLANGE
Outlet A: WELDED 2-BOLT FLANGE
Length: 50.50"



- 2005-02 8 CADILLAC ESCALADE 5.3L
- 2006-00 6 CHEVROLET C-(2WD), K-(4WD) PICKUP 1/2 TON, (Inc. SILVERADO & AVALANCHE) 4.3L
- 2006-00 8 CHEVROLET C-(2WD), K-(4WD) PICKUP 1/2

645988 (cont.)

- 2006-00 8 TON, (Inc. SILVERADO & AVALANCHE) 4.8L
- 2006-00 8 CHEVROLET C-(2WD), K-(4WD) PICKUP 1/2 TON, (Inc. SILVERADO & AVALANCHE) 5.3L
- 2000 8 CHEVROLET C-(2WD), K-(4WD) PICKUP 3/4 TON, (Inc. SILVERADO & AVALANCHE) 5.3L
- 2005-00 8 CHEVROLET SUBURBAN/TAHOE 4.8L
- 2005-00 8 CHEVROLET SUBURBAN/TAHOE 5.3L
- 2006-00 6 GMC C-(2WD), K-(4WD) PICKUP 1/2 TON, (Inc. SIERRA) 4.3L
- 2006-00 8 GMC C-(2WD), K-(4WD) PICKUP 1/2 TON, (Inc. SIERRA) 4.8L
- 2006-00 8 GMC C-(2WD), K-(4WD) PICKUP 1/2 TON, (Inc. SIERRA) 5.3L
- 2000 8 GMC C-(2WD), K-(4WD) PICKUP 3/4 TON, (Inc. SIERRA) 5.3L
- 2005-01 8 GMC SUBURBAN/YUKON 4.8L
- 2005-01 8 GMC SUBURBAN/YUKON 5.3L

645989

Inlet A: 2.50" I.D. PIPE
Outlet A: 2.50" O.D. PIPE
Length: 71"



- 1999-97 6 DODGE DAKOTA 3.9L
- 1999-97 8 DODGE DAKOTA 5.2L

645990

Inlet A: LOOSE 2-BOLT FLANGE W/ FEMALE FLARE
Inlet B: LOOSE 2-BOLT FLANGE W/ FEMALE FLARE
Outlet A: 2.50" O.D. PIPE
Length: 48.75"

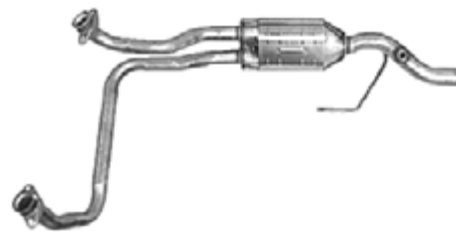

- 2003-98 6 DODGE B-VAN 3.9L
- 2003-98 8 DODGE B-VAN 5.2L
- 2003-98 8 DODGE B-VAN 5.9L

DIRECT FIT



645992

Inlet A: WELDED 3-BOLT FLANGE
 Inlet B: WELDED 3-BOLT FLANGE
 Outlet A: LOOSE 2-BOLT FLANGE W/ SPECIAL MALE BALL
 Length: 49.75"



1998-96 8 LAND ROVER DISCOVERY 4.0L

645993

Inlet A: WELDED 3-BOLT FLANGE
 Inlet B: WELDED 3-BOLT FLANGE
 Outlet A: LOOSE 2-BOLT FLANGE W/ SPECIAL MALE BALL
 Length: 50.25"



2002-99 8 LAND ROVER DISCOVERY 4.0L
 2004-03 8 LAND ROVER DISCOVERY 4.6L

645994

Inlet A: 2.50" I.D. PIPE
 Outlet A: 2.50" O.D. PIPE
 Length: 59.50"



1999-97 8 DODGE DAKOTA 5.2L
 1999-98 8 DODGE DAKOTA 5.9L

645995

Inlet A: 2.50" I.D. PIPE
 Outlet A: 2.50" O.D. PIPE
 Length: 48.25"



1999-98 8 DODGE DURANGO 5.2L
 1999-98 8 DODGE DURANGO 5.9L

645996

Inlet A: LOOSE 3-BOLT FLANGE W/ FLARE
 Outlet A: 3" O.D. PIPE
 Length: 61.75"



2000-96 8 CHEVROLET G -VAN 1 TON (Inc. Express Van) 5.7L
 2000-97 8 CHEVROLET G -VAN 1/2 & 3/4 TON (Inc. Express Van) 5.7L
 2000-96 8 GMC G -VAN 1 TON (Inc. Savana Van) 5.7L
 2000-97 8 GMC G -VAN 1/2 & 3/4 TON (Inc. Savana Van) 5.7L

645997

Inlet A: LOOSE 3-BOLT FLANGE W/ FLARE
 Outlet A: WELDED 3-BOLT FLANGE
 Length: 66.50"



2000-96 8 CHEVROLET G -VAN 1 TON (Inc. Express Van) 5.7L
 2000-97 8 CHEVROLET G -VAN 1/2 & 3/4 TON (Inc. Express Van) 5.7L
 2000-96 8 GMC G -VAN 1 TON (Inc. Savana Van) 5.7L
 2000-97 8 GMC G -VAN 1/2 & 3/4 TON (Inc. Savana Van) 5.7L

645998

Inlet A: LOOSE 3-BOLT FLANGE W/ FLARE
 Inlet B: LOOSE 3-BOLT FLANGE W/ FLARE
 Outlet A: WELDED 3-BOLT FLANGE
 Length: 50.88"



2000-96 8 CHEVROLET C-(2WD), K-(4WD) PICKUP 1 TON, (Inc. SILVERADO) 5.7L
 2000-96 8 CHEVROLET C-(2WD), K-(4WD) PICKUP 3/4 TON, (Inc. SILVERADO & AVALANCHE) 5.7L
 1999-96 8 CHEVROLET SUBURBAN/TAHOE 5.7L
 2000-96 8 GMC C-(2WD), K-(4WD) PICKUP 1 TON, (Inc. SIERRA) 5.7L
 2000-96 8 GMC C-(2WD), K-(4WD) PICKUP 3/4 TON, (Inc. SIERRA) 5.7L
 1999-96 8 GMC SUBURBAN/YUKON 5.7L

645999

Inlet A: WELDED 4-BOLT FLANGE
Outlet A: 2.085" O.D. PIPE
Length: 60"



2003-98 8 CADILLAC SEVILLE 4.6L

646301

Inlet A: 3" I.D. PIPE
Outlet A: 3" O.D. PIPE
Length: 30"



1995-87 8 FORD F-250 PICKUP 3/4 TON 5.8L
1995-87 8 FORD F-250 PICKUP 3/4 TON 7.5L
1997-88 8 FORD F-350 PICKUP 1 TON 5.8L
1997-88 8 FORD F-350 PICKUP 1 TON 7.5L

646302

Inlet A: WELDED 4-BOLT FLANGE W/ STUDS
Outlet A: 3" O.D. PIPE
Length: 29.25"



1997-87 8 FORD F-250 PICKUP 3/4 TON 5.8L
1997-87 8 FORD F-250 PICKUP 3/4 TON 7.5L
1997-88 8 FORD F-350 PICKUP 1 TON 5.8L
1997-88 8 FORD F-350 PICKUP 1 TON 7.5L
1995-94 8 FORD F-450 PICKUP 1-1/2 TON 7.5L

646303

Inlet A: WELDED 4-BOLT FLANGE W/ STUDS
Outlet A: 2.50" O.D. PIPE
Length: 29.25"



1993-87 8 FORD E-250 VAN 3/4 TON 7.5L
1995-88 8 FORD E-250 VAN 3/4 TON 5.8L
1989-88 8 FORD E-350 VAN 1 TON 5.8L
1995-87 8 FORD E-350 VAN 1 TON 7.5L

646303 (cont.)

1997-87 8 FORD F-250 PICKUP 3/4 TON 5.8L
1997-87 8 FORD F-250 PICKUP 3/4 TON 7.5L
1998 8 FORD F-250 PICKUP 3/4 TON 5.4L
1997-87 8 FORD F-350 PICKUP 1 TON 5.8L
1997-87 8 FORD F-350 PICKUP 1 TON 7.5L
1993-90 8 FORD F-450 PICKUP 1-1/2 TON 7.5L

646304

Inlet A: 3" I.D. PIPE
Outlet A: 3" O.D. PIPE
Length: 26"



1995-88 8 CHEVROLET C-(2WD), K-(4WD) PICKUP 1 TON, (Inc. SILVERADO) All
1993-88 8 CHEVROLET C-(2WD), K-(4WD) PICKUP 3/4 TON, (Inc. SILVERADO & AVALANCHE) 5.7L
1995-91 8 CHEVROLET C-(2WD), K-(4WD) PICKUP 3/4 TON, (Inc. SILVERADO & AVALANCHE) 7.4L
1991-87 8 CHEVROLET G -VAN 1 TON (Inc. Express Van) 5.7L
1994-92 8 CHEVROLET G -VAN 1 TON (Inc. Express Van) All
1994-87 8 CHEVROLET G -VAN 1/2 & 3/4 TON (Inc. Express Van) 5.7L
1989-87 8 CHEVROLET R-(2WD), V-(4WD) PICKUP 7.4L
1993-88 8 CHEVROLET SUBURBAN/TAHOE 5.7L
1995-87 8 CHEVROLET SUBURBAN/TAHOE 7.4L
1995-88 8 GMC C-(2WD), K-(4WD) PICKUP 1 TON, (Inc. SIERRA) All
1993-88 8 GMC C-(2WD), K-(4WD) PICKUP 3/4 TON, (Inc. SIERRA) 5.7L
1995-91 8 GMC C-(2WD), K-(4WD) PICKUP 3/4 TON, (Inc. SIERRA) 7.4L
1991-87 8 GMC G -VAN 1 TON (Inc. Savana Van) 5.7L
1994-92 8 GMC G -VAN 1 TON (Inc. Savana Van) All
1994-87 8 GMC G -VAN 1/2 & 3/4 TON (Inc. Savana Van) 5.7L
1993-88 8 GMC SUBURBAN/YUKON 5.7L
1995-87 8 GMC SUBURBAN/YUKON 7.4L

646306

Inlet A: 2.25" I.D. PIPE
Outlet A: 2.25" O.D. PIPE
Length: 24"

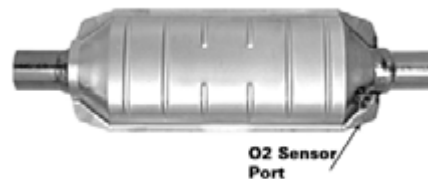

1996-94 8 DODGE RAM (2WD & 4WD) PICKUP 1 TON 5.9L

DIRECT FIT



646307

Inlet A: 3" I.D. PIPE
 Outlet A: 3" O.D. PIPE
 Length: 24"

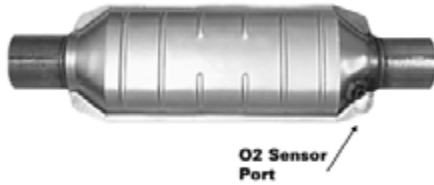

1996-95 10 DODGE RAM (2WD & 4WD) PICKUP 1 TON 8.0L

646312

Inlet A: WELDED 3-BOLT FLANGE
 Outlet A: 3" O.D. PIPE
 Length: 35.25"



1999 10 FORD F-350 PICKUP 1 TON 6.8L
 1999 10 FORD F-450 PICKUP 1-1/2 TON 6.8L

646309

Inlet A: 2.25" I.D. PIPE
 Outlet A: 2.25" O.D. PIPE
 Length: 23.25"



2002-94 10 DODGE RAM (2WD & 4WD) PICKUP 1 TON 8.0L
 2002-94 10 DODGE RAM (2WD & 4WD) PICKUP 1/2 & 3/4 TON 8.0L

646313

Inlet A: WELDED 3-BOLT FLANGE
 Outlet A: 3" O.D. PIPE
 Length: 35.25"



2000-97 10 FORD E-350 VAN 1 TON 6.8L

646310

Inlet A: WELDED 3-BOLT FLANGE
 Outlet A: 3" O.D. PIPE
 Length: 31.25"



2000-98 8 BLUE BIRD BUS CV200 7.4L
 2000-98 8 GMC B7 CONVENTIONAL CHASSIS 7.4L

646315

Inlet A: WELDED 3-BOLT FLANGE
 Outlet A: 3" O.D. PIPE
 Length: 45.75"



2007-06 10 FORD E-350 VAN 1 TON 6.8L
 2007-06 10 FORD E-450 VAN 6.8L

646311

Inlet A: WELDED 3-BOLT FLANGE
 Outlet A: 3" O.D. PIPE
 Length: 35.25"



2000-97 10 FORD E-350 VAN 1 TON 6.8L

646316

Inlet A: WELDED 3-BOLT FLANGE
 Outlet A: 3" O.D. PIPE
 Length: 38"



2004-02 8 FORD E-150 VAN 1/2 TON 5.4L
 2004-02 8 FORD E-250 VAN 3/4 TON 5.4L

646317

Inlet A: 3" I.D. PIPE
Outlet A: 3" O.D. PIPE
Length: 47"



2007-04 10 FORD E-450 VAN 6.8L

646318

Inlet A: 3" I.D. PIPE
Outlet A: 3" O.D. PIPE
Length: 39.50"



2000-97 10 FORD E-350 VAN 1 TON 6.8L

646319

Inlet A: WELDED 3-BOLT FLANGE
Outlet A: 3" O.D. PIPE
Length: 35"



1999 10 FORD F-250 PICKUP 3/4 TON 6.8L
1999 8 FORD F-250 PICKUP 3/4 TON 5.4L
1999 10 FORD F-350 PICKUP 1 TON 6.8L
1999 10 FORD F-450 PICKUP 1-1/2 TON 6.8L

646320

Inlet A: WELDED 4-BOLT FLANGE
Outlet A: 3" O.D. PIPE
Length: 32.25"



2007-05 10 FORD F-250 PICKUP 3/4 TON 6.8L
2007-05 8 FORD F-250 PICKUP 3/4 TON 5.4L
2007-05 10 FORD F-350 PICKUP 1 TON 6.8L
2007-05 8 FORD F-350 PICKUP 1 TON 5.4L
2007-05 10 FORD F-450 PICKUP 1-1/2 TON 6.8L
2007-05 10 FORD F-550 SUPER DUTY 6.8L

646321

Inlet A: WELDED 3-BOLT FLANGE
Outlet A: 3" O.D. PIPE
Length: 34.75"



2008-07 10 FORD E-350 VAN 1 TON 6.8L
2008-07 8 FORD E-350 VAN 1 TON 5.4L
2008 10 FORD E-450 VAN 6.8L
2008 8 FORD E-450 VAN 5.4L

646322

Inlet A: 3" I.D. PIPE
Outlet A: 2.88" I.D. PIPE
Length: 46.75"



2006-00 10 FORD E-450 VAN 6.8L
2006-00 8 FORD E-450 VAN 5.4L
2003 10 FORD E-550 SUPER DUTY 6.8L

646323

Inlet A: WELDED 4-BOLT FLANGE
Outlet A: 3" O.D. PIPE
Length: 30"



2007-05 10 FORD F-250 PICKUP 3/4 TON 6.8L
2007-05 8 FORD F-250 PICKUP 3/4 TON 5.4L
2007-05 10 FORD F-350 PICKUP 1 TON 6.8L
2007-05 8 FORD F-350 PICKUP 1 TON 5.4L
2007-05 10 FORD F-450 PICKUP 1-1/2 TON 6.8L
2007-05 10 FORD F-550 SUPER DUTY 6.8L

DIRECT FIT



646900

Inlet A: LOOSE 2-BOLT FLANGE W/ 2.25" FEMALE FLARE
 Inlet B: LOOSE 2-BOLT FLANGE W/ 2.50" FEMALE FLARE
 Outlet A: 2.50" O.D. PIPE
 Length: 63.25"

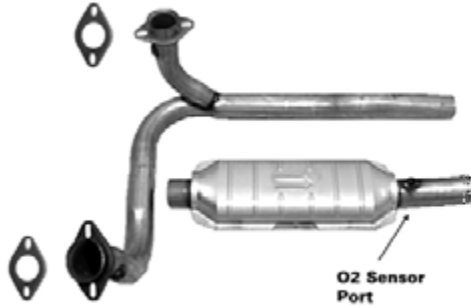

- 1996 8 FORD E-250 VAN 3/4 TON 5.8L
- 1996 8 FORD E-350 VAN 1 TON 5.8L

646901

Inlet A: WELDED 3-BOLT FLANGE W/ STUDS
 Outlet A: 3" O.D. PIPE
 Length: 38.25"



- 1999-97 8 FORD E-250 VAN 3/4 TON 5.4L
- 1998-97 10 FORD E-350 VAN 1 TON 6.8L
- 1998-97 8 FORD E-350 VAN 1 TON 5.4L
- 1999 8 FORD F-250 PICKUP 3/4 TON 5.4L
- 1999 10 FORD F-350 PICKUP 1 TON 6.8L

646902

Inlet A: WELDED 3-BOLT FLANGE
 Outlet A: 3" O.D. PIPE
 Length: 56.50"



- 2002-00 10 FORD EXCURSION 6.8L
- 2002-00 8 FORD EXCURSION 5.4L
- 2003-00 8 FORD F-250 PICKUP 3/4 TON 5.4L
- 2003-99 10 FORD F-250 PICKUP 3/4 TON 6.8L
- 2003-99 10 FORD F-350 PICKUP 1 TON 6.8L
- 2003-99 8 FORD F-350 PICKUP 1 TON 5.4L

646903

Inlet A: WELDED 3-BOLT FLANGE
 Outlet A: 3" O.D. PIPE
 Length: 56"



- 2004 8 FORD F-350 PICKUP 1 TON 5.4L

OXYGEN SENSOR ACCESSORIES

4961

18 mm Male O2 Sensor Plug
10 per box



4752

12 mm Female O2 Sensor Boss
10 per box



4962

18 mm Female O2 Sensor Boss
10 per box



4753

**Toyota, Lexus, GEO, Mitsubishi,
Subaru, Chrysler Imports:
2 Bolt O2 sensor Boss**
10 per box



4751

**18 mm Female O2 Sensor Boss,
45 Deg. cut**
10 per box



**For O2 sensor gaskets,
see page 481 for #9224, 9242
and
page 482 for #9291, 9299.**

AIR TUBE REPLACEMENTS

4948

UNIVERSAL AIR TUBE KIT - SINGLE

Fits 1/2" & 3/4" Air Tubes
Allows for easy connection from OEM air tube to
aftermarket converter.

INCLUDES: 12" of 3/4" High Temp. Hose,
(2) Hose Clamps, (2) High Temp.
Thermo Plastic Hose Size Adapters.



4949

UNIVERSAL AIR TUBE KIT - (6) PER/BOX

ACCESSORIES



HIGH TEMP - REPLACEMENT HOSE

HIGH TEMP HOSES-FOR USE IN AIR INJECTION SYSTEM REPAIRS.



1/2" I.D. DIAMETER

4754 - 12" Length

4937 - Bulk 10' Length

5/8" I.D. DIAMETER

4756 - 12" Length

4757 - Bulk 10' Length

3/4" I.D. DIAMETER

4758 - 12" Length

4938 - Bulk 10' Length

CLAMPS

STANDARD DUTY 5/16" U-BOLT



P/N	SIZE	BOX QTY
U118	1 1/8"	1
U114	1 1/4"	1
U112	1 1/2"	1
U158	1 5/8"	1
U134	1 3/4"	1
U178	1 7/8"	1
U200	2"	1
U218	2 1/8"	1
U214	2 1/4"	1
U212	2 1/2"	1

STANDARD DUTY 5/16" U-BOLT W/ FLANGE NUT



P/N	SIZE	BOX QTY
339976	1 1/2"	50
339977	1 5/8"	50
339978	1 3/4"	50
339979	1 7/8"	50
339980	2"	50
339981	2 1/8"	50
339982	2 1/4"	50
339983	2 1/2"	50

SLOTTED HD 3/8" U-BOLT W/ FLANGE NUT



P/N	SIZE	BOX QTY
339893	1 1/2"	100
339892	1 3/4"	100
339891	1 7/8"	100
339890	2"	100
339889	2 1/4"	100
339888	2 1/2"	100

DGM STYLE 3/8" U-BOLT W/ FLANGE NUT



P/N	SIZE	BOX QTY	P/N	SIZE	BOX QTY
M112	1 1/2"	1	339862	1 1/2"	100
M158	1 5/8"	1			
M134	1 3/4"	1	339880	1 3/4"	100
M178	1 7/8"	1	339879	1 7/8"	100
M200	2"	1	339878	2"	100
M218	2 1/8"	1	339877	2 1/8"	100
M214	2 1/4"	1	339876	2 1/4"	100
M212	2 1/2"	1	339875	2 1/2"	100
M258	2 5/8"	1			
M300	3"	1	9972	3"	50

CLAMPS - (Cont.)

HEAVY DUTY 3/8" U-BOLT TRUCK CLAMPS



P/N	P/N ZINC	SIZE	BOX QTY
H234P	—	2 3/4"	1
H300P	H300PZ	3"	1
H312P	H312PZ	3 1/2"	1
H400P	H400PZ	4"	1
H412P	H412PZ	4 1/2"	1
H500P	H500PZ	5"	1

EXTRA HEAVY DUTY CLAMPS 3/8" U-BOLT 11 GAUGE SADDLE



P/N	P/N ZINC	SIZE	BOX QTY	P/N	P/N ZINC	SIZE	BOX QTY
H200	—	2"	1	H300*	H300Z	3"	1
H218	—	2 1/8"	1	H314*	—	3 1/4"	1
H214	—	2 1/4"	1	H312*	—	3 1/2"	1
H238	—	2 3/8"	1	H400*	H400Z	4"	1
H212	—	2 1/2"	1	H412*	—	4 1/2"	1
H258*	—	2 5/8"	1	H500*	H500Z	5"	1
H234*	—	2 3/4"	1	H600*	H600Z	6"	1

*Welded Saddle

STAINLESS STEEL 3/8" U-BOLT



P/N	SIZE	BOX QTY
SS112	1 1/2"	1
SS134	1 3/4"	1
SS178	1 7/8"	1
SS200	2"	1
SS214	2 1/4"	1
SS212	2 1/2"	1
SS300	3"	1

FLAT BAND CLAMPS



P/N ZINC	P/N CHROME	SIZE	BOX QTY
9501	9490	3"	1
9502	—	3 1/2"	1
9503	9492	4"	1
9504	9493	5"	1
9736	—	5 1/2"	1
9506	9495	6"	1

HEAVY DUTY GUILLOTINE CLAMPS



P/N	P/N ZINC	P/N CHROME	SIZE	BOX QTY
T234	—	—	2 3/4"	1
T300	T300Z	—	3"	1
T314	—	—	3 1/4"	1
T312	T312Z	—	3 1/2"	1
T400	T400Z	9486	4"	1
—	T412Z	—	4 1/2"	1
T500	T500Z	9487	5"	1
—	T512Z	—	5 1/2"	1
T600	T600Z	9734	6"	1

AIR TUBE SADDLE CLAMPS



P/N	SIZE	BOX QTY
4904	1/2"	25
4914	5/8"	25
4907	3/4"	25
4925	1"	25

ACCESSORIES



FLEX COUPLING

- Complete Coverage
- Constructed with 2-Ply Bellows
- Designed with a Seamless, Convolved Inner Core to Prevent Exhaust Leaks
- Increased Flexibility Reduces Vibrations
- Available with or without Expandable Nipple Extensions
- Available with Inner Braid



WITHOUT NIPPLE EXTENSION

P/N W/O INNER LINER	P/N WITH INNER BRAID	FLEX LENGTH	OVERALL LENGTH	INLET DIAMETER
8810	8810IB	4"	4"	1.77"
8811	8811IB	6"	6"	1.77"
8812	8812IB	8"	8"	1.77"
8813	8813IB	10"	10"	1.77"
8814	8814IB	4"	4"	2.02"
8815	8815IB	6"	6"	2.02"
8816	8816IB	8"	8"	2.02"
8817	8817IB	10"	10"	2.02"
8818	8818IB	4"	4"	2.27"
8819	8819IB	6"	6"	2.27"
8820	8820IB	8"	8"	2.27"
8821	8821IB	10"	10"	2.27"
8822	8822IB	4"	4"	2.52"
8823	8823IB	6"	6"	2.52"
8824	8824IB	8"	8"	2.52"
8825	8825IB	10"	10"	2.52"
8826	8826IB	4"	4"	3.02"
8827	8827IB	6"	6"	3.02"
8828	8828IB	8"	8"	3.02"
8829	8829IB	10"	10"	3.02"

WITH NIPPLE EXTENSION

P/N W/O INNER LINER	P/N WITH INNER BRAID	FLEX LENGTH	OVERALL LENGTH	INLET DIAMETER
8835	8835IB	4"	8"	1.75"
8836	8836IB	6"	10"	1.75"
8837	8837IB	8"	12"	1.75"
8838	8838IB	10"	14"	1.75"
8839	8839IB	4"	8"	2.00"
8840	8840IB	6"	10"	2.00"
8841	8841IB	8"	12"	2.00"
8842	8842IB	10"	14"	2.00"
8843	8843IB	4"	8"	2.25"
8844	8844IB	6"	10"	2.25"
8845	8845IB	8"	12"	2.25"
8846	8846IB	10"	14"	2.25"
8847	8847IB	4"	8"	2.50"
8848	8848IB	6"	10"	2.50"
8849	8849IB	8"	12"	2.50"
8850	8850IB	10"	14"	2.50"
8851	8851IB	4"	8"	3.00"
8852	8852IB	6"	10"	3.00"
8853	8853IB	8"	12"	3.00"
8854	8854IB	10"	14"	3.00"

MANIFOLD SHOULDER BOLTS & SPRINGS

 <p>4678 Acura/Chrysler/ Honda/Subaru</p>	 <p>4682 Acura/Honda (2 each per kit)</p>	 <p>4975 Chrysler</p>	 <p>4973 Ford/Mazda</p>	 <p>4971S (Single) GM/Ford/Mazda 4971 (10/box)</p>	 <p>4976 GM/Chrysler</p>
---	---	---	--	---	--

MANIFOLD SHOULDER BOLTS & SPRINGS - (Cont.)



4680
GM/Geo/Suzuki/Toyota



4970
GM/Subaru



4972
GM



4974
GM



8037
GM



8038
GM



8039
Subaru



4978
Toyota



4979
Toyota



F5309
Universal Spring
(10 per box)

JOINT CONNECTOR



P/N	DESCRIPTION
8802	Fits 1 3/4" and 2" pipes Gasket included. Stainless Steel

CLAMP-A-STUD



P/N	SIZE	BOX QTY
8028	1/4" - 1 3/4"	1
8027	1 1/4" - 2 1/4"	1
8026	2 1/4" - 3 1/4"	1

ACCESSORIES



The HUSH Studfix

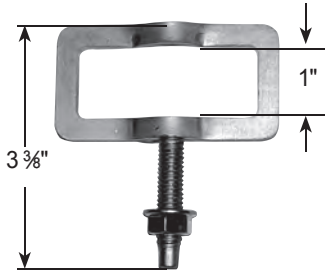

8001 - Pkg. Qty. 2
Ford Trucks

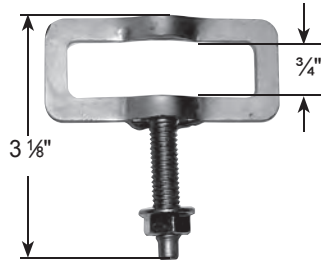

8002 - Pkg. Qty. 2
Ford Cars

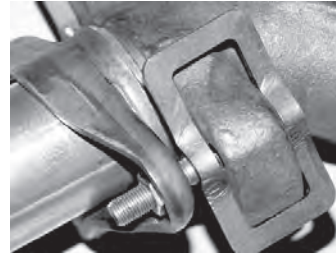

The HUSH Studfix installed

SPLIT FLANGES & MISC.

SPLIT CONVERTER FLANGES

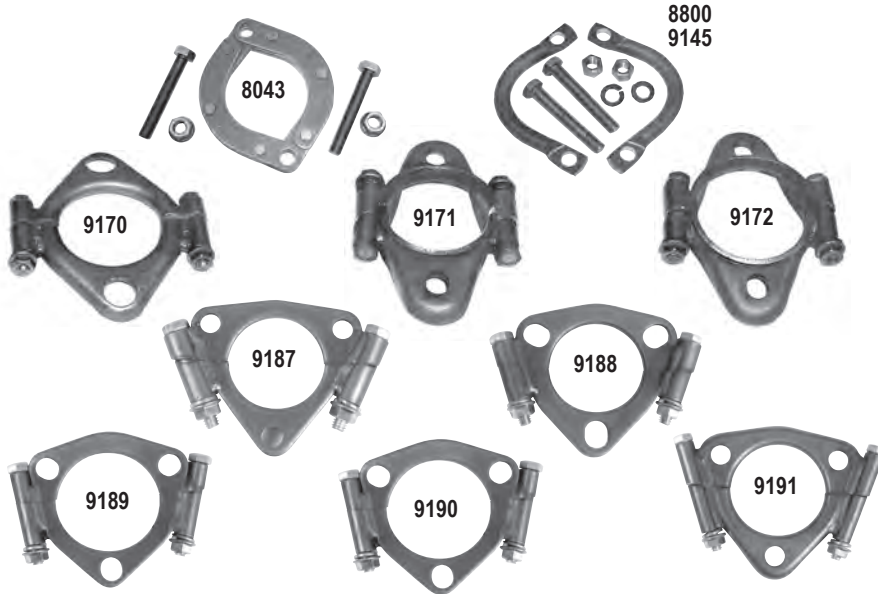

P/N	SIZE	BOX QTY
9145	1 3/4" - 2"	1
9187	1 7/8"	1
8043	2" - 2 1/4"	1
9171	2 3/32"	1
9188	2 1/8"	1
8800	2 1/4" - 2 1/2"	1
9170	2 5/16"	1
9172	2 7/16"	1
9191	2 7/16"	1
9189	2 1/2"	1
9190	2 5/8"	1

SPLIT FLANGES Individually Boxed

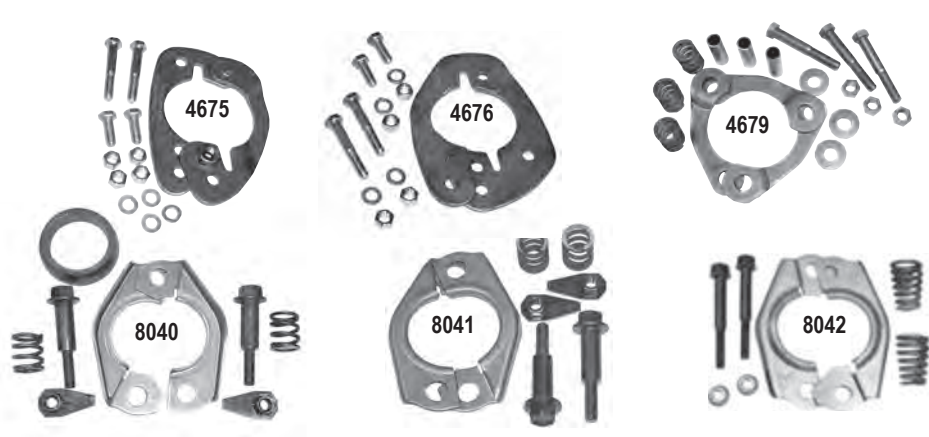

P/N	TYPE
4675	GM
4676	Universal
4679	GM
8040	Ford
8041	Ford
8042	Chrysler

UNIVERSAL & SPECIAL APPLICATION FLANGES

3-HOLE UNIVERSAL FLANGE



P/N	SIZE	BOX QTY
9152	2"	10
9152S	2"	1
8032	2 5/8"	1
8033	3 1/16"	1

2-HOLE UNIVERSAL FLANGE



P/N	SIZE	BOX QTY
9153	1 3/4"	10
9153S	1 3/4"	1
8036	1 3/4"	1

Note: 9153, 9153S - 5/16" thick
8036 - 3/8" thick

2-HOLE UNIVERSAL FLANGE



P/N	SIZE	BOX QTY
9154	2 1/8"	10
9154S	2 1/8"	1

2-HOLE UNIVERSAL FLANGE



P/N	SIZE	BOX QTY
9155	2 5/16"	10
9155S	2 5/16"	1
8035	2 3/8"	1

2-HOLE UNIVERSAL FLANGE



P/N	SIZE	BOX QTY
9156	2 9/16"	10
9156S	2 9/16"	1

3-HOLE UNIVERSAL FLANGE



P/N	SIZE	BOX QTY
9158	2 5/16"	10
9158S	2 5/16"	1

4-HOLE GM FLANGE



P/N	SIZE	BOX QTY
9160	2 1/4"	10
9160S	2 1/4"	1

4-HOLE GM FLANGE



P/N	SIZE	BOX QTY
9161	2"	10
9161S	2"	1

OEM STYLE FLANGE - FORD



P/N	SIZE	BOX QTY
8029	2 9/16"	1

OEM STYLE FLANGE - FORD



P/N	SIZE	BOX QTY
8030	2 1/16"	1

OEM STYLE FLANGE - FORD



P/N	SIZE	BOX QTY
8031	2 5/16"	1

EXHAUST PIPE FLANGE CHARTS

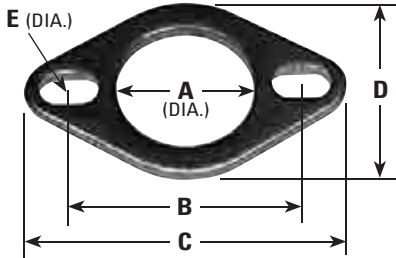

P/N	A	B	C	D	E
8035	2 3/8"	3 7/8"	5 1/4"	3 1/2"	1/2" x 7/8" slot
8036	1 3/4"	3 1/2"	4 3/4"	3"	1/2" x 3/4" slot
8788	2"	3"	4"	2 3/4"	1/2"
8793	2 1/8"	3 1/8"	3 7/8"	3"	7/16"
9153#	1 3/4"	3 1/2"	4 3/4"	3"	1/2" x 3/4" slot
9153S	1 3/4"	3 1/2"	4 3/4"	3"	1/2" x 3/4" slot
9154#	2 1/8"	3 1/2"	4 3/4"	3"	1/2" x 3/4" slot
9154S	2 1/8"	3 1/2"	4 3/4"	3"	1/2" x 3/4" slot
9155#	2 5/16"	3 7/8"	5 1/4"	3 1/2"	1/2" x 7/8" slot
9155S	2 5/16"	3 7/8"	5 1/4"	3 1/2"	1/2" x 7/8" slot
9156#	2 9/16"	3 7/8"	5 1/4"	3 1/2"	1/2" x 7/8" slot
9156S	2 9/16"	3 7/8"	5 1/4"	3 1/2"	1/2" x 7/8" slot
9175	1 7/8"	3 1/16"	4 1/4"	2 3/4"	9/16" x 1 1/16" slot
9176	2 1/16"	3 1/16"	4 1/4"	2 3/4"	9/16" x 1 1/16" slot
9179	2 1/16"	3 1/2"	4 7/8"	3 1/16"	7/16" x 7/8" slot
9181	2"	3 1/2"	4 3/4"	3"	1/2" x 3/4" slot
9184	2 1/16"	3"	4"	2 3/4"	1/2"
9185	2 1/4"	3 7/16"	4 1/2"	3"	1/2"

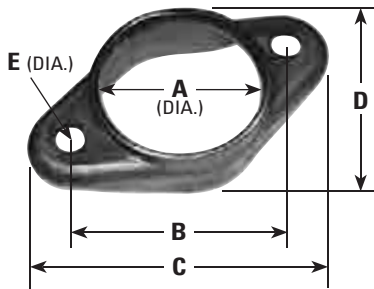

P/N	A	B	C	D	E
8776	2 1/8"	3 1/8"	4 1/2"	3 1/4"	7/16"
8777	2 7/16"	3 5/8"	5"	2 7/8"	7/16" x 9/16" slot
8786	2 7/16"	3 3/4"	5 1/8"	2 15/16"	7/16"
8792	2 1 1/16"	3 3/4"	5 1/4"	2 7/8"	7/16"
8796	2 1/4"	3 9/16"	5"	2 3/4"	3/8" x 7/16" slot
8798	2 1/8"	3 3/4"	5 1/8"	2 3/8"	7/16"
9569	2 3 1/32"	4 3/32"	5 1/2"	3 1/2"	7/16"
9147	2 5/16"	4"	5 3/8"	3 3/8"	1 3/16"
9150	2 1/8"	3 5/8"	4 3/4"	2 9/16"	7/16" x 9/16" slot
9162	2 5/8"	4 3/4"	6 1/8"	3"	7/16"
9166	3 1/12"	4 1/4"	6 5/64"	3 9/16"	7/16"
9167	2 1/2"	4"	5 3/8"	3 3/8"	3/4"

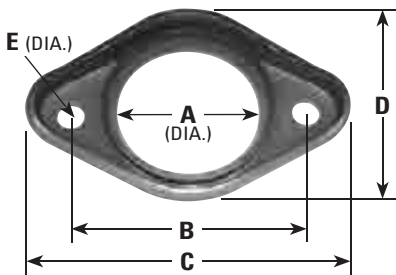

P/N	A	B	C	D	E
8789	2 1/16"	3 1/8"	4 1/8"	3 1/4"	1/2"
9140	2 1/4"	4"	5 7/16"	3 3/8"	7/16"
9164	2 9/16"	3 15/16"	5 1/8"	3 7/16"	23/32"

EXHAUST PIPE FLANGE CHARTS

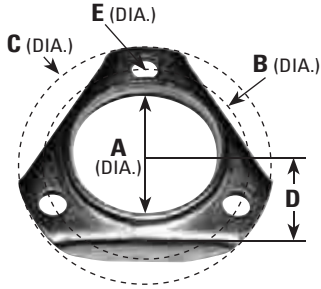

P/N	A	B	C	D	E
8780	2 1/8"	3 1/8"	3 7/8"	1 7/16"	7/16"

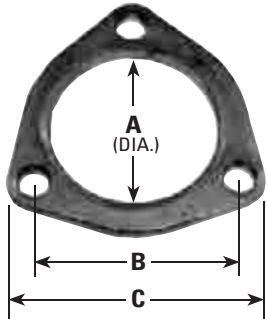

P/N	A	B	C
8032	2 5/8"	3 3/16"	3 7/8"
8033	3 1/16"	3 5/16"	4 1/8"
8034	2 5/8"	3 1/16"	3 7/8"
8799	2 7/16"	2 13/16"	3 5/8"
9152#	2"	2 11/16"	3 3/4"
9152S	2"	2 11/16"	3 3/4"
9158#	2 5/16"	2 11/16"	3 15/16"
9158S	2 5/16"	2 11/16"	3 15/16"
9173	2 1/2"	3 1/8"	3 15/16"
9177	2 7/8"	2 11/16"	3 5/8" (rad.)
9178	2 5/8"	3 1/16"	3 7/8"
9180	3 1/16"	3 5/16"	4 1/8"

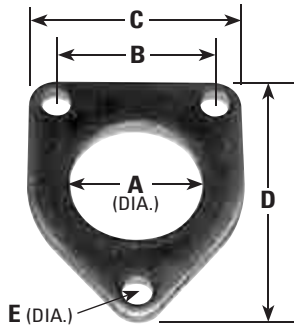

P/N	A	B	C	D	E
9174	2"	2 7/16"	3 3/8"	4 3/16"	7/16"

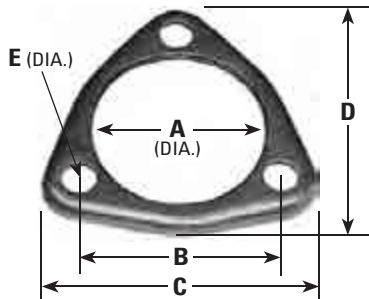

P/N	A	B	C	D	E
8775	2 5/16"	2 7/8"	4 5/16" (rad.)	4 1/2" (rad.)	7/16"
8787	2 11/16"	3 1/8"	4 5/16" (rad.)	4 1/8" (rad.)	1/2"
9146	2 5/8"	3 1/2"	4 33/64" (rad.)	4 19/64" (rad.)	27/64"

EXHAUST PIPE FLANGE CHARTS

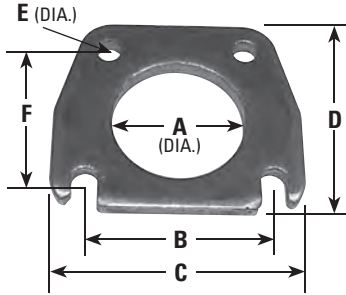

P/N	A	B	C	D	E	F
9160#	2 1/4"	2 3/8"/3 3/16"	4 5/16"	3 5/8"	7/16"	2 9/16"
9160S	2 1/4"	2 3/8"/3 3/16"	4 5/16"	3 5/8"	7/16"	2 9/16"
9161#	2"	2 3/8"/3 3/16"	4 1/4"	3 21/32"	7/16"	2 9/16"
9161S	2"	2 3/8"/3 3/16"	4 1/4"	3 21/32"	7/16"	2 9/16"

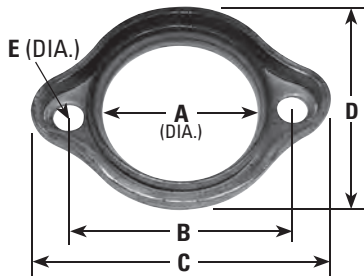

P/N	A	B	C	D	E
8029	2 9/16"	3 3/4"	4 15/16"	3 9/16"	1/2"
8030	2 1/16"	3 1/2"	4 5/8"	3 3/8"	1/2"
8031	2 5/16"	3 13/16"	4 15/16"	3 9/16"	1/2"
8778	2 7/16"	4 1/16"	4 1/2"	3 9/16"	9/16"
8781	2 1/8"	3 1/8"	4 1/4"	3 1/4"	7/16"
9159	2 1/8"	3 1/2"	4 3/4"	3"	1/2 x 3/4" slot

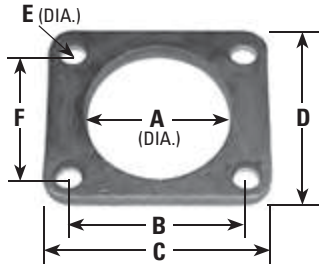

P/N	A	B	C	D	E	F
9143	2 9/16"	2 13/16"	3 9/16"	3 1/4"	3/8"	2 7/16"
9586	4 1/8"	4 3/16"	6"	6"	5/8"	4 3/16"

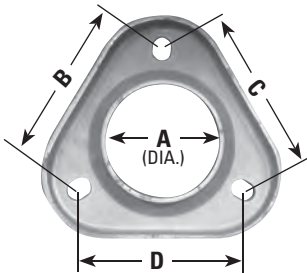

P/N	A	B	C	D
9149	2 9/16"	3 11/16"	3 11/16"	3 13/16"

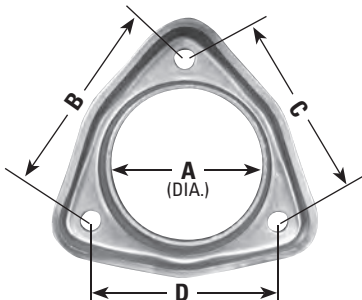

P/N	A	B	C	D
9165	2 27/32"	3 11/16"	3 5/8"	3 13/16"

EXHAUST GASKET CHARTS

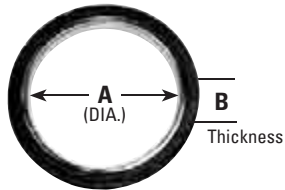

GASKET NO.	A	B
8421	3 3/32"	3/16"
8449	3 13/32"	7/32"
8470	2 13/16"	5/32"
8690	1 3/4"	3/16"
8731°	2"	1/16"
8733	1 15/16"	5/32"
8737	2 5/32"	3/16"
8749	1 13/16"	3/16"
8764°	5 9/64"	3/16"
8770	1 9/16"	3/16"
9016	2 3/8"	3/16"
9024	1 31/32"	3/16"
9026	2 19/32"	3/16"
9027	2 3/16"	1/8"
9066	1 7/8"	3/16"
9100	2 1/16"	1/16"
9207	2 31/32"	3/16"
9218°	2 3/4"	3/16"
9233	2 1/32"	15/32"
9282	2 3/8"	3/16"

° Metal with Fiber Core

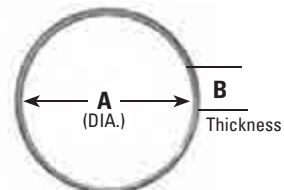

GASKET NO.	A	B
8424	2 7/16"	5/32"
8437	4 7/32"	1/8"
8457	2 29/32"	11/64"
8467	2 9/16"	5/32"
8469	3 3/16"	5/32"
8693	2"	3/16"
8702	2 9/32"	3/16"
8762	2 13/16"	5/32"
9044	2 13/32"	7/32"
9059	2 5/8"	3/16"
9061	2"	1/8"
9080	2 3/32"	5/32"
9252	1 13/16"	3/16"
9267	1 7/8"	3/16"
9268	2 7/32"	5/32"

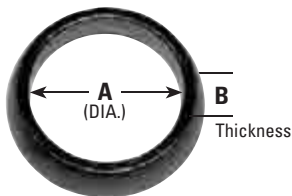

GASKET NO.	A	B
8406	2 9/16"	11/16"
8410	1 1/2"	1/2"
8411	2 3/8"	37/64"
8415	2 3/8"	11/16"
8423	2 3/16"	11/16"
8425	2 31/32"	45/64"
8427	2 9/32"	1/2"
8434	1 29/32"	3/8"
8443	1 31/32"	9/16"

GASKET NO.	A	B
8458	1 55/64"	15/32"
8460	2 27/32"	1/2"
8473	2 17/32"	9/16"
8482	1 25/32"	21/32"
8489	1 15/16"	7/16"
8490	2 13/32"	27/64"
8706 ¹	1 25/32"	1/2"
9002	2 3/16"	5/8"
9003 ²	2 1/32"	19/32"
9019	2 1/8"	5/8"
9056 ²	2 1/8"	1/2"
9082 ¹	2 13/16"	19/32"
9084 ²	2 1/8"	3/4"
9087 ¹	2"	1/2"
9090 ¹	2"	5/8"

GASKET NO.	A	B
9094 ¹	1 3/4"	9/16"
9095 ¹	2 5/16"	5/8"
9215	1 29/32"	21/32"
9216	2 3/8"	5/8"
9221 ¹	2 1/4"	1/2"
9225 ³	2 5/16"	11/16"
9231 ³	2"	9/16"
9236 ¹	1 11/16"	5/8"
9240 ¹	1 11/16"	1/2"
9248 ³	2 1/2"	15/32"
9257	2 5/32"	21/32"
9264 ¹	2 1/16"	5/8"
9290 ¹	1 29/32"	5/8"

¹ Graphoil Material
² Sintered Iron Material
³ Metal Mesh Material

EXHAUST GASKET CHARTS

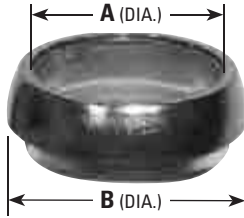

GASKET NO.	A	B
8408	2 5/16"	3 1/8"
8418	2 17/32"	3 7/16"
8444	2 5/16"	3"
8698 ²	2 1/8"	2"
8699 ²	2 1/8"	2"
8763	2 1/8"	2 1/8"
8769	1 29/32"	1 7/8"
9051	2 3/8"	2 5/8"
9052	2 1/8"	2 3/8"
9091 ¹	1 11/16"	1 7/8"
9093 ³	1 15/16"	2 1/4"
9212	1 27/32"	2"
9220 ³	1 3/4"	2"
9234	2 1/16"	2 13/32"
9259	2"	2 1/2"
9260	2 3/8"	3 3/16"
9261	2 1/4"	2 1/2"
9272	2 1/8"	2 1/2"

- ¹ Graphoil Material
- ² Sintered Iron Material
- ³ Metal Mesh Material

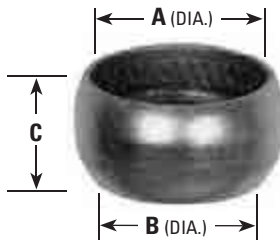

GASKET NO.	A	B	C
8435	2 1/2"	2"	1 1/4"
9292	2"	1 5/8"	3/8"

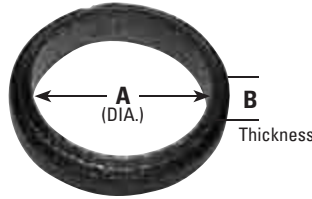

GASKET NO.	A	B
8420 ²	2 1/4"	9/16"
8440	1 13/32"	5/8"
8715	1 7/8"	5/8"
8717	2 1/32"	5/8"
8738	2 1/2"	5/8"
8740 ²	1 13/16"	9/16"
8744	2 1/8"	3/4"
8766 ^{2,3}	2 1/8"	3/4"
8767 ³	2 3/8"	7/8"
8773	2 1/4"	5/8"
9001	1 7/8"	9/16"
9004	1 25/32"	5/8"
9005	1 31/32"	9/16"
9007	2 1/32"	3/4"
9008	1 15/16"	9/16"
9017 ^{2,3}	2 9/32"	15/32"
9038 ^{3,4}	1 3/4"	3/8"
9055	1 3/4"	5/8"
9057 ^{3,4}	1 5/8"	3/8"
9083 ^{3,4}	2"	1/2"
9086 ²	2 7/32"	5/8"
9118	2 9/16"	1/2"
9217 ^{2,3}	2 13/32"	13/16"
9295	1 13/16"	3/8"
9743 ²	2 3/4"	5/8"

- ² Sintered Iron Material
- ³ For Spherical Flare Use
- ⁴ Formed Metal Material

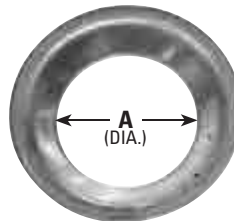

GASKET NO.	A
9244♦	1 9/16"

♦ Copper

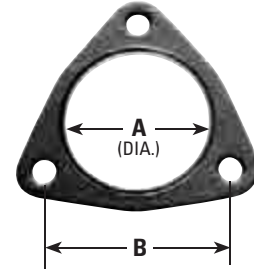

GASKET NO.	A	B
8403	3 9/32"	4 15/32"
8441	2 3/8"	2 3/4"
8442	3 5/32"	3 3/8"
8681	2 5/8"	3 3/16"
8691	2 7/16"	3 9/32"
8705+	2 1/16"	2 15/16"
8710	2 3/32"	2 3/4"
8711	2 9/16"	3"
8720	2 3/32"	2 3/4"
8730	2 11/32"	2 13/16"
8739	1 13/16"	2 5/8"
9000	2 3/16"	3 1/2"
9010	2"	2 33/64"
9018	2 19/32"	3 1/2"
9028	1 13/16"	2 3/8"
9030	1 7/8"	2 5/8"
9031	2 1/4"	2 7/8"
9039	2 13/16"	3 1/4"
9040	2 13/16"	3 5/16"
9042	2 31/32"	3 1/8"
9068	2 1/8"	3 1/8"
9214	1 13/16"	3 29/32"
9278	2 5/32"	2 15/16"
9280	3 1/16"	4 7/16"
9283	2 5/16"	3 1/8"
9287	2 13/16"	4 5/16"

+ Slotted Bolt Hole

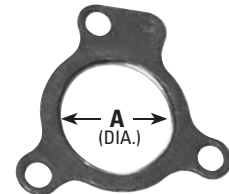

GASKET NO.	A
9047	1 13/16"
9247	2 1/32"
9251	1 15/16"

EXHAUST GASKET CHARTS

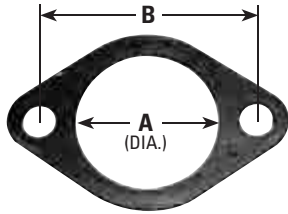

GASKET NO.	A	B
8405	2 1/4"	4"
8412 ⁵	2 19/32"	4 3/32"
8426	2 1/4"	4 1/32"
8428+	2 5/64"	3 1/2"
8430+	1 13/16"	3"
8454+	2 19/64"	3 7/8"
8455+	2 13/32"	3 3/8"
8456+	2 19/32"	3 5/16"
8459+	2 5/32"	3 1/8"
8688	2 13/32"	3 15/16"
8689	2 3/8"	3 5/8"
8692	2 1/8"	4"

GASKET NO.	A	B
8697	2"	3 3/8"
8703+	1 49/64"	3"
8704+	2"	3 1/8"
8707+	1 7/8"	3 3/4"
8714	1 31/32"	2 15/16"
8719	1 15/16"	3 1/8"
8722	1 31/32"	3 1/4"
8724	2 5/16"	3 1/2"
8726	2 3/16"	3"
8729	2 9/16"	3 11/16"
8735#	1 13/16"	3 1/8"
8735S	1 13/16"	3 1/8"
8741	1 31/32"	3 3/8"
8742	2 15/32"	3 7/8"
8751	1 13/16"	3"
8768	2"	3 1/2"
8771+	2 1/2"	4"
8772+	2 5/16"	3 1/2"
9033	1 13/16"	2 13/16"
9064	1 27/32"	2 59/64"

GASKET NO.	A	B
9072	2 1/16"	3 5/32"
9075	2"	3"
9079+	2 5/8"	4 1/4"
9081	2"	3 3/16"
9088	1 27/32"	5 1/4"
9099	2 1/2"	4 1/8"
9238	2 1/4"	3 1/2"
9250	2 1/16"	4 5/16"
9256	2 3/8"	4 5/16"
9258+	1 13/16"	3 3/8"
9270	2 21/32"	4 1/16"
9274	2 5/16"	4 1/8"
9275	2 1/4"	3 7/8"
9277	1 15/16"	3 5/8"
9279	2 1/4"	3 5/8"
9284	3 1/16"	5 5/32"
9288	2 23/32"	4 7/16"

+ Slotted Bolt Hole
Bulk Packed 10/Box
⁵ Tin Plate With Insert

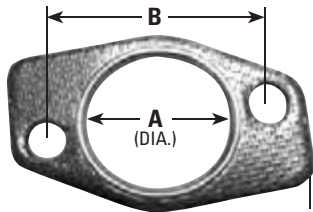

GASKET NO.	A	B
8407	1 27/32"	2 15/16"

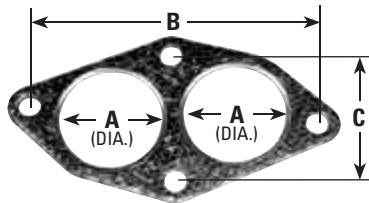

GASKET NO.	A	B	C
9265	1 11/16"	5"	2 3/8"

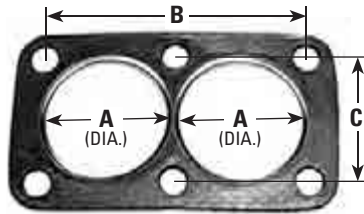

GASKET NO.	A	B	C
9213*	2 3/32"	5 1/16"	2 3/4"

* Hi-temp Graphite

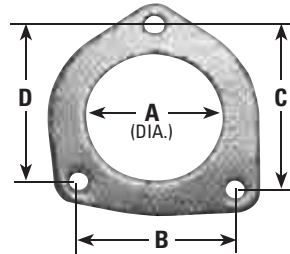

GASKET NO.	A	B	C	D
8414	2 9/16"	2 13/16"	3 9/16"	3 3/8"

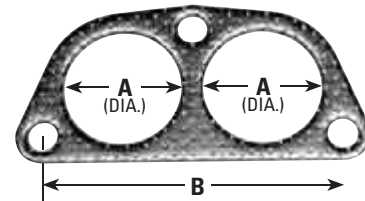

GASKET NO.	A	B
8402	1 13/16"	5 1/8"
8404	2 1/32"	5 5/16"
8463	2"	5"
8696	1 3/4"	4 3/16"
8734	1 11/16"	4"
9022	1 27/32"	4 13/32"
9228	1 7/8"	4 5/16"
9229	2"	4 3/4"
9237	1 1/2"	3 15/16"
9253	1 3/4"	4 5/16"
9255@	1 9/16"	4 3/4"
9281	1 15/32"	3 7/8"
9286+	2 9/16"	7 11/16"

@ Holes Connect
+ Slotted Bolt Hole

EXHAUST GASKET CHARTS

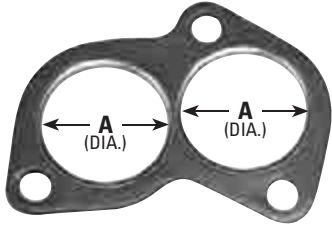

GASKET NO.	A
8750	1 3/16"
9235+	2"

+ Slotted Bolt Hole

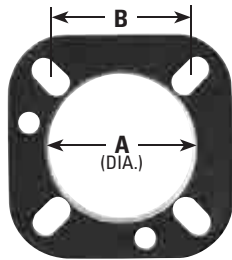

GASKET NO.	A	B
9069	2 29/32"	2 15/16"
9070	3 3/8"	3 7/16"

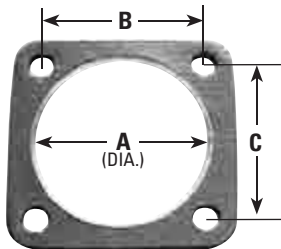

GASKET NO.	A	B	C
8481	3"	3 1/4"	3 1/4"
8759	3 3/32"	2 29/32"	4 31/64"
9025	2 15/16"	2 3/8"	2 3/8"
9058	2 3/4"	2 1/2"	2 3/4"
9226	2 1/2"	2 13/16"	2 1/2"
9227	2 3/4"	3 1/16"	2 11/16"
9289	2 5/8"	3 1/4"	3 1/4"

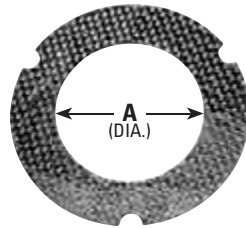

GASKET NO.	A
9223	2 5/8"

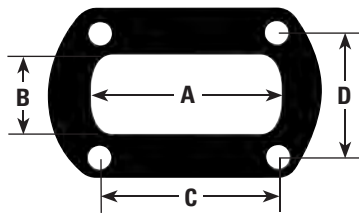

GASKET NO.	A	B	C	D
9245	5 9/16"	2 5/16"	4 9/16"	4 1/4"

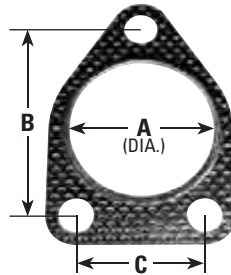

GASKET NO.	A	B	C
8439	2 1/2"	4"	2 43/64"
8453	2 1/4"	3 3/32"	2 23/32"
8701+*	2 1/16"	2 7/8"	2 1/2"
8760	1 13/16"	3 1/4"	2 1/2"
9043	2"	3 1/8"	2 5/16"
9097	2 3/32"	2 15/16"	1 13/16"
9098	1 3/4"	2 13/16"	1 9/16"
9239	2 1/4"	3 3/16"	1 15/16"
9269	2 5/8"	3 5/8"	2 5/16"

+ Slotted Bolt Hole

* Hi-temp Graphite

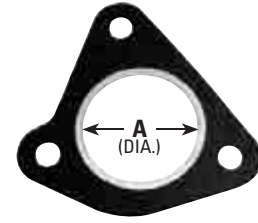

GASKET NO.	A
8712	2 3/32"

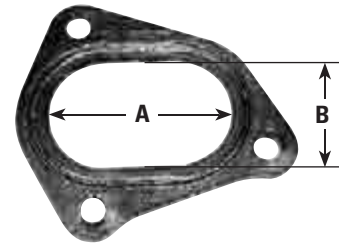

GASKET NO.	A	B
9263	3 7/16"	2 3/16"

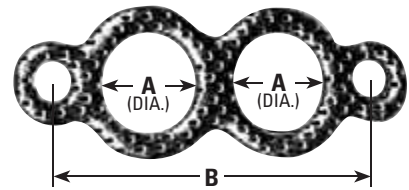

GASKET NO.	A	B
9224	1 5/16"	3 5/16"

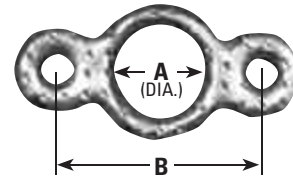

GASKET NO.	A	B
9242	1 3/16"	1 3/4"

EXHAUST GASKET CHARTS

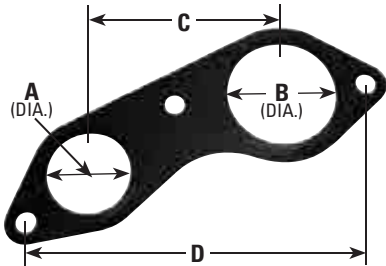

GASKET NO.	A	B	C	D
4731	3 5/32"	3 23/32"	5 5/8"	9 15/16"
9285	2 1/16"	2 3/4"	5 1/4"	9 5/32"

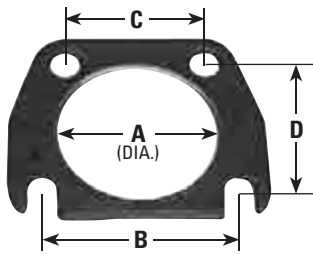

GASKET NO.	A	B	C	D
8682	2 1/16"	2 11/16"	1 15/16"	2 3/16"
9014	2"	3 3/16"	2 3/8"	2 9/8"
9015	2 5/8"	3 3/16"	2 3/8"	2 5/8"

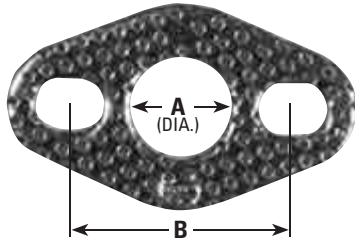

GASKET NO.	A	B
9291+	3/4"	1 11/16"
9299	3/4"	2 1/8"

Airtibe / O2 Sensor Gasket

+ Slotted Bolt Hole

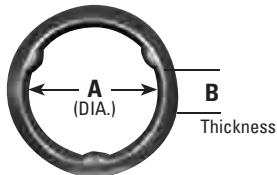

GASKET NO.	A	B
9048	1 27/32"	17/32"
9297	2"	9/16"

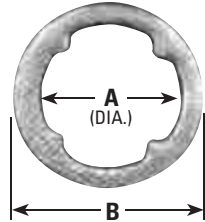

GASKET NO.	A	B
9266	2 9/16"	3 1/2"

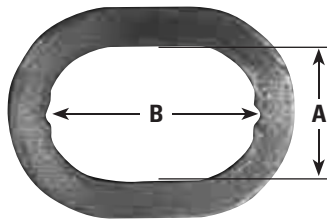

GASKET NO.	A	B
8725	2 7/32"	3 3/8"

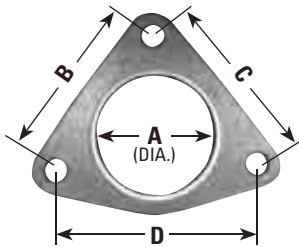

GASKET NO.	A	B	C	D
8468	2 9/16"	4 29/32"	4 29/32"	4 1/2"
9276	2 7/16"	3 1/2"	3 1/2"	4 1/4"

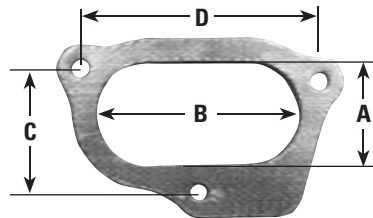

GASKET NO.	A	B	C	D
8708+	2 17/32"	3 25/32"	3 3/8"	4 3/4"
9271	2 11/32"	4 3/4"	2 15/16"	5 9/16"

+ Slotted Bolt Hole

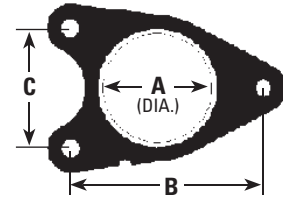

GASKET NO.	A	B	C
8728	2 3/4"	5 3/16"	3 1/8"

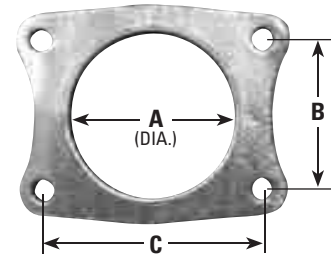

GASKET NO.	A	B	C
9119	3 1/2"	3 1/4"	4 57/64"

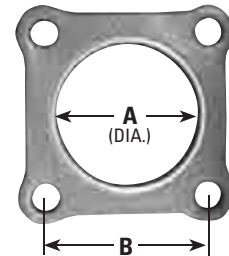

GASKET NO.	A	B
8417	3 9/16"	3 7/32"
8433	4"	3 7/8"
9011	2 11/32"	2 13/16"

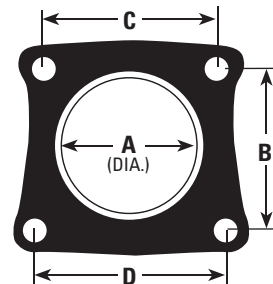

GASKET NO.	A	B	C	D
8721	2 5/8"	2 45/64"	3 21/32"	4 9/64"

EXHAUST GASKET CHARTS

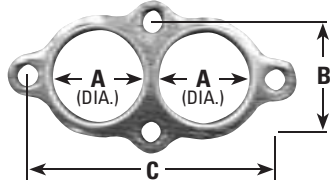

GASKET NO.	A	B	C
8401	1 27/32"	2 1/4"	5 1/8"

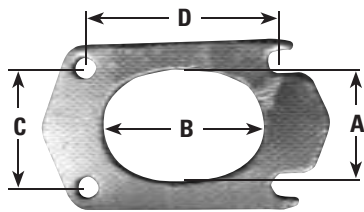

GASKET NO.	A	B	C	D
8761	2 1/2"	3 9/16"	2 3/4"	4 3/8"

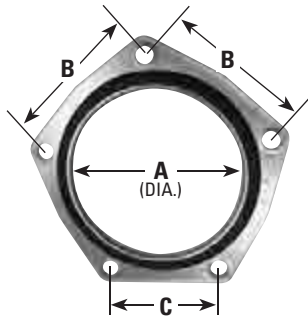

GASKET NO.	A	B	C
8413 ⁵	3 21/32"	3 1/16"	2 17/32"

⁵ Tin Plate With Insert

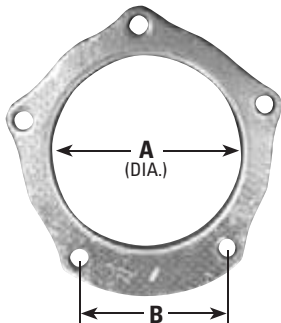

GASKET NO.	A	B
8409	4"	2 7/8"
8465	3 1/2"	3"
8723	3 17/32"	2 13/16"
9096	4 19/32"	3 3/16"
9254	4 1/16"	3 1/8"

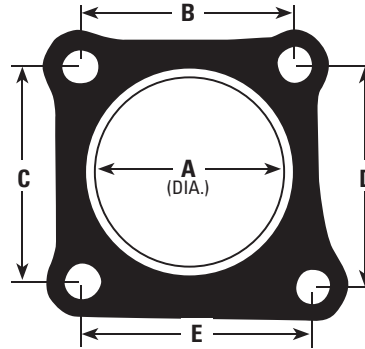

GASKET NO.	A	B	C	D	E
9013	2 1/2"	3 1/4"	3 1/4"	3 1/2"	3 5/8"

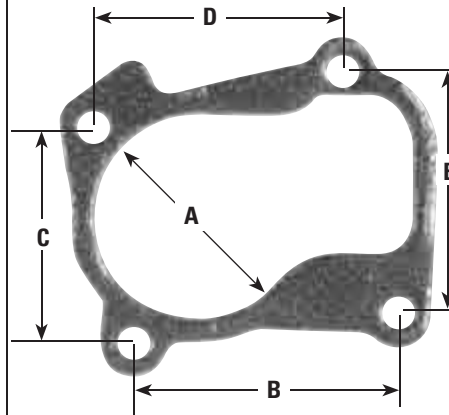

GASKET NO.	A	B	C	D	E
8687	2 1/4"	3"	2 1/2"	2 7/8"	2 49/64"

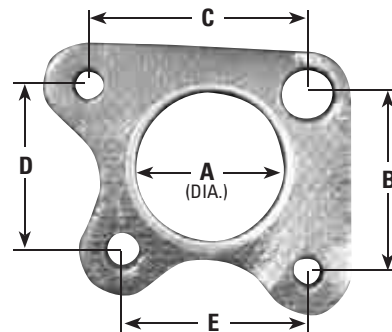

GASKET NO.	A	B	C	D	E
8732	2 1/32"	2 15/32"	3 1/16"	2 1/4"	2 17/32"

EXHAUST GASKET CHARTS

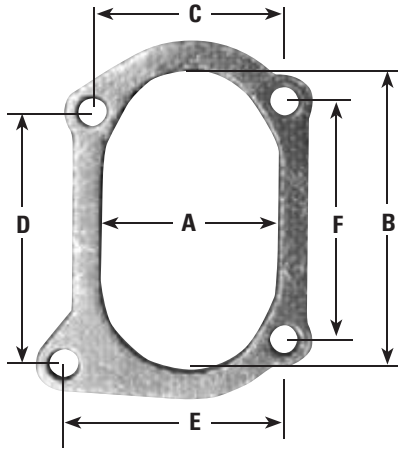

GASKET NO.	A	B	C	D	E	F
8713	2 19/32"	4 15/32"	2 7/8"	3 13/16"	3 5/16"	3 5/8"

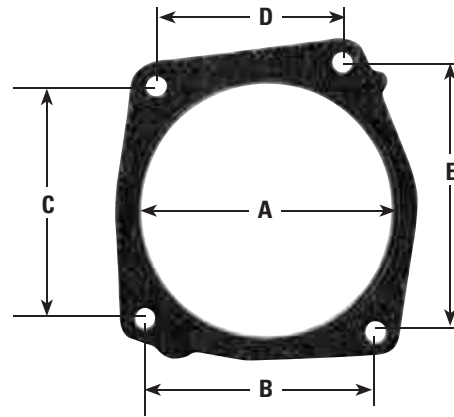

GASKET NO.	A	B	C	D	E
8452	4 43/64"	4 1/4"	4 1/4"	3 1/2"	5"

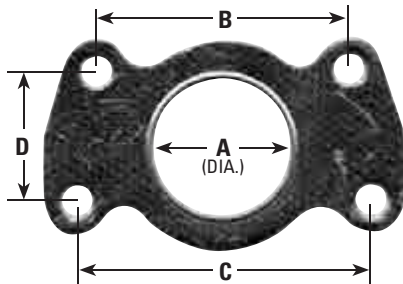

GASKET NO.	A	B	C	D
9054	2"	3 3/4"	4 5/16"	1 15/16"

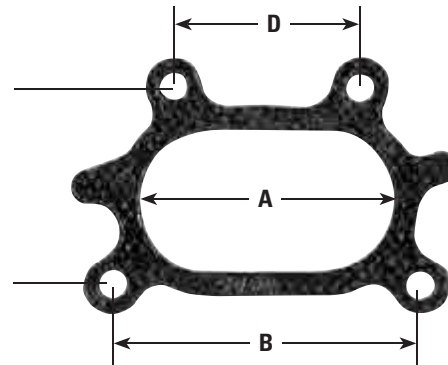

GASKET NO.	A	B	C	D
8480	3 1/4"	3 15/16"	2 1/2"	2 3/8"

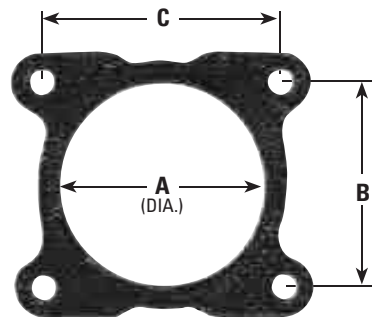

GASKET NO.	A	B	C
8436	3"	3"	3 1/2"

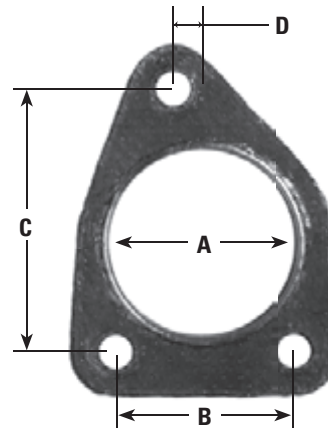

GASKET NO.	A	B	C	D
8685	2 1/4"	2 7/32"	3 3/16"	3/8"

EXHAUST GASKET CHARTS



8431

- 96-00 Honda Civic CX/DX/LX 1.6L
- 96-97 Honda Del Sol S 1.6L



8432

- 06-10 Ford Fusion 3.0L, FWD
- 06-10 Mercury Milan 3.0L, FWD



8446

- 07-09 Kia 3.3L, 3.8L



8447

- 07-09 Kia 3.3L, 3.8L



8471

- 07-09 Lexus 3.5L
- 05-12 Toyota 3.5L



8472

- 07-12 Nissan 2.5L



8475

- 03-09 Toyota 4 Runner 4.0L
- 02-11 Toyota FJ Cruiser 4.0L



8476

- 07-12 GM Colorado/Canyon 3.7L
- 07-10 Hummer H3 3.7L



8477

- 04-07 Chevrolet Malibu 2.2L
- 06-07 Pontiac G6 2.4L



8479

- 07-12 GM Colorado/Canyon 2.9L

EXHAUST GASKET CHARTS



8486

09-12 GM Aveo, G3 1.6L, Cruze 1.8L



8491

05-10 Hyundai 2.0L

05-09 Kia 2.0L



8492

99-10 Hyundai/Kia 2.7L



8495

04-06 Infiniti 5.6L

04-12 Nissan 5.6L



8496

01-11 Hyundai 1.6L

06-11 Kia 1.6L



8497

02-12 Nissan 2.5L



8499

99-06 Lexus, Toyota 3.0L

04-10 Lexus, Toyota 3.3L



8718

96-12 Ford, Mercury 2.5L, 3.0L



9243

05-09 Scion TC 2.4L

08-10 Scion XB 2.4L

02-09 Toyota Camry 2.4L

01-07 Toyota Highlander 2.4L

04-11 Toyota RAV-4 2.4L

02-08 Toyota Solara 2.4L

AP EPA CONVERTER SUPERSESSIONS

OLD PART NO.	NEW PART NO.
641193	641374
641233	641344
641241	641329
641251	641318
641252	641344
641257	641355
641258	641356
641271	641344
641275	641439
641276	641340
641279	641327
641284	641260
641285	641261
641446	641343
642084	645784
642152	642061
642190	642067
642198	641343

OLD PART NO.	NEW PART NO.
642222	642803
642725	642291
642733	642161
642734	642179
642999	643083
643062	643043
643068	642001
643077	643090
645295	641394
645388	645255
645389	645256
645821	645797
645835	642817 + 7511
645845	645804
645874	645798
645892	645893
645988	645236