



EXHAUST TECHNOLOGIES®



:: Mufflers :: Exhaust Pipes :: Accessories ::

MSL®
Muffler Shop Line

**Professional
Installer
Catalog**

Be Car Care Aware™
APRIL • NATIONAL CAR CARE MONTH



THE MANUFACTURING PROCESS



ENGINEERING

ENGINEERING

AP Exhaust Technologies is recognized as one of the world's most innovative producers of aftermarket exhaust and emission systems. At AP, development of these products begins in our engineering technical center

where application research, and the use of state-of-the-art CAD systems, connect with prototyping, and tooling design processes for quicker development and release of new exhaust and emission products.



MANUFACTURING

MANUFACTURING

The minute a part is sold, the process begins for replenishment. AP deploys throughout its 440,000 ft² manufacturing facility a linked production system that consistently produces parts for an on-time delivery to our distribution center. Advanced automation, robotics, and computer controlled equipment assure that quality parts are in position at the right time.

With multiple production areas ranging from steel coil processing, muffler assembly, pipe bending, and catalytic converter welding this modern approach to manufacturing reduces production lead times, and improves the quality of the products and accentuates the responsiveness to AP customer needs.

DISTRIBUTION

DISTRIBUTION

AP's strength is in our consistently high order fill rate maintained across all product lines. From our 250,000 ft² distribution center, daily shipments are processed quickly and accurately assuring that AP customers have the products they need in stock at all times. Using the latest in distribution processes and equipment, AP is leading the way in customer service and delivery.



COMPREHENSIVE PRODUCT ASSORTMENT

OE REPLACEMENT



WELDED ASSEMBLIES

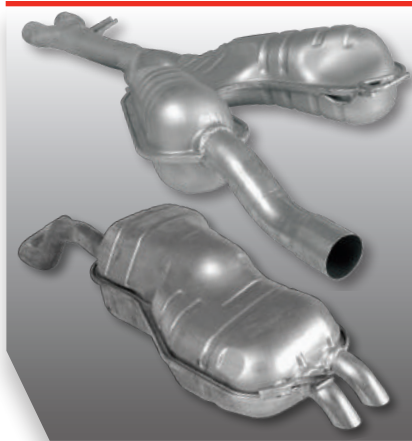

CATALYTIC CONVERTERS



PREBENT PIPES



PERFORMANCE



HEAVY DUTY



MADE IN USA

1211

INLET

TABLE OF CONTENTS



MSL, Maximum Direct Fit Mufflers - Applications By Make	2-61
MSL, Maximum Muffler Specifications - By Part Number	62-94
MSL, Maximum Muffler Specifications - By Universal Dimension	95-113
MSL, Maximum Muffler Numerical Listing	114-126
Xlerator High Performance Mufflers - Stainless Steel, VX, VR	127-133
Xlerator All-Welded Performance Mufflers	134-135
Big Max Aluminized Turbo Mufflers	136-137
Enforcer Aluminized Glasspacks	138-139
Enforcer Aluminized Turbopacks & Torpedopacks	140
Header Gaskets & Flanges	141
Cherry Bomb Performance Mufflers	142-161
Glasspacks	142-144
M-80	145
Salute	146-149
Vortex	150-151
Extreme	152
Pro	153-155
Turbo	156-157
Hot Rod	158
Cherry Bomb Accessories	159-161
Enforcer II Economy Mufflers	162-165
Universal All Welded Aluminized Heavy Duty Truck Mufflers	166
Flex & Repair Exhaust Pipe	167-170
Max Fit Exhaust & Tailpipes	171-185
Numerical Listing of Max Fit Pipes w/Overall Length	186-190
Accessories	
Gaskets - Images by Part Number	191-195
Brackets - Hangers, Misc. Parts - Images by Part Number	195-198
Clamps	199-204
Hangers	205-207
Brackets, Straps & Grommets	207-210
Heat Shields, Heat Risers, Split Flanges & Stud Repair Kits	210-211
Bolts, Nuts, Screws	211-212
Studs, Washers & Shims	212-213
Manifold Shoulder Bolts & Springs, Joint Connector	213-214
Universal & Special Application Flanges	215
Exhaust Pipe Flange Charts	216-218
Exhaust Gasket Charts w/Specs	219-228
Elbows, Reducers, Connectors, Adapters	228-236
Flex Coupling	237
Y-Pipes, Splitter T's, HD Flanges, Tubes, Inserts	238
Flex Tubing, Bellows	239-240
Straight Tubing	241
Chrome Tips	242-244
Stainless Tips	245-249
Tail Spouts	249
Tools	250

ACURA

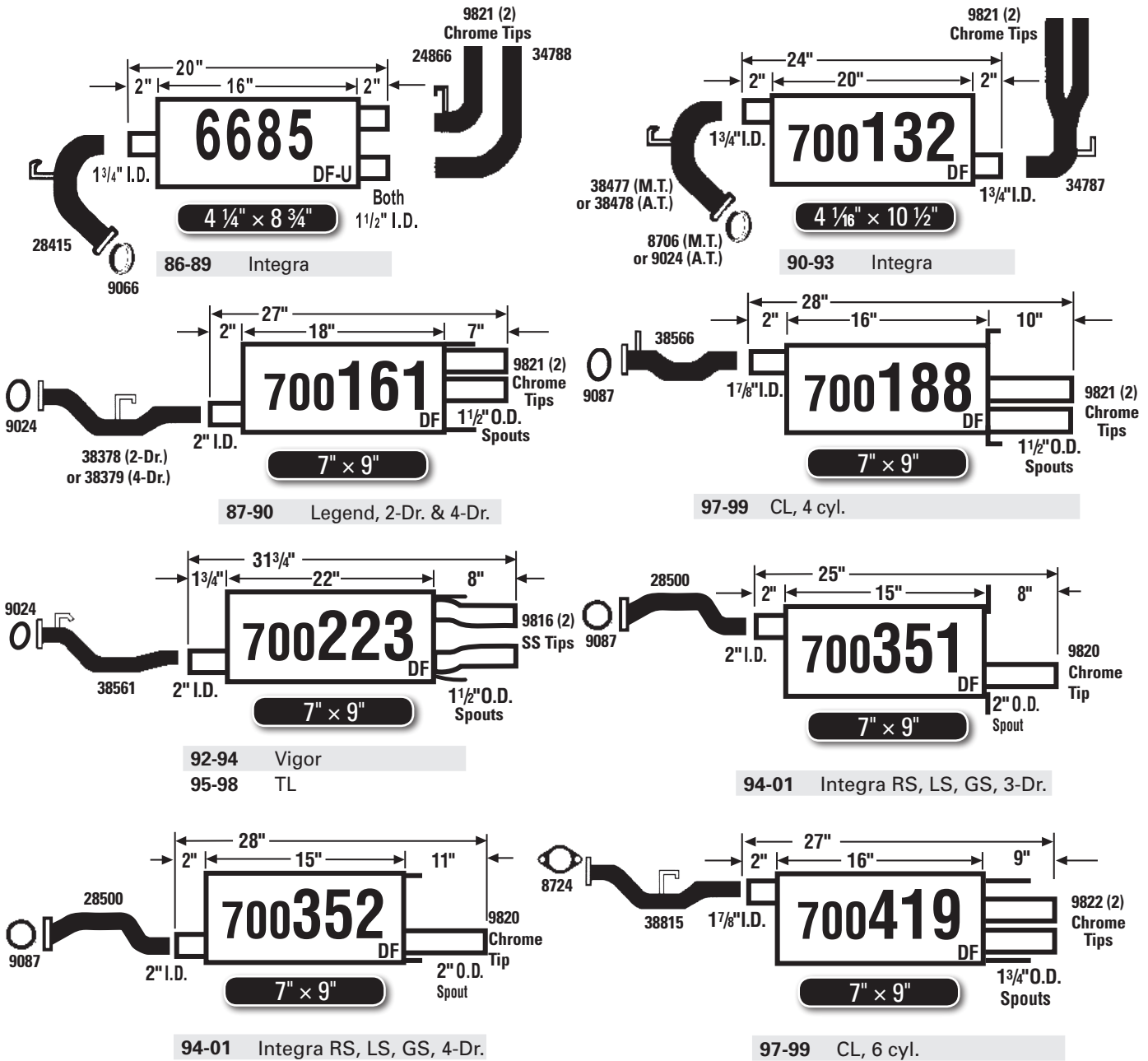

NOTE: Black area denotes welded head bracket.

DF-U - Denotes muffler used primarily as Direct Fit, but is also Universal.
 U-DF - Denotes muffler used primarily as Universal, but is also Direct Fit.

DF - Direct Fit Muffler
 U - Universal Muffler
 HS - Denotes Heat Shield is on muffler.

CHRYSLER / DODGE / PLYMOUTH / RAM

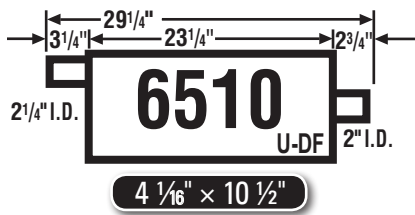

- 65-74 Fury, Monaco, Polara
- 65-73 Custom 880, Monaco, Polara (Front)
- 65-72 Custom 880, Imperial, Newport, New Yorker, Dual Exh.
- 65-67 Newport, New Yorker

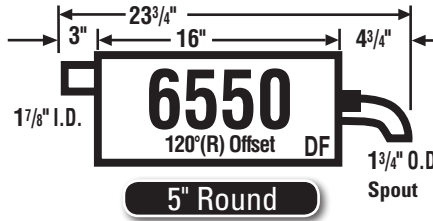

- 81-88 600, Caravelle
- 83-87 New Yorker
- 82-86 LeBaron, Town & Country
- 81-86 Aries
- 81-86 Reliant, Reliant America
- 81-85 400



- 81-90 Omni, Horizon
- 83-87 Charger, Turismo
- 82-84 Rampage, Scamp



- 87-90 Caravan, Caravan C/V, Voyager, Grand Caravan, Grand Caravan C/V, Grand Voyager, Mini-Ram Van

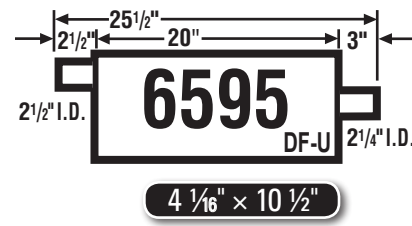

- 80-89 AD, AW, PD, PW Series

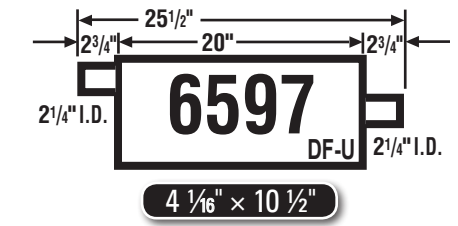

- 79-80 Chry. Full Size
- 75-79 Cordoba, Magnum
- 67-80 Dod./Plym. Full Size
- 75-78 Fury, Fury Custom, Roadrunner
- 74-76 Satellite, Roadrunner
- 69-73 Belvedere, Roadrunner, Satellite
- 1967 Belvedere, Satellite

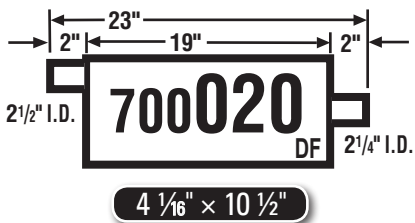

- 1990 Dakota

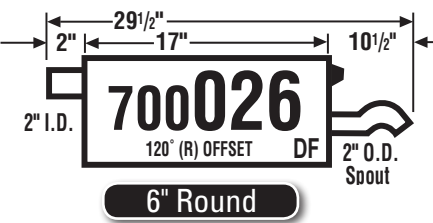

- 89-95 Acclaim, Spirit
- 90-94 LeBaron, 4-Dr. Sedan

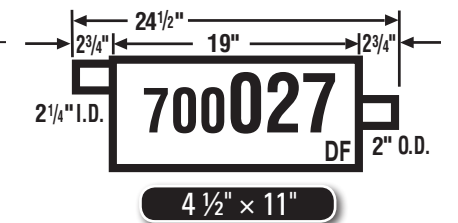

- 91-95 Caravan, Voyager, Town & Country

NOTE: Black area denotes welded head bracket.

DF-U - Denotes muffler used primarily as Direct Fit, but is also Universal.
 U-DF - Denotes muffler used primarily as Universal, but is also Direct Fit.

DF - Direct Fit Muffler
 U - Universal Muffler
 HS - Denotes Heat Shield is on muffler.

CHRYSLER / DODGE / PLYMOUTH / RAM

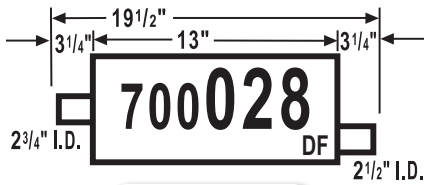

7" x 9"

92-93 Dakota, D150/250, W150/250 Ramcharger

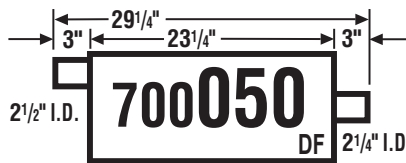

4 1/16" x 10 1/2"

75-78 Newport, New Yorker, Imperial, Town & Country
88-89 D100/150/250, W100/150
79-89 Series D, W, AD, AW/PD, PW, Ramcharger, Trail Duster
75-87 Series B, C, P, CB, MB, Vans, Wagons

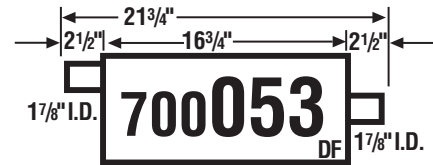

4 1/4" x 8 3/4"

82-89 New Yorker, 5th Avenue
80-83 Cordoba, Imperial (81-83)
79-81 Newport (79-80), New Yorker (1979), LeBaron, Town & Country (79-80)
79-89 Diplomat, Mirada (80-89), St. Regis (1979)
76-80 Aspen (exc. 1978)
82-89 Gran Fury
76-80 Volare (exc. 1978)

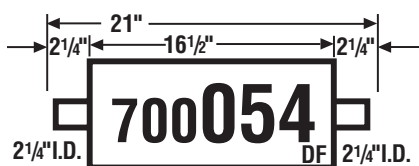

4" Round

1993 Imperial, New Yorker, 5th Avenue

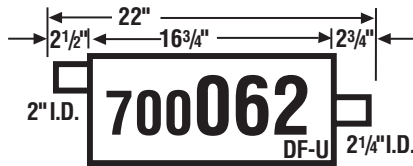

4 1/4" x 8 3/4"

79-87 Series B, D, W, PB, CB300/350, MB300, PD100, PW100
79-80 AD100, AW100

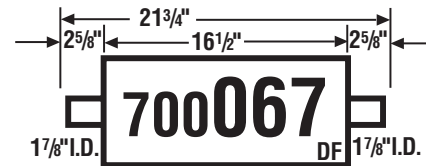

4" Round

82-90 LeBaron, New Yorker (83-87), E-Class (83-84), Town & Country (82-88)
89-90 Spirit (exc. turbo)
82-88 400 (82-83), 600, Aries, Aries America
89-90 Acclaim (exc. Turbo)
83-88 Caravelle (85-88), Reliant, Reliant America
85-90 Omni, Horizon (Canada)

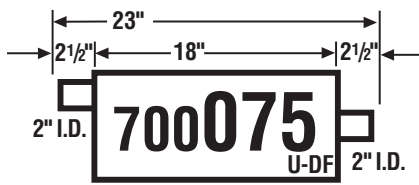

4 1/16" x 10 1/2"

87-96 Dakota 4 cyl.
87-89 Dakota 6 cyl.



6" Round

1985 LeBaron, Town & Country (exc. GTS & turbo)
85-86 Aries, 600, Reliant

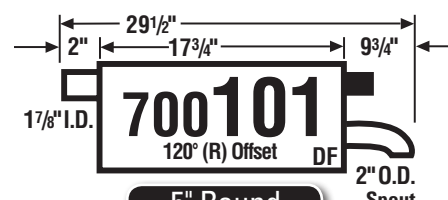

5" Round

89-90 LeBaron Coupe, Convertible, (exc. turbo)
87-88 LeBaron, Town & Country
87-88 Aries, Aries America
87-88 Reliant, Reliant America

NOTE: Black area denotes welded head bracket.

DF-U - Denotes muffler used primarily as Direct Fit, but is also Universal.
 U-DF - Denotes muffler used primarily as Universal, but is also Direct Fit.

DF - Direct Fit Muffler
 U - Universal Muffler
 HS - Denotes Heat Shield is on muffler.

CHRYSLER / DODGE / PLYMOUTH / RAM

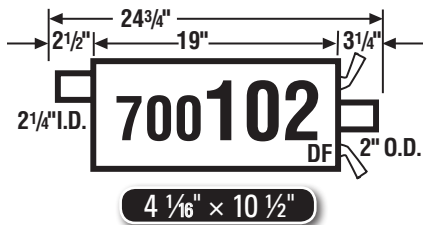

- 1990 Town & Country
- 87-90 Caravan, Voyager, Grand Caravan, Voyager

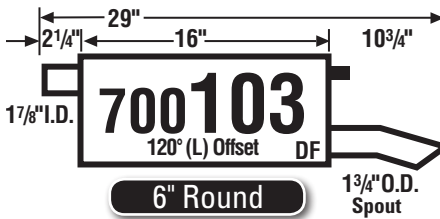

- 87-94 Shadow, Shadow America (exc. turbo)
- 87-94 Sundance, Sundance America (exc. turbo)
- 1992 Duster

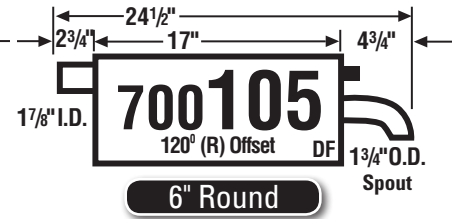

- 87-89 Aries, Aries America
- 87-89 Reliant, Reliant America



- 90-93 New Yorker, Landau, Salon, 5th Avenue, Imperial
- 88-89 New Yorker
- 88-93 Dynasty



- 90-95 LeBaron Coupe, Conv.

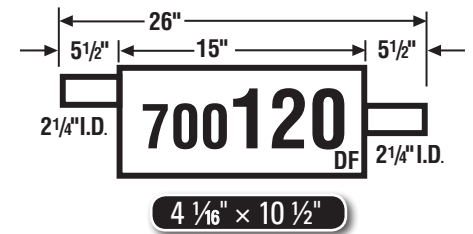

- 1992 B250/350
- 89-91 B150/250/350

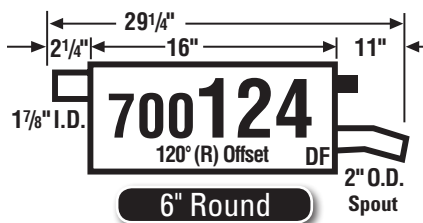

- 84-89 LeBaron, LeBaron GTS (85-89), Laser (84-86) (exc. turbo)
- 84-89 Lancer (85-89), Daytona (84-88) (exc. turbo)

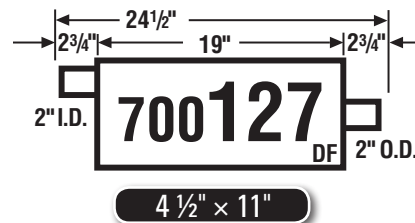

- 91-95 Caravan, Voyager

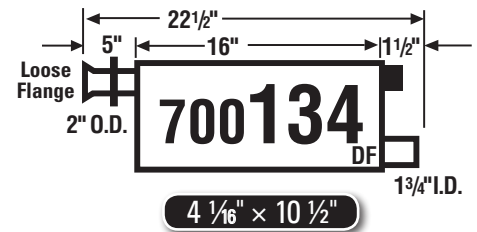

- 87-94 2000cc (87-89), 2600cc (87-89), Ram 50, Power Ram 50 Pickup (exc. 93-94 Calif.)

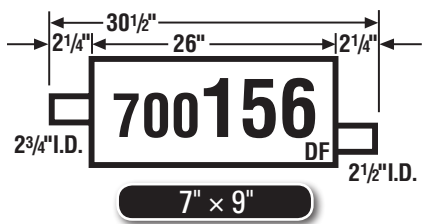

- 92-94 B150/250

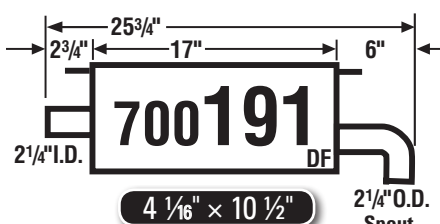

- 95-99 Neon

NOTE: Black area denotes welded head bracket.

DF-U - Denotes muffler used primarily as Direct Fit, but is also Universal.
 U-DF - Denotes muffler used primarily as Universal, but is also Direct Fit.

DF - Direct Fit Muffler
 U - Universal Muffler
 HS - Denotes Heat Shield is on muffler.

CHRYSLER / DODGE / PLYMOUTH / RAM

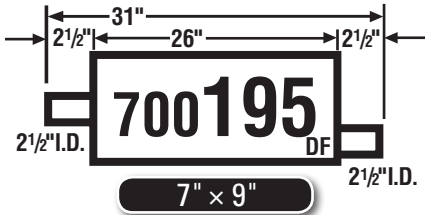

94-97 B150/250

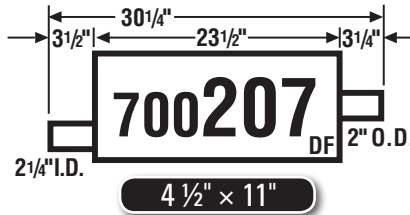

91-95 Town & Country, Grand Caravan, Grand Caravan C/V, Grand Voyager

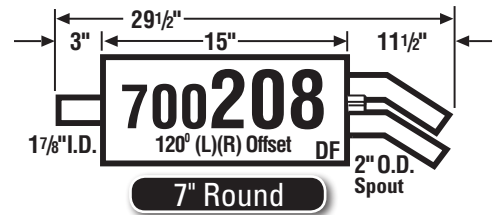

92-94 Shadow
92-94 Duster, Sundance

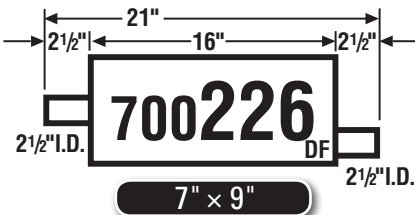

94-97 R1500, R2500

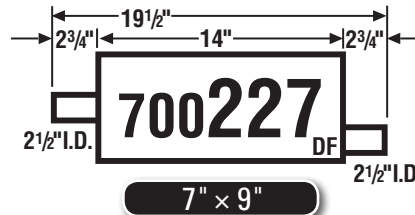

94-96 Dakota

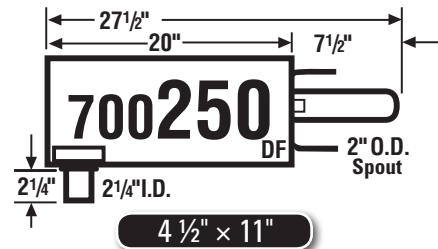

96-97 Cirrus
95-97 Stratus, Breeze

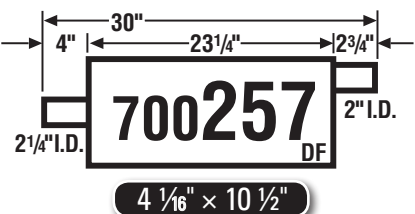

96-07 Town & Country, Caravan, Voyager, Grand Caravan, Grand Voyager

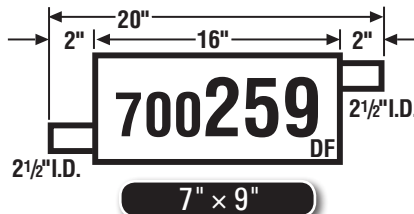

97-99 Dakota

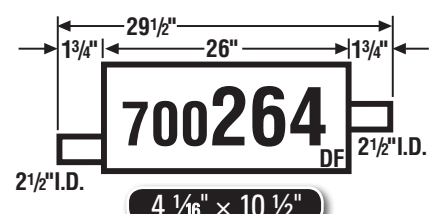

76-78 B100, BF100, B200, BF200, B300, BF300, CB300, MB300, MB400, PB100, PB200, PB300

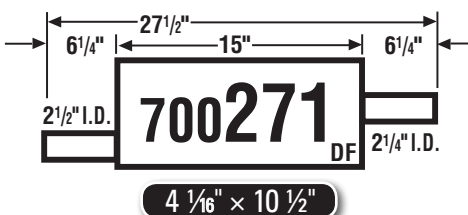

1992 AD150, AW150, Ramcharger
90-91 AD100, AD150, AW100, AW150; Ramcharger
90-91 D150, D250, D350
90-92 D250, W150, W250, W350
1989 W100, W150

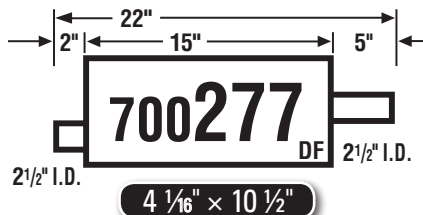

1991 Dakota

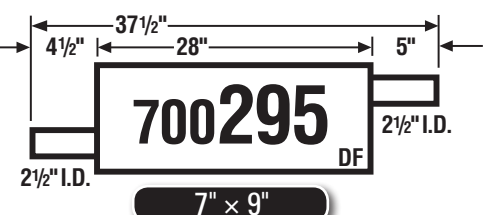

98-02 Series R1500

NOTE: Black area denotes welded head bracket.

DF-U - Denotes muffler used primarily as Direct Fit, but is also Universal.
U-DF - Denotes muffler used primarily as Universal, but is also Direct Fit.

DF - Direct Fit Muffler
U - Universal Muffler
HS - Denotes Heat Shield is on muffler.

CHRYSLER / DODGE / PLYMOUTH / RAM

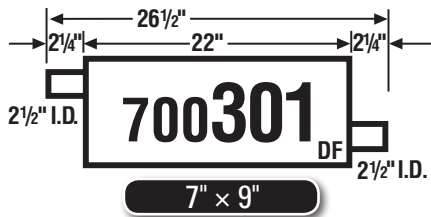

98-03 Series B150

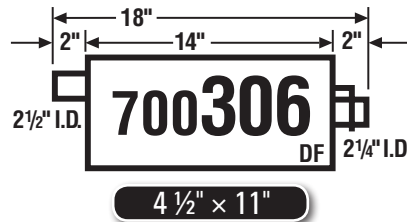

98-02 Concorde (Rear)
98-04 Intrepid (Rear)

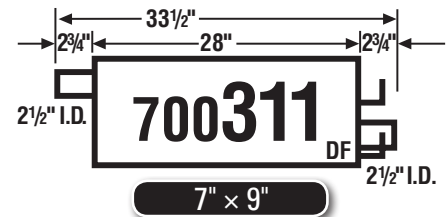

98-03 Durango

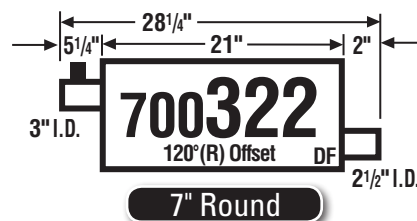

88-93 D250, D350 Turbo Diesel Eng.
88-93 W250, W350 Turbo Diesel Eng.

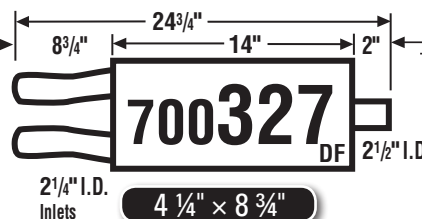

99-04 300M (Front)
98-04 Concorde, Intrepid, 3.2L & 3.5L (Front)
99-01 LHS (Front)

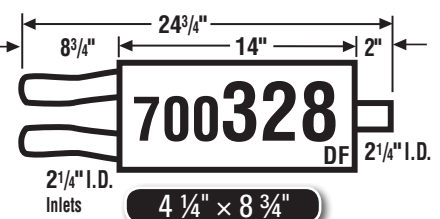

98-04 Concorde, Intrepid, 2.7L (Front)

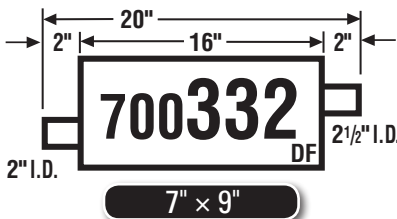

97-99 Dakota 4 cyl.

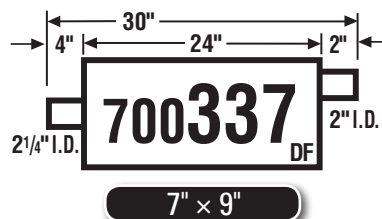

96-07 Caravan, Voyager 4 cyl.
96-00 Grand Caravan, Grand Voyager 4 cyl.

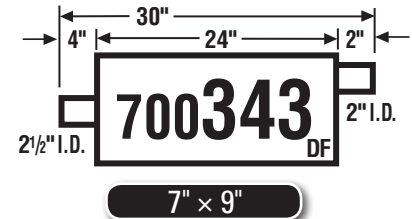

01-05 Town & Country, Grand Caravan, Grand Voyager 6 cyl., 3.8L



00-05 Neon

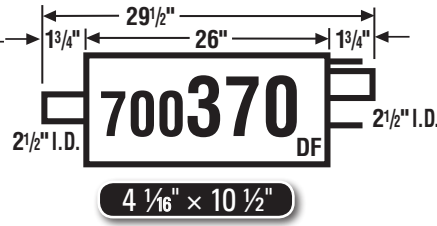

00-03 Durango 8 cyl.

NOTE: Black area denotes welded head bracket.

DF-U - Denotes muffler used primarily as Direct Fit, but is also Universal.

U-DF - Denotes muffler used primarily as Universal, but is also Direct Fit.

DF - Direct Fit Muffler
U - Universal Muffler

HS - Denotes Heat Shield is on muffler.

CHRYSLER / DODGE / PLYMOUTH / RAM

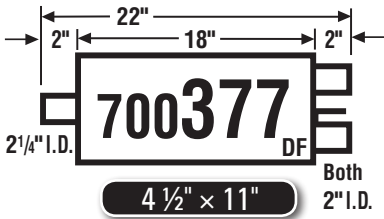

96-00 Sebring Convertible

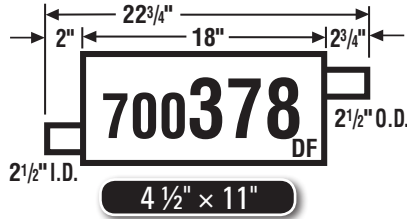

99-04 300M (Center)
98-04 Concorde, Intrepid 3.2L & 3.5L (Center)
99-01 LHS (Center)

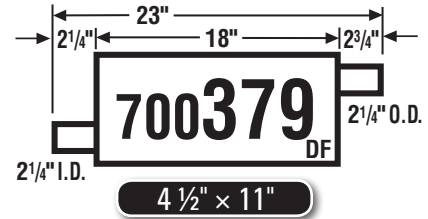

98-04 Concorde, Intrepid, 2.7L (Center)

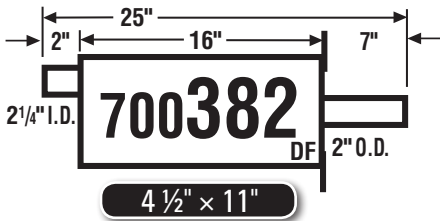

98-00 Cirrus, Breeze
01-06 Sebring (Sedan)
98-06 Stratus (Sedan)



98-04 Concorde, Intrepid, 2.7L (Rear)

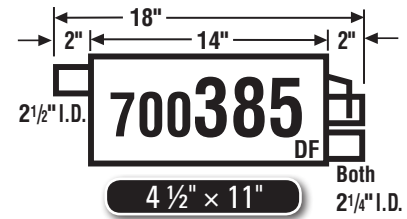

99-04 300M (Rear)
02-04 Concorde Limited, 3.5L (Rear)
99-01 LHS (Rear)

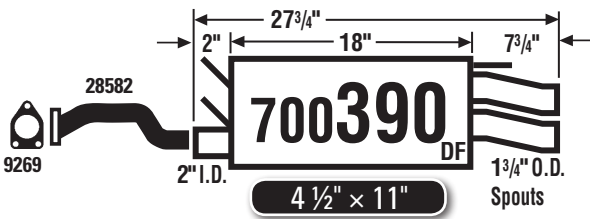

95-00 Avenger, Sebring LX, LXI Coupe

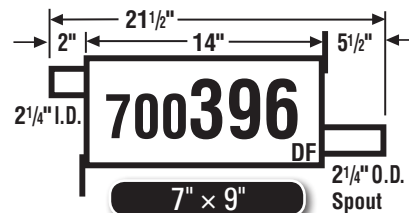

01-10 PT Cruiser (exc. Turbo)

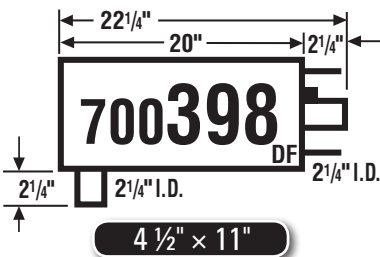

95-97 Cirrus, Stratus, 6 cyl.

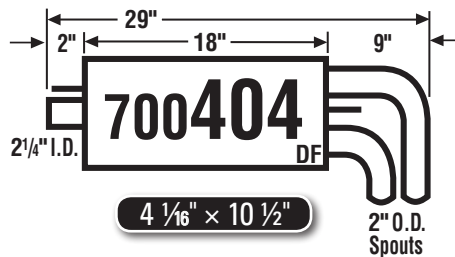

95-99 Neon (DOHC)

NOTE: Black area denotes welded head bracket.

DF-U - Denotes muffler used primarily as Direct Fit, but is also Universal.
U-DF - Denotes muffler used primarily as Universal, but is also Direct Fit.

DF - Direct Fit Muffler
U - Universal Muffler
HS - Denotes Heat Shield is on muffler.

CHRYSLER / DODGE / PLYMOUTH / RAM

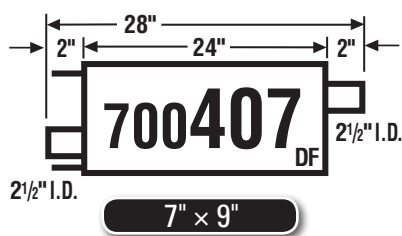

00-03 Dakota, 112" W.B., 131" W.B. Club Cab

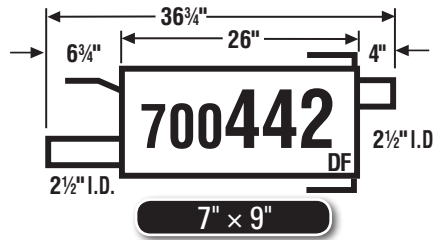

02-05 R1500 Ram Pickup

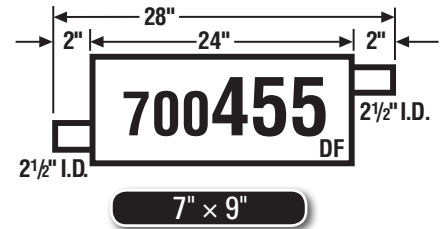

00-03 Dakota Quad Cab, 3.9L
00-03 Dakota Quad Cab, 5.9L

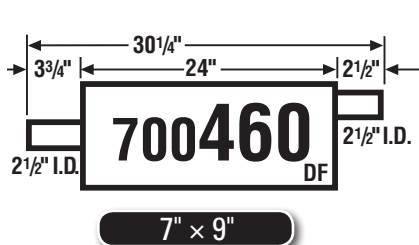

2004 Dakota, Dakota Club & Quad Cab, 3.7L
2004 Dakota, Dakota Club & Quad Cab, 4.7L

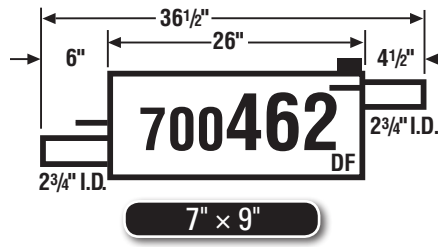

04-05 R1500, 5.7L Hemi

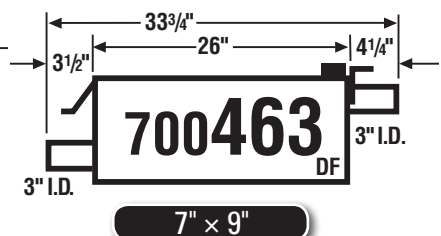

2003 R1500, 5.7L Hemi

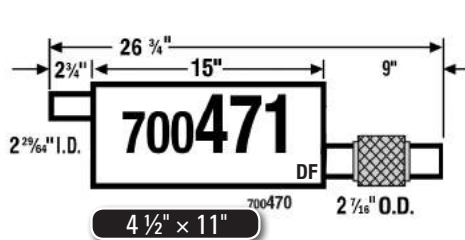

04-06 Chrysler, Pacifica, V6-3.5L, Front Muffler

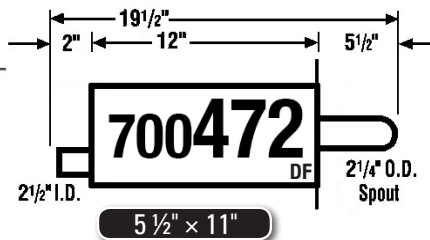

04-06 Chrysler, Pacifica, V6-3.5L, Rear Muffler

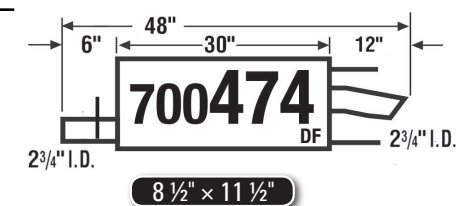

2007 Chrysler, Aspen, V8-4.7L
2007 Chrysler, Aspen, V8-5.7L
04-09 Dodge, Durango, V6-3.7L
04-07 Dodge, Durango, V8-4.7L
04-07 Dodge, Durango, V8-5.7L

NOTE: Black area denotes welded head bracket.

DF-U - Denotes muffler used primarily as Direct Fit, but is also Universal.

U-DF - Denotes muffler used primarily as Universal, but is also Direct Fit.

DF - Direct Fit Muffler

U - Universal Muffler

HS - Denotes Heat Shield is on muffler.

CHRYSLER / DODGE / PLYMOUTH / RAM

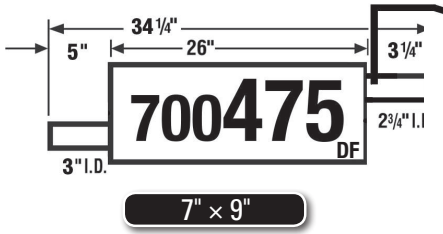

- 06-08 Dodge, Ram 1500, V6-3.7L
- 06-08 Dodge, Ram 1500, V8-4.7L

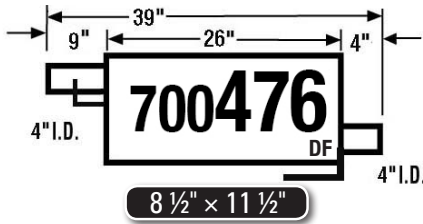

- 05-09 Dodge, Ram 2500, L6-5.9L
- 05-09 Dodge, Ram 3500, L6-5.9L

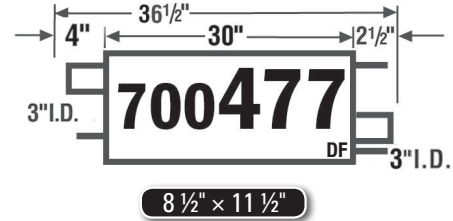

- 06-08 Dodge, Ram 1500, V8-5.7L

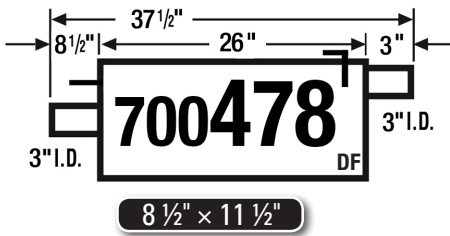

- 03-09 Dodge, Ram 2500, V8-5.7L
- 03-08 Dodge, Ram 3500, V8-5.7L

*Challenge PN: 2558

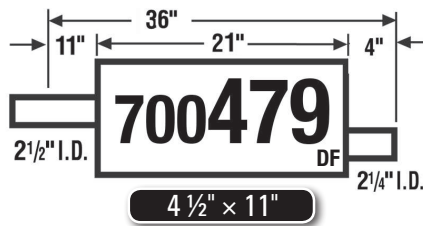

- 07-11 Dodge, Nitro, V6-3.7L
- 08-12 Jeep, Liberty, V6-3.7L

*Challenge PN: 2564

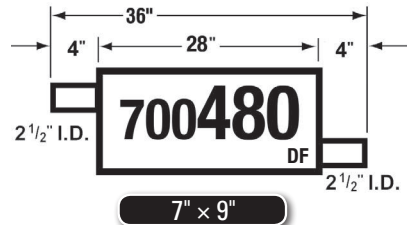

- 05-10 Dodge, Dakota, V6-3.7L
- 05-10 Dodge, Dakota, V8-4.7L
- 06-09 Mitsubishi, Raider, V6-3.7L
- 06-07 Mitsubishi, Raider, V8-4.7L
- 2011 Ram, Dakota, V6-3.7L
- 2011 Ram, Dakota, V8-4.7L

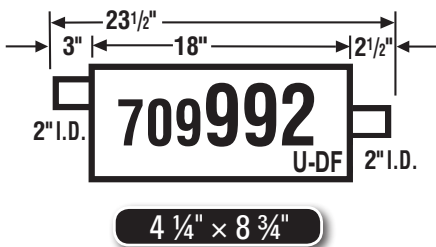

- 87-96 Dakota 4 cyl.
- 87-89 Dakota 6 cyl.

NOTE: Black area denotes welded head bracket.

DF-U - Denotes muffler used primarily as Direct Fit, but is also Universal.
 U-DF - Denotes muffler used primarily as Universal, but is also Direct Fit.

DF - Direct Fit Muffler
 U - Universal Muffler
 HS - Denotes Heat Shield is on muffler.

FORD / LINCOLN / MERCURY

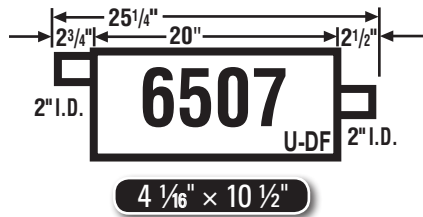

- 1974 Ranchero, Torino Sta. Wag.
- 72-74 Fairlane, Montego, Torino
- 65-72 Custom, Galaxie
- 1966 Comet, Fairlane, All Models

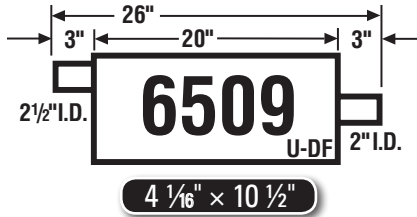

- 72-76 Ford/Merc. Full Size

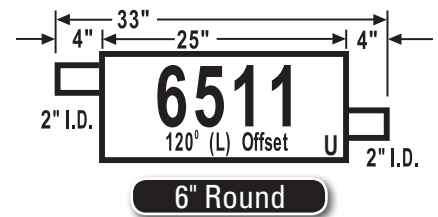

- 61-79 F100 thru F250

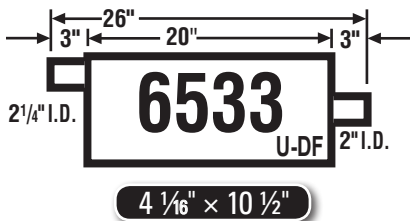

- 67-78 Ford/Merc. Full Size

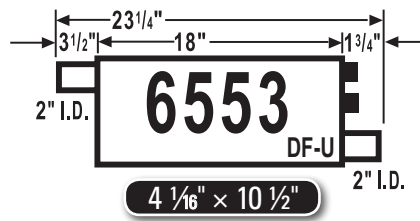

- 80-82 Granada, Cougar
- 79-82 Fairmont, Zephyr

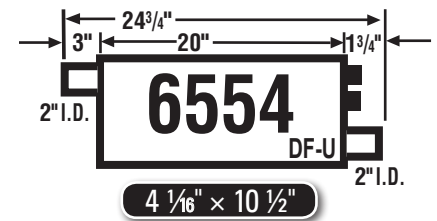

- 83-89 Crown Victoria, Grand Marquis, Sgl. Exh., Dual Exh. (Right)
- 81-89 Town Car, Sgl. Exh., Dual Exh. (Right)
- 80-83 Continental, Mark VI
- 79-82 LTD, Marquis



- 84-94 Tempo, Topaz

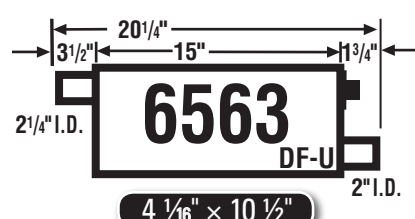

- 83-89 Mustang
- 83-86 Capri

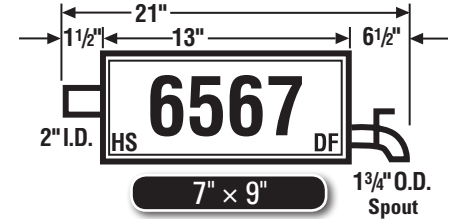

- 85-90 Escort
- 86-88 EXP
- 85-87 Lynx

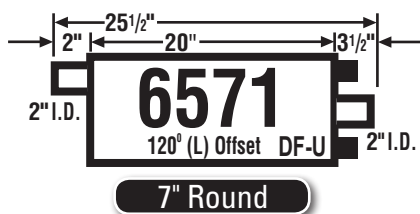

- 85-92 Ranger



- 84-86 F150/250/350

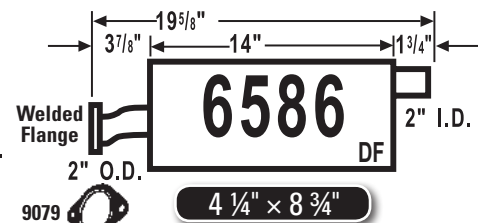

- 86-89 Bronco II

NOTE: Black area denotes welded head bracket.

DF-U - Denotes muffler used primarily as Direct Fit, but is also Universal.
 U-DF - Denotes muffler used primarily as Universal, but is also Direct Fit.

DF - Direct Fit Muffler
 U - Universal Muffler
 HS - Denotes Heat Shield is on muffler.

FORD / LINCOLN / MERCURY

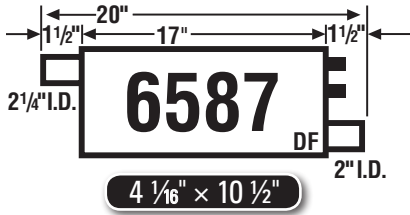

87-88 Thunderbird, Cougar



87-97 F250/350
87-96 F150
87-96 Bronco

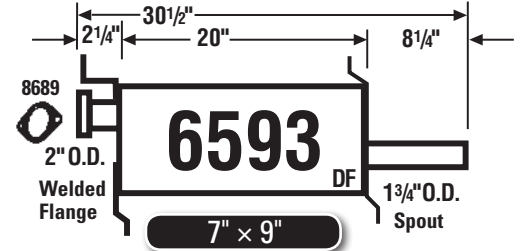

89-92 Probe

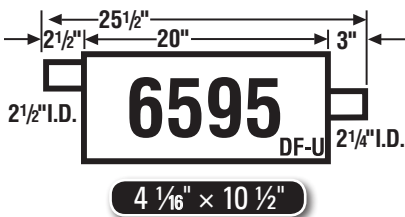

75-76 Galaxie, LTD, Marquis

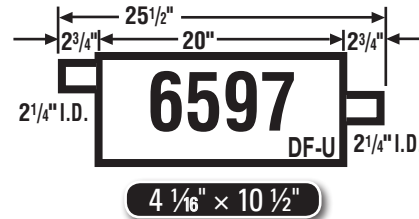

91-92 Explorer
94-96 Park Avenue, Delta 98, Ninety-Eight
1973 LeSabre, Centurion, Electra, Sgl./Dual Exh.
73-74 Delta 88, 98
73-74 Bonneville, Catalina, Grandville, Sgl. Exh. (Front)
73-77 Toronado, All Models, Dual Exh. (Front)
1974 LeSabre, Centurion, Electra, Sgl. Exh.
74-76 Bel Air, Caprice, Impala, Dual Exh. (Front)
1995 Cadillac DeVille

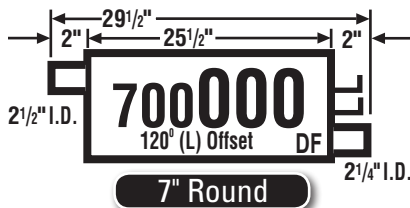

87-96 Econoline, E150/250/350



80-86 F Series
80-84 Bronco



86-89 Aerostar

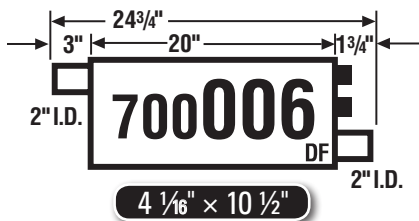

83-89 Grand Marquis, Dual Exh. (Left)
80-89 Crown Victoria, Dual Exh. (Left)
82-89 Town Car, Dual Exh. (Left)
80-82 LTD, Dual Exh. (Left)

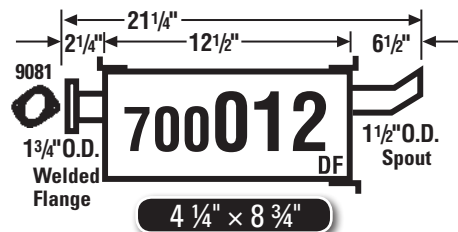

88-93 Festiva

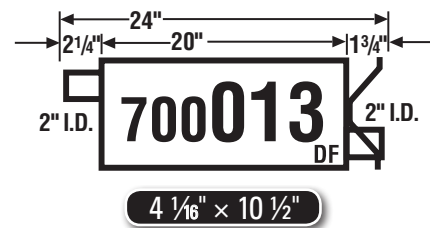

90-91 Crown Victoria, Grand Marquis, Sedan, Sta. Wag., Sgl. Exh., Dual Exh. (Right)

NOTE: Black area denotes welded head bracket.

DF-U - Denotes muffler used primarily as Direct Fit, but is also Universal.
U-DF - Denotes muffler used primarily as Universal, but is also Direct Fit.

DF - Direct Fit Muffler
U - Universal Muffler
HS - Denotes Heat Shield is on muffler.

FORD / LINCOLN / MERCURY

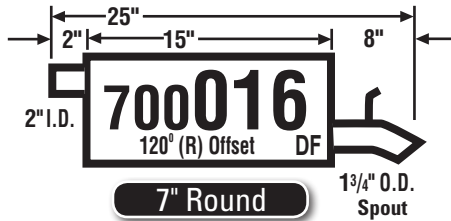

84-94 Tempo, Topaz

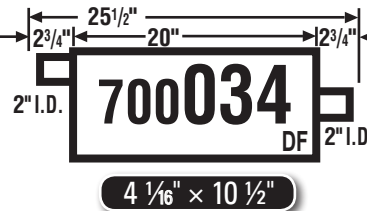

93-03 Ranger

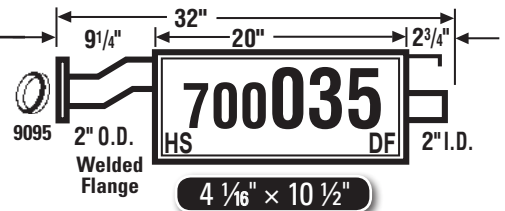

93-94 Explorer 2-Dr.

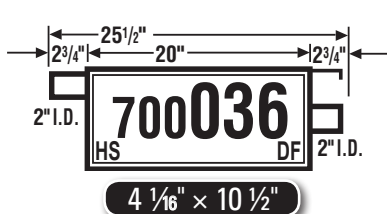

93-94 Explorer 4-Dr.

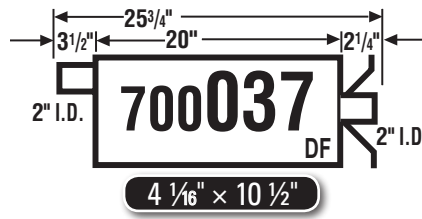

92-97 Crown Victoria, Town Car, Grand Marquis, Sgl. Exh., Dual Exh. (Right)

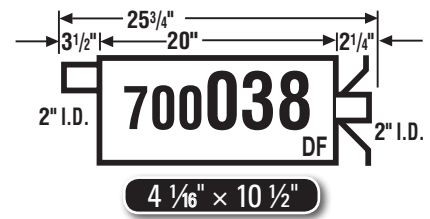

92-97 Crown Victoria, Town Car, Grand Marquis, Dual Exh., (Left)

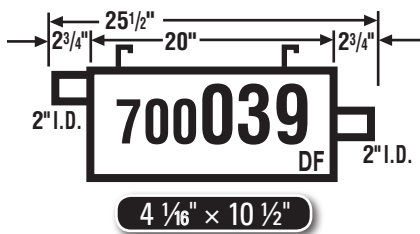

95-03 Ranger

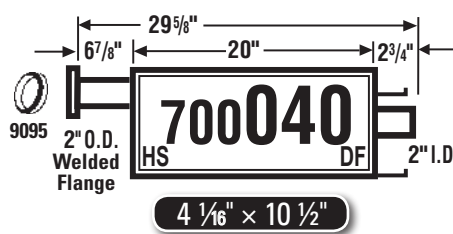

95-00 Explorer 2-Dr.

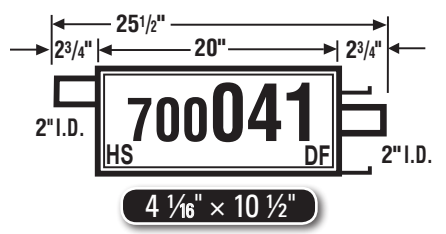

95-00 Explorer 4-Dr.

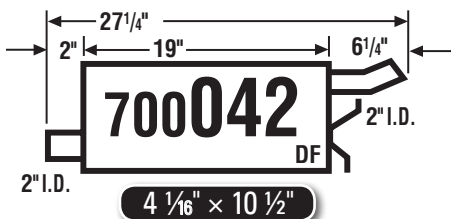

92-94 Crown Victoria, Grand Marquis Sedan, Sgl. Exh., Dual Exh. (Right)
90-94 Town Car, Sgl. Exh., Dual Exh. (Right)

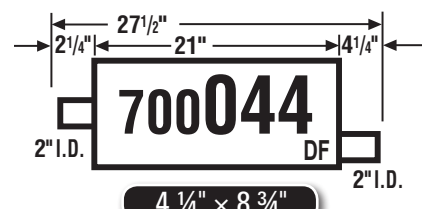

90-97 Aerostar

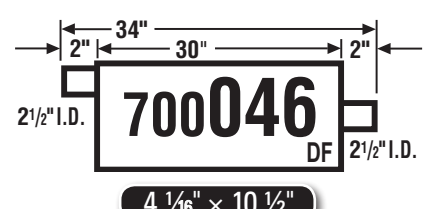

85-97 F250/350/450, Commercial Stripped Chassis, Motor Home

NOTE: Black area denotes welded head bracket.

DF-U - Denotes muffler used primarily as Direct Fit, but is also Universal.
U-DF - Denotes muffler used primarily as Universal, but is also Direct Fit.

DF - Direct Fit Muffler
U - Universal Muffler
HS - Denotes Heat Shield is on muffler.

FORD / LINCOLN / MERCURY

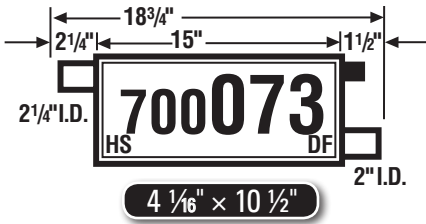

83-86 Thunderbird, Cougar



83-86 Ranger



84-86 E150/250/350, Econoline



84-86 E150/250/350

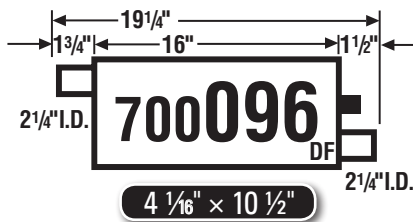

86-93 Mustang, GT, LX, Dual Exh. (Left)
1986 Capri, Dual Exh. (Left)

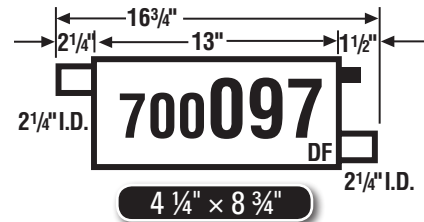

86-93 Mustang, GT, LX, Dual Exh. (Right)
1986 Capri, Dual Exh. (Right)

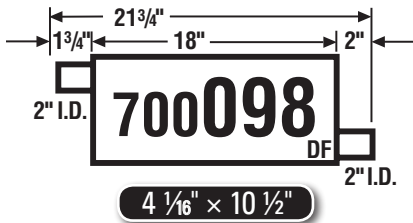

86-95 Taurus, Taurus SHO (86-95), Police Car (91-92), Sgl. Exh., Dual Exh. (Both Sides)

88-94 Continental, Sgl. Exh., Dual Exh. (Both Sides)

86-95 Sable Sedan, Sta. Wag.



87-96 F150/250
84-91 Bronco



87-92 Ranger

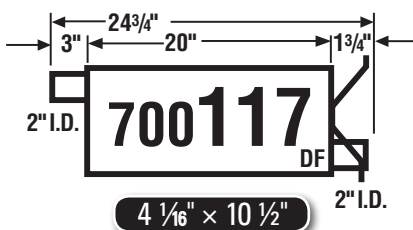

90-91 Crown Victoria, Grand Marquis Sedan, Sta. Wag., Dual Exh. (Left)

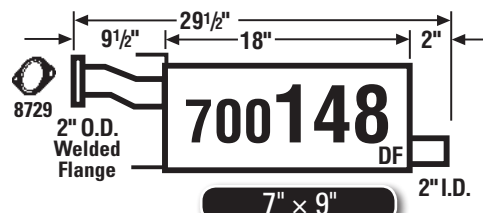

1993 Villager

NOTE: Black area denotes welded head bracket.

DF-U - Denotes muffler used primarily as Direct Fit, but is also Universal.
U-DF - Denotes muffler used primarily as Universal, but is also Direct Fit.

DF - Direct Fit Muffler
U - Universal Muffler
HS - Denotes Heat Shield is on muffler.

FORD / LINCOLN / MERCURY

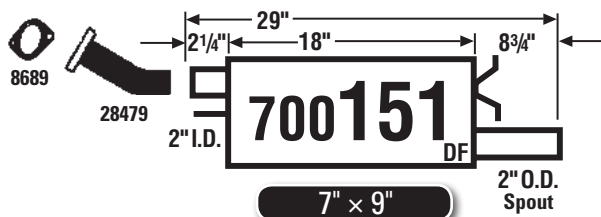

93-97 Probe

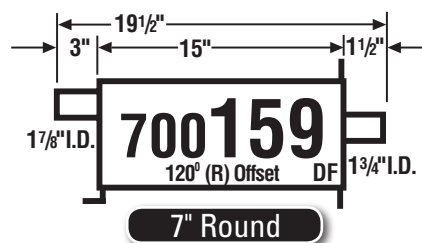

91-03 Escort, Sedan, Sta. Wag.
91-00 Tracer, Sedan, Sta. Wag.



91-92 Ranger

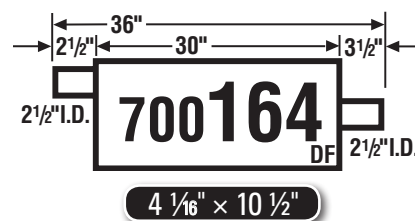

81-94 E250/350
1997 F450, 7.3L

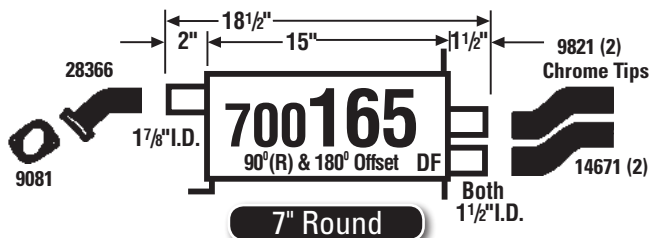

92-96 Escort, Tracer
91-96 Tracer LTS, Escort GT (1991)

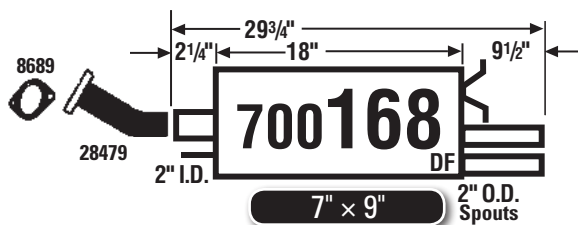

93-97 Probe GT

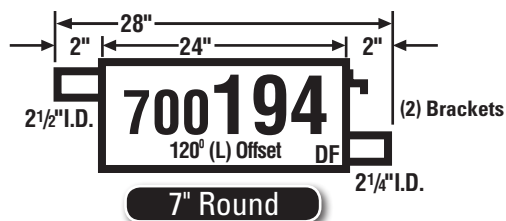

92-96 Econoline E150/250

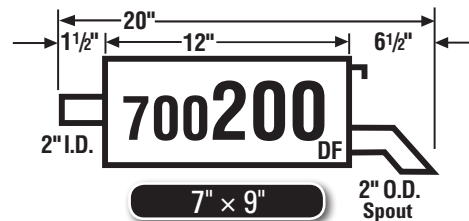

89-95 Thunderbird, Cougar
Sgl. Exh., Dual Exh. (Left)

NOTE: Black area denotes welded head bracket.

DF-U - Denotes muffler used primarily as Direct Fit, but is also Universal.

U-DF - Denotes muffler used primarily as Universal, but is also Direct Fit.

DF - Direct Fit Muffler

U - Universal Muffler

HS - Denotes Heat Shield is on muffler.

FORD / LINCOLN / MERCURY

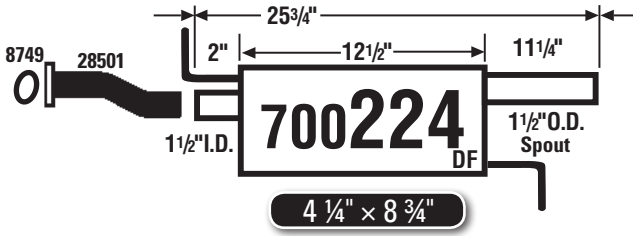

94-97 Aspire

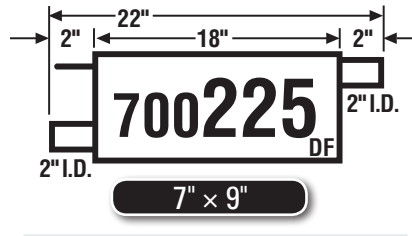

94-97 Villager

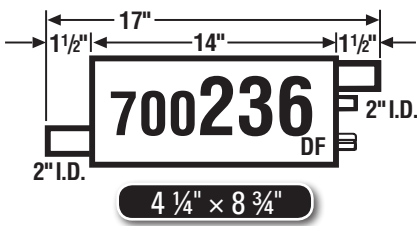

86-87 Continental, Dual Exh. (Right)
86-92 Mark VII, Dual Exh. (Right)

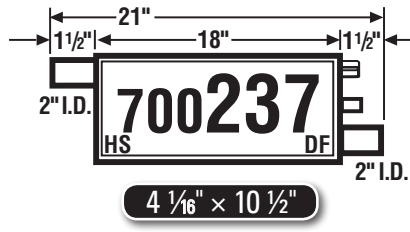

86-87 Continental, Dual Exh. (Left)
86-92 Mark VII, Dual Exh. (Left)

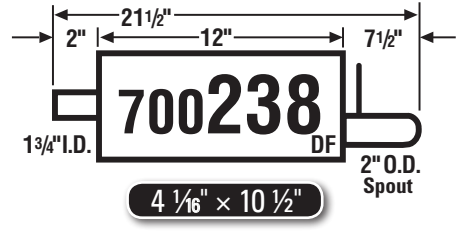

95-00 Contour, Mystique (Rear)

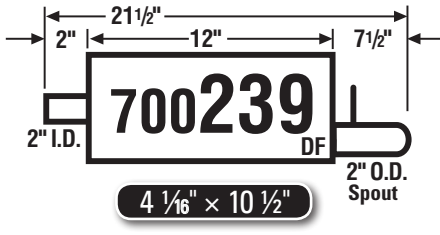

95-00 Contour, Mystique (Rear)

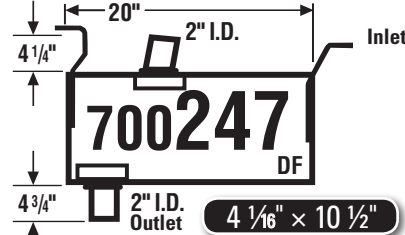

95-03 Windstar
04-07 Freestar, Monterey

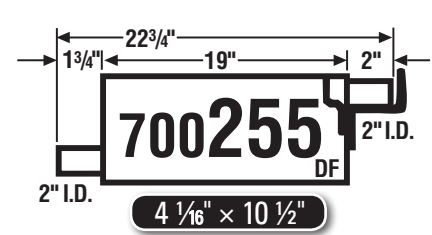

96-99 Taurus, Sable, Dual Exh. (Right)

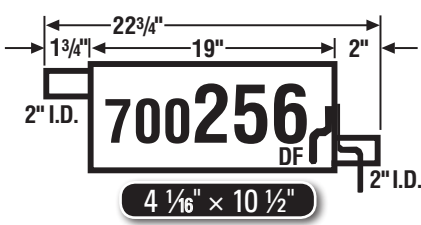

96-99 Taurus, Sable, Sgl. Exh.,
Dual Exh. (Left)

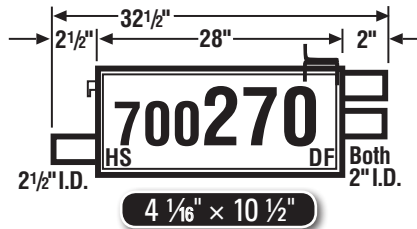

88-97 F250, F350 Series

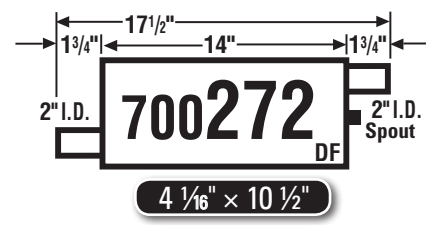

90-93 Mustang

NOTE: Black area denotes welded head bracket.

DF-U - Denotes muffler used primarily as Direct Fit, but is also Universal.
U-DF - Denotes muffler used primarily as Universal, but is also Direct Fit.

DF - Direct Fit Muffler
U - Universal Muffler
HS - Denotes Heat Shield is on muffler.

FORD / LINCOLN / MERCURY

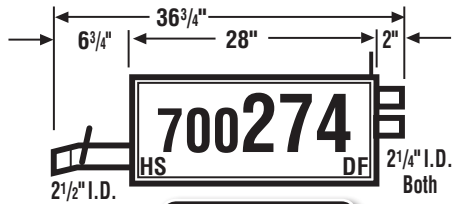

4 1/16" x 10 1/2"

94-96 E250, E350 Series; Econoline, exc. Cutway Van

88-93 E250, E350 Series; Econoline, exc. Cutway Van; exc. 1993 7.5L w/ Round Muffler

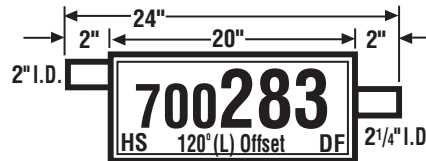

7" Round

1992 Ranger

91-92 Ranger; Super Cab

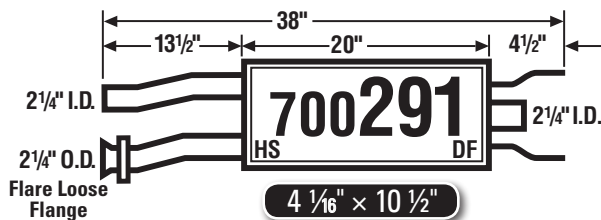

4 1/16" x 10 1/2"

97-00 Explorer 4 dr.

98-00 Moutaineer

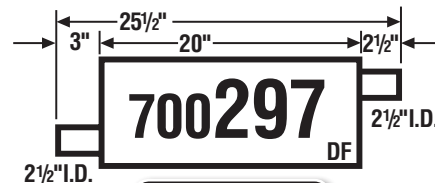

7" x 9"

97-04 F100, F150 Series

97-99 F250 Series

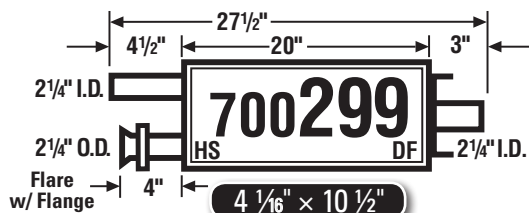

4 1/16" x 10 1/2"

97-00 Explorer 2 dr.

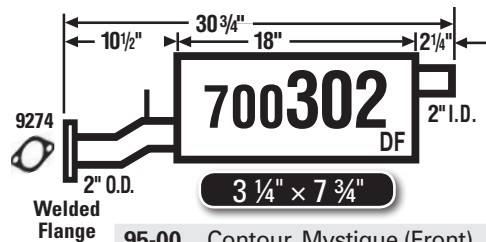

3 1/4" x 7 3/4"

95-00 Contour, Mystique (Front)



7" Round

97-03 E Series, Econoline

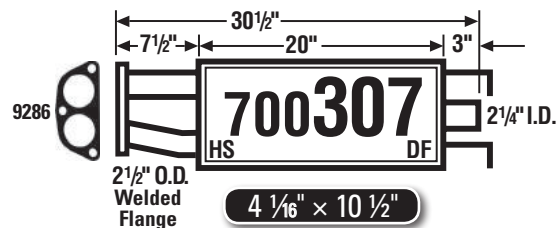

4 1/16" x 10 1/2"

96-98 Explorer 5.0L, 4 dr,

97-98 Moutaineer

NOTE: Black area denotes welded head bracket.

DF-U - Denotes muffler used primarily as Direct Fit, but is also Universal.

U-DF - Denotes muffler used primarily as Universal, but is also Direct Fit.

DF - Direct Fit Muffler

U - Universal Muffler

HS - Denotes Heat Shield is on muffler.

FORD / LINCOLN / MERCURY

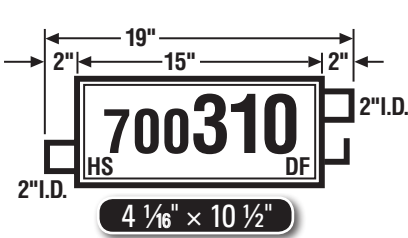

94-98 Mustang, 6 cyl.



95-98 Windstar (Rear)

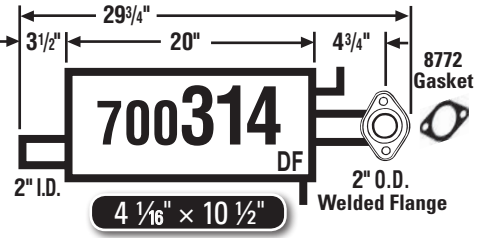

98-02 Full Size Models, Sgl. Exh, Dual Exh. (Right)

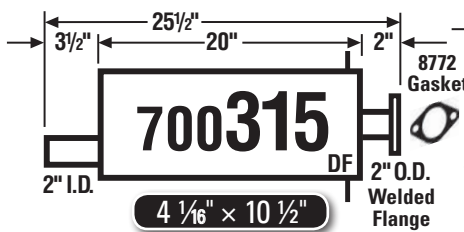

98-02 Full Size Models, Dual Exh. (Left)

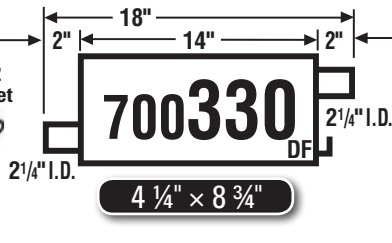

94-04 Mustang GT, Dual Exh (Left) SOHC
03-04 Mustang Mach I, Dual Exh (Left) DOHC
99-04 Mustang, 6 cyl. Single Exh

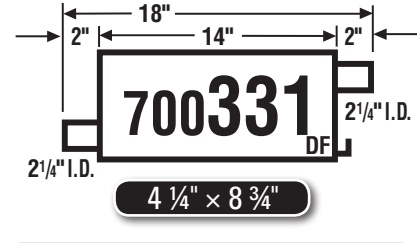

94-04 Mustang GT, Dual Exh (Right) SOHC
03-04 Mustang Mach I, Dual Exh (Right) DOHC

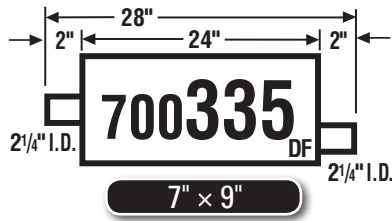

02-05 Explorer, Mountaineer

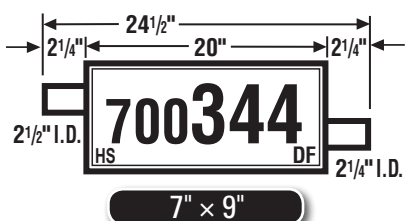

97-98 Expedition
1998 Navigator

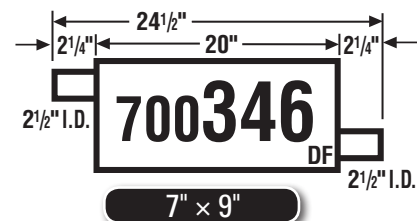

99-02 Expedition, Navigator

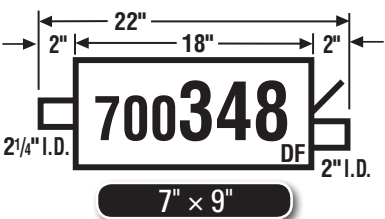

98-02 Villager (Rear)



1996 F150 (inc. Super Cab), 5.0L

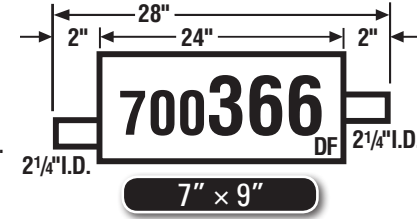

06-10 Explorer
01-10 Explorer Sport Trac
06-10 Mountaineer

NOTE: Black area denotes welded head bracket.

DF-U - Denotes muffler used primarily as Direct Fit, but is also Universal.
U-DF - Denotes muffler used primarily as Universal, but is also Direct Fit.

DF - Direct Fit Muffler
U - Universal Muffler
HS - Denotes Heat Shield is on muffler.

FORD / LINCOLN / MERCURY

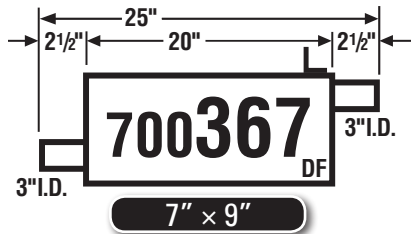

99-04 F250, F350, Super Duty

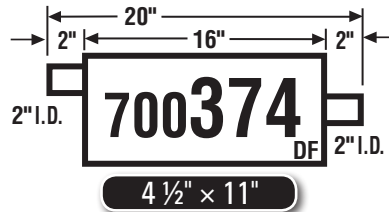

95-02 Continental, Dual Exh (Both)

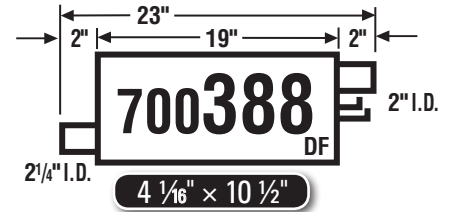

00-07 Taurus, Sable

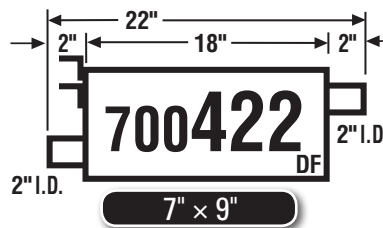

04-11 Ranger (exc. CA)

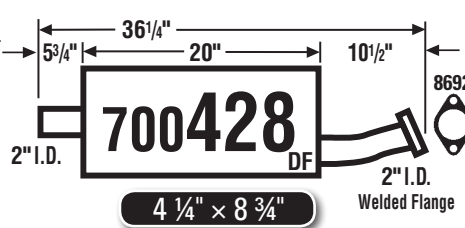

01-04 Escape

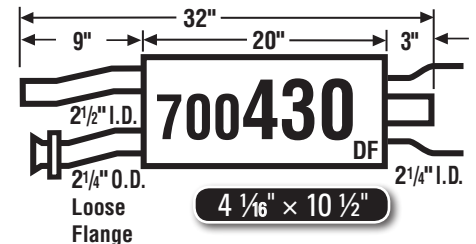

4/98-01 Explorer, Mountaineer, 4-Dr., 8 cyl.

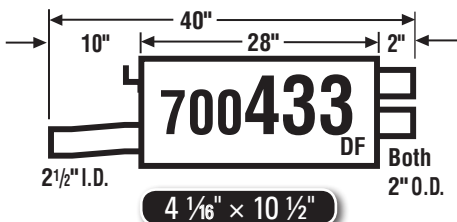

1992 F250
88-97 F350
88-93 F450

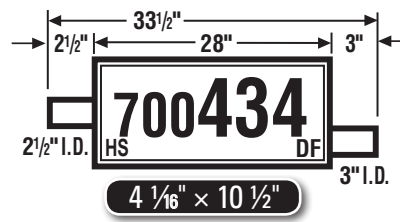

88-96 E350, 158" & 176" W.B.

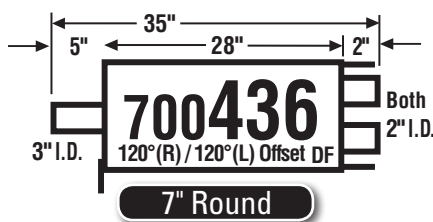

93-95 F350, F450 7.5L

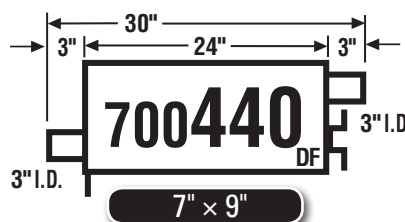

97-03 E150, E250, E350, 5.4L

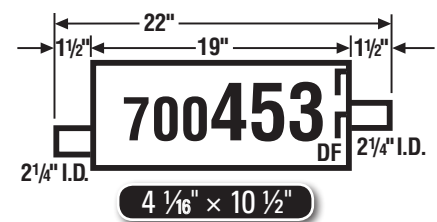

00-01 Explorer, 4.0L., 4-Dr. (From 12/99)
00-03 Explorer Sport, 4.0L., 2-Dr. (From 12/99)

NOTE: Black area denotes welded head bracket.

DF-U - Denotes muffler used primarily as Direct Fit, but is also Universal.
U-DF - Denotes muffler used primarily as Universal, but is also Direct Fit.

DF - Direct Fit Muffler
U - Universal Muffler
HS - Denotes Heat Shield is on muffler.

FORD / LINCOLN / MERCURY

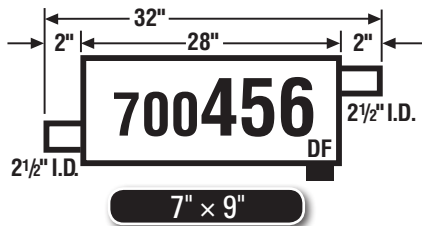

- 04-08 F150, 4.2L (exc. Heritage Series, Old Body Style)
- 04-08 F150, 4.6L & 5.4L (exc. Heritage Series, Old Body Style)
- 06-08 Mark LT, 5.4L

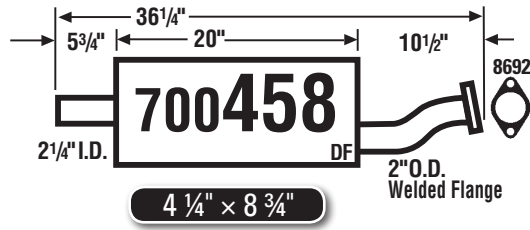

- 05-08 Escape, 2.3L
- 05-08 Escape, 3.0L
- 05-08 Mariner, 2.3L
- 05-08 Mariner, 3.0L
- 05-08 Tribute, 2.3L
- 05-08 Tribute, 3.0L

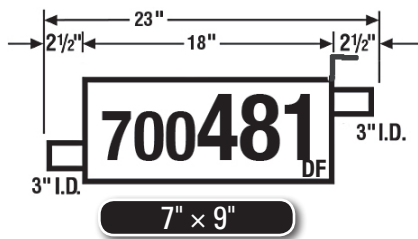

- 05-07 Ford, F-250 Super Duty, V10-6.8L, V8-5.4L
- 2005 Ford, F-350 Super Duty, V10-6.8L
- 2007 Ford, F-350 Super Duty, V10-6.8L
- 05-07 Ford, F-350 Super Duty, V8-5.4L

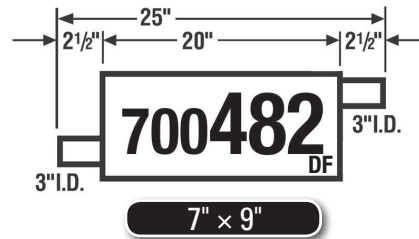

- 04-15 Ford, E-150, E-250, E-350 Super Duty, V8-5.4L
- 2004 Ford, E150 Club Wagon, V8-5.4L
- 04-05 Ford, E-250 Super Duty, E-350 Club Wagon, V8-5.4L
- 00-05 Ford, Excursion, V8-5.4L, V10-6.8L

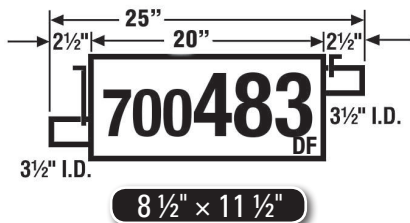

- 99-03 Ford, F-250 Super Duty, F-350 Super Duty, V8-7.3L

NOTE: Black area denotes welded head bracket.

DF-U - Denotes muffler used primarily as Direct Fit, but is also Universal.
 U-DF - Denotes muffler used primarily as Universal, but is also Direct Fit.

DF - Direct Fit Muffler
 U - Universal Muffler
 HS - Denotes Heat Shield is on muffler.

GENERAL MOTORS

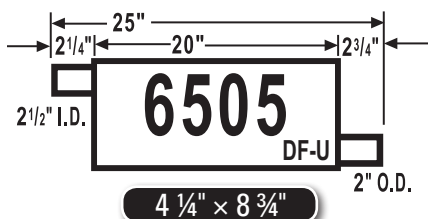

- 69-84** C, K, P Series, 1/2 - 1 Ton
- 75-80** Blazer, Jimmy

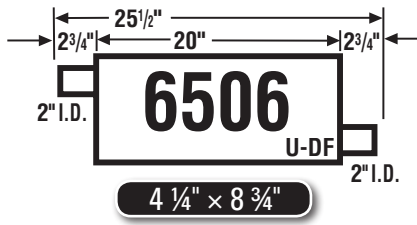

- 71-72** Bel Air, Biscayne, Impala
- 70-72** Chevelle, Tempest, All Models
- 70-72** Sprint

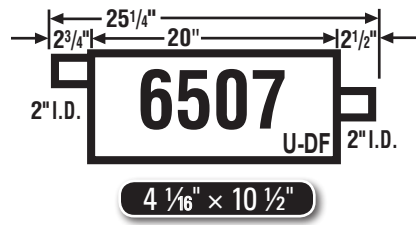

- 73-74** Chevelle, LeMans, Grand Prix, GTO
- 73-74** Sprint
- 1973** All Models



- 67-71** 10, 20, 30 Series (exc. Carryall), 1/2 - 2 Ton Series
- 67-70** C Series
- 67-68** G Series
- 67-71** P Series

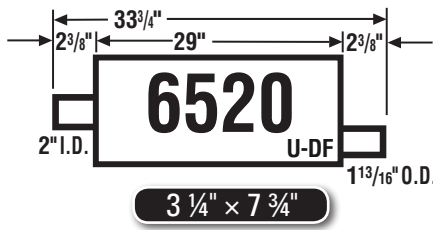

- 58-64** Chev. 6-8 cyl. All Models, exc. Hi. Performance
- 58-59** Series 5,000-10,000
- 54-57** Chev. 6-8 cyl. (exc. Conv.)

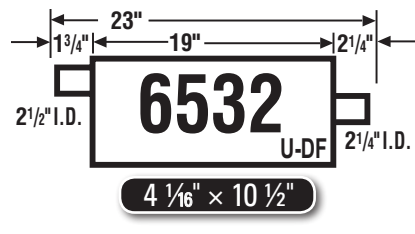

- 71-74** Cadillac 8 cyl. All Models (Front)

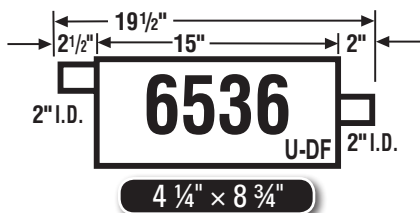

- 75-80** Monza, Starfire, Sunbird

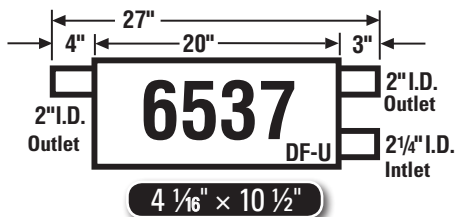

- 75-81** Camaro, Firebird
- 75-79** Apollo, Skylark, Chevy II, Nova, Omega, Ventura II, Phoenix

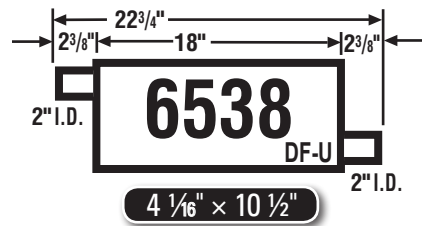

- 86-87** Century, Celebrity, Cutlass, 6000
- 82-86** Firebird
- 82-86** Camaro
- 80-85** GM Full Size

NOTE: Black area denotes welded head bracket.

DF-U - Denotes muffler used primarily as Direct Fit, but is also Universal.

U-DF - Denotes muffler used primarily as Universal, but is also Direct Fit.

DF - Direct Fit Muffler

U - Universal Muffler

HS - Denotes Heat Shield is on muffler.

GENERAL MOTORS



4 1/16" x 10 1/2"

- 78-87 Regal, Cutlass, Century, Bonneville, Grand Prix
- 78-84 Malibu, Monte Carlo, El Camino, Caballero
- 78-81 Century, LeMans, Grand AM

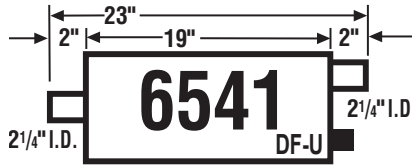

4 1/16" x 10 1/2"

- 80-85 Eldorado, Seville
- 79-85 Riviera, Toronado



4 1/16" x 10 1/2"

- 84-96 Century, Cutlass Ciera
- 85-91 6000
- 85-90 Celebrity
- 77-90 GM Full Size
- 1985 Cad. Full Size
- 79-82 Cad. Full Size



4 1/16" x 10 1/2"

- 79-87 Chevette, T1000

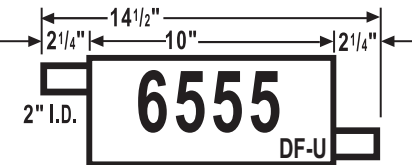

3 1/4" x 7 3/4"

- 77-81 Camaro, Z28
- 78-81 Firebird, Trans AM



4 1/16" x 10 1/2"

- 80-87 Blazer, Jimmy
- 80-87 C, K, R, V, Suburban Series, 1/2 - 3/4 Ton

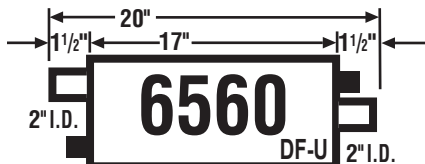

4 1/16" x 10 1/2"

- 84-94 Cavalier, Sunbird
- 86-91 Skylark
- 85-91 Calais, Grand AM
- 84-89 Skyhawk, Cimarron
- 84-88 Firenza
- 85-87 Somerset, Somerset Regal (Rear Exit Only With Spout Welded To Muffler - see 700060)

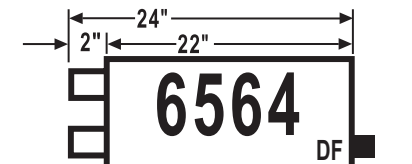

4 1/16" x 10 1/2"

- 84-86 Century, Celebrity, Cutlass Ciera, 6000

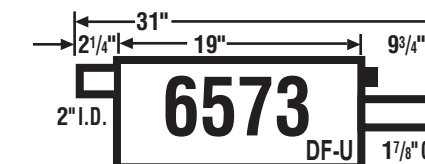

4 1/16" x 10 1/2"

- 82-87 Century, Celebrity, Cutlass Ciera, 6000

NOTE: Black area denotes welded head bracket.

DF-U - Denotes muffler used primarily as Direct Fit, but is also Universal.

U-DF - Denotes muffler used primarily as Universal, but is also Direct Fit.

DF - Direct Fit Muffler

U - Universal Muffler

HS - Denotes Heat Shield is on muffler.

GENERAL MOTORS

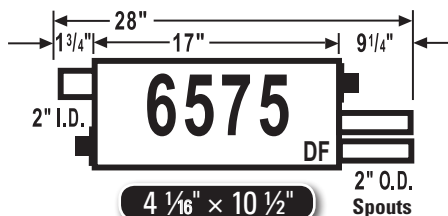

- 84-91 Sunbird
- 84-89 Cavalier, Skyhawk
- 86-88 Skylark
- 85-88 Calais
- 84-88 Firenza
- 85-87 Somerset, Somerset Regal, Grand AM

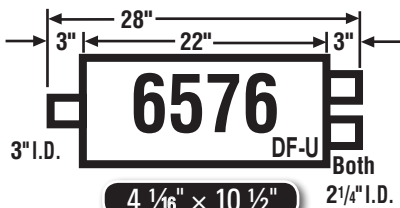

- 91-95 C2500, K2500, C3500, K3500
- 91-93 C1500



- 86-91 GM Full Size, Riviera, Toronado
- 86-87 Eldorado, Seville

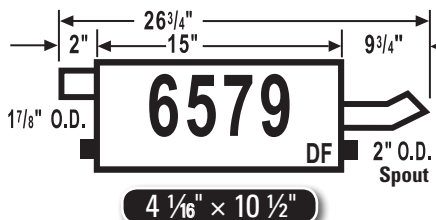

- 90-93 Lumina
- 88-93 Regal, Cutlass Supreme, Grand Prix

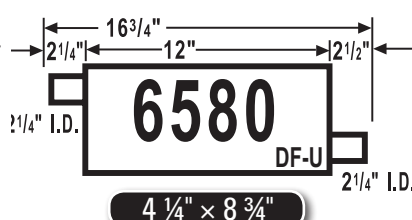

- 75-79 Seville

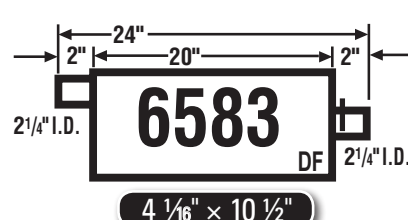

- 85-91 Astro, Safari Van

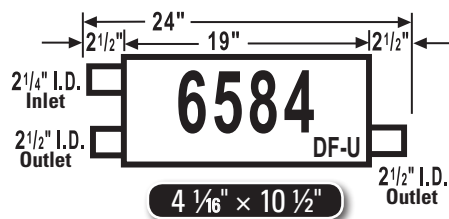

- 88-92 Camaro, Firebird

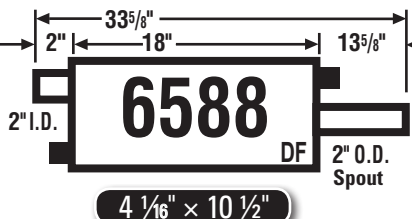

- 87-92 Beretta, Corsica
- 87-91 Pontiac Tempest (Canada)

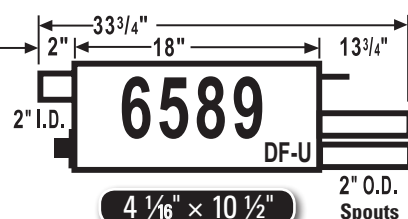

- 87-92 Beretta, Corsica
- 90-91 Pontiac Tempest (Canada)

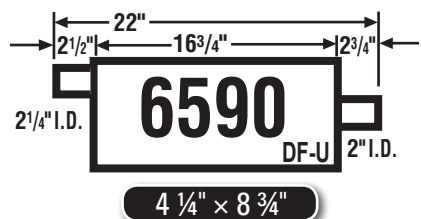

- 82-91 S10/S15, T10/T15
- 83-89 Blazer, Jimmy

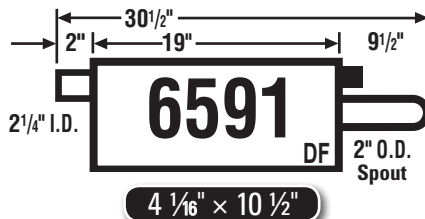

- 84-92 Century, Cutlass Ciera
- 86-91 6000
- 86-89 Celebrity

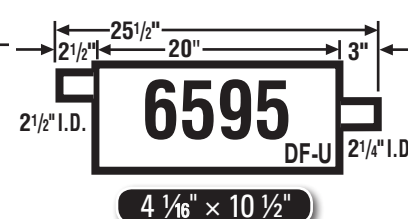

- 1982 G Series Van
- 1978 Toronado
- 75-77 GM Full Size, Century, Cutlass, LeMans, Grand Prix

NOTE: Black area denotes welded head bracket.

DF-U - Denotes muffler used primarily as Direct Fit, but is also Universal.

U-DF - Denotes muffler used primarily as Universal, but is also Direct Fit.

DF - Direct Fit Muffler

U - Universal Muffler

HS - Denotes Heat Shield is on muffler.

GENERAL MOTORS

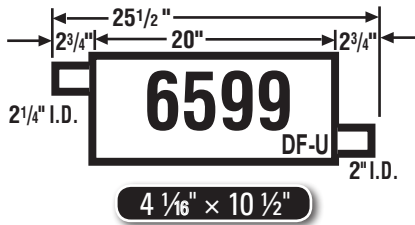

- 71-73 Chev. Full Size, Sgl. Exh. (71-72); All Models w/ Dual Exh., exc. Sta. Wag. (Front)
- 71-72 Delta 88, Catalina, Sgl. Exh., exc. Sta. Wag.
- 68-72 F85 Series, Vista Cruiser
- 65-72 3300/3400/3435/4000/4400/4600 Series, Catalina, Skylark, LeSabre
- 1969 Sportswagon, Special
- 65-68 3000 Series
- 66-67 F85 Series, Dual Exh., exc. model 442 (Right)
- 65-66 6000/8000 Series, Electra, Wildcat, Dual Exh. (both sides, front)
- 1965 Model 442 (Both Sides)
- 1965 Catalina, Sgl. Exh., exc. Sta. Wag., All Models w/Dual Exh. (Both Sides)
- 75-78 G Series Van

- 75-82 Luv

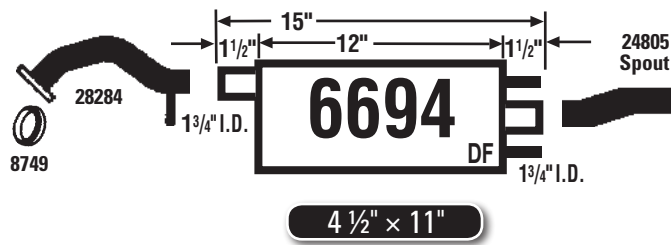

- 90-92 Geo Prizm (Welded Assembly Available)

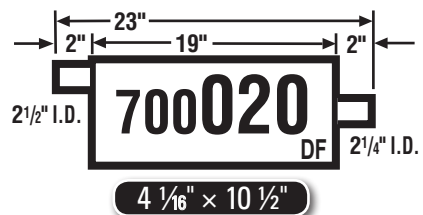
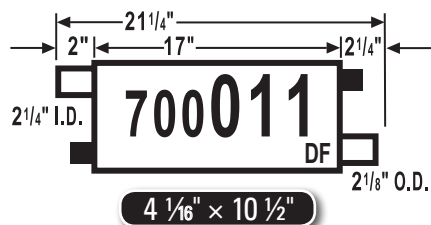
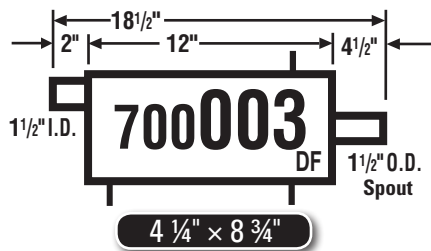

- 89-94 Geo Metro
- 89-94 Chevrolet Sprint (Canada)

- 87-89 Cavalier Z24

- 88-04 T10/T15
- 88-95 S10/S15
- 88-91 Blazer, Jimmy
- 1991 Bravada
- 88-04 Sonoma

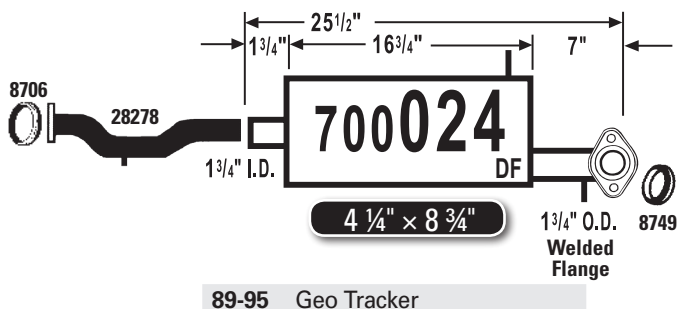

- 89-95 Geo Tracker

NOTE: Black area denotes welded head bracket.

DF-U - Denotes muffler used primarily as Direct Fit, but is also Universal.
 U-DF - Denotes muffler used primarily as Universal, but is also Direct Fit.

DF - Direct Fit Muffler
 U - Universal Muffler
 HS - Denotes Heat Shield is on muffler.

GENERAL MOTORS

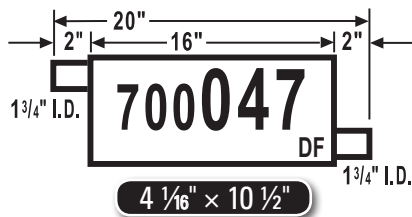

- 82-84 Skyhawk, Cimarron
- 82-84 Cavalier, Firenza
- 82-84 J2000, Sunbird

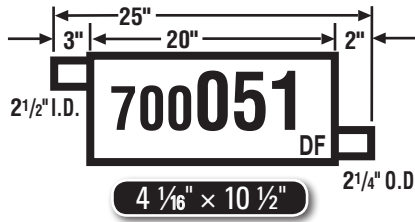

- 88-93 C1500/2500, K1500/2500
- 83-93 G20/2500, G30/3500
- 82-90 P30/3500
- 85-87 C10/1500, C20/2500, K10/1500, R10/1500, R20/2500, V10/1500
- 81-85 Suburban
- 75-85 Series C, K
- 78-84 C Series, K30/3500
- 80-82 Blazer, Jimmy
- 75-82 C10/1500, C30/3500, K Series
- 1979 Suburban

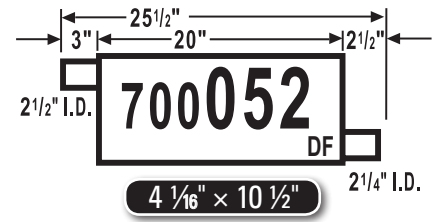

- 75-94 G Series Van
- 71-73 Chev. Full Size Models

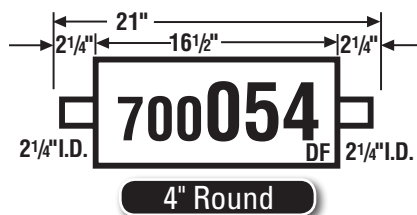

- 77-90 LeSabre, Estate Wagon
- 86-90 Caprice Sta. Wagon
- 81-85 Caprice, Impala, Sta. Wag.
- 77-90 Delta 88 (77-79), Custom Cruiser (80-90)
- 87-89 Safari Sta. Wag.
- 83-86 Parisienne Sta. Wag.
- 77-81 Catalina, Bonneville, Sta. Wag., Safari Sta. Wag. (1981)

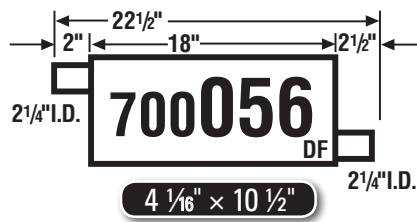

- 83-90 Estate Wagon
- 80-85 Buick Full Size
- 81-84 Electra, Park Avenue (exc. Estate Wagon)
- 77-81 LeSabre
- 77-79 Electra, Riviera
- 81-90 Brougham (86-90), Fleetwood Brougham
- 81-85 Fleetwood, DeVille
- 77-82 Cad. Full Size
- 81-90 Caprice, Impala (81-85)
- 86-90 Custom Cruiser
- 77-85 Delta 88, 98
- 83-89 Parisienne (83-86), Safari Sta. Wag. (87-89)
- 77-81 Catalina, Bonneville

NOTE: Black area denotes welded head bracket.

DF-U - Denotes muffler used primarily as Direct Fit, but is also Universal.

U-DF - Denotes muffler used primarily as Universal, but is also Direct Fit.

DF - Direct Fit Muffler

U - Universal Muffler

HS - Denotes Heat Shield is on muffler.

GENERAL MOTORS

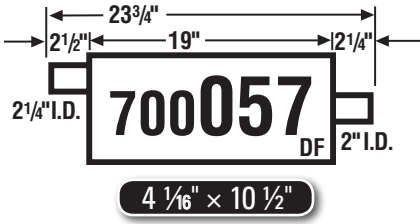

- 78-87 Century, Regal
- 78-88 Chevelle, Monte Carlo
- 78-87 El Camino, Malibu
- 79-87 Caballero
- 78-88 Cutlass, Cutlass Cruiser Sta. Wag. (80-81)
- 79-87 Bonneville (82-86), Grand Prix
- 79-81 LeMans, Grand AM

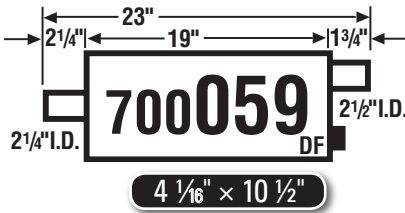

- 79-85 Eldorado, Seville (80-85)

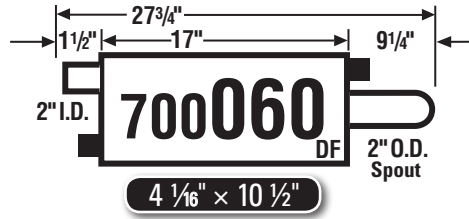

- 84-94 Cavalier, Sunbird
- 86-91 Skylark
- 85-91 Calais, Grand AM
- 84-89 Skyhawk
- 84-88 Cimarron, Firenza
- 85-87 Somerset, Somerset Regal (Rear Exit Only)

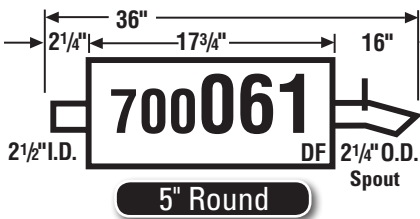

- 80-81 Riviera
- 79-85 Eldorado, Seville
- 79-81 Toronado

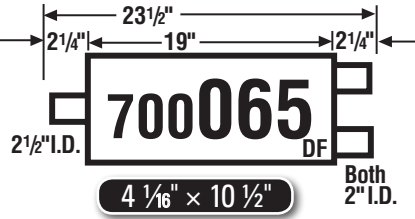

- 80-94 G Series
- 82-88 P30/P3500

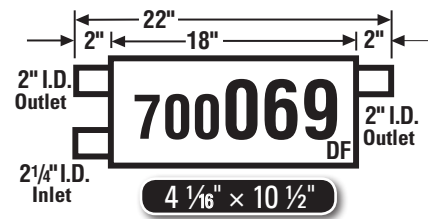

- 85-90 Camaro, Firebird
- 82-87 Camaro, Berlinetta (exc. Z28)
- 82-87 Firebird (exc. Trans AM)

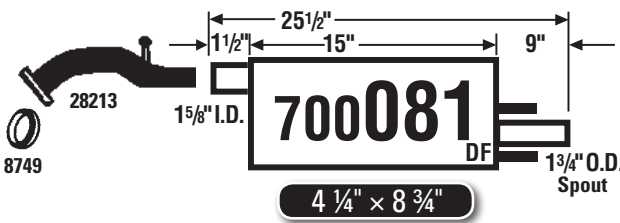

- 85-88 Nova

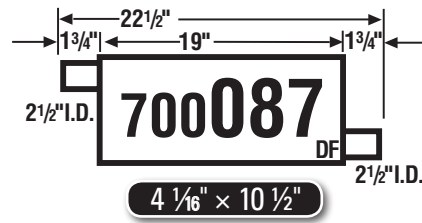

- 91-93 Roadmaster (Front)
- 90-93 Brougham, Fleetwood Brougham (Front)
- 85-93 Caprice, Impala (Front)
- 91-92 Custom Cruiser (Front)
- 85-86 Parisienne (Front)

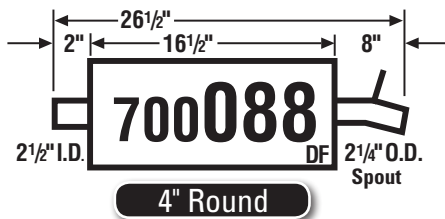

- 90-92 Brougham (Rear)
- 85-89 Caprice, Impala, Sedan (Rear)
- 85-86 Parisienne Sedan (Rear)

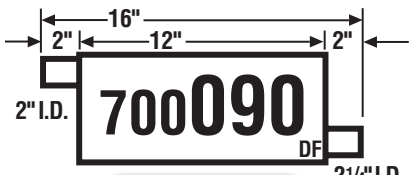

- 83-88 Monte Carlo SS Dual Exh. (Both Sides)

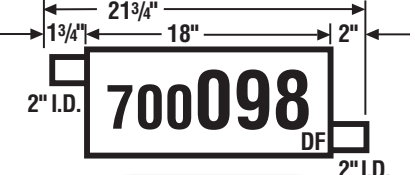

- 03-08 Pontiac Vibe

NOTE: Black area denotes welded head bracket.

DF-U - Denotes muffler used primarily as Direct Fit, but is also Universal.
 U-DF - Denotes muffler used primarily as Universal, but is also Direct Fit.

DF - Direct Fit Muffler
 U - Universal Muffler
 HS - Denotes Heat Shield is on muffler.

GENERAL MOTORS

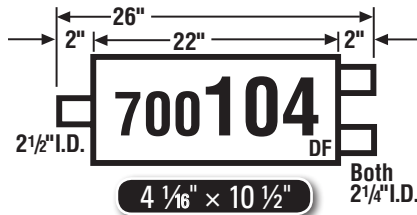

- 90-93 C1500, C2500, K1500, K2500
- 1990 C2500/K2500
- 88-90 Series C, K

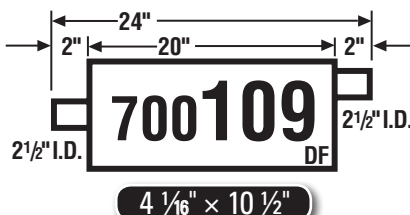

- 87-89 Blazer, Jimmy
- 87-88 V10/V1500, Suburban
- 1987 R10/R1500, R20/R2500



- 1992 Roadmaster Sedan
- 90-92 Caprice, exc. Sta. Wag.

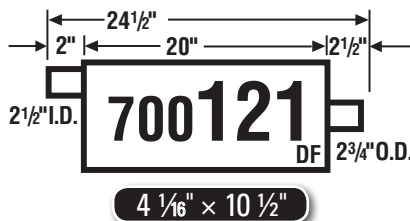

- 90-91 Blazer, Jimmy
- 88-91 V10/V1500, V20/2500, Suburban
- 88-90 R10/R1500, R20/R2500

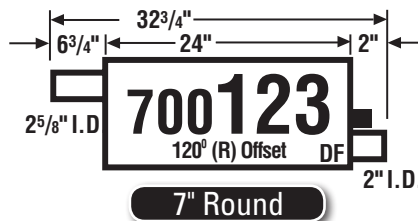

- 90-91 Lumina APV, Silhouette, Trans Sport

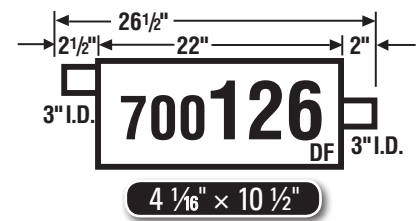

- 1991 G Series
- 88-95 C/K Series

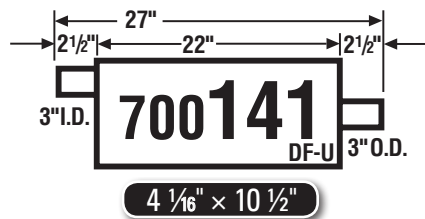

- 87-96 P30/P3500
- 87-89 G30/G3500, R20/R2500, R30/R3500, V20/V2500, V30/V3500

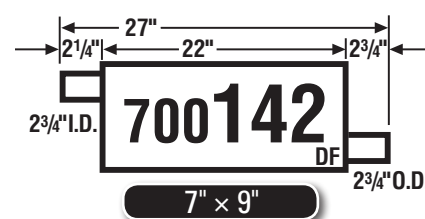

- 94-95 C1500/2500, K1500/2500

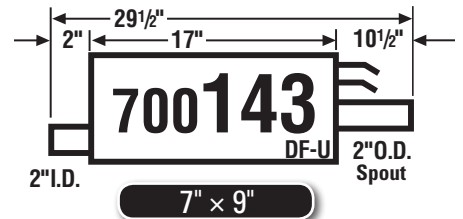

- 94-96 Century, Cutlass Ciera, exc. Sta. Wag.

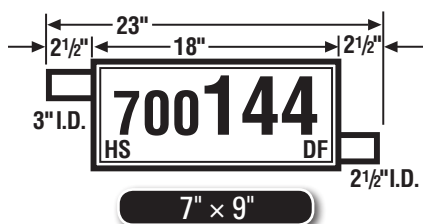

- 92-95 Astro/Safari Van

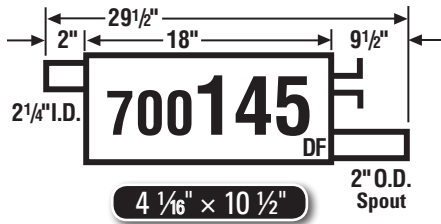

- 1993 Century, Cutlass Ciera, Sedan

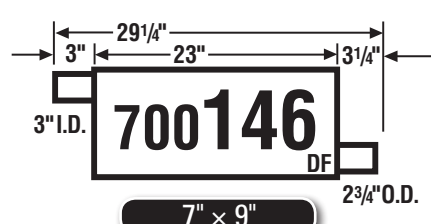

- 92-96 G Series Van

NOTE: Black area denotes welded head bracket.

DF-U - Denotes muffler used primarily as Direct Fit, but is also Universal.

U-DF - Denotes muffler used primarily as Universal, but is also Direct Fit.

DF - Direct Fit Muffler

U - Universal Muffler

HS - Denotes Heat Shield is on muffler.

GENERAL MOTORS

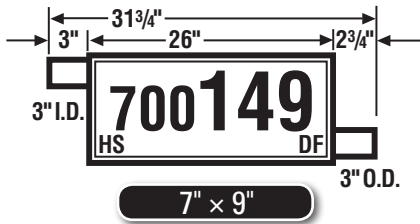

92-93 C1500/2500, K1500/2500, Suburban

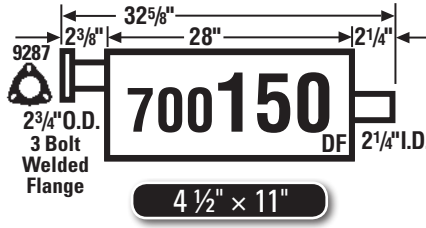

95-99 S10/T10, Blazer/Jimmy, 4-Dr.
96-99 Bravada

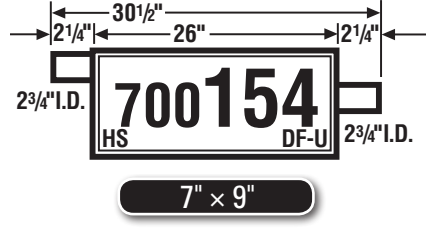

94-95 C1500/2500, K1500/2500, Suburban

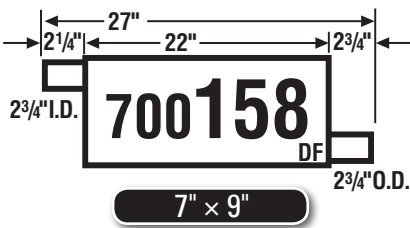

94-95 C1500/2500, K1500/2500

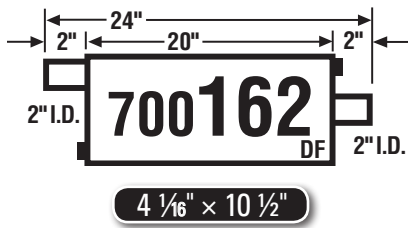

92-94 Skylark, Achieva, Grand AM
93-94 Beretta, Corsica, exc. Beretta GT/GTZ, Z26



1992 Astro/Safari Van

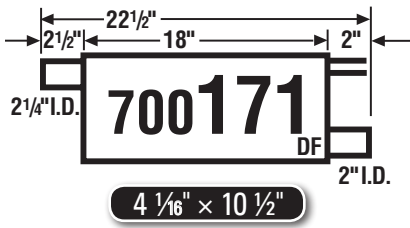

94-96 Roadmaster, Fleetwood Brougham (RWD), Caprice (Dual Exh., all Front Right) Caprice (Sgl. Exh., and Dual Exh.)

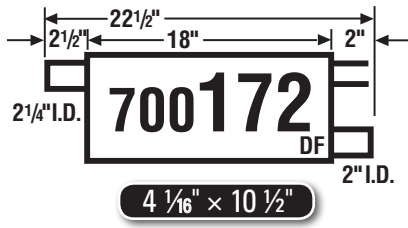

94-96 Roadmaster, Fleetwood Brougham (RWD), Caprice (Dual Exh., all Front Left)

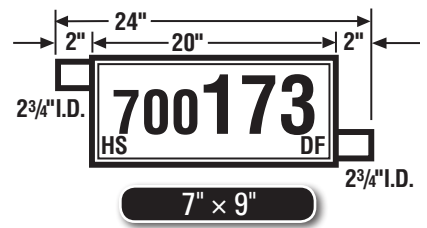

94-95 Tahoe/Yukon

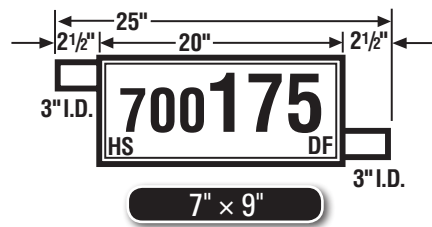

92-93 Blazer/Yukon

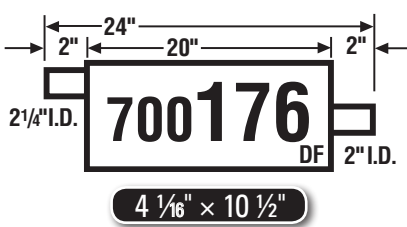

92-94 S10/S15 Pickup

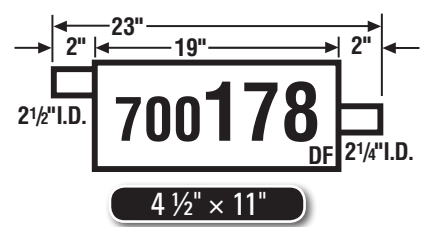

92-94 Bravada 4 WD
92-94 Blazer/Jimmy 2 WD (S10/S15), 4 WD (T10/T15)

NOTE: Black area denotes welded head bracket.

DF-U - Denotes muffler used primarily as Direct Fit, but is also Universal.
U-DF - Denotes muffler used primarily as Universal, but is also Direct Fit.

DF - Direct Fit Muffler
U - Universal Muffler
HS - Denotes Heat Shield is on muffler.

GENERAL MOTORS

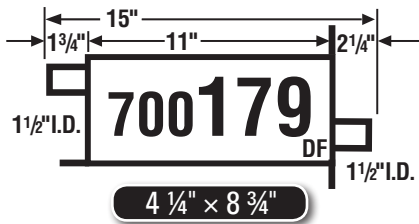

- 95-97 Geo Metro
- 98-01 Chev. Metro
- 95-01 Pontiac Firefly (Canada)

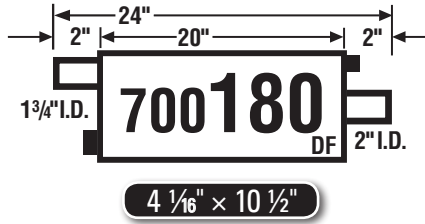

- 92-94 Skylark, Achieva, Grand AM; Quad OHC

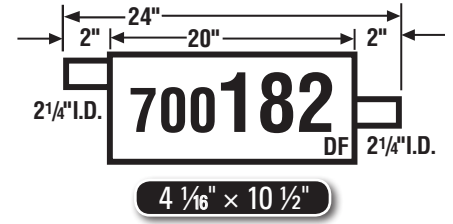

- 95-03 S10/S15 Pickup



- 1995 G Series

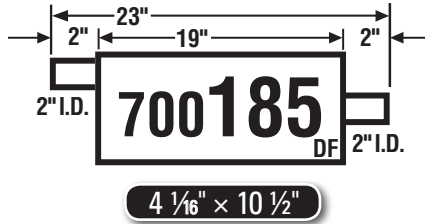

- 95-05 Cavalier, Sunfire
- 95-99 DeVille, Eldorado, Dual Exh. (Both Sides)
- 95-98 Skylark, Achieva, Grand AM
- 95-97 Seville, Dual Exh. (Both Sides)
- 95-96 Beretta/Corsica

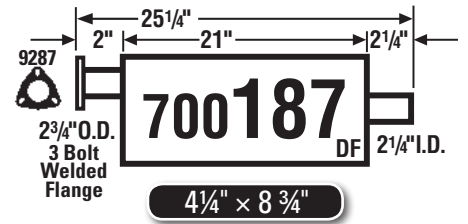

- 95-99 S10/T10, Blazer/Jimmy, 2-Dr.

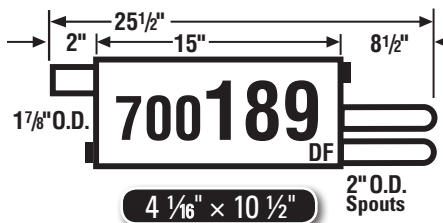

- 90-93 Lumina, Sport Exh.
- 88-89 Cutlass Ciera, Sport Exh.

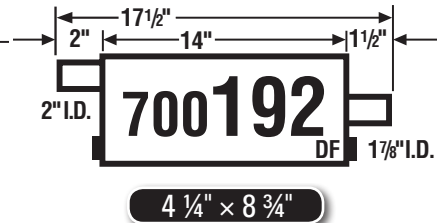

- 90-92 Cutlass Supreme, Grand Prix; (Right)

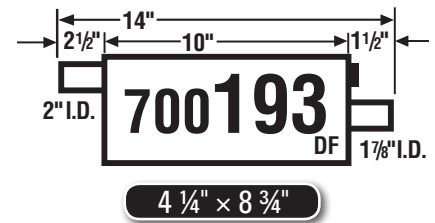

- 90-92 Cutlass Supreme, Grand Prix; (Left)

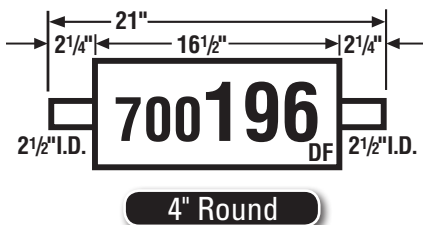

- 91-93 Roadmaster Estate Sta. Wag., Caprice Sta. Wag.
- 91-92 Custom Cruiser
- 85-86 Caprice/Impala Sta. Wag., Parisienne Sta. Wag.

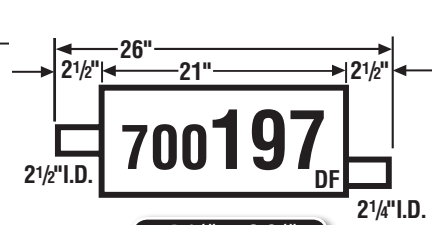

- 92-93 LeSabre, 88, Bonneville SE

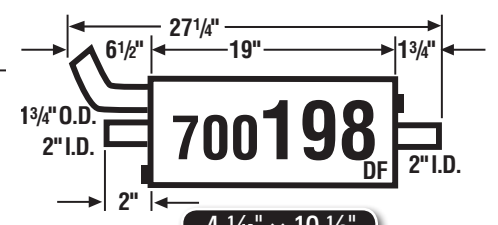

- 92-94 Achieva, Grand AM (Left)

NOTE: Black area denotes welded head bracket.

DF-U - Denotes muffler used primarily as Direct Fit, but is also Universal.
 U-DF - Denotes muffler used primarily as Universal, but is also Direct Fit.

DF - Direct Fit Muffler
 U - Universal Muffler
 HS - Denotes Heat Shield is on muffler.

GENERAL MOTORS

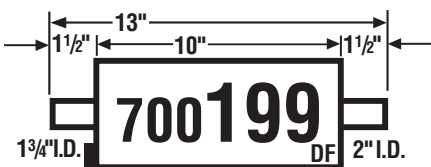

4 1/4" x 8 3/4"

92-94 Achieva, Grand AM (Right)



7" x 9"

94-95 C/K 1500/2500, Suburban; 2 WD/4 WD, with 3" Inlet



4 1/16" x 10 1/2"

87-88 V10/1500, V20/2500, Suburban; 4 WD, with 3" Inlet

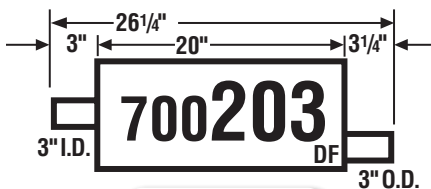

4 1/16" x 10 1/2"

87-88 R10/1500, R20/2500, Suburban; 2 WD, with 3" Inlet



4 1/16" x 10 1/2"

87-90 G10, G20, G30/G1500, G2500, G3500, with 3" Inlet

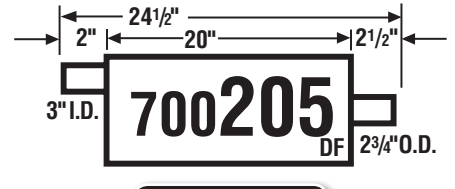

4 1/16" x 10 1/2"

88-91 V10/1500, V20/2500, Suburban; 4 WD, with 3" Inlet
88-90 R10/1500, R20/2500, Suburban; 2 WD, with 3" Inlet

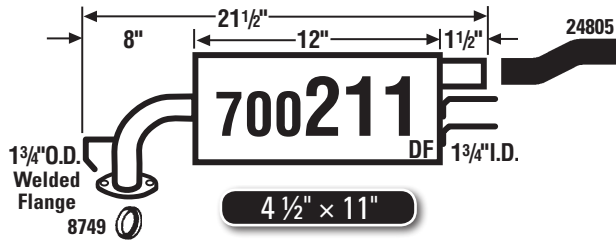

4 1/2" x 11"

93-97 Geo Prizm, Prizm LSI (Welded Assembly Available)

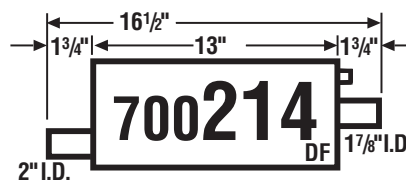

7" x 9"

93-94 Chev. Lumina, Dual Exh. (Left)
93-96 Grand Prix, Dual Exh. (Left)

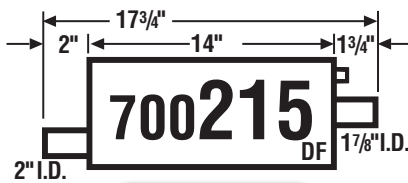

4 1/4" x 8 3/4"

1993 Cutlass Supreme, Dual Exh. (Right)
93-96 Grand Prix, Dual Exh. (Right)

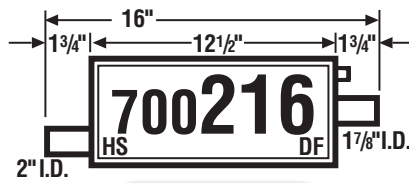

4 1/4" x 8 3/4"

1993 Cutlass Supreme, Dual Exh. (Left)
93-96 Grand Prix, Dual Exh. (Left)



4 1/16" x 10 1/2"

93-02 Camaro, Firebird

NOTE: Black area denotes welded head bracket.

DF-U - Denotes muffler used primarily as Direct Fit, but is also Universal.
U-DF - Denotes muffler used primarily as Universal, but is also Direct Fit.

DF - Direct Fit Muffler
U - Universal Muffler
HS - Denotes Heat Shield is on muffler.

GENERAL MOTORS

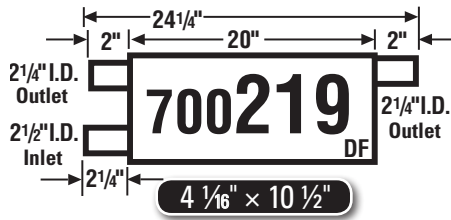

93-02 Camaro, Firebird

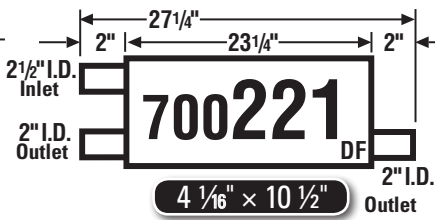

1992 Eldorado, Seville

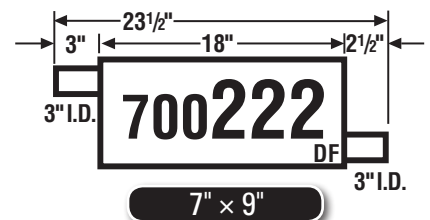

90-95 C3500, K3500

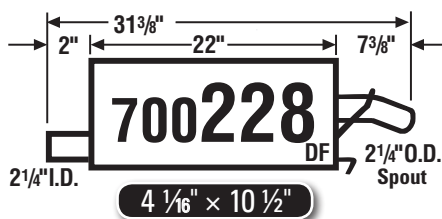

1994 DeVille

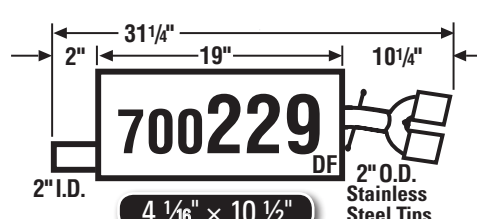

93-94 Eldorado, Seville, Dual Exh. (Right)

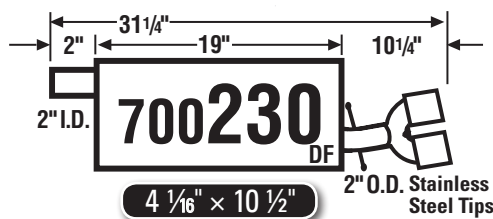

93-94 Eldorado, Seville, Dual Exh. (Left)

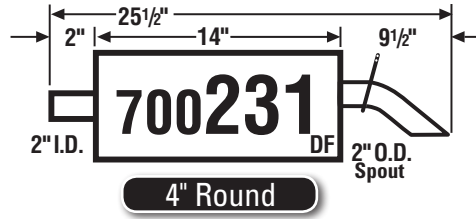

94-96 Roadmaster, Caprice, Sedan, Sgl. Exh. (Rear), Dual Exh. (Right Rear)



94-96 Roadmaster, Caprice, Sedan, Dual Exh. (Left Rear)

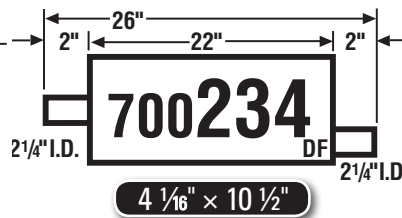

02-07 Rendezvous
01-05 Aztek
94-99 LeSabre, 88, Bonneville

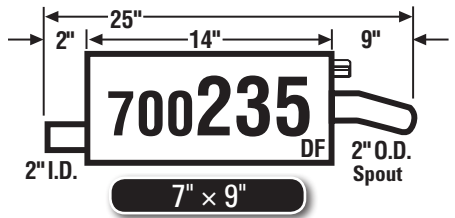

94-96 Regal, Grand Prix
1994 Lumina
94-97 Cutlass Supreme

NOTE: Black area denotes welded head bracket.

DF-U - Denotes muffler used primarily as Direct Fit, but is also Universal.
U-DF - Denotes muffler used primarily as Universal, but is also Direct Fit.

DF - Direct Fit Muffler
U - Universal Muffler
HS - Denotes Heat Shield is on muffler.

GENERAL MOTORS

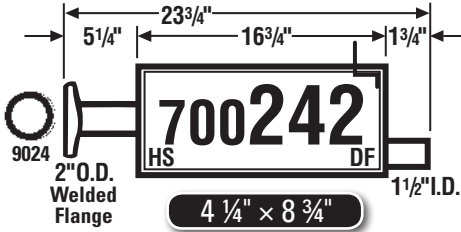

1998 Chev./GMC Tracker, 2-Dr. Models
94-97 Geo Tracker, 2-Dr. & Convertibles

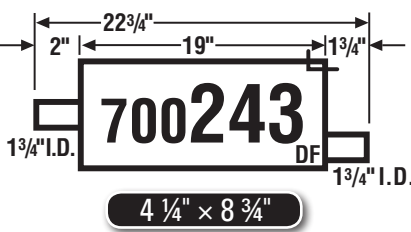

1998 Chev./GMC Tracker, 4-Dr. Models
96-97 Geo Tracker, 4-Dr., Hardtop

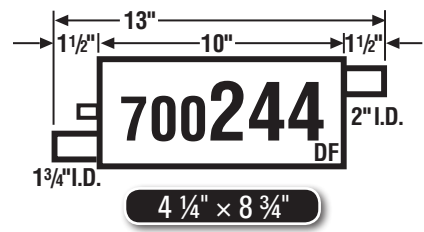

96-98 Grand Am GT, Dual Exh. (Right)
1995 Grand Am, Dual Exh. (Right)

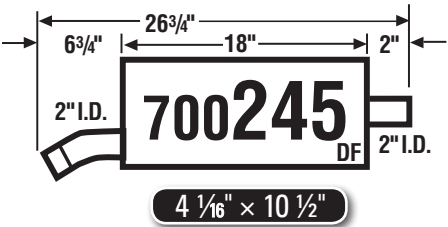

96-98 Grand Am GT, Dual Exh. (Left)
1995 Grand Am, Dual Exh. (Left)

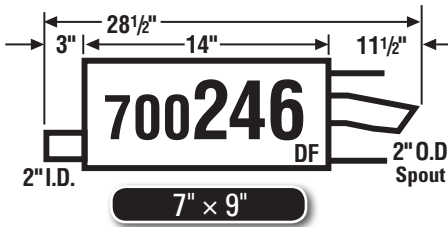

95-01 Lumina
95-99 Monte Carlo

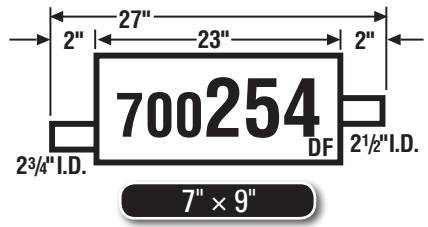

96-05 Astro/Safari Van

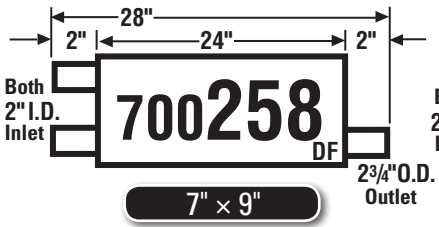

99-00 Escalade, Denali
96-99 C1500, C2500, K1500, K2500
96-00 Tahoe/Yukon

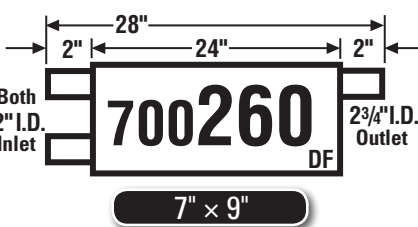

96-00 C1500, C2500, K1500, K2500, Suburban, Tahoe, Yukon

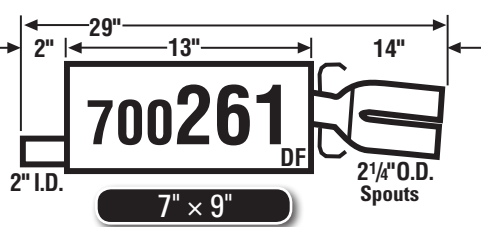

95-99 Lumina, Monte Carlo, Dual Exh. (Right)

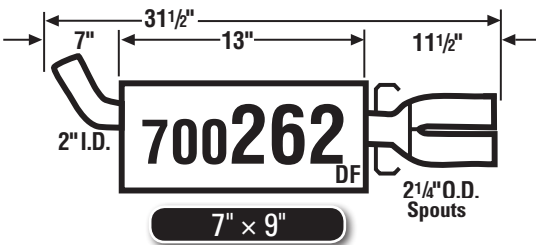

95-99 Lumina, Monte Carlo, Dual Exh. (Left)

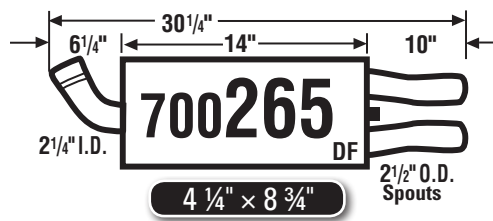

85-90 Corvette, exc. ZR1, Dual Exh. (Left)

NOTE: Black area denotes welded head bracket.

DF-U - Denotes muffler used primarily as Direct Fit, but is also Universal.
U-DF - Denotes muffler used primarily as Universal, but is also Direct Fit.

DF - Direct Fit Muffler
U - Universal Muffler
HS - Denotes Heat Shield is on muffler.

GENERAL MOTORS

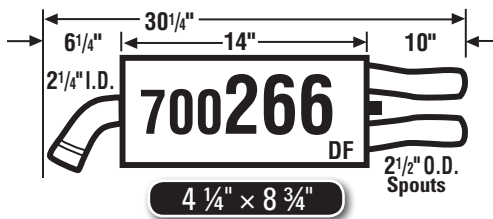

85-90 Corvette, exc. ZR1, Dual Exh. (Right)

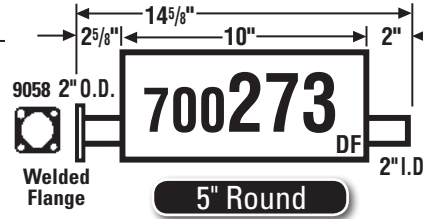

90-93 Storm, (Front)

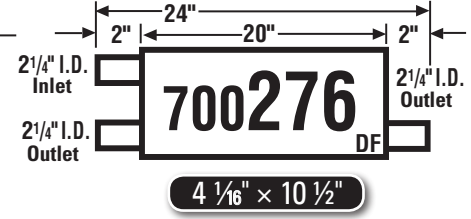

95-97 Camaro
91-92 Camaro, Firebird
96-97 Firebird

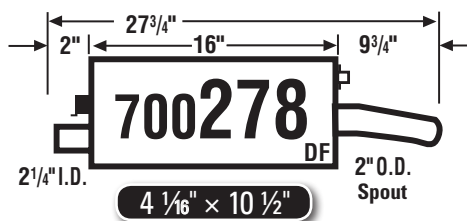

90-92 Regal

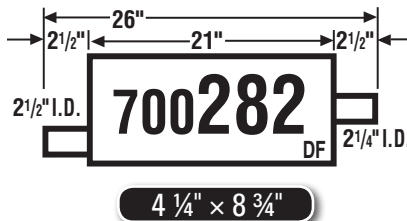

91-93 Park Avenue, exc. 92-93 Supercharged Eng.
92-93 98, Exc. Supercharged Eng.



91-94 Lumina, Dual Exh. (Right)
91-96 Grand Prix, Dual Exh. (Right)



92-95 Lumina APV, Silhouette, Trans Sport

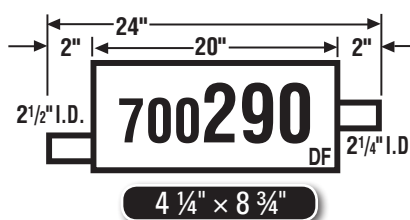

89-91 DeVille, Fleetwood

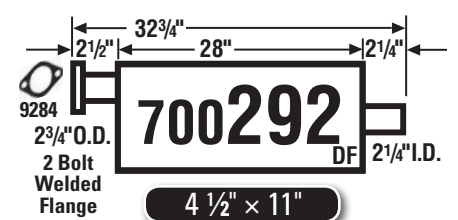

00-05 Blazer, Jimmy, Envoy
00-01 Bravada

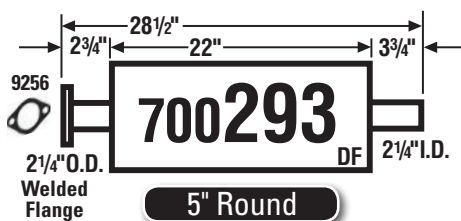

97-04 Regal, (Front)
00-05 Impala, (Front)
00-05 Monte Carlo, (Front)
97-08 Grand Prix, (Front)
05-09 Lacrosse (Front)
05-07 Allure (Front)

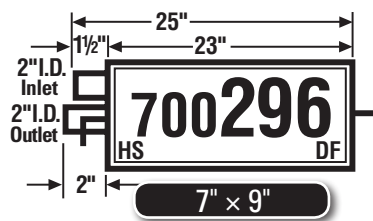

97-03 Malibu
04-05 Classic
97-99 Cutlass

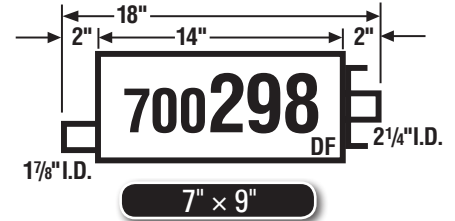

00-05 Monte Carlo, Dual Exh. (Right)
97-08 Grand Prix, Dual Exh. (Right)
05-08 Lacrosse, Dual Exh. (Right)
05-07 Allure, Dual Exh. (Right)

NOTE: Black area denotes welded head bracket.

DF-U - Denotes muffler used primarily as Direct Fit, but is also Universal.

U-DF - Denotes muffler used primarily as Universal, but is also Direct Fit.

DF - Direct Fit Muffler
U - Universal Muffler

HS - Denotes Heat Shield is on muffler.

GENERAL MOTORS

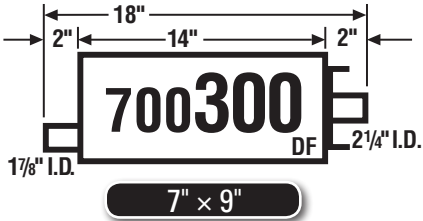

7" x 9"

- 00-05 Monte Carlo, Dual Exh. (Left)
- 97-08 Grand Prix, Dual Exh. (Left)
- 05-08 Lacrosse, Dual Exh. (Left)
- 05-07 Allure, Dual Exh. (Left)

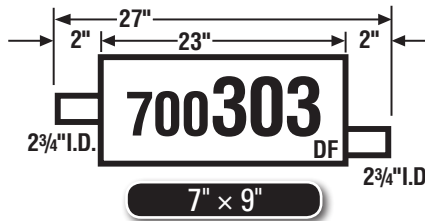

7" x 9"

- 99-07 C1500/K1500 Silverado/Sierra, Avalanche, Suburban, Tahoe, Yukon
- 99-00 C2500/K2500 Silverado/Sierra
- 02-05 Escalade

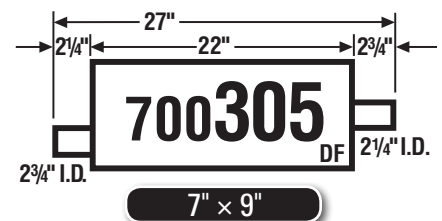

7" x 9"

- 96-99 C1500/K1500, C2500/K2500

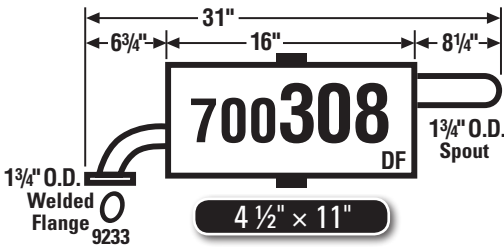

4 1/2" x 11"

- 98-02 Chevrolet Prizm

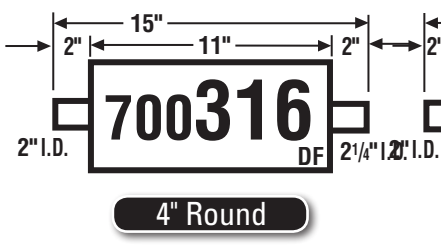

4" Round

- 94-96 Caprice Sta. Wagon, Roadmaster Estate Wagon, Dual Exh (Right Rear)

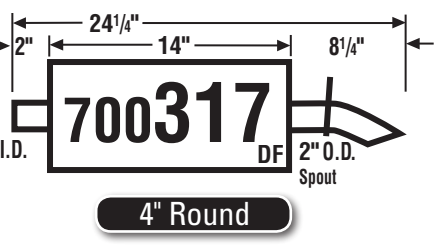

4" Round

- 94-96 Fleetwood Brougham, Dual Exh (RWD) (Both Rear)

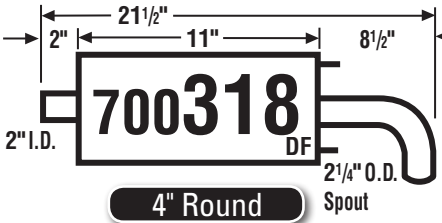

4" Round

- 94-96 Caprice Sta. Wagon, Roadmaster Estate Wagon, Dual Exh (Left Rear)

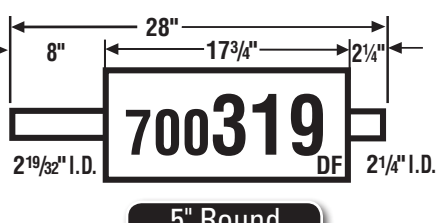

5" Round

- 00-05 LeSabre/Bonneville (Front)
- 04-05 Park Avenue (Front)



7" Round

- 92-95 Lumina APV, Silhouette, Trans Sport 3.1L

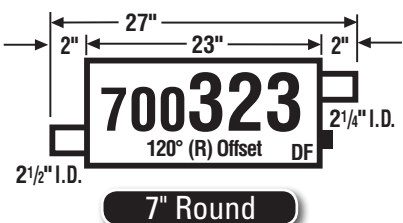

7" Round

- 1996 Lumina APV, Silhouette, Trans Sport

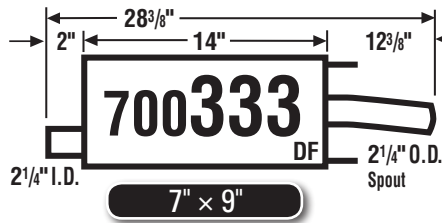

7" x 9"

- 97-05 Century, 3.1L
- 00-05 Monte Carlo, 3.4L
- 97-08 Grand Prix

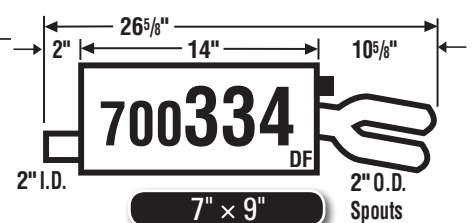

7" x 9"

- 95-96 Regal, 3.8L

NOTE: Black area denotes welded head bracket.

DF-U - Denotes muffler used primarily as Direct Fit, but is also Universal.
 U-DF - Denotes muffler used primarily as Universal, but is also Direct Fit.

DF - Direct Fit Muffler
 U - Universal Muffler
 HS - Denotes Heat Shield is on muffler.

GENERAL MOTORS

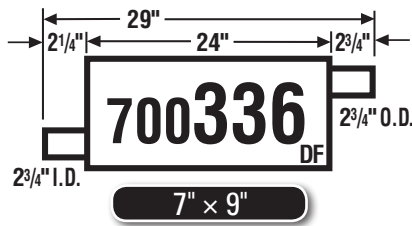

93-95 C/K1500, C/K2500, C/K3500 Turbo Diesel

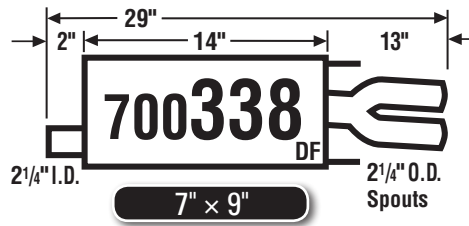

97-04 Regal

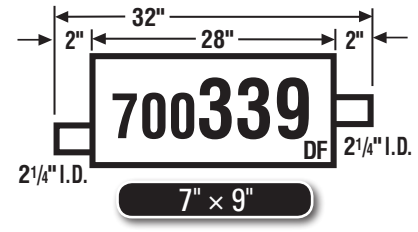

99-01 Montana (Ext. W.B.)
97-01 Silhouette (Ext. W.B.)
97-98 Trans Sport (Ext. W.B.)
97-01 Venture (Ext. W.B.)

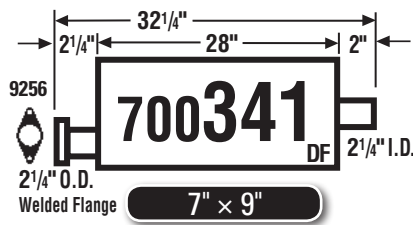

99-01 Montana (Std. W.B.)
97-99 Silhouette (Std. W.B.)
97-98 Trans Sport (Std. W.B.)
97-01 Venture (Std. W.B.)

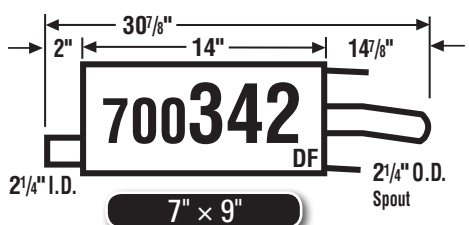

00-05 Impala

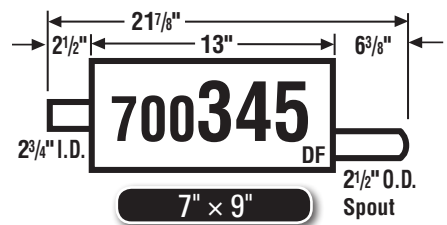

02-04 Bravada (Rear)
04-07 Rainier (Rear)
02-09 Trailblazer, Envoy (Rear)

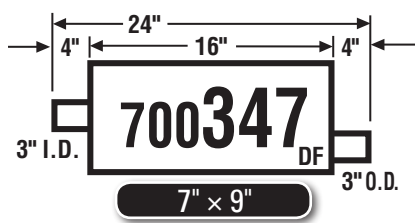

90-95 C3500/K3500 7.4L Chassis Cab

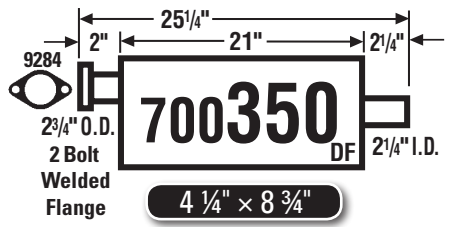

00-05 Blazer/Jimmy S/T 2-Dr.

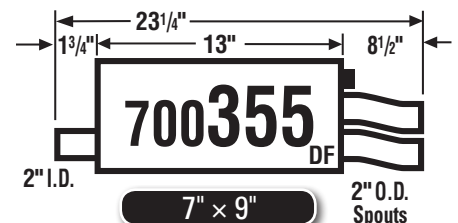

93-96 Cutlass Supreme, Dual Exh (Left)
1993 Grand Prix, Dual Exh (Left)

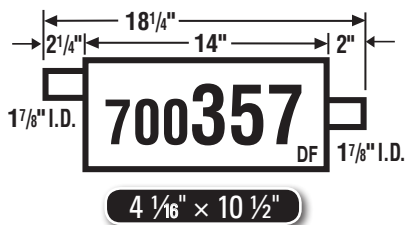

95-99 Aurora, Riviera, Dual Exh (Both Rear)
97-05 Park Avenue, Dual Exh (Both Rear)

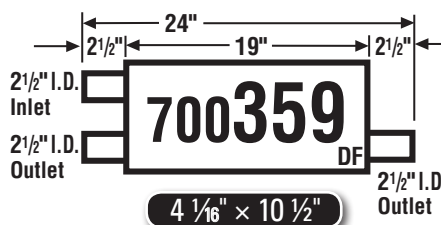

83-90 Camaro Z28, IROC-Z, Firebird, Trans AM

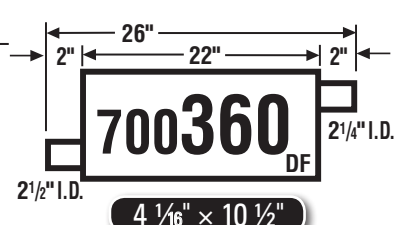

91-93 Riviera
90-92 Eldorado/Seville
91-92 Toronado

NOTE: Black area denotes welded head bracket.

DF-U - Denotes muffler used primarily as Direct Fit, but is also Universal.
U-DF - Denotes muffler used primarily as Universal, but is also Direct Fit.

DF - Direct Fit Muffler
U - Universal Muffler
HS - Denotes Heat Shield is on muffler.

GENERAL MOTORS

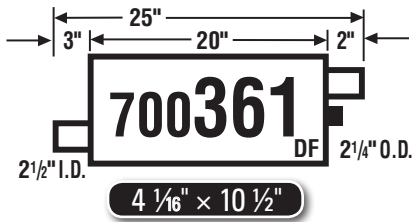

- 85-91 C/K, R/V Suburban Diesel Eng.
- 82-86 C10/C1500, C20/C2500, C30/C3500 Diesel Eng.
- 82-86 K10/K1500, Suburban Diesel Eng.

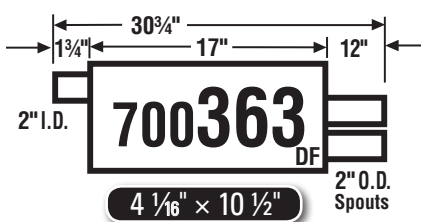

- 91-94 Cavalier Z24

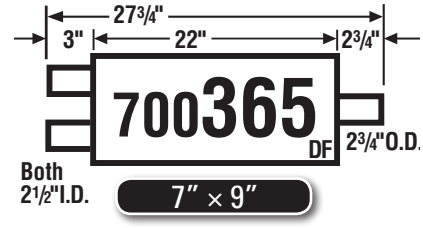

- 96-00 C/K2500, C/K3500 Old Body Style, 155.5" W.B.

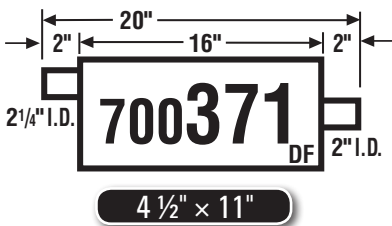

- 97-05 Park Avenue (Rear)

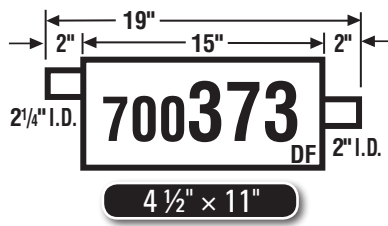

- 00-05 Bonneville, LeSabre (Rear)

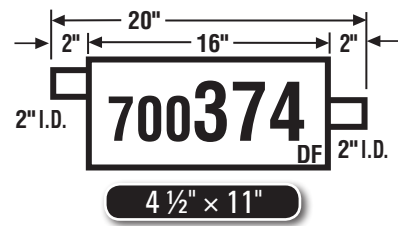

- 00-05 Deville, Dual Exh (Both)
- 98-03 Seville, Dual Exh (Both)
- 06-11 DTS, Dual Exh (Both)

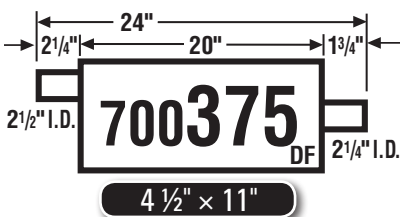

- 92-93 DeVille
- 1992 Fleetwood

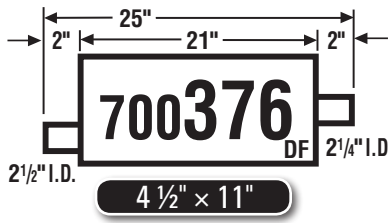

- 05-09 Equinox
- 96-04 S10/S15, 6 cyl. (96 Manual Trans.)
- 06-09 Torrent
- 02-07 Vue

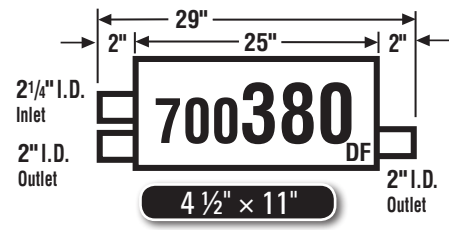

- 96-99 Bonneville SSE

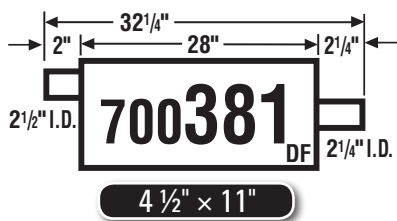

- 1996 S10/S15 6 cyl. (Auto. Trans.)
- 96-97 T10/T15 6 cyl.

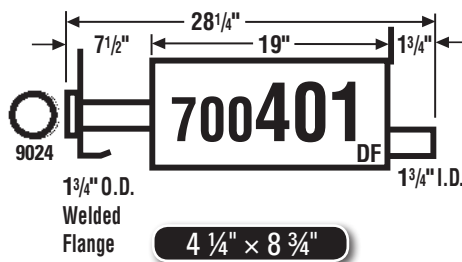

- 99-03 Tracker 2-Dr. Models

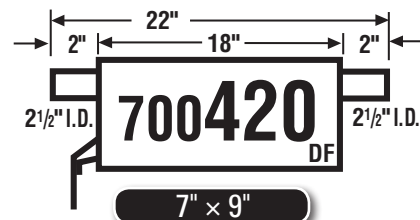

- 04-12 Colorado/Canyon

NOTE: Black area denotes welded head bracket.

DF-U - Denotes muffler used primarily as Direct Fit, but is also Universal.
 U-DF - Denotes muffler used primarily as Universal, but is also Direct Fit.

DF - Direct Fit Muffler
 U - Universal Muffler
 HS - Denotes Heat Shield is on muffler.

GENERAL MOTORS

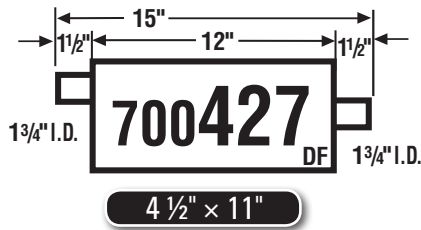

04-07 Malibu Sedan & Maxx
2008 Malibu Classic

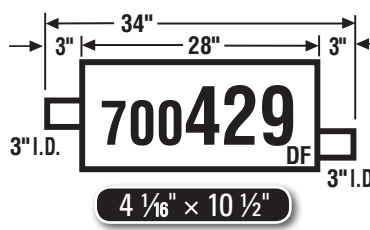

02-04 Bravada (Front)
04-07 Rainier (Front)
02-09 Trailblazer, Envoy (Front)

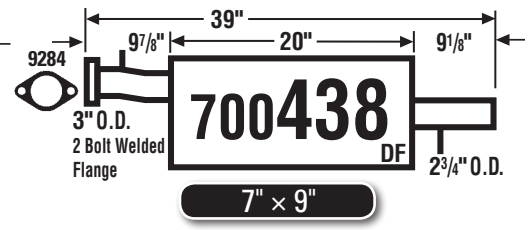

00-02 G10/G1500, G20/G2500, Express/Savana

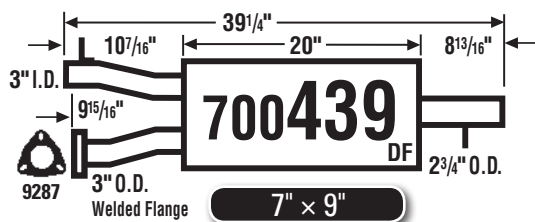

96-00 G10/G1500 (96-99), G20/G2500 (96-99), G30/G3500 (96-00), Express/Savana

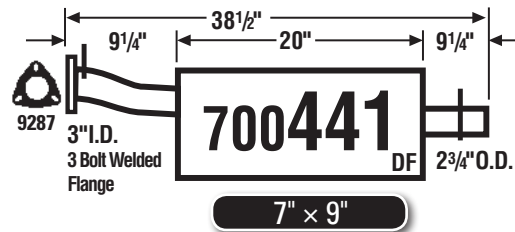

96-00 G10/G1500, G20/G2500, Express/Savana

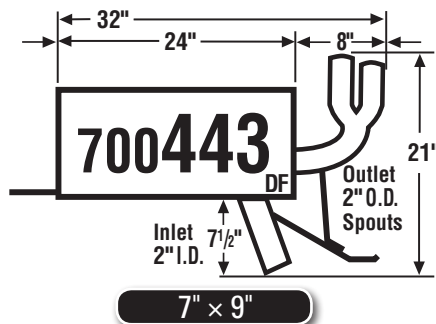

99-04 Oldsmobile Alero
99-05 Pontiac Grand Am, exc. GT w/ Dual Exhaust

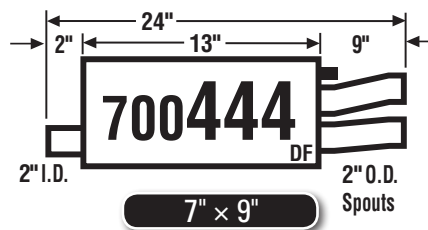

91-96 Cutlass Supreme, Dual Exh (Right)
91-93 Grand Prix, Dual Exh (Right)

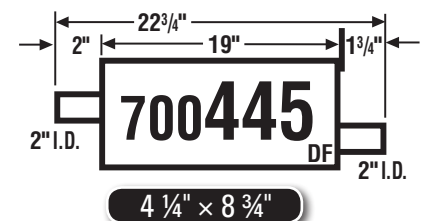

99-03 Tracker, 4 cyl., 4-Dr.
01-04 Tracker, 6 cyl., 4-Dr.

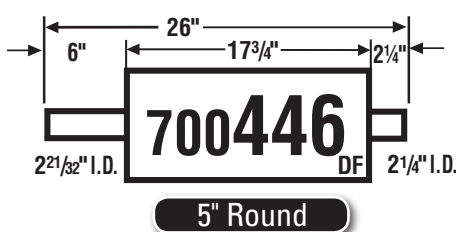

95-99 Aurora, Riviera (Front)
97-05 Park Avenue (Front)

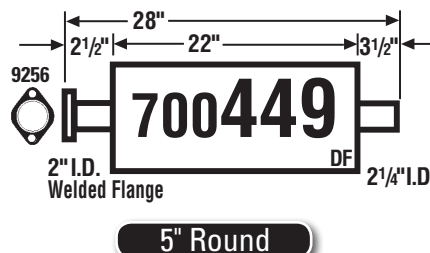

06-11 Impala, 3.5L (Front)
06-07 Monte Carlo, 3.5L (Front)

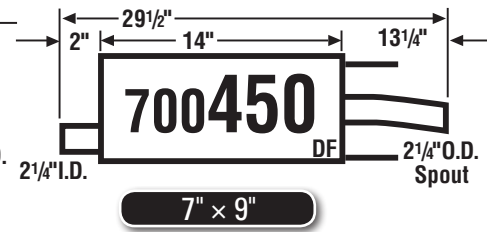

06-11 Impala, 3.5L (Rear)
06-07 Monte Carlo, 3.5L (Rear)

NOTE: Black area denotes welded head bracket.

DF-U - Denotes muffler used primarily as Direct Fit, but is also Universal.
U-DF - Denotes muffler used primarily as Universal, but is also Direct Fit.

DF - Direct Fit Muffler
U - Universal Muffler
HS - Denotes Heat Shield is on muffler.

GENERAL MOTORS

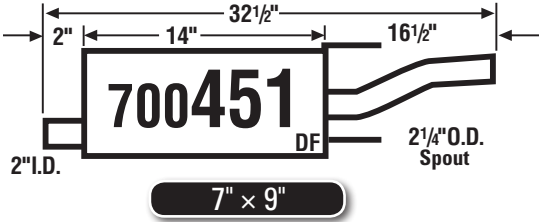

- 06-11 Impala, 3.9L (Right)
- 06-09 Impala SS, 5.3L (Right)
- 12-16 Impala, 3.6L (Right)

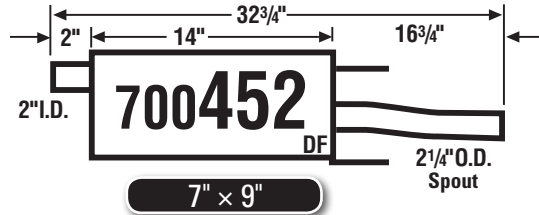

- 06-11 Impala, 3.9L (Left)
- 06-09 Impala SS, 5.3L (Left)
- 12-16 Impala, 3.6L (Left)

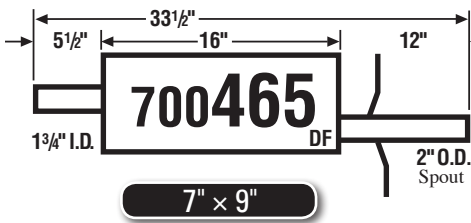

- 05-10 Cobalt, 2.2L
- 05-06 G5 Pursuit, 2.2L (Canada Only)
- 07-10 G5, 2.2L



- 02-06 Escalade, 6.0L (exc. ESV or EXT Models or Models w/ 20" Wheels)
- 01-06 Tahoe/Yukon Denali, 6.0L (exc. XL Models)
- 03-06 Hummer H2, 6.0L

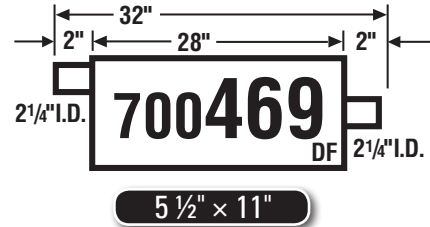

- 05-07 Terraza
- 05-08 Uplander
- 02-05 Venture
- 02-04 Silhouette
- 02-08 Montana
- 05-07 Relay

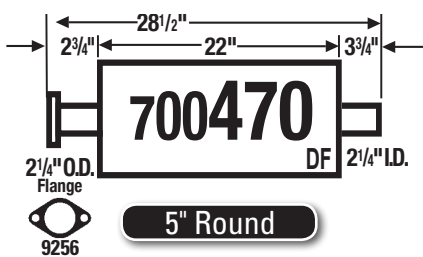

- 05-07 Buick, Allure
- 05-09 Buick, Lacrosse

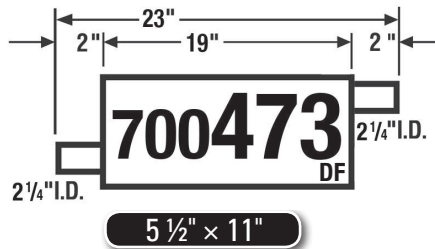

- 08-12 Buick, Enclave, V6-3.6L
- 09-16 Chevrolet, Traverse, V6-3.6L
- 07-12 GMC, Acadia, V6-3.6L



- 08-12 Chevrolet, Malibu, L4-2.4L
- 08-10 Pontiac, G6, L4-2.4L

NOTE: Black area denotes welded head bracket.

DF-U - Denotes muffler used primarily as Direct Fit, but is also Universal.
 U-DF - Denotes muffler used primarily as Universal, but is also Direct Fit.

DF - Direct Fit Muffler
 U - Universal Muffler
 HS - Denotes Heat Shield is on muffler.

GENERAL MOTORS

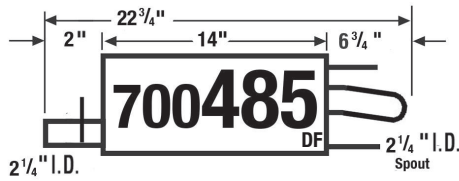

7" x 9"

05-07 Buick, Allure, V6-3.8L, Rear

05-09 Buick, Lacrosse, V6-3.8L, Rear



5" Round

08-12 Chevrolet, Malibu, V6-3.6L

08-10 Pontiac, G6, V6-3.5L

08-09 Pontiac, G6, V6-3.6L



7" x 9"

06-11 Chevrolet, HHR, L4-2.2L

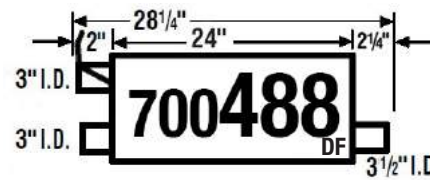

8 1/2" x 11 1/2"

01-06 Chevrolet/Silverado 2500HD, GMC/Sierra 2500HD, V8-6.0L, V8-8.1L

2007 Chevrolet/Silverado 2500HD Classic, GMC/Sierra 2500HD Classic, V8-6.0L, V8-8.1L

04-06 Chevrolet/Silverado 3500, GMC/Sierra 3500, V8-6.0L, V8-8.1L

2007 Chevrolet/Silverado 3500 Classic, GMC/Sierra 3500 Classic, V8-6.0L, V8-8.1L

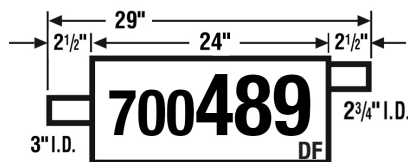

8 1/2" x 11 1/2"

07-13 Chevrolet/Silverado 1500, GMC/Sierra 1500, V6-4.3L, V8-4.8L, V8-5.3L



4 1/16" x 10 1/2"

87-90 G Series Van

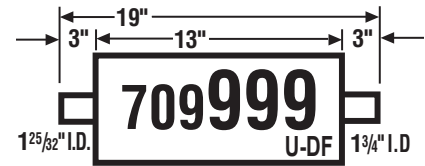

5" Round

88-89 LeMans (Front)

NOTE: Black area denotes welded head bracket.

DF-U - Denotes muffler used primarily as Direct Fit, but is also Universal.

U-DF - Denotes muffler used primarily as Universal, but is also Direct Fit.

DF - Direct Fit Muffler

U - Universal Muffler

HS - Denotes Heat Shield is on muffler.

HONDA

6685
DF-U
Both 1 1/2" I.D.
9821 (2) Chrome Tips
24864
24865
28415
9066
1 3/4" I.D.
20" 16" 2"
4 1/4" x 8 3/4"

86-87 Civic Si Hatchback

700017
DF
9822 Chrome Tip
1 3/4" O.D. Spout
8706 or 9066
38559 or 38351 or 38560 or 48273
1 1/2" 23 3/8" 15" 6 7/8"
1 5/8" I.D.
4 1/4" x 8 3/4"

86-89 Accord 2-door Hatchback, Coupe, 4-door Sedan (Welded Ass'y. Available)

700018
DF-U
9822 Chrome Tip
1 3/4" O.D. Spout
38471
9024
1 7/8" I.D.
26 1/2" 16" 8 3/4"
1 3/4"
7" x 9"

90-93 Accord DX, LX, 2-door Coupe, 4-door Sedan (Welded Ass'y. Available)

700019
DF
9821 (2) Chrome Tips
1 1/2" O.D. Spouts
38471
9024
1 7/8" I.D.
26 1/2" 16" 8 3/4"
1 3/4"
7" x 9"

90-93 Accord EX, SE 4-door Sedan, (1991 & 1993), SE 2-door Coupe (1993) (Welded Ass'y. Available)

700082
DF
180° Offset
24761
28205
9066
1 1/2" I.D.
18 1/2" 15" 1 3/4"
1 3/4"
5" Round

84-87 Civic Hatchback

700110
DF
9821 Chrome Tip
24802 or 34770
38389 or 38390 or 28280
9066 or 8706
1 3/4" I.D.
21 1/4" 18" 1 1/2"
1 3/4"
4 1/4" x 8 3/4"

**88-91 Civic Hatchback, Sedan, DX, LX
88-91 Civic STD Hatchback, Sta. Wag., Wagovan, CRX, HF, CRX DX**

700111
DF
Both 1 1/2" I.D.
24803
24804
38389 or 28280
8706
1 3/4" I.D.
21 1/4" 18" 1 1/2"
1 3/4"
4 1/4" x 8 3/4"

**88-91 Civic Si Hatchback, Sta. Wag., Wagovan
88-91 CRX Si**

700140
DF
9821 (2) Chrome Tips
1 1/2" O.D. Spouts
38482
9267 (90-91)
2" I.D.
24 1/2" 14" 9"
1 1/2"
7" x 9"

**90-91 Prelude Si
88-89 Prelude, w/ Fuel Inj.**

NOTE: Black area denotes welded head bracket.

DF-U - Denotes muffler used primarily as Direct Fit, but is also Universal.
U-DF - Denotes muffler used primarily as Universal, but is also Direct Fit.

DF - Direct Fit Muffler
U - Universal Muffler
HS - Denotes Heat Shield is on muffler.

HONDA

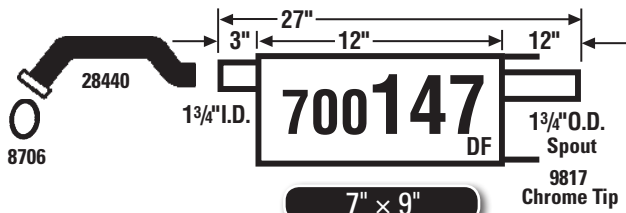

- 92-00** Civic EX, Coupe (93-00), Sedan (92-00)
- 96-98** Civic All Models, exc. Ex
- 92-95** Civic DX, LX, Coupe, Sedan, CX, VX Hatchback (Welded Ass'y Available)

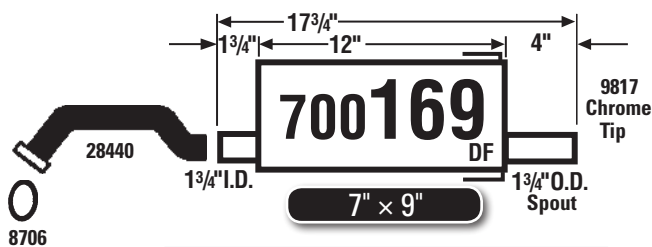

- 92-00** Civic, Hatchback (Welded Ass'y Available)

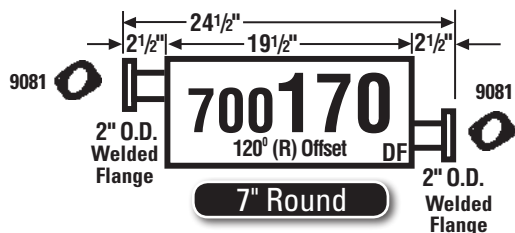

- 1994** Passport

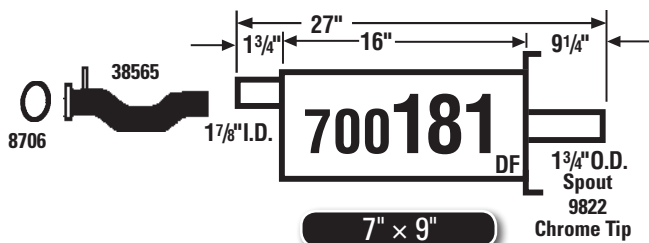

- 94-97** Accord DX, LX (Welded Ass'y Available)

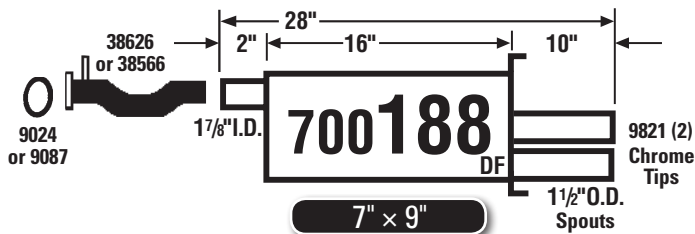

- 94-97** Accord EX, LX, 2-Dr. Coupe, 4-Dr. Sedan (Welded Assembly Available)

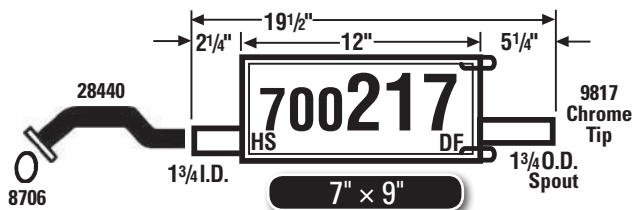

- 93-95** Civic Del Sol S

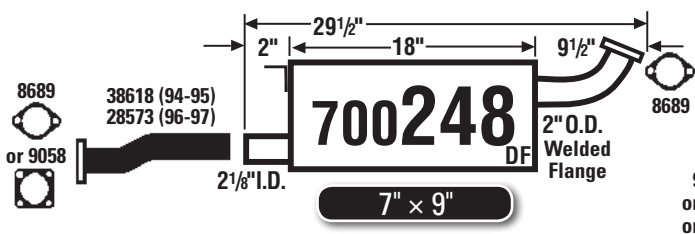

- 94-97** Passport

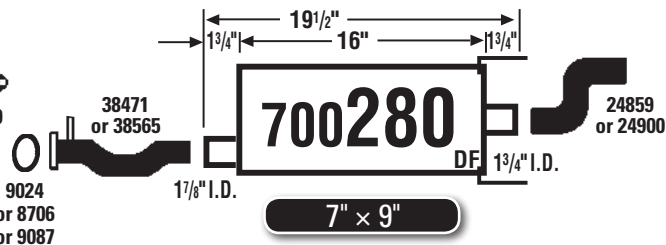

- 91-97** Accord LX; Sta. Wag.

NOTE: Black area denotes welded head bracket.

DF-U - Denotes muffler used primarily as Direct Fit, but is also Universal.
U-DF - Denotes muffler used primarily as Universal, but is also Direct Fit.

DF - Direct Fit Muffler
U - Universal Muffler
HS - Denotes Heat Shield is on muffler.

HONDA

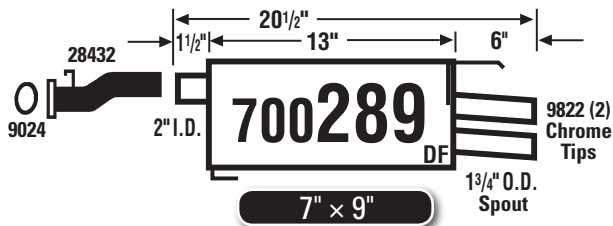

92-96 Prelude, All Models

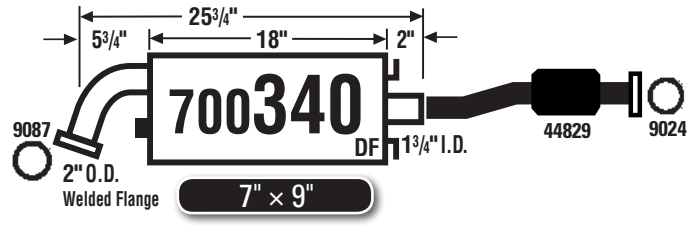

95-98 Odyssey (Front)

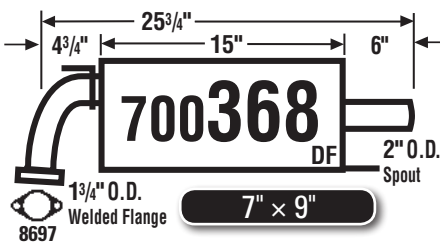

98-02 Accord Coupe & Sedan
6 cyl., Dual Exh (Right)

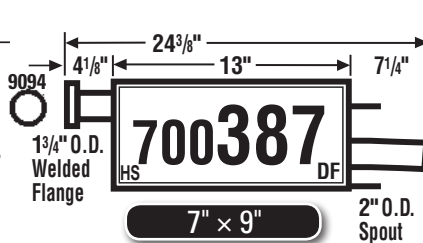

97-01 CRV

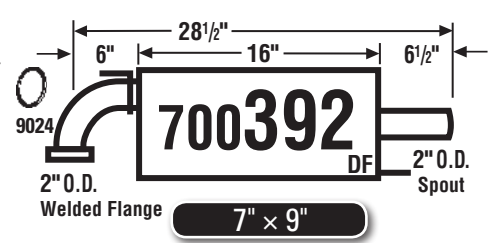

98-02 Accord, DX, LX, EX, SE

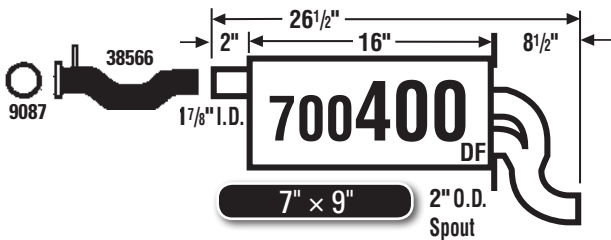

94-95 Accord EX Sta. Wagon

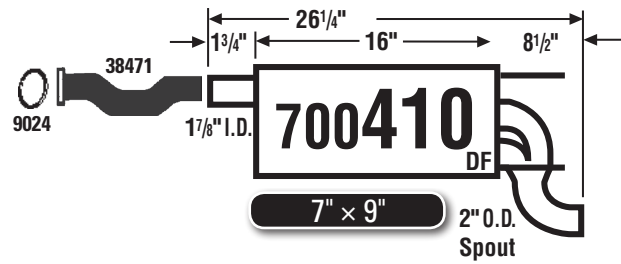

91-93 Accord EX; Sta. Wagon

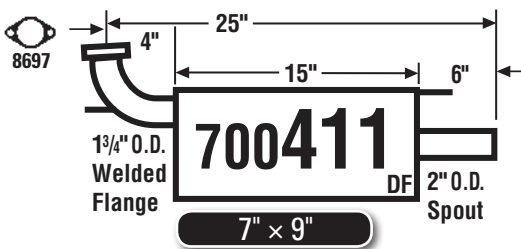

98-02 Accord Coupe & Sedan
6 cyl., Dual Exh (Left)

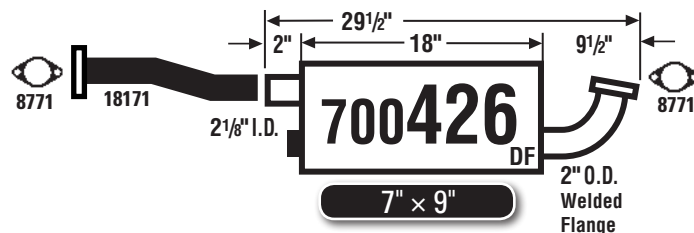

98-02 Passport

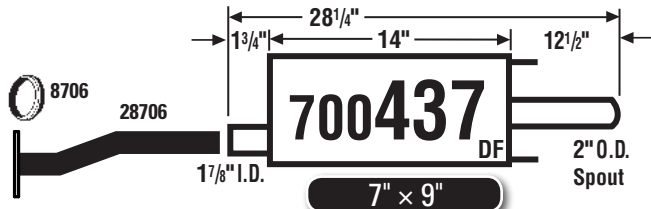

01-05 Civic DX, EX, GX, HX,
LX, Sedan & Coupe

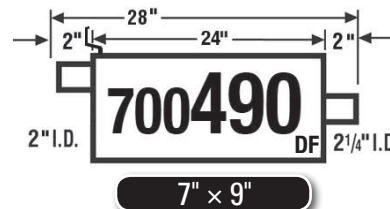

04-99 Honda, Odyssey, V6-3.5L

NOTE: Black area denotes welded head bracket.

DF-U - Denotes muffler used primarily as Direct Fit, but is also Universal.
U-DF - Denotes muffler used primarily as Universal, but is also Direct Fit.

DF - Direct Fit Muffler
U - Universal Muffler
HS - Denotes Heat Shield is on muffler.

DIRECT FITS

MAXIMUM **MSL**

MSL MUFFLER BY APPLICATION

HYUNDAI

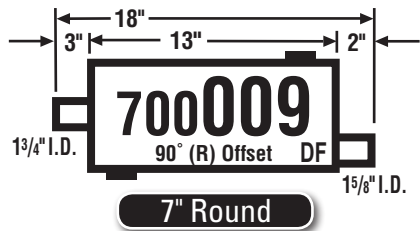

90-94 Excel

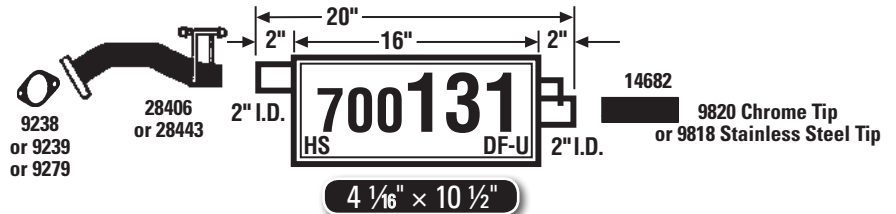

89-94 Sonata

INFINITI

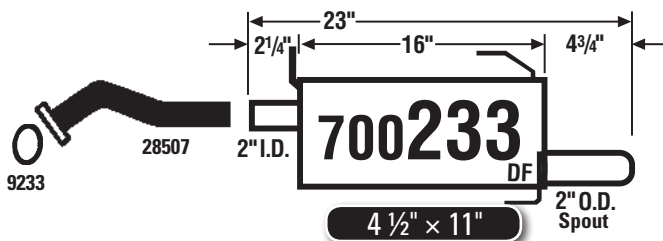

G20

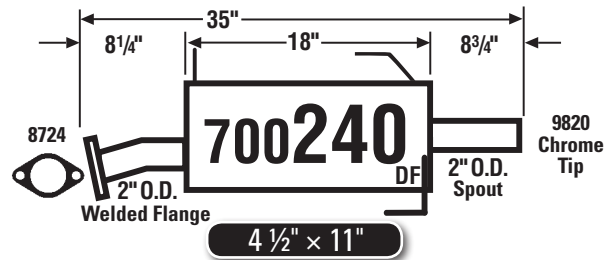

96-99 I30

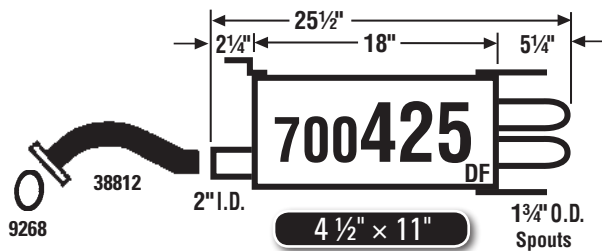

I30 (Exc. CA)

NOTE: Black area denotes welded head bracket.

DF-U - Denotes muffler used primarily as Direct Fit, but is also Universal.

U-DF - Denotes muffler used primarily as Universal, but is also Direct Fit.

DF - Direct Fit Muffler

U - Universal Muffler

HS - Denotes Heat Shield is on muffler.

ISUZU



6" Round

- 88-91 Trooper
- 86-90 Pickup
- 86-91 Trooper II



6" Round

- 81-87 Pickup
- 84-85 Trooper II

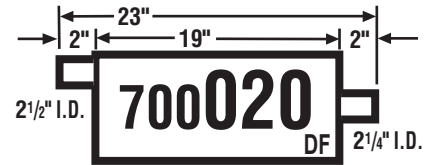

4 1/16" x 10 1/2"

- 98-99 Hombre

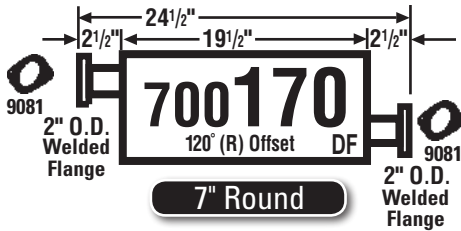

7" Round

- 91-97 Rodeo, Pickup (91-95)

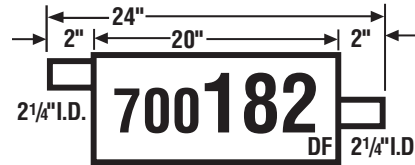

4 1/16" x 10 1/2"

- 96-00 Hombre

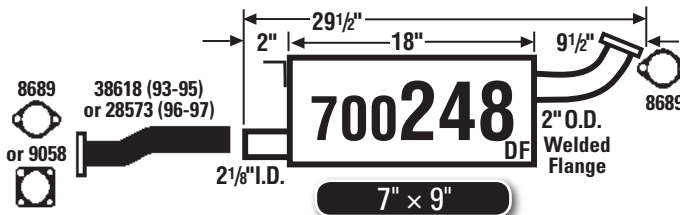

7" x 9"

- 93-97 Rodeo

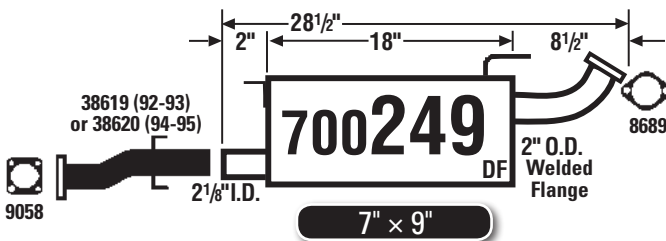

7" x 9"

- 92-95 Trooper

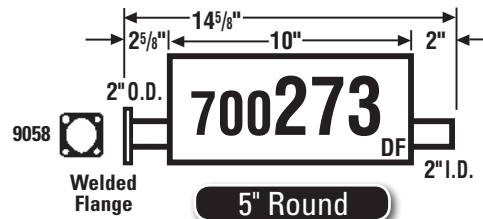

5" Round

- 90-92 Impulse Hatchback, (Front)
- 91-93 Stylus, (Front)

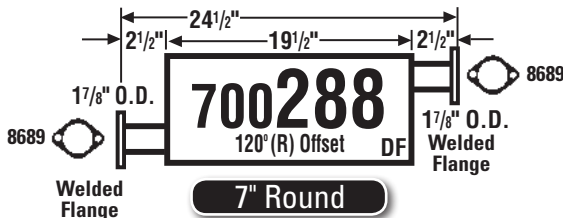

7" Round

- 91-95 Pickup

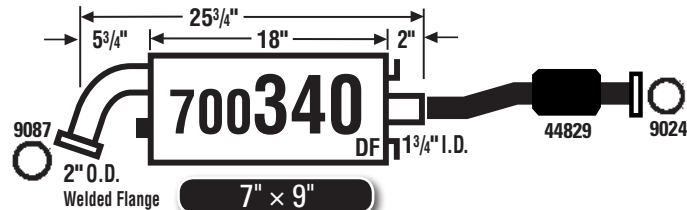

7" x 9"

- 96-99 Oasis

NOTE: Black area denotes welded head bracket.

DF-U - Denotes muffler used primarily as Direct Fit, but is also Universal.
 U-DF - Denotes muffler used primarily as Universal, but is also Direct Fit.

DF - Direct Fit Muffler
 U - Universal Muffler
 HS - Denotes Heat Shield is on muffler.

ISUZU

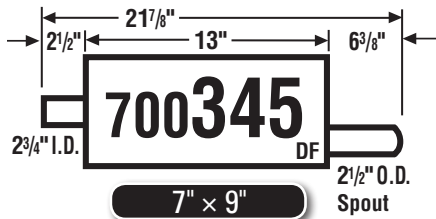

03-08 Ascender (Rear)

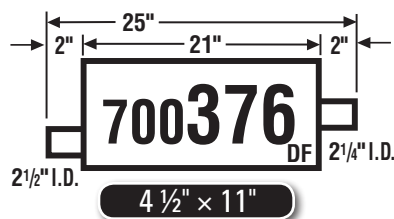

98-99 Hombre 6 cyl., 2 WD



06-08 I280/I350 Pickup

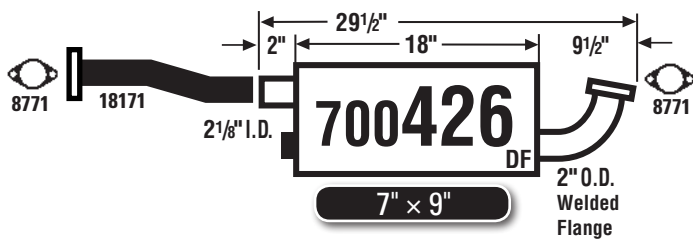

98-04 Rodeo (exc. Sport)

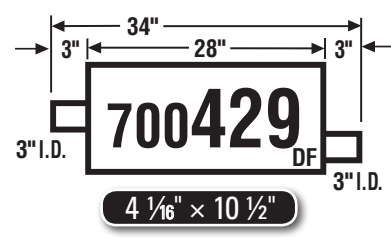

03-08 Ascender (Front)

JEEP

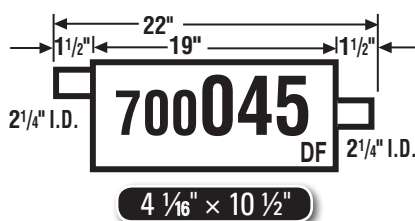

96-01 Cherokee

86-92 Wagoneer, Cherokee, Comanche (Reverse for some applications)

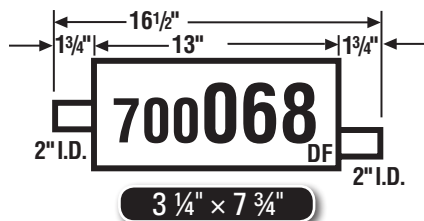

84-86 CJ7, CJ8, Scrambler

81-83 CJ5, CJ7, CJ8, All Models (1983), Calif. Models (81-82)

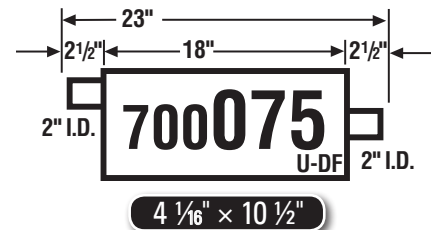

84-87 Wagoneer, Cherokee

1986 Comanche (Reverse for some applications)

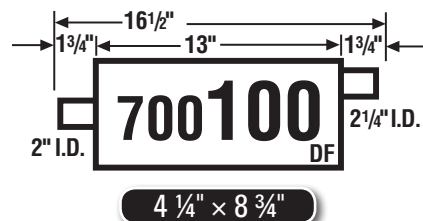

87-90 Wrangler

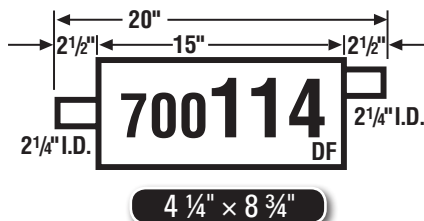

87-92 Wrangler

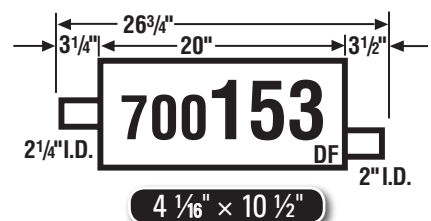

93-98 Grand Cherokee, Grand Wagoneer, 2 & 4 WD

NOTE: Black area denotes welded head bracket.

DF-U - Denotes muffler used primarily as Direct Fit, but is also Universal.
 U-DF - Denotes muffler used primarily as Universal, but is also Direct Fit.

DF - Direct Fit Muffler
 U - Universal Muffler
 HS - Denotes Heat Shield is on muffler.

JEEP

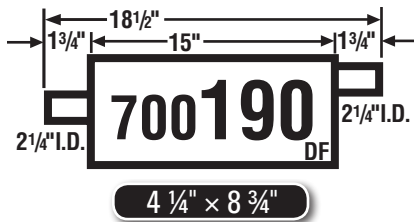

4 1/4" x 8 3/4"

93-96 Wrangler

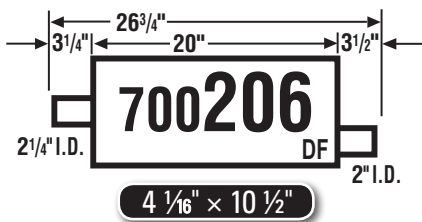

4 1/16" x 10 1/2"

92-98 Grand Cherokee, 2 & 4 WD
93-95 Cherokee, 2 & 4 WD

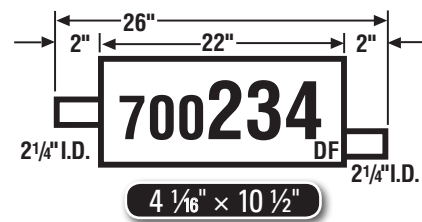

4 1/16" x 10 1/2"

02-07 Liberty

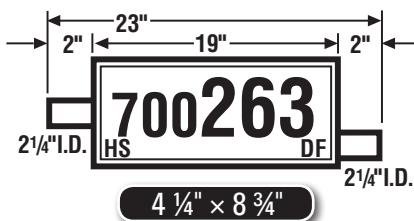

4 1/4" x 8 3/4"

97-00 Wrangler

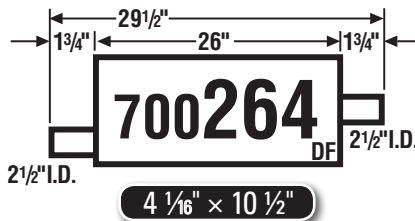

4 1/16" x 10 1/2"

84-91 Grand Wagoneer
80-82 Series 10, Wagoneer, Cherokee
1983 Wagoneer, Cherokee

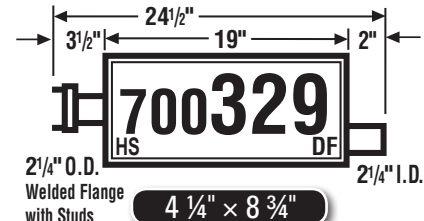

4 1/4" x 8 3/4"

00-06 Wrangler

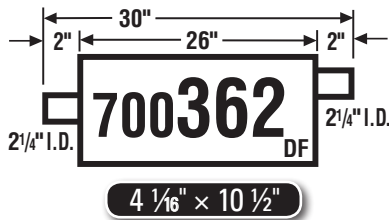

4 1/16" x 10 1/2"

99-01 Grand Cherokee 6 cyl.

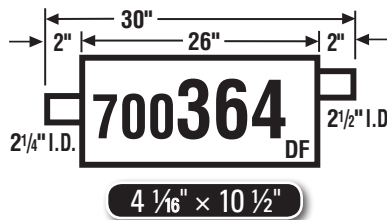

4 1/16" x 10 1/2"

99-01 Grand Cherokee 8 cyl.

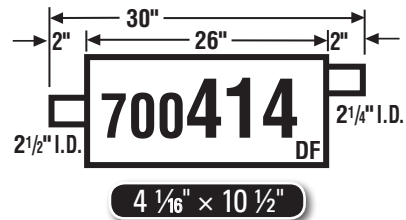

4 1/16" x 10 1/2"

02-04 Grand Cherokee, 6 cyl.

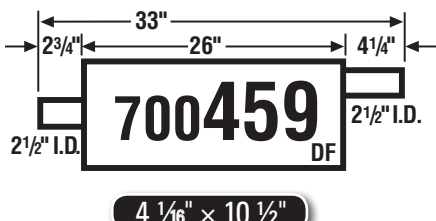

4 1/16" x 10 1/2"

02-03 Grand Cherokee, 4.7L

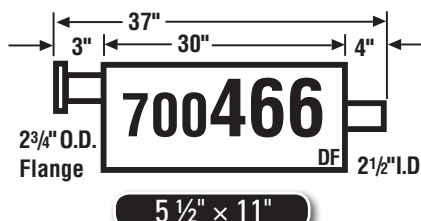

5 1/2" x 11"

05-10 Grand Cherokee, 3.7L
05-10 Grand Cherokee, 4.7L & 5.7L
06-10 Commander, 3.7L
06-07 Commander, 4.7L & 5.7L

NOTE: Black area denotes welded head bracket.

DF-U - Denotes muffler used primarily as Direct Fit, but is also Universal.
U-DF - Denotes muffler used primarily as Universal, but is also Direct Fit.

DF - Direct Fit Muffler
U - Universal Muffler
HS - Denotes Heat Shield is on muffler.

KIA

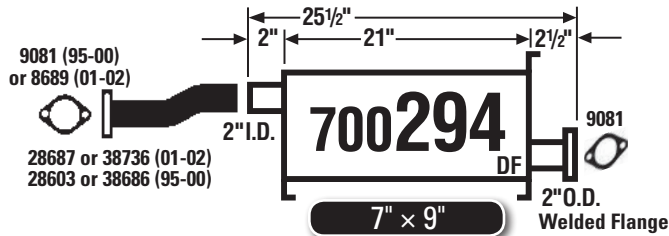

95-02 Sportage

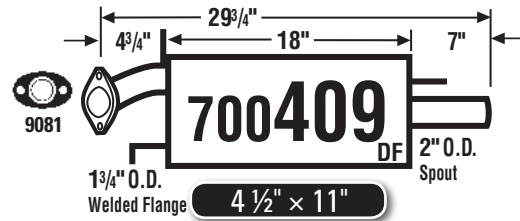

98-01 Sephia
00-04 Spectra Hatchback,
Sedan

LEXUS

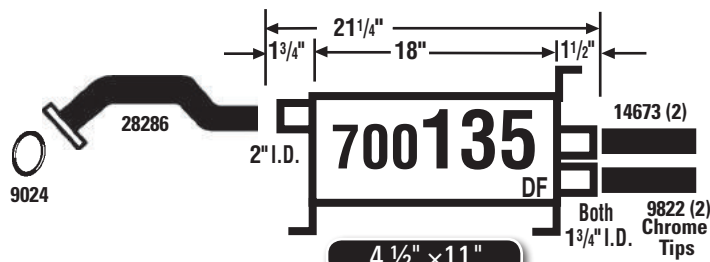

90-91 ES250

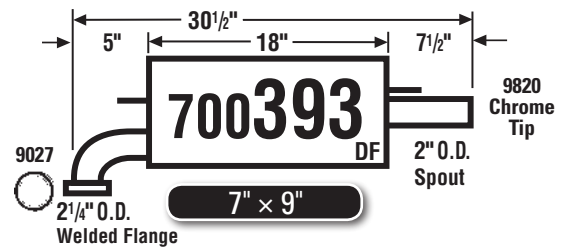

97-98 ES300

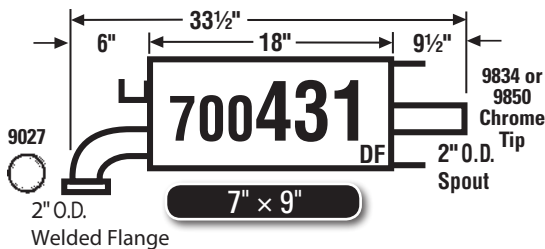

02-03 ES300
04-06 ES330

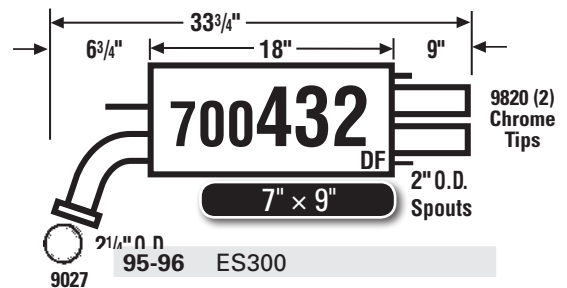

95-96 ES300

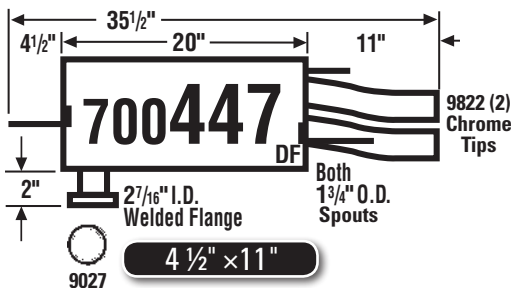

92-94 ES300

NOTE: Black area denotes welded head bracket.

DF-U - Denotes muffler used primarily as Direct Fit, but is also Universal.
U-DF - Denotes muffler used primarily as Universal, but is also Direct Fit.

DF - Direct Fit Muffler
U - Universal Muffler
HS - Denotes Heat Shield is on muffler.

MAZDA

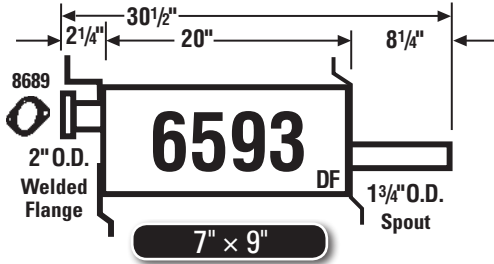

88-92 626, MX6

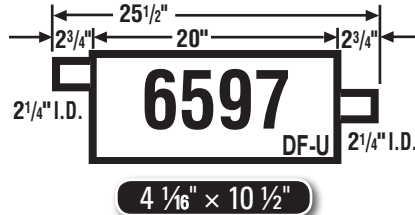

91-92 Navajo

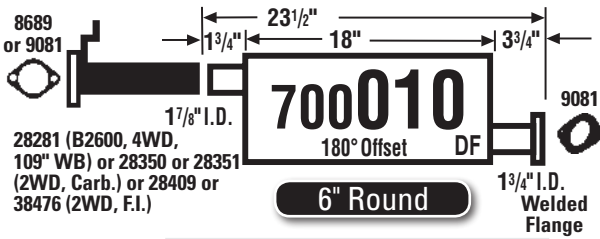

28281 (B2600, 4WD, 109" WB) or 28350 or 28351 (2WD, Carb.) or 28409 or 38476 (2WD, F.I.)

86-93 B2200 Pickup
87-88 B2600 Pickup

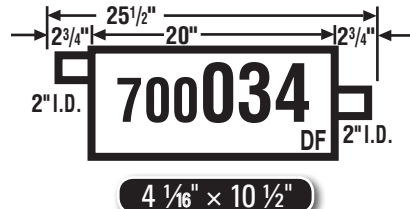

94-04 B2300, B2500, B3000, B4000

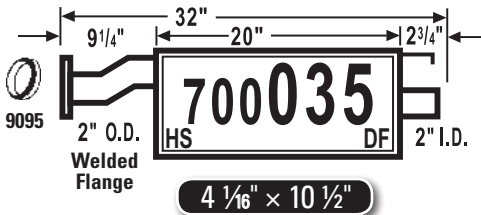

93-94 Navajo

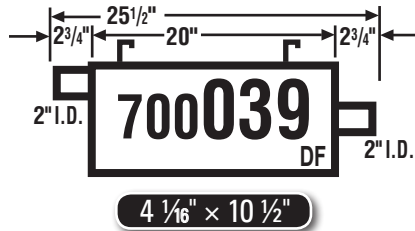

95-04 B2300
98-04 B2500
95-03 B3000, B4000

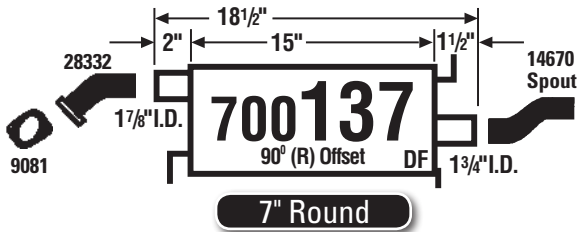

90-94 Protege

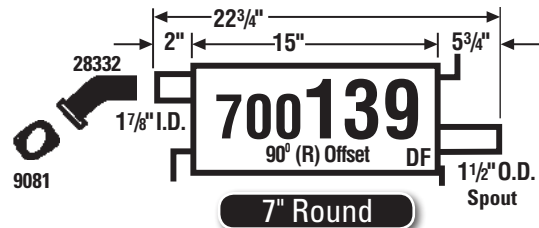

90-94 323
92-93 MX-3

NOTE: Black area denotes welded head bracket.

DF-U - Denotes muffler used primarily as Direct Fit, but is also Universal.
U-DF - Denotes muffler used primarily as Universal, but is also Direct Fit.

DF - Direct Fit Muffler
U - Universal Muffler
HS - Denotes Heat Shield is on muffler.

MAZDA

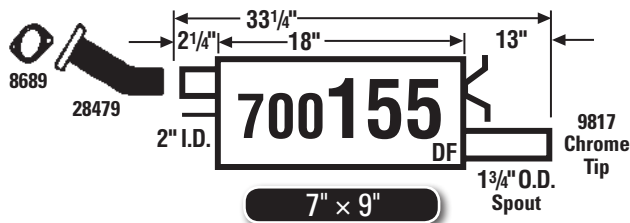

93-97 MX-6, 626 (Welded Assembly Available)

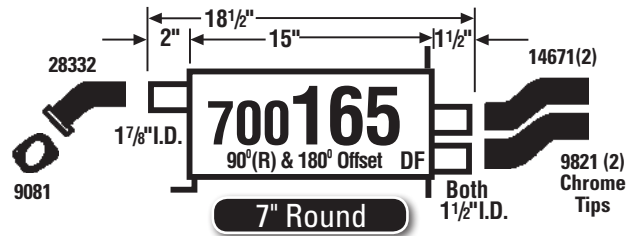

90-94 323 Protege (Welded Assembly Available)

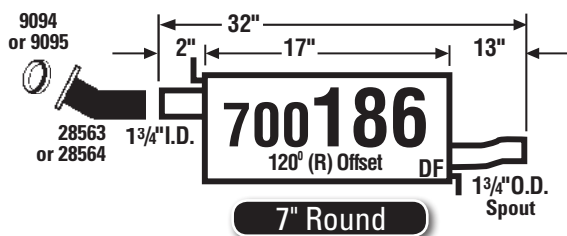

95-98 323 Protege

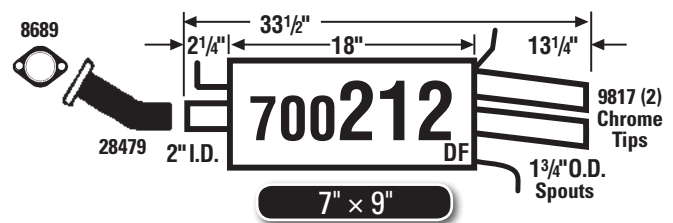

93-97 626 (Welded Assembly Available)

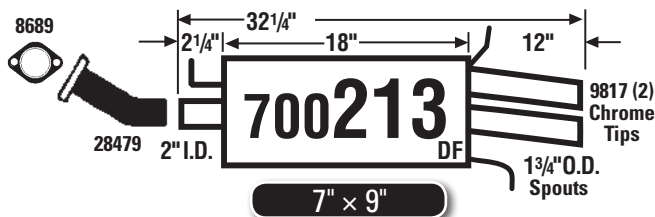

93-97 MX-6

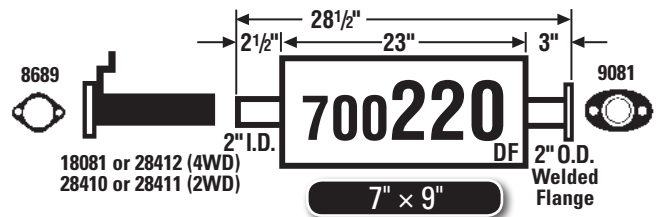

89-93 B2600 Pickup

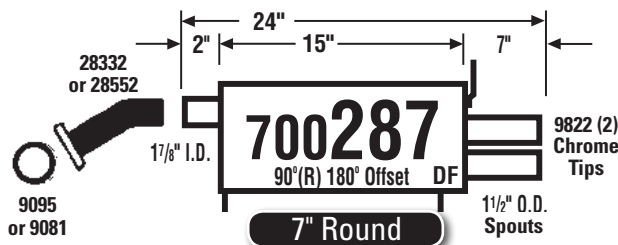

92-95 MX-3



90-97 MX-5 Miata

NOTE: Black area denotes welded head bracket.

DF-U - Denotes muffler used primarily as Direct Fit, but is also Universal.

U-DF - Denotes muffler used primarily as Universal, but is also Direct Fit.

DF - Direct Fit Muffler

U - Universal Muffler

HS - Denotes Heat Shield is on muffler.

MAZDA



99-03 Protégé
(exc. Mazda Speed)

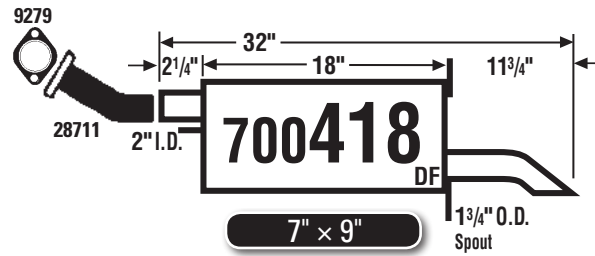

98-02 626 2.0L

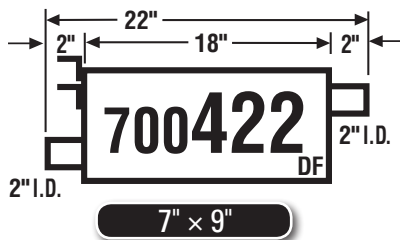

05-09 B2300
04-07 B3000
04-09 B4000

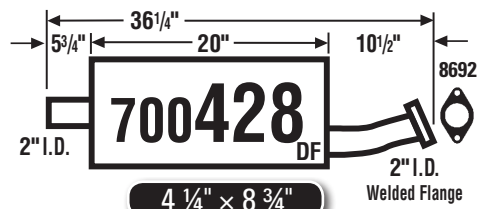

01-04 Tribute

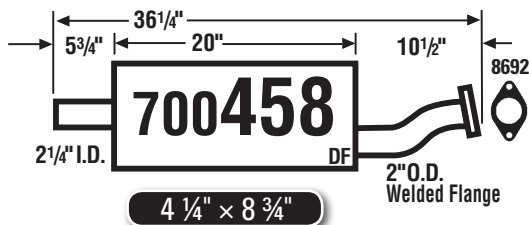

05-06 Tribute, 2.3L
2008 Tribute, 2.3L
05-06 Tribute, 3.0L
2008 Tribute, 3.0L

NOTE: Black area denotes welded head bracket.

DF-U - Denotes muffler used primarily as Direct Fit, but is also Universal.
U-DF - Denotes muffler used primarily as Universal, but is also Direct Fit.

DF - Direct Fit Muffler
U - Universal Muffler
HS - Denotes Heat Shield is on muffler.

MITSUBISHI

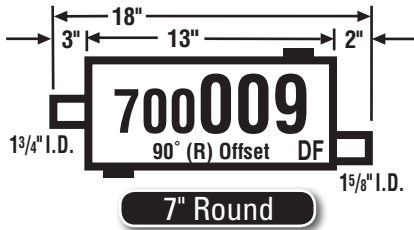

90-92 Precis

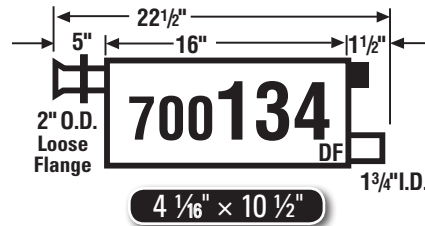

87-95 Pickup

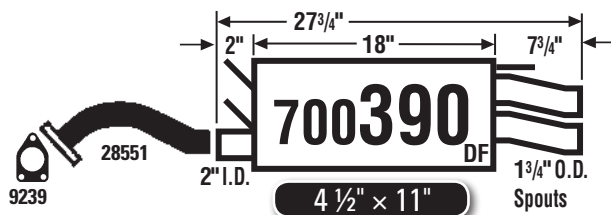

94-98 Galant

NISSAN

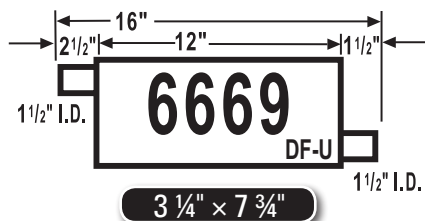

74-82 210, B210

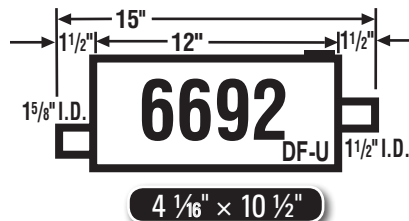

87-93 Sentra; Sedan, 2 W.D. Wagon

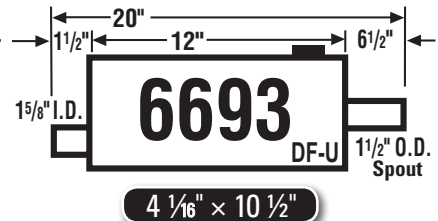

87-90 Pulsar, Sentra, Sport Coupe, Hatchback (87-88)

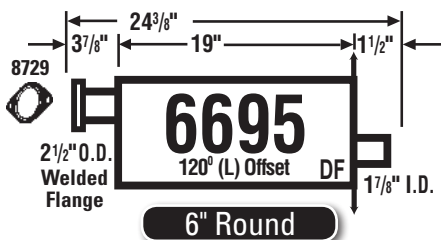

86-97 D21 (Hardbody)

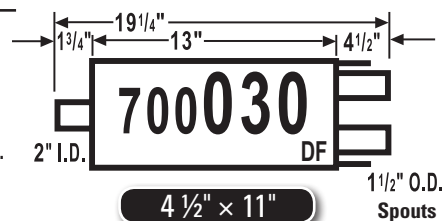

89-94 240SX (Rear)



84-89 300ZX

NOTE: Black area denotes welded head bracket.

DF-U - Denotes muffler used primarily as Direct Fit, but is also Universal.

U-DF - Denotes muffler used primarily as Universal, but is also Direct Fit.

DF - Direct Fit Muffler
U - Universal Muffler

HS - Denotes Heat Shield is on muffler.

NISSAN

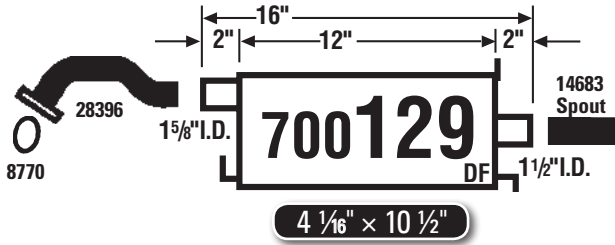

91-94 Sentra

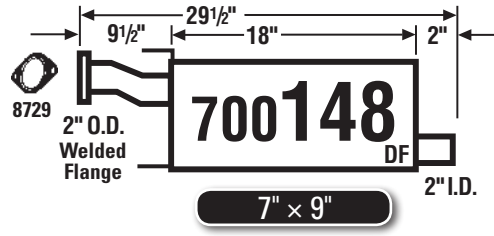

1993 Quest

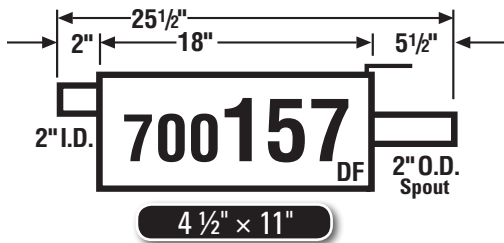

89-94 Maxima, GXE Sedan
90-92 Stanza

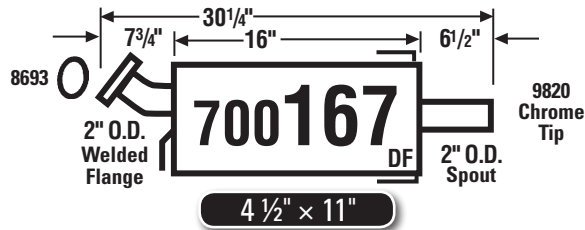

93-97 Altima

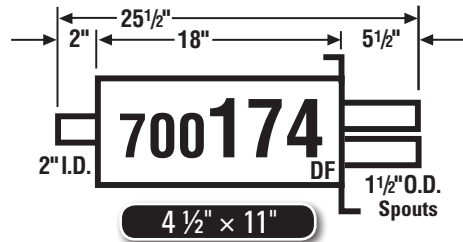

89-94 Maxima, Sedan, SE
Sedan (dual outlet)

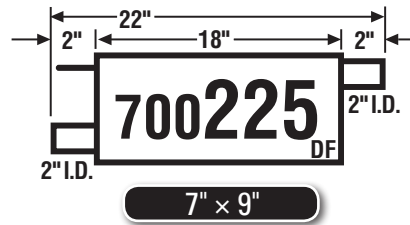

94-97 Quest

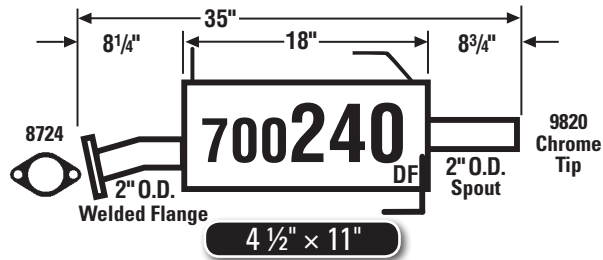

95-00 Maxima

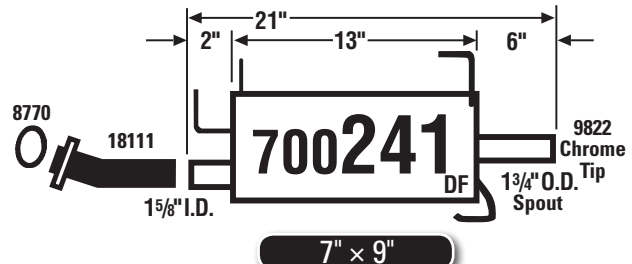

95-98 200SX
95-99 Sentra

NOTE: Black area denotes welded head bracket.

DF-U - Denotes muffler used primarily as Direct Fit, but is also Universal.
U-DF - Denotes muffler used primarily as Universal, but is also Direct Fit.

DF - Direct Fit Muffler
U - Universal Muffler
HS - Denotes Heat Shield is on muffler.

NISSAN

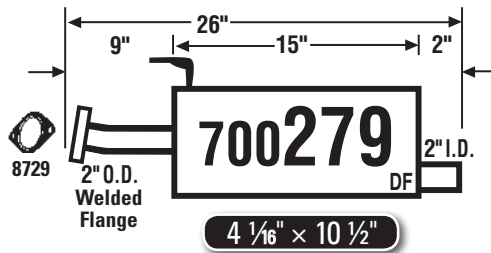

90-95 Pathfinder

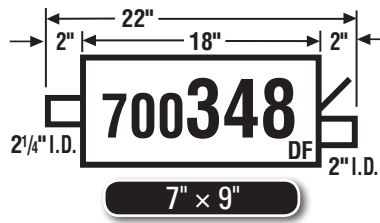

98-02 Quest (Rear)

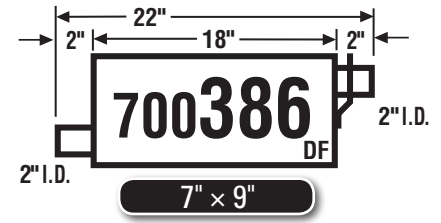

99-04 Frontier (99-02 6 cyl.)
(01-03 4 cyl.)
00-02 Xterra

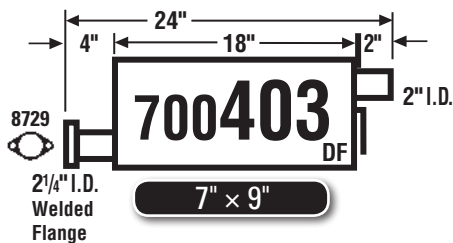

98-00 Frontier 4 cyl.

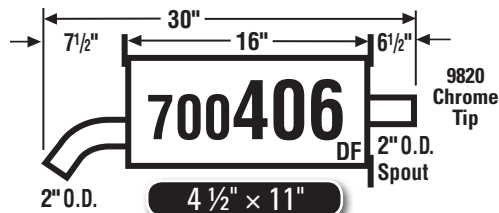

98-01 Altima

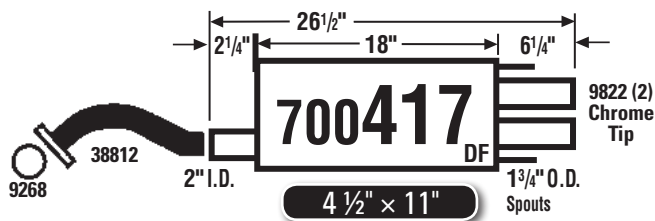

4/99-03 Maxima (exc. CA)

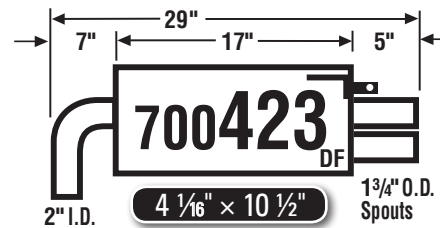

02-06 Altima, 4 cyl.

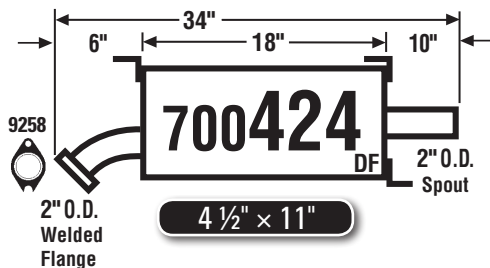

00-06 Sentra, 1.8L

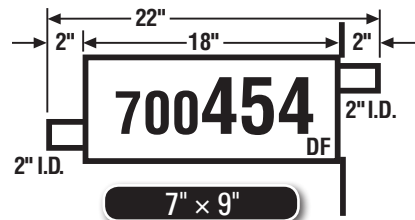

03-04 Xterra, 3.3L

NOTE: Black area denotes welded head bracket.

DF-U - Denotes muffler used primarily as Direct Fit, but is also Universal.

U-DF - Denotes muffler used primarily as Universal, but is also Direct Fit.

DF - Direct Fit Muffler

U - Universal Muffler

HS - Denotes Heat Shield is on muffler.

NISSAN

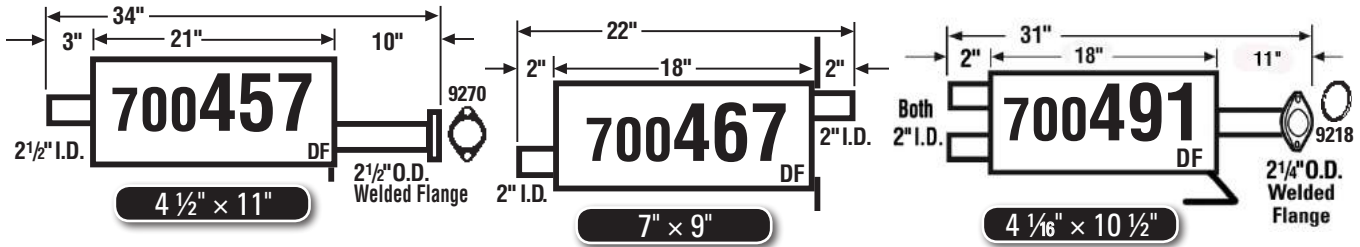

04-06 Titan Pickup King & Crew Cab, 5.6L (XE, SE, LE) (exc. Calif.)

03-04 Frontier Crew-Cab, 3.3L

07-15 Titan, V8-5.6L

SATURN

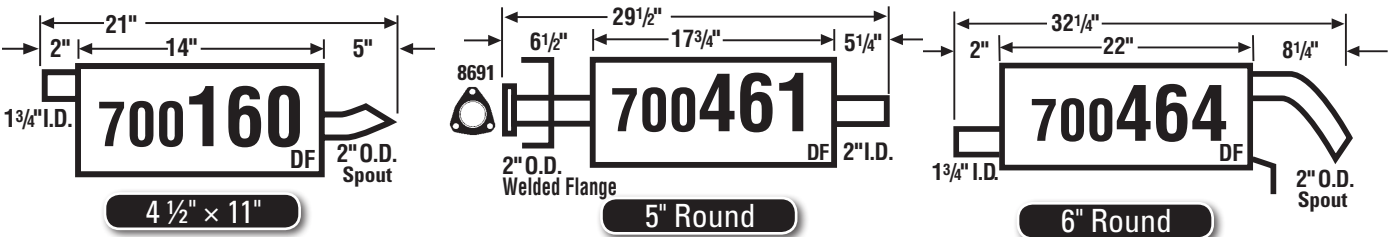

91-02 Sedan, Coupe, Sta. Wag.

00-05 L Series (Front)

03-07 ION, 2.2L

SUBARU

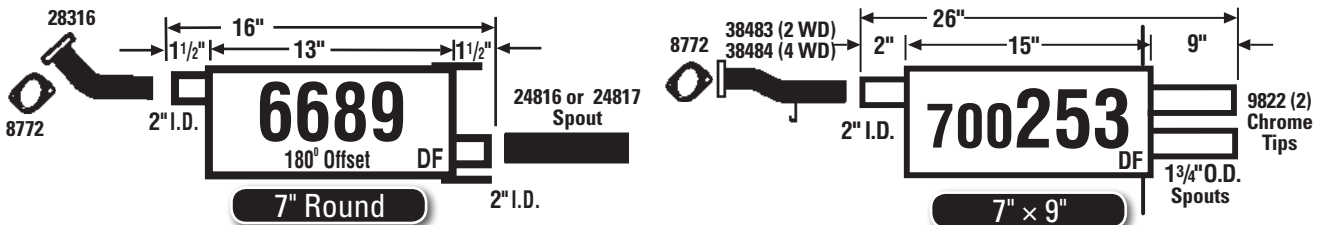

90-94 Loyale
85-89 3-Dr. Coupe, 4-Dr. Sedan, Sta. Wag.

90-94 Legacy Sta. Wag., exc. Turbo (through 2/94)

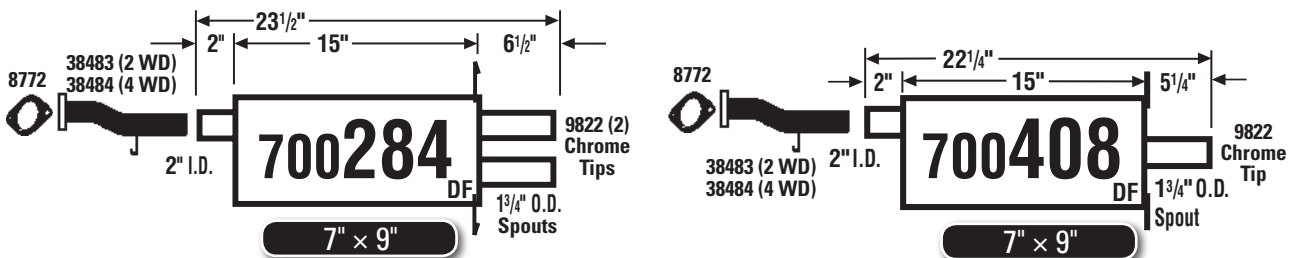

90-94 Legacy 4-Dr. Sedan; exc. Turbo (through 2/94)

3/94-99 Legacy 4 dr. Sedan, 2.2L

NOTE: Black area denotes welded head bracket.

DF-U - Denotes muffler used primarily as Direct Fit, but is also Universal.
U-DF - Denotes muffler used primarily as Universal, but is also Direct Fit.

DF - Direct Fit Muffler
U - Universal Muffler
HS - Denotes Heat Shield is on muffler.

SUBARU

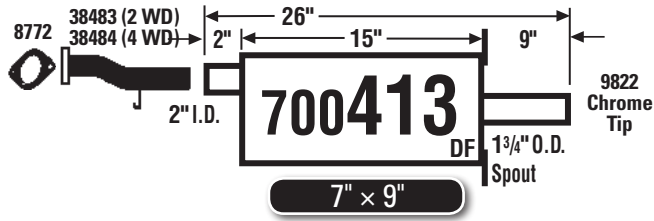

96-99 Legacy Outback
94-99 Legacy Sta. Wagon, 2.2L

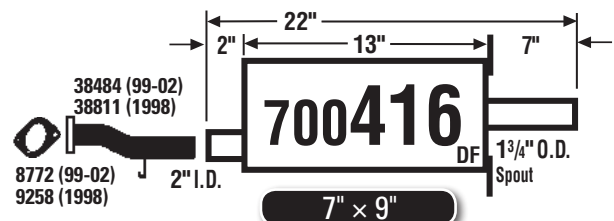

98-2/02 Forester

SUZUKI

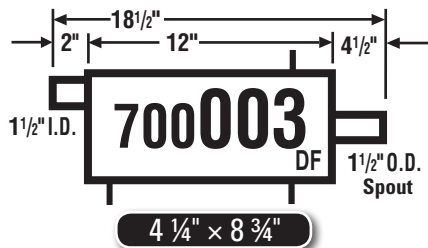

89-94 Suzuki Swift

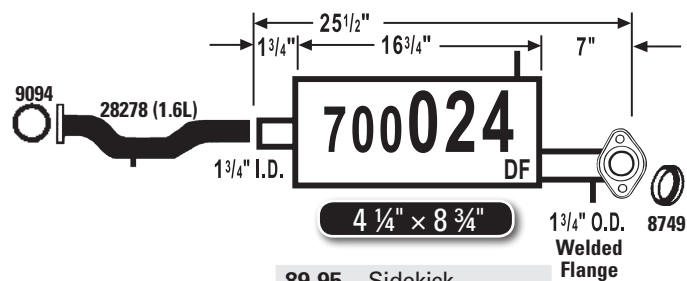

89-95 Sidekick

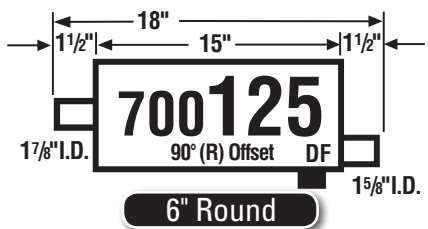

86-95 Samurai

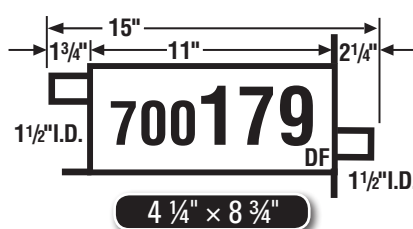

95-96 Suzuki Swift

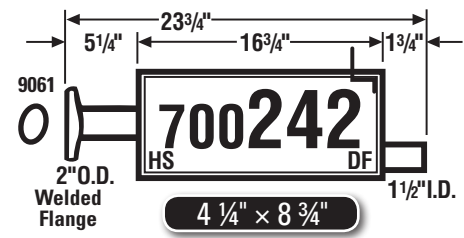

94-98 Sidekick; Convertible

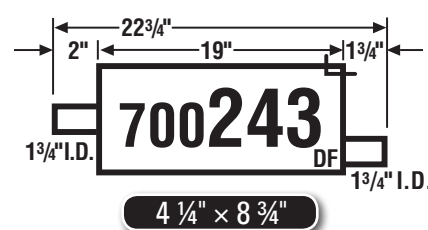

93-98 Sidekick; 4-Dr. Hardtop

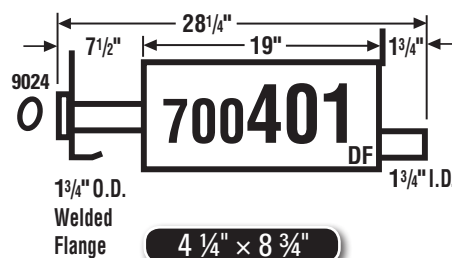

99-03 Vitara 2-Dr. Models

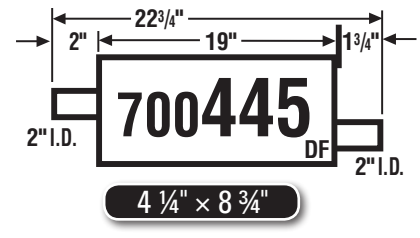

99-03 Vitara, 4 cyl., 4-Dr.
99-05 Grand Vitara, 6 cyl.

NOTE: Black area denotes welded head bracket.

DF-U - Denotes muffler used primarily as Direct Fit, but is also Universal.

U-DF - Denotes muffler used primarily as Universal, but is also Direct Fit.

DF - Direct Fit Muffler

U - Universal Muffler

HS - Denotes Heat Shield is on muffler.

TOYOTA

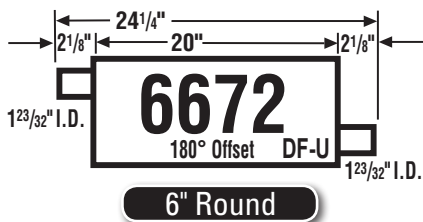

79-95 Pickup, Cab & Chassis, Camper, 4-Runner

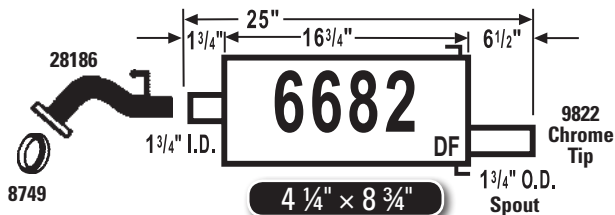

83-86 Camry

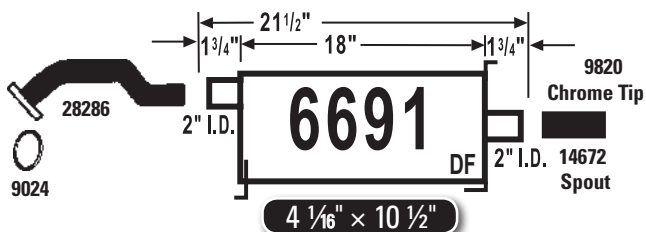

87-91 Camry (Welded Assembly Available)

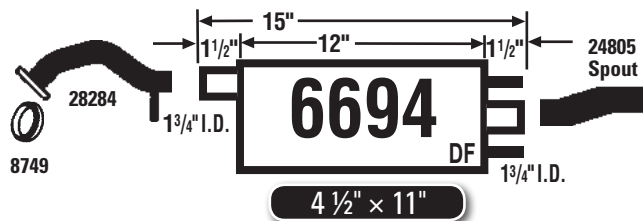

88-92 Corolla (Welded Assembly Available)

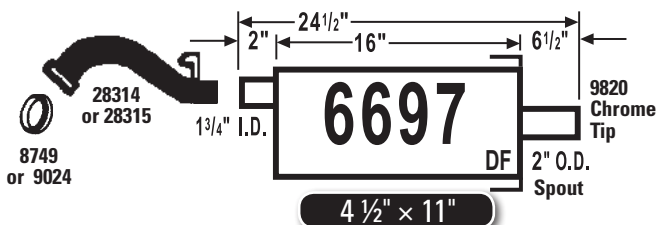

86-93 Celica

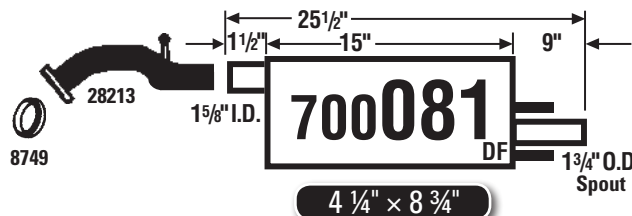

84-87 Corolla (exc. Diesel)

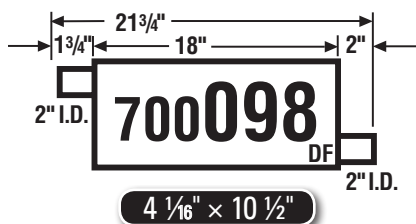

03-08 Matrix

NOTE: Black area denotes welded head bracket.

DF-U - Denotes muffler used primarily as Direct Fit, but is also Universal.

U-DF - Denotes muffler used primarily as Universal, but is also Direct Fit.

DF - Direct Fit Muffler

U - Universal Muffler

HS - Denotes Heat Shield is on muffler.

TOYOTA

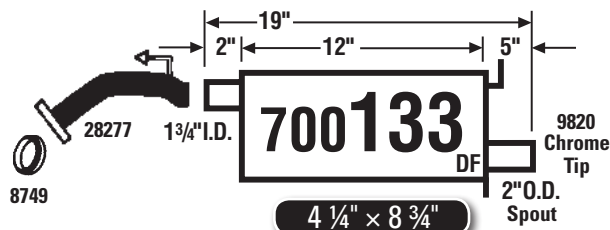

87-88 Corolla FX, FX16, FX16 GTS

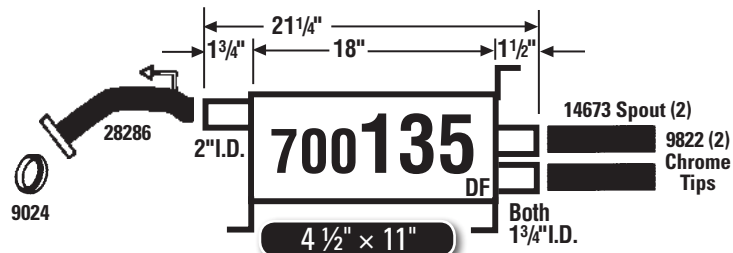

89-91 Camry Sedan, Wagon (exc. AWD)



88-95 Pickup, Cab & Chassis, 4-Runner

93-97 T100 Pickup

95-04 Tacoma Pickup

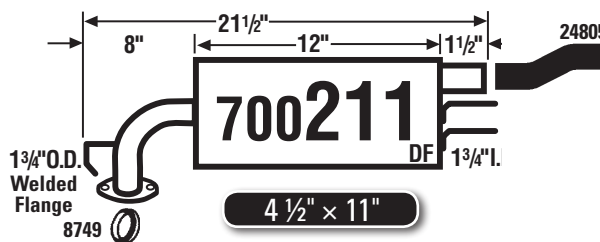

93-97 Corolla (Welded Assembly Available)

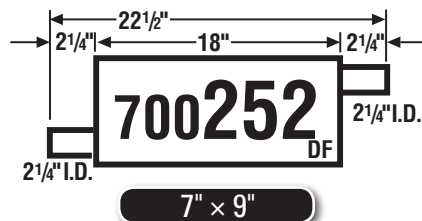

95-16 Tacoma Pickup

95-98 T100 Pickup

00-06 Tundra Pickup

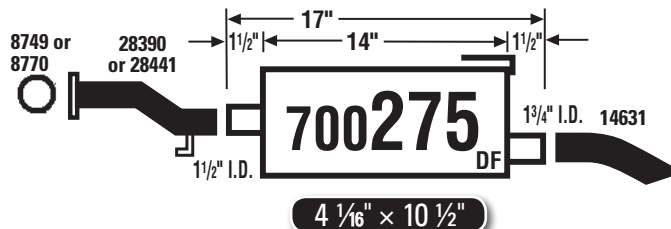

92-95 Paseo

91-94 Tercel

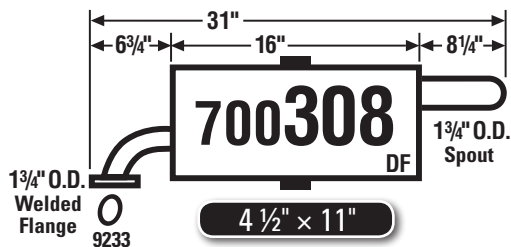

98-02 Corolla

NOTE: Black area denotes welded head bracket.

DF-U - Denotes muffler used primarily as Direct Fit, but is also Universal.

U-DF - Denotes muffler used primarily as Universal, but is also Direct Fit.

DF - Direct Fit Muffler

U - Universal Muffler

HS - Denotes Heat Shield is on muffler.

TOYOTA



96-97 RAV-4



98-00 RAV-4

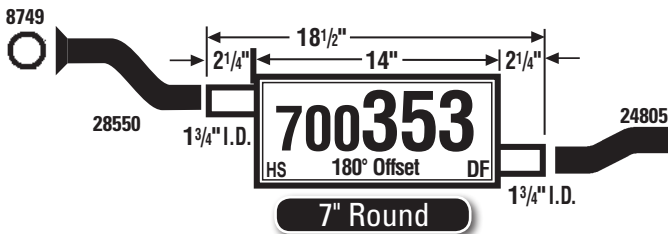

96-97 Paseo
95-98 Tercel

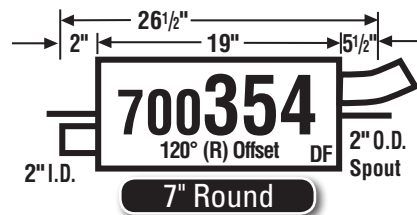

91-96 Previa, All Trac (94-96)

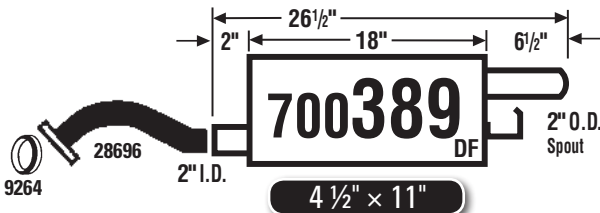

03-13 Corolla, 4-Dr. Sedan

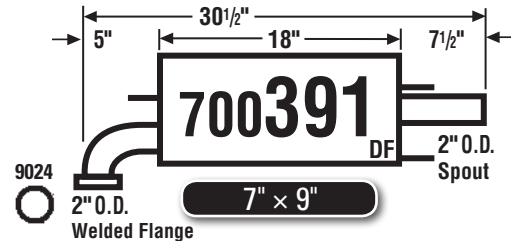

97-01 Camry Sedan, 4 cyl.
02-03 Solara, 4 cyl.

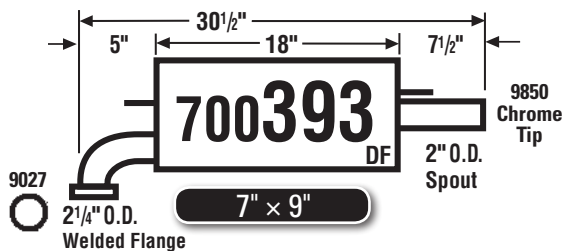

97-01 Camry Sedan 6 cyl.

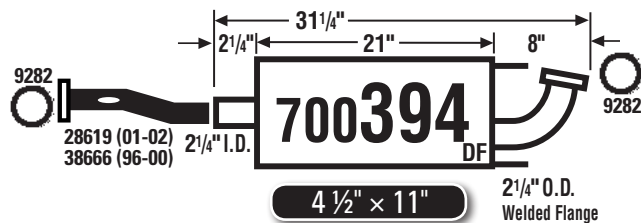

96-02 4 Runner 6 cyl. (exc. CA)

NOTE: Black area denotes welded head bracket.

DF-U - Denotes muffler used primarily as Direct Fit, but is also Universal.
U-DF - Denotes muffler used primarily as Universal, but is also Direct Fit.

DF - Direct Fit Muffler
U - Universal Muffler
HS - Denotes Heat Shield is on muffler.

TOYOTA

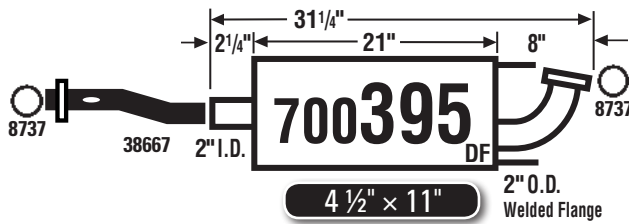

96-00 4 Runner 4 cyl.

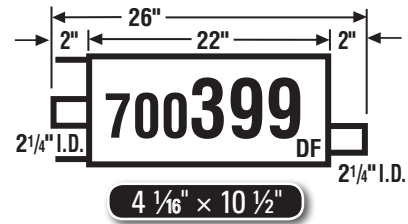

98-03 Sienna (exc. CA)

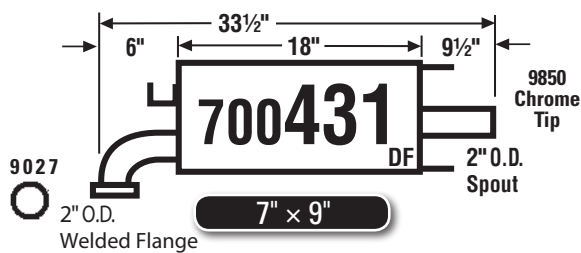

02-06 Camry
04-08 Solara

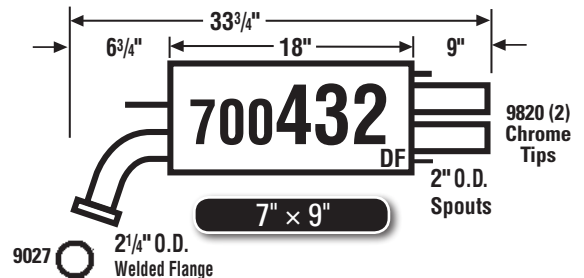

95-96 Camry Coupe, Sedan,
6 cyl.

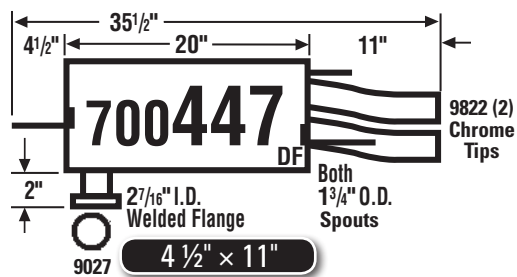

92-94 Camry 6 cyl.

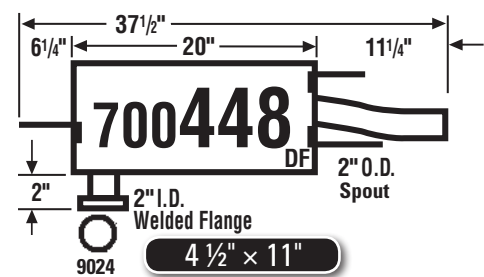

92-96 Camry 4 cyl.

NOTE: Black area denotes welded head bracket.

DF-U - Denotes muffler used primarily as Direct Fit, but is also Universal.

U-DF - Denotes muffler used primarily as Universal, but is also Direct Fit.

DF - Direct Fit Muffler

U - Universal Muffler

HS - Denotes Heat Shield is on muffler.

VOLKSWAGEN

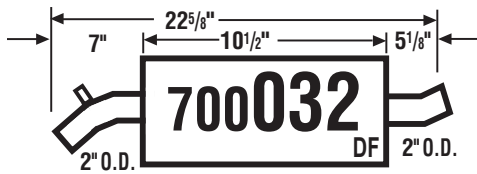

3 1/4" x 7 3/4"

- 85-92 Golf, GT, GTI (Front)
- 85-87 Jetta (exc. Diesel)

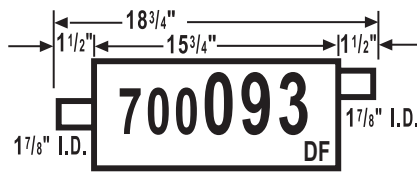

3 1/4" x 7 3/4"

- 85-92 Golf, Jetta (Rear)

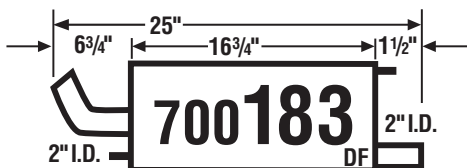

4 1/4" x 8 3/4"

- 93-99 Jetta (Rear)
- 93-97 Golf (Rear)
- 95-02 Cabriolet (Rear)

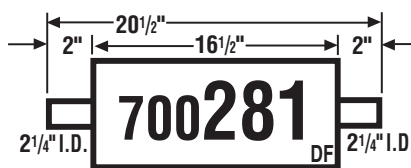

3 1/4" x 7 3/4"

- 90-94 Passat Sedan, Sta. Wag. (Rear)

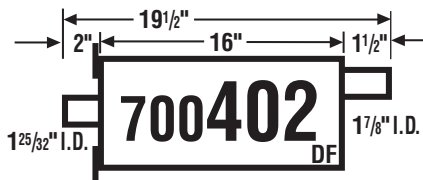

4 1/4" x 8 3/4"

- 84-93 Cabriolet
- 84-87 Scirocco (exc. 16V)

NOTE: Black area denotes welded head bracket.

DF-U - Denotes muffler used primarily as Direct Fit, but is also Universal.
 U-DF - Denotes muffler used primarily as Universal, but is also Direct Fit.

DF - Direct Fit Muffler
 U - Universal Muffler
 HS - Denotes Heat Shield is on muffler.

VOLVO

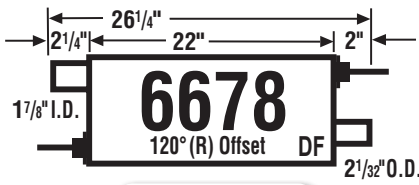

6" Round

- 84-93** 240 DL, GL
- 80-85** 2-Dr. (80-84), 4-Dr. Sedan, Sta. Wag.
- 75-80** 240 Series
- 75-76** 260 Series

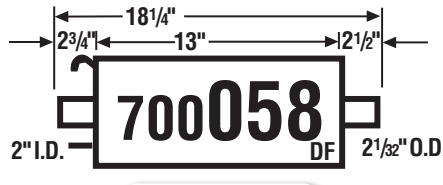

6" Round

- 84-93** 240 DL, GL (exc. turbo) (Front)
- 80-85** Sedan, Sta. Wag. (Front)
- 80-83** DL Sedan, Sta. Wag. (exc. turbo) (Front)
- 77-82** Series 242, 244, 245, 262, 264, 265 (Front)

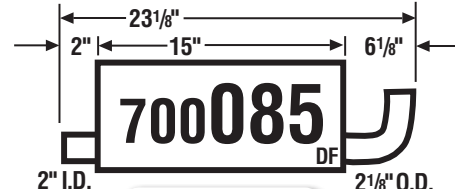

6" Round

- 91-95** 940, 940 GLE (1991)
- 85-92** 740
- 83-90** 760, 780 (86-87)



4 1/4" x 8 3/4"

- 91-95** 940, 940 GLE (1991), (exc. turbo) (Rear)
- 88-92** 740, (exc. turbo); 760, 780 (88-91) (Rear)

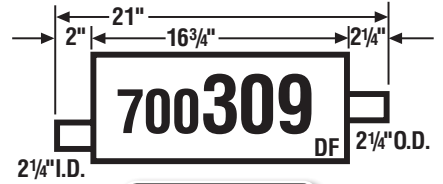

4 1/4" x 8 3/4"

- 88-92** 700 Series (Rear)
- 91-95** 900 Series (Rear)

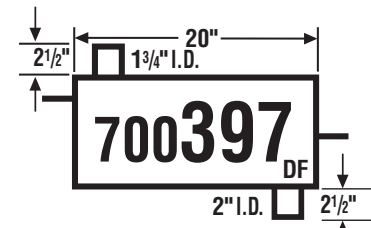

4 1/16" x 10 1/2"

- 93-97** 850 (exc. Turbo)
- 98-00** C70, S70, V70 (exc. Turbo)

MSL MUFFLER BY APPLICATION

NOTE: Black area denotes welded head bracket.

DF-U - Denotes muffler used primarily as Direct Fit, but is also Universal.
U-DF - Denotes muffler used primarily as Universal, but is also Direct Fit.

DF - Direct Fit Muffler
U - Universal Muffler
HS - Denotes Heat Shield is on muffler.

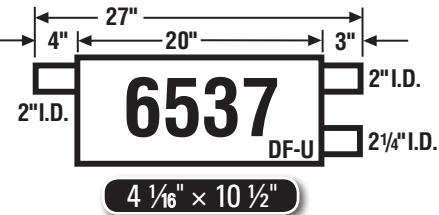
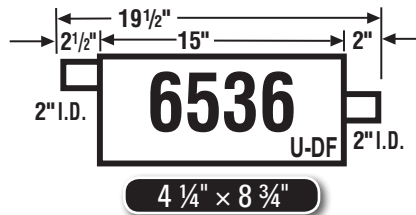
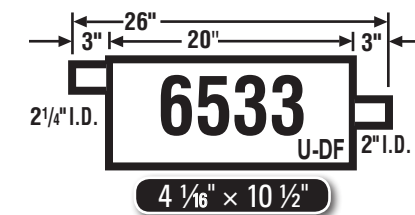
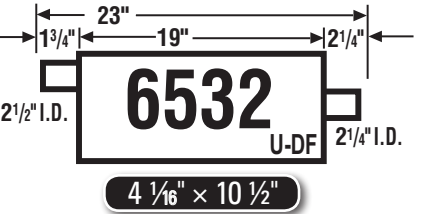
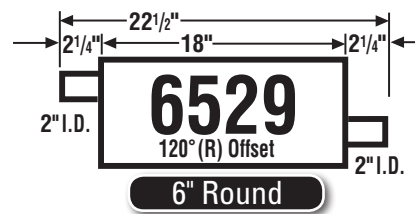
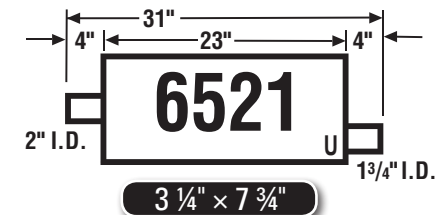
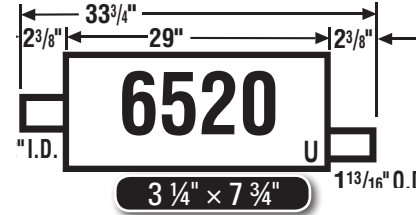
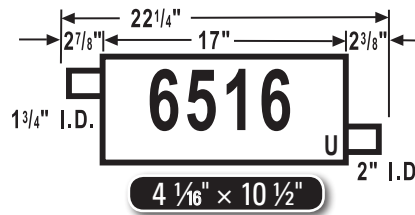
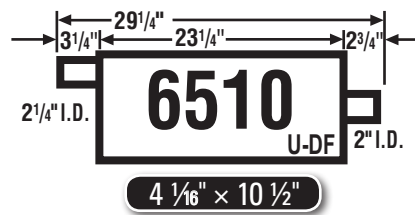
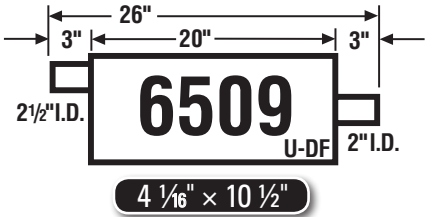
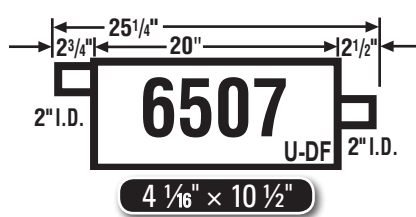
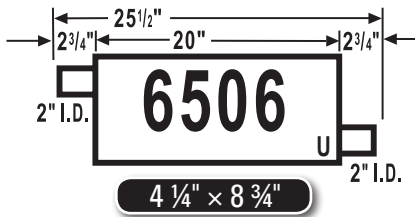
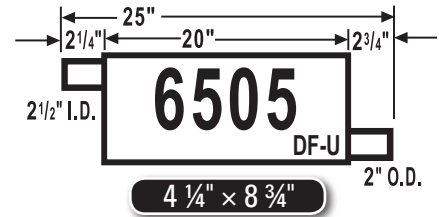
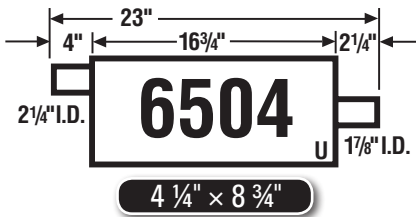
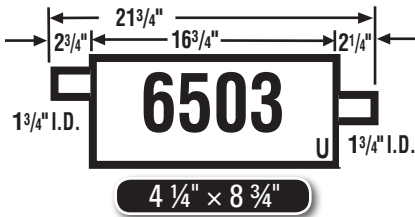

TRANSVERSE

NOTE: Black area denotes welded head bracket.

DF-U - Denotes muffler used primarily as Direct Fit, but is also Universal.
U-DF - Denotes muffler used primarily as Universal, but is also Direct Fit.

DF - Direct Fit Muffler
U - Universal Muffler
HS - Denotes Heat Shield is on muffler.

MUFFLER SPECS

by PART NUMBER

MAXIMUM **MSL**

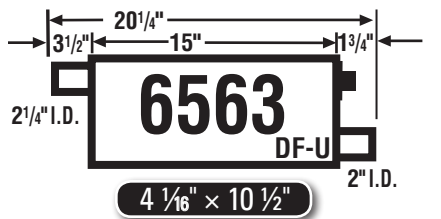
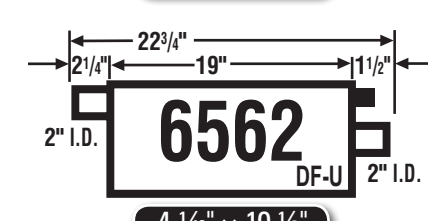
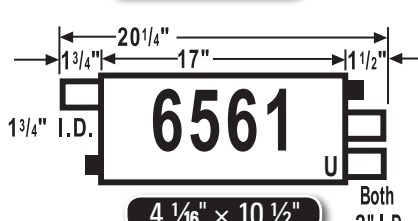
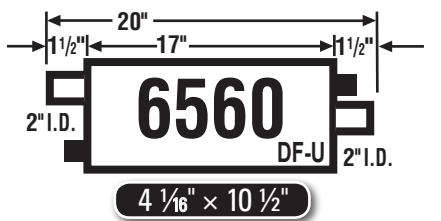
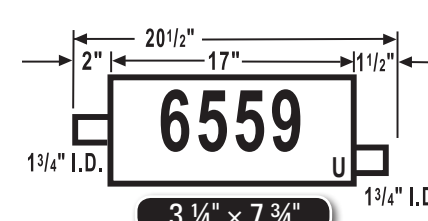
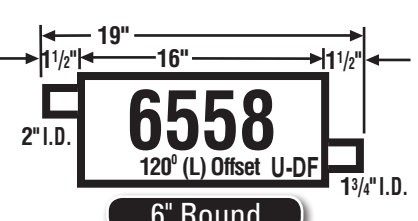
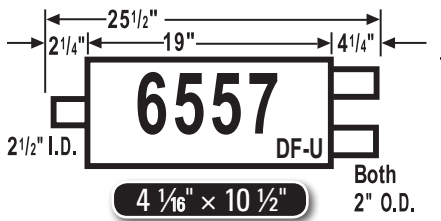
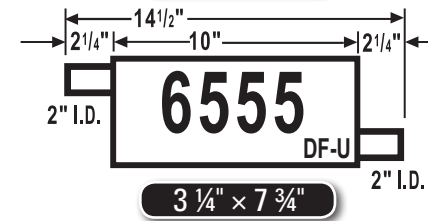
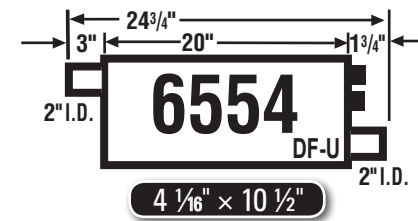
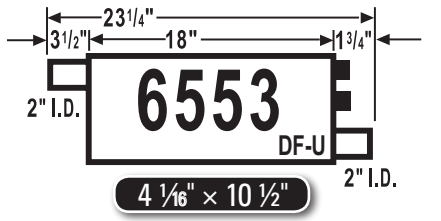
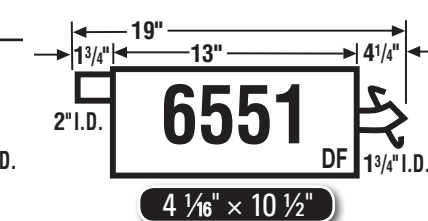
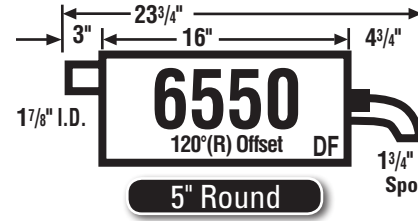
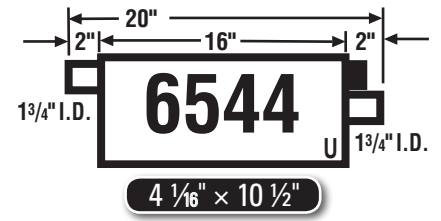
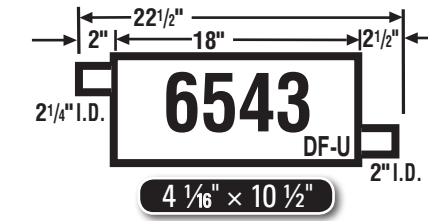
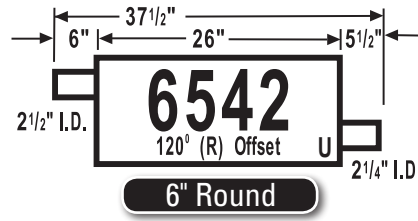
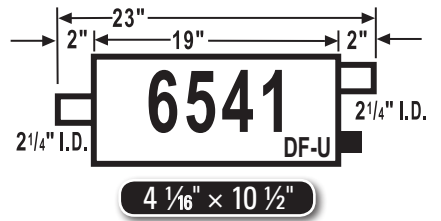
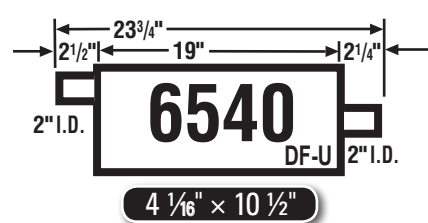
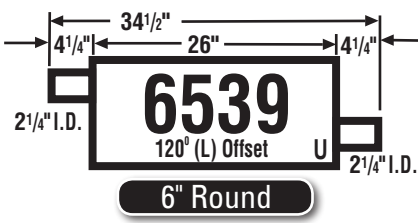
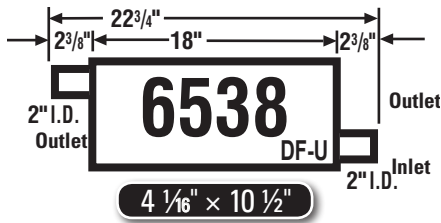

MSL BY PART NUMBER

NOTE: Black area denotes welded head bracket.

DF-U - Denotes muffler used primarily as Direct Fit, but is also Universal.
 U-DF - Denotes muffler used primarily as Universal, but is also Direct Fit.

DF - Direct Fit Muffler
 U - Universal Muffler
 HS - Denotes Heat Shield is on muffler.

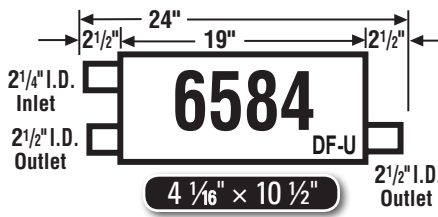
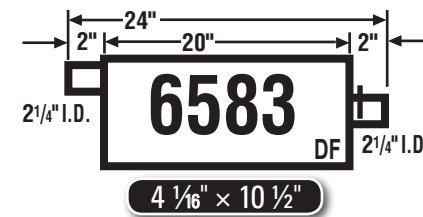
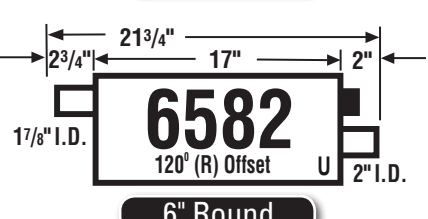
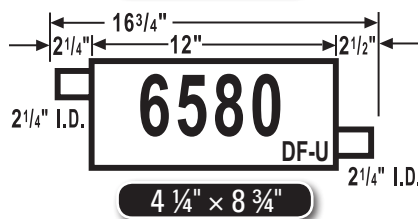
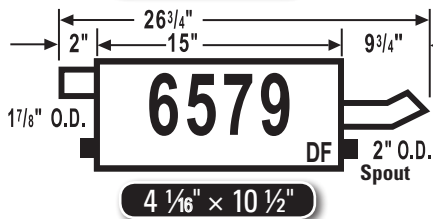
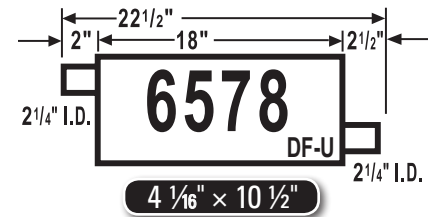
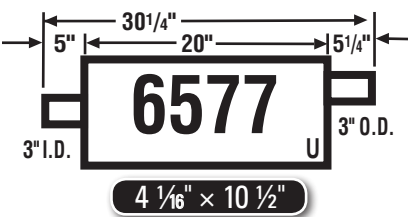
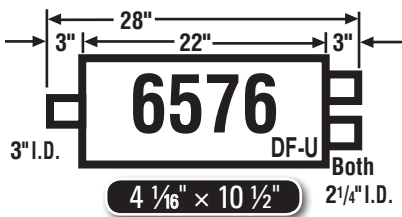
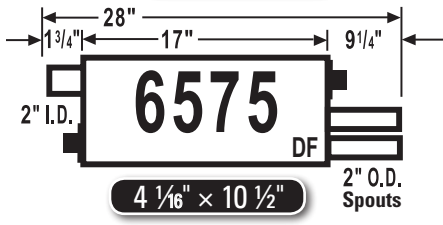
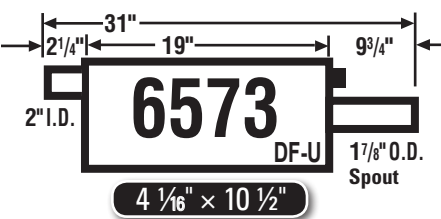
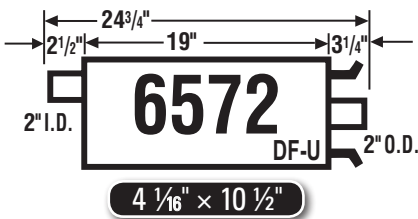
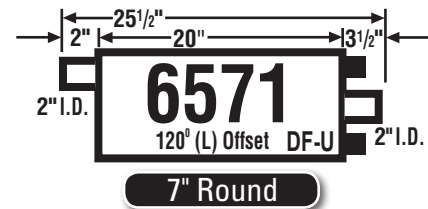
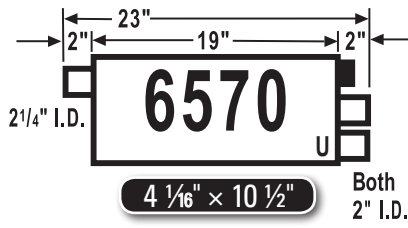
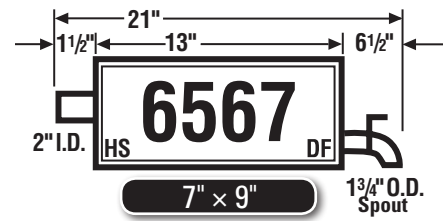
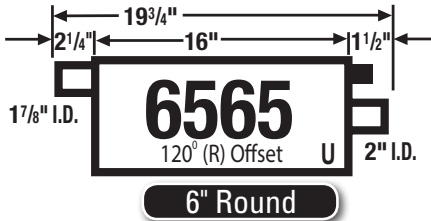
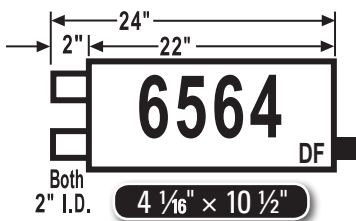

TRANSVERSE

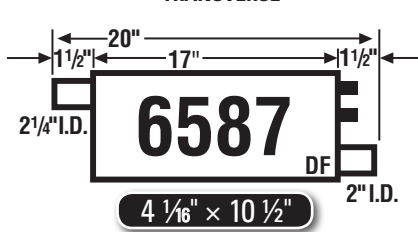
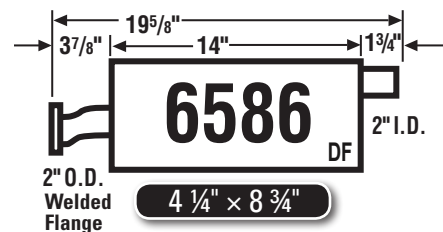

NOTE: Black area denotes welded head bracket.

DF-U - Denotes muffler used primarily as Direct Fit, but is also Universal.
 U-DF - Denotes muffler used primarily as Universal, but is also Direct Fit.

DF - Direct Fit Muffler
 U - Universal Muffler
 HS - Denotes Heat Shield is on muffler.

MUFFLER SPECS

by PART NUMBER

MAXIMUM **TMSL**

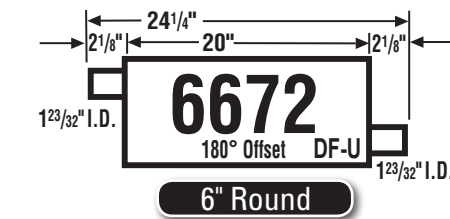
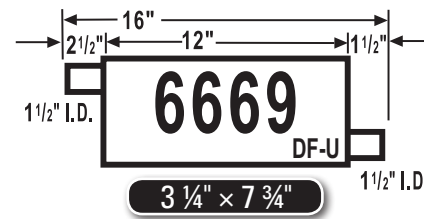
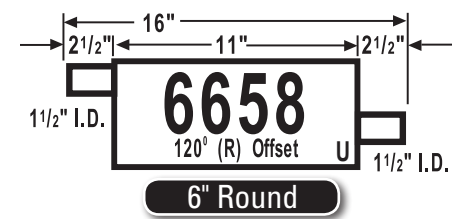
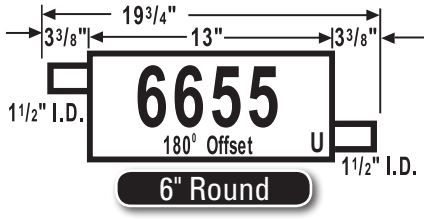
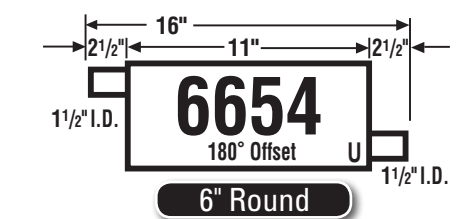
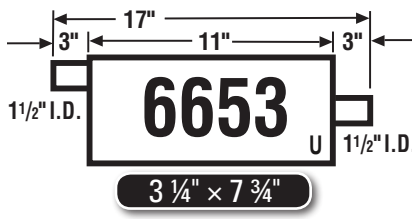
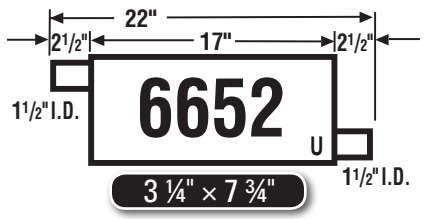
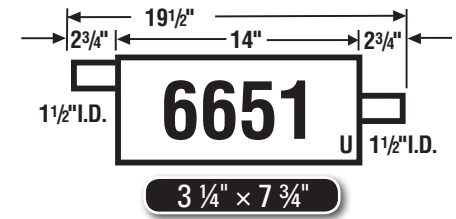
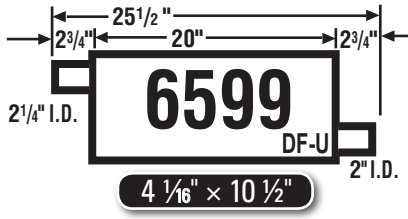
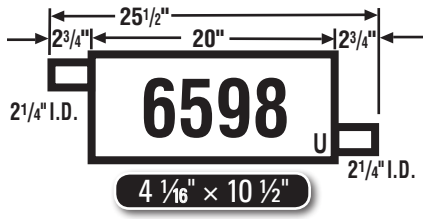
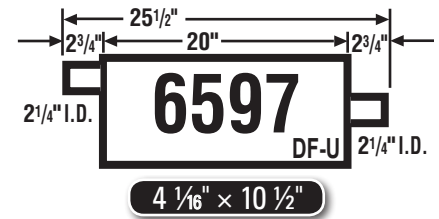
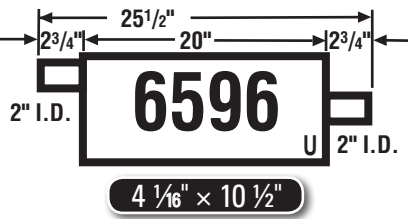
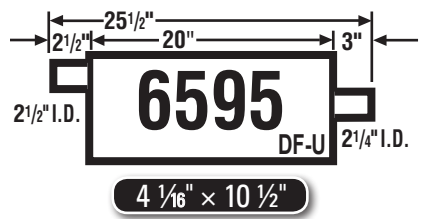
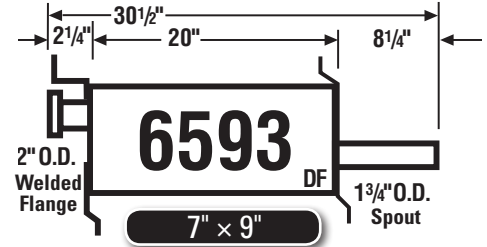
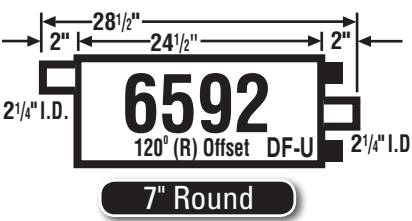
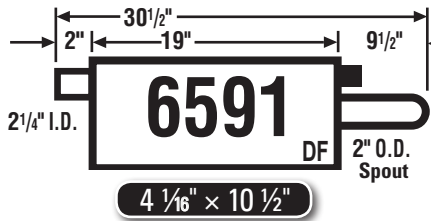
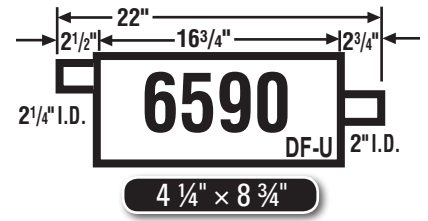
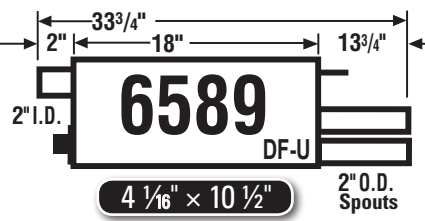
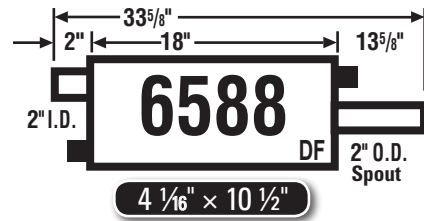

NOTE: Black area denotes welded head bracket.

DF-U - Denotes muffler used primarily as Direct Fit, but is also Universal.
 U-DF - Denotes muffler used primarily as Universal, but is also Direct Fit.

DF - Direct Fit Muffler
 U - Universal Muffler
 HS - Denotes Heat Shield is on muffler.

MSL BY PART NUMBER

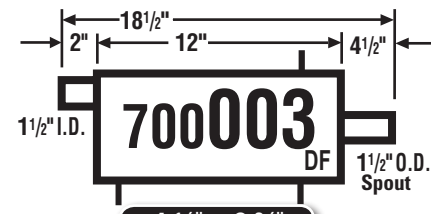
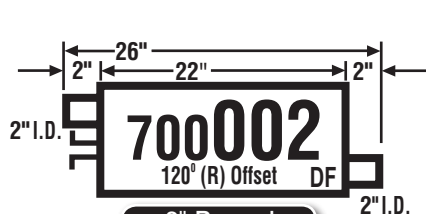
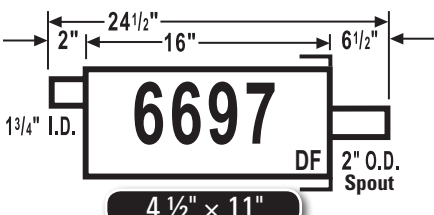
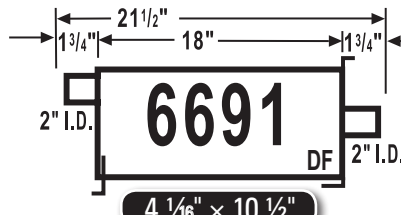
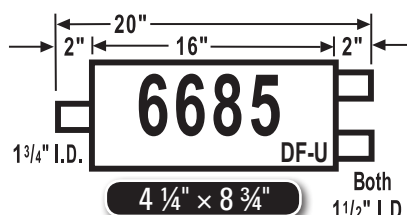
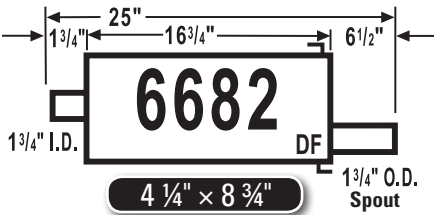
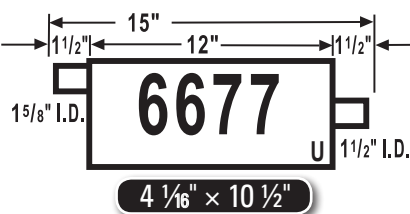
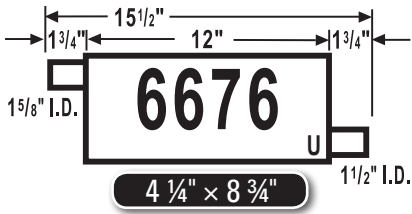

NOTE: Black area denotes welded head bracket.

DF-U - Denotes muffler used primarily as Direct Fit, but is also Universal.
 U-DF - Denotes muffler used primarily as Universal, but is also Direct Fit.

DF - Direct Fit Muffler
 U - Universal Muffler
 HS - Denotes Heat Shield is on muffler.

MUFFLER SPECS

by PART NUMBER

MAXIMUM **MSL**

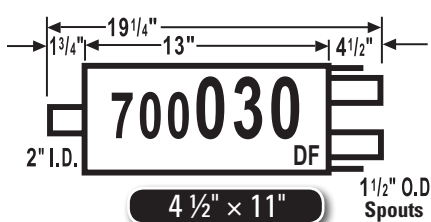
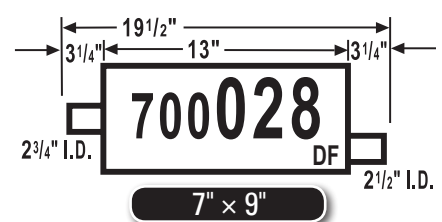
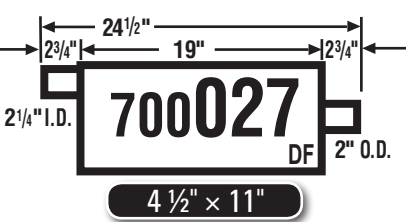
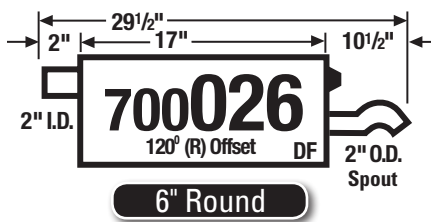
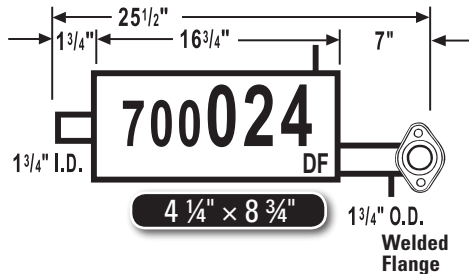
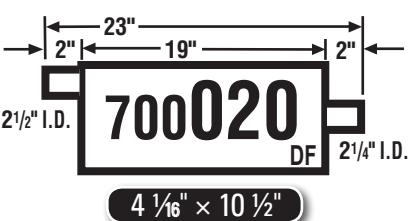
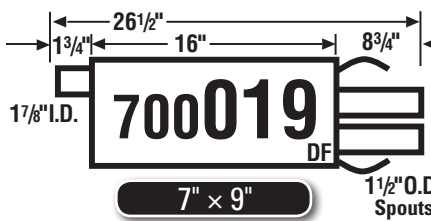
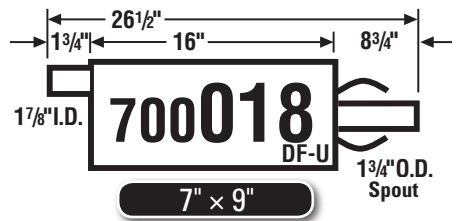
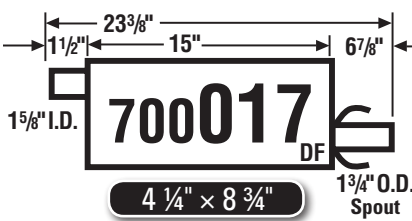
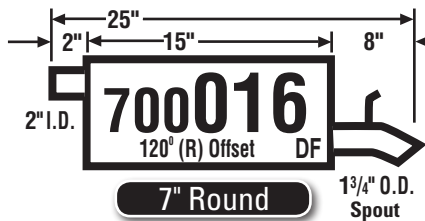
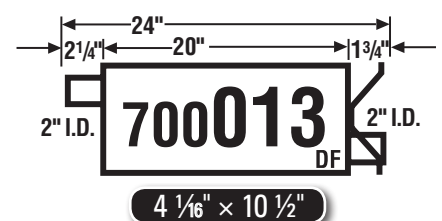
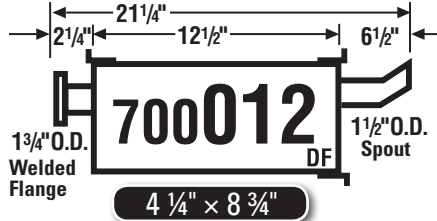
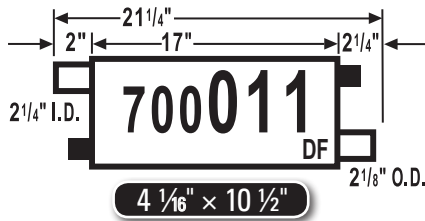
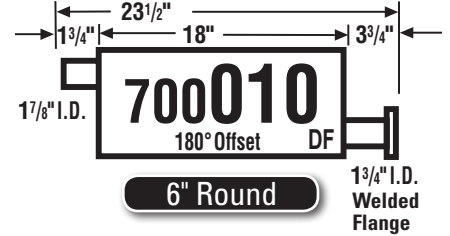
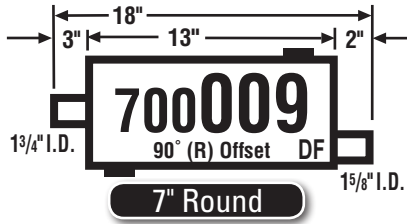
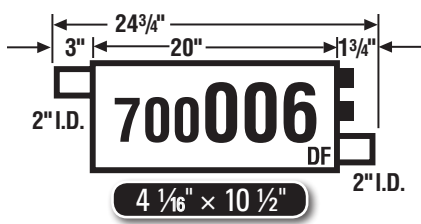

NOTE: Black area denotes welded head bracket.

DF-U - Denotes muffler used primarily as Direct Fit, but is also Universal.
U-DF - Denotes muffler used primarily as Universal, but is also Direct Fit.

DF - Direct Fit Muffler
U - Universal Muffler
HS - Denotes Heat Shield is on muffler.

MSL BY PART NUMBER

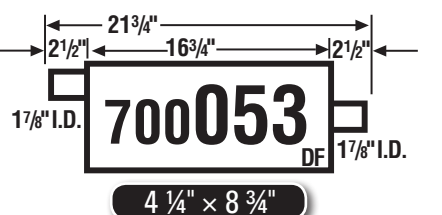
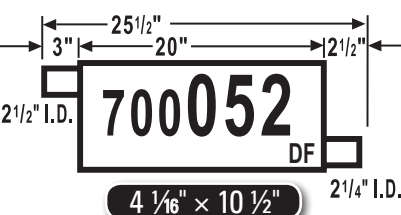
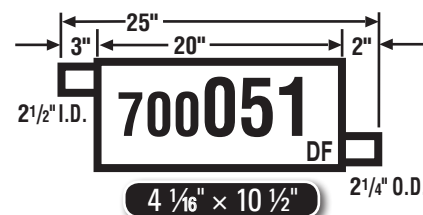
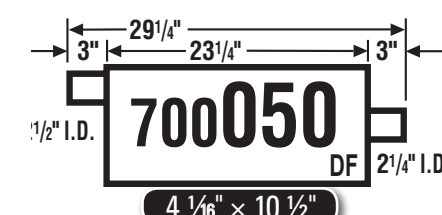
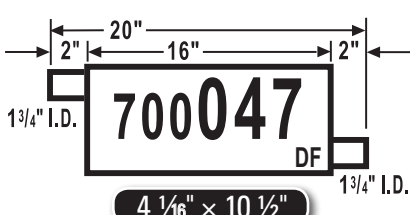
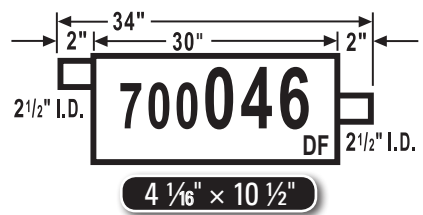
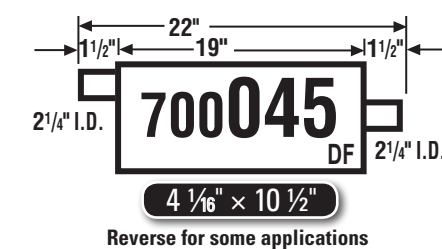
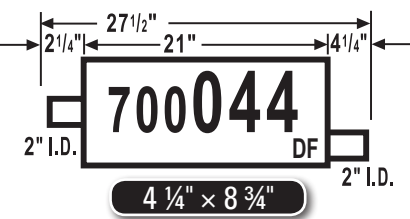
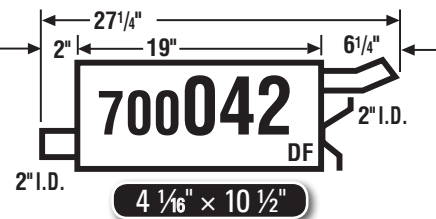
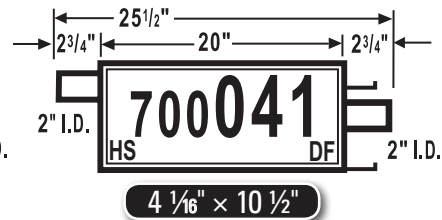
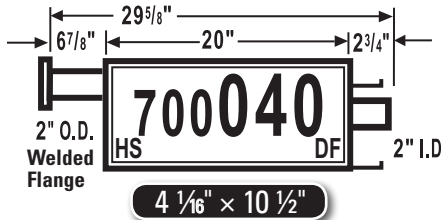
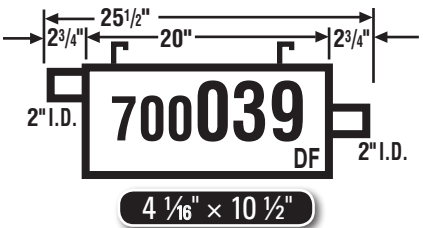
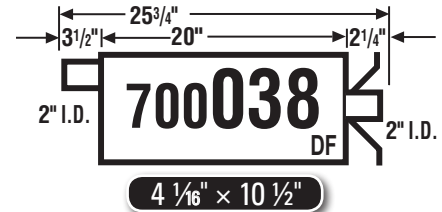
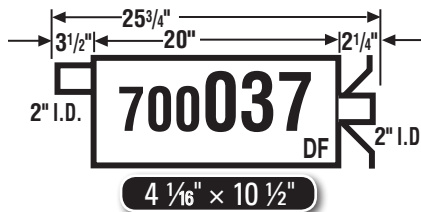
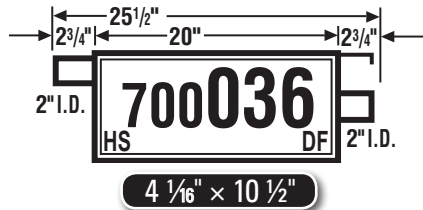
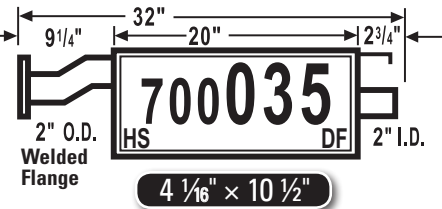
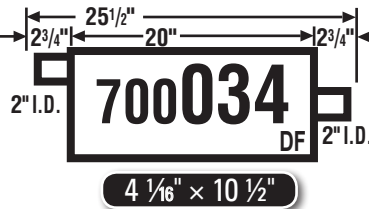
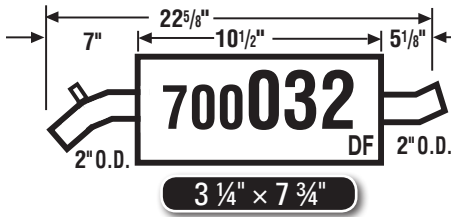

NOTE: Black area denotes welded head bracket.

DF-U - Denotes muffler used primarily as Direct Fit, but is also Universal.
U-DF - Denotes muffler used primarily as Universal, but is also Direct Fit.

DF - Direct Fit Muffler
U - Universal Muffler
HS - Denotes Heat Shield is on muffler.

MUFFLER SPECS

by PART NUMBER

MAXIMUM **MSL**

MSL BY PART NUMBER

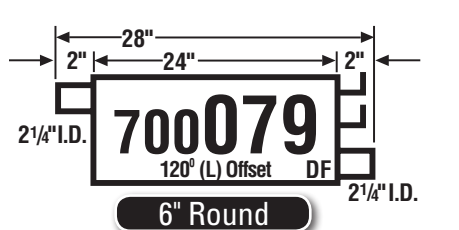
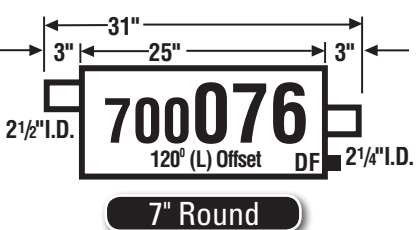
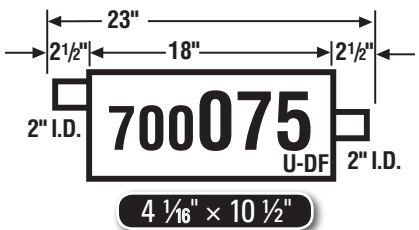
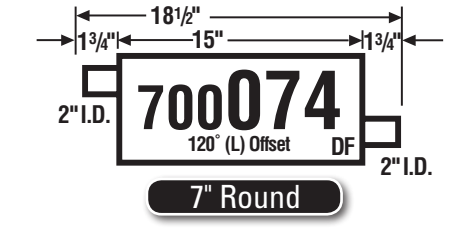
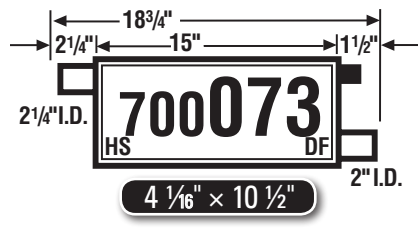
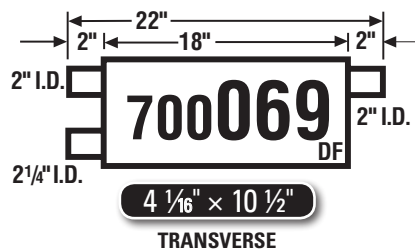
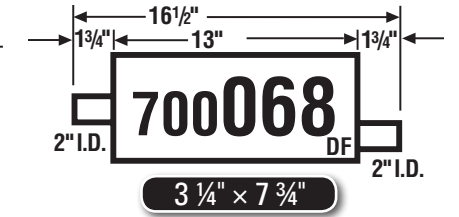
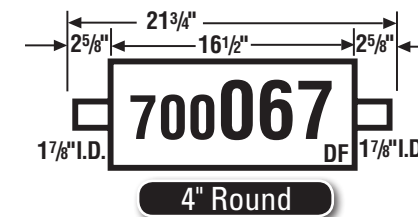
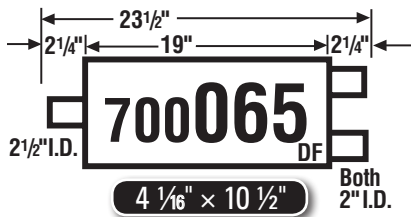
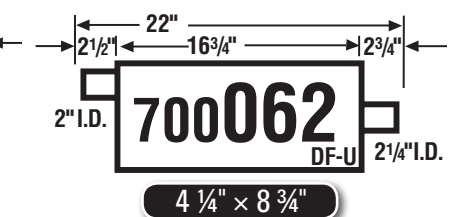
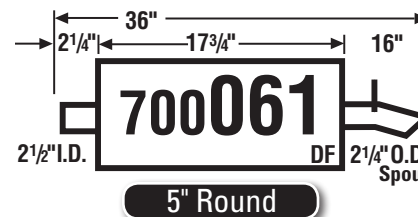
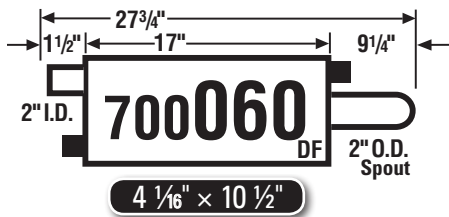
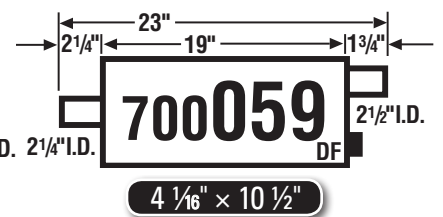
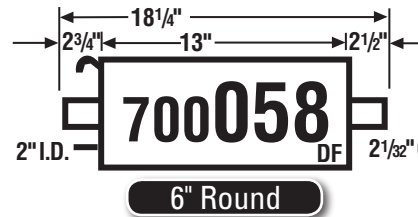
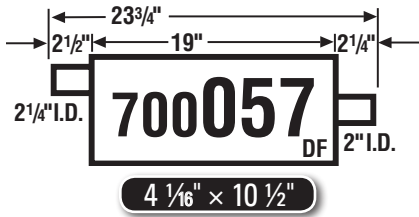
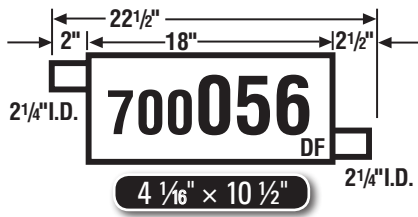

NOTE: Black area denotes welded head bracket.

DF-U - Denotes muffler used primarily as Direct Fit, but is also Universal.
U-DF - Denotes muffler used primarily as Universal, but is also Direct Fit.

DF - Direct Fit Muffler
U - Universal Muffler
HS - Denotes Heat Shield is on muffler.

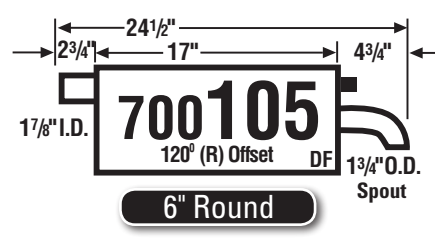
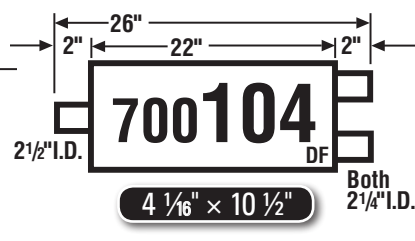
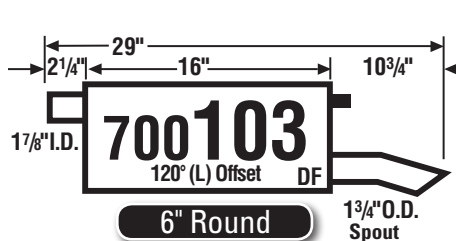
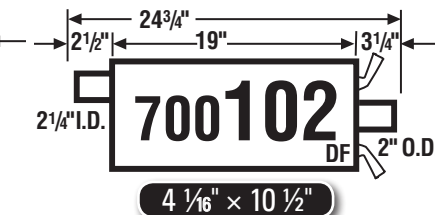
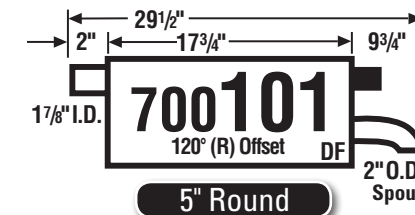
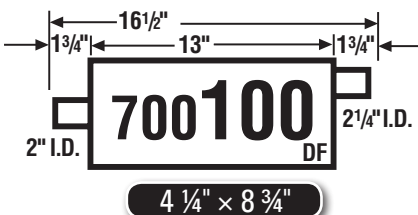
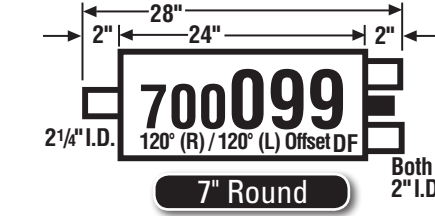
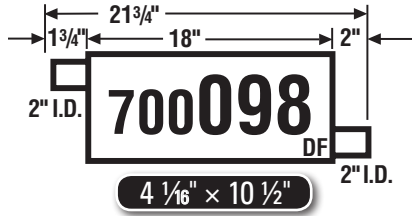
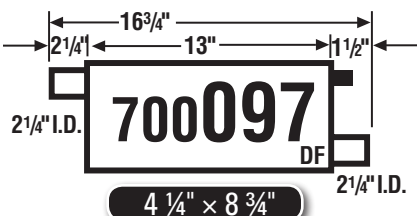
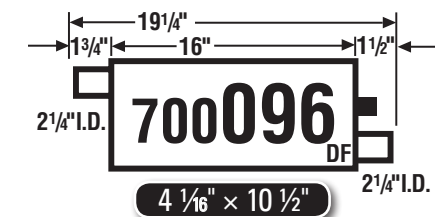
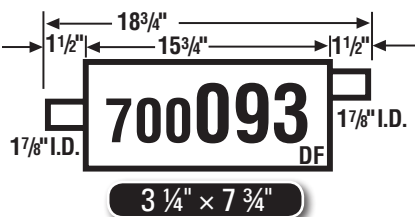
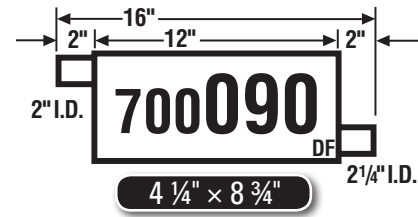
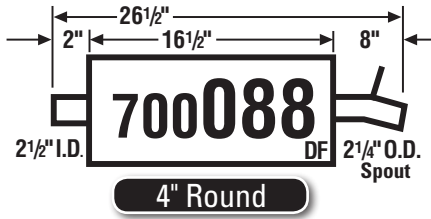
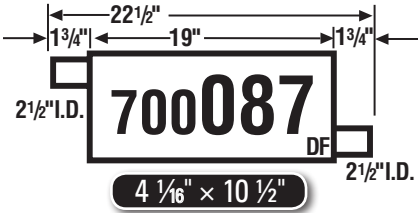
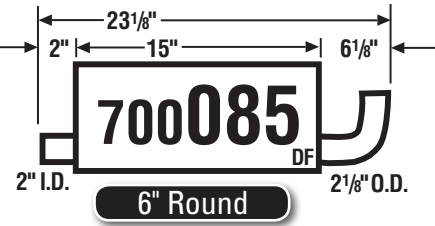
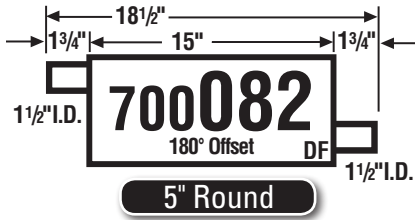
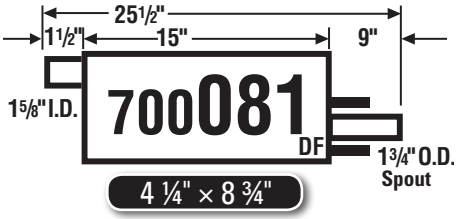

NOTE: Black area denotes welded head bracket.

DF-U - Denotes muffler used primarily as Direct Fit, but is also Universal.
 U-DF - Denotes muffler used primarily as Universal, but is also Direct Fit.

DF - Direct Fit Muffler
 U - Universal Muffler
 HS - Denotes Heat Shield is on muffler.

MUFFLER SPECS

by PART NUMBER

MAXIMUM **MSL**[®]

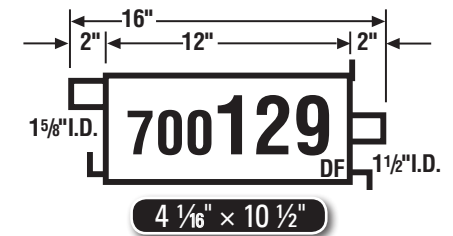
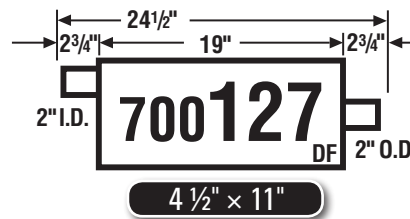
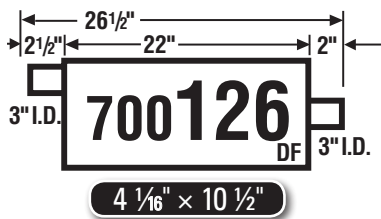
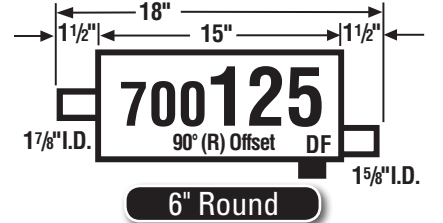
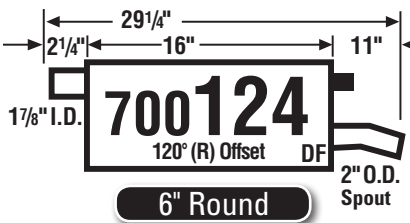
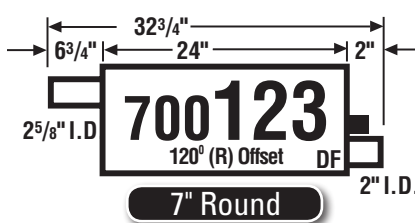
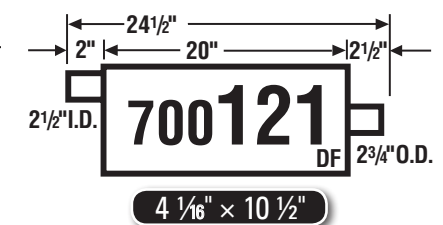
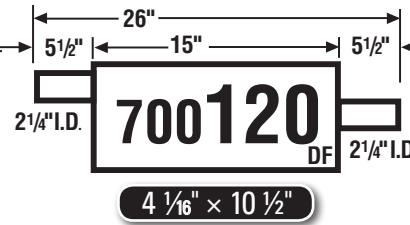
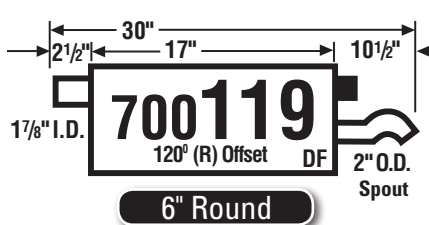
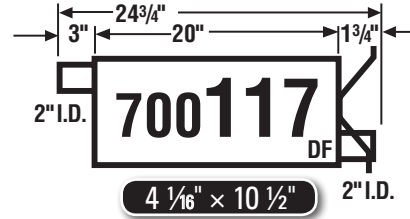
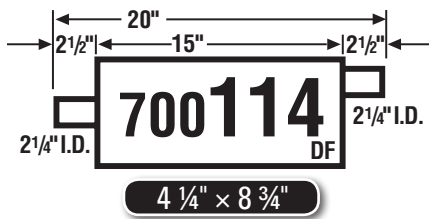
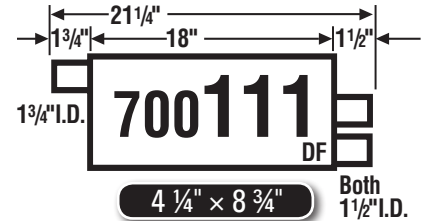
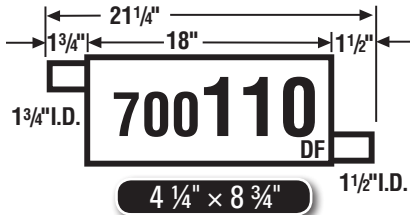
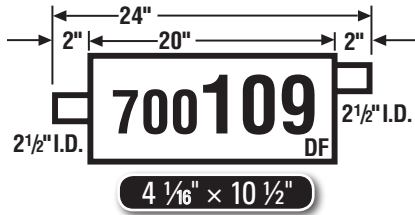
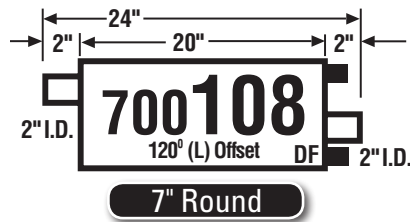
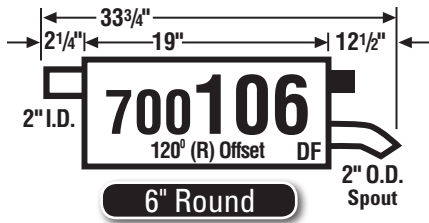

NOTE: Black area denotes welded head bracket.

DF-U - Denotes muffler used primarily as Direct Fit, but is also Universal.
U-DF - Denotes muffler used primarily as Universal, but is also Direct Fit.

DF - Direct Fit Muffler
U - Universal Muffler
HS - Denotes Heat Shield is on muffler.

MSL BY PART NUMBER

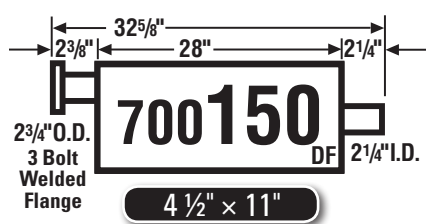
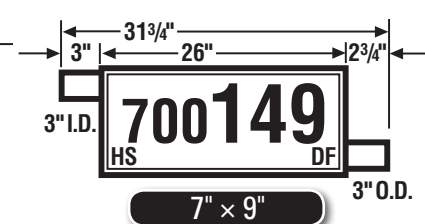
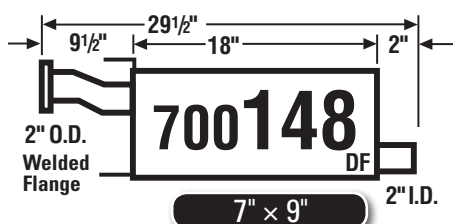
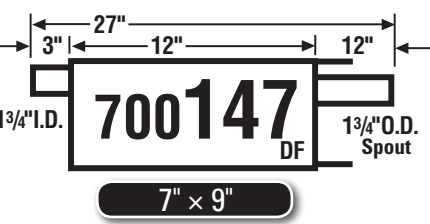
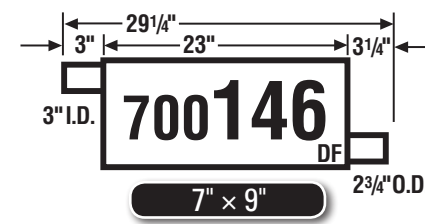
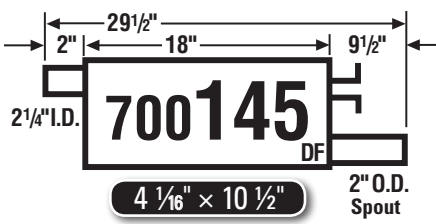
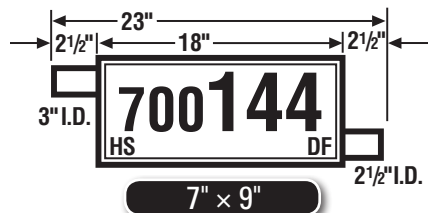
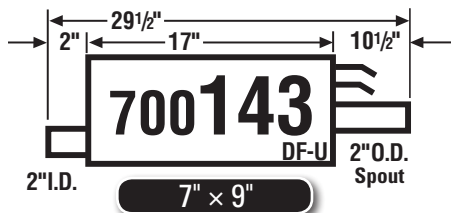
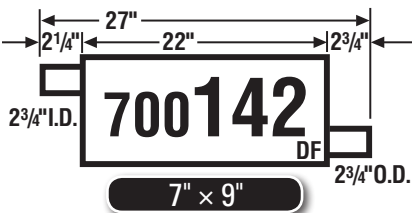
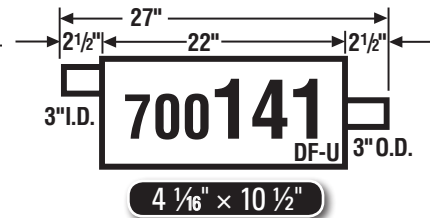
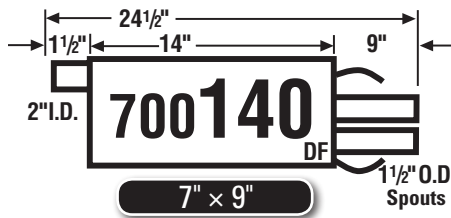
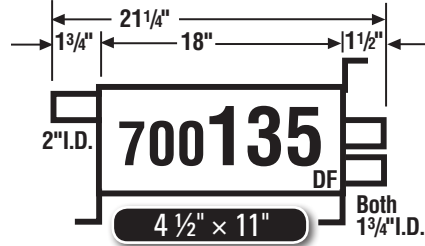
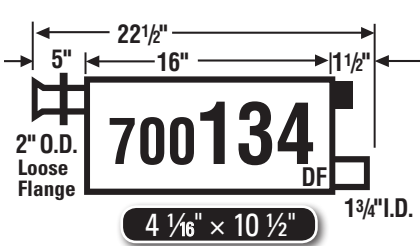
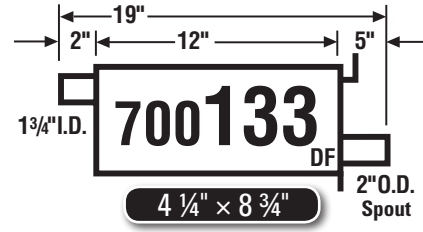
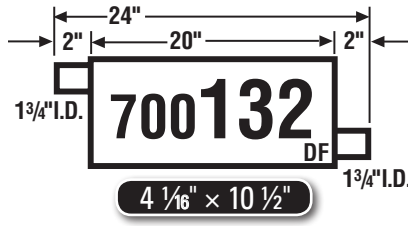
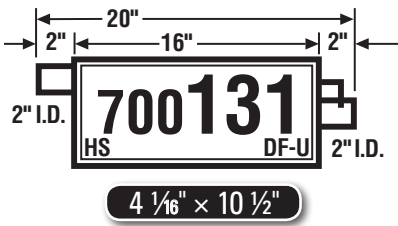

NOTE: Black area denotes welded head bracket.

DF-U - Denotes muffler used primarily as Direct Fit, but is also Universal.
 U-DF - Denotes muffler used primarily as Universal, but is also Direct Fit.

DF - Direct Fit Muffler
 U - Universal Muffler
 HS - Denotes Heat Shield is on muffler.

MUFFLER SPECS

by PART NUMBER

MAXIMUM **TMSL**

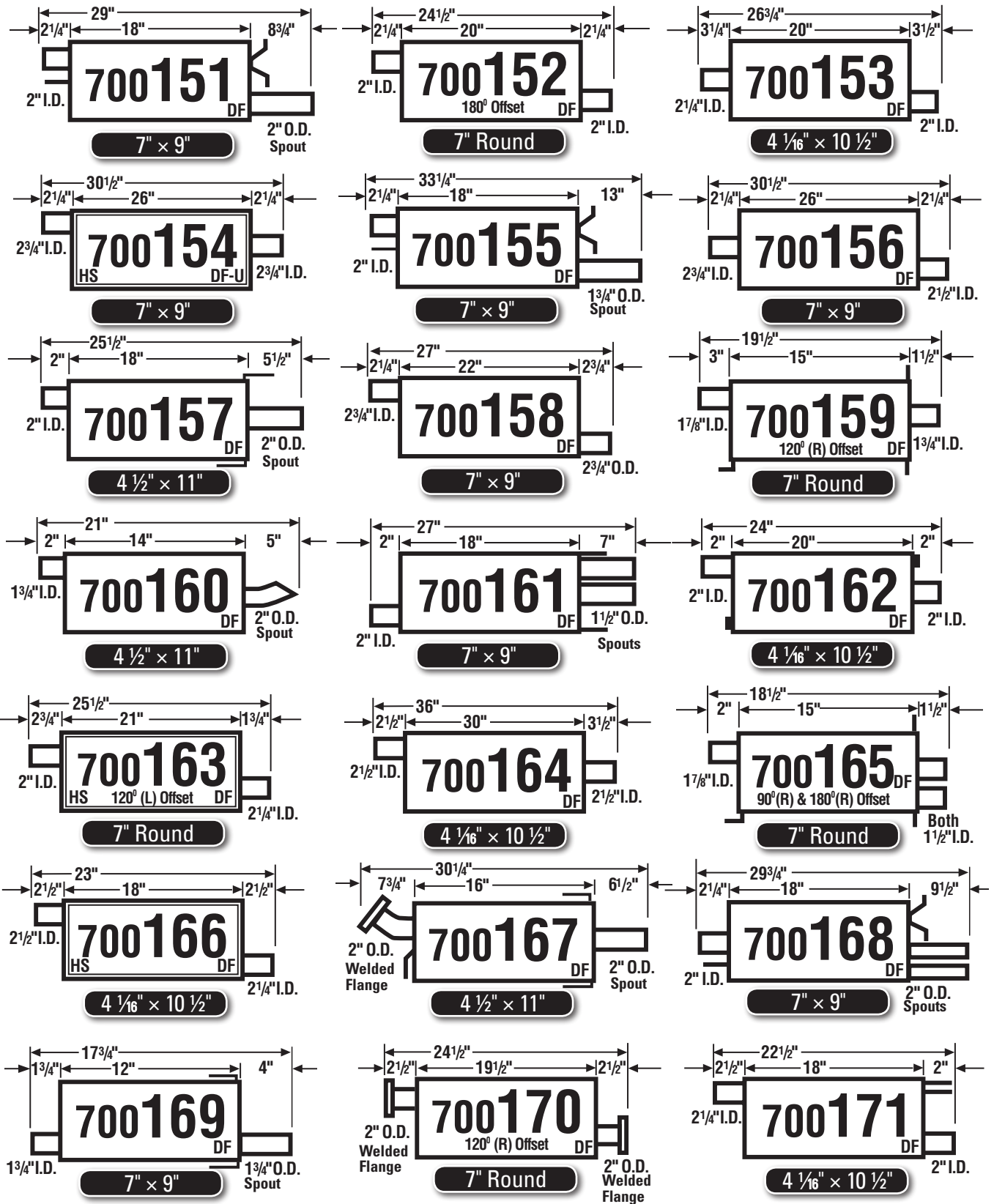

NOTE: Black area denotes welded head bracket.

DF-U - Denotes muffler used primarily as Direct Fit, but is also Universal.
 U-DF - Denotes muffler used primarily as Universal, but is also Direct Fit.

DF - Direct Fit Muffler
 U - Universal Muffler
 HS - Denotes Heat Shield is on muffler.

TMSL BY PART NUMBER

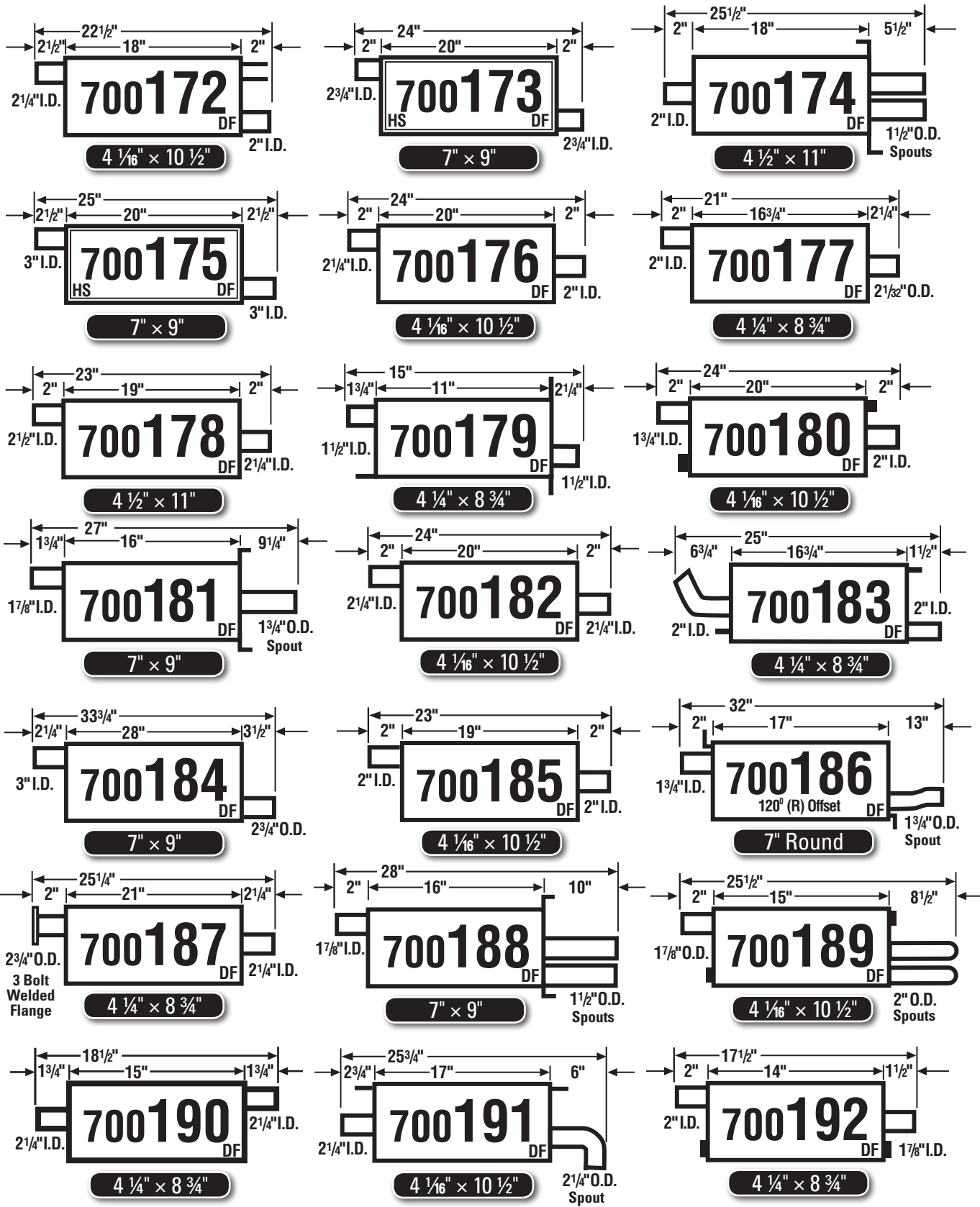

NOTE: Black area denotes welded head bracket.

DF-U - Denotes muffler used primarily as Direct Fit, but is also Universal.
 U-DF - Denotes muffler used primarily as Universal, but is also Direct Fit.

DF - Direct Fit Muffler
 U - Universal Muffler
 HS - Denotes Heat Shield is on muffler.

MUFFLER SPECS

by PART NUMBER

MAXIMUM **MSL**

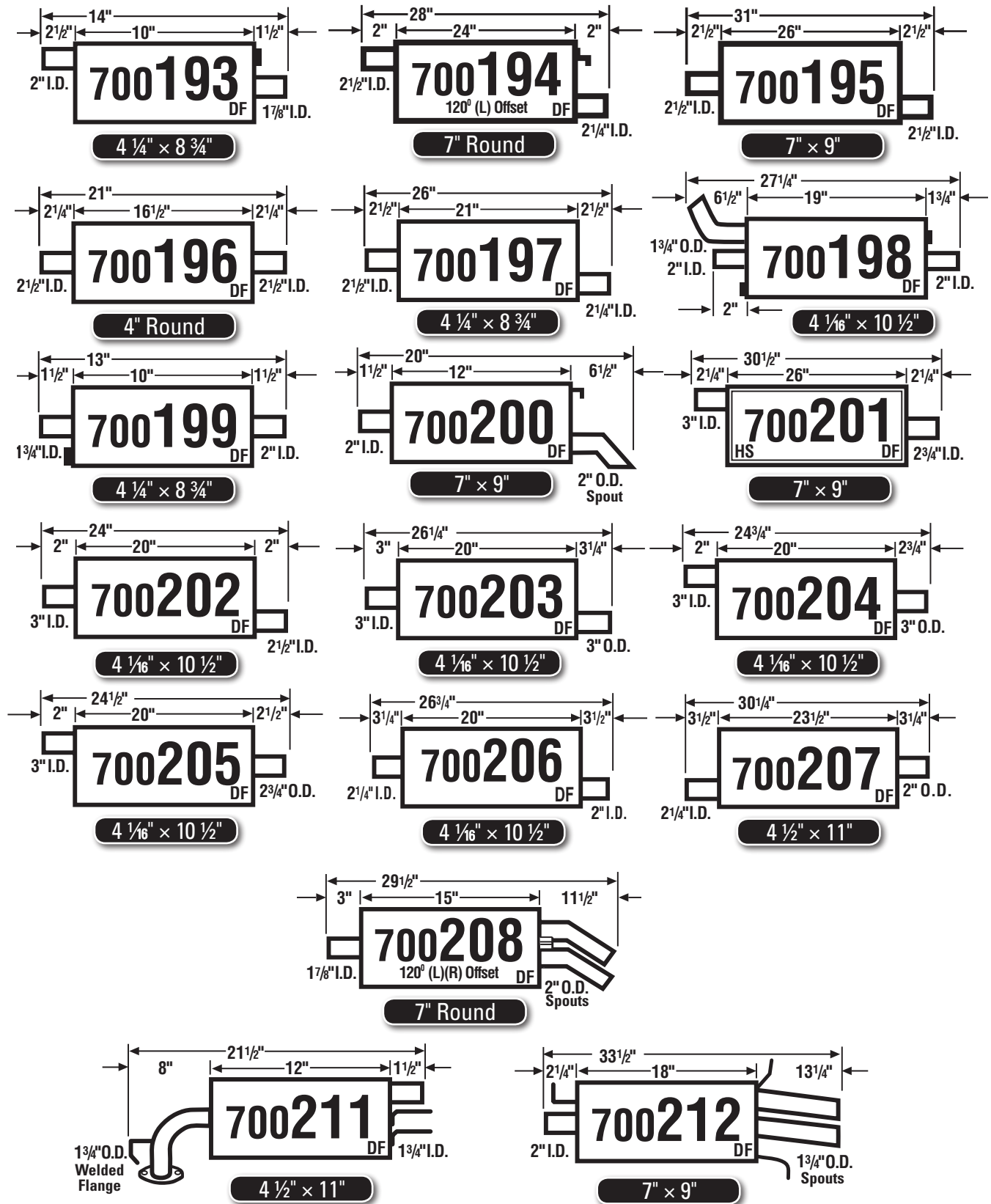

MSL BY PART NUMBER

NOTE: Black area denotes welded head bracket.

DF-U - Denotes muffler used primarily as Direct Fit, but is also Universal.
 U-DF - Denotes muffler used primarily as Universal, but is also Direct Fit.

DF - Direct Fit Muffler
 U - Universal Muffler
 HS - Denotes Heat Shield is on muffler.

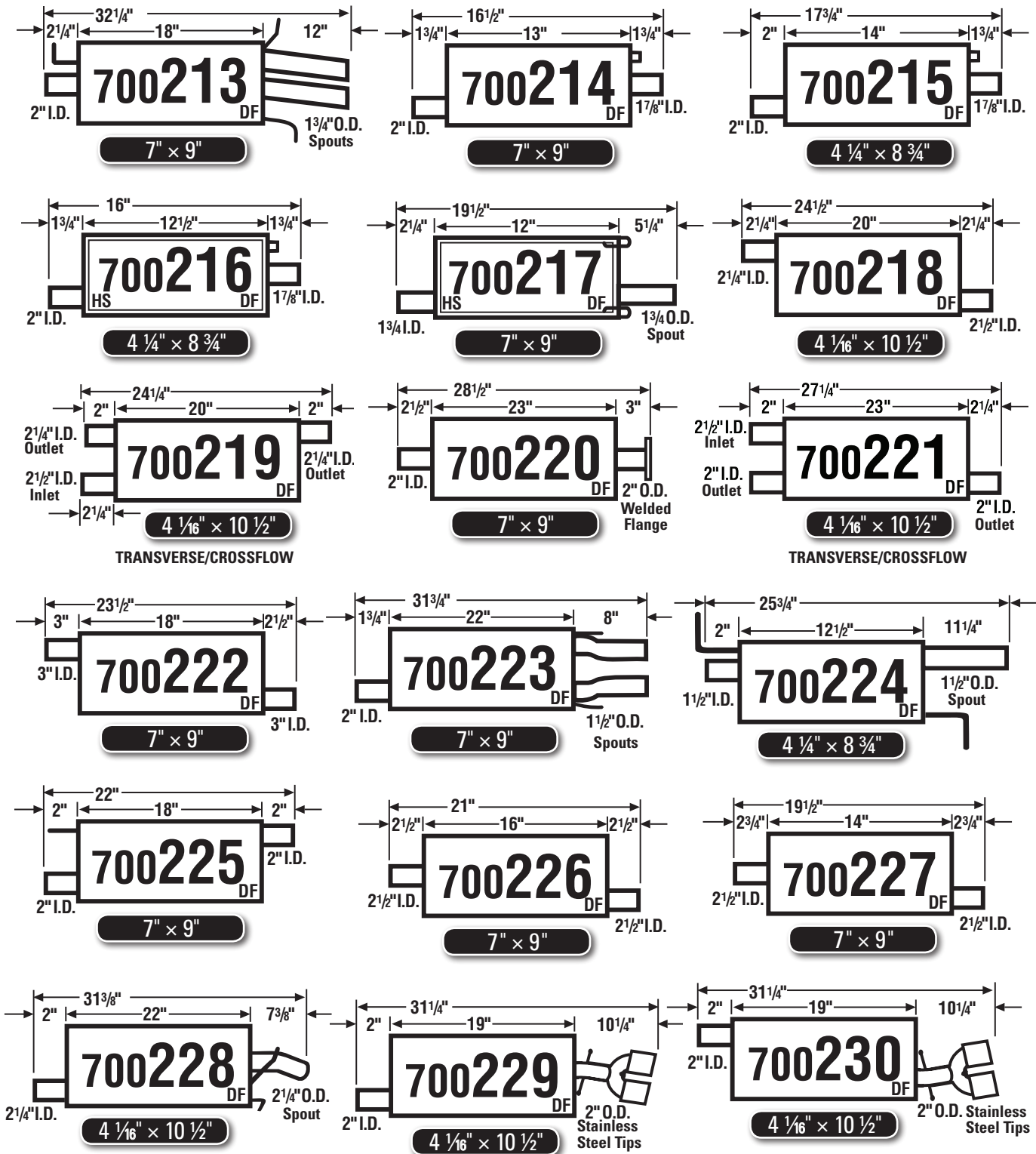

NOTE: Black area denotes welded head bracket.

DF-U - Denotes muffler used primarily as Direct Fit, but is also Universal.
 U-DF - Denotes muffler used primarily as Universal, but is also Direct Fit.

DF - Direct Fit Muffler
 U - Universal Muffler
 HS - Denotes Heat Shield is on muffler.

MUFFLER SPECS

by PART NUMBER

MAXIMUM **MSL**

MSL BY PART NUMBER

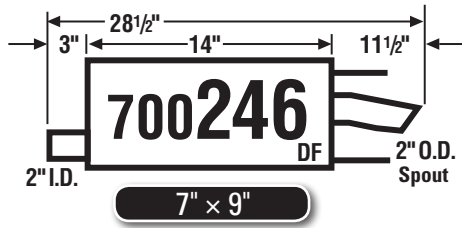
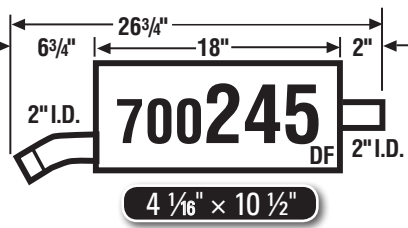
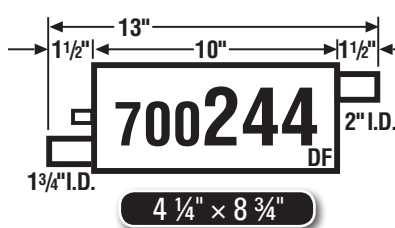
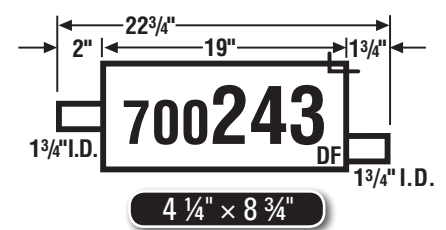
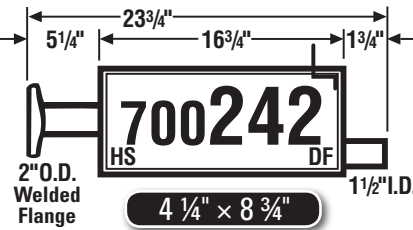
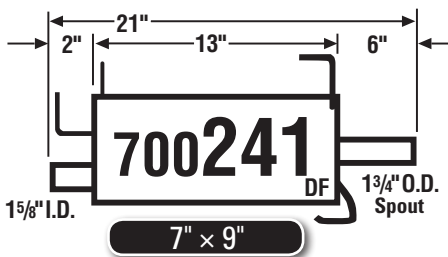
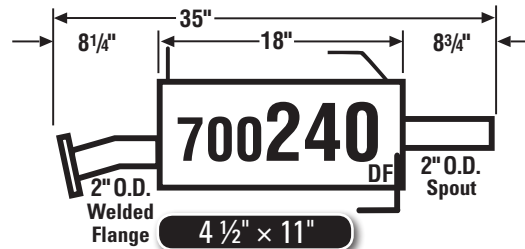
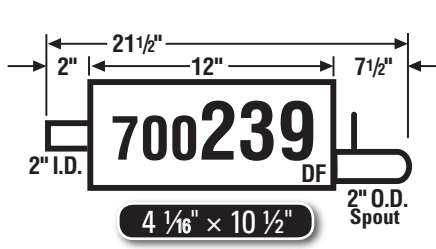
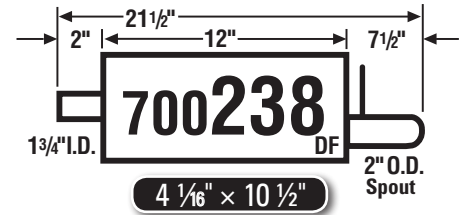
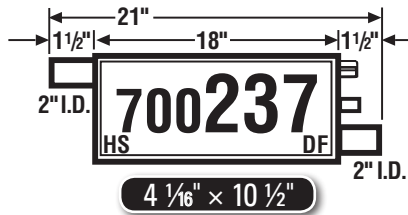
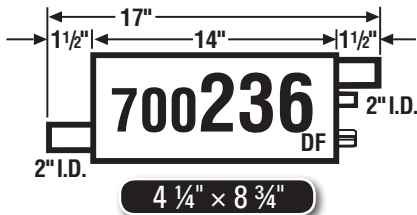
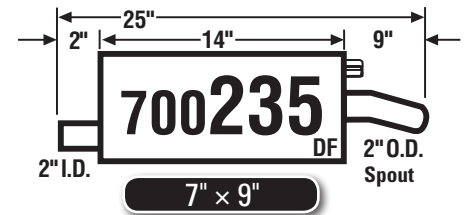
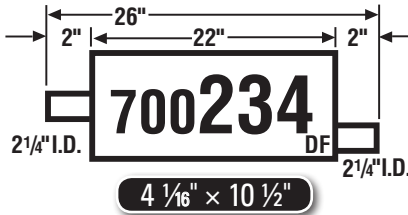
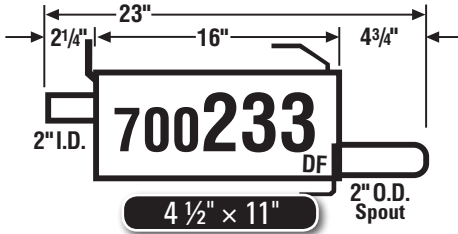
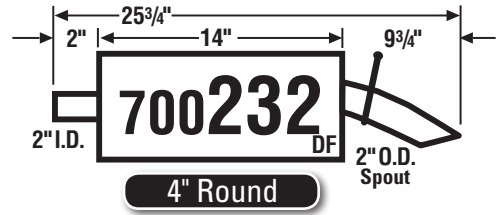
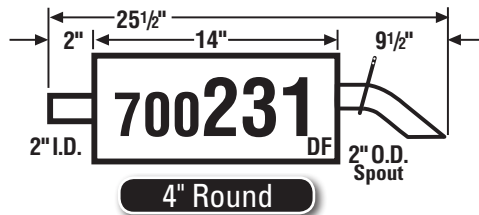

NOTE: Black area denotes welded head bracket.

DF-U - Denotes muffler used primarily as Direct Fit, but is also Universal.
U-DF - Denotes muffler used primarily as Universal, but is also Direct Fit.

DF - Direct Fit Muffler
U - Universal Muffler
HS - Denotes Heat Shield is on muffler.

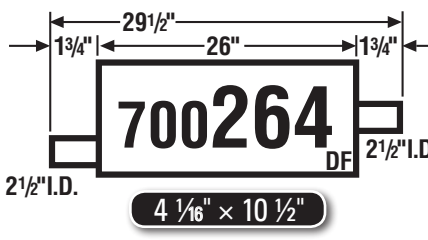
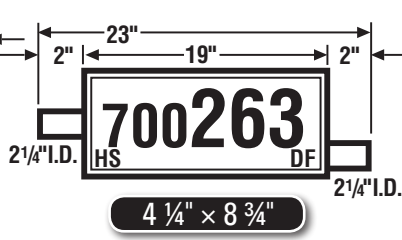
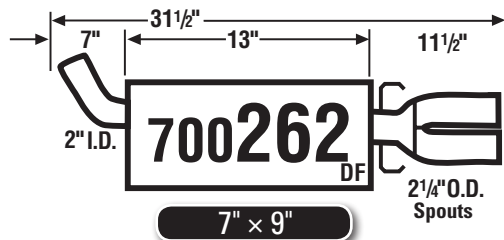
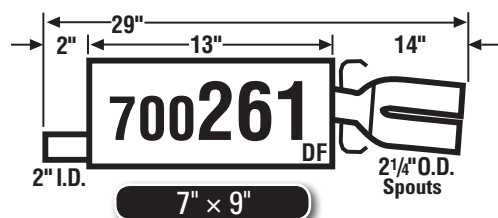
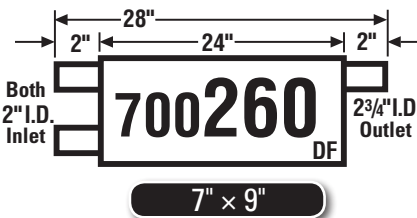
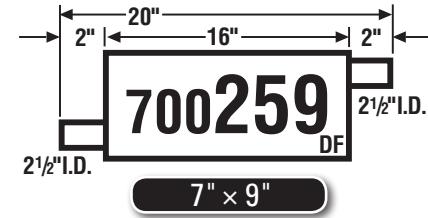
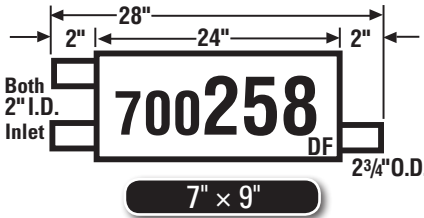
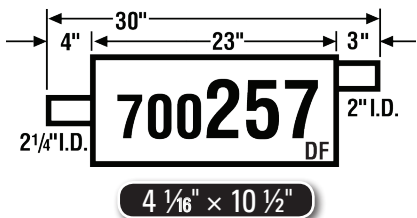
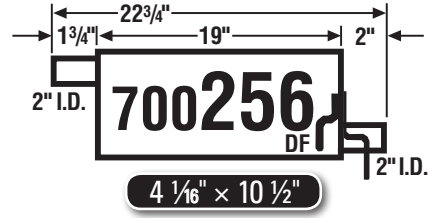
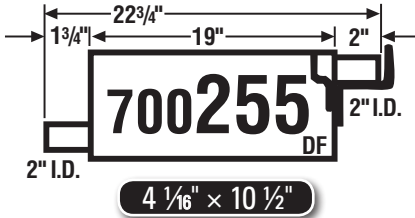
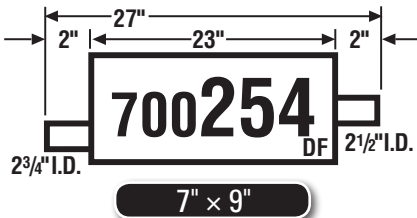
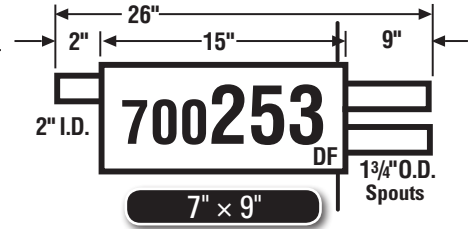
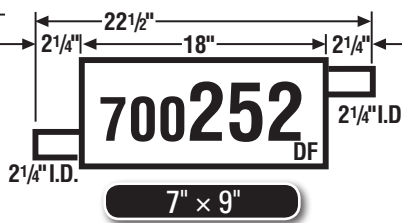
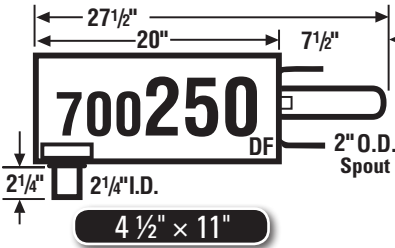
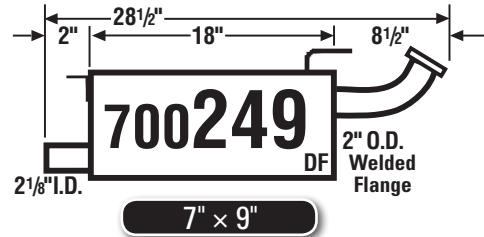
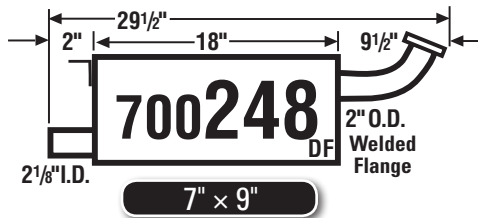
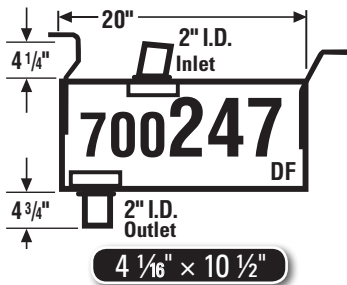

NOTE: Black area denotes welded head bracket.

DF-U - Denotes muffler used primarily as Direct Fit, but is also Universal.
 U-DF - Denotes muffler used primarily as Universal, but is also Direct Fit.

DF - Direct Fit Muffler
 U - Universal Muffler
 HS - Denotes Heat Shield is on muffler.

MUFFLER SPECS

by PART NUMBER

MAXIMUM **MSL**

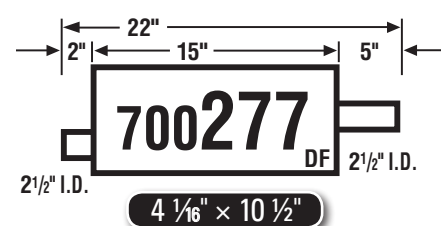
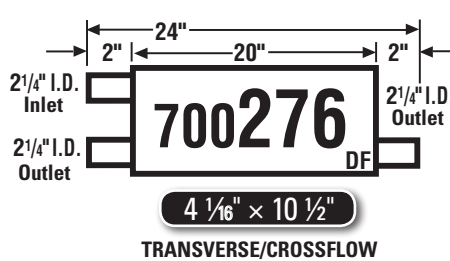
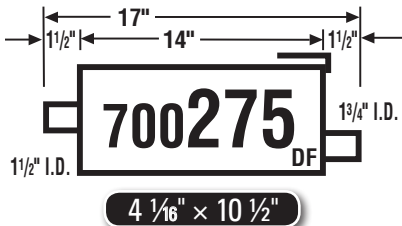
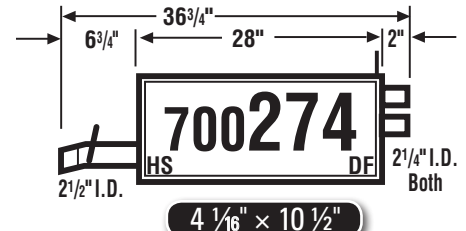
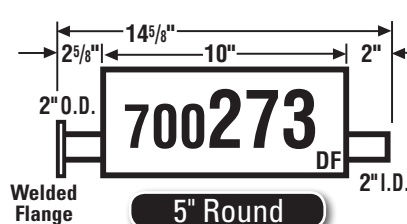
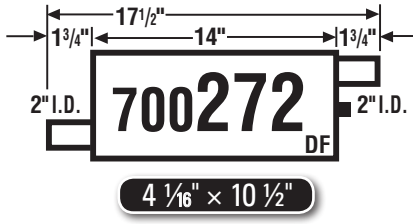
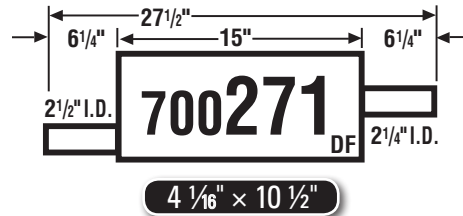
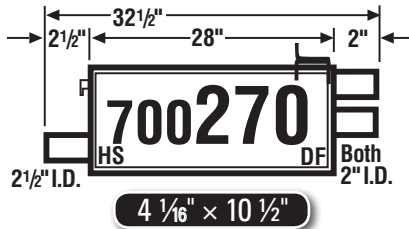
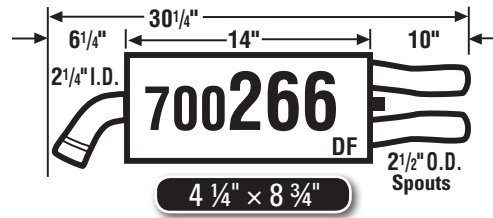
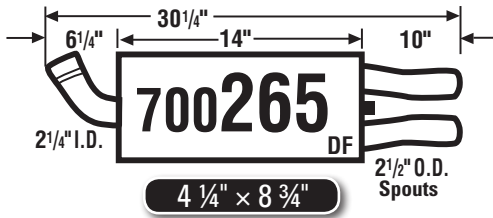

TRANSVERSE/CROSSFLOW

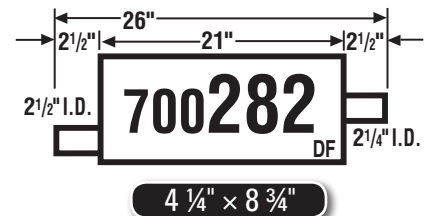
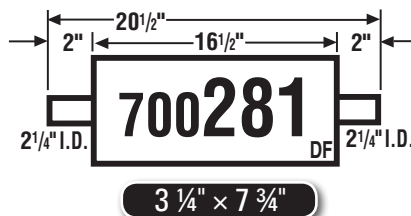
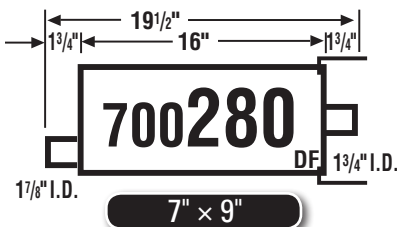
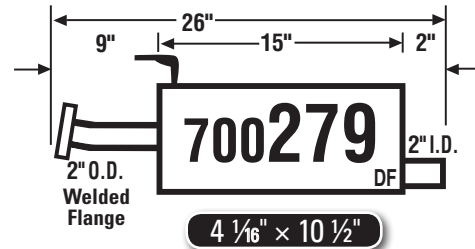
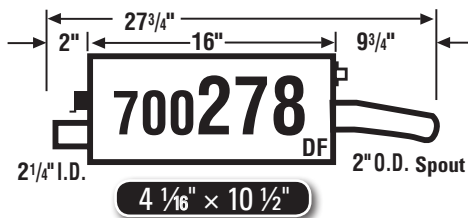

NOTE: Black area denotes welded head bracket.

DF-U - Denotes muffler used primarily as Direct Fit, but is also Universal.
U-DF - Denotes muffler used primarily as Universal, but is also Direct Fit.

DF - Direct Fit Muffler
U - Universal Muffler
HS - Denotes Heat Shield is on muffler.

MSL BY PART NUMBER

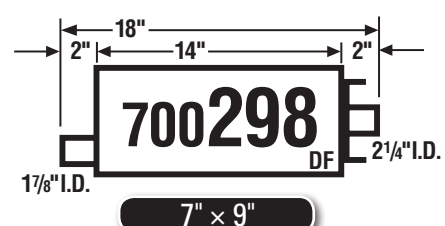
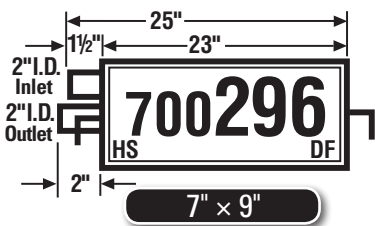
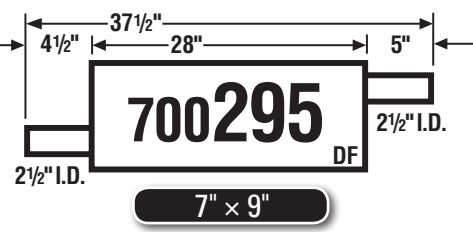
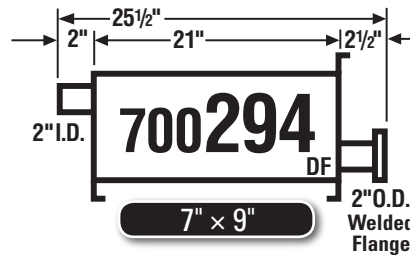
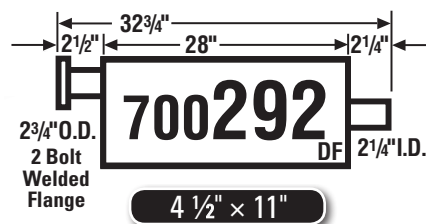
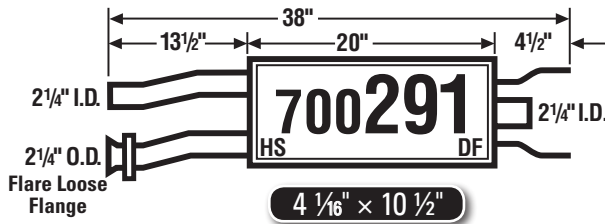
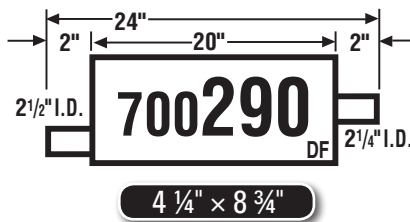
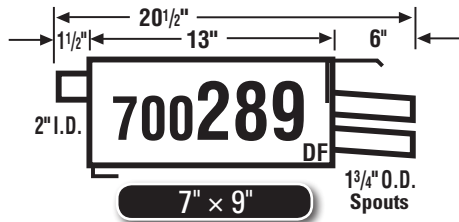
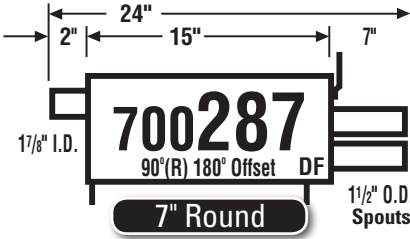
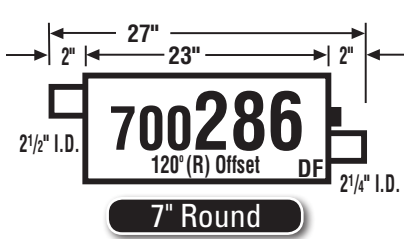
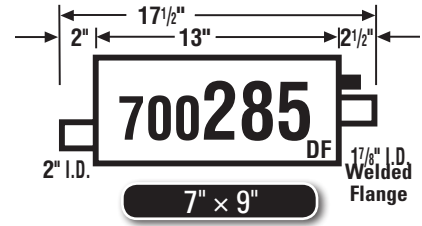
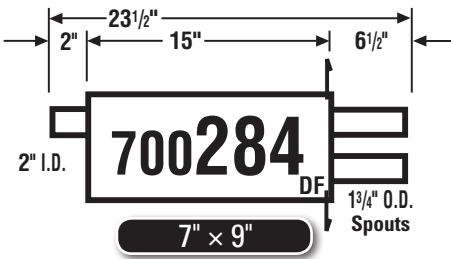
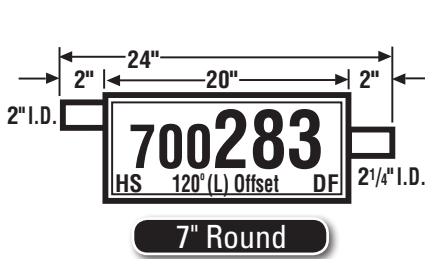

NOTE: Black area denotes welded head bracket.

DF-U - Denotes muffler used primarily as Direct Fit, but is also Universal.
U-DF - Denotes muffler used primarily as Universal, but is also Direct Fit.

DF - Direct Fit Muffler
U - Universal Muffler
HS - Denotes Heat Shield is on muffler.

MUFFLER SPECS

by PART NUMBER

MAXIMUM **MSL**

MSL BY PART NUMBER

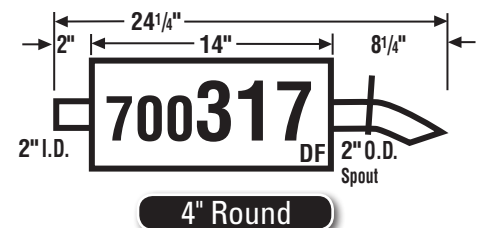
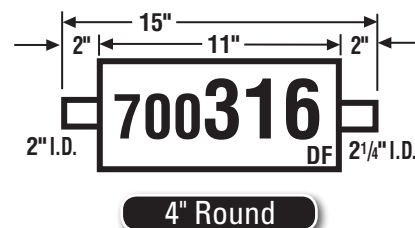
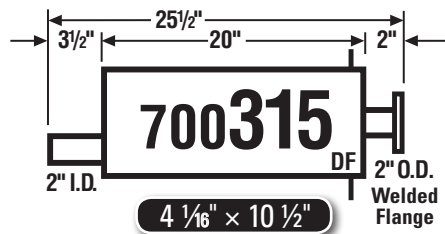
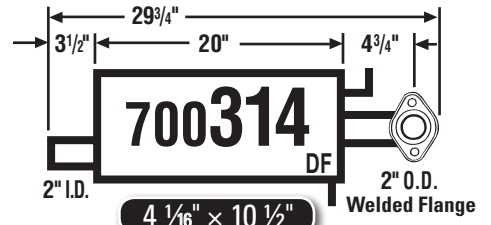
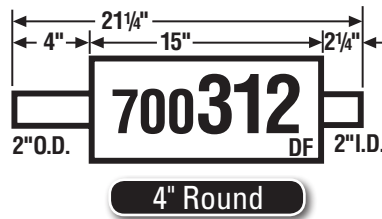
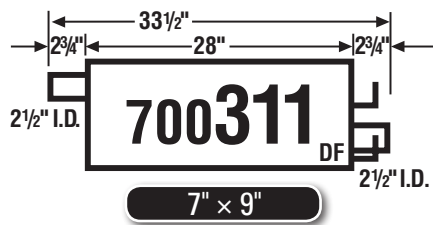
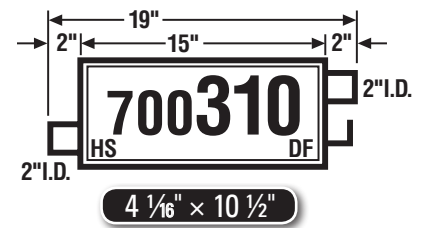
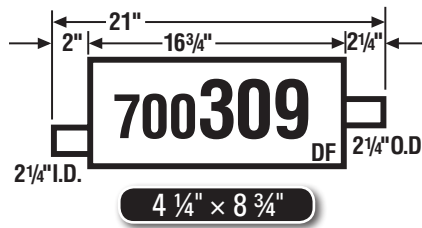
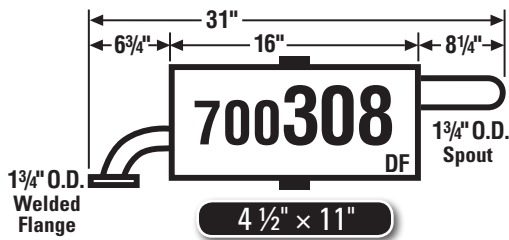
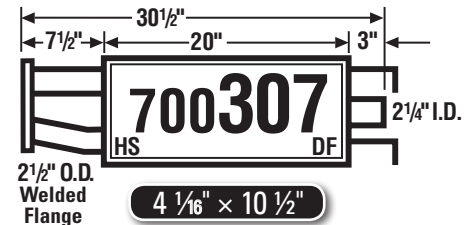
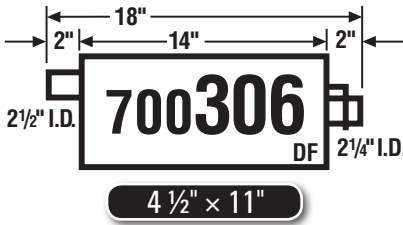
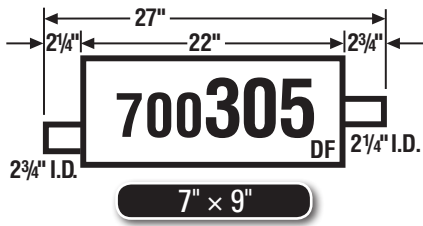
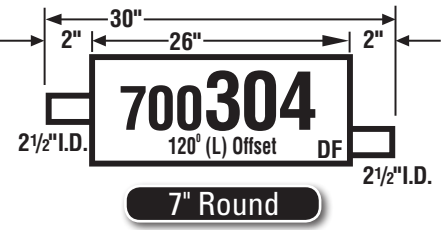
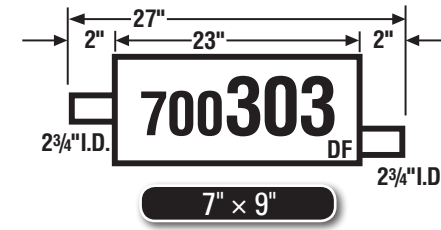
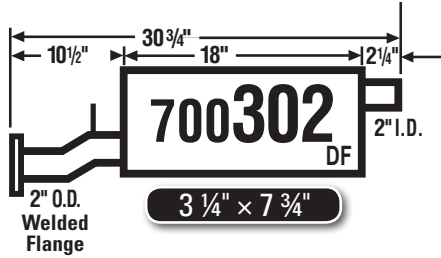
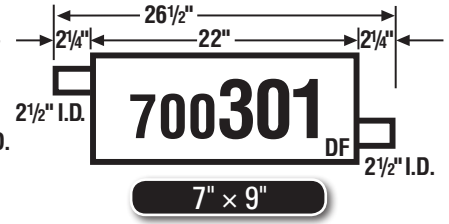
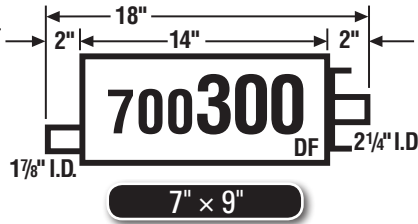
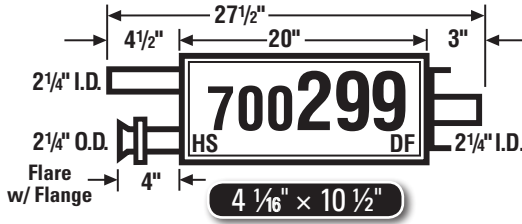

NOTE: Black area denotes welded head bracket.

DF-U - Denotes muffler used primarily as Direct Fit, but is also Universal.
 U-DF - Denotes muffler used primarily as Universal, but is also Direct Fit.

DF - Direct Fit Muffler
 U - Universal Muffler
 HS - Denotes Heat Shield is on muffler.

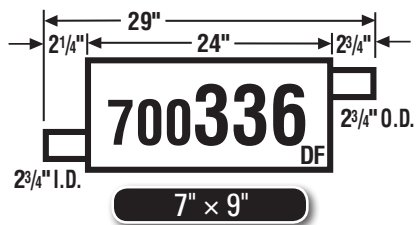
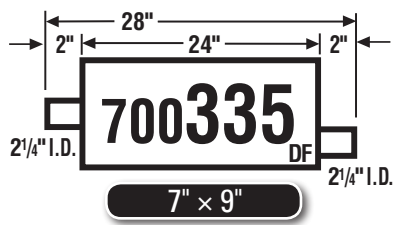
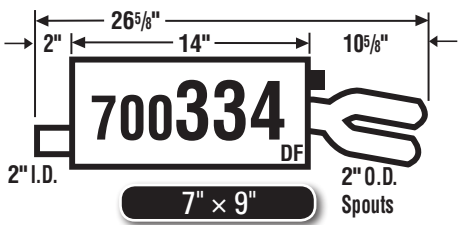
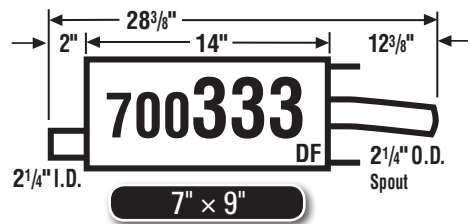
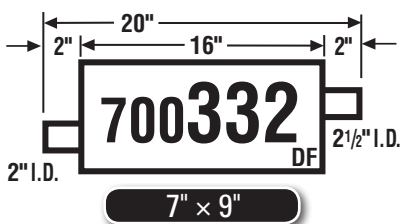
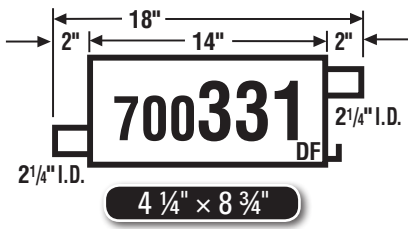
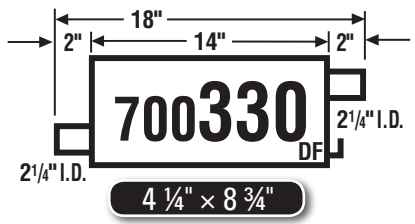
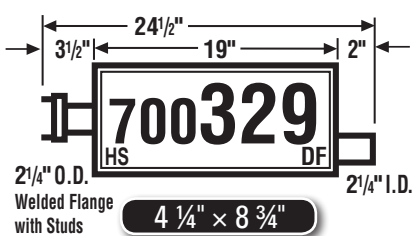
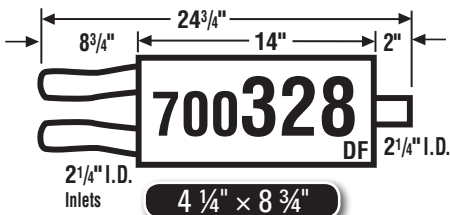
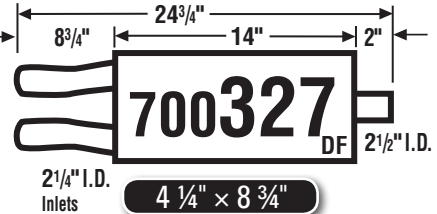
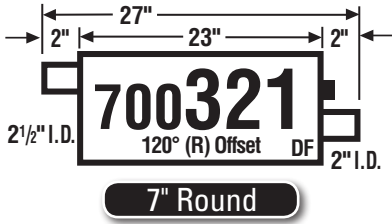

NOTE: Black area denotes welded head bracket.

DF-U - Denotes muffler used primarily as Direct Fit, but is also Universal.
U-DF - Denotes muffler used primarily as Universal, but is also Direct Fit.

DF - Direct Fit Muffler
U - Universal Muffler
HS - Denotes Heat Shield is on muffler.

MUFFLER SPECS

by PART NUMBER

MAXIMUM **MSL**

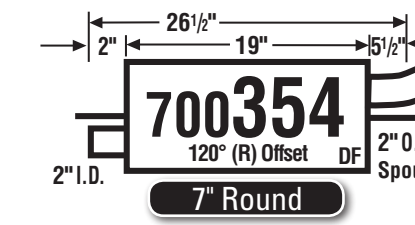
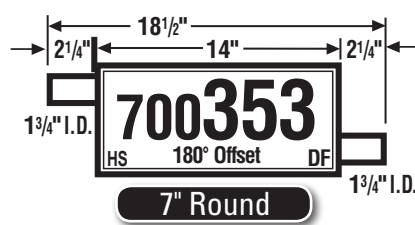
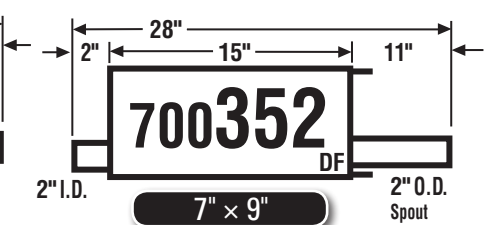
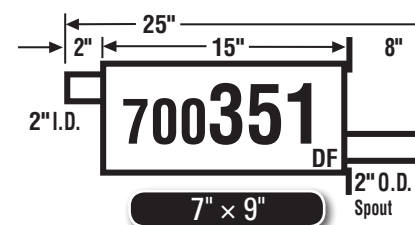
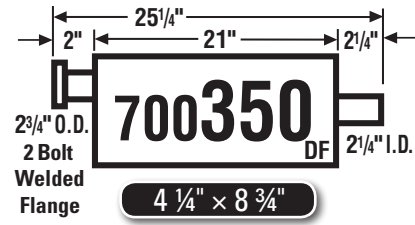
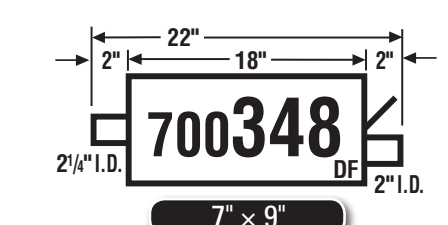
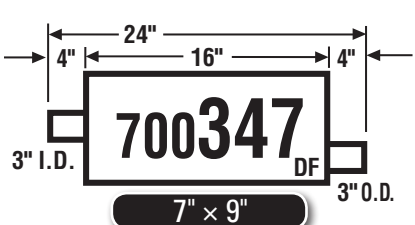
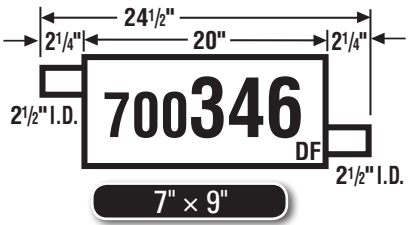
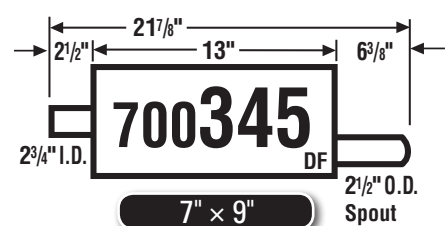
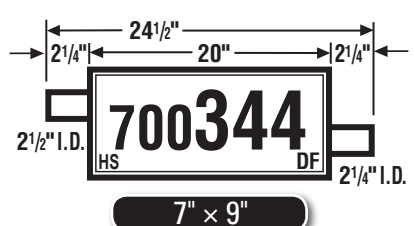
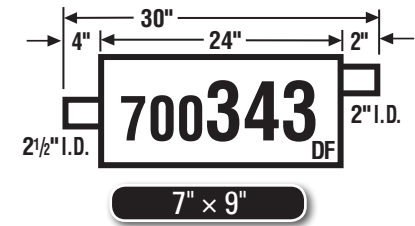
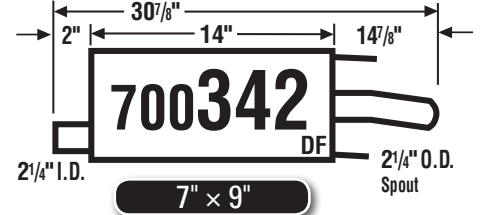
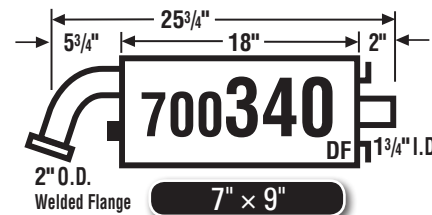
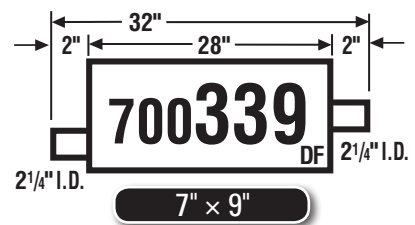
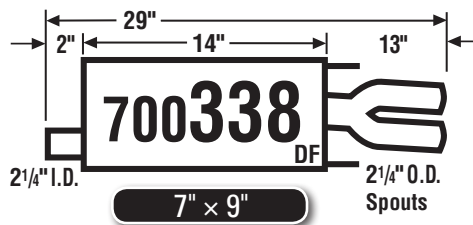
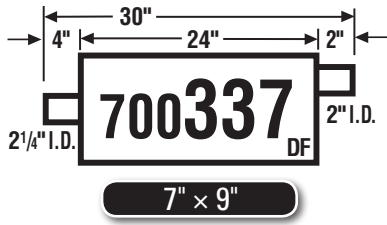

NOTE: Black area denotes welded head bracket.

DF-U - Denotes muffler used primarily as Direct Fit, but is also Universal.
 U-DF - Denotes muffler used primarily as Universal, but is also Direct Fit.

DF - Direct Fit Muffler
 U - Universal Muffler
 HS - Denotes Heat Shield is on muffler.

MSL BY PART NUMBER

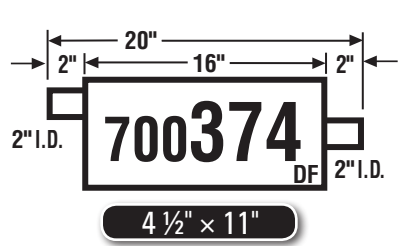
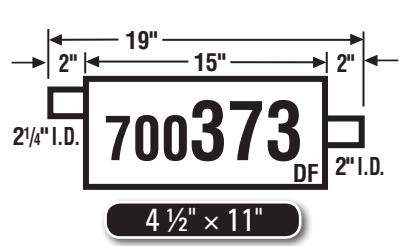
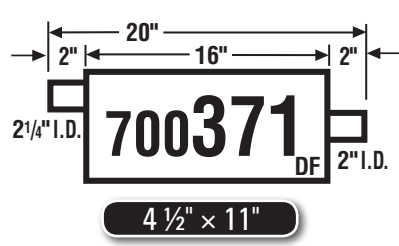
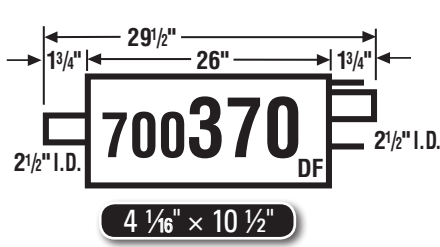
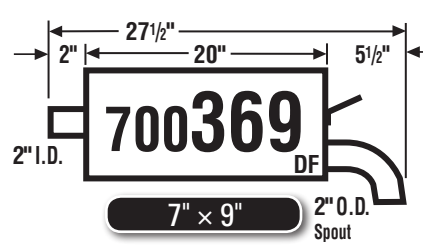
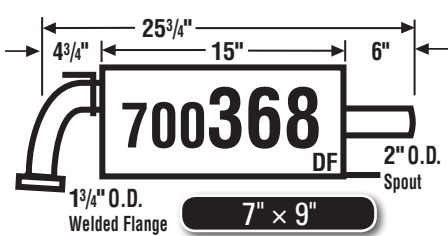
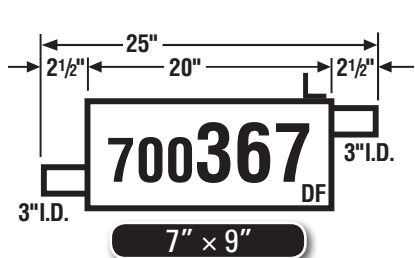
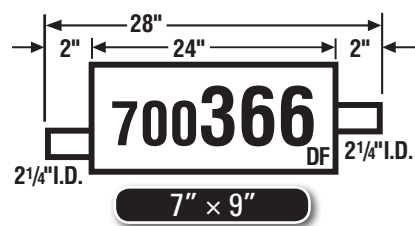
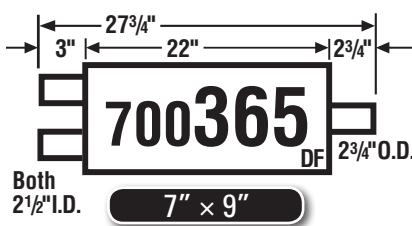
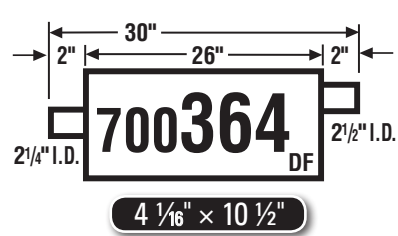
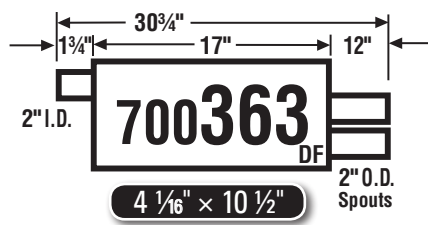
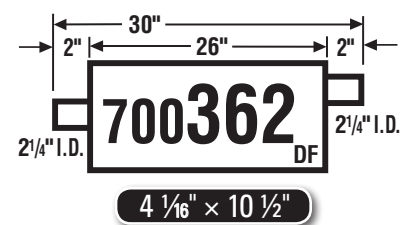
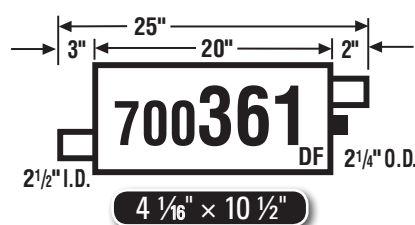
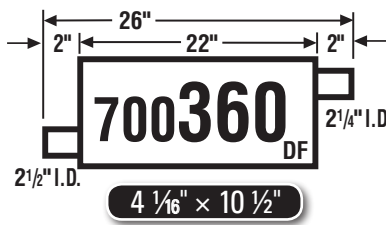
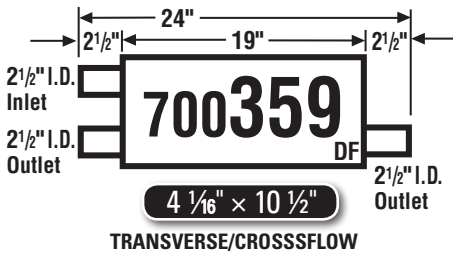
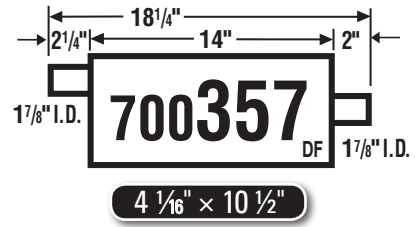
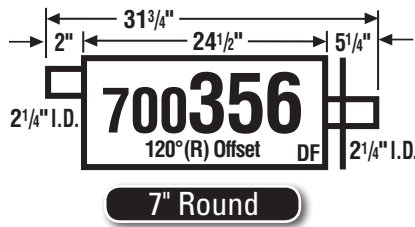
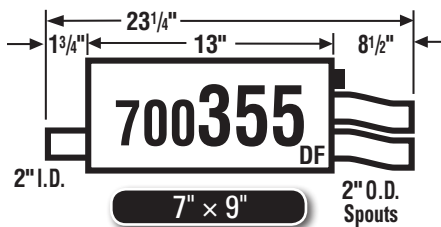

NOTE: Black area denotes welded head bracket.

DF-U - Denotes muffler used primarily as Direct Fit, but is also Universal.
U-DF - Denotes muffler used primarily as Universal, but is also Direct Fit.

DF - Direct Fit Muffler
U - Universal Muffler
HS - Denotes Heat Shield is on muffler.

MUFFLER SPECS

by PART NUMBER

MAXIMUM **MSL**[®]

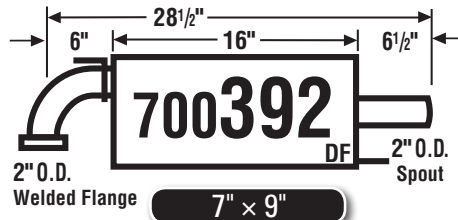
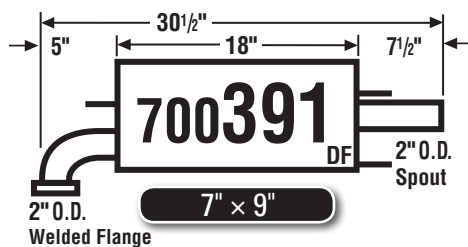
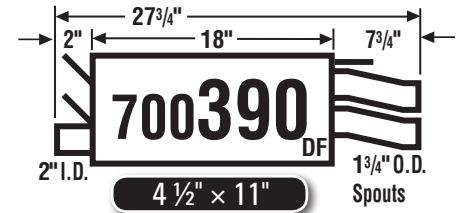
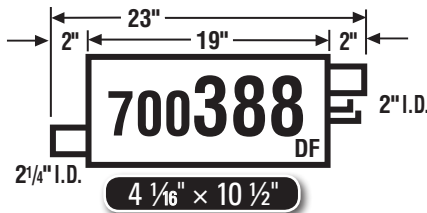
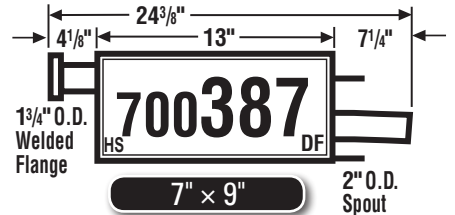
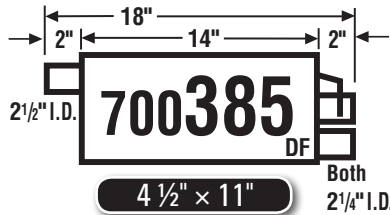
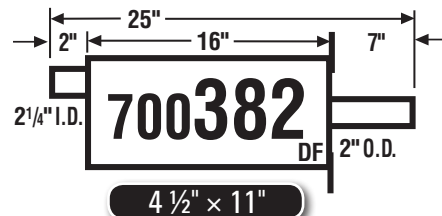
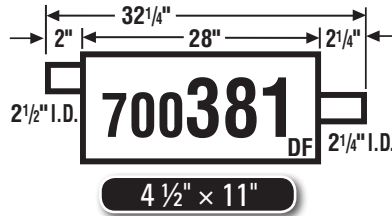
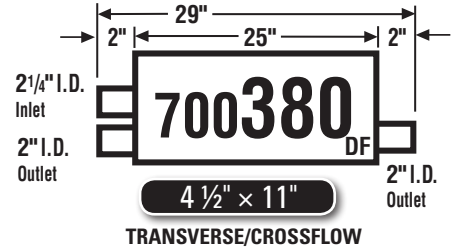
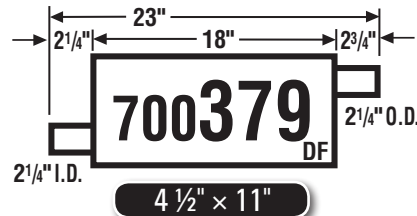
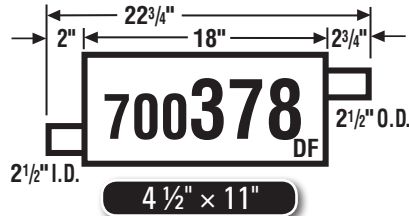
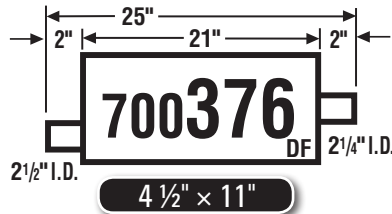
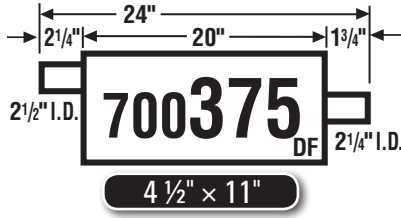

NOTE: Black area denotes welded head bracket.

DF-U - Denotes muffler used primarily as Direct Fit, but is also Universal.
U-DF - Denotes muffler used primarily as Universal, but is also Direct Fit.

DF - Direct Fit Muffler
U - Universal Muffler
HS - Denotes Heat Shield is on muffler.

MSL BY PART NUMBER

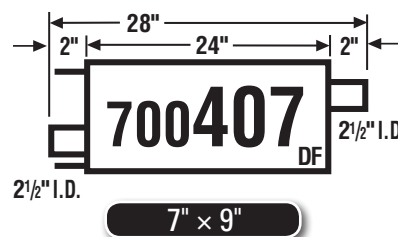
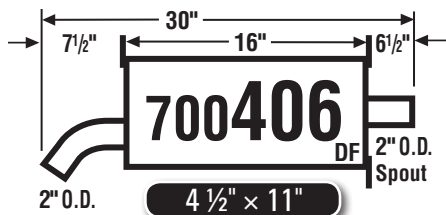
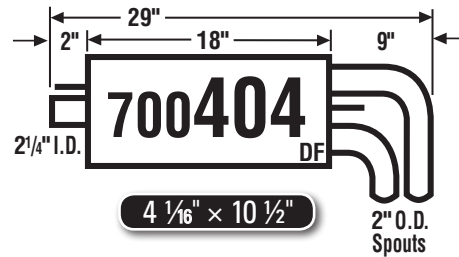
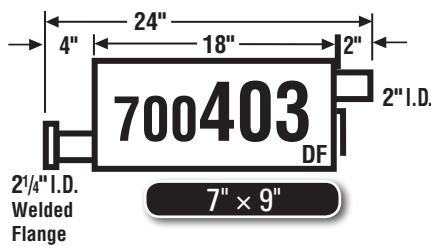
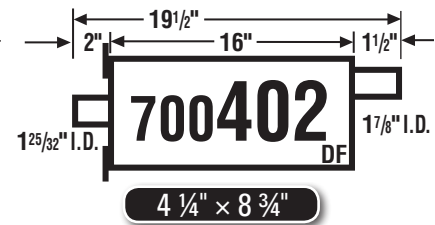
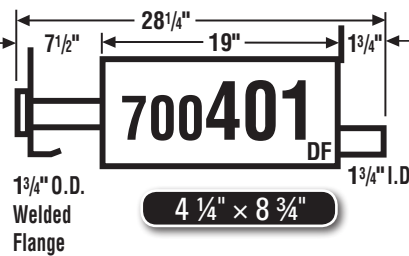
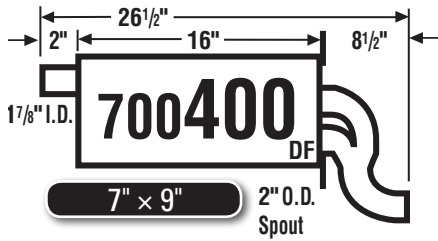
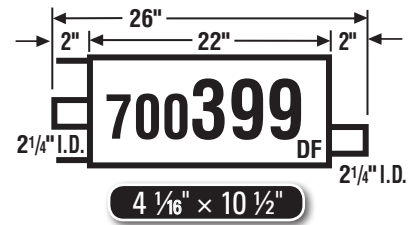
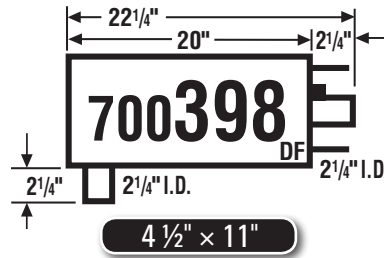
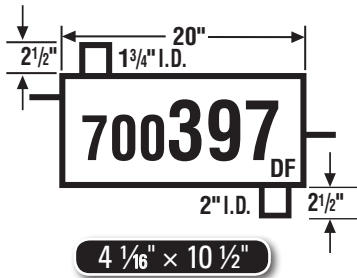
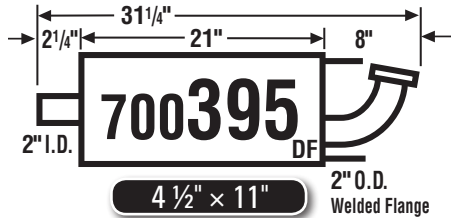
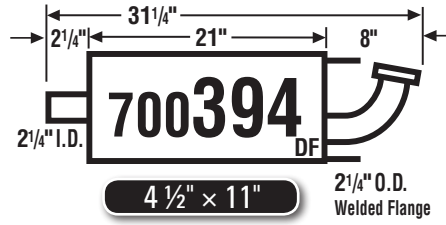
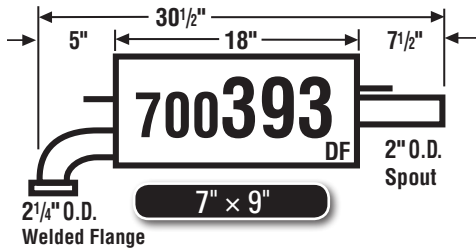

NOTE: Black area denotes welded head bracket.

DF-U - Denotes muffler used primarily as Direct Fit, but is also Universal.
U-DF - Denotes muffler used primarily as Universal, but is also Direct Fit.

DF - Direct Fit Muffler
U - Universal Muffler
HS - Denotes Heat Shield is on muffler.

MUFFLER SPECS

by PART NUMBER

MAXIMUM **MSL**

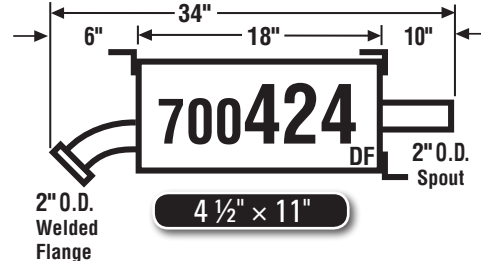
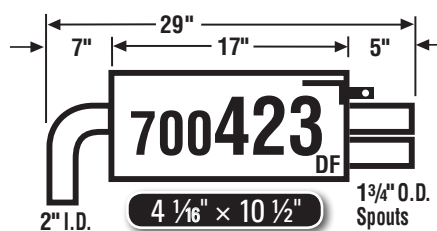
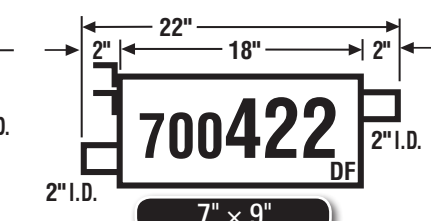
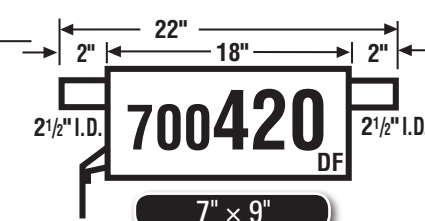
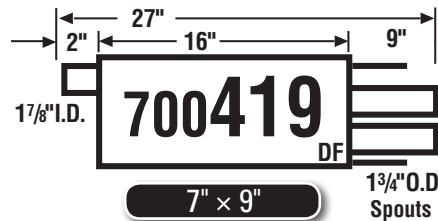
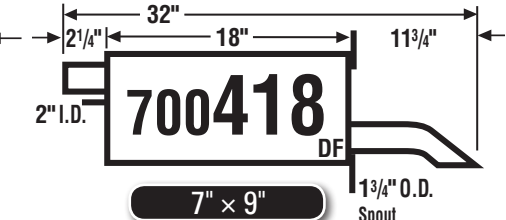
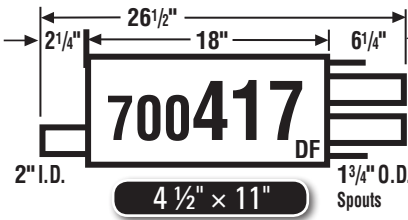
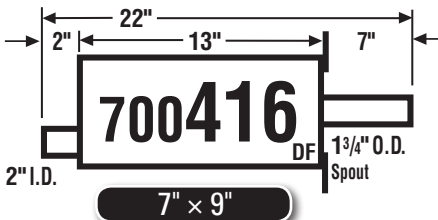
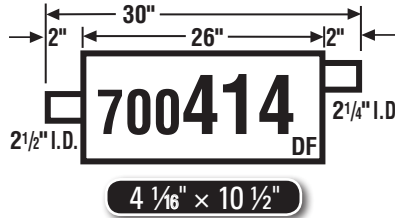
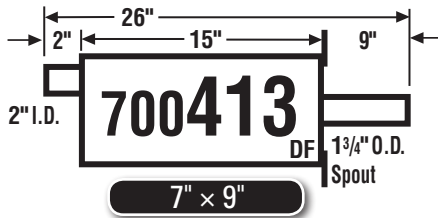
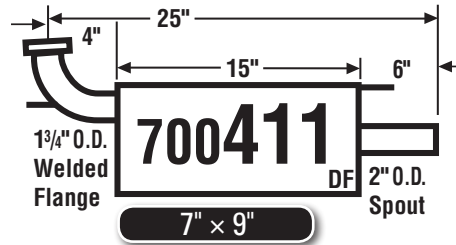
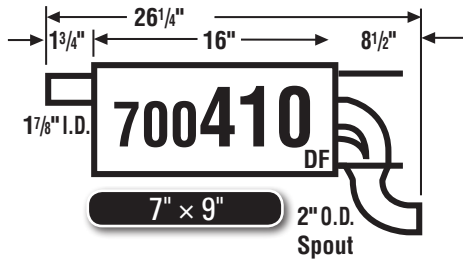
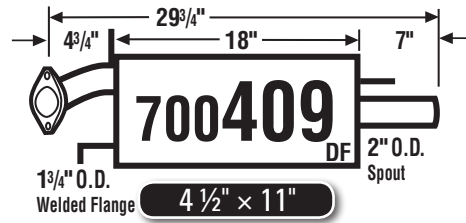
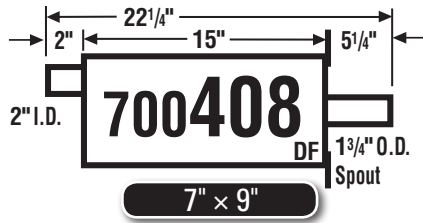

NOTE: Black area denotes welded head bracket.

DF-U - Denotes muffler used primarily as Direct Fit, but is also Universal.
 U-DF - Denotes muffler used primarily as Universal, but is also Direct Fit.

DF - Direct Fit Muffler
 U - Universal Muffler
 HS - Denotes Heat Shield is on muffler.

MSL BY PART NUMBER

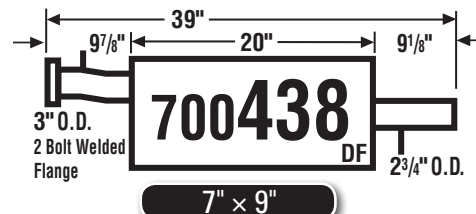
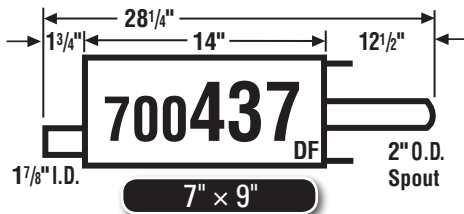
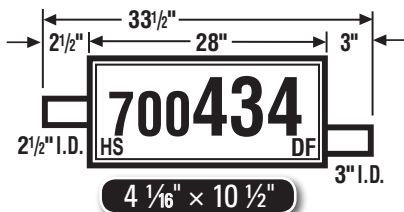
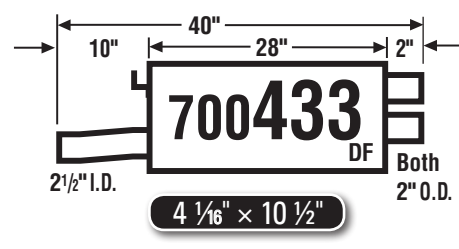
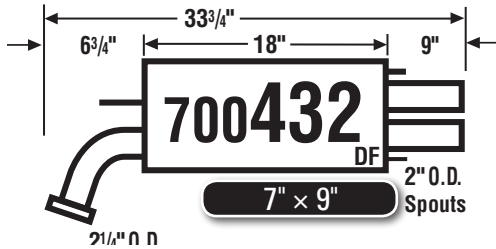
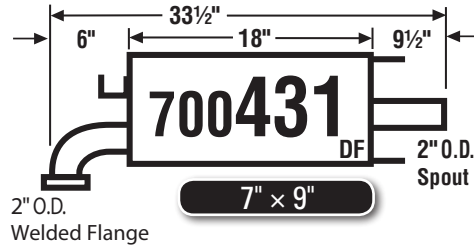
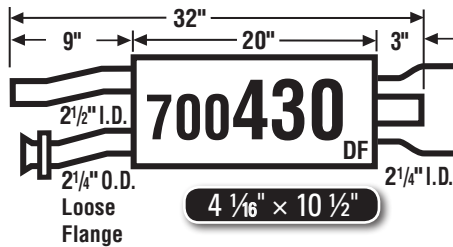
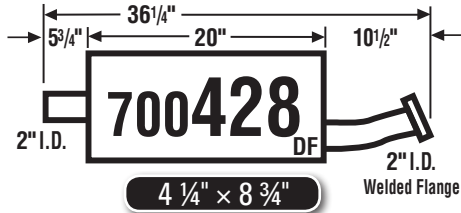
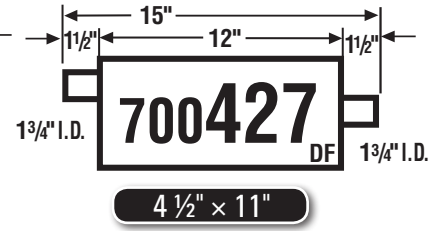
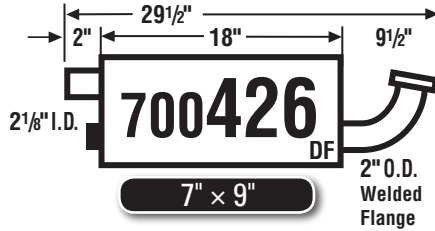
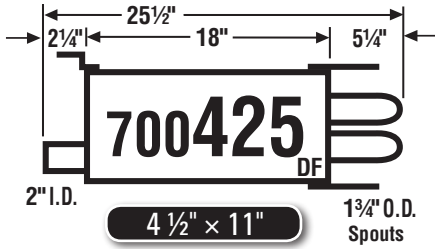

NOTE: Black area denotes welded head bracket.

DF-U - Denotes muffler used primarily as Direct Fit, but is also Universal.
U-DF - Denotes muffler used primarily as Universal, but is also Direct Fit.

DF - Direct Fit Muffler
U - Universal Muffler
HS - Denotes Heat Shield is on muffler.

MUFFLER SPECS

by PART NUMBER

MAXIMUM. **MSL**

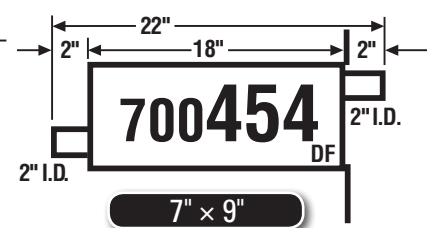
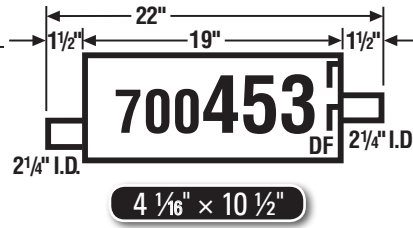
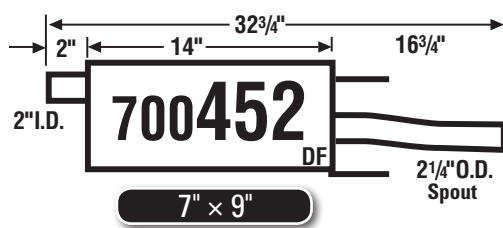
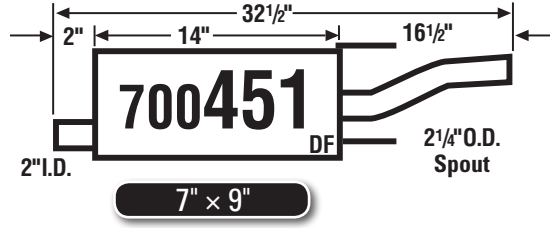
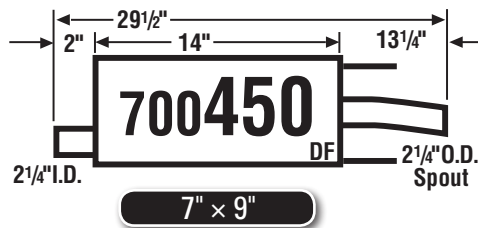
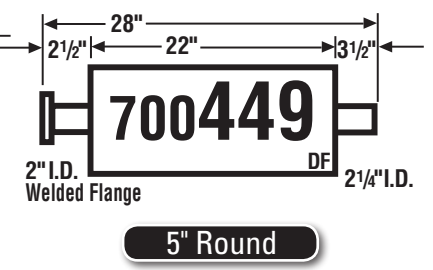
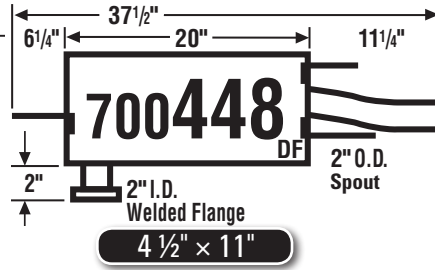
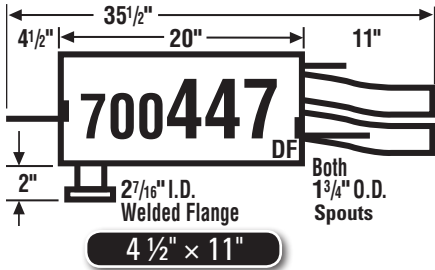
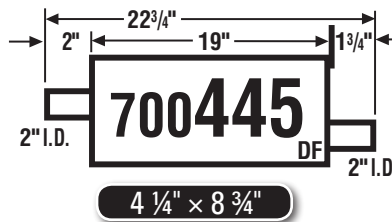
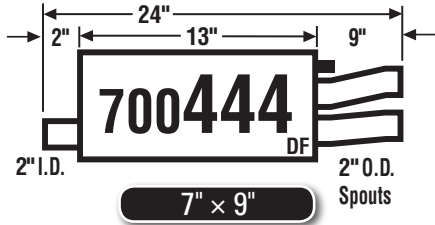
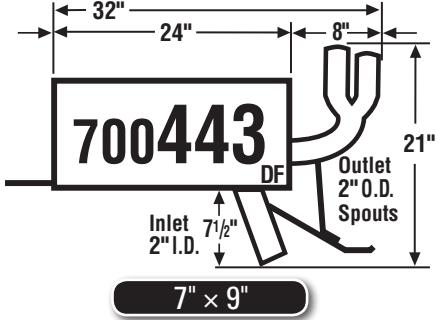
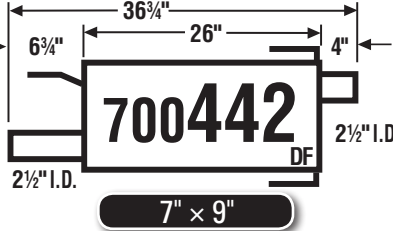
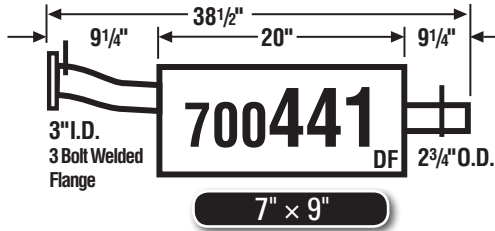
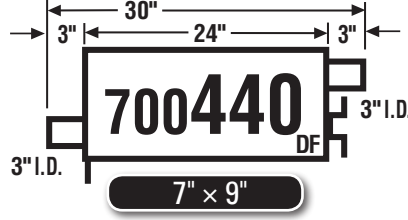
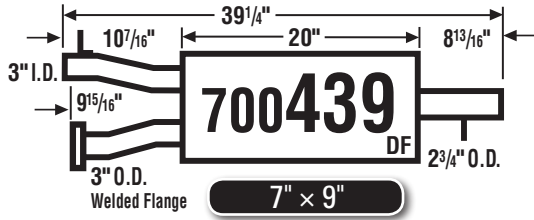

NOTE: Black area denotes welded head bracket.

DF-U - Denotes muffler used primarily as Direct Fit, but is also Universal.
U-DF - Denotes muffler used primarily as Universal, but is also Direct Fit.

DF - Direct Fit Muffler
U - Universal Muffler
HS - Denotes Heat Shield is on muffler.

MSL BY PART NUMBER

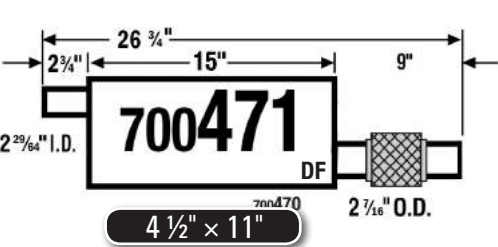
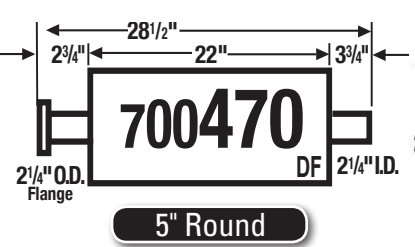
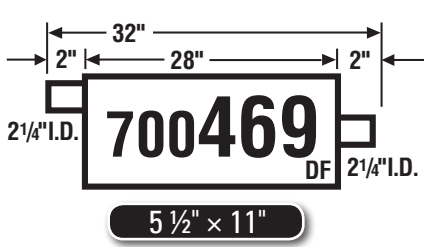
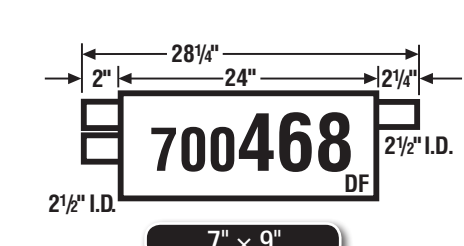
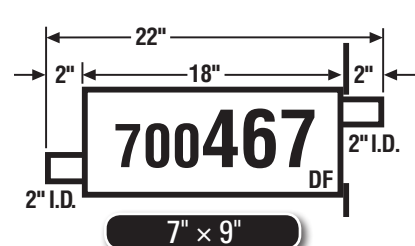
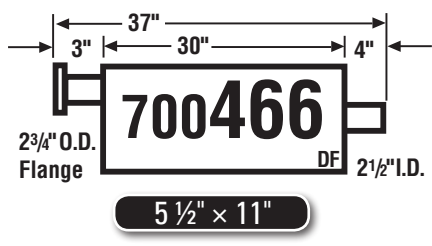
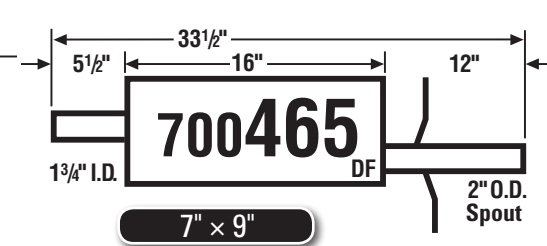
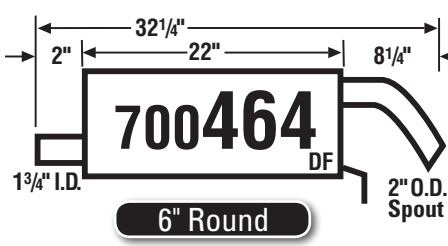
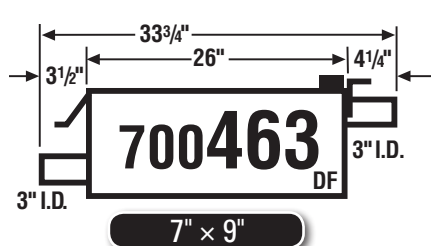
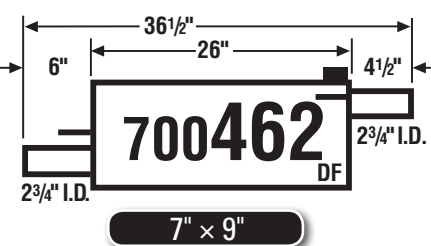
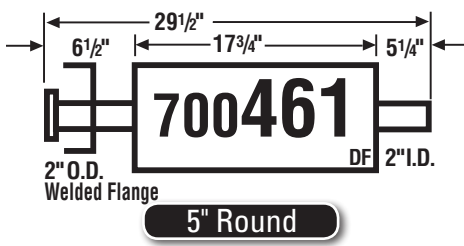
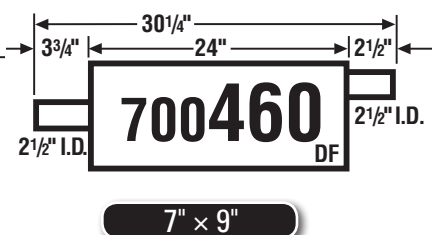
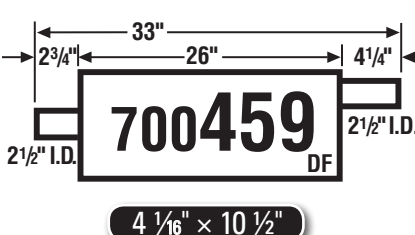
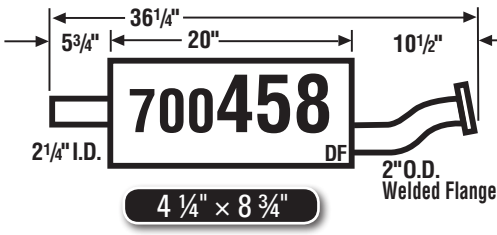
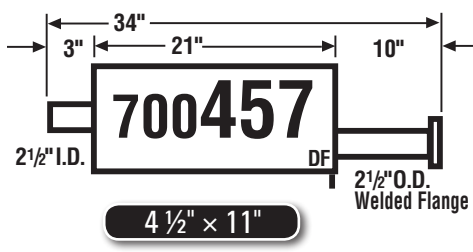
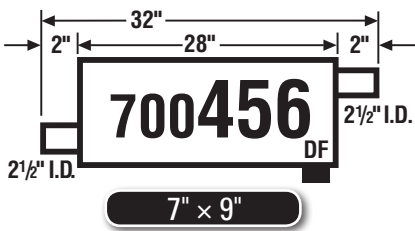
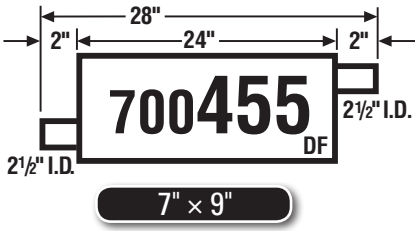

NOTE: Black area denotes welded head bracket.

DF-U - Denotes muffler used primarily as Direct Fit, but is also Universal.
U-DF - Denotes muffler used primarily as Universal, but is also Direct Fit.

DF - Direct Fit Muffler
U - Universal Muffler
HS - Denotes Heat Shield is on muffler.

MUFFLER SPECS

by PART NUMBER

MAXIMUM **MSL**

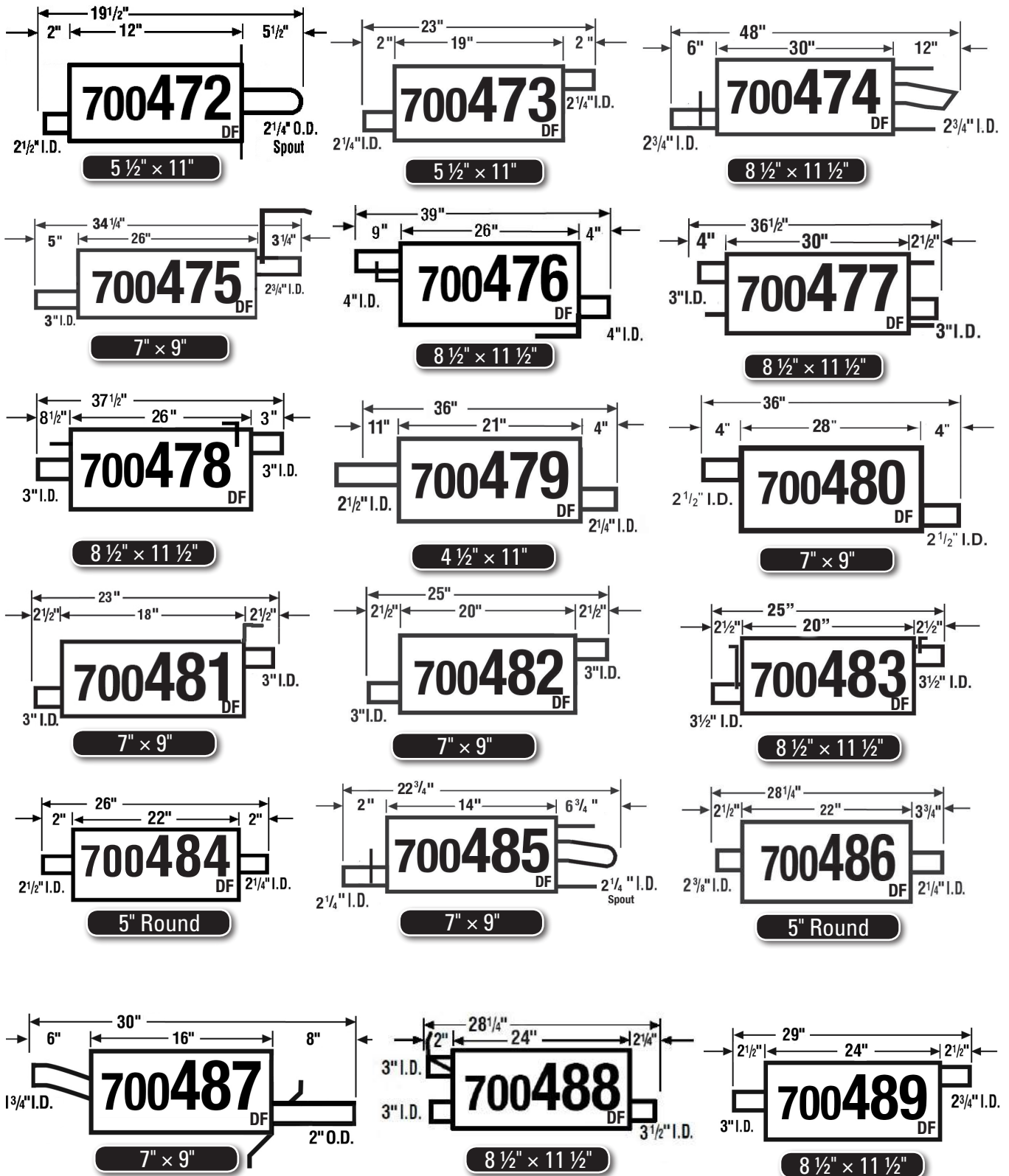

MSL BY PART NUMBER

NOTE: Black area denotes welded head bracket.

DF-U - Denotes muffler used primarily as Direct Fit, but is also Universal.
 U-DF - Denotes muffler used primarily as Universal, but is also Direct Fit.

DF - Direct Fit Muffler
 U - Universal Muffler
 HS - Denotes Heat Shield is on muffler.

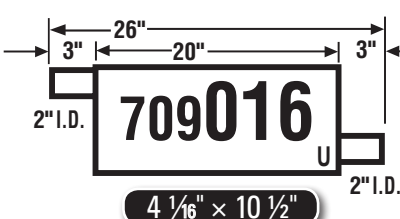
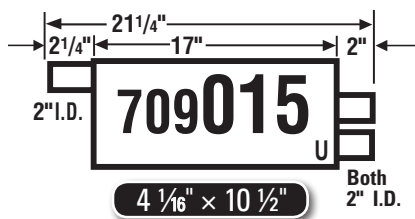
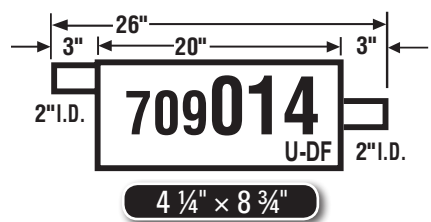
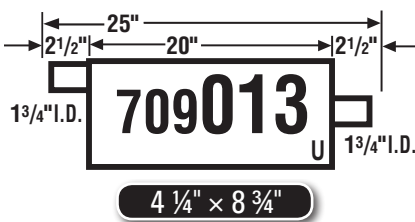
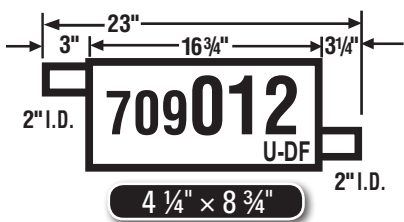
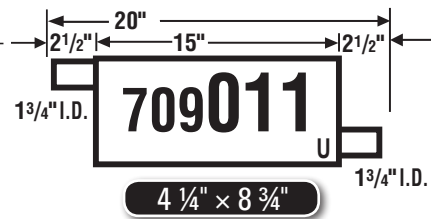
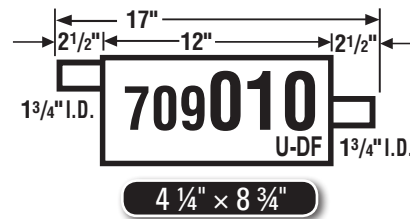
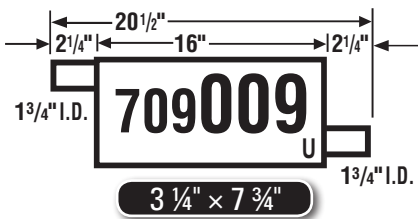
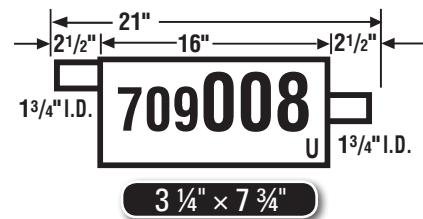
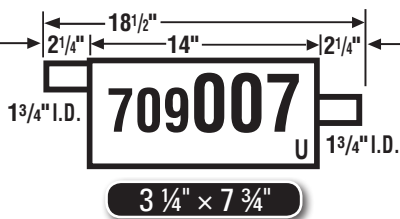
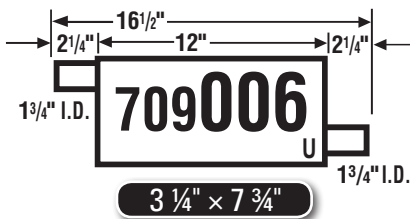
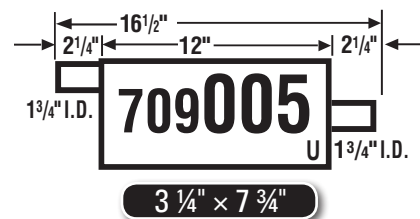
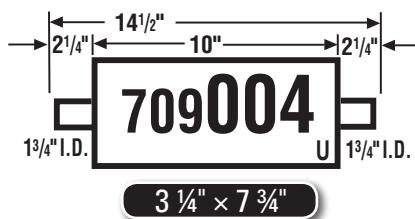
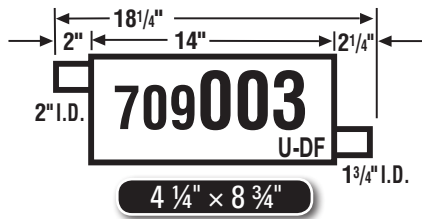
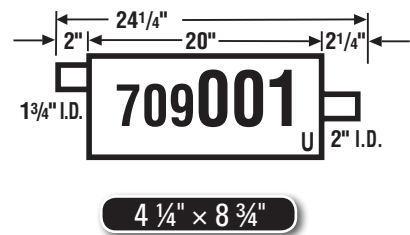
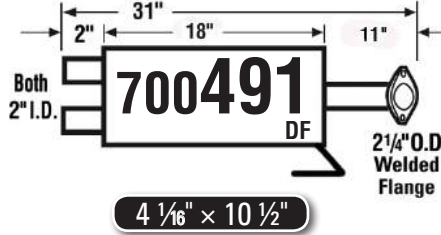
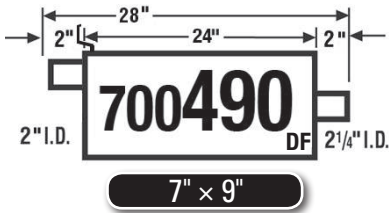

NOTE: Black area denotes welded head bracket.

DF-U - Denotes muffler used primarily as Direct Fit, but is also Universal.
U-DF - Denotes muffler used primarily as Universal, but is also Direct Fit.

DF - Direct Fit Muffler
U - Universal Muffler
HS - Denotes Heat Shield is on muffler.

MUFFLER SPECS

by PART NUMBER

MAXIMUM **MSL**

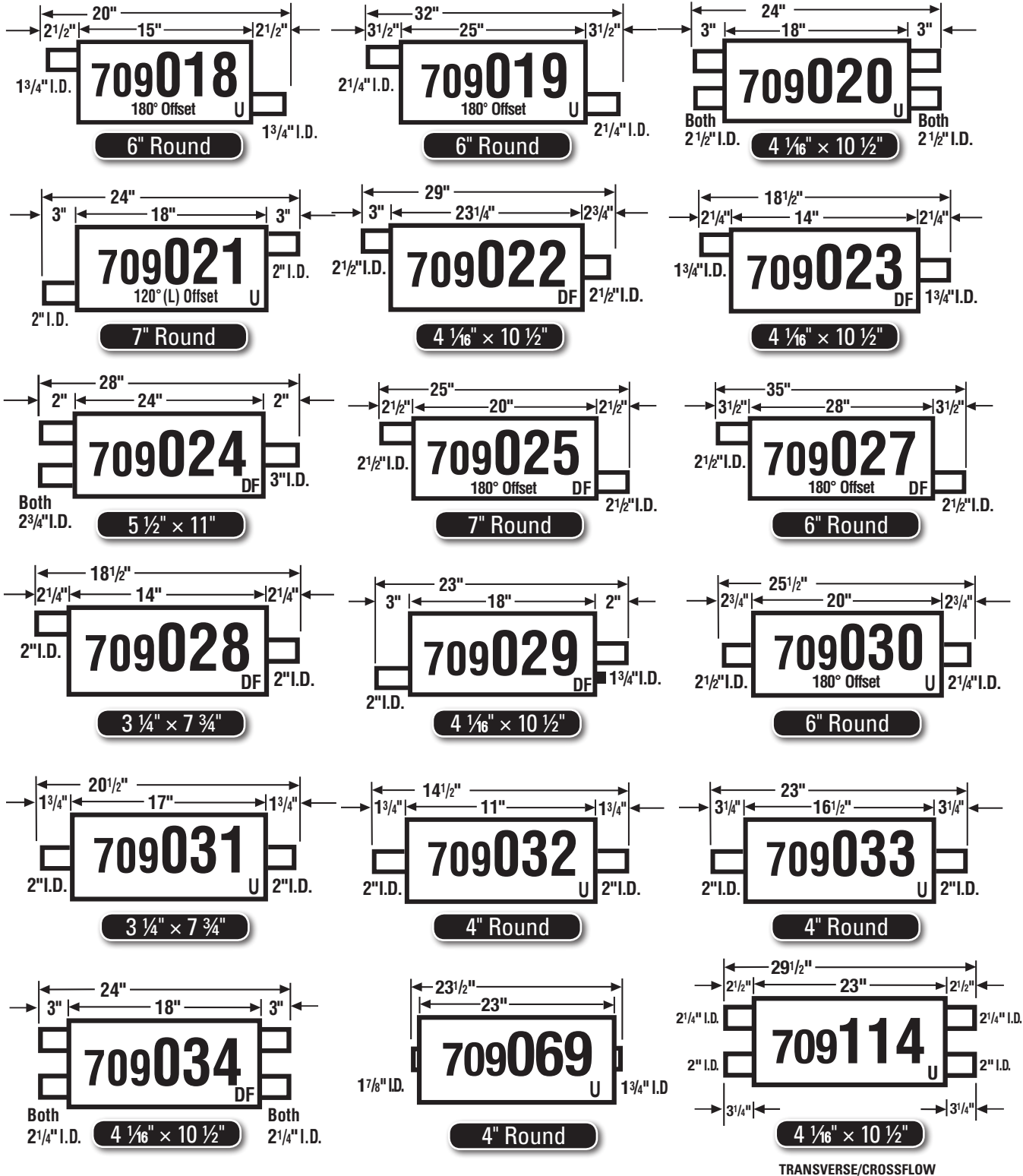

MSL BY PART NUMBER

NOTE: Black area denotes welded head bracket.

DF-U - Denotes muffler used primarily as Direct Fit, but is also Universal.
 U-DF - Denotes muffler used primarily as Universal, but is also Direct Fit.

DF - Direct Fit Muffler
 U - Universal Muffler
 HS - Denotes Heat Shield is on muffler.

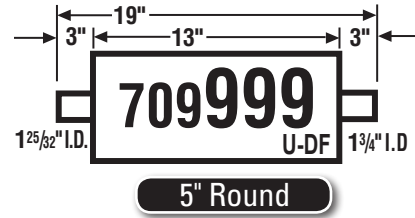
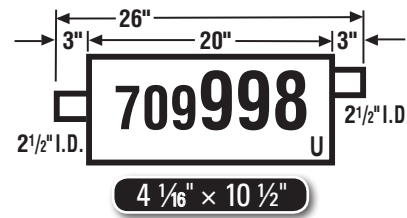
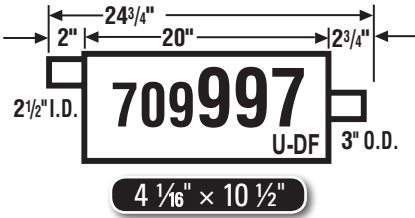
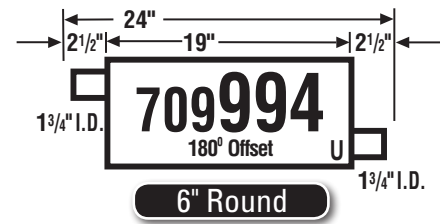
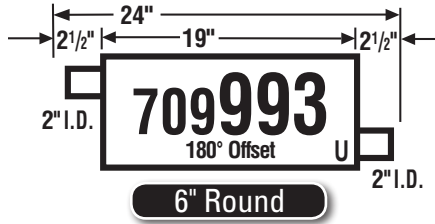
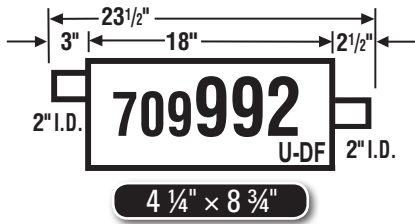

MSL BY PART NUMBER

NOTE: Black area denotes welded head bracket.

DF-U - Denotes muffler used primarily as Direct Fit, but is also Universal.
U-DF - Denotes muffler used primarily as Universal, but is also Direct Fit.

DF - Direct Fit Muffler
U - Universal Muffler
HS - Denotes Heat Shield is on muffler.

UNIVERSAL SPECS

by DIMENSION

Sorted first by Cross Section, then Shell Length, then Inlet Diameter.

MAXIMUM **MSL**

4" ROUNDS

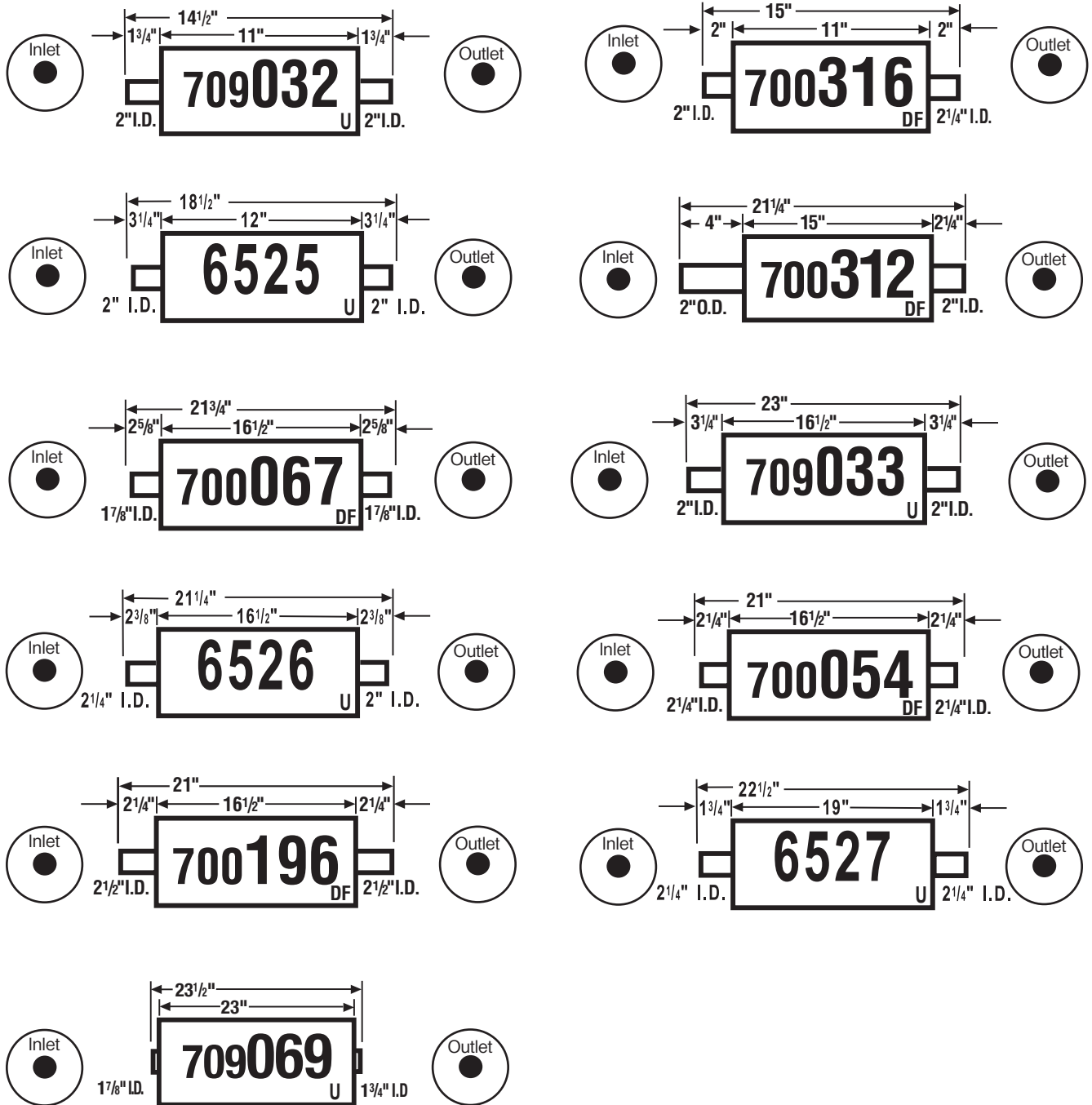

NOTE: Black area denotes welded head bracket.

DF-U - Denotes muffler used primarily as Direct Fit, but is also Universal.
 U-DF - Denotes muffler used primarily as Universal, but is also Direct Fit.

DF - Direct Fit Muffler
 U - Universal Muffler
 HS - Denotes Heat Shield is on muffler.

MSL BY DIMENSION

5" ROUNDS

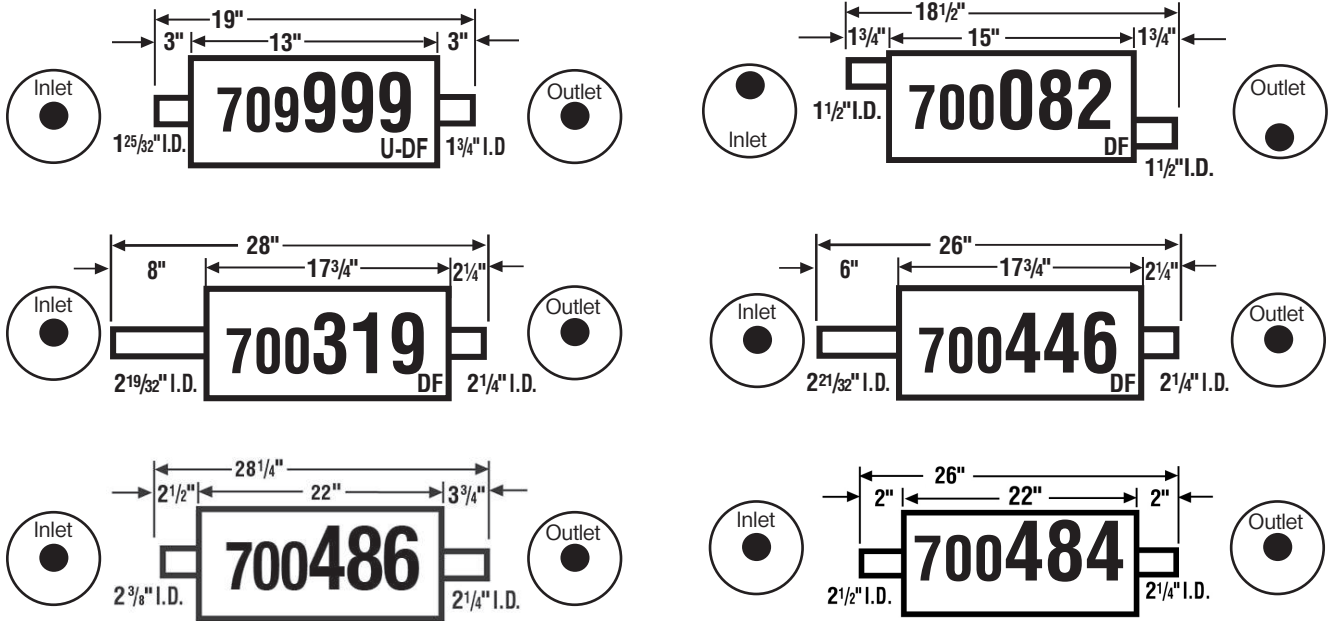

6" ROUNDS

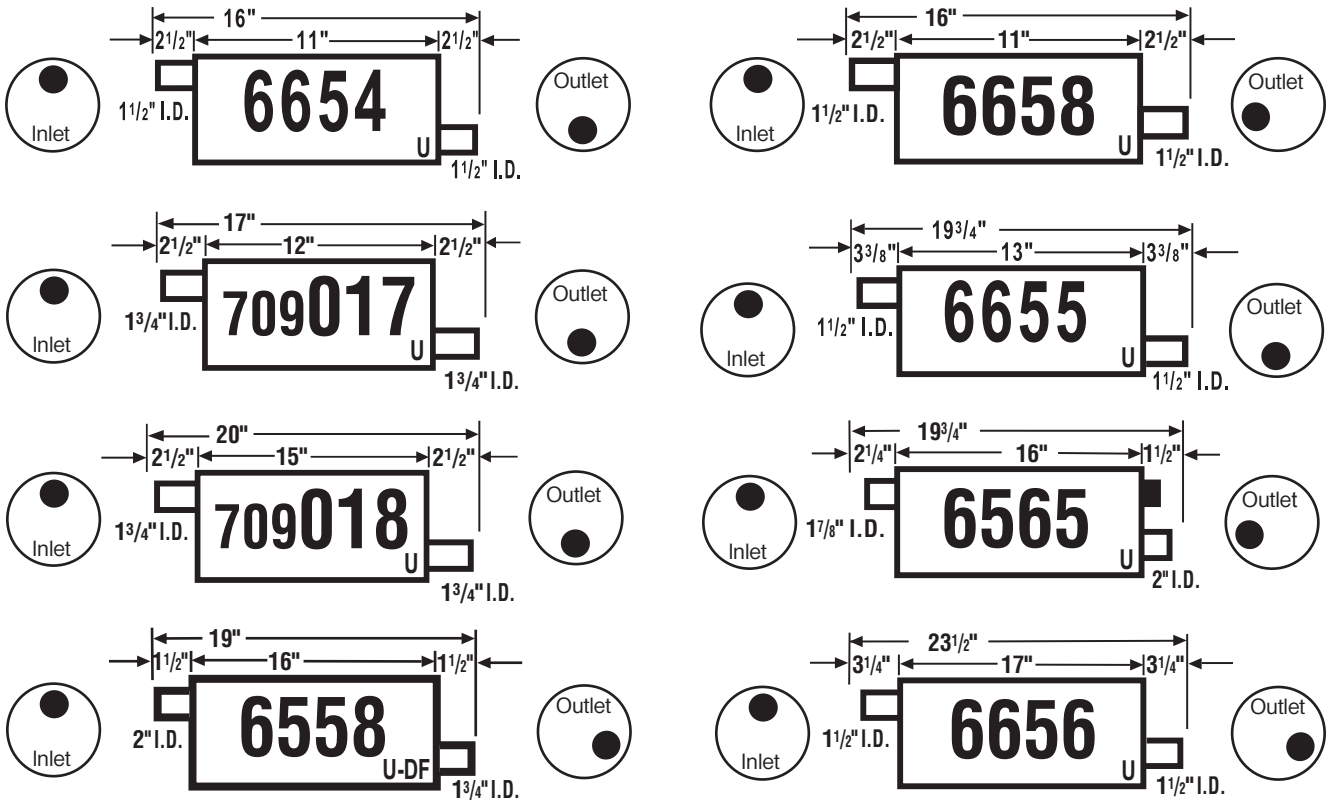

NOTE: Black area denotes welded head bracket.

DF-U - Denotes muffler used primarily as Direct Fit, but is also Universal.
U-DF - Denotes muffler used primarily as Universal, but is also Direct Fit.

DF - Direct Fit Muffler
U - Universal Muffler
HS - Denotes Heat Shield is on muffler.

UNIVERSAL SPECS

by DIMENSION

Sorted first by Cross Section, then Shell Length, then Inlet Diameter.

MAXIMUM **MSL**

6" ROUNDS

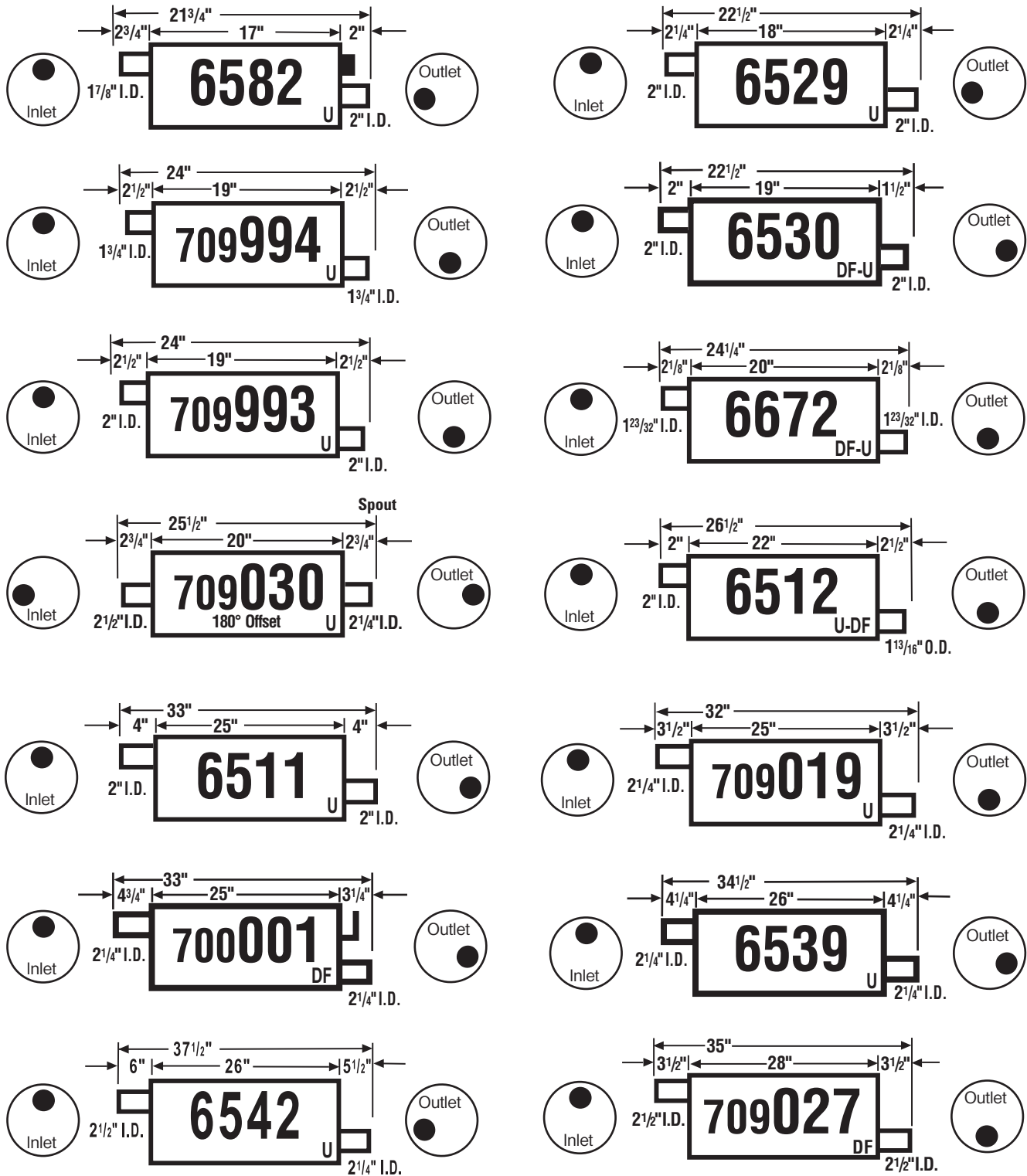

NOTE: Black area denotes welded head bracket.

DF-U - Denotes muffler used primarily as Direct Fit, but is also Universal.

U-DF - Denotes muffler used primarily as Universal, but is also Direct Fit.

DF - Direct Fit Muffler

U - Universal Muffler

HS - Denotes Heat Shield is on muffler.

MSL BY DIMENSION

7" ROUNDS

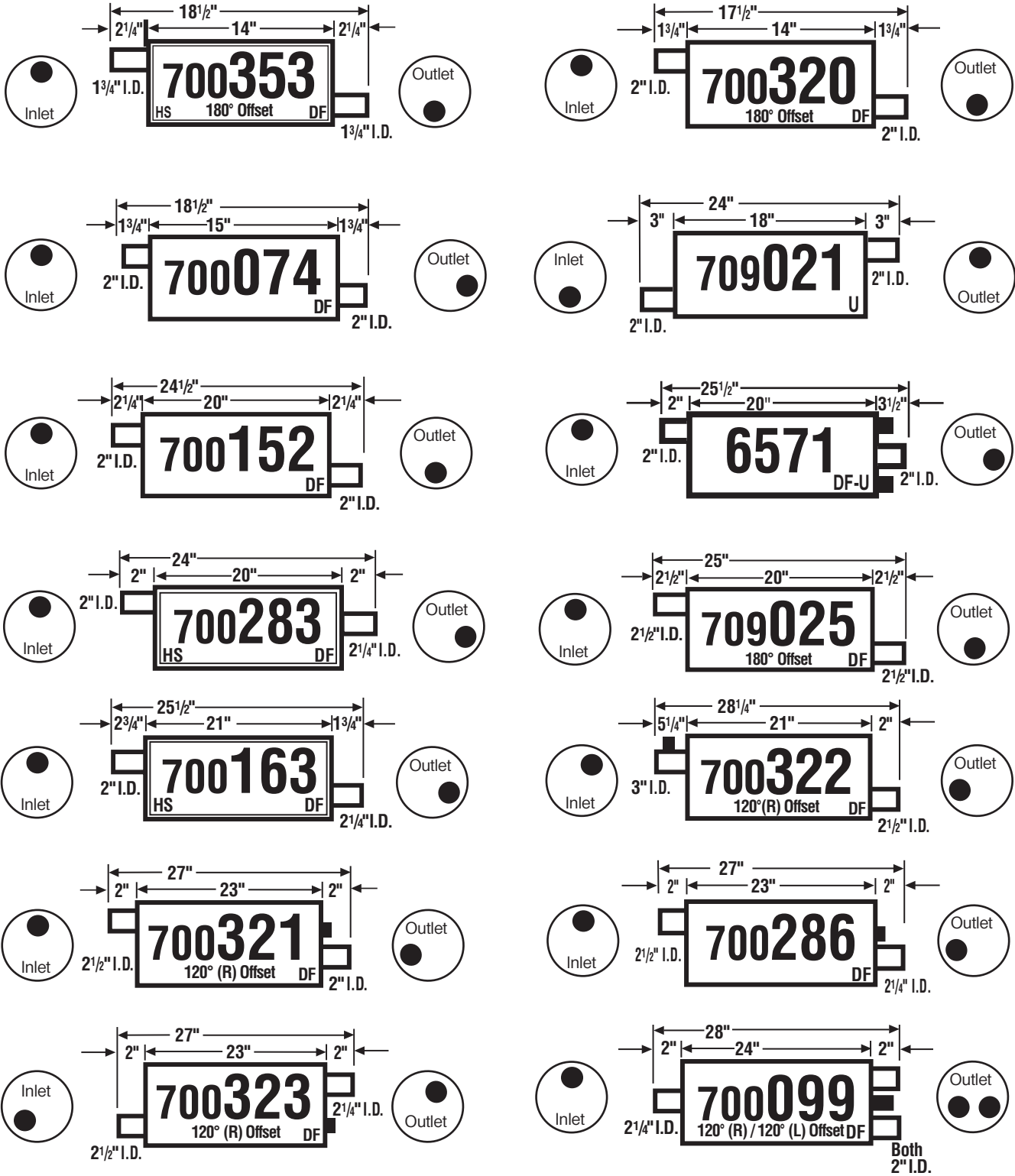

MSL BY DIMENSION

NOTE: Black area denotes welded head bracket.

DF-U - Denotes muffler used primarily as Direct Fit, but is also Universal.

U-DF - Denotes muffler used primarily as Universal, but is also Direct Fit.

DF - Direct Fit Muffler

U - Universal Muffler

HS - Denotes Heat Shield is on muffler.

UNIVERSAL SPECS

by DIMENSION

Sorted first by Cross Section, then Shell Length, then Inlet Diameter.

MAXIMUM **MSL**

7" ROUNDS

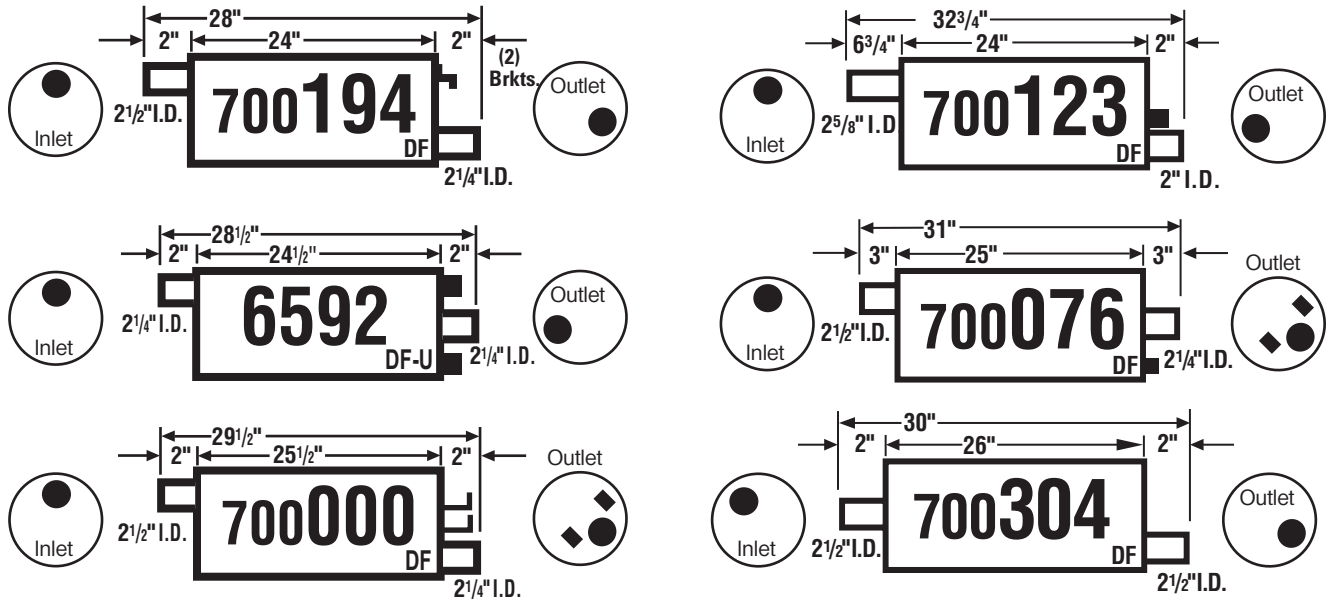

3 1/4" x 7 3/4" OVALS

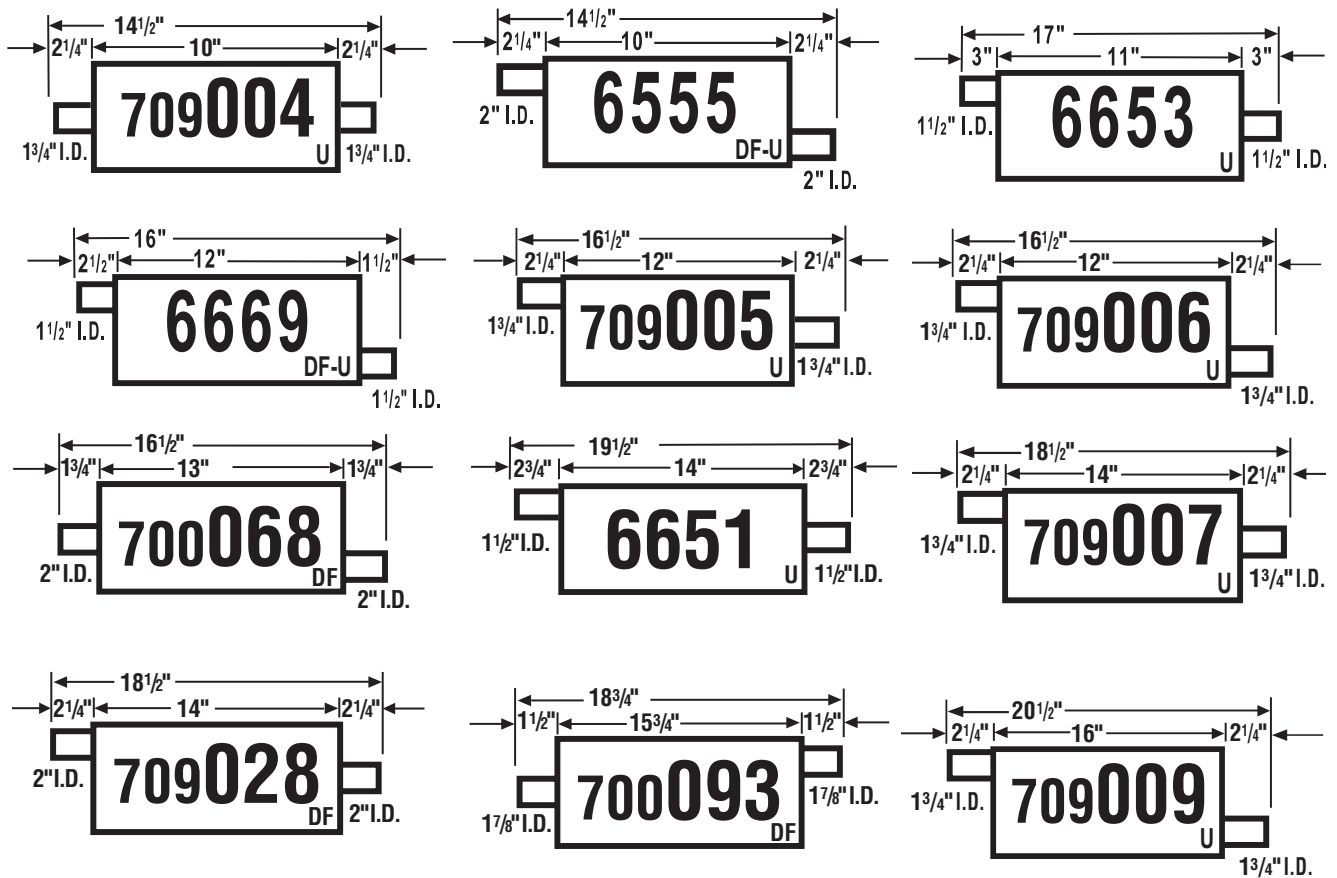

NOTE: Black area denotes welded head bracket.

DF-U - Denotes muffler used primarily as Direct Fit, but is also Universal.
 U-DF - Denotes muffler used primarily as Universal, but is also Direct Fit.

DF - Direct Fit Muffler
 U - Universal Muffler
 HS - Denotes Heat Shield is on muffler.

MSL BY DIMENSION

3 1/4" x 7 3/4" OVALS

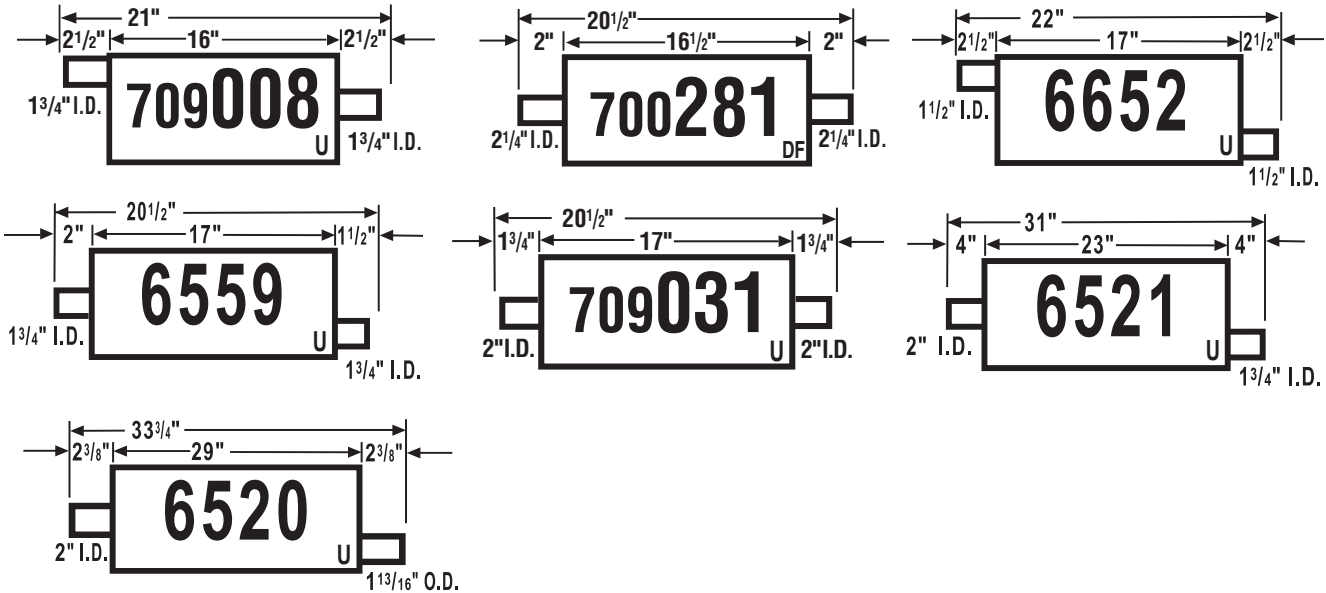

4 1/4" x 8 3/4" OVALS

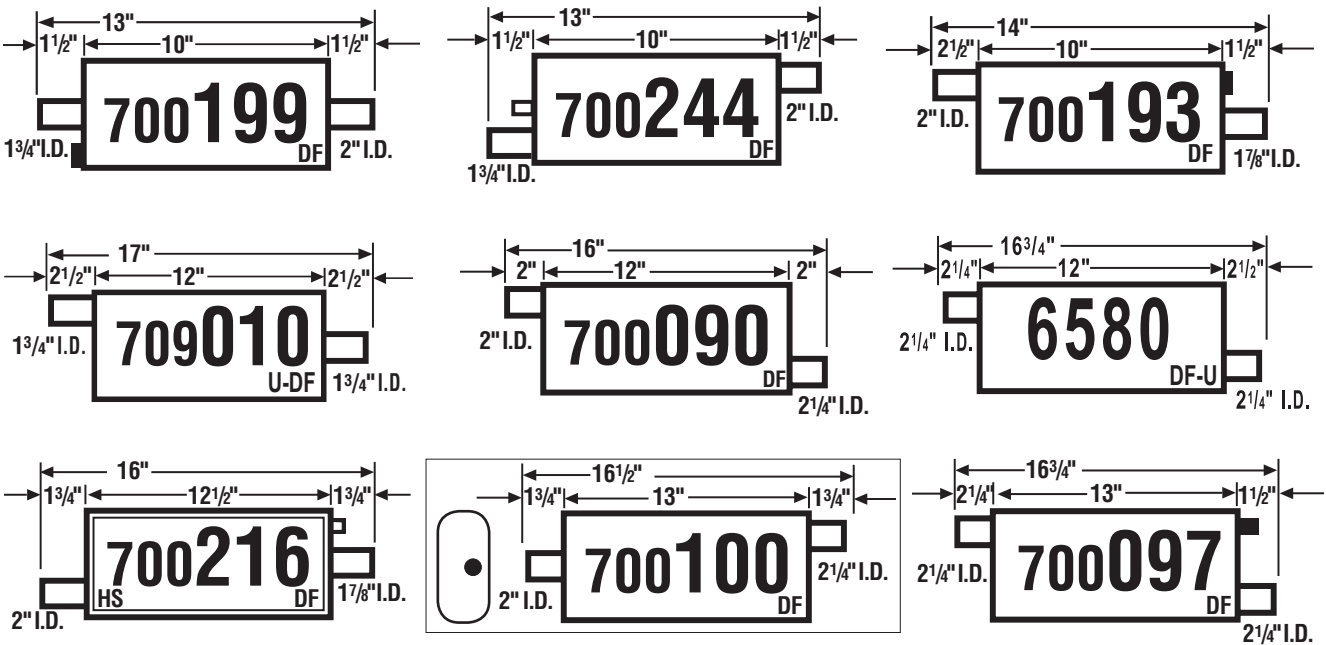

NOTE: Black area denotes welded head bracket.

DF-U - Denotes muffler used primarily as Direct Fit, but is also Universal.
U-DF - Denotes muffler used primarily as Universal, but is also Direct Fit.

DF - Direct Fit Muffler
U - Universal Muffler
HS - Denotes Heat Shield is on muffler.

UNIVERSAL SPECS

by DIMENSION

Sorted first by Cross Section, then Shell Length, then Inlet Diameter.

MAXIMUM **MSL**

4 1/4" x 8 3/4" OVALS

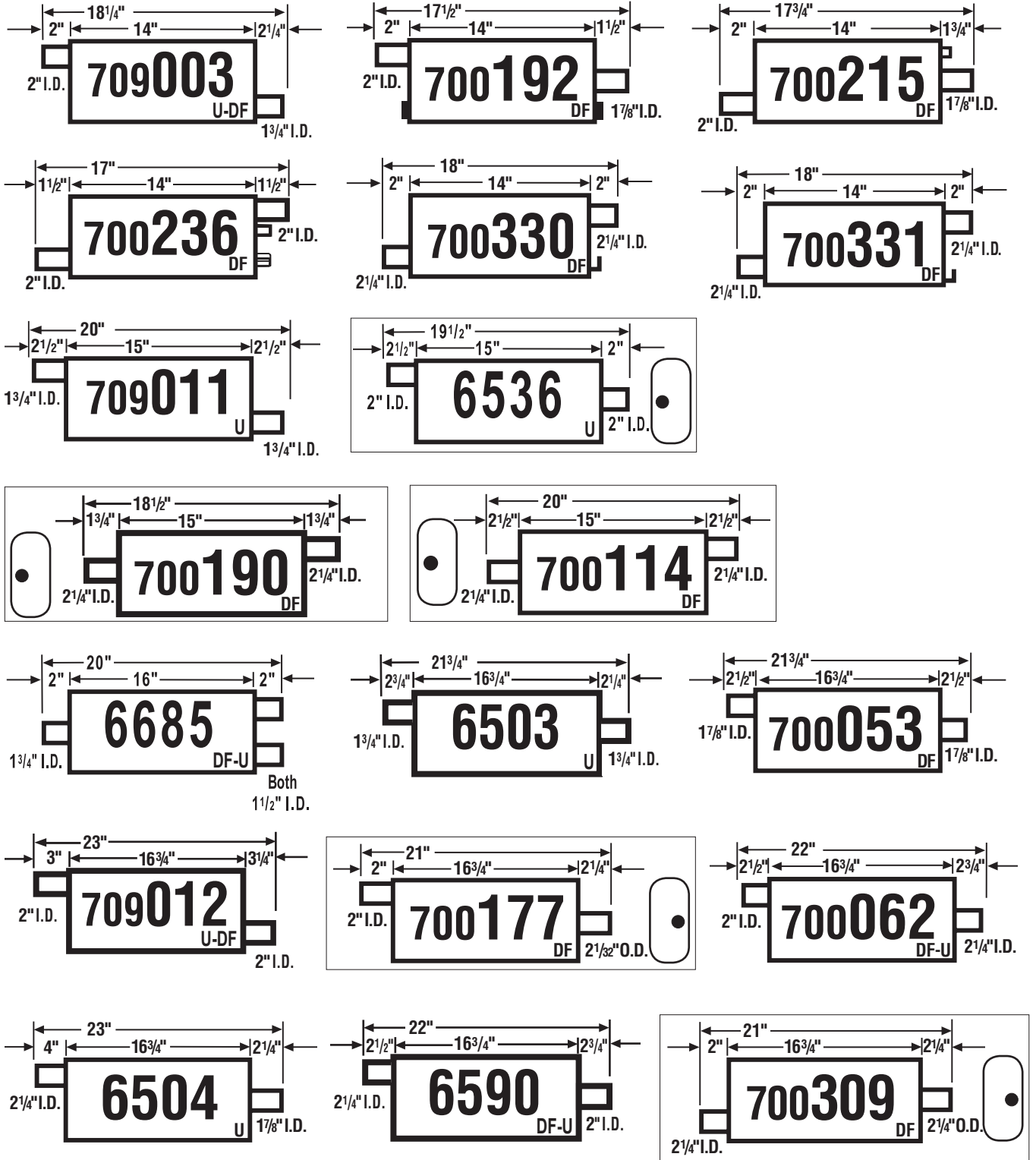

NOTE: Black area denotes welded head bracket.

DF-U - Denotes muffler used primarily as Direct Fit, but is also Universal.
 U-DF - Denotes muffler used primarily as Universal, but is also Direct Fit.

DF - Direct Fit Muffler
 U - Universal Muffler
 HS - Denotes Heat Shield is on muffler.

MSL BY DIMENSION

4 1/4" x 8 3/4" OVALS

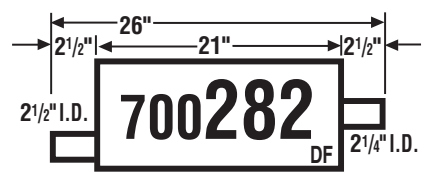
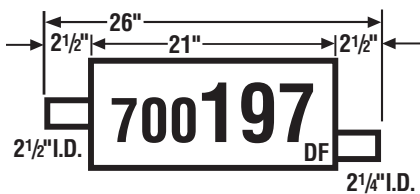
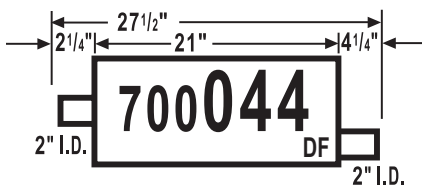
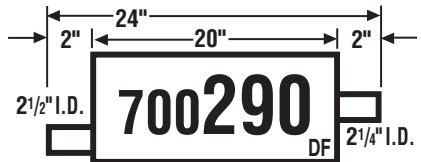
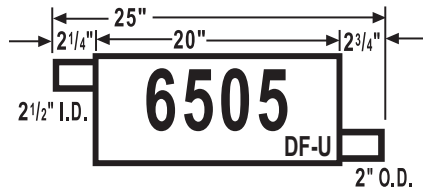
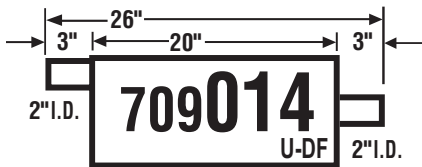
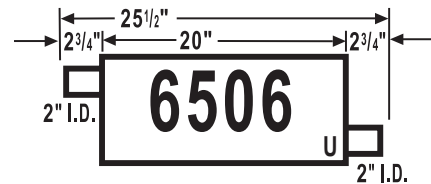
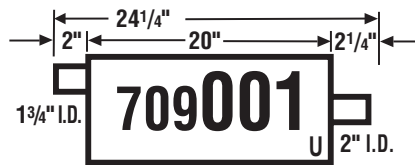
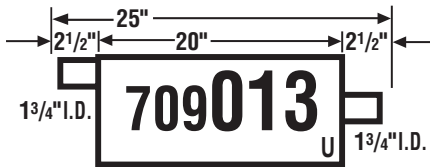
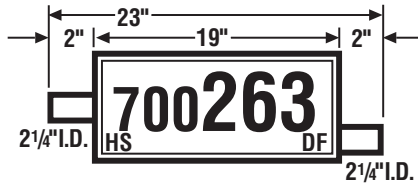
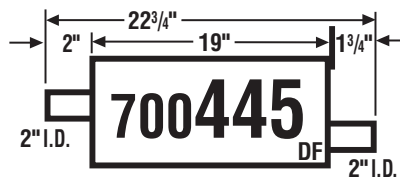
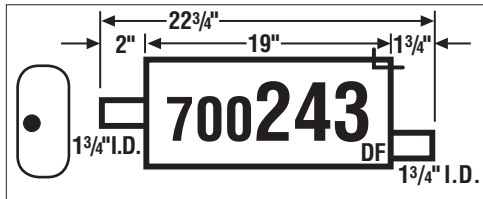
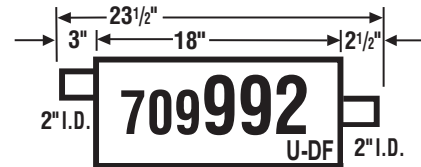
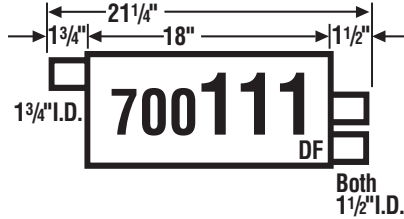
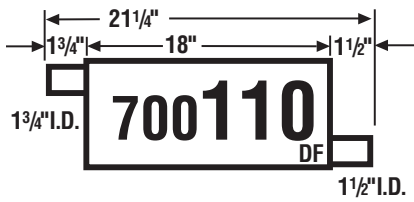

MSL BY DIMENSION

NOTE: Black area denotes welded head bracket.

DF-U - Denotes muffler used primarily as Direct Fit, but is also Universal.

U-DF - Denotes muffler used primarily as Universal, but is also Direct Fit.

DF - Direct Fit Muffler

U - Universal Muffler

HS - Denotes Heat Shield is on muffler.

UNIVERSAL SPECS

by DIMENSION

Sorted first by Cross Section, then Shell Length, then Inlet Diameter.

MAXIMUM **MSL**

4 1/16" x 10 1/2" OVALS

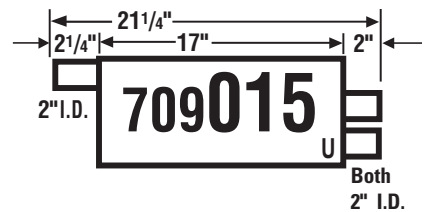
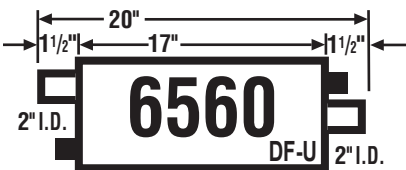
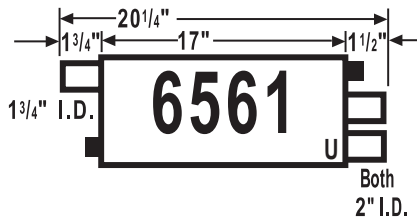
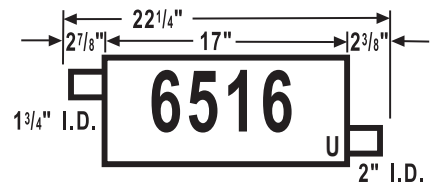
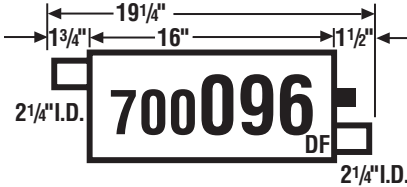
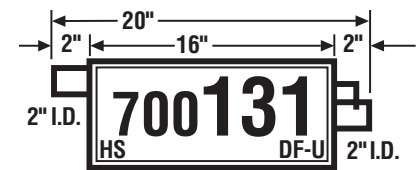
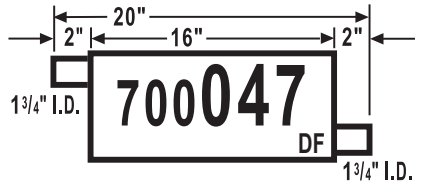
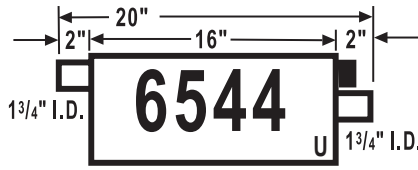
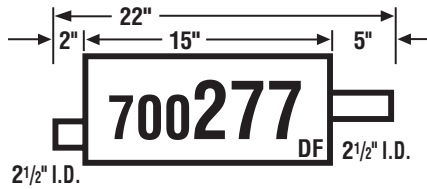
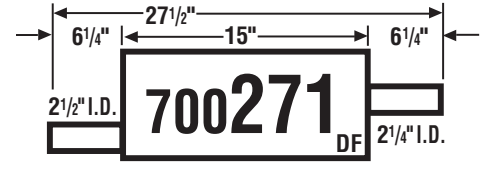
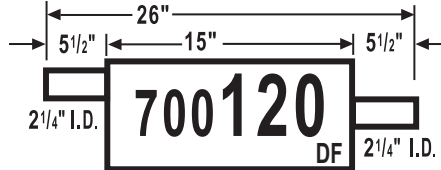
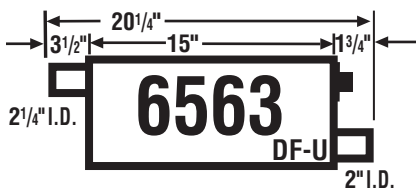
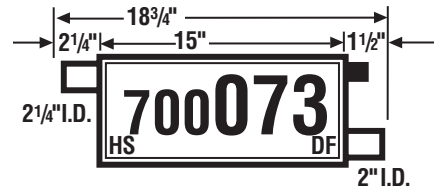
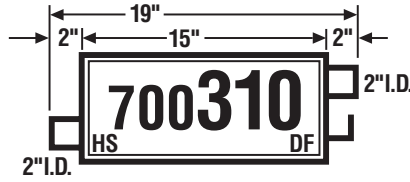
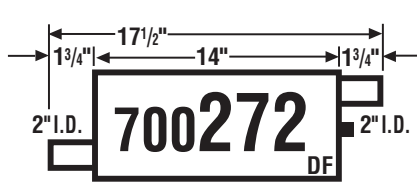
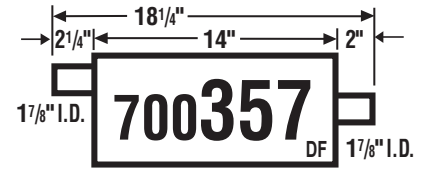
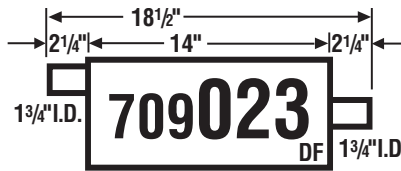
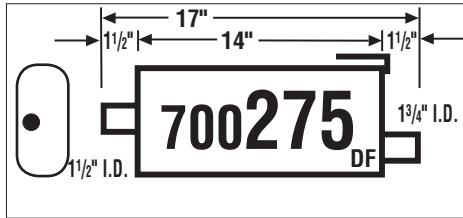
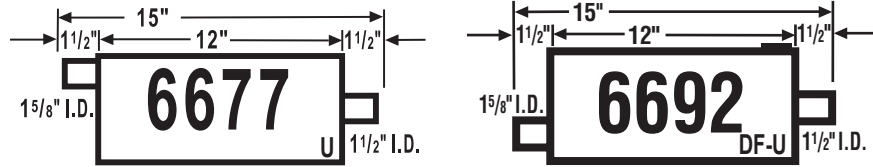

NOTE: Black area denotes welded head bracket.

DF-U - Denotes muffler used primarily as Direct Fit, but is also Universal.
 U-DF - Denotes muffler used primarily as Universal, but is also Direct Fit.

DF - Direct Fit Muffler
 U - Universal Muffler
 HS - Denotes Heat Shield is on muffler.

MSL BY DIMENSION

4 1/16" x 10 1/2" OVALS

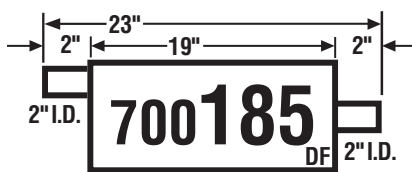
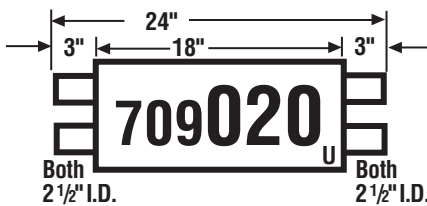
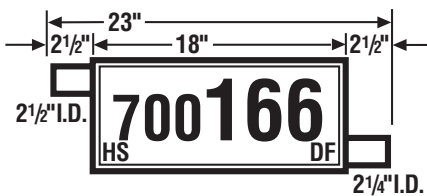
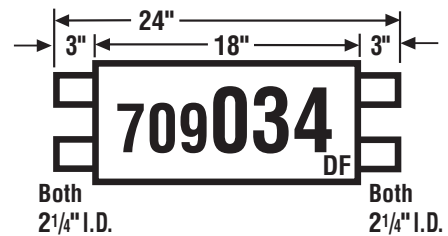
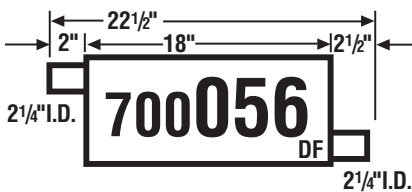
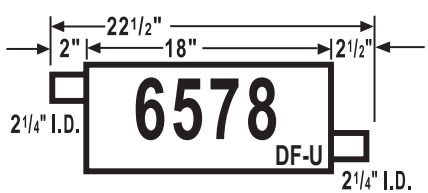
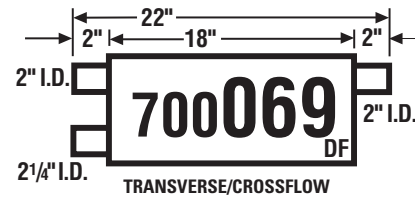
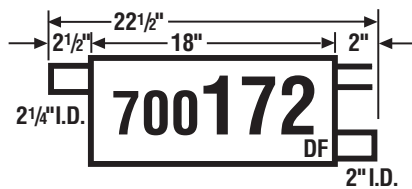
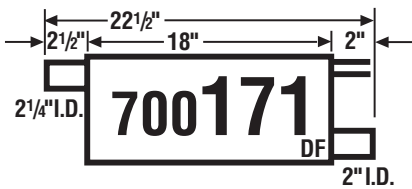
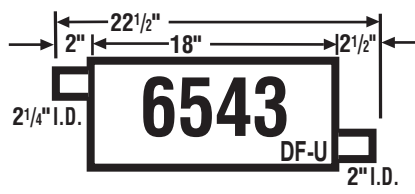
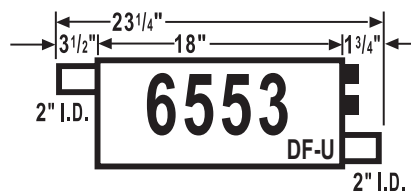
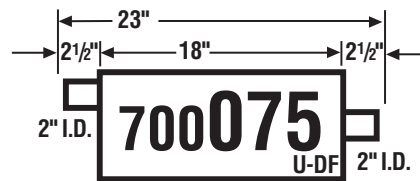
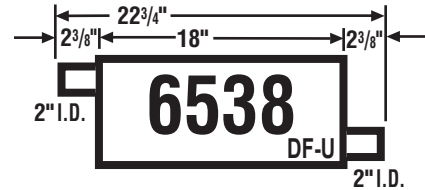
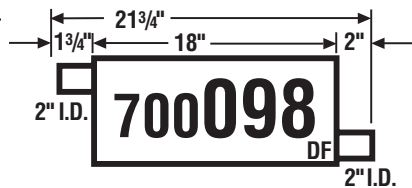
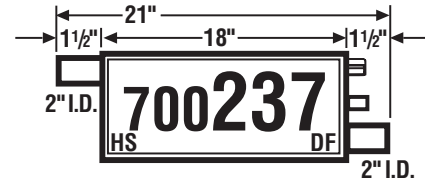
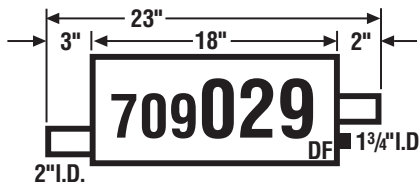
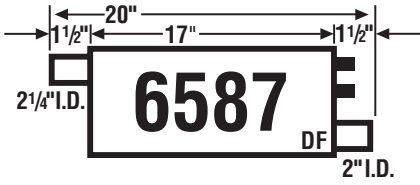

NOTE: Black area denotes welded head bracket.

DF-U - Denotes muffler used primarily as Direct Fit, but is also Universal.
U-DF - Denotes muffler used primarily as Universal, but is also Direct Fit.

DF - Direct Fit Muffler
U - Universal Muffler
HS - Denotes Heat Shield is on muffler.

MSL BY DIMENSION

UNIVERSAL SPECS

by DIMENSION

Sorted first by Cross Section, then Shell Length, then Inlet Diameter.

MAXIMUM **TMSL**

4 1/16" x 10 1/2" OVALS

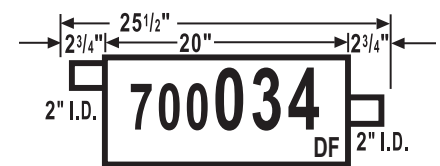
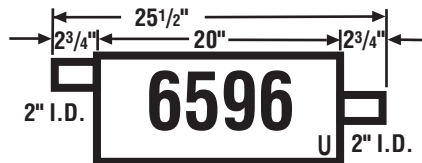
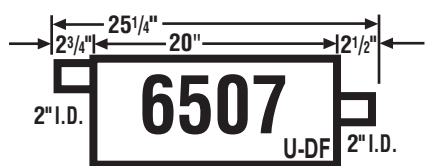
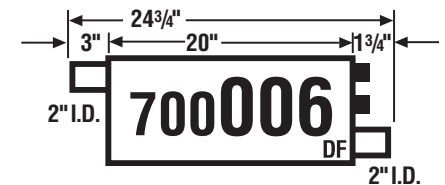
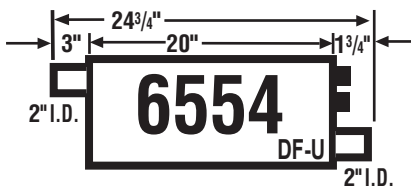
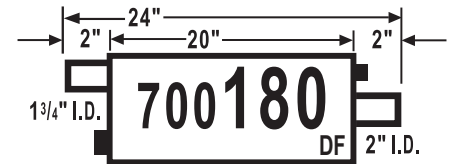
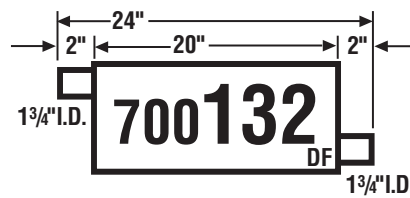
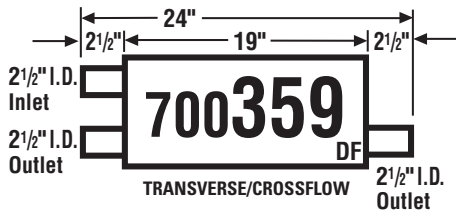
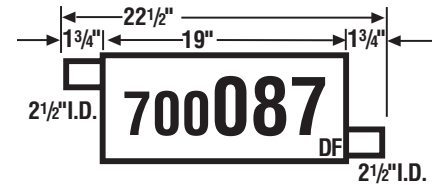
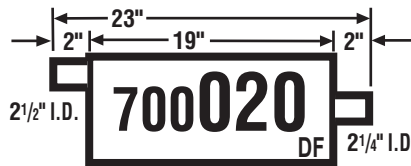
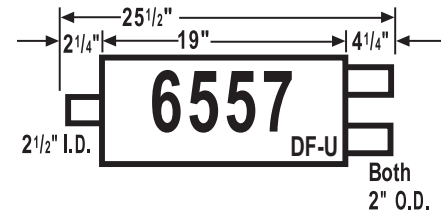
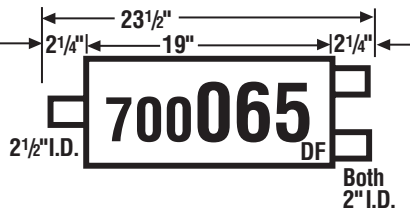
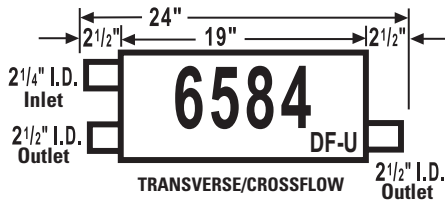
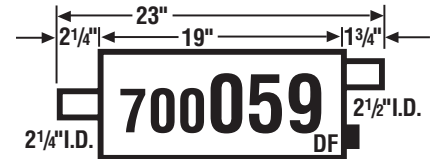
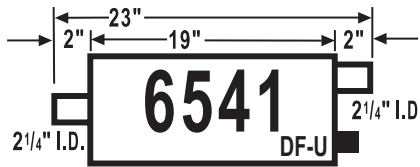
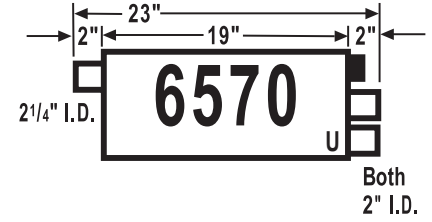
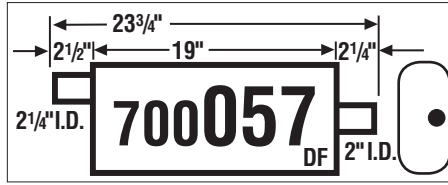
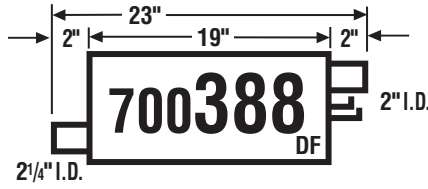

NOTE: Black area denotes welded head bracket.

DF-U - Denotes muffler used primarily as Direct Fit, but is also Universal.
 U-DF - Denotes muffler used primarily as Universal, but is also Direct Fit.

DF - Direct Fit Muffler
 U - Universal Muffler
 HS - Denotes Heat Shield is on muffler.

MSSL BY DIMENSION

4 1/16" x 10 1/2" OVALS

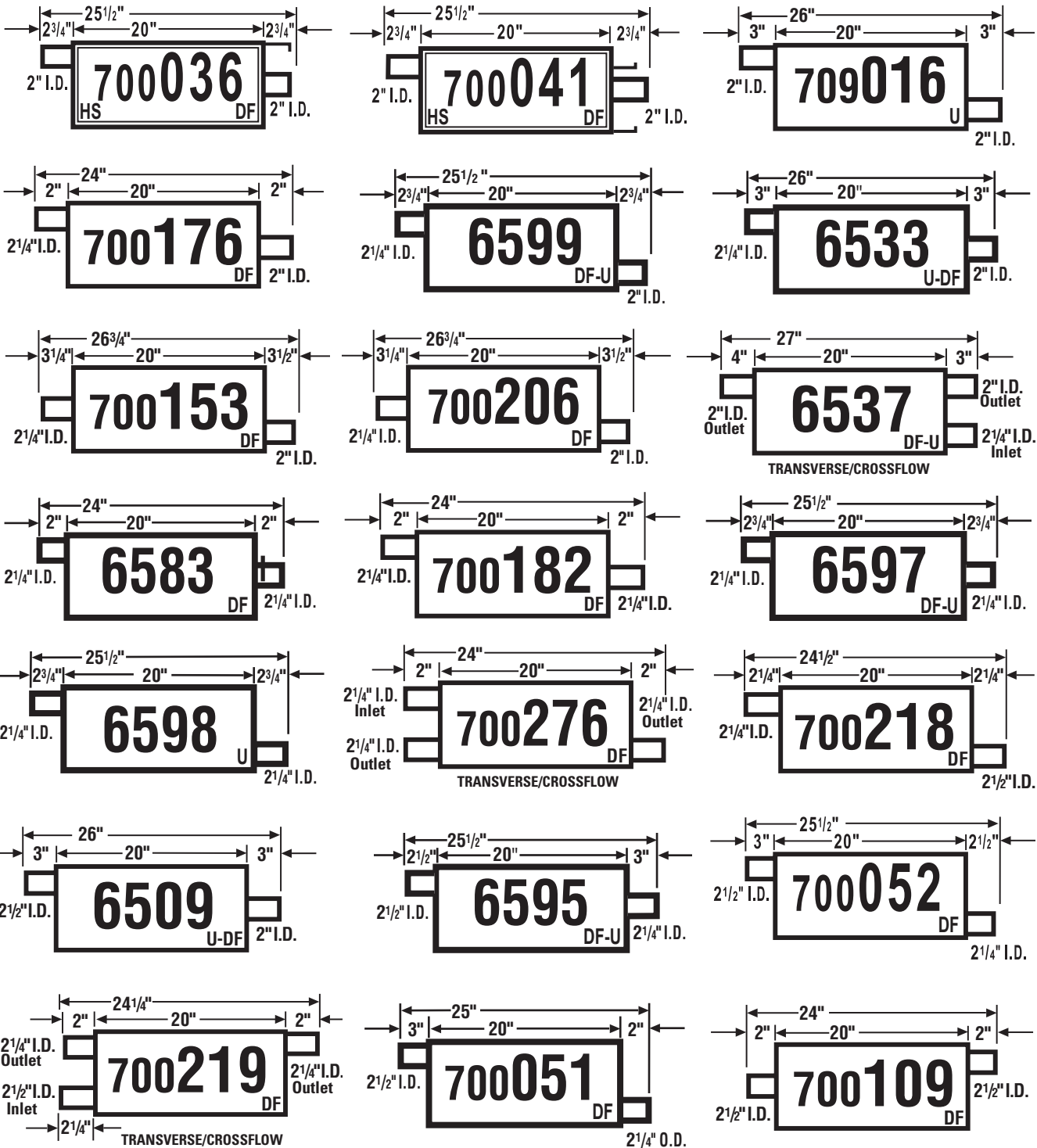

MSL BY DIMENSION

NOTE: Black area denotes welded head bracket.

DF-U - Denotes muffler used primarily as Direct Fit, but is also Universal.
U-DF - Denotes muffler used primarily as Universal, but is also Direct Fit.

DF - Direct Fit Muffler
U - Universal Muffler
HS - Denotes Heat Shield is on muffler.

UNIVERSAL SPECS

by DIMENSION

Sorted first by Cross Section, then Shell Length, then Inlet Diameter.

MAXIMUM **MSL**

4 1/16" x 10 1/2" OVALS

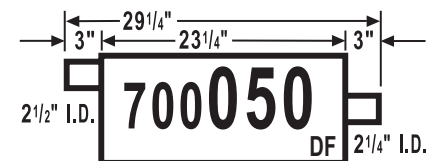
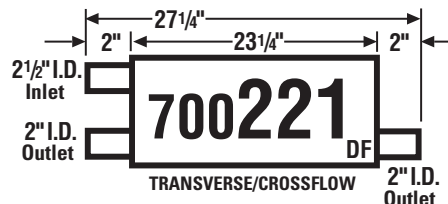
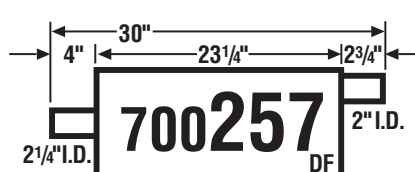
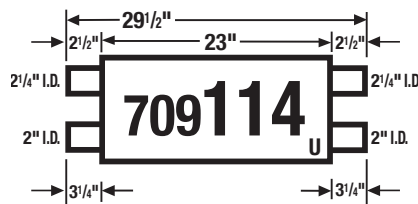
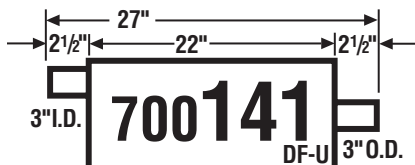
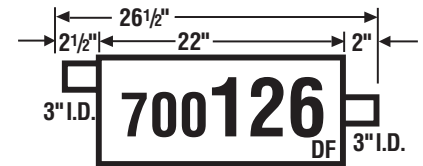
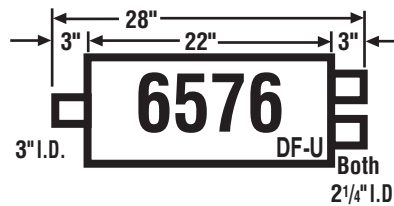
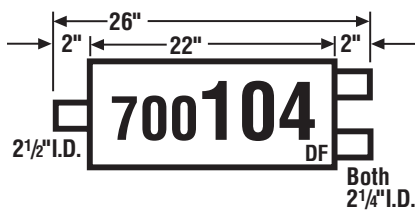
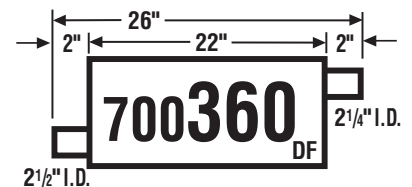
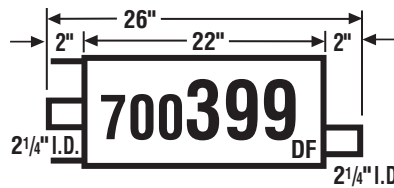
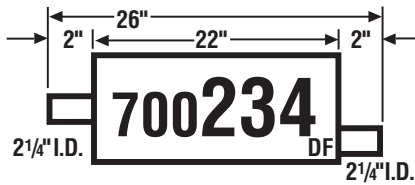
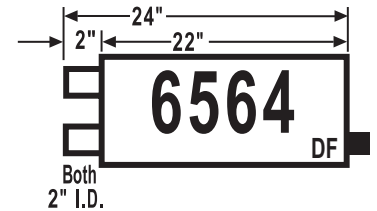
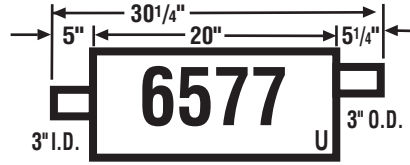
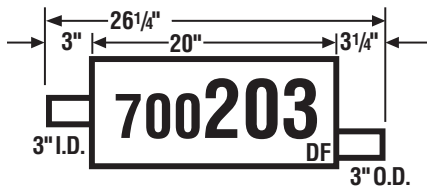
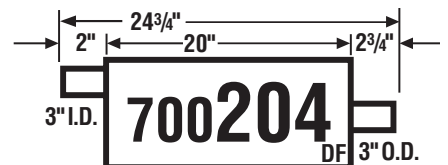
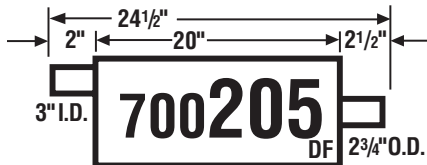
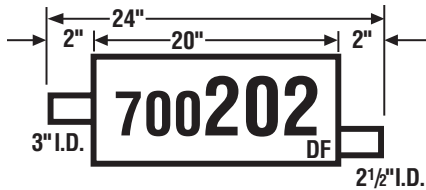
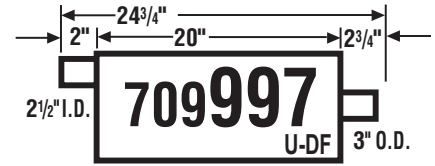
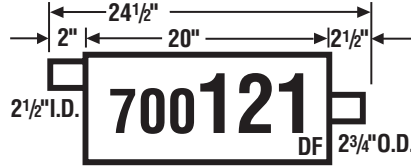
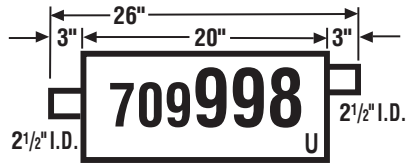

NOTE: Black area denotes welded head bracket.

DF-U - Denotes muffler used primarily as Direct Fit, but is also Universal.
 U-DF - Denotes muffler used primarily as Universal, but is also Direct Fit.

DF - Direct Fit Muffler
 U - Universal Muffler
 HS - Denotes Heat Shield is on muffler.

MSL BY DIMENSION

4 1/16" x 10 1/2" OVALS

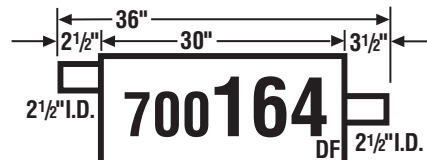
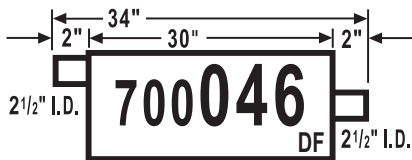
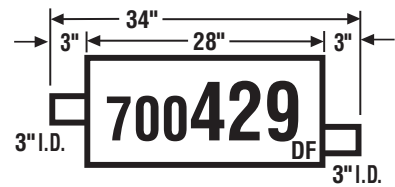
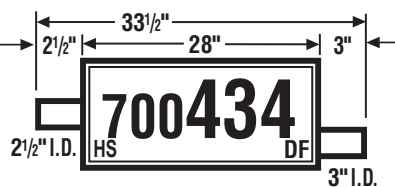
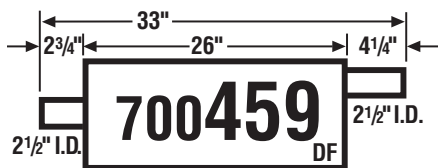
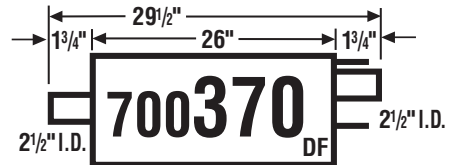
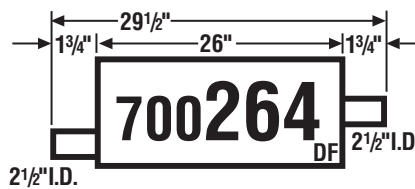
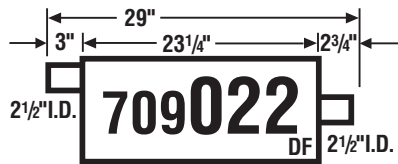

4 1/2" x 11" OVALS

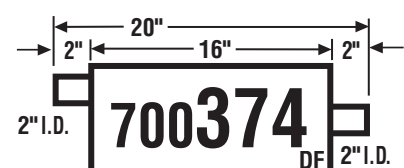
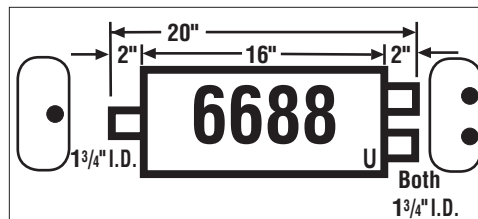
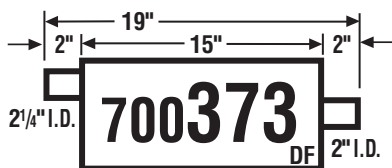
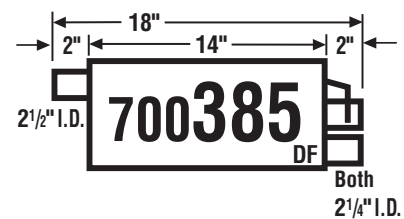
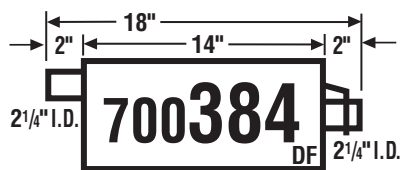
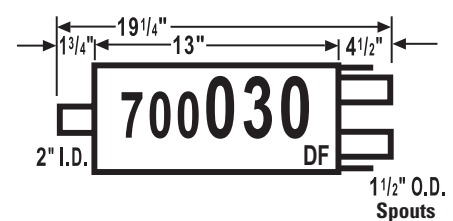
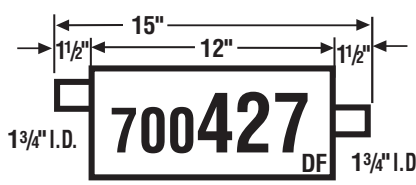
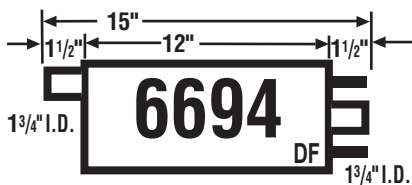

NOTE: Black area denotes welded head bracket.

DF-U - Denotes muffler used primarily as Direct Fit, but is also Universal.
U-DF - Denotes muffler used primarily as Universal, but is also Direct Fit.

DF - Direct Fit Muffler
U - Universal Muffler
HS - Denotes Heat Shield is on muffler.

UNIVERSAL SPECS

by DIMENSION

Sorted first by Cross Section, then Shell Length, then Inlet Diameter.

MAXIMUM. **MSL**

4 1/2" x 11" OVALS

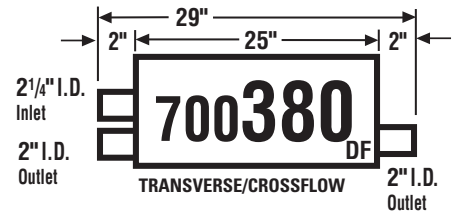
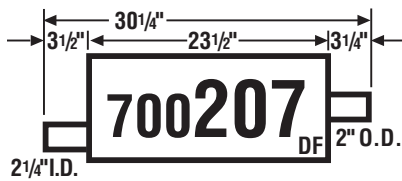
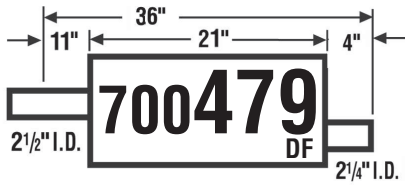
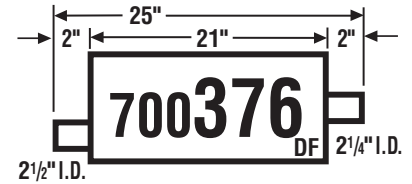
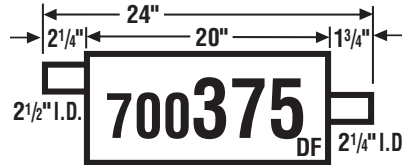
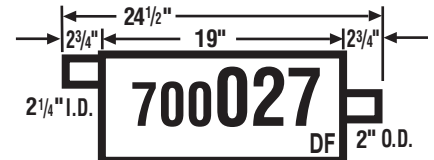
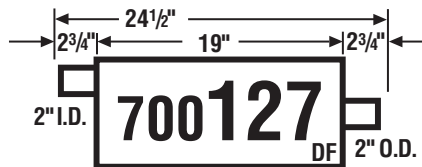
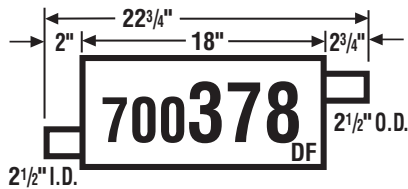
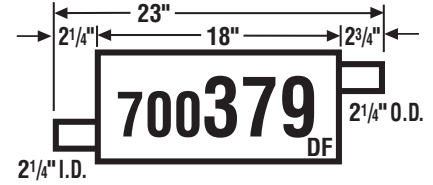
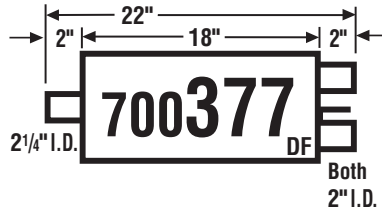

5 1/2" x 11" OVALS

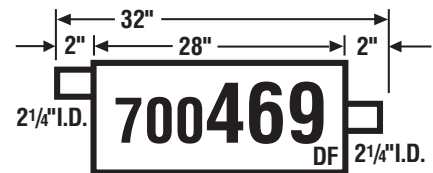
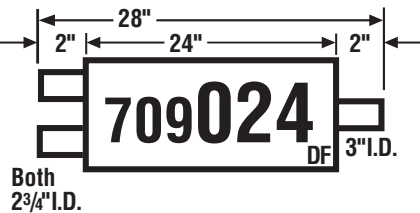

NOTE: Black area denotes welded head bracket.

DF-U - Denotes muffler used primarily as Direct Fit, but is also Universal.
 U-DF - Denotes muffler used primarily as Universal, but is also Direct Fit.

DF - Direct Fit Muffler
 U - Universal Muffler
 HS - Denotes Heat Shield is on muffler.

MSL BY DIMENSION

7" x 9" OVALS

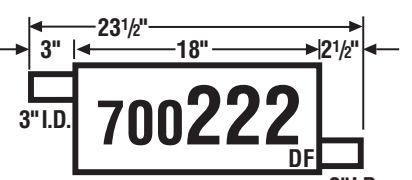
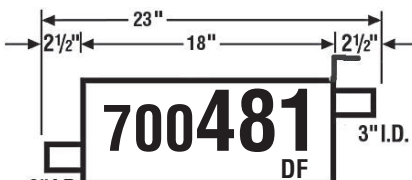
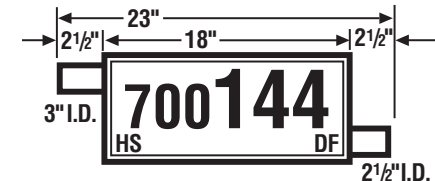
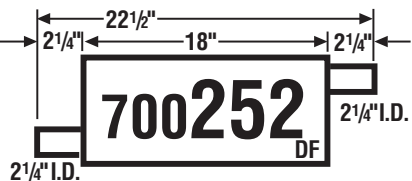
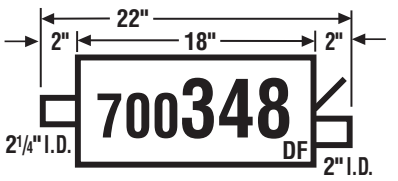
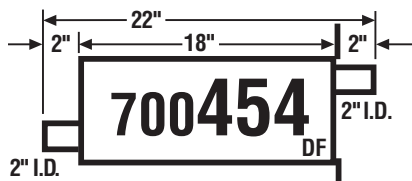
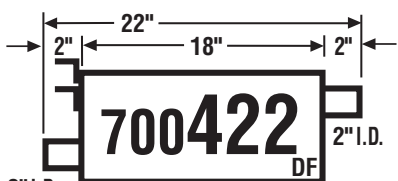
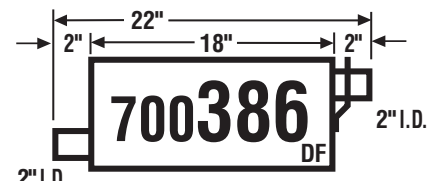
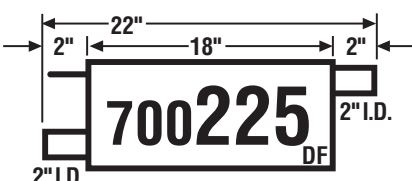
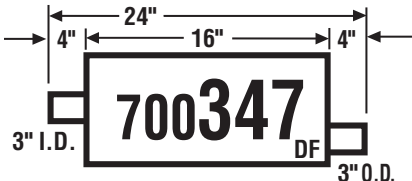
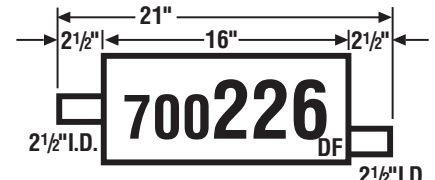
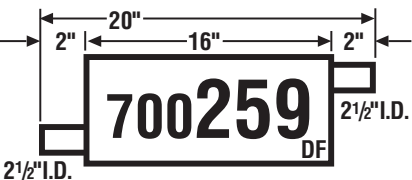
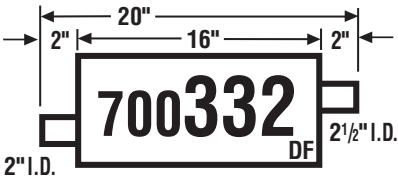
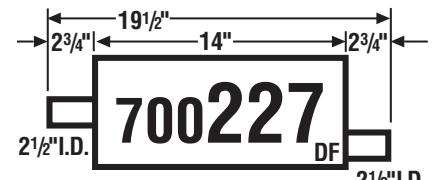
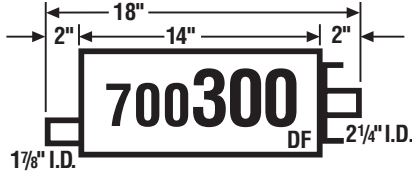
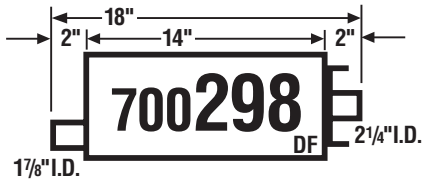
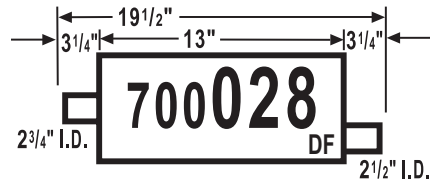
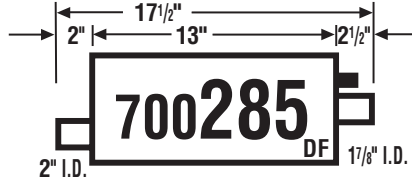
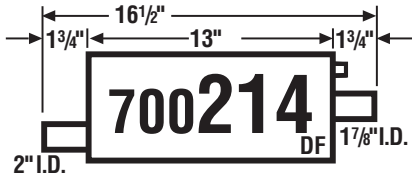

MSL BY DIMENSION

NOTE: Black area denotes welded head bracket.

DF-U - Denotes muffler used primarily as Direct Fit, but is also Universal.

U-DF - Denotes muffler used primarily as Universal, but is also Direct Fit.

DF - Direct Fit Muffler

U - Universal Muffler

HS - Denotes Heat Shield is on muffler.

UNIVERSAL SPECS

by DIMENSION

Sorted first by Cross Section, then Shell Length, then Inlet Diameter.

MAXIMUM **MSL**

7" x 9" OVALS

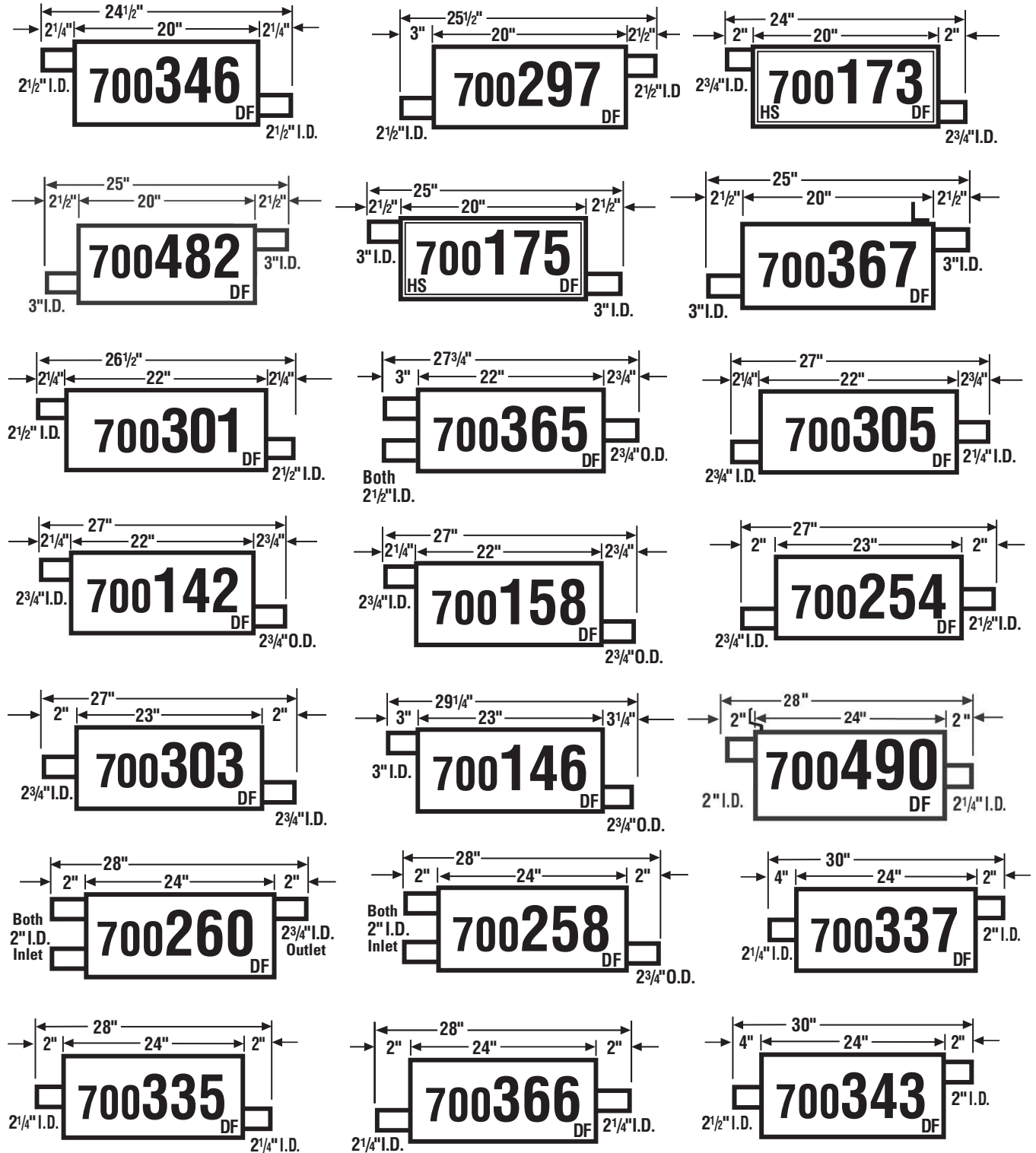

NOTE: Black area denotes welded head bracket.

DF-U - Denotes muffler used primarily as Direct Fit, but is also Universal.
 U-DF - Denotes muffler used primarily as Universal, but is also Direct Fit.

DF - Direct Fit Muffler
 U - Universal Muffler
 HS - Denotes Heat Shield is on muffler.

MSL BY DIMENSION

7" x 9" OVALS

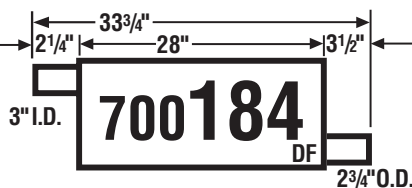
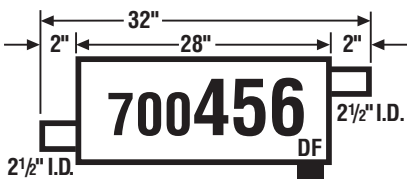
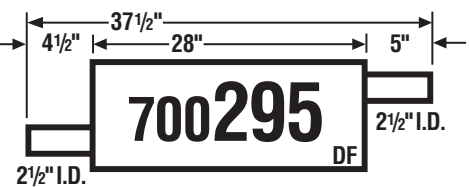
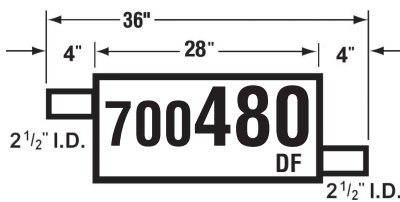
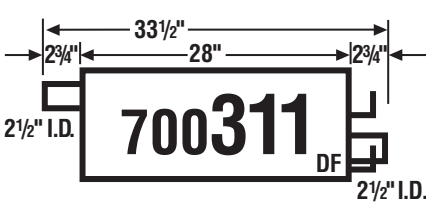
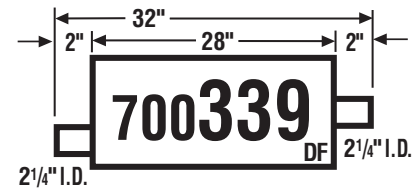
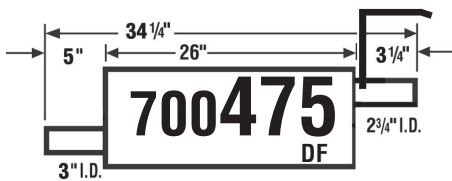
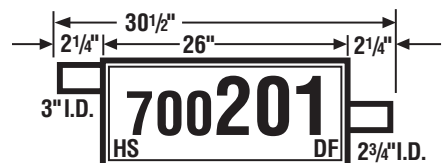
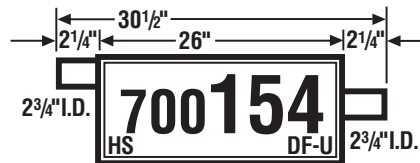
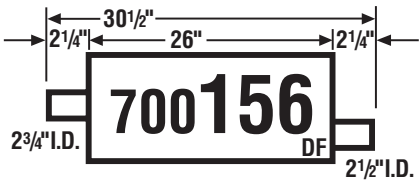
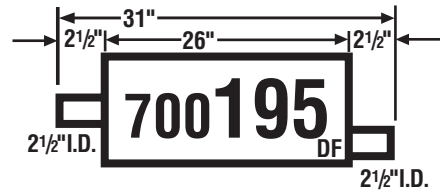
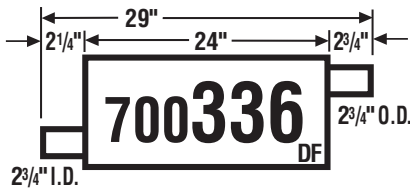
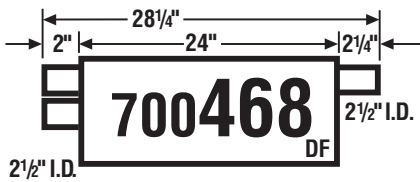
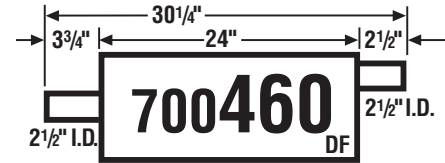
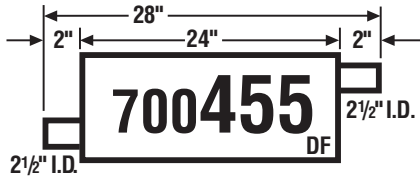
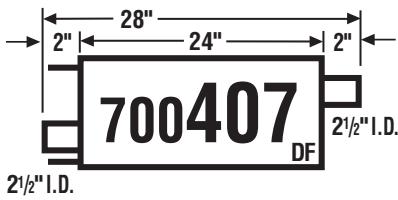

MSL BY DIMENSION

NOTE: Black area denotes welded head bracket.

DF-U - Denotes muffler used primarily as Direct Fit, but is also Universal.
U-DF - Denotes muffler used primarily as Universal, but is also Direct Fit.

DF - Direct Fit Muffler
U - Universal Muffler
HS - Denotes Heat Shield is on muffler.

UNIVERSAL SPECS

by DIMENSION

Sorted first by Cross Section, then Shell Length, then Inlet Diameter.

MAXIMUM. **MSL**

8 1/2" x 11 1/2" OVALS

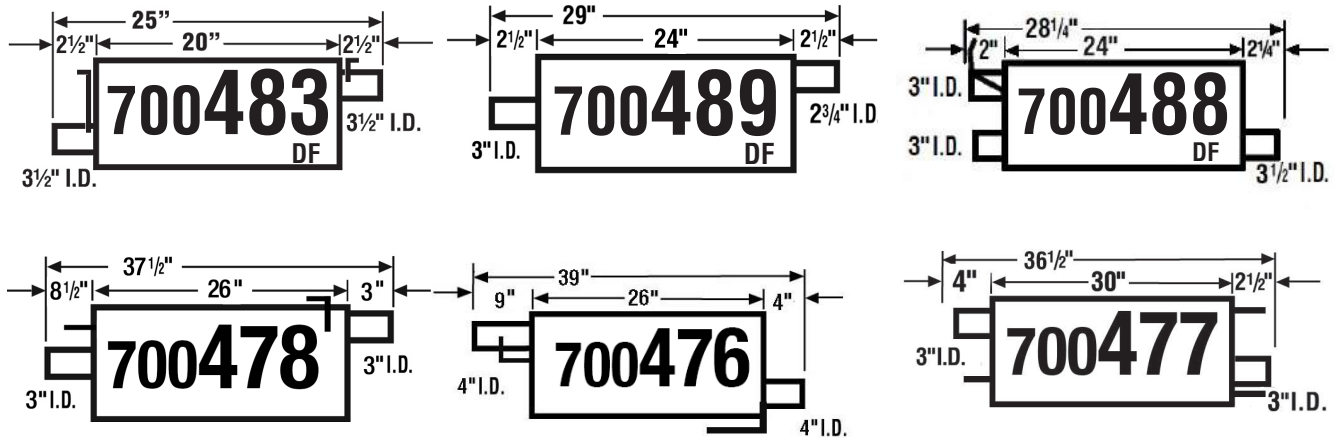

NOTE: Black area denotes welded head bracket.

DF-U - Denotes muffler used primarily as Direct Fit, but is also Universal.
U-DF - Denotes muffler used primarily as Universal, but is also Direct Fit.

DF - Direct Fit Muffler
U - Universal Muffler
HS - Denotes Heat Shield is on muffler.

MSL BY DIMENSION

P/N	YEAR	APPLICATION
6491		BIG MAX Turbo Muffler
6492		BIG MAX Turbo Muffler
6493		BIG MAX Turbo Muffler
6494		BIG MAX Turbo Muffler
6495		BIG MAX Turbo Muffler
6496		BIG MAX Turbo Muffler
6497		BIG MAX Turbo Muffler
6498		BIG MAX Turbo Muffler
6499		BIG MAX Turbo Muffler
6503		Universal MSL/Maximum Muffler
6504		Universal MSL/Maximum Muffler
6505	69-84 75-80	CHEV/GMC Truck C, K, P Series CHEV/GMC Truck Blazer/Jimmy
6506	70-72 70-72 71-72 70-72	CHEV/GMC Truck Caballero/Sprint CHEV Chevelle, Malibu, Monte Carlo, El Camino CHEV Full Size PONT LeMans, Tempest
6507	63-66 73-74 73-74 72-74 1966 1974 65-72 73-74	AMC Ambassador, Classic CHEV/GMC Truck Caballero/Sprint CHEV Full-Size (1973); Chevelle (73-74) FORD/MERC Fairlane, Torino, Ranchero/Montego FORD/MERC Fairlane, Comet FORD Ranchero, Torino Sta. Wgn. FORD; Full-Size PONT Full-Size, Grand Prix, LeMans, Tempest
6509	72-76	FORD/MERC Full-Size
6510	65-74	CHRY; Full-Size; Imperial (67-72)
6511	1979	FORD Truck F100/150, F200/250 Series; 138" & 155" W.B., 4.9L & 5.0L Eng.
6512	67-71	CHEV/GMC Truck Van Blazer/Jimmy (69-74); C, K, P Series (69-74); G Series (67-74)
6516		Universal MSL/Maximum Muffler
6519		BIG MAX Turbo Muffler
6520	54-64	CHEV Full-Size
6521		Universal MSL/Maximum Muffler
6525		Universal MSL/Maximum Muffler
6526		Universal MSL/Maximum Muffler
6527		Universal MSL/Maximum Muffler
6529		Universal MSL/Maximum Muffler
6530	88-91	ISUZU Truck Pickups, Trooper, Trooper II
6532	71-74	CAD; 8 Cyl., All Models (Front)
6533	67-78	FORD Full-Size LTD II, Ranchero, Torino, Torino Elite; Thunderbird (74- 78); Falcon

P/N	YEAR	APPLICATION
6534		BIG MAX Turbo Muffler
6536	75-80	BUICK/CHEV/OLDS/PONT Skyhawk/ Monza/Starfire, Sunbird (76-80); Astre (1975)
6537	75-79 75-81	BUICK/CHEV/OLDS/PONT Apollo, Skylark/Chevy II-Nova (75-78)/Ome- ga/Ventura II, Phoenix CHEV/PONT Camaro, Firebird
6538	80-85 80-83 80-86 80-85 80-81 82-86	BUICK Full-Size CAD; Full-Size CHEV Full-Size (80-84); Camaro (82- 86) OLDS; Full-Size PONT Catalina, Bonneville, Safari Sta. Wag. PONT Firebird, Parisienne (1984)
6539		Universal MSL/Maximum Muffler
6540	78-87 78-84	BUICK/CHEV/OLDS/PONT Regal(78- 87); Century (78-81)/Malibu, Monte Carlo, El Camino/Cutlass/Bonneville (82-86); Grand Prix (78-87); LeMans, Grand AM (78-81) CHEV/GMC Truck Caballero/Sprint
6541#	79-85	BUICK/CAD/OLDS; Eldorado/Seville (80-85); Riviera/Toronado (79-85)
6542		Universal MSL/Maximum Muffler
6543	77-90 84-96 77-90	BUICK/CAD/OLDS; Full-Size; Riviera (77-78); Cadillac (79-82) (1985) BUICK/CHEV/OLDS/PONT Century/ Cutlass Ciera (84-96); 6000 (85-91); Celebrity (85-90) CHEV/PONT Full-Size
6544#		Universal MSL/Maximum Muffler
6550#	81-88	CHRY/DODGE/PLYM New Yorker (83-87); LeBaron, Town & Country (82-86); 600/Caravelle (81-88); Aries/ Reliant (81-86); 400 (81-85)
6551#	79-87	CHEV/PONT Chevette/T1000 (81-87)
6553#	80-82 79-82	FORD/MERC Granada/Cougar FORD/MERC Fairmont/Zephyr
6554#	83-89 79-82 80-89	FORD/MERC Crown Victoria/Grand Marquis FORD/MERC LTD/Marquis LINC; Mark VI (80-83); Continental (80-81); Town Car (81-89)
6555	77-81	CHEV/PONT Camaro, Z28/Firebird, Trans Am (78-81)
6557	80-87	CHEV/GMC Truck Blazer/Jimmy; C, G, K, P Series
6558	84-94	FORD/MERC Tempo/Topaz
6559		Universal MSL/Maximum Muffler

Muffler includes bracket.

MUFFLER NUMERICAL LISTING



6560#	84-94	BUICK/CAD/CHEV/OLDS/PONT Skyhawk (84-89) (85-87)/Cimarron (84-88)/Cavalier (84-94)/ Grand AM (85-91)/Sunbird (84-94)
6561#		Universal MSL/Maximum Muffler
6562#		Universal MSL/Maximum Muffler
6563#	83-89	FORD/MERC Mustang/Capri (83-86)
6564#	84-86	BUICK/CHEV/OLDS/PONT Century/Celebrity/Cutlass Ciera/6000 (All Sta. Wagons)
6565#		Universal MSL/Maximum Muffler
6567#	85-90	FORD/MERC Escort (85-90); EXP (86-88)/Lynx (85-87)
6569#	82-84	DODGE/PLYM Truck Rampage/Scamp
	83-87	DODGE/PLYM Charger (FWD)/Turismo
	81-90	DODGE/PLYM Omni/Horizon
6570#		Universal MSL/Maximum Muffler
6571#	85-92	FORD Truck Ranger
6572#	87-90	DODGE/PLYM Caravan, Caravan C/V, Voyager, Mini Ram Van, Grand Caravan, Grand Caravan C/V, Grand Voyager
6573#	82-87	BUICK/CHEV/OLDS/PONT Century/Celebrity/Cutlass Ciera/6000
6575#	84-91	BUICK/CHEV/OLDS/PONT Skyhawk (84-89); Skylark (86-88); Somerset, Somerset Regal (85-87)/Cavalier (84-90)/Calais (85-88); Firenza (84-88)/Grand Am (85-87)/J2000, Sunbird (84-91)
6576	91-95	CHEV/GMC Truck C, K Series
6577		Universal MSL/Maximum Muffler
6578	86-91	BUICK/CAD/OLDS/PONT Electra, LeSabre, Riviera/DeVille, Fleetwood; Eldorado/Seville (86-87); 88, 98, Toronado/Bonneville (88-91)
6579#	88-93	BUICK/CHEV/OLDS/PONT Regal/Lumina (90-93)/Cutlass Supreme/Grand Prix
6580	75-79	CAD Seville
6582#		Universal MSL/Maximum Muffler
6583#	85-91	CHEV/GMC; Astro/Safari Van
6584	88-92	CHEV/PONT Camaro/Firebird
6585#	84-86	FORD Truck F150, F250, F350
6586	86-89	FORD Truck Bronco II
6587#	87-88	FORD/MERC Thunderbird/Cougar
6588#	87-92	CHEV Beretta, Corsica
	87-91	PONT Tempest (Canada)
6589#	87-92	CHEV Beretta, Corsica
	90-91	PONT Tempest (Canada)
6590	82-91	CHEV/GMC Truck S10/S15, T10/T15; Blazer/Jimmy (83-89)

6591#	84-92	BUICK Century
	86-89	CHEV Celebrity
	84-92	OLDS Cutlass Ciera
	86-91	PONT 6000
6592#	87-97	FORD Truck Bronco, F150, F250, F350
6593#	89-92	FORD Probe
	88-92	MAZDA 626, MX-6
6595	1982	CHEV/GMC; Van G Series
	80-89	DODGE/PLYM Truck AD, AW, PD, PW Series
	75-76	FORD/MERC Galaxie, LTD/Marquis
	75-77	GM; Century, LeSabre, Electra, Riviera, Bel Air, Impala, Caprice, Cutlass, Delta 88, 98, LeMans, Catalina, Bonneville, Grand Prix
	1978	OLDS; Toronado
6596		Universal MSL/Maximum Muffler
6597	94-96	BUICK/OLDS; Park Avenue, 98
	67-80	CHRY/DODGE/PLYM; Full-Size, Cordoba
	91-92	FORD Truck Explorer
	77-78	FORD/MERC LTD/Marquis
	73-77	GM; LeSabre, Centurion, Electra, Caprice, Impala, Toronado, Delta 88, 98, Catalina, Bonneville, Grand Prix
	1995	CAD Deville
6598		Universal MSL/Maximum Muffler
6599	75-78	CHEV/GMC; Van G Series
	65-73	GM; Full-Size, Intermediate
6651		Universal MSL/Maximum Muffler
6652		Universal MSL/Maximum Muffler
6653		Universal MSL/Maximum Muffler
6654		Universal MSL/Maximum Muffler
6655		Universal MSL/Maximum Muffler
6656		Universal MSL/Maximum Muffler
6658		Universal MSL/Maximum Muffler
6669	74-82	NISSAN 210, B210
6672	75-82	CHEV Truck Luv
	81-87	ISUZU Truck Pickup
	84-85	ISUZU Truck Trooper II
	84-95	TOYOTA Truck 4-Runner
	79-95	TOYOTA Truck Pickup, Cab & Chassis
6676		Universal MSL/Maximum Muffler
6677		Universal MSL/Maximum Muffler
6678#	84-93	VOLVO; 240 DL, GL
	80-85	VOLVO; 2, 4-Dr. Sedan, Sta. Wag.
	75-80	VOLVO; 240, 260 Series
6682#	83-86	TOYOTA Camry
6685	86-89	ACURA Integra
	86-87	HONDA Civic, Si Hatchback
6688		Universal MSL/Maximum Muffler

Muffler includes bracket.

P/N	YEAR	APPLICATION
6689#	90-94	SUBARU Loyale
	85-89	SUBARU 3-Dr. Coupe, 4-Dr. Sedan, Sta. Wag.
6691#	87-91	TOYOTA Camry
6692#	87-93	NISSAN Sentra
6693#	87-90	NISSAN Pulsar, Sentra
6694#	90-92	GEO Prizm
	88-92	TOYOTA Corolla
6695#	86-97	NISSAN Truck D21 (Hardbody)Pickup
6697#	86-93	TOYOTA Celica
690003		BIG MAX Turbo Muffler
690008		BIG MAX Turbo Muffler
690500		BIG MAX Turbo Muffler
690501		BIG MAX Turbo Muffler
690502		BIG MAX Turbo Muffler
690503		BIG MAX Turbo Muffler
690510		BIG MAX Turbo Muffler
690511		BIG MAX Turbo Muffler
690512		BIG MAX Turbo Muffler
690513		BIG MAX Turbo Muffler
690514		BIG MAX Turbo Muffler
700000#	87-96	FORD Van Econoline E150/250/350
700001#	80-86	FORD Truck F Series; Bronco (80-84)
700002#	86-89	FORD Van Aerostar
700003#	89-94	GEO Metro; CHEV Sprint; PONT Firefly (89-91)
	89-94	SUZUKI Swift
700006#	83-89	FORD Crown Victoria
	80-82	FORD LTD
	82-89	LINC Town Car
	80-89	MERC Grand Marquis
700009#	90-94	HYUNDAI Excel
	90-92	NISSAN Sentra
700010	86-93	MAZDA Truck B2200; B2600 (87-88) Pickup
700011#	87-89	CHEV Cavalier Z24
700012#	88-93	FORD Festiva
700013#	90-91	FORD Crown Victoria Sedan, Sta. Wag. (Right Side)
	90-91	MERC Grand Marquis Sedan, Sta. Wag. (Right Side)
700016#	84-94	FORD/MERC Tempo/Topaz
700017#	86-89	HONDA Accord, 2-Dr. Hatchback, Coupe; 4-Dr. Sedan
700018#	90-93	HONDA Accord DX, LX, 2-Dr. Coupe, 4-Dr. Sedan
700019#	90-93	HONDA Accord EX, SE (1991 & 1993) 2-Dr. Coupe, 4-Dr. Sedan

P/N	YEAR	APPLICATION
700020	88-04	CHEV/GMC Truck T10/T15 Pickup
	88-95	CHEV/GMC Truck S10/S15 Pickup
	88-91	CHEV/GMC Truck S10/S15 Blazer/Jimmy
	1990	DODGE/PLYM Truck Dakota
	88-04	GMC Sonoma
	98-99	ISUZU Truck Hombre
700024#	1991	OLDS Truck Bravada
	89-95	GEO Truck Tracker
700026#	89-95	SUZUKI Truck Sidekick
	90-94	CHRY LeBaron 4-Dr. Sedan
700027	89-95	DODGE Spirit
	89-95	PLYM Acclaim
	91-95	CHRY Van Town & Country, exc. AWD
700028	91-95	DODGE/PLYM Van Caravan/Voyager
	92-93	DODGE/PLYM Truck Dakota, D150/250, W150/250, Ramcharger
700030#	89-94	NISSAN 240 SX (Rear Muffler)
700031#	84-89	NISSAN 300ZX, All Models
700032#	85-92	VW Golf, GT, GTI
	85-87	VW Jetta, exc. Diesel
700034	93-03	FORD Truck Ranger
	94-04	MAZDA Truck B2300, B2500, B3000, B4000, Pickup
700035#	93-94	FORD Truck Explorer 2-Dr
	93-94	MAZDA Truck Navajo
700036#	93-94	FORD Truck Explorer 4-Dr
700037#	92-97	FORD/LINC/MERC Crown Victoria/Town Car/Grand Marquis; Single Exh., Dual Exh. (Right Side)
700038#	92-97	FORD/LINC/MERC Crown Victoria/Town Car/Grand Marquis; Dual Exh. (Left Side)
700039#	95-03	FORD Truck Ranger
	95-04	MAZDA Truck B2300
	98-04	MAZDA Truck B2500
	95-03	MAZDA Truck B3000, B4000
700040#	95-00	FORD Truck Explorer 2-Dr
700041#	95-00	FORD Truck Explorer 4-Dr
700042#	92-94	FORD/MERC Crown Victoria/Grand Marquis Sedan; Single Exh., Dual Exh. (Right Side)
	90-94	LINC Town Car; Single Exh., Dual Exh. (Right Side)
700044	90-97	FORD Van Aerostar
700045	96-01	JEEP Truck Cherokee
	86-92	JEEP Truck Wagoneer, Comanche, Cherokee

Muffler includes bracket.

MUFFLER NUMERICAL LISTING



P/N	YEAR	APPLICATION
700046	85-97	FORD Truck F250/350/450, Commercial Stripped Chassis, Motor Home
700047	82-84	BUICK/CAD/CHEV/OLDS/PONT Skyhawk/Cimarron/Cavalier/Firenza/J2000, Sunbird
700050	75-78	CHRY Chrysler Newport, New Yorker, Imperial, Town & Country
	88-89	DODGE/PLYM Truck D100/150/250, W100/150
	79-89	DODGE/PLYM Truck Series D, W, AD, AW/PD, PW, Ramcharger/Trail Duster
	75-87	DODGE/PLYM Vans Series B, C, P, CB, MB, Wagon
700051	88-93	CHEV/GMC Truck C1500/2500, K1500/2500
	83-93	CHEV/GMC Van G20/2500, G30/3500
	82-90	CHEV/GMC Truck P30/3500
	81-85	CHEV/GMC Truck Suburban
	1979	CHEV/GMC Truck Suburban
	85-87	CHEV/GMC Truck C10/1500, C20/2500, K10/1500, R10/1500, R20/2500, V10/1500
	75-85	CHEV/GMC Truck Series C, K
	78-84	CHEV/GMC Truck C Series, K30/3500
	80-82	CHEV/GMC Truck Blazer/Jimmy
	75-82	CHEV/GMC Truck C10/1500, C30/3500, K Series
700052	71-73	CHEV Full-Size
	75-94	CHEV/GMC Van G Series
700053	82-89	CHRY New Yorker, Fifth Avenue
	80-83	CHRY Cordoba, Imperial (81-83)
	79-81	CHRY Newport (79-80); New Yorker (1979); LeBaron, Town & Country (79-80)
	79-89	DODGE Diplomat, Mirada (80-89); St. Regis (1979)
	76-80	DODGE Aspen (exc. 1978)
	82-89	PLYM Gran Fury
	76-80	PLYM Volare (exc. 1978)
700054	77-90	BUICK LeSabre Estate Wagon
	86-90	CHEV Caprice Sta. Wag.
	81-85	CHEV Caprice, Impala Sta. Wag.
	1993	CHRY Imperial, New Yorker, Fifth Avenue
	77-90	OLDS Delta 88 (77-79), Custom Cruiser (80-90)
	87-89	PONT Safari Sta. Wag.
	83-86	PONT Parisienne Sta. Wag.
	77-81	PONT Catalina, Bonneville, Sta. Wag., Safari Sta. Wag. (1981)

P/N	YEAR	APPLICATION
700056	83-90	BUICK Estate Wagon
	80-85	BUICK Full-Size Models
	81-84	BUICK Electra, Park Avenue (exc. Estate Wagon)
	77-81	BUICK LeSabre
	77-79	BUICK Electra, Riviera
	81-90	CAD Brougham (86-90); Fleetwood Brougham
	81-85	CAD Fleetwood, Deville
	77-82	CAD Full-Size Models
	81-90	CHEV Caprice, Impala (81-85)
	86-90	OLDS Custom Cruiser
	77-85	OLDS Delta 88, 98
	83-89	PONT Parisienne, Safari Sta. Wag. (87-89)
	77-81	PONT Catalina, Bonneville
700057	78-87	BUICK Century (78-87), Regal
	78-88	CHEV Chevelle, Monte Carlo
	78-87	CHEV El Camino, Malibu
	79-87	GMC Caballero
	78-88	OLDS Cutlass, Cutlass Cruiser Sta. Wag. (80-81)
	79-87	PONT Bonneville (82-87); Grand Prix
	79-81	PONT LeMans, Grand AM
700058#	84-93	VOLVO 240 DL, GL (exc. Turbo) (Front Muffler)
	80-85	VOLVO Sedan, Sta. Wag. (Front Muffler)
	80-83	VOLVO DL, Sedan, Sta. Wag. (exc. Turbo) (Front Muffler)
	77-82	VOLVO Series 242, 244, 245, 262, 264, 265 (Front Muffler)
700059#	79-85	CAD Eldorado, Seville (80-85)
700060#	86-91	BUICK Skylark
	84-89	BUICK Skyhawk
	85-87	BUICK Somerset, Somerset Regal
	84-88	CAD/OLDS Cimarron/Firenza
	84-94	CHEV Cavalier
	85-91	OLDS Calais
	85-91	PONT Grand AM
700061#	84-94	PONT Sunbird
	80-81	BUICK Riviera
	79-85	CAD Eldorado, Seville
	79-81	OLDS Toronado
700062	1988	DODGE/PLYM Truck D100/150
	79-87	DODGE/PLYM Truck/Van Series B, D, W, PB, CB300/350, MB300, PD100, PW100
	79-80	DODGE/PLYM Truck AD100, AW100
	95-99	DODGE/PLYM Neon

Muffler includes bracket.

P/N	YEAR	APPLICATION
700065	80-94	CHEV/GMC Van G Series
	82-88	CHEV/GMC P30/P3500 Series
700067	82-90	CHRY LeBaron, New Yorker (83-87), "E" Class (83-84) Town & Country (82-88)
	89-90	DODGE Spirit (exc. Turbo)
	82-88	DODGE 400 (82-83), 600, Aries, Aries America
	89-90	PLYM Acclaim (exc. Turbo)
	83-88	PLYM Caravelle (85-88), Reliant, Reliant America, Horizon (83-90)
700068	84-86	JEEP Truck CJ7, CJ8, Scrambler
	81-83	JEEP Truck CJ5, CJ7, CJ8, All Models, (1983), Calif. Models (81-82)
700069	85-90	CHEV/PONT Camaro/Firebird
	82-87	CHEV/PONT Camaro, Berlinetta (exc. Z28)/Firebird (exc. Trans AM)
700073#	83-86	FORD/MERC Thunderbird/Cougar
700074	83-86	FORD Truck Ranger
700075	84-87	JEEP Truck Wagoneer, Cherokee
	1986	JEEP Truck Commanche
	87-96	DODGE Dakota
700076#	84-86	FORD Van E150/250/350, Econoline
700079#	84-86	FORD Van E150/250/350
700081#	85-88	CHEV Nova
	84-87	TOYOTA Corolla (exc. Diesel)
700082	84-87	HONDA Civic Hatchback, CRX (85-87)
700085	91-95	VOLVO 940; 940 GLE (1991)
	85-92	VOLVO 740
	83-90	VOLVO 760, 780 (86-87)
700087	91-93	BUICK Roadmaster (Front Muffler)
	90-93	CAD Brougham, Fleetwood Brougham (Front Muffler)
	85-93	CHEV Caprice, Impala (Front Muffler)
	91-92	OLDS Custom Cruiser (Front Muffler)
	85-86	PONT Parisienne (Front Muffler)
700088#	90-92	CAD Brougham (Rear Muffler)
	85-89	CHEV Caprice, Impala Sedan (Rear Muffler)
	85-86	Pont. Parisienne Sedan (Rear Muffler)
700089#	1985	CHRY/CHRY Van LeBaron/Town & Country (exc. GTS & Turbo)
	85-86	DODGE/PLYM Aries, 600/Reliant
700090	83-88	CHEV Monte Carlo SS (Both Sides)
700093	85-92	VW Golf, Jetta (Rear)
700096#	86-93	FORD Mustang, GT, LX (Left Side)
	1986	MERC Capri (Left Side)

P/N	YEAR	APPLICATION
700097#	86-93	FORD Mustang, GT, LX (Right Side)
	1986	MERC Capri Dual Exh. (Right Side)
700098	86-95	FORD Taurus, Taurus SHO (86-95), Police Car (91-92), Linc. Continental (88-94), Single and Dual Exh. (Both Sides)
	86-95	MERC Sable Sedan, Sta. Wag.
	03-08	PONT Truck Vibe
700099#	87-96	FORD Truck F150, 250 (87-93)
	87-91	FORD Truck Bronco (exc. Chassis Cab)
	84-86	FORD Truck Bronco
700100	87-90	JEEP Truck Wrangler
700101#	89-90	CHRY LeBaron Coupe, Convertible (exc. Turbo)
	87-88	CHRY/CHRY Van LeBaron/Town & Country
	87-88	DODGE/PLYM Aries, Aries America/Reliant, Reliant America
700102#	1990	CHRY Van Town & Country
	87-90	DODGE/PLYM Van Caravan/Voyager, Grand Caravan/Grand Voyager
700103#	87-94	DODGE/PLYM Shadow, Shadow America/Sundance, Sundance America (exc. Turbo)
	1992	PLYM Duster
	90-93	CHEV/GMC Truck C1500/2500, K1500/2500
700104	1990	CHEV/GMC Truck C2500, K2500
	88-90	CHEV/GMC Truck Series C, K All Models
700105#	87-89	DODGE/PLYM Aries, Aries America/Reliant, Reliant America
700106#	90-93	CHRY New Yorker Landau, Salon, Fifth Avenue, Imperial
	88-89	CHRY New Yorker
	88-93	DODGE Dynasty
700108#	87-92	FORD Truck Ranger
700109	87-89	CHEV/GMC Truck Blazer/Jimmy
	87-88	CHEV/GMC Truck V10/1500, Suburban
	1987	CHEV/GMC Truck R20/2500
700110	88-91	HONDA Civic Hatchback, STD, Sedan, DX, LX, Sta. Wag., Wagovan, CRX HF, CRX DX
700111	88-91	HONDA Civic Si Hatchback, Sta. Wag., Wagovan
	88-91	HONDA CRX Si
700114	87-92	JEEP Truck Wrangler
700117#	90-91	FORD/MERC Crown Victoria/Grand Marquis Sedan, Sta. Wag. Dual Exh. (Left Side)
700118#	1992	BUICK Roadmaster Sedan
	90-92	CHEV Caprice (exc. Sta. Wag.)
700119#	90-95	CHRY LeBaron Coupe, Convertible
700120	1992	DODGE/PLYM Van B250/350
	89-91	DODGE/PLYM Van B150/250/350

Muffler includes bracket.

MUFFLER NUMERICAL LISTING



P/N	YEAR	APPLICATION
700121	90-91	CHEV/GMC Truck Blazer/Jimmy
	88-91	CHEV/GMC Truck V10/1500, V20/2500, Suburban
	88-90	CHEV/GMC Truck R10/1500, R20/2500
700123#	90-91	CHEV/GMC/OLDS/PONT Vans Lumina APV/Silhouette/Trans Sport
700124#	84-89	CHRY/DODGE LeBaron, LeBaron GTS, Lancer (85-89), Laser, Daytona (84-88), (exc. Turbo)
700125#	86-95	SUZUKI Truck Samurai
700126	1991	CHEV/GMC Vans G Series
	88-95	CHEV/GMC C/K Series
700127	91-95	DODGE/PLYM Vans Caravan/Voyager
700129#	91-94	NISSAN Sentra
700131#	89-94	HYUNDAI Sonata
700132	90-93	ACURA Integra
700133#	87-88	TOYOTA Corolla FX, FX16, FX16 GTS
700134#	87-94	DODGE/PLYM Truck Ram 50, Power Ram 50 Pickup (exc. 1993 Calif.), 2000CC (87-89), 2600CC (87-89)
	87-95	Mitsubishi Truck Pickup
700135#	90-91	LEXUS ES250
	89-91	TOYOTA Camry Sedan, Wagon (exc. AWD)
700137#	90-94	MAZDA Protégé
700139#	90-94	MAZDA 323
	92-93	MAZDA MX-3
700140#	90-91	HONDA Prelude Si
	88-89	HONDA Prelude w/ Fuel Injection
700141	87-96	CHEV/GMC Truck P30/3500
	87-89	CHEV/GMC Van G30/3500, R20/2500, R30/3500, V20/2500, V30/3500
700142	94-95	CHEV/GMC C1500/2500, K1500/2500
700143#	94-96	BUICK/OLDS Century/Cutlass Ciera, (exc. Sta. Wag.)
700144	92-95	CHEV/GMC Van Astro/Safari
700145#	1993	BUICK/OLDS Century, Cutlass Ciera, Sedan
700146	92-96	CHEV/GMC Van G Series
700147#	92-00	HONDA Civic EX, Coupe (93-00), Sedan (92-00)
	96-97	HONDA Civic, All Models exc. EX
700148#	1993	MERC/NISSAN Van Villager/Quest
700149	92-93	CHEV/GMC Truck C1500/2500, K1500/2500, Suburban
700150	95-99	CHEV/GMC Truck Blazer/Jimmy, 4-Dr.
	96-99	OLDS Bravada
700151#	93-97	FORD Probe
700152	95-04	TOYOTA Tacoma Pickup
	88-95	TOYOTA Truck Pickup, Cab & Chassis, 4-Runner
	93-97	TOYOTA T100 Pickup
700153	93-98	JEEP Truck Grand Cherokee, Grand Wagoneer, 2 & 4 WD

P/N	YEAR	APPLICATION
700154	94-95	CHEV/GMC Truck C1500/2500, K1500/2500, Suburban
700155#	93-97	MAZDA MX-6, 626
700156	92-94	DODGE/PLYM Truck B150/250
700157#	89-94	NISSAN Maxima GXE Sedan
	90-92	NISSAN Stanza
700158	94-95	CHEV/GMC Truck C1500/2500, K1500/2500
700159#	91-03	FORD/MERC Escort/Tracer
700160	91-02	SATURN Sedan, Coupe, Sta. Wag.
700161#	87-90	ACURA Legend
700162#	92-94	BUICK/OLDS/PONT Skylark/Achieva/Grand AM
	93-94	CHEV Beretta, Corsica, (exc. Beretta) GT/GTZ, Z26
700163	91-92	FORD Truck Ranger
700164	81-94	FORD Truck E250/350
	1997	FORD Truck F450, 7.3L
700165#	92-96	FORD/MERC Escort/Tracer
	90-94	MAZDA 323 Protégé
700166	1992	CHEV/GMC Van Astro/Safari
700167#	93-97	NISSAN Altima
700168#	93-97	FORD Probe GT
700169#	92-00	HONDA Civic Hatchback
700170	1994	HONDA Truck Passport
	91-97	ISUZU Truck Rodeo, Pickup (91-95)
700171#	94-96	BUICK/CAD/CHEV Roadmaster/ Fleetwood Brougham RWD/Caprice, Dual Exh. (Right Front Muffler)
700172#	94-96	BUICK/CAD/CHEV Roadmaster/ Fleetwood Brougham RWD/Caprice, Dual Exh. (Left Front Muffler)
700173	94-95	CHEV/GMC Truck Tahoe/Yukon
700174#	89-94	NISSAN Maxima, Sedan, SE Sedan, (Dual Outlet)
700175	92-93	CHEV/GMC Truck Blazer/Yukon
700176	92-94	CHEV/GMC Truck S10/S15 Pickup
700177	91-95	VOLVO 940, 940 GLE (91) (exc. Turbo) (Rear Muffler)
	88-92	VOLVO 740, (exc. Turbo) 760, 780 (88-91) (Rear Muffler)
700178	92-94	CHEV/GMC Truck Blazer/Jimmy S10/S15, T10/T15, 2 WD/4 WD
	92-94	OLDS Truck Bravada 4 WD
700179#	98-01	CHEV Metro
	95-97	GEO Metro
700179# (Cont.)	95-01	PONT Firefly (Canada)
	95-96	SUZUKI Swift
700180#	92-94	BUICK/OLDS/PONT Skylark/Achieva/Grand Am, Quad OHC
700181#	94-97	HONDA Accord DX, LX
700182	95-03	CHEV/GMC S10/S15 Pickup
	96-00	ISUZU Hombre

Muffler includes bracket.

MUFFLER NUMERICAL LISTING

P/N	YEAR	APPLICATION
700183#	93-02	VW Cabriolet (95-02), Golf (93-97), Jetta (93-99) (Rear)
700184	1995	CHEV/GMC Van G Series
700185	95-05	BUICK/CHEV/OLDS/PONT Skylark, Achieva, Grand Am (95-98); Beretta/Corsica (95-96), Cavalier/Sunfire (95-05)
	95-99	CAD Deville, Eldorado, Dual Exh. (Both Sides)
	95-97	CAD Seville, Dual Exh. (Both Sides)
700186#	95-98	MAZDA 323 Protégé
700187	95-99	CHEV/GMC Truck Blazer/Jimmy S10/S15, T10/T15, 2-Dr.
700188#	97-99	ACURA CL
	94-97	HONDA Accord Ex, LX, 2-Dr. Coupe, 4-Dr. Sedan
700189#	88-93	CHEV/OLDS Lumina (90-93), Cutlass Ciera (88-89), Sport Exh.
700190	93-96	JEEP Truck Wrangler
700191#	95-99	DODGE/PLYM Neon
700192#	90-92	OLDS/PONT Cutlass Supreme/Grand Prix, (Right Side)
700193#	90-92	OLDS/PONT Cutlass Supreme/Grand Prix, (Left Side)
700194#	92-96	FORD Truck E150/E250
700195	94-97	DODGE/PLYM Truck B150/B250
700196	91-93	BUICK/CHEV/OLDS Sta. Wag. Roadmaster/Caprice/Custom Cruiser (91-92)
	85-86	CHEV/PONT Caprice, Impala Parisienne, Sta. Wag.
700197	92-93	BUICK/OLDS/PONT LeSabre/88/Bonneville SE
700198#	92-94	OLDS/PONT Achieva/Grand Am,(Left Side)
700199#	92-94	OLDS/PONT Achieva/Grand Am,(Right Side)
700200#	89-95	FORD/MERC Thunderbird, Cougar, Single Exh. & Dual Exh. (Left Side)
700201	94-95	CHEV/GMC Truck C1500/2500,K1500/2500, Suburban, 2 Or 4 WD, w/ 3" Inlet
700202	87-88	CHEV/GMC Truck V10/V1500, V20/V2500, Suburban, 4 WD, w/ 3" Inlet
700203	87-88	CHEV/GMC Truck R10/1500, R20/2500, Suburban, 2 WD, w/ 3" Inlet
700204	87-90	CHEV/GMC Van G Series, w/ 3" Inlet
700205	88-91	CHEV/GMC Truck V10/1500, V20/2500, Suburban, 4 WD, w/ 3" Inlet
	88-90	CHEV/GMC Truck R10/1500, R20/2500, Suburban, 2 WD, w/ 3" Inlet
700206	92-98	JEEP Truck Grand Cherokee, 2 & 4 WD
	93-95	JEEP Truck Cherokee, 2 & 4 WD

P/N	YEAR	APPLICATION
700207	91-95	CHRY Truck Town & Country
	91-95	DODGE/PLYM Truck Grand Caravan, Grand Caravan C/V, Grand Voyager
700208#	92-94	DODGE Shadow
	92-94	PLYM Duster, Sundance
700211#	93-97	GEO Prizm, Prizm LSI
	93-97	TOYOTA Corolla
700212#	93-97	MAZDA 626
700213#	93-97	MAZDA MX-6, Dual Outlet
700214#	93-94	CHEV Lumina, Dual Exh. (Left)
	93-96	PONT Grand Prix, Dual Exh. (Left)
700215#	1993	OLDS Cutlass Supreme, Dual Exh. (Right)
	93-96	PONT Grand Prix, Dual Exh. (Right)
700216#	1993	OLDS Cutlass Supreme, Dual Exh. (Left)
	93-96	PONT Grand Prix, Dual Exh. (Left)
700217#	93-95	HONDA Civic Del Sol S
700218	93-02	CHEV Camaro
	93-02	PONT Firebird
700219	93-02	CHEV Camaro
	93-02	PONT Firebird
700220	89-93	MAZDA Truck B2600 pickup
700221	1992	CAD Eldorado, Seville
700222	90-95	CHEV/GMC Truck C3500
	90-95	CHEV/GMC Truck K3500
700223#	95-98	ACURA TL
	92-94	ACURA Vigor
700224#	94-97	FORD Aspire
700225#	94-97	MERC Truck Villager
	94-97	NISSAN Truck Quest
700226	94-97	DODGE/PLYM Truck R1500, R2500
700227	94-96	DODGE/PLYM Truck Dakota
700228#	1994	CAD Deville
700229#	93-94	CAD Eldorado, Seville, Dual Exh. (Right)
700230#	93-94	CAD Eldorado, Seville, Dual Exh. (Left)
700231#	94-96	BUICK Roadmaster Sedan, Sgl. Exh. (Rear); Dual Exh. (Right Rear)
	94-96	CHEV Caprice, Sedan, Sgl. Exh. (Rear); Dual Exh. (Right Rear)
700232#	94-96	BUICK Roadmaster Sedan, Dual Exh. (Left Rear)
	94-96	CHEV Caprice, Dual Exh. (Left Rear)
700233#	91-96	INFINITI G20
700234	02-05	BUICK Rendezvous
	94-99	BUICK LeSabre
	02-07	JEEP Truck Liberty
	94-99	OLDS 88
	01-05	PONT Aztek
	94-99	PONT Bonneville

Muffler includes bracket.

MUFFLER NUMERICAL LISTING



P/N	YEAR	APPLICATION
700235#	94-96	BUICK Regal
	1994	CHEV Lumina
	94-97	OLDS Cutlass Supreme
	94-96	PONT Grand Prix
700236#	86-87	LINC Continental, Dual Exh. (Right)
	86-92	LINC Mark VII, Dual Exh. (Right)
700237#	86-87	LINC Continental, Dual Exh. (Left)
	86-92	LINC Mark VII, Dual Exh. (Left)
700238#	95-00	FORD Contour 4 Cyl. (Rear)
	95-00	MERC Mystique 4 Cyl. (Rear)
700239#	95-00	FORD Contour 6 Cyl. (Rear)
	95-00	MERC Mystique 6 Cyl. (Rear)
700240#	95-00	NISSAN Maxima
	96-99	INFINITI I30
700241#	95-98	NISSAN 200SX
	95-99	NISSAN Sentra
700242#	1998	CHEV Truck Tracker, 2-Dr. Models
	94-97	GEO Truck Tracker, 2-Dr. & Convertibles
	94-98	SUZUKI Truck Sidekick; Convertible
700243#	1998	CHEV Truck Tracker, 4-Dr. Models
	96-97	GEO Truck Tracker, 4-Dr. Hardtop
	93-98	SUZUKI Truck Sidekick; 4-Dr. Hardtop
700244#	96-98	PONT Grand Am GT, Dual Exh. (Right)
	1995	PONT Grand Am, Dual Exh. (Right)
700245	96-98	PONT Grand Am GT, Dual Exh. (Left)
	1995	PONT Grand Am, Dual Exh. (Left)
700246#	95-01	CHEV Lumina
	95-99	CHEV Monte Carlo
700247#	95-03	FORD Truck Windstar
	04-07	FORD/MERC Truck Freestar, Monterey
700248#	94-97	HONDA Truck Passport
	93-97	ISUZU Truck Rodeo
700249#	92-95	ISUZU Truck Trooper
700250#	96-97	CHRY Cirrus
	95-97	DODGE/PLYM Stratus, Breeze
700252	95-12	TOYOTA Truck Tacoma Pickup
	95-98	TOYOTA Truck T100 Pickup
	00-06	TOYOTA Truck Tundra Pickup
700253#	90-94	SUBARU Legacy Sta. Wag., exc. Turbo (Through 02/94)
700254	96-05	CHEV/GMC Truck Astro/Safari Van
700255#	96-99	FORD/MERC Taurus, Sable, Dual Exh. (Right)
700256#	96-99	FORD/MERC Taurus, Sable, Sgl. Exh., Dual Exh. (Left)
700257	96-07	CHRY Truck Town & Country
	96-07	DODGE/PLYM Truck Caravan, Voyager
	96-05	DODGE/PLYM Truck Grand Caravan, Grand Voyager

P/N	YEAR	APPLICATION
700258	99-00	CAD Escalade
	96-99	CHEV/GMC Truck C1500, C2500
	99-00	CHEV/GMC Truck Denali
	96-99	CHEV/GMC Truck K1500, K2500
	96-00	CHEV/GMC Truck Tahoe/Yukon
700259	97-99	DODGE/PLYM Truck Dakota
700260	96-00	CHEV/GMC Truck C1500, C2500; Suburban
	96-00	CHEV/GMC Truck K1500, K2500; Suburban
	96-00	CHEV/GMC Truck Tahoe/Yukon
700261#	95-99	CHEV Lumina, Monte Carlo, Dual Exh. (Right)
700262#	95-99	CHEV Lumina, Monte Carlo, Dual Exh. (Left)
700263	97-00	JEEP Truck Wrangler
700264	76-78	DODGE/PLYM Truck B100, BF100, B200, BF200, B300, BF300, CB300, MB300/MB400, PB100, PB200, PB300
	84-91	JEEP Truck Grand Wagoneer
	80-82	JEEP Truck Series 10, Wagoneer, Cherokee
	1983	JEEP Truck Wagoneer, Cherokee
700265#	85-90	CHEV Corvette, exc. ZR1, Dual Exh. (Left)
700266#	85-90	CHEV Corvette, exc. ZR1, Dual Exh. (Right)
700270#	88-97	FORD Truck F250, F350 Series
700271	1992	DODGE/PLYM Truck AD150, AW150, Ramcharger
	90-91	DODGE/PLYM Truck AD100, AD150, AW100, AW150, Ramcharger
	90-91	DODGE/PLYM Truck D150, D250
	90-92	DODGE/PLYM Truck D250
	90-91	DODGE/PLYM Truck D350
	1989	DODGE/PLYM Truck W100, W150
	90-92	DODGE/PLYM Truck W150
	90-92	DODGE/PLYM Truck W250
	90-91	DODGE/PLYM Truck W350
700272#	90-93	FORD Mustang
700273	90-93	GEO Storm (Front)
	90-92	ISUZU Impulse Hatchback (Front)
	91-93	ISUZU Stylus (Front)
700274#	94-96	FORD Truck E250, E350 Series; Econoline, exc. Cutaway Van
	88-93	FORD Truck E250, E350 Series; Econoline, exc. Cutaway Van; exc. 1993 7.5L w/ Round Muffler
700275#	92-95	TOYOTA Paseo
	91-94	TOYOTA Tercel
700276	95-97	CHEV Camaro
	91-92	CHEV Camaro
	96-97	PONT Firebird
	91-92	PONT Firebird

Muffler includes bracket.

P/N	YEAR	APPLICATION
700277	1991	DODGE/PLYM Truck Dakota
700278#	90-92	BUICK Regal
700279#	90-95	NISSAN Truck Pathfinder
700280#	91-97	HONDA Accord LX; Sta. Wag.
700281	90-94	VW Passat Sedan, Sta. Wag. (Rear)
700282	91-93	BUICK Park Avenue, exc. 92-93 Supercharged Eng.
	92-93	OLDS 98, exc. Supercharged Eng.
700283	1992	FORD Truck Ranger
	91-92	FORD Truck Ranger, Super Cab
700284#	90-94	SUBARU Legacy 4-Dr. Sedan;exc. Turbo (Through 02/94)
700285#	91-94	CHEV Lumina, Dual Exh. (Right)
	91-96	PONT Grand Prix, Dual Exh. (Right)
700286#	92-95	CHEV/GMC Truck Lumina APV
	92-95	OLDS/PONT Truck Silhouette, Trans Sport
700287#	92-95	MAZDA MX-3
700288	91-95	ISUZU Truck Pickup
700289#	92-96	HONDA Prelude, All Models
700290	89-91	CAD DeVille, Fleetwood
700291#	97-00	FORD Truck Explorer 4-door
	98-00	MERCURY Truck Mountaineer
700292	00-04	CHEV/GMC Truck Blazer, Jimmy, Envoy (S Series)
	00-01	OLDSMOBILE Truck Bravada
700293	05-09	Buick Lacrosse (Front)
	97-04	BUICK Regal (Front)
	05-07	BUICK Allure (Front)
	00-05	CHEV Impala (Front)
	00-05	CHEV Monte Carlo (Front)
	97-08	PONT Grand Prix (Front)
700294#	95-02	KIA Truck Sportage
700295	98-02	DODGE/PLYM Truck Series R1500
700296#	97-03	CHEV Malibu
	04-05	CHEV Classic
	97-99	OLDSMOBILE Cutlass
700297	97-04	FORD Truck F150 Series
	97-99	FORD Truck F250 Series
700298#	05-08	BUICK Lacrosse, Dual Exh. (Right)
	05-07	BUICK Allure, Dual Exh. (Right)
700298# (Cont.)	00-05	CHEV Monte Carlo, Dual Exh. (Right)
	97-08	PONT Grand Prix, Dual Exh. (Right)
700299#	97-00	FORD Truck Explorer 2-door
700300#	05-08	BUICK Lacrosse, Dual Exh. (Left)
	05-07	BUICK Allure, Dual Exh. (Left)
	00-05	CHEV Monte Carlo, Dual Exh. (Left)
	97-08	PONT Grand Prix, Dual Exh. (Left)
700301	98-03	DODGE/PLYM Truck Series B150 Vans, Wagons
700302#	95-00	FORD Contour (Front)
	95-00	MERCURY Mystique (Front)

P/N	YEAR	APPLICATION
700303	02-05	CAD Truck Escalade
	99-06	CHEV/GMC Truck C1500/K1500 Silverado/Sierra, Avalanche, Suburban, Tahoe, Yukon
	99-00	CHEV/GMC Truck C2500/K2500 Silverado/Sierra
700304	97-03	FORD Truck E Series, Econoline
700305	96-99	CHEV/GMC Truck C1500/K1500, C2500/K2500 Pickup
700306#	98-02	CHRY Concorde (Rear)
	98-04	DODGE Intrepid (Rear)
700307#	96-98	FORD Truck Explorer 5.0L, 4-door
	97-98	MERCURY Truck Mountaineer
700308#	98-02	CHEV Prizm
	98-02	TOYOTA Corolla
700309	88-92	VOLVO 700 Series (Rear)
	91-95	VOLVO 900 Series (Rear)
700310#	94-98	FORD Mustang 6 Cyl.
700311#	98-03	DODGE/PLYM Truck Durango
700312	95-98	FORD Truck Windstar (Rear)
700314#	98-02	FORD/LINC/MERC Full-Size Models, Sgl. Exh., Dual Exh. (Right)
700315#	98-02	FORD/LINC/MERC Full-Size Models, Dual Exh. (Left)
700316	94-96	BUICK/CHEV Roadmaster/Caprice Sta. Wgn. (Right Rear)
700317#	94-96	CAD Fleetwood Brougham 5.7L, Dual Exh. (Both Rear)
700318#	94-96	BUICK/CHEV Roadmaster/Caprice Sta. Wgn. (Left Rear)
700319	00-05	BUICK/PONT LeSabre, Bonneville; Park Avenue (04-05); (Front)
700320	90-97	MAZDA MX-5 Miata
700321#	93-95	GM Truck Lumina APV, Silhouette, Trans Sport 3.1L
700322#	88-93	DODGE Truck D250/350, W250/350, Turbo Diesel Eng.
700323#	1996	GM Truck Lumina APV, Silhouette, Trans Sport
700324#	96-97	TOYOTA Truck RAV-4
700325#	98-00	TOYOTA Truck RAV-4
700327	98-04	CHRY/DODGE 300M, Concorde, Intrepid, LHS, 3.2L & 3.5L (Front)
700328	98-04	CHRY/DODGE Concorde, Intrepid 2.7L (Front)
700329	00-06	JEEP Truck Wrangler
700330#	94-04	FORD Mustang GT, Mach 1 (03-04) Dual Exh. Left; 6 Cyl. (99-04)
700331#	94-04	FORD Mustang GT, Mach 1 (03-04) Dual Exh. Right
700332	97-99	DODGE Truck Dakota 4 Cyl.
700333#	97-08	BUICK/CHEV/PONT Century 3.1L; Monte Carlo 3.4L (00-05); Grand Prix (97-08)
700334#	95-96	BUICK Regal 3.8L
700335	02-05	FORD/MERC Truck Explorer, Mountaineer

Muffler includes bracket.

MUFFLER NUMERICAL LISTING



P/N	YEAR	APPLICATION
700336#	93-95	CHEV/GMC Truck C/K1500, C/K2500, C/K3500 Turbo Diesel
700337	96-07	CHRY/DODGE/PLYM Truck Caravan/Voyager, Grand Caravan, Grand Voyager 4 Cyl.
700338#	97-04	BUICK Regal
700339	97-01	GM Truck Venture, Silhouette (97-01); Montana (99-01); Trans Sport (97-98); Extended Wheelbase
700340#	95-99	HONDA/ISUZU Truck Odyssey (95-98); Oasis (96-99); (Front)
700341	97-01	GM Truck Venture, Silhouette (97-99); Montana (99-01); Trans Sport (97-98); Standard Wheelbase
700342#	00-05	CHEV Impala
700343	01-05	CHRY/DODGE Truck Town & Country, Grand Caravan 3.8L
700344	97-98 1998	FORD Truck Expedition LINCOLN Truck Navigator
700345	02-09 03-08	GM Truck Rainier (04-07); Trailblazer/Envoy (02-09); Bravada (02-04); (Rear) ISUZU Truck Ascender
700346	99-02	FORD/LINC Truck Expedition, Navigator
700347	90-95	CHEV/GMC Truck C/K3500, 7.4L, Chassis Cab
700348#	98-02 98-02	MERC Truck Villager (Rear) NISSAN Truck Quest (Rear)
700350	00-05	CHEV/GMC Truck Blazer/Jimmy S/T, 2-door
700351#	94-01	ACURA Integra RS, LS, GS 3-door
700352#	94-01	ACURA Integra RS, LS, GS 4-door
700353#	96-97 95-98	TOYOTA Paseo TOYOTA Tercel
700354#	91-96	TOYOTA Truck Previa, All Trac (94-96)
700355#	93-96 1993	OLDS Cutlass Supreme, Dual Exh. (Left) PONT Grand Prix, Dual Exh. (Left)
700356#	1996	FORD Truck F150 5.0L, including Supercab
700357	95-05	BUICK/OLDS Aurora/Riviera (95-99); Park Avenue (97-05); Dual Exh. (Both)
700359	83-90	CHEV/PONT Camaro/Firebird Z-28, IROC-Z, Trans Am
700360	90-93	BUICK/CAD/OLDS Riviera (91-93); Eldorado/Seville (90-92); Toronado (91-92)
700361#	82-91	CHEV/GMC Truck C/K, R/V, Suburban, Diesel Eng.
700362	99-01	JEEP Truck Grand Cherokee 6 Cyl.
700363	91-94	CHEV Cavalier Z-24, V6
700364	99-01	JEEP Truck Grand Cherokee 8 Cyl.
700365	96-00	CHEV/GMC Truck C/K2500, C/K3500, 155" WB, Old Body Style
700366	01-06	FORD/MERC Truck Explorer, Mountaineer (06-08); Sport Trac (01-05)
700367#	99-04	FORD Truck F250, F350, Super Duty

P/N	YEAR	APPLICATION
700368#	98-02	HONDA Accord Coupe & Sedan V6 Dual Exh. (Right)
700369#	00-05	DODGE/PLYM Neon
700370#	00-03	DODGE Truck Durango 8 Cyl.
700371	97-01	BUICK Park Avenue (Rear)
700373	00-05	BUICK/PONT LeSabre, Bonneville (Rear)
700374	00-05 98-03 06-11 95-02	CAD Deville, Dual Exh. (Both Sides) CAD Seville, Dual Exh. (Both Sides) CAD DTS, Dual Exh. (Both Sides) LINCOLN Continental, Dual Exh. (Both Sides)
700375	92-93	CAD Deville; Fleetwood (1992)
700376	96-09 98-99	GM/SATURN Truck Equinox (05-09); Torrent (06-09); Vue (02-07); S10/S15 V6 (96-04) ISUZU Truck Hombre 2WD
700377#	96-00	CHRY Sebring Convertible
700378	98-04	CHRY/DODGE 300M, Concorde, Intrepid, LHS, 3.2L & 3.5L (Center)
700379	98-04	CHRY/DODGE Concorde, Intrepid 2.7L (Center)
700380	96-99	PONT Bonneville SSE
700381	96-97	CHEV/GMC Truck S10/S15 V6 4WD; 2WD Auto. Trans. (1996)
700382#	98-06	CHRY/DODGE/PLYM Cirrus, Breeze (98-00); Sebring sedan (01-06); Stratus sedan (98-06)
700384#	98-04	CHRY/DODGE Concorde, Intrepid 2.7L (Rear)
700385#	99-04	CHRY 300M, Concorde, LHS 3.5L (Rear)
700386#	99-04 00-02	NISSAN Truck Frontier NISSAN Truck Xterra
700387#	97-01	HONDA Truck CR-V
700388#	00-07	FORD/Merc Taurus, Sable
700389#	03-12	TOYOTA Corolla 4-door sedan
700390#	95-00 94-98	CHRY/DODGE Avenger, Sebring LX/Lxi Coupe MITSUBISHI Galant
700391#	97-03	TOYOTA Camry 4 Cyl. (97-01); Solara 4 Cyl. (02-03)
700392#	98-02	HONDA Accord DX, LX, EX, SE
700393#	97-98 97-01	LEXUS ES300 TOYOTA Camry sedan V6
700394#	96-02	TOYOTA Truck 4-Runner 6 Cyl., exc. Calif.
700395#	96-00	TOYOTA Truck 4-Runner 4 Cyl.
700396#	01-10	CHRY PT Cruiser, exc. Turbo
700397#	93-00	VOLVO 850, exc. Turbo (93-97); C70/S70/V70 exc. Turbo (98-00)
700398#	95-97	CHRY/DODGE Cirrus, Stratus 6 Cyl.
700399#	98-03	TOYOTA Truck Sienna Van, exc. Calif.
700400#	94-95	HONDA Accord EX Sta. Wgn.
700401#	99-03	CHEV/SUZUKI Truck Tracker/Vitara 2-door

Muffler includes bracket.

P/N	YEAR	APPLICATION
700402#	84-93	VW Cabriolet; Scirocco 8V (84-87)
700403#	98-00	NISSAN Truck Frontier 4 Cyl.
700404#	95-99	DODGE/PLYM Neon, DOHC
700406#	98-01	NISSAN Altima
700407#	00-03	DODGE Truck Dakota 112" WB, 131" WB Club Cab
700408#	3/94-99	SUBARU Legacy 4-door sedan, 2.2L
700409#	98-04	KIA Sephia (98-01); Spectra (00-04)
700410#	91-93	HONDA Accord EX Sta. Wgn.
700411#	98-02	HONDA Accord Coupe & Sedan V6 Dual Exh. (Left)
700413#	94-99 96-99	SUBARU Legacy 2.2L Sta. Wgn. SUBARU Legacy Outback
700414	02-04	JEEP Truck Grand Cherokee 6 Cyl.
700415#	99-03	MAZDA Protégé, exc. Mazdaspeed
700416#	98-2/02	SUBARU Forester
700417#	4/99-03	NISSAN Maxima, exc. Calif.
700418#	98-02	MAZDA 626, 2.0L
700419#	97-99	ACURA CL 6 Cyl.
700420#	04-12 06-08	CHEV/GMC Truck Colorado, Canyon ISUZU Truck I280/I350 Pickup
700422#	04-11 04-09	FORD Truck Ranger, exc. Calif. MAZDA Pickup
700423#	02-06	NISSAN Altima 4 Cyl.
700424#	00-06	NISSAN Sentra 1.8L
700425#	00-01	INFINITI I30, exc. Calif.
700426#	98-04	HONDA/ISUZU Truck Passport (98-02); Rodeo exc. Sport (98-04)
700427	04-07 2008	CHEV Malibu sedan & Maxx CHEV Malibu Classic
700428	01-04	FORD/MAZDA Truck Escape, Tribute
700429	02-09 03-08	GM Truck Rainier (04-07); Trailblazer/Envoy (02-09); Bravada (02-04); (Front) ISUZU Truck Ascender
700430#	4/98-01	FORD/MERC Truck Explorer 4-door, Mountaineer 8 Cyl.
700431#	02-06 02-08	LEXUS ES300 (02-03); ES330 (04-06) TOYOTA Camry (02-06); Solara (04-08)
700432#	95-96	LEXUS/TOYOTA ES300, Camry V6
700433#	88-97	FORD Truck F250 (1992); F350 (88-97); F450 (88-93)
700434	88-96	FORD Truck E350, 158" & 176" WB
700436#	93-95	FORD Truck F350, F450, 7.5L
700437#	01-05	HONDA Civic DX, EX, GX, HX, LX Sedan & Coupe
700438#	00-02	GM Truck G10/G1500, G20/G2500 Express, Savana
700439#	96-99 96-00	GM Truck G10/G1500, G20/G2500 Express, Savana GM Truck G30/G3500 Express, Savana
700440#	97-03	FORD Truck E150, E250, E350, 5.4L
700441#	96-00	GM Truck G10/G1500, G20/G2500 Express, Savana

P/N	YEAR	APPLICATION
700442#	02-05	DODGE Truck R1500 Ram Pickup
700443#	99-04 99-05	OLDS Alero PONT Grand Am, exc. GT w/ Dual Exh.
700444#	91-96	OLDS/PONT Cutlass Supreme; Grand Prix (91-93); Dual Exh. (Right)
700445#	99-03 01-04 99-05	CHEV/SUZUKI Truck Tracker/Vitara 4 Cyl., 4-door CHEV Truck Tracker 6 Cyl., 4-door SUZUKI Truck Grand Vitara 6 Cyl.
700446	97-05 95-99	BUICK Park Avenue (Front) BUICK/OLDS Riviera, Aurora (Front)
700447#	92-94 92-94	LEXUS ES300 TOYOTA Camry V6
700448#	92-93 94-96	TOYOTA Camry 2.2L, exc. Calif. TOYOTA Camry 2.2L
700449	06-11 06-07	CHEV Impala 6 Cyl., 3.5L (Front) CHEV Monte Carlo 6 Cyl., 3.5L (Front)
700450#	06-11 06-07	CHEV Impala 6 Cyl., 3.5L (Rear) CHEV Monte Carlo 6 Cyl., 3.5L (Rear)
700451#	06-11 06-09	CHEV Impala 6 Cyl., 3.9L (Right) CHEV Impala SS 8 Cyl., 5.3L (Right)
700452#	06-11 06-09	CHEV Impala 6 Cyl., 3.9L (Left) CHEV Impala SS 8 Cyl., 5.3L (Left)
700453#	00-01 00-03	FORD Explorer 4-door, SOHC (Code "E") 4.0L (From 12/99) FORD Explorer Sport 2-door, SOHC (Code "E") 4.0L (From 12/99)
700454#	03-04	NISSAN Xterra 6 Cyl., 3.3L
700455#	00-03 00-03	DODGE Dakota Quad Cab 2 & 4 WD, 131" WB, 6 Cyl., 3.9L DODGE Dakota Quad Cab 2 & 4 WD, 131" WB, 8 Cyl., 4.7 & 5.9L
700456#	04-08 04-08 04-08 04-08 06-08	FORD F150 6 Cyl., 126", 133"WB, 4.2L, exc. Heritage Series (Old Body Style) FORD F150 6 Cyl., 139", 145", 150", 163" WB, 4.2L, exc. Heritage Series (Old Body Style) FORD F150 8 Cyl., 126", 133"WB, 4.6 & 5.4L, exc. Heritage Series (Old Body Style) FORD F150 8 Cyl., 139", 145", 150", 163" WB, 4.6 & 5.4L, exc. Heritage Series (Old Body Style) LINCOLN Mark LT 139", 150" WB, 8 Cyl., 5.4L
700457#	04-06	NISSAN Titan Pickup King & Crew Cab (XE, SE, LE) 2 & 4 WD, 8 Cyl., 5.6L, exc. Calif.
700458	05-08 05-08 05-06 2008 05-06	FORD Escape 4 Cyl., 2.3L FORD Escape 6 Cyl., 3.0L MAZDA Tribute 4 Cyl., 2.3L MAZDA Tribute 4 Cyl., 2.3L MAZDA Tribute 6 Cyl., 3.0L

Muffler includes bracket.

MUFFLER NUMERICAL LISTING



P/N	YEAR	APPLICATION
700458 (Cont.)	2008	MAZDA Tribute 6 Cyl., 3.0L
	05-08	MERCURY Mariner 4 Cyl., 2.3L
	05-08	MERCURY Mariner 6 Cyl., 3.0L
700459	02-04	JEEP Grand Cherokee 2 & 4 WD, 8 Cyl., 4.7L
700460	2004	DODGE Dakota Dakota Club & Quad Cab 2 & 4 WD, 112", 131" WB, 6 Cyl., 3.7L
	2004	DODGE Dakota Dakota Club & Quad Cab 2 & 4 WD, 112", 131" WB, 8 Cyl., 4.7L
700461#	00-05	SATURN L Series (Front)
700462#	04-05	DODGE R1500 2 & 4 WD, 120", 140", 160" WB, 8 Cyl., 5.7L Hemi
700463#	2003	DODGE R1500 2 & 4 WD, 120", 140", 160" WB, 8 Cyl., 5.7L Hemi
700464#	03-07	SATURN ION 4 Cyl., 2.2L
700465#	05-10	CHEV Cobalt 4 Cyl., 2.2L
	05-06	PONTIAC G5 Pursuit 4 Cyl., 2.2L (Canada only)
	07-10	PONTIAC G5 4 Cyl., 2.2L
700466	05-10	JEEP Grand Cherokee 6 Cyl., 3.7L
	05-10	JEEP Grand Cherokee 8 Cyl., 4.7 & 5.7L
	06-10	JEEP Commander 6 Cyl., 3.7L
	06-07	JEEP Commander 8 Cyl., 4.7 & 5.7L
700467#	03-04	NISSAN Frontier Crew-Cab 2 & 4 WD, 131.1" WB. Long Bed, 6 Cyl., 3.3L
700468	02-06	CADILLAC Escalade 8 Cyl., 6.0L exc. ESV or EXT Models or Models w/ 20" Wheels
	01-06	GMC Tahoe/Yukon Denali 8 Cyl., 6.0L exc. XL Models
700469	05-07	BUICK Terraza
	05-08	CHEV Uplander
	02-05	CHEV Venture
	02-04	OLDS Silhouette
	02-08	PONT Montana
	05-07	SATURN Relay
700470	05-07	BUICK Allure 6 Cyl., 3.8L
	05-09	BUICK Lacrosse 6 Cyl., 3.8L
700471	04-06	CHRYSLER Pacifica 6 Cyl., 3.5L
700472#	04-06	CHRYSLER Pacifica 6 Cyl., 3.5L
700473	08-12	BUICK Enclave 6 Cyl., 3.6L
	07-12	CHEVROLET GMC Acadia 6 Cyl., 3.6L
	09-16	CHEVROLET Traverse 6 Cyl., 3.6L
700474#	2007	CHRYSLER Aspen 8 Cyl., 4.7L, 5.7L
	04-09	DODGE Durango 6 Cyl., 3.7L, 8 Cyl., 4.7, 5.7L
700475#	06-08	DODGE R1500 Series Pickup 6 Cyl., 3.7L, 8 Cyl., 4.7L
700476#	05-09	DODGE R2500/2500 HD/3500 Series Pickup 6 Cyl., 5.9L

P/N	YEAR	APPLICATION
700477#	06-08	DODGE R1500 Series Pickup 8 Cyl., 5.7L
700478#	03-09	DODGE R2500/2500 HD/3500 Series Pickup 8 Cyl., 5.7L
700479	07-11	DODGE Nitro 6 Cyl., 3.7L
	08-12	JEEP Liberty 6 Cyl., 3.7L
700480	05-10	DODGE Dakota 6 Cyl., 3.7L, 8 Cyl., 4.7L
	06-09	MINI Cooper S 4 Cyl., 4.7L
	2011	RAM Dakota 6 Cyl., 3.7L, 8 Cyl., 4.7L
700481#	05-07	FORD F250 Series Pickup 10 Cyl., 6.8L, 8 Cyl., 5.4L
	05-07	FORD F350 Series Pickup 10 Cyl., 6.8L, 8 Cyl., 5.4L
700482	04-15	FORD E Series Econoline Vans 8 Cyl., 5.4L
	00-05	FORD Excursion 10 Cyl., 6.8L, 8 Cyl., 5.4L
700483#	99-03	FORD F250 Series Pickup 8 Cyl., 7.3L
	99-03	FORD F350 Series Pickup 8 Cyl., 7.3L
700484	08-12	CHEVROLET Malibu, Classic 4 Cyl., 2.4L
	08-10	PONTIAC G6 4 Cyl., 2.4L
700485#	05-07	BUICK Allure 6 Cyl., 3.8L
	05-09	BUICK Lacrosse 6 Cyl., 3.8L
700486	08-12	CHEVROLET Malibu 6 Cyl., 3.6L
	08-10	PONTIAC G6 6 Cyl., 3.5L, 6 Cyl., 3.6L
700487#	06-11	CHEVROLET HHR 4 Cyl., 2.2L
700488#	99-07	CHEVROLET Silverado / GMC Sierra 2500 Series 2wd Pickup 8 Cyl., 6.0L, 8 Cyl., 6.0L, 8.1L, 8 Cyl., 8.1, 6.0L
	99-07	CHEVROLET Silverado / GMC Sierra 2500 Series 4wd Pickup 8 Cyl., 6.0L, 8 Cyl., 6.0L, 8.1L, 8 Cyl., 8.1, 6.0L
	04-07	CHEVROLET Silverado / GMC Sierra 3500 Series 2wd Pickup 8 Cyl., 8.1, 6.0, 8.1, 6.0, 8 Cyl., 8.1, 6.0L
	2007	CHEVROLET Silverado / GMC Sierra 3500 Series 4wd Pickup 8 Cyl., 8.1, 6.0L
700489	07-13	CHEVROLET Silverado / GMC Sierra 1500 Series 2wd Pickup 6 Cyl., 4.3L, 8 Cyl., 4.8L, 8 Cyl., 5.3L
	07-13	CHEVROLET Silverado / GMC Sierra 1500 Series 4wd Pickup 8 Cyl., 4.8L, 8 Cyl., 5.3L, 6 Cyl., 4.3L
700490	99-04	HONDA Odyssey 6 Cyl., 3.5L
700491#	07-15	NISSAN Titan 8 Cyl., 5.6L
709001		Universal MSL/Maximum Muffler
709003	1989	EAGLE/RENAULT Medallion
709004		Universal MSL/Maximum Muffler
709005		Universal MSL/Maximum Muffler
709006		Universal MSL/Maximum Muffler
709007		Universal MSL/Maximum Muffler
709008		Universal MSL/Maximum Muffler
709009		Universal MSL/Maximum Muffler
709010		Universal MSL/Maximum Muffler
709011		Universal MSL/Maximum Muffler
709012		Universal MSL/Maximum Muffler

Muffler includes bracket.

P/N	YEAR	APPLICATION
709013		Universal MSL/Maximum Muffler
709014		Universal MSL/Maximum Muffler
709015		Universal MSL/Maximum Muffler
709016		Universal MSL/Maximum Muffler
709017		Universal MSL/Maximum Muffler
709018		Universal MSL/Maximum Muffler
709019		Universal MSL/Maximum Muffler
709020		Universal MSL/Maximum Muffler
709021		Universal MSL/Maximum Muffler
709022		Universal MSL/Maximum Muffler
709023		Universal MSL/Maximum Muffler
709024		Universal MSL/Maximum Muffler
709025		Universal MSL/Maximum Muffler
709027		Universal MSL/Maximum Muffler

P/N	YEAR	APPLICATION
709028		Universal MSL/Maximum Muffler
709029		Universal MSL/Maximum Muffler
709030		Universal MSL/Maximum Muffler
709031		Universal MSL/Maximum Muffler
709032		Universal MSL/Maximum Muffler
709033		Universal MSL/Maximum Muffler
709034		Universal MSL/Maximum Muffler
709069		Universal MSL/Maximum Muffler
709114		Universal MSL/Maximum Muffler
709992	87-96	DODGE Dakota
709993		Universal MSL/Maximum Muffler
709994		Universal MSL/Maximum Muffler
709997	87-90	CHEV/GMC Van G Series
709998		Universal MSL/Maximum Muffler
709999	88-89	PONT LeMans

Muffler includes bracket.

STAINLESS STEEL PERFORMANCE MUFFLERS *Reversible*



PERFORMANCE FEATURES

- Heavy gauge 100% Stainless Steel
- All welded construction
- Straight through flow design
- Increased flow
- Excellent performance sound
- Reversible
- High temperature acoustical filler material
- Better performance

4" x 9" OVAL REVERSIBLE

OFFSET/CENTER (4" x 9")

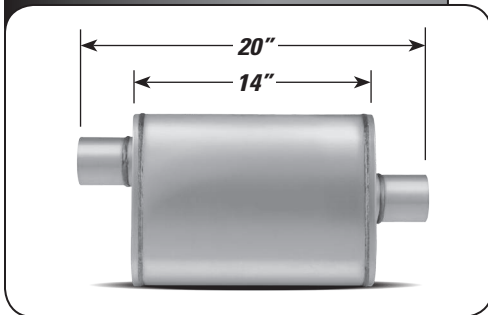

P/N	INLET	OUTLET
XS1224	2"	2"
XS1225	2 ¼"	2 ¼"
XS1226	2 ½"	2 ½"
XS1229	3"	3"

OFFSET/CENTER (4" x 9")

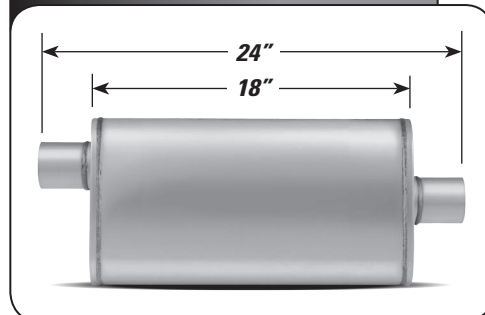

P/N	INLET	OUTLET
XS1255	2 ¼"	2 ¼"
XS1256	2 ½"	2 ½"
XS1259	3"	3"

OFFSET/OFFSET (4" x 9")

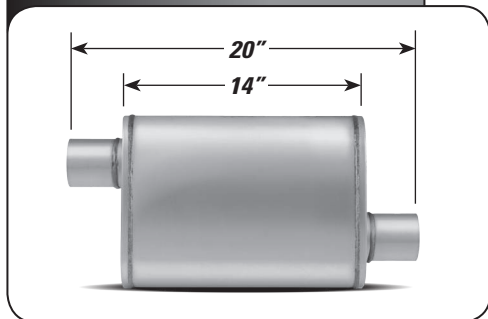

P/N	INLET	OUTLET
XS1235	2 ¼"	2 ¼"
XS1236	2 ½"	2 ½"

OFFSET/OFFSET (4" x 9")

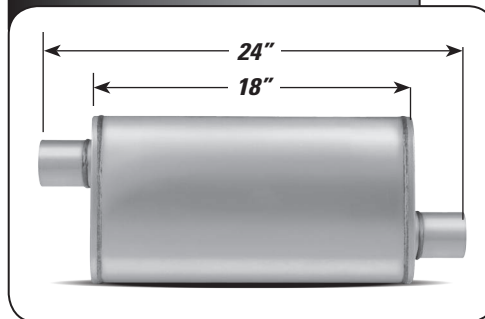

P/N	INLET	OUTLET
XS1266	2 ½"	2 ½"

PERFORMANCE FEATURES

- Heavy gauge 100% Stainless Steel
- All welded construction
- Straight through flow design
- Increased flow
- Excellent performance sound
- Reversible
- High temperature acoustical filler material
- Better performance

4" x 9" OVAL REVERSIBLE

TRANSVERSE & OFFSET/DUALS (4" x 9")

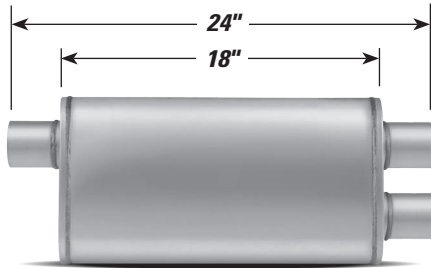

P/N	INLET	OUTLET
XS2265	2 1/2"	2 1/2"

CENTER/DUALS (4" x 9")

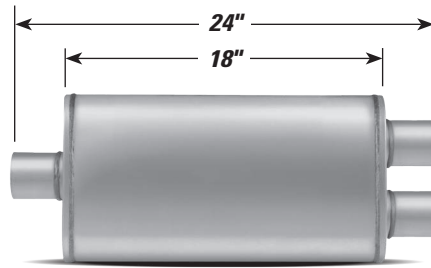

P/N	INLET	OUTLET
XS2258	2 1/2"	2 1/4"
XS2268	2 1/2"	2 1/2"
XS2278	3"	2 1/4"
XS2288	3"	2 1/2"
XS2298	3"	3"

CENTER/DUALS (4" x 9")

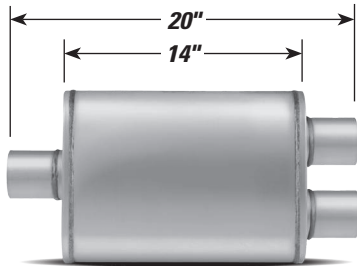

P/N	INLET	OUTLET
XS1149	2 1/4"	2 1/4"
XS2157	2 1/2"	2 1/4"
XS2158	2 1/2"	2 1/2"
XS2197	3"	2 1/4"
XS2198	3"	2 1/2"

STAINLESS STEEL PERFORMANCE MUFFLERS *Reversible*



PERFORMANCE FEATURES

- Heavy gauge 100% Stainless Steel
- All welded construction
- Straight through flow design
- Increased flow
- Excellent performance sound
- Reversible
- High temperature acoustical filler material
- Better performance

5" x 11" LARGE OVAL REVERSIBLE

CENTER/CENTER (5" x 11")

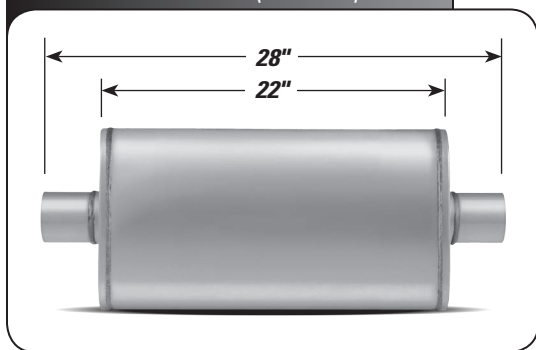

P/N	INLET	OUTLET
XS2579	3"	3"

DUALS/CENTER OR CENTER/DUALS (5" x 11")

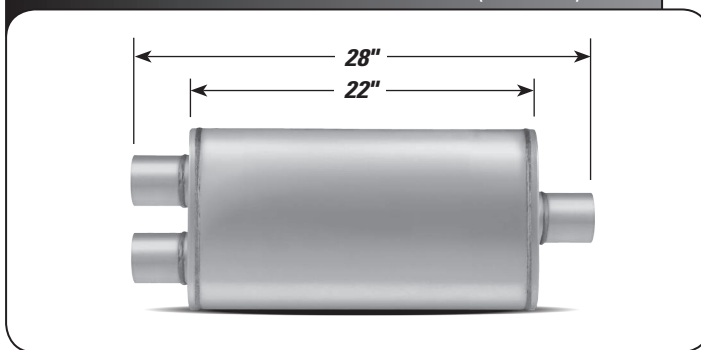

DUALS/CENTER

P/N	INLET	OUTLET
XS2588	2 1/2"	3"

CENTER/DUALS

P/N	INLET	OUTLET
XS2588	3"	2 1/2"

CENTER/OFFSET (5" x 11")

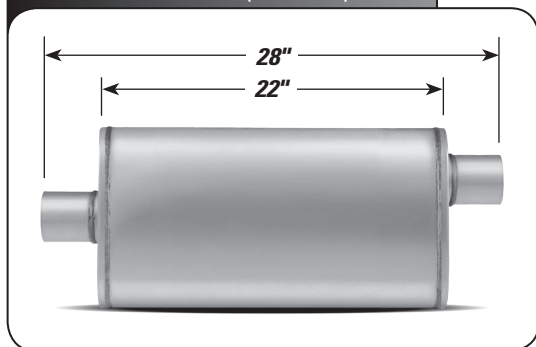

P/N	INLET	OUTLET
XS2589	3"	3"

DUALS/DUALS (5" x 11")

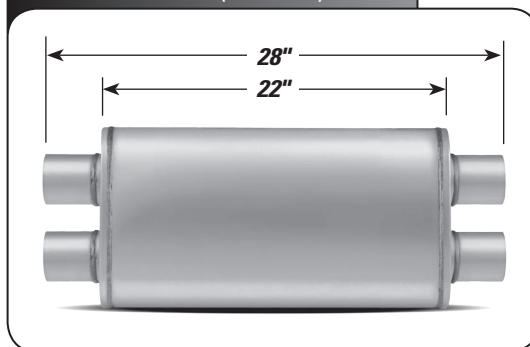

P/N	INLET	OUTLET
XS2568	2 1/2"	2 1/2"

PERFORMANCE

PERFORMANCE FEATURES

- Heavy gauge 100% Stainless Steel
- All welded construction
- Straight through flow design
- Increased flow
- Excellent performance sound
- Reversible
- High temperature acoustical filler material
- Better performance

4" ROUND REVERSIBLE

CENTER/CENTER (4" Round)

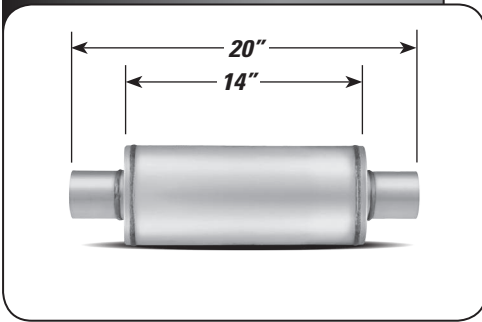

P/N	INLET	OUTLET
XS0445	2 ¼"	2 ¼"
XS0416	2 ½"	2 ½"

CENTER/CENTER (4" Round)

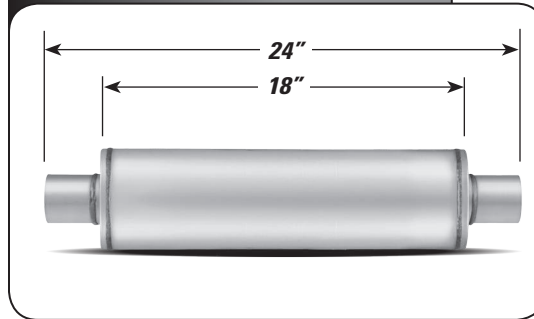

P/N	INLET	OUTLET
XS0425	2 ¼"	2 ¼"
XS0426	2 ½"	2 ½"

7" ROUND REVERSIBLE

CENTER/CENTER (7" Round)

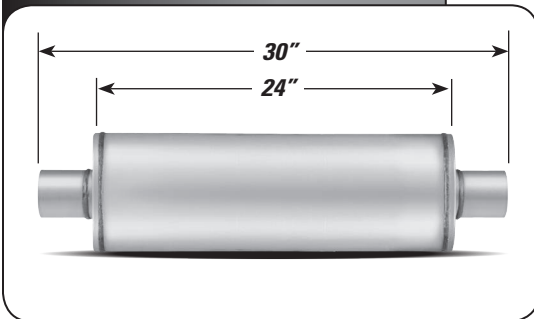

P/N	INLET	OUTLET
XS2772	4"	4"

HIGH PERFORMANCE MUFFLERS



VX SERIES HIGH PERFORMANCE MUFFLERS

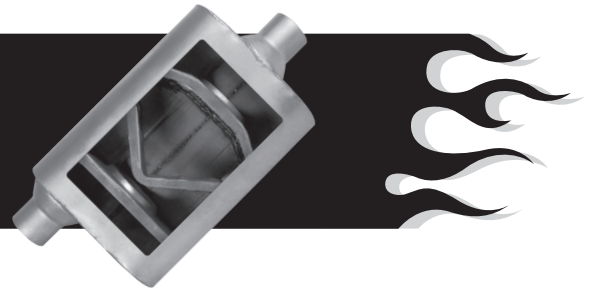

PERFORMANCE

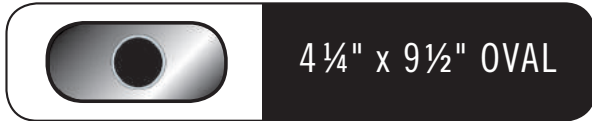

4 1/4" x 9 1/2" OVAL

CENTER/OFFSET (4 1/4" x 9 1/2")

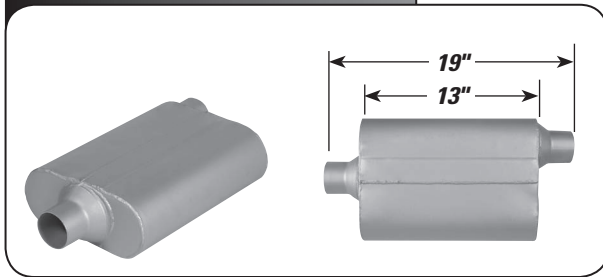

P/N	Inlet	Outlet
VX2442	2 1/4"	2 1/4"
VX2542	2 1/2"	2 1/2"
VX3042	3"	3"

OFFSET/CENTER (4 1/4" x 9 1/2")

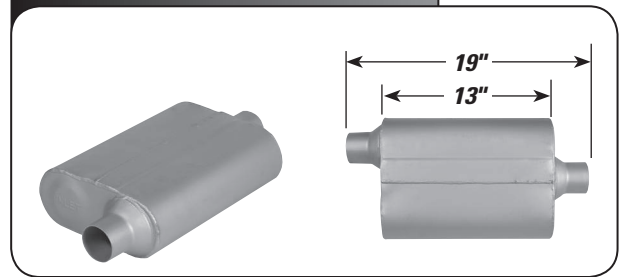

P/N	Inlet	Outlet
VX2441	2 1/4"	2 1/4"
VX2541	2 1/2"	2 1/2"
VX3041	3"	3"

OFFSET/OFFSET (4 1/4" x 9 1/2")

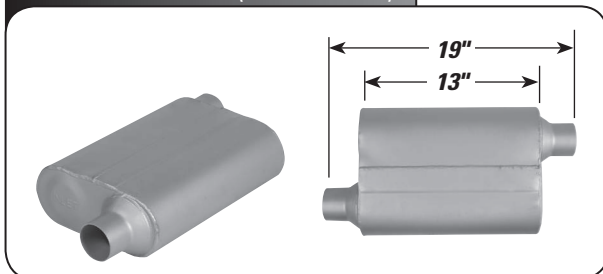

P/N	Inlet	Outlet
VX2443	2 1/4"	2 1/4"
VX2543	2 1/2"	2 1/2"
VX3043	3"	3"

CENTER/DUALS (4 1/4" x 9 1/2")

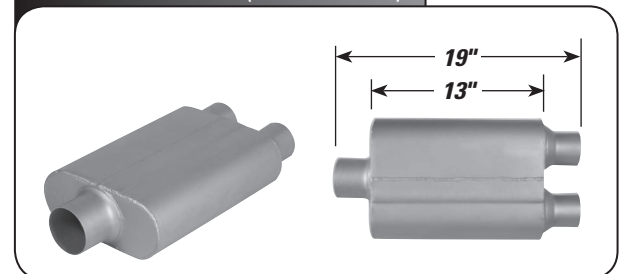

P/N	Inlet	Outlet
VX0402	3"	2 1/2" Duals
VX0422	3"	2 1/4" Duals
VX4422	2 1/4"	2 1/4" Duals
VX5400	2 1/2"	2 1/2" Duals
VX5422	2 1/2"	2 1/4" Duals

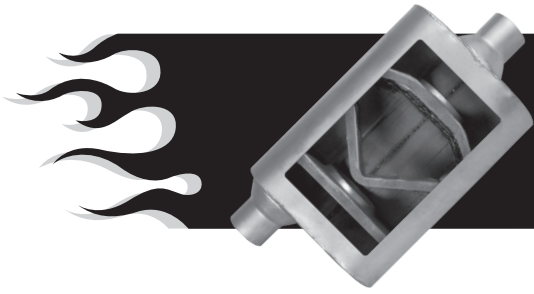

VX SERIES

- V-FLOW for deep, aggressive tone
- Better performance
- Increased flow
- 100% Aluminized

DUALS/CENTER (4 1/4" x 9 1/2")

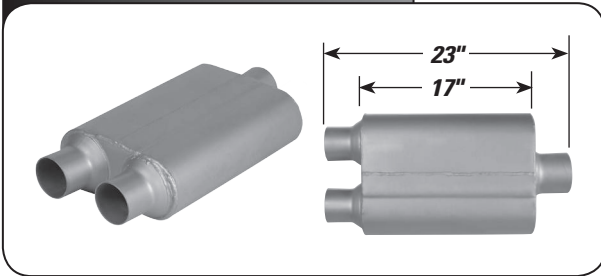

P/N	Inlet	Outlet
VX2552	2 1/2" Duals	2 1/2"

DUALS/DUALS (4 1/4" x 9 1/2")

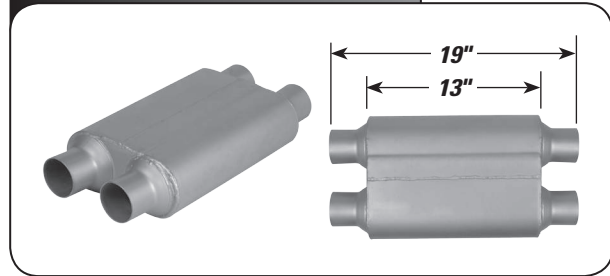

P/N	Inlet	Outlet
VX4134	2 1/4" Duals	2 1/4" Duals

DUALS/DUALS (4 1/4" x 9 1/2")

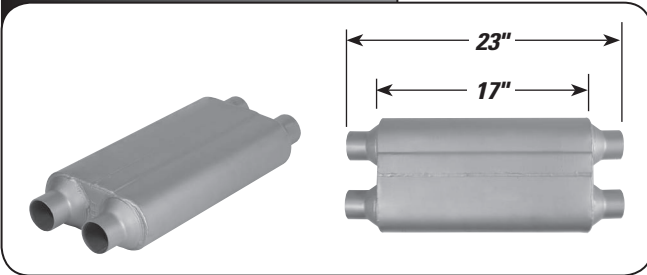

P/N	Inlet	Outlet
VX4554	2 1/4" Duals	2 1/4" Duals

TRANSVERSE (4 1/4" x 9 1/2")

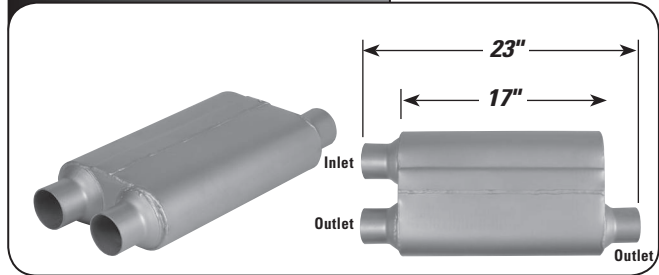

P/N	Inlet	Outlet
VX2583	2 1/2"	2 1/2" Duals Trans

RACE PERFORMANCE MUFFLERS

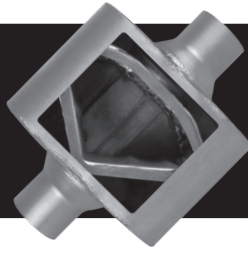

VR SERIES



PERFORMANCE

- V-FLOW for deep, aggressive tone
- Better performance
- Increased flow
- 100% Aluminized

CENTER/CENTER (4 1/4" x 9 1/2")

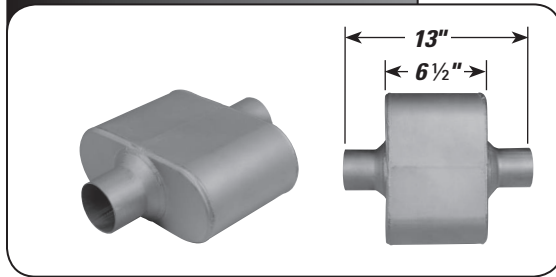

P/N	Inlet	Outlet
VR7426	2 1/2"	2 1/2"
VR7428	3"	3"

CENTER/DUALS (4 1/4" x 9 1/2")

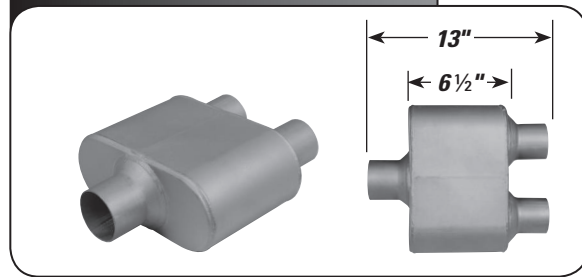

P/N	Inlet	Outlet
VR7425	2 1/2"	2 1/4" Duals
VR7427	3"	2 1/2" Duals

OFFSET/OFFSET (4 1/4" x 9 1/2")

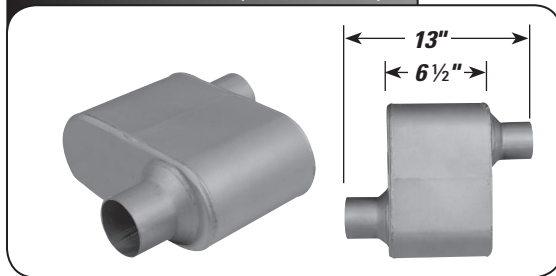

P/N	Inlet	Outlet
VR7429	2 1/4"	2 1/4"
VR7430	2 1/2"	2 1/2"

OFFSET/CENTER (4 1/4" x 9 1/2")

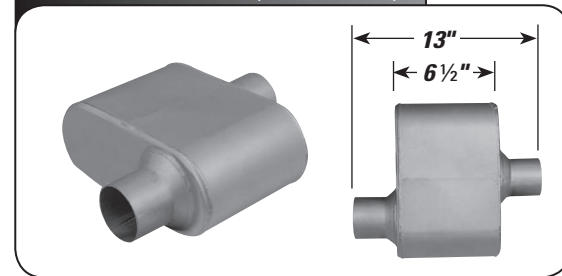

P/N	Inlet	Outlet
VR7431	2 1/4"	2 1/4"
VR7432	2 1/2"	2 1/2"

CHEVROLET/GMC MUFFLERS

1500, 2500, 3500 HeavyDuty 6.0 & 8.1 Litre Gas Engines

PERFORMANCE FEATURES

- All welded construction
- High flow design
- Better performance
- Heavy gauge 100% aluminized steel
- Increased flow
- Excellent performance sound

8 1/2" x 11 3/4"

DUAL OUTLETS FIT OEM TAIL PIPE (8 1/2" x 11 3/4")



INLET



OUTLET

P/N	SHELL	OAL	INLET	OUTLET
2500	24 1/2"	29"	3" ID Duals	3" OD Duals

- Dual Outlets Fit OEM Tailpipe
- Original Equipment Tuning for OE Sound

SINGLE OUTLET PERFORMANCE OPTION (8 1/2" x 11 3/4")

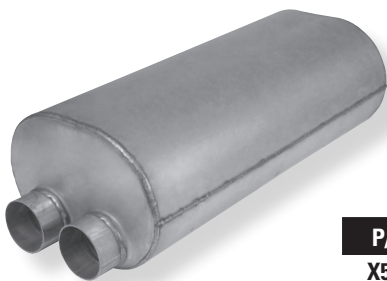

INLET



OUTLET

P/N	SHELL	OAL	INLET	OUTLET
X503	24 1/2"	29"	3" ID Duals	3" ID

- Use with Xlerator Mandrel Bent Tailpipe X6007 or MaxFit Tailpipe 126584
- Performance Sound on Single Outlet 3" Tailpipe

DUAL OUTLET PERFORMANCE OPTION (8 1/2" x 11 3/4")

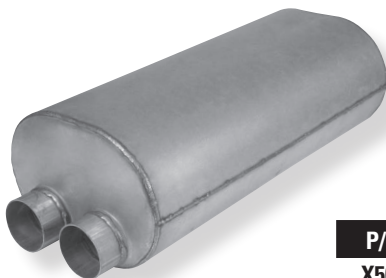

INLET



OUTLET

P/N	SHELL	OAL	INLET	OUTLET
X504	24 1/2"	30 1/2"	3" ID Duals	2 1/2" ID Duals

- Full Performance Sound when used with Xlerator Mandrel Bent Tailpipe No.'s X6013 (LS) and X6014 (RS) or Use MaxFit Tailpipes 127670 (LS) and 127671 (RS)

ALL-WELDED PERFORMANCE MUFFLERS



POPULAR OPTIONS FOR DUALING PICKUP TRUCKS

Mandrel Bent Pipes are available.

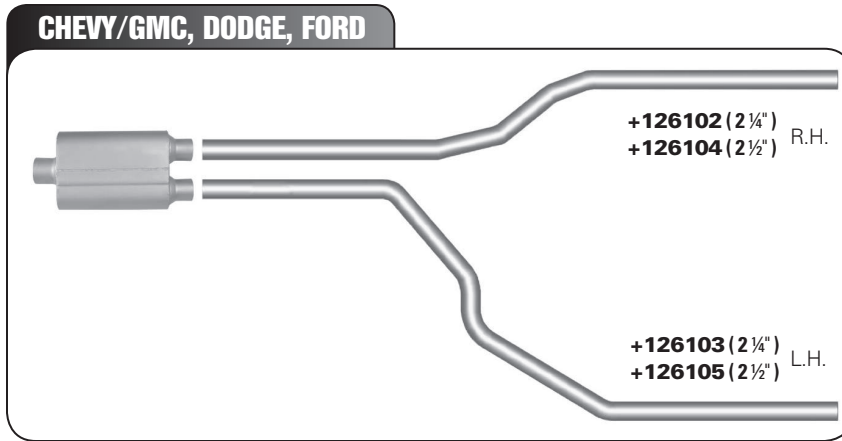

P/N	INLET	OUTLET	BRAND
XS1149	2 1/4"	2 1/4" Duals	XLERATOR
XS2157	2 1/2"	2 1/4" Duals	XLERATOR
XS2158	2 1/2"	2 1/2" Duals	XLERATOR
XS2197	3"	2 1/4" Duals	XLERATOR
XS2198	3"	2 1/2" Duals	XLERATOR
VX4422	2 1/4"	2 1/4" Duals	VX
VX5422	2 1/2"	2 1/4" Duals	VX
VX5400	2 1/2"	2 1/2" Duals	VX
VX0422	3"	2 1/4" Duals	VX
VX0402	3"	2 1/2" Duals	VX
690513	2 1/2"	2 1/4" Duals	TURBO
690514	2 1/2"	2 1/2" Duals	TURBO
690510	3"	2 1/4" Duals	TURBO
690511	3"	2 1/2" Duals	TURBO

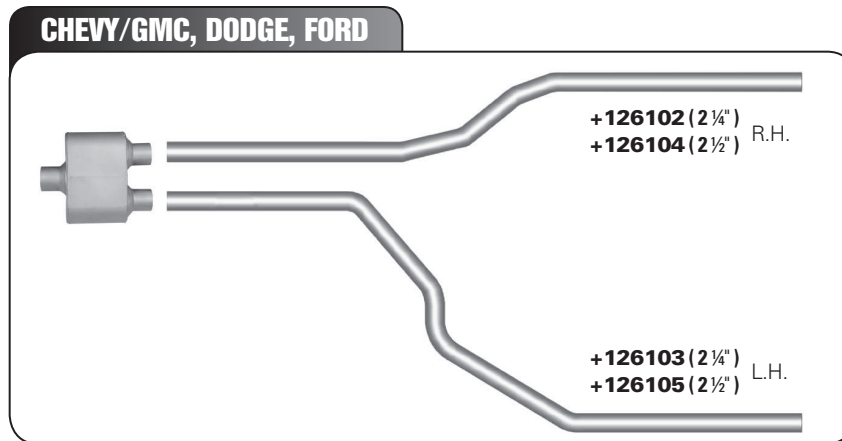

P/N	INLET	OUTLET	BRAND
VR7425	2 1/2"	2 1/4" Duals	VR
VR7427	3"	2 1/2" Duals	VR

+Note: For **MANDREL** Bent Pipes use the following:

- For 126102 use **X6102** 2 1/4"
- For 126103 use **X6103** 2 1/4"
- For 126104 use **X6104** 2 1/2"
- For 126105 use **X6105** 2 1/2"

- Ideal For Custom and Dual Installations
- Economically Priced
- Excellent Performance, Sound and Reduced Back-Pressure
- 100% Aluminized Components For Superior Corrosion Protection
- Large Inner Tubes Allow Straight Through Power
- Feature AKDDQ Necks For Easy Modification
- Most Units are Reversible to Limit SKU's
- Large Body 4 1/16" x 10 1/2" and 4 1/2" x 11" Ovals For Light Trucks, Sport Utility Vehicles, Cars and Vans
- Slimmer 4 1/4" x 8 3/4" Ovals to Fit Today's Performance Vehicles
- Smaller 3 1/4" x 7 3/4" Ovals are Also Available to Meet Your Installation Flexibility Needs.

3 1/4" x 7 3/4"

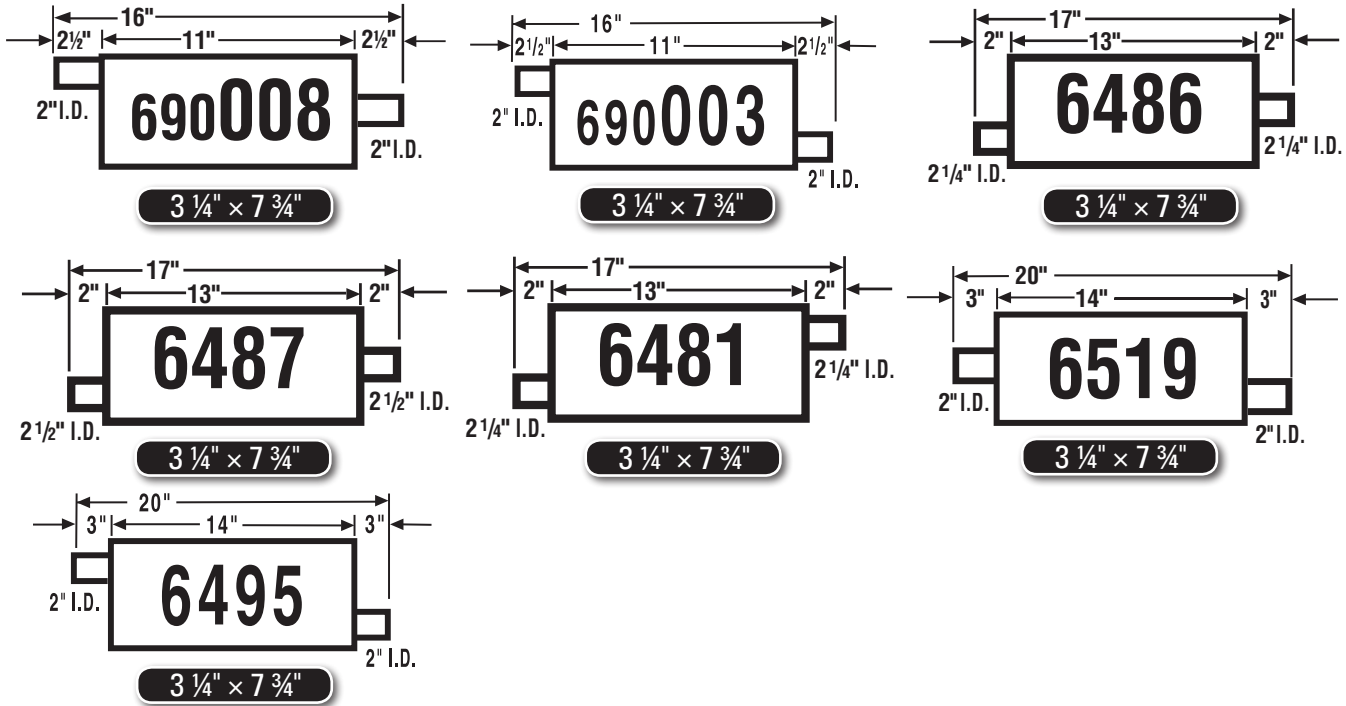

4 1/4" x 8 3/4"

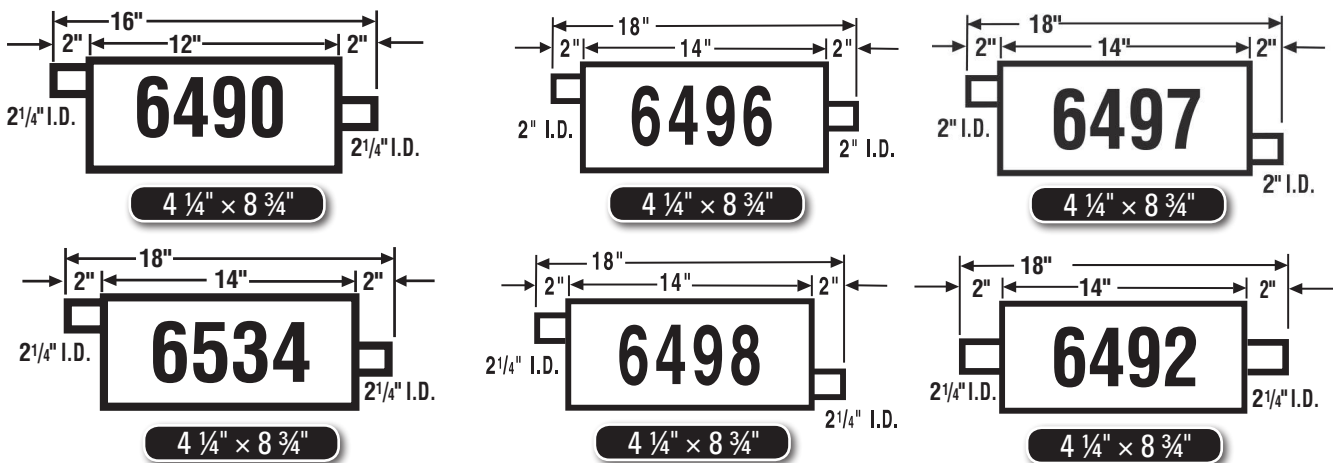

ALUMINIZED TURBO MUFFLERS



PERFORMANCE

4 1/4" x 8 3/4"

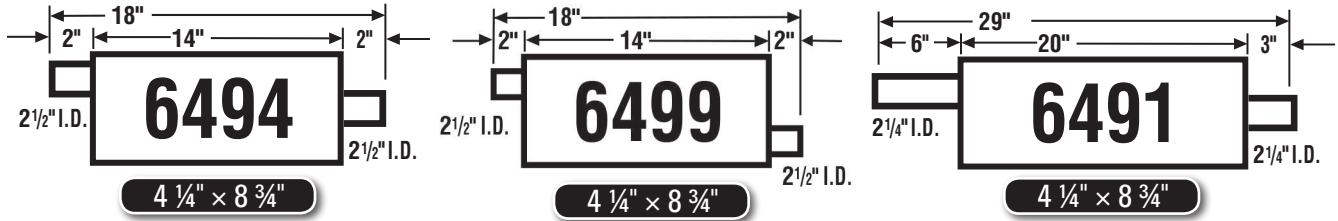

4 1/16" x 10 1/2"

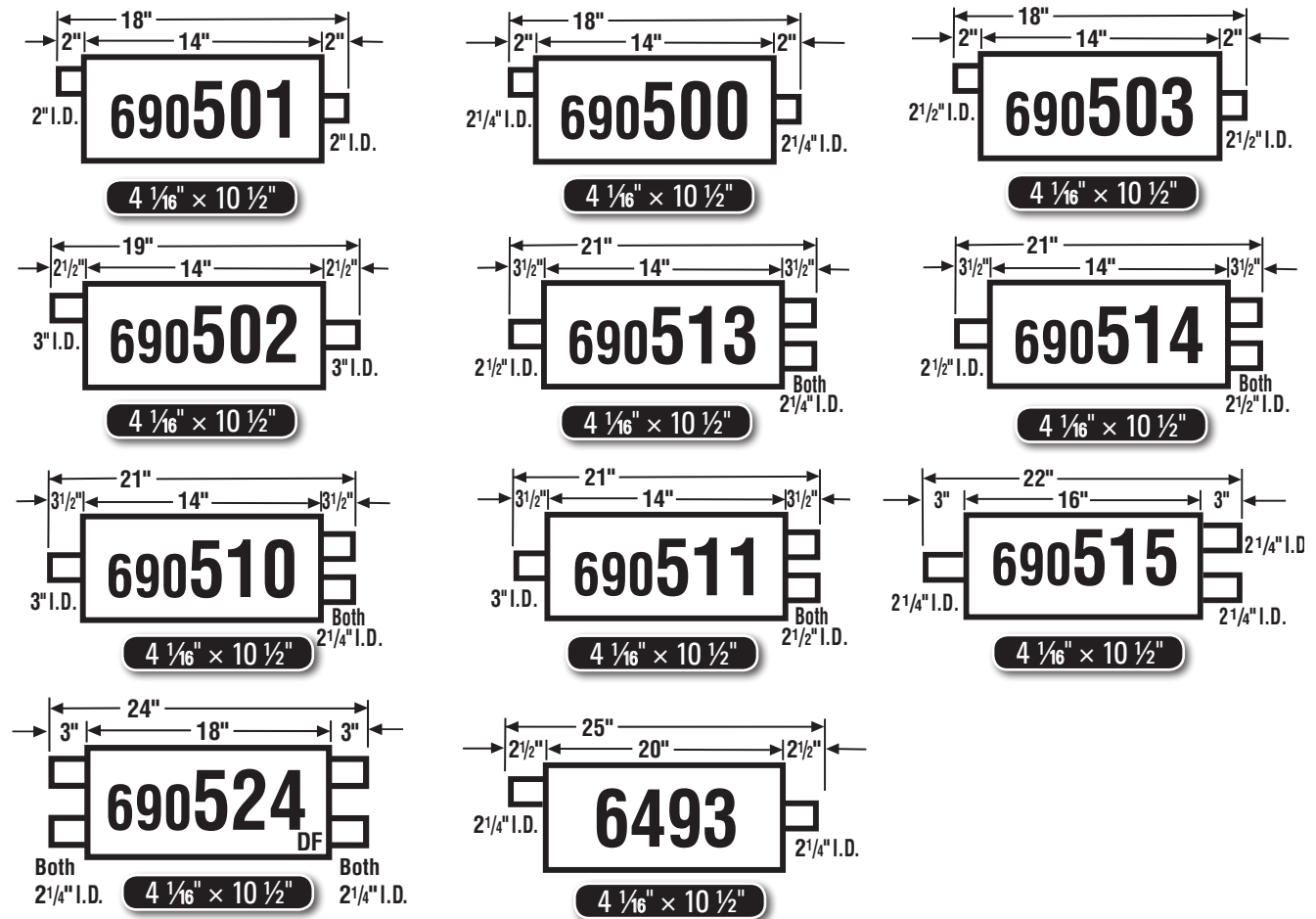

4 1/2" x 11"

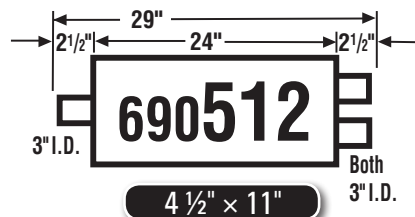

5 1/2" x 11"

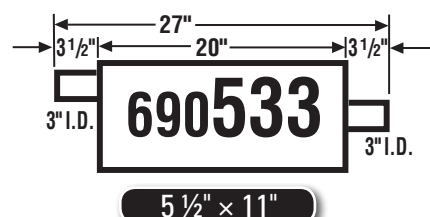

GLASSPACKS

- Aluminized Heavy Duty, 15 Gauge, 3", 3 1/2" and 4" Diameter Shells
- Spiral Louvered Inner Core Produces a Deep, Mellow Tone, Decreases Backpressure and Increases Performance
- AKDDQ Necks Allow For Easy Expansion
- Single Packs

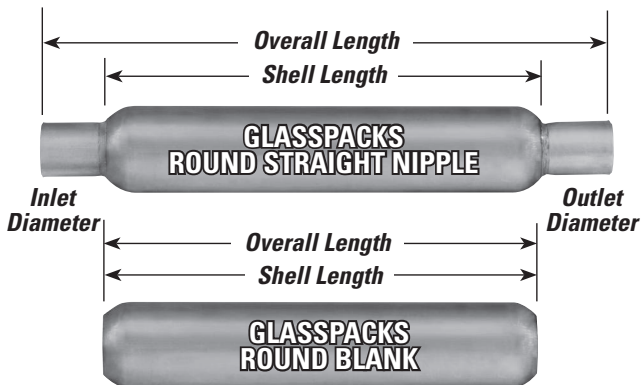

PART NUMBER DEFINITION

Example: 351811

First two digits = Shell Diameter (35=3.5=3 1/2")

Second two digits = Shell Length (18")

Third Two Digits = Configuration:

00 = Blank

11 = Center/Center

12 = Mild Offset/Mild Offset

22 = Full Offset/Full Offset

Seventh digit indicates neck size greater than 2 1/4":

3 = Two 2 1/2" Necks

4 = Two 3" Necks

Seventh or Eighth digit:

2 = 2 1/4" Core Size

5 = 2 1/2" Core Size

6 = 3" Core Size

P/N	CASE DIAMETER	CASE LENGTH	CORE DIAMETER	OAL	NECK INLET	NECK OUTLET	NECK CONFIG
3" Case / 1 3/4" Core							
301200S	3"	12"	1 3/4"	12"			Blank
301211S	3"	12"	1 3/4"	18"	1 3/4"	1 3/4"	Straight
301800S	3"	18"	1 3/4"	18"			Blank
301811S	3"	18"	1 3/4"	24"	1 3/4"	1 3/4"	Straight
3 1/2" Case / 2" Core							
351200S	3 1/2"	12"	2"	12"			Blank
351211S	3 1/2"	12"	2"	18"	2"	2"	Straight
351600S	3 1/2"	16"	2"	16"			Blank
351611S	3 1/2"	16"	2"	22"	2"	2"	Straight
351800S	3 1/2"	18"	2"	18"			Blank
351811S	3 1/2"	18"	2"	24"	2"	2"	Straight
351812S	3 1/2"	18"	2"	24"	2"	2"	Medium
351822S	3 1/2"	18"	2"	24"	2"	2"	Full
352200S	3 1/2"	22"	2"	22"			Blank
352211S	3 1/2"	22"	2"	28"	2"	2"	Straight
352400S	3 1/2"	24"	2"	24"			Blank
352411S	3 1/2"	24"	2"	30"	2"	2"	Straight
352600S	3 1/2"	26"	2"	26"			Blank
352611S	3 1/2"	26"	2"	32"	2"	2"	Straight
353000S	3 1/2"	30"	2"	30"			Blank
353011S	3 1/2"	30"	2"	36"	2"	2"	Straight

GLASSPACKS - (Cont.)

P/N	CASE DIAMETER	CASE LENGTH	CORE DIAMETER	OAL	NECK INLET	NECK OUTLET	NECK CONFIG
3 ½" Case / 2 ¼" Core							
3512002S	3 ½"	12"	2 ¼"	12"			Blank
3512112S	3 ½"	12"	2 ¼"	18"	2 ¼"	2 ¼"	Straight
3516002S	3 ½"	16"	2 ¼"	16"			Blank
3516112S	3 ½"	16"	2 ¼"	22"	2 ¼"	2 ¼"	Straight
3518002S	3 ½"	18"	2 ¼"	18"			Blank
3518112S	3 ½"	18"	2 ¼"	24"	2 ¼"	2 ¼"	Straight
35181135S	3 ½"	18"	2 ½"	24"	2 ½"	2 ½"	Straight
3518122S	3 ½"	18"	2 ¼"	24"	2 ¼"	2 ¼"	Medium
3522002S	3 ½"	22"	2 ¼"	22"			Blank
3522112S	3 ½"	22"	2 ¼"	28"	2 ¼"	2 ¼"	Straight
35221132S	3 ½"	22"	2 ¼"	28"	2 ½"	2 ½"	Straight
3524002S	3 ½"	24"	2 ¼"	24"			Blank
3524112S	3 ½"	24"	2 ¼"	30"	2 ¼"	2 ¼"	Straight
35241132S	3 ½"	24"	2 ¼"	30"	2 ½"	2 ½"	Straight
3526002S	3 ½"	26"	2 ¼"	26"			Blank
3526112S	3 ½"	26"	2 ¼"	32"	2 ¼"	2 ¼"	Straight
35261132S	3 ½"	26"	2 ¼"	32"	2 ½"	2 ½"	Straight
3530002S	3 ½"	30"	2 ¼"	30"			Blank
3530112S	3 ½"	30"	2 ¼"	36"	2 ¼"	2 ¼"	Straight
35301132S	3 ½"	30"	2 ¼"	36"	2 ½"	2 ½"	Straight
4" Case / 2 ¼" Core							
401800S	4"	18"	2 ¼"	18"			Blank
401811S	4"	18"	2 ¼"	24"	2 ¼"	2 ¼"	Straight
402200S	4"	22"	2 ¼"	22"			Blank
402211S	4"	22"	2 ¼"	28"	2 ¼"	2 ¼"	Straight
403000S	4"	30"	2 ¼"	30"			Blank
403011S	4"	30"	2 ¼"	36"	2 ¼"	2 ¼"	Straight
4" Case / 2 ½" Core							
4012005S	4"	12"	2 ½"	12"			Blank
40121135S	4"	12"	2 ½"	18"	2 ½"	2 ½"	Straight
4018005S	4"	18"	2 ½"	18"			Blank
40181135S	4"	18"	2 ½"	24"	2 ½"	2 ½"	Straight
4024005S	4"	24"	2 ½"	24"			Blank
40241135S	4"	24"	2 ½"	30"	2 ½"	2 ½"	Straight
4530005S	4"	30"	2 ½"	30"			Blank
40301135S	4"	30"	2 ½"	36"	2 ½"	2 ½"	Straight
4" Case / 3" Core							
4012006S	4"	12"	3"	12"			Blank
40121146S	4"	12"	3"	18"	3"	3"	Straight
4018006S	4"	18"	3"	18"			Blank
40181146S	4"	18"	3"	24"	3"	3"	Straight
4024006S	4"	24"	3"	24"			Blank
40241146S	4"	24"	3"	30"	3"	3"	Straight

TURBOPACKS & TORPEDO PACKS

- Featuring The Versatility of a Glasspack with The Sound Performance of a Turbo Muffler
- 2 Tube, 2 Baffle Internal Design Provides Turbo Tuning For Superior Sound Control
- Aluminized Heavy Duty, 15 Gauge, 4" Diameter Shell
- Aluminized AKDDQ Necks Allow For Easy Expansion
- Single Packs

PART NUMBER DEFINITION

Example: 4218112

First two digits = 4" Shell; 2 Designates Turbo Pack
Second two digits = Shell Length (18")

Third Two Digits = Configuration:
11 = Center/Center
12 = Mild Offset/Mild Offset
22 = Full Offset/Full Offset

Seventh digit indicates neck size other than 2" on both ends

- 1 = One 2 ¼"; One 2" Neck
- 2 = Two 2 ¼" Necks
- 3 = Two 2 ½" Necks

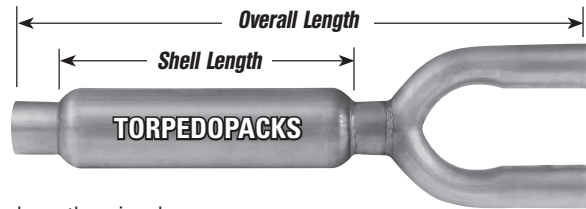
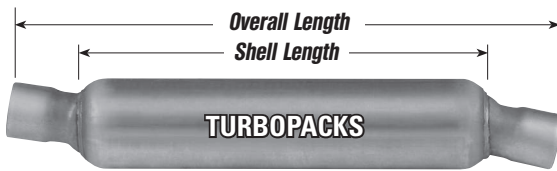

TURBOPACKS * Neck Offset – Inlet and Outlet dimensions I.D. unless otherwise shown.

P/N	CASE DIAMETER	CASE LENGTH	CORE DIAMETER	OAL	NECK INLET	NECK OUTLET	NECK CONFIG
421211S	4"	12"	1 ¾" (2)	18"	2"	2"	Straight
4212112S	4"	12"	1 ¾" (2)	18"	2 ¼"	2 ¼"	Straight
421512S	4"	15"	1 ¾" (2)	22"	2"	2"	Medium
421511S	4"	15"	1 ¾" (2)	22"	2"	2"	Straight
4215112S	4"	15"	1 ¾" (2)	22"	2 ¼"	2 ¼"	Straight
4215113S	4"	15"	1 ¾" (2)	22"	2 ½"	2 ½"	Straight
421822S	4"	18"	1 ¾" (2)	25"	2"	2"	Full
421812S	4"	18"	1 ¾" (2)	25"	2"	2"	Medium
4218122S	4"	18"	1 ¾" (2)	25"	2 ¼"	2 ¼"	Medium
421811S	4"	18"	1 ¾" (2)	25"	2"	2"	Straight
4218111S	4"	18"	1 ¾" (2)	25"	2 ¼"	2"	Straight
4218112S	4"	18"	1 ¾" (2)	25"	2 ¼"	2 ¼"	Straight
4218113S	4"	18"	1 ¾" (2)	25"	2 ½"	2 ½"	Straight
422411S	4"	24"	1 ¾" (2)	30"	2"	2"	Straight
4224112S	4"	24"	1 ¾" (2)	30"	2 ¼"	2 ¼"	Straight
4224113S	4"	24"	1 ¾" (2)	30"	2 ½"	2 ½"	Straight

TORPEDOPACKS

P/N	CASE DIAMETER	CASE LENGTH	CORE DIAMETER	OAL	NECK INLET	NECK OUTLET	NECK CONFIG
4115032	4"	15"	2 ½"	29"	Blank - 2 ½"	2 ¼"	Dual Outlet
4115033	4"	15"	2 ½"	29"	Blank - 2 ½"	2 ½"	Dual Outlet
4115042	4"	15"	3"	29"	Blank - 3"	2 ¼"	Dual Outlet
4115043	4"	15"	3"	29"	Blank - 3"	2 ½"	Dual Outlet
4115122	4"	15"	2 ¼"	29"	2 ¼"	2 ¼"	Dual Outlet
4115132	4"	15"	2 ½"	29"	2 ½"	2 ¼"	Dual Outlet
4115133	4"	15"	2 ½"	29"	2 ½"	2 ½"	Dual Outlet
4115142	4"	15"	3"	29"	3"	2 ¼"	Dual Outlet
4115143	4"	15"	3"	29"	3"	2 ½"	Dual Outlet
4118042	4"	18"	3"	31"	Blank - 3"	2 ¼"	Dual Outlet
4118132	4"	18"	2 ½"	31"	2 ½"	2 ¼"	Dual Outlet
4118133	4"	18"	2 ½"	31"	2 ½"	2 ½"	Dual Outlet
4118142	4"	18"	3"	31"	3"	2 ¼"	Dual Outlet

HEADER GASKETS & FLANGES

Allows Exhaust System Installation on Header Equipped Vehicles

GASKETS

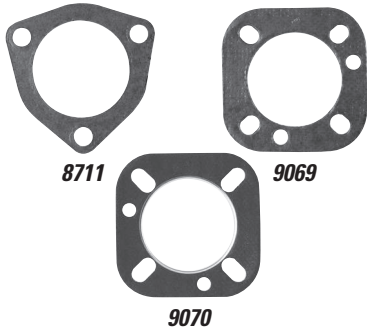

P/N	DESCRIPTION
8711	2 ½" Center Hole Flange Gasket
9069	3" Center Hole Flange Gasket
9070	3 ½" Center Hole Flange Gasket

FLANGES

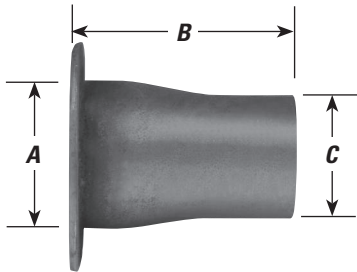

P/N	A	B	C
9071	2 ½"	4"	2 ½" O.D. 3 Hole
9073	3" O.D.	4 ½"	2 ½" O.D. 3 or 4 Hole

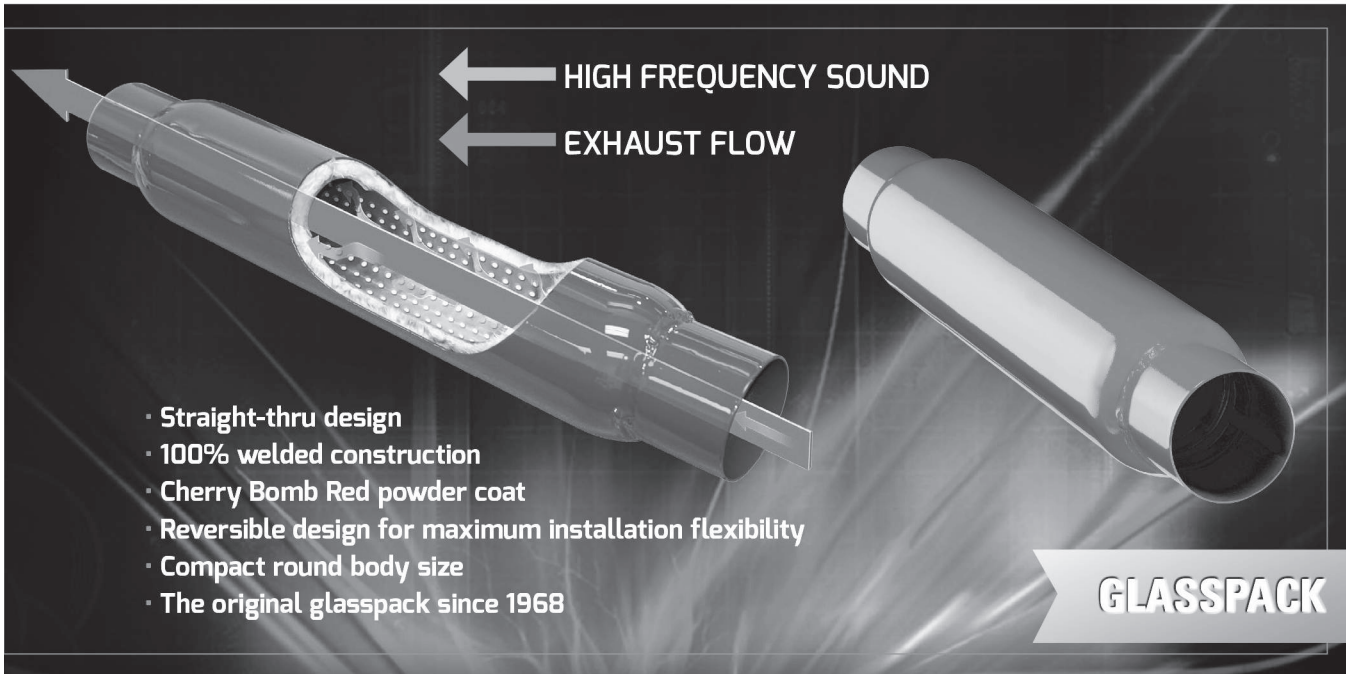

3 1/2" BODY Angled Necks

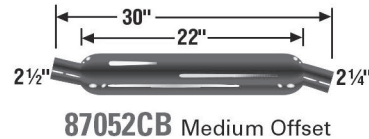

Full Offset - (Used for OFFSET / OFFSET Applications)
 Medium Offset - (Used for OFFSET / CENTER Applications)
 All neck sizes are inside diameter unless otherwise noted.



3 1/2" BODY Straight Necks

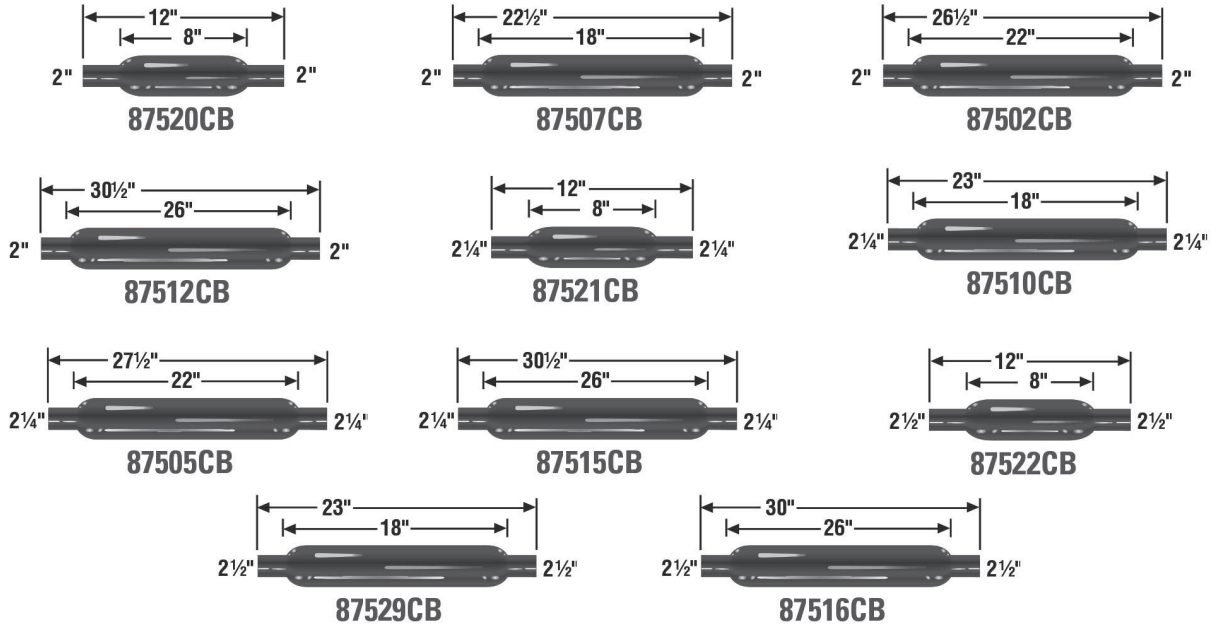

4" BODY Straight Necks

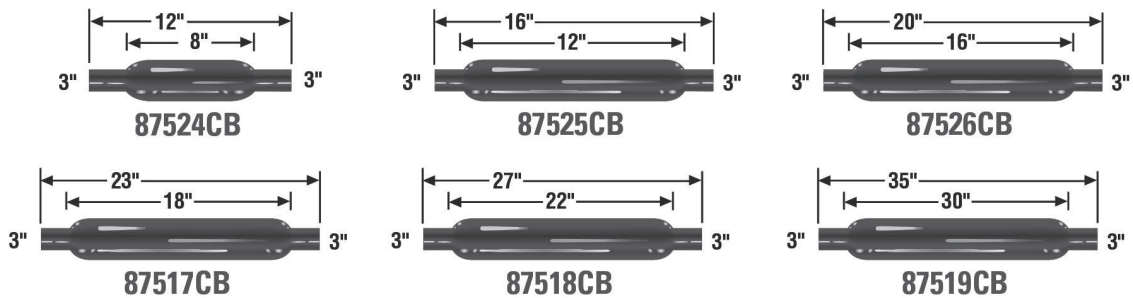

All neck sizes are inside diameter unless otherwise noted.



5" BODY Straight Necks

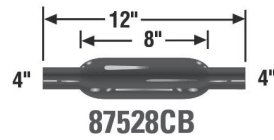
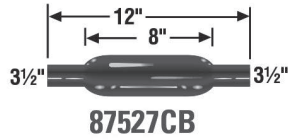

3 1/2" BODY Header Mufflers - Gasket Included

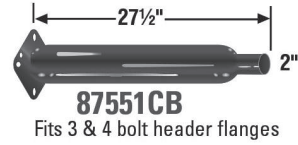
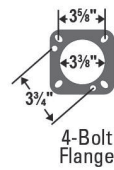
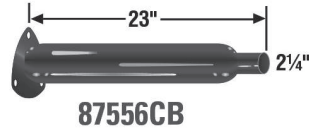

4" BODY Header Muffler - Gasket Included

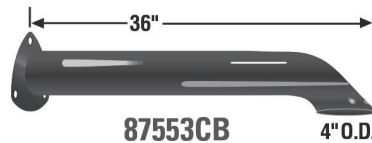

SIDE PIPE

All neck sizes are inside diameter unless otherwise noted.

CHERRY BOMB® M-80 PERFORMANCE MUFFLERS



PERFORMANCE

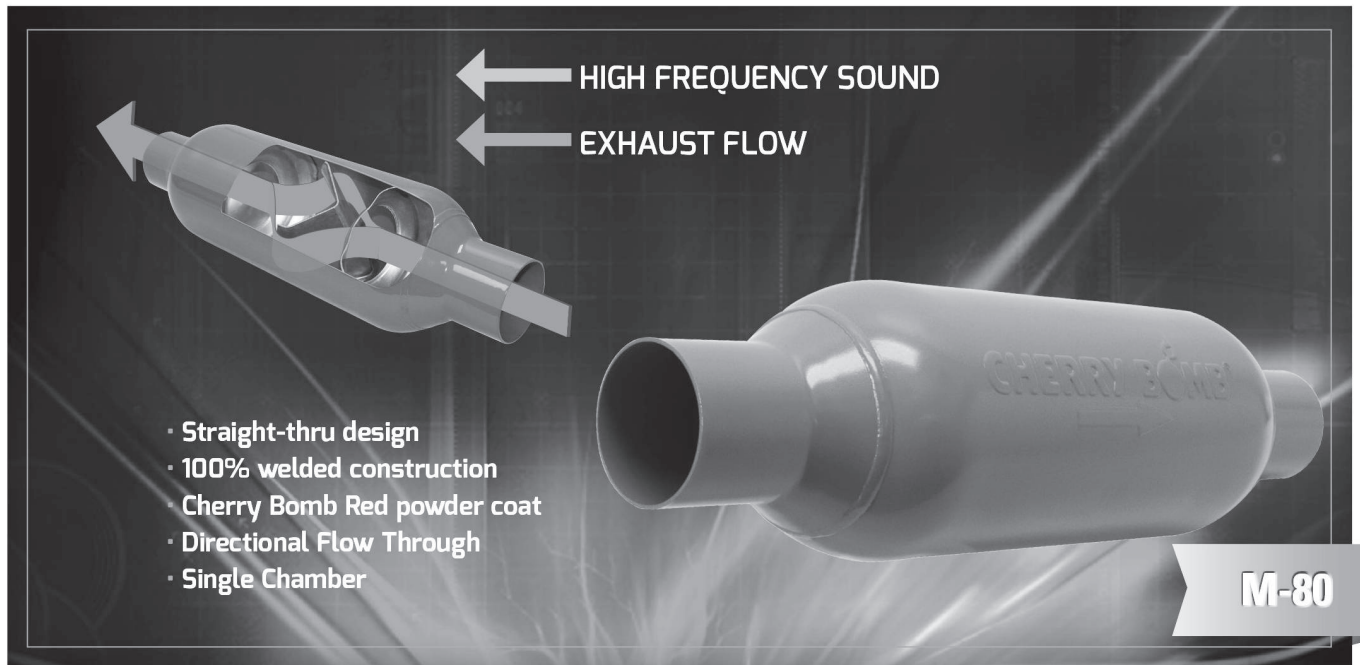

- Straight-thru design
- 100% welded construction
- Cherry Bomb Red powder coat
- Directional Flow Through
- Single Chamber



5" BODY Straight Necks



All neck sizes are inside diameter unless otherwise noted.

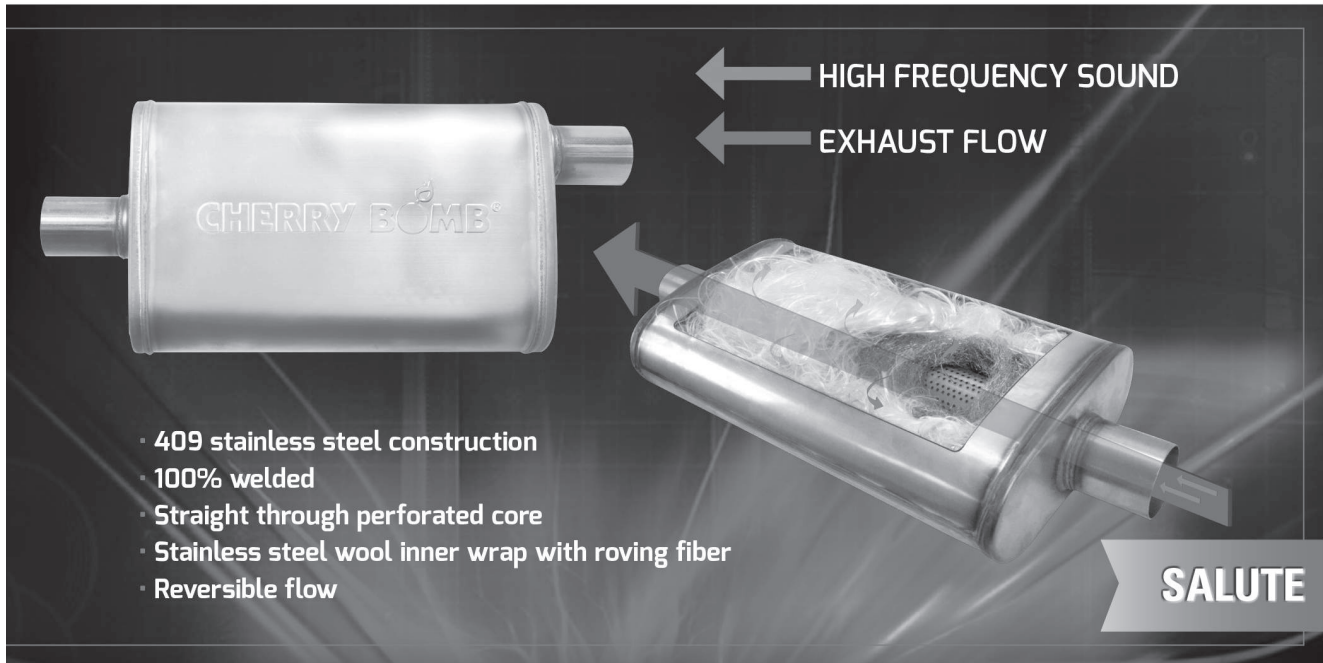

4" x 9" OVAL 14" BODY 20" OVERALL

OFFSET/OFFSET



SA1235



SA1236

OFFSET/CENTER



SA1224



SA1226



SA1225



SA1229

All neck sizes are inside diameter unless otherwise noted.

CHERRY BOMB® SALUTE PERFORMANCE MUFFLERS



4" x 9" OVAL 14" BODY 20" OVERALL

CENTER/DUALS



4" x 9" OVAL 18" BODY 24" OVERALL

OFFSET/OFFSET



OFFSET/CENTER

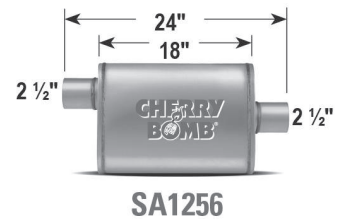

TRANSVERSE & OFFSET/ DUALS



All neck sizes are inside diameter unless otherwise noted.



4" x 9" OVAL 18" BODY 24" OVERALL

CENTER/DUALS

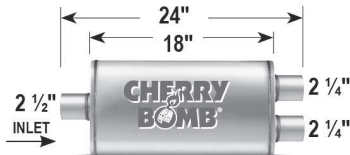

SA2258

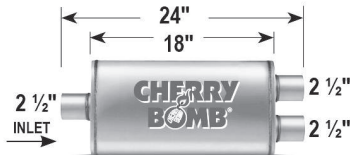

SA2268

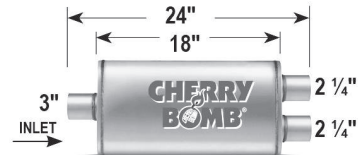

SA2278

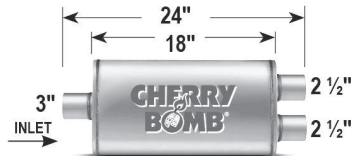

SA2288



SA2298



5" x 11" OVAL 22" BODY 28" OVERALL

DUAL/DUAL

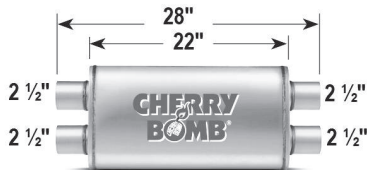

SA2568

CENTER/DUAL

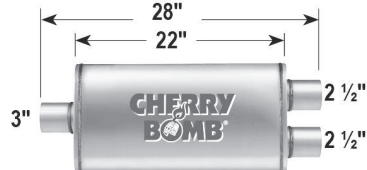

SA2588

OFFSET/CENTER

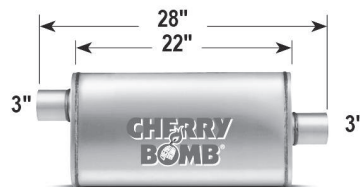

SA2589

All neck sizes are inside diameter unless otherwise noted.

CHERRY BOMB® SALUTE PERFORMANCE MUFFLERS



4" ROUND 14" BODY 20" OVERALL

CENTER/CENTER

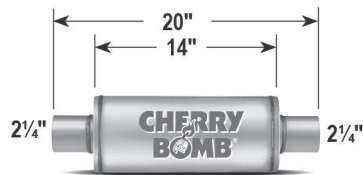

SA0445

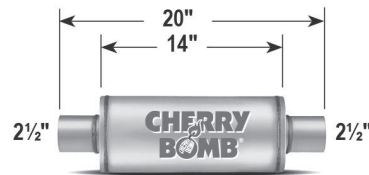

SA0416



4" ROUND 18" BODY 24" OVERALL

CENTER/CENTER

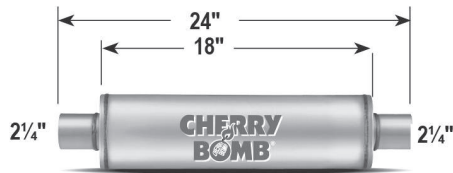

SA0425

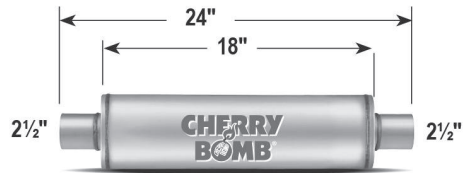

SA0426



7" ROUND 24" BODY 30" OVERALL

CENTER/CENTER

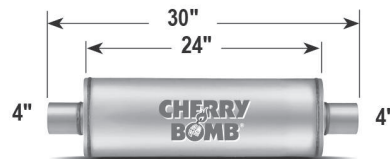

SA2772

All neck sizes are inside diameter unless otherwise noted.

PERFORMANCE

CHERRY BOMB
US PATENT 8996810

HIGH FREQUENCY SOUND
EXHAUST FLOW

- Patented flow divider design with high temp fiberglass
- 100% welded construction
- High temp grey finish
- Reversible design for maximum installation flexibility
- Standard body size
- Recommended for car, truck and SUV applications

VORTEX



4 1/4" x 10 1/4" OVAL 14" BODY 20 1/2" OVERALL

OFFSET/OFFSET

CENTER/OFFSET

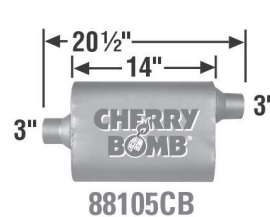
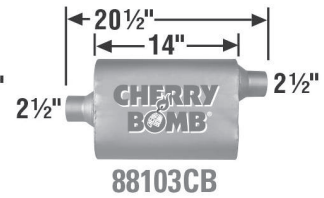
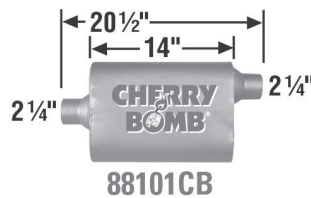
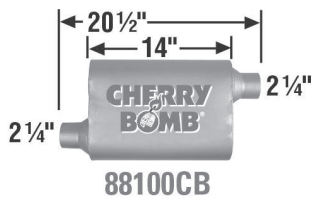

All Vortex Mufflers are Reversible Except for Cross-Flow
All neck sizes are inside diameter unless otherwise noted.

CHERRY BOMB® VORTEX PERFORMANCE MUFFLERS



4 1/4" x 10 1/4" OVAL 16" BODY 22 1/2" OVERALL

CENTER/DUAL

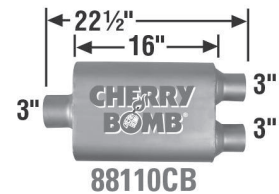
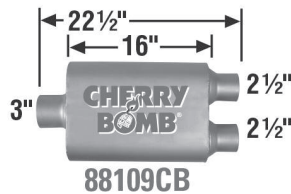
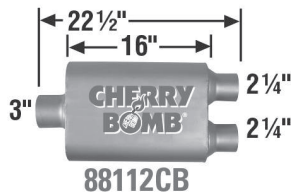
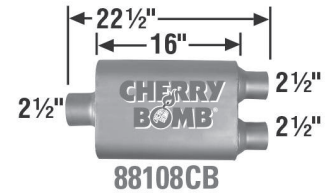
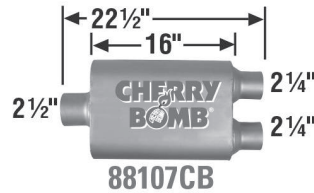

4 1/4" x 10 1/4" OVAL 17" BODY 23 1/2" OVERALL

DUAL/DUAL

Can Be Used As an X-Pipe



CROSS-FLOW

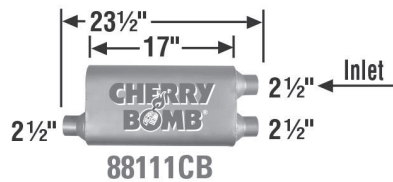

All Vortex Mufflers are Reversible Except for Cross-Flow
All neck sizes are inside diameter unless otherwise noted.

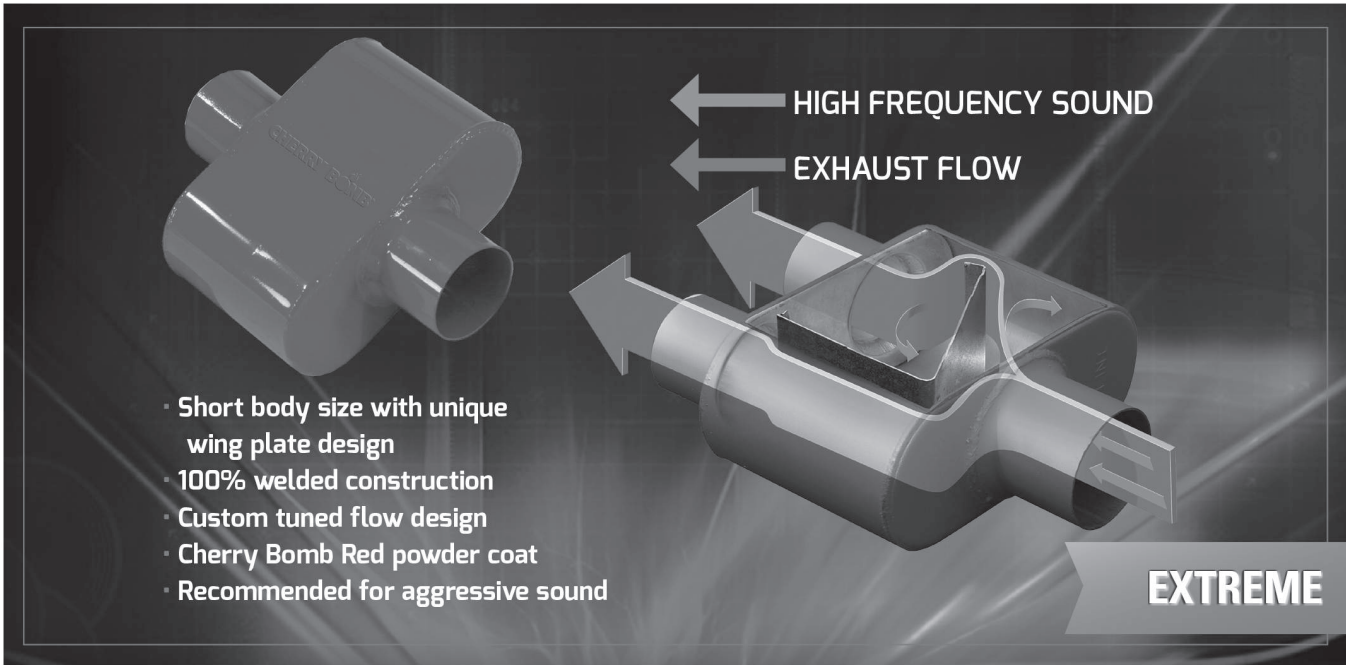

4" x 9³/₄" OVAL 6" BODY 12" OVERALL

OFFSET/OFFSET

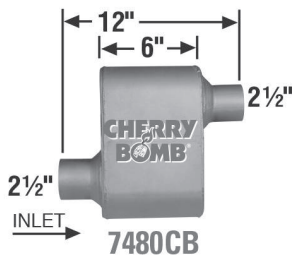

CENTER/CENTER

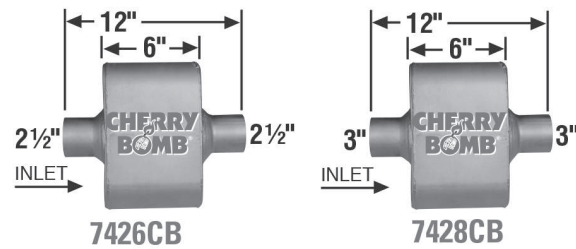

CENTER/DUAL

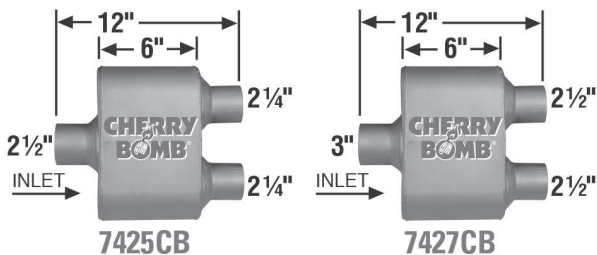

DUAL/DUAL

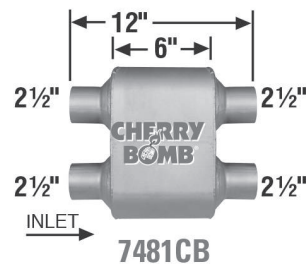

All Pro Mufflers are Directional Flow Design.
All neck sizes are inside diameter unless otherwise noted.

CHERRY BOMB® PRO PERFORMANCE MUFFLERS

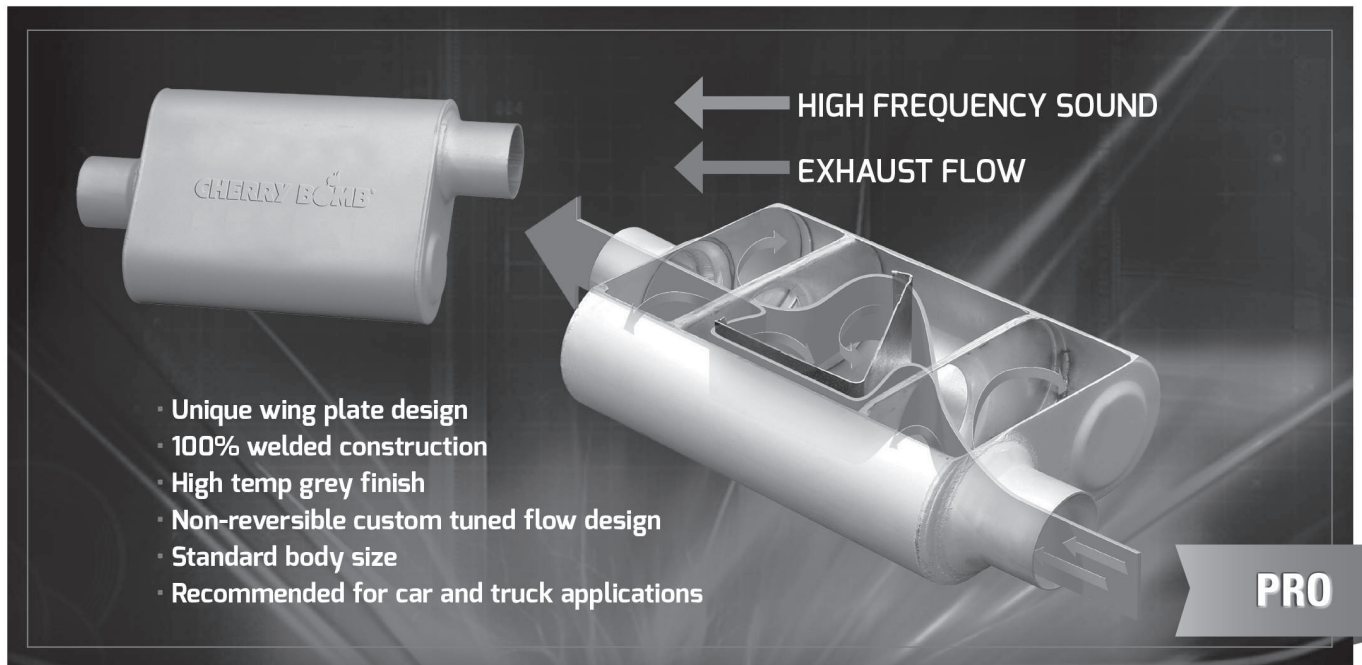

PERFORMANCE



4" x 9³/₄" OVAL 13" BODY 19" OVERALL

CENTER/CENTER

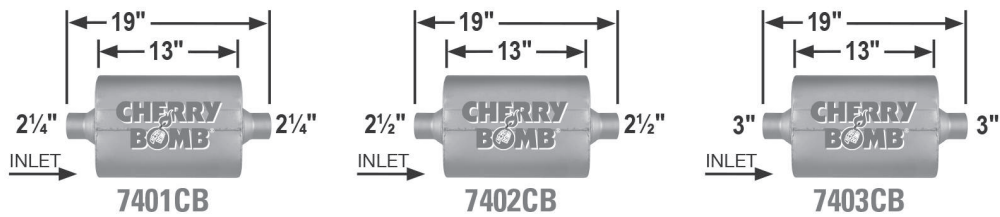

OFFSET/CENTER

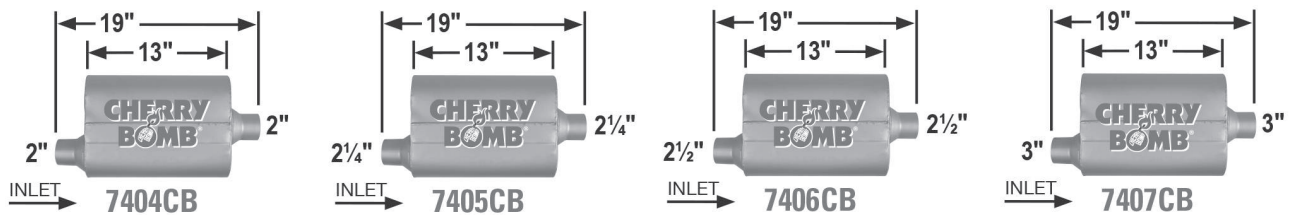

All Pro Mufflers are Directional Flow Design.
All neck sizes are inside diameter unless otherwise noted.



4" x 9³/₄" OVAL 13" BODY 19" OVERALL

CENTER/OFFSET

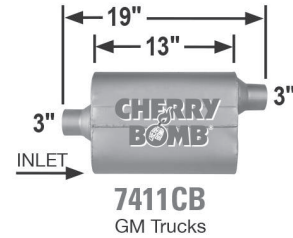
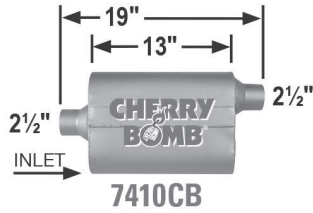
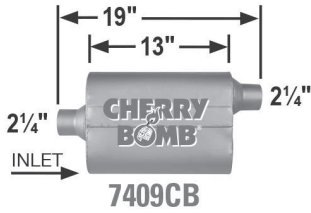

OFFSET/OFFSET

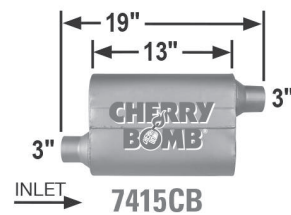
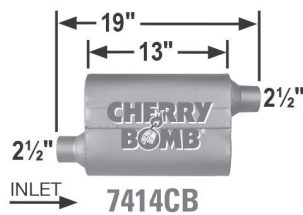
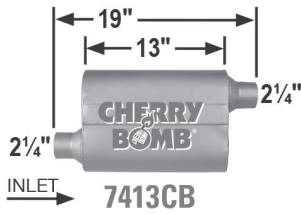

CENTER/DUAL

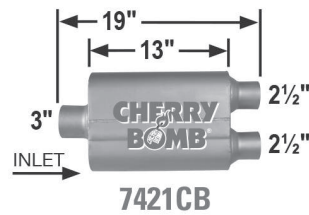
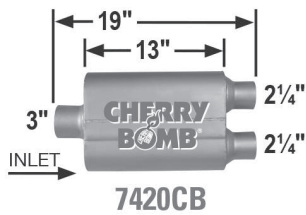
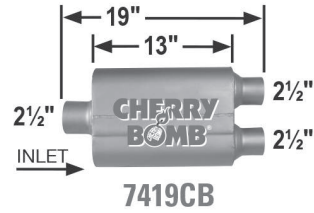
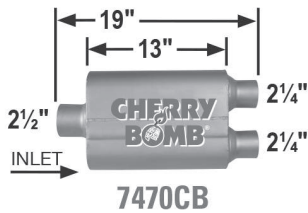

All Pro Mufflers are Directional Flow Design.
All neck sizes are inside diameter unless otherwise noted.



4" x 9³/₄" OVAL 16¹/₂" BODY 22¹/₂" OVERALL

CENTER/OFFSET

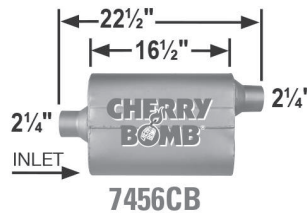

CENTER/DUAL

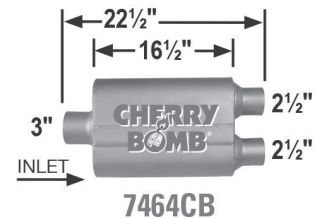
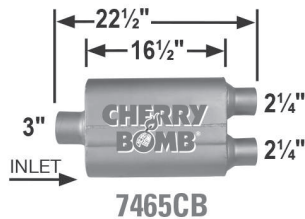

OFFSET/DUAL

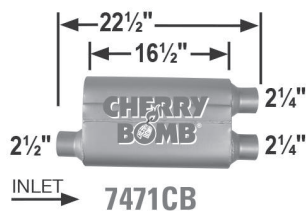

CROSS-FLOW

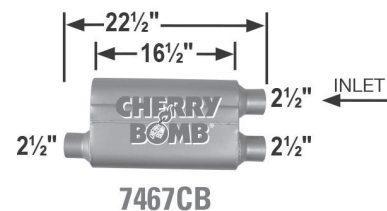

All Pro Mufflers are Directional Flow Design.
All neck sizes are inside diameter unless otherwise noted.

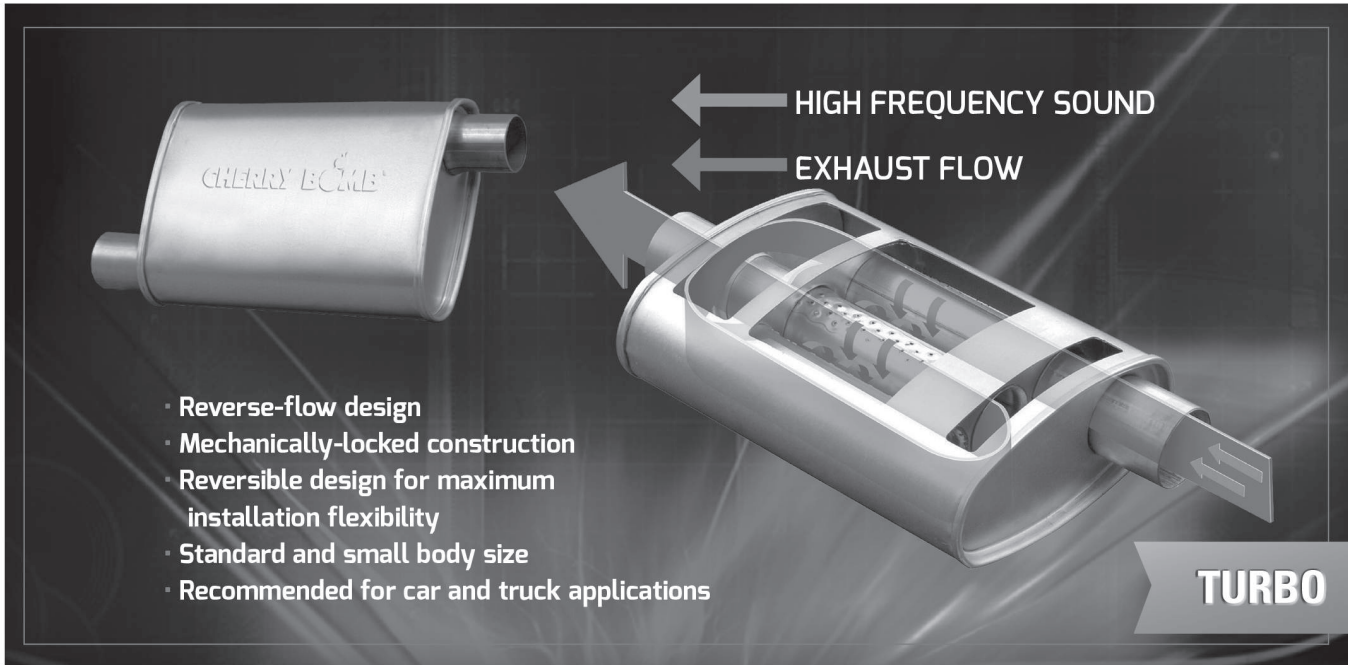

3 1/4" x 7 3/4" OVAL

OFFSET/CENTER

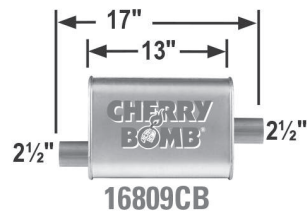
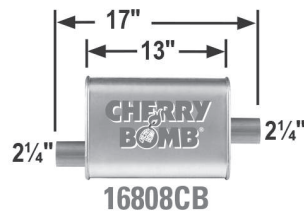
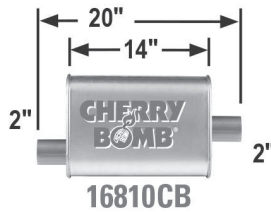
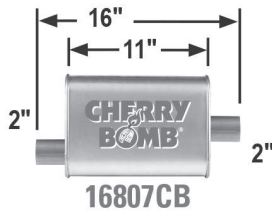

OFFSET/OFFSET

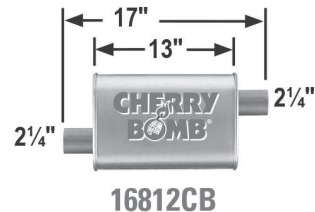
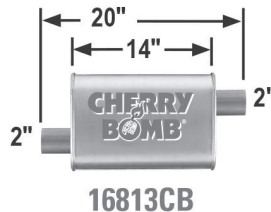
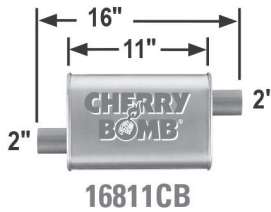

All Turbo Mufflers are Reversible.
 Turbo Mufflers are Double Wrapped.
 All neck sizes are inside diameter unless otherwise noted.

CHERRY BOMB® TURBO PERFORMANCE MUFFLERS



4 1/4" x 8 3/4" OVAL

OFFSET/CENTER

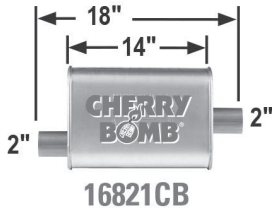

OFFSET/OFFSET

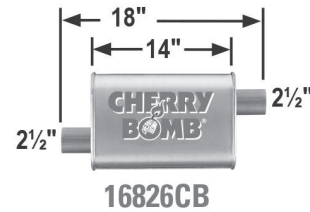
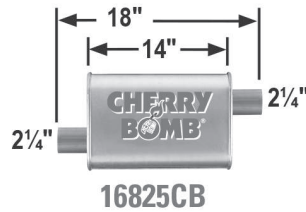
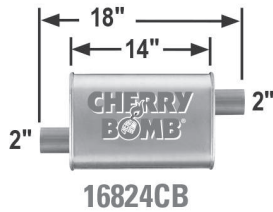

4 1/16" x 10 1/2" OVAL

OFFSET/CENTER

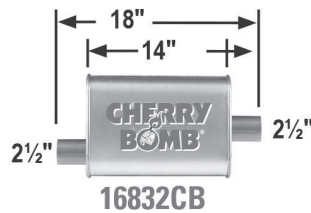
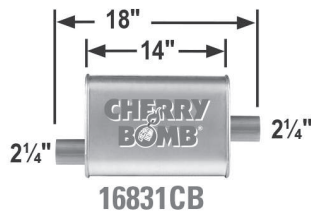

CENTER/DUAL

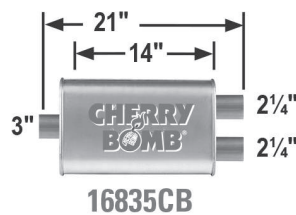
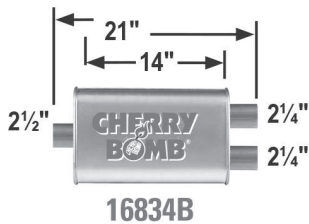

DUAL/DUAL

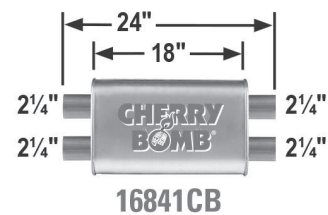

All Turbo Mufflers are Reversible.
Turbo Mufflers are Double Wrapped.
All neck sizes are inside diameter unless otherwise noted.

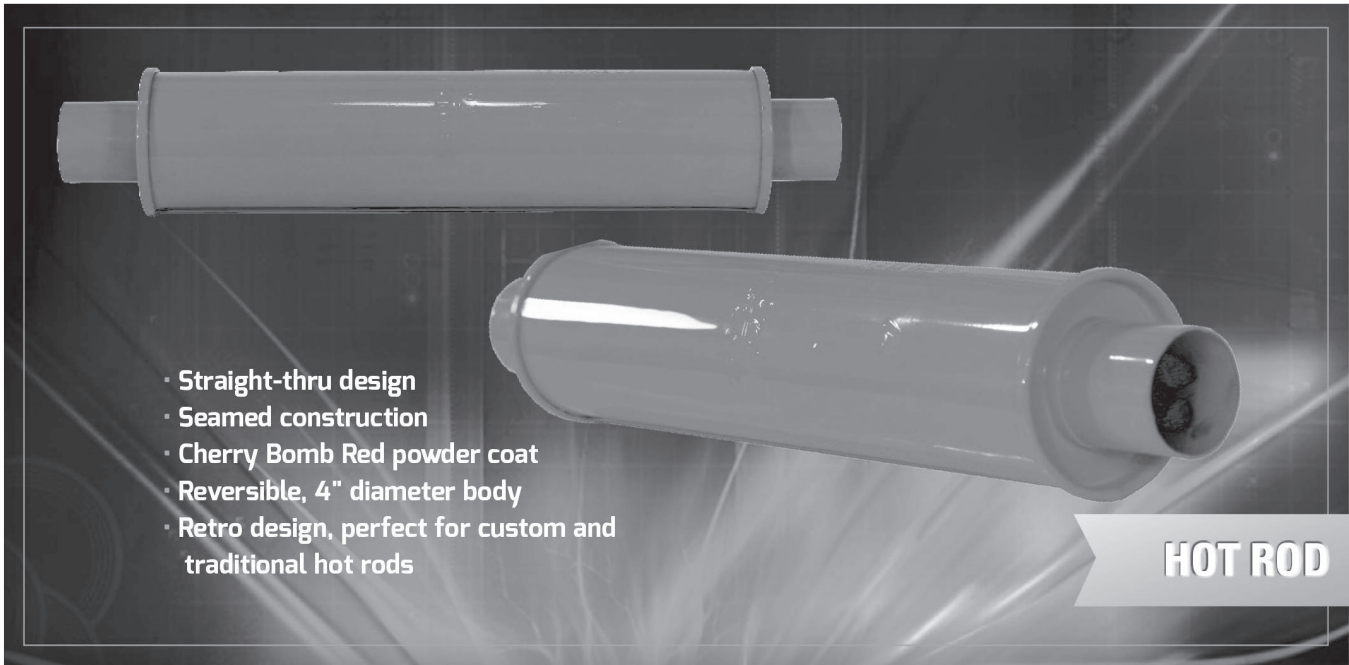

4" DIA. Traditional Hot Rod Muffler

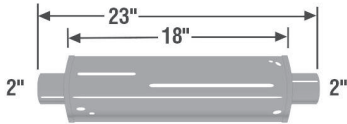

87886CB

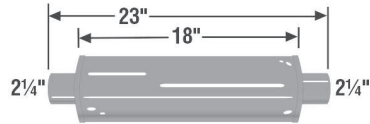

87885CB

All neck sizes are inside diameter unless otherwise noted.



X - Pipes



- Mandrel Bent
- Aluminized Steel
- Available in 3 Sizes

Universal X-Flow pipes increase horsepower and reduce noise levels. They work like an H-pipe balance tube, but give your vehicle better performance by increasing exhaust scavenging and balancing the exhaust pulses.

P/N	DIAMETER O.D.	WIDTH	LENGTH
429834CB	2 ¼"	8 ½"	18"
429835CB	2 ½"	8 ½"	18"
429836CB	3"	8 ½"	18"



UNIVERSAL Y-CONNECTORS



429825CB
429826CB

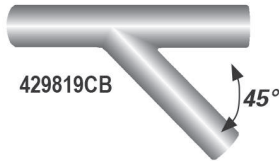

429819CB

- Aluminized Steel
- Available in 2 styles

P/N	OVERALL LENGTH	INLET DIAMETER	OUTLET DIAMETER	OUTLET CENTER TO CENTER DISTANCE
429825CB	13 ¼"	3" I.D.	Dual 2 ¼" O.D.	5 ½"
429826CB	13 ¼"	3" I.D.	Dual 2 ½" O.D.	6"
429819CB	12"	2 ¼" O.D.	Dual 2 ¼" O.D.	---



180° MANDREL U-BENDS

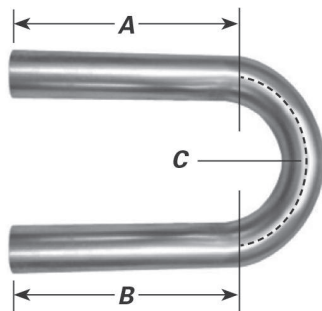

- Aluminized
- Mandrel Bent

P/N	INLET DIA. O.D.	OUTLET DIA. O.D.	LEG LENGTH (A)	LEG LENGTH (B)	CENTERLINE RADIUS (C)
320463CB	2"	2"	9"	9"	3 ½"
320464CB	2 ¼"	2 ¼"	8"	8"	4 ½"
320466CB	2 ½"	2 ½"	9"	9"	3 ½"
320465CB	2 ½"	2 ½"	8"	8"	4 ½"
320467CB	3"	3"	8"	8"	5 ½"



170° MANDREL ELBOWS

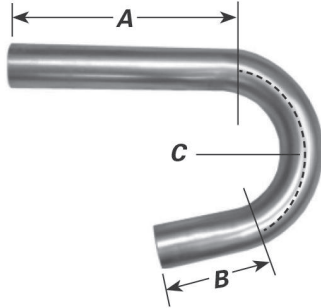

- Aluminized Steel
- Mandrel Bent

P/N	INLET DIA. O.D.	OUTLET DIA. O.D.	LEG LENGTH (A)	LEG LENGTH (B)	CENTERLINE RADIUS (C)
320474CB	2 ½"	2 ½"	14"	5"	4 ½"
320475CB	3"	3"	14"	5"	5"



90° MANDREL ELBOWS

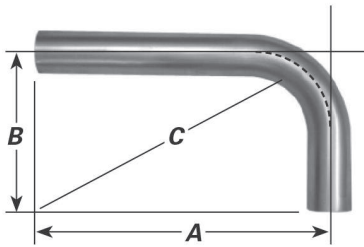

- Aluminized Steel
- Mandrel Bent

P/N	INLET DIAMETER	OUTLET DIAMETER	LEG LENGTH (A)	LEG LENGTH (B)	CENTERLINE RADIUS (C)
320441CB	2 ¼" O.D.	2 ¼" O.D.	14"	5"	4"
320442CB	2 ½" O.D.	2 ½" O.D.	14"	5"	4 ½"
320443CB	3" O.D.	3" O.D.	7"	7"	3 ½"
320444CB	3" O.D.	3" O.D.	14"	5"	5"
320445CB	3" O.D.	3" O.D.	7"	7"	5 ½"
320446CB	3 ½" O.D.	3 ½" O.D.	7"	7"	4"
320447CB	3 ½" I.D.	3 ½" I.D.	7"	7"	6"
320448CB	4" I.D.	4" I.D.	7"	7"	4 ½"
320449CB	4" I.D.	4" I.D.	7"	7"	6"
320450CB	4" I.D.	4" I.D.	7"	7"	8"
320451CB	5" I.D.	5" I.D.	7"	7"	6"



45° MANDREL ELBOWS

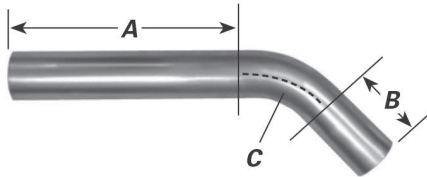

- Aluminized Steel
- Mandrel Bent

P/N	INLET DIAMETER	OUTLET DIAMETER	LEG LENGTH (A)	LEG LENGTH (B)	CENTERLINE RADIUS (C)
320452CB	2 ¼" O.D.	2 ¼" O.D.	14"	5"	4"
320453CB	2 ½" O.D.	2 ½" O.D.	14"	5"	4 ½"
320454CB	3" I.D.	3" I.D.	7"	7"	3 ½"
320455CB	3" O.D.	3" O.D.	14"	5"	5"
320456CB	3" I.D.	3" I.D.	7"	7"	5 ½"
320457CB	3 ½" I.D.	3 ½" O.D.	7"	7"	4"
320458CB	3 ½" I.D.	3 ½" I.D.	7"	7"	6"
320459CB	4" I.D.	4" I.D.	7"	7"	4 ½"
320460CB	4" I.D.	4" I.D.	7"	7"	6"
320461CB	4" I.D.	4" I.D.	7"	7"	8"



30° MANDREL ELBOWS

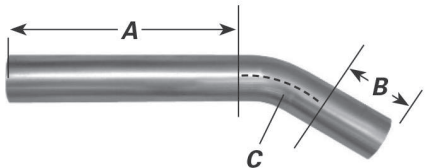

- Aluminized Steel
- Mandrel Bent

P/N	INLET DIA. O.D.	OUTLET DIA. O.D.	LEG LENGTH (A)	LEG LENGTH (B)	CENTERLINE RADIUS (C)
320462CB	3"	3"	14"	5"	5"

6" ROUND

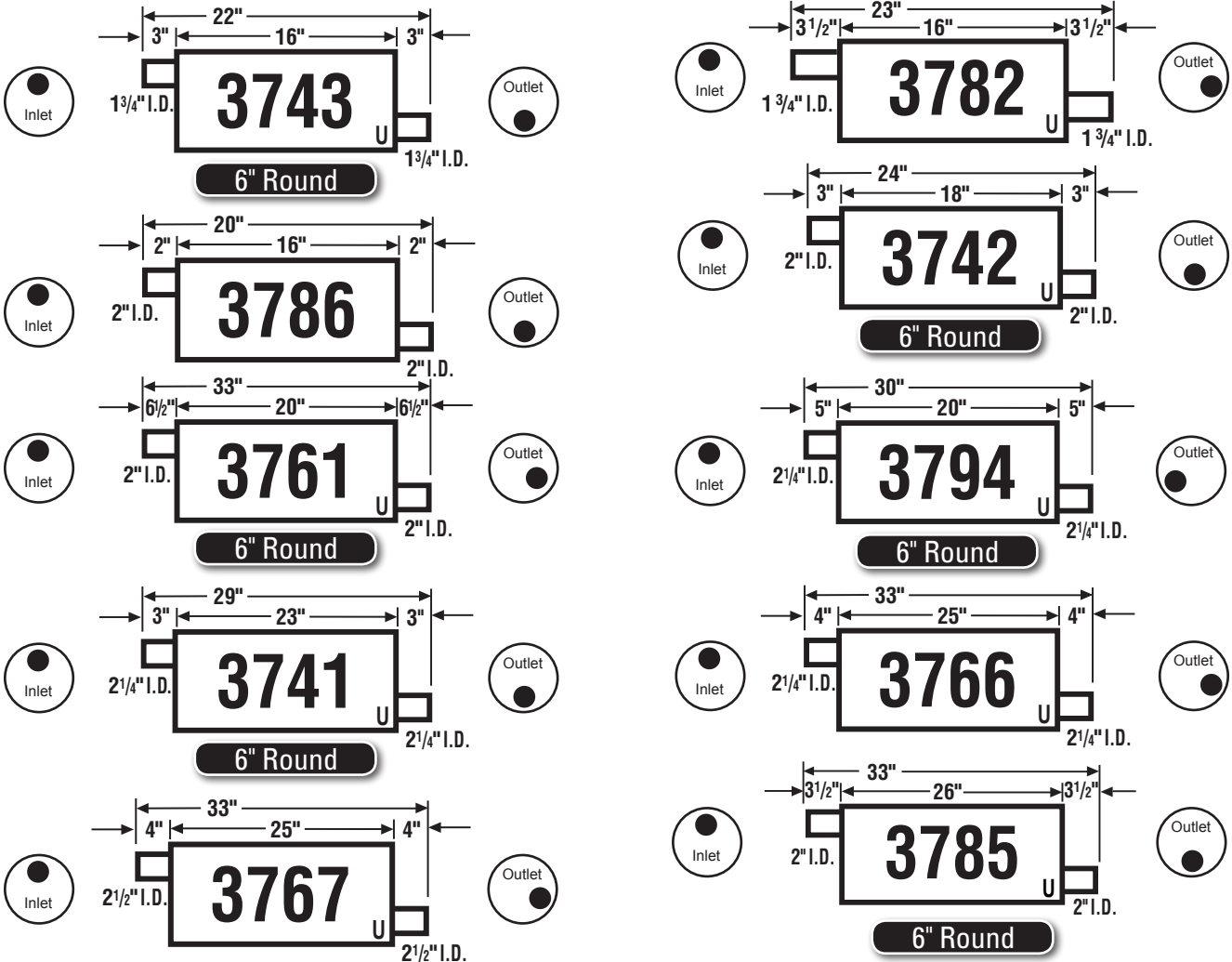

3 1/4" x 7 3/4"

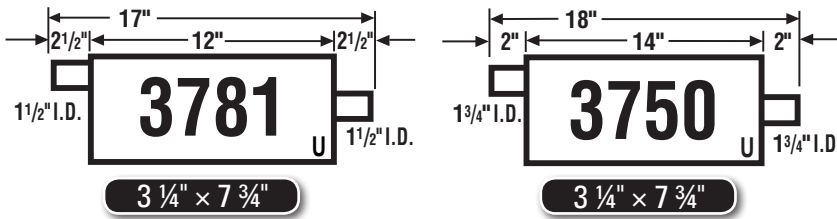

4 1/4" x 8 3/4"

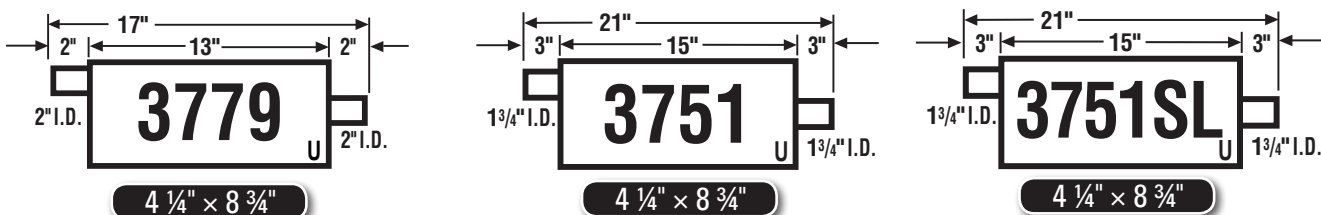

Tube & Baffle Design

U - Universal Muffler

ECONOMY MUFFLERS

Sorted first by Cross Section, then
Shell Length, then Inlet Diameter.

ENFORCER II®

4 1/4" x 8 3/4"

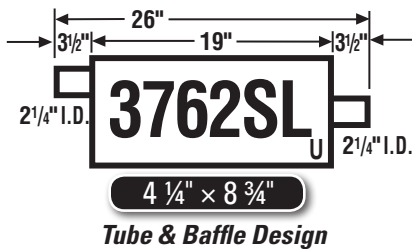
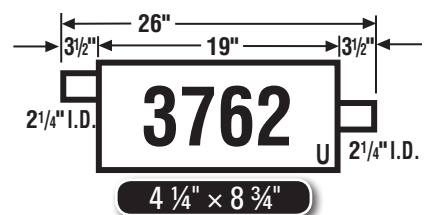
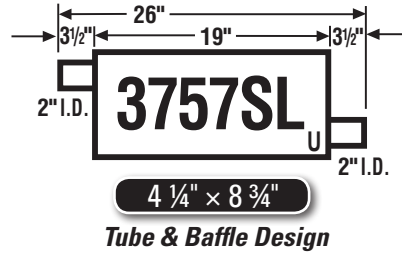
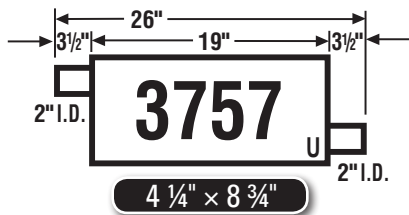
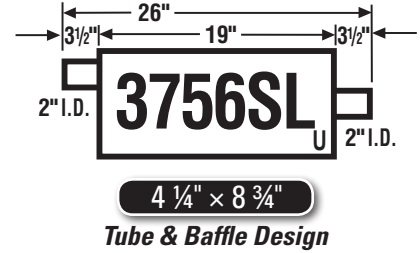
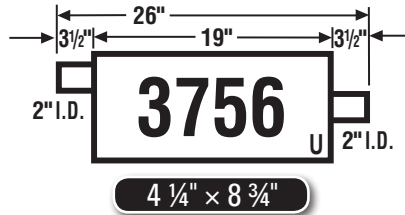
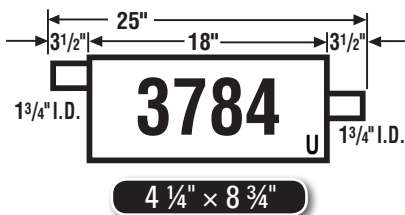
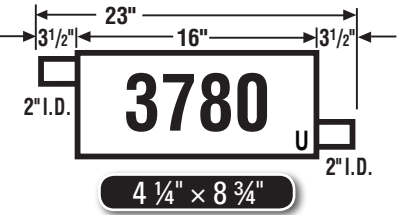
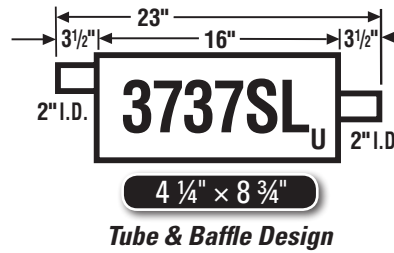
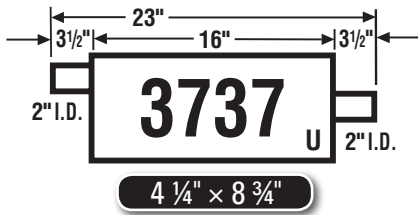
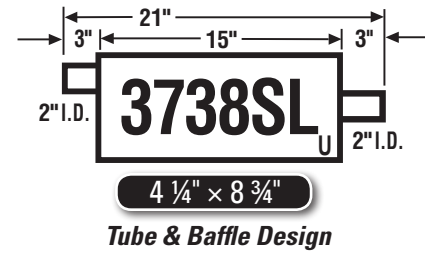
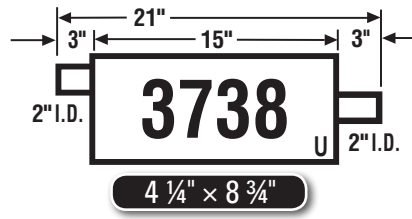
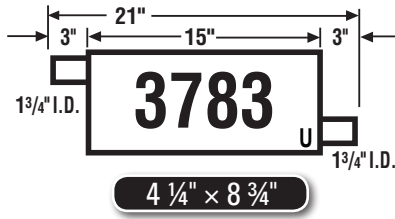

ENFORCER MUFFLERS BY DIMENSION

4 1/16" x 10 1/2"

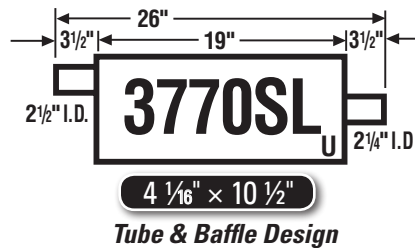
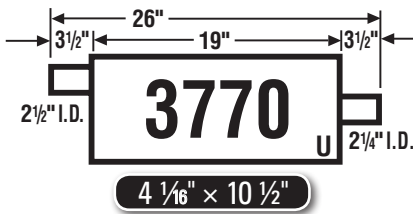
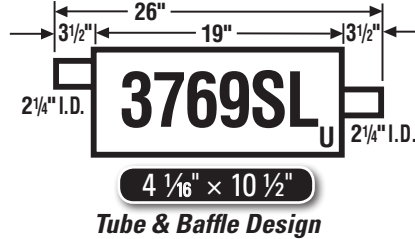
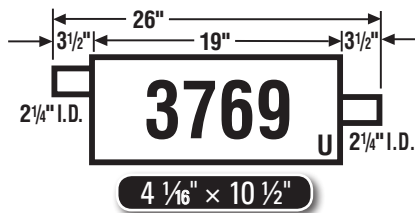
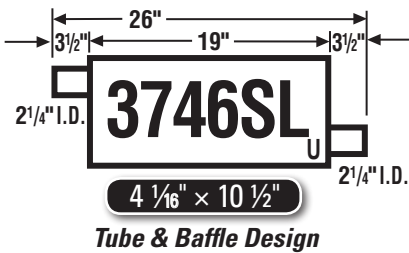
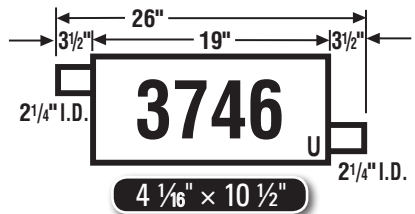
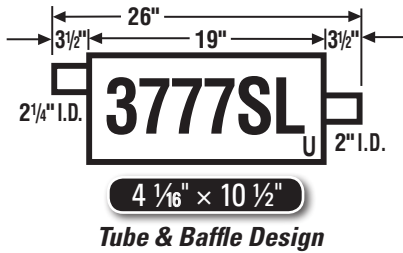
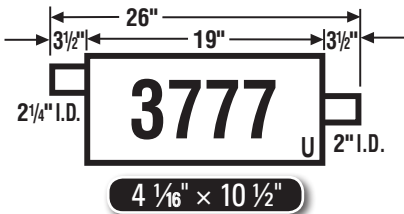
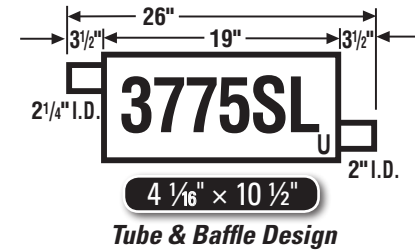
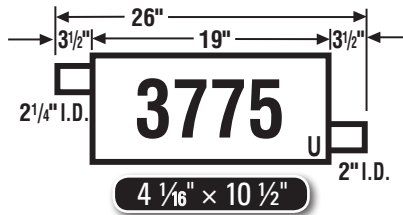
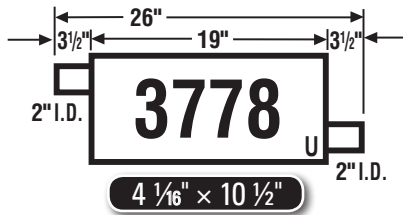
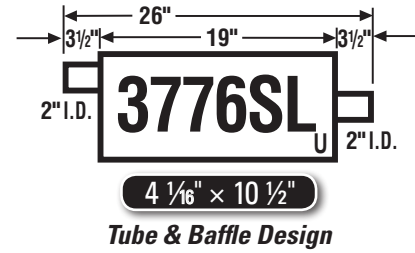
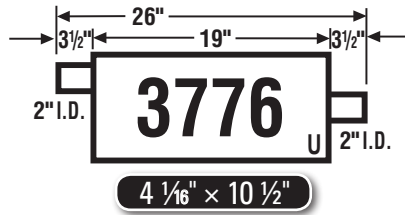
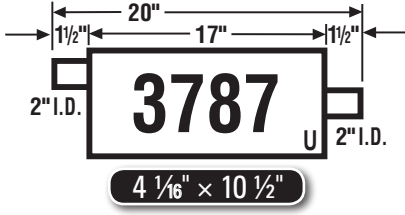

ECONOMY MUFFLERS *360° Welded Necks*

ENFORCER II®

7" x 9" 360° WELDED NECKS

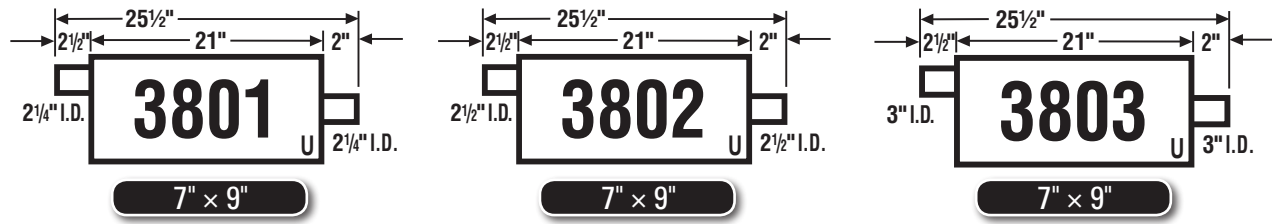

7" Round 360° WELDED NECKS

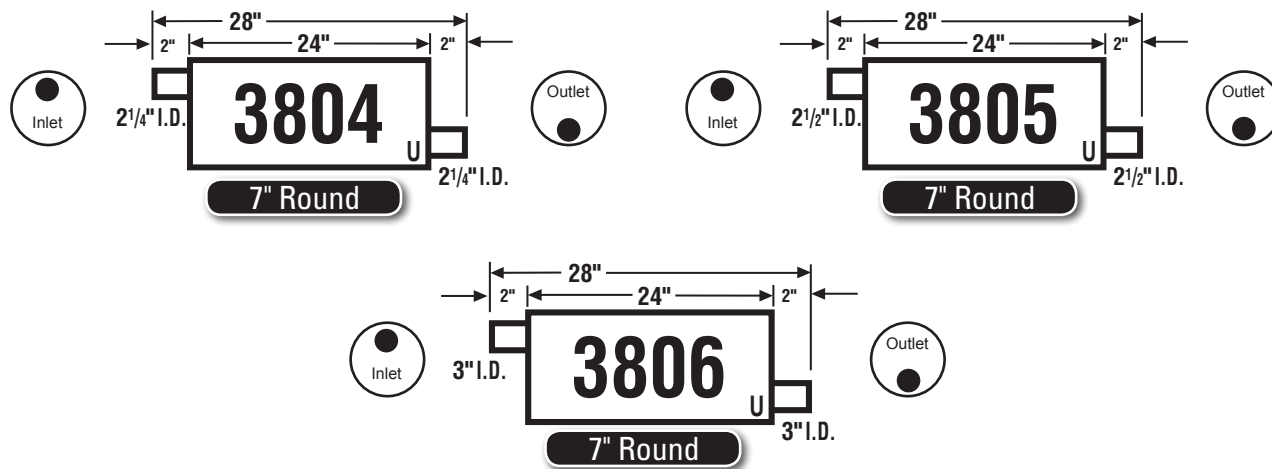

ENFORCER MUFFLERS BY DIMENSION

HEAVY DUTY TRUCK MUFFLERS

UNIVERSAL ALL WELDED ALUMINIZED HEAVY DUTY TRUCK MUFFLERS

- 100% Aluminized
- All Welded Construction
- Light Truck & Medium Duty Truck Applications

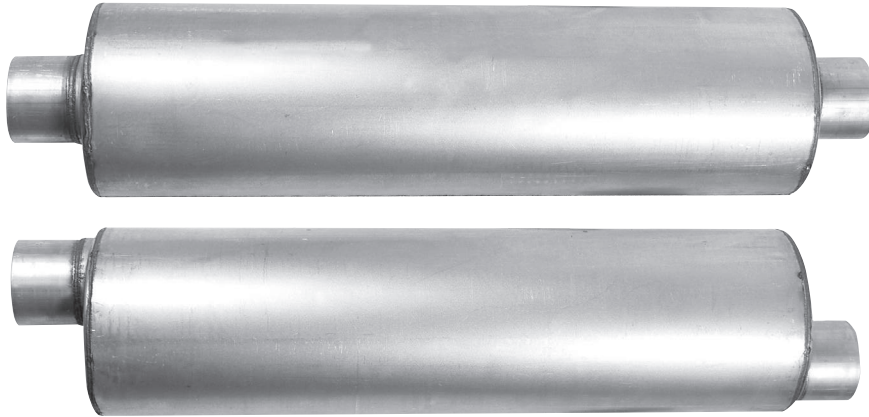

P/N	DIAMETER	SHELL LENGTH	OVERALL LENGTH	INLET/OUTLET	NECKS
4267	7" Round	26"	32"	Center/Center	2 ¼"
4268	7" Round	26"	32"	Center/Center	2 ½"
4269	7" Round	26"	32"	Center/Center	3"
4270	7" Round	26"	32"	Center/Center	3 ½"
4271	7" Round	26"	32"	Offset/Offset	2 ¼"
4272	7" Round	26"	32"	Offset/Offset	2 ½"
4273	7" Round	26"	32"	Offset/Offset	3"
4274	7" Round	26"	32"	Offset/Offset	3 ½"

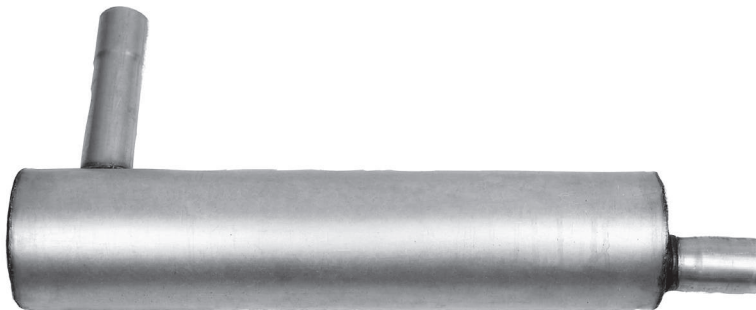

P/N	DIAMETER	SHELL LENGTH	OVERALL LENGTH	INLET LENGTH	INLET/OUTLET	NECKS
4290	4" Round	18"	21"	6"	Side/Offset	1 ½"

FLEX & REPAIR

EXHAUST PIPES

Sorted from Newest to
Oldest Application

CHRYSLER/DODGE/PLYMOUTH

121683

Inlet - 4 Bolt Flange
Outlet - 2 ½" O.D.
O.A.L. - 6"
Gasket 9289



- 00-05 DODGE/PLYM Neon 2.0L
- 96-07 CHRYS Town & Country,
DODGE Caravan Plymouth Voyager 3.3L & 3.8L
- 01-03 CHRYS Voyager 2.4L
- 01-07 DODGE Caravan 2.4L
- 01-10 CHRYS PT Cruiser 2.4L
- 05-08 CHRYS Pacifica 3.8L

With Inner Lock Flex (Inner Heat Shield)

121681

Inlet - 4 Bolt Flange
Outlet - 2 ¼" O.D.
O.A.L. - 8 ½"
Gasket 9289



- 95-06 CHRYS Cirrus, Sebring 2.4L & 2.5L
- 95-06 DODGE Stratus 2.0L, 2.4L & 2.5L
- 98-00 PLYM Breeze 2.0L & 2.4L

121682

Inlet - 4 Bolt Flange
Outlet - 2 ½" O.D.
O.A.L. - 5 ¾"
Gasket 9013



- 96-00 DODGE Caravan PLYM Voyager 3.0L

With Inner Lock Flex (Inner Heat Shield)

FORD/LINCOLN/MERCURY

121690

Inlet - 2 Bolt Flange
Outlet - 2" I.D.
O.A.L. - 5 7/16"
Gasket 9059



- 00-07 FORD Taurus 3.0L
- 96-98 MERC Sable 3.0L

With Inner Braid

121685

Inlet - 4 Bolt Flange
Outlet - 3" O.D.
O.A.L. - 9 ½"
Gasket 9245



- 87-95 FORD Truck E-Series
- 87-99 FORD Truck F-Series

123529

Inlet - 2 Bolt Flange
Outlet - 2" I.D.
O.A.L. - 32 ¼"
Gasket 9274

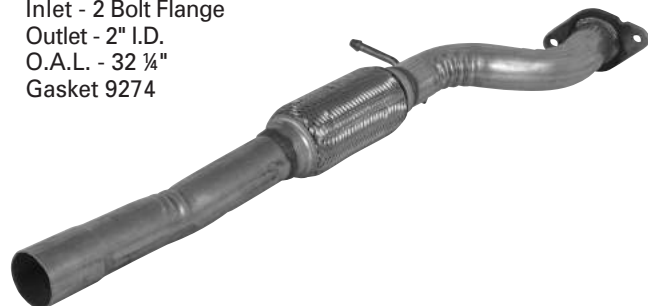

- 95-97 FORD Contour 2.0L
- 95-97 MERC Mystique 2.0L

FLEX & REPAIR EXHAUST PIPES

Sorted from Newest to
Oldest Application

GENERAL MOTORS

121691

Inlet - 3 Bolt Flange
Outlet - 2 3/32" I.D.
O.A.L. - 4"
Gasket 8403



02-05 CHEV/PONT Cavalier/Sunfire 2.2L (02 Code F)
05-10 CHEV Cobalt 2.2L
06-08 CHEV Cobalt 2.4L
06-11 CHEV HHR 2.2L & 2.4L
04-05 CHEV Malibu Classic 2.2L
02-04 OLDS Alero 2.2L

With Inner Braid Flex

07-09 PONTIAC G5 2.2L & 2.4L

02-05 PONTIAC Grand Am 2.2L

03-07 SATURN Ion 2.2L

06-07 SATURN Ion 2.4L

01-04 SATURN L100 L200 LW200 2.2L A/T

02-06 SATURN Vue 2.2L

121692

Inlet - 3 Bolt Flange
Outlet - 2 1/2" I.D.
O.A.L. - 7 1/2"
Gasket 8762

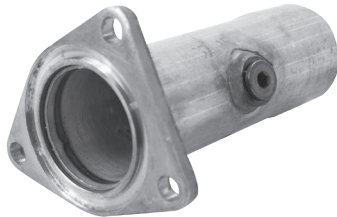

99-06 GM Truck 4.3L Engine Left

99-05 GM Truck 4.8L Engine Left

99-05 GM Truck 5.3L Engine Left

122621

Inlet - 2 Bolt Flange
Outlet - 2 3/16" O.D.
O.A.L. - 19 1/2"
Gasket 9088



97-04 BUICK Regal 3.8L

00-05 CHEV Impala, Monte Carlo 3.8L

98-99 OLDS Intrigue 3.8L

97-03 PONT Grand Prix 3.8L

With Inner Braid Flex

123532

Inlet - 2 Bolt Flange
Outlet - 2 1/4" O.D.
O.A.L. - 25"
Gasket 8762



98-03 CHEV Malibu 3.1L

99-04 OLDS Alero 3.4L

98-99 OLDS Cutlass 3.1L

99-04 PONT Grand Am 3.4L

With Inner Braid Flex

122624

Inlet - 2 Bolt Flange
Outlet - 2 1/4" O.D.
O.A.L. - 20 1/2"
Gasket 8762



97-04 BUICK Century 3.1L

00-04 CHEV Impala, Monte Carlo 3.4

97-01 CHEV Lumina 3.1L

97-04 PONT Grand Prix 3.1L

FLEX & REPAIR EXHAUST PIPES

Sorted from Newest to
Oldest Application

GENERAL MOTORS

121688

Inlet - 3 Bolt Flange
Outlet - 1 3/4" I.D.
O.A.L. - 4 1/2"
Gasket 8731



98-03 CHEV S10 Pickup 2.2L
98-03 GMC S15 Sonoma Pickup 2.2L

With Inner Braid Flex

122618

Inlet - 3 Bolt Flange
Outlet - 2" O.D.
O.A.L. - 23 1/2"
Gasket 9207



99-02 CHEV Cavalier 2.4L
99-00 CHEV Malibu 2.4L
99-01 PONT Grand Am 2.4L
99-02 PONT Sunfire 2.4L
99-01 OLDS Alero 2.4L

122622

Inlet - 2 Bolt Flange
Outlet - 2 1/4" O.D.
O.A.L. - 23 1/2"
Gasket 8762



2001 CHEV Venture 3.4L
2001 OLDS Silhouette 3.4L
2001 PONT Montana 3.4L

123530

Inlet - 2 Bolt Flange
Outlet - 2 1/4" O.D.
O.A.L. - 26 1/2"
Gasket 8762



97-00 CHEV Venture 3.4L
97-00 OLDS Silhouette 3.4L
99-00 PONT Montana 3.4L
97-98 PONT Transport 3.4L

122619

Inlet - 4 Bolt Flange
Outlet - 1 3/4" I.D.
O.A.L. - 21"
Gasket 9054



96-98 CHEV Cavalier / Pontiac Sunfire 2.4L
97-98 CHEV Malibu 2.4L

With Inner Braid Flex

122620

Inlet - 4 Bolt Flange
Outlet - 1 3/4" I.D.
O.A.L. - 22 1/2"
Gasket 9054



96-98 CHEV Cavalier / Pontiac Sunfire 2.4L
97-98 CHEV Malibu 2.4L

Without Inner Braid Flex

FLEX & REPAIR EXHAUST PIPES

Sorted from Newest to
Oldest Application

GENERAL MOTORS

121686

Inlet - 4 Bolt Flange
Outlet - 1 3/4" I.D.
O.A.L. - 4 1/4"
Gasket 9054



- 96-98 BUICK Skylark 2.4L
- 96-98 CHEV Cavalier, 97-98 Malibu 2.4L
- 96-98 OLDS Achieva 2.4L
- 96-98 PONT Grand Am, Sunfire 2.4L

With Inner Braid Flex

122625

Inlet - 4 Bolt Flange
Outlet - 1 3/4" I.D.
O.A.L. - 20"
Gasket 9054

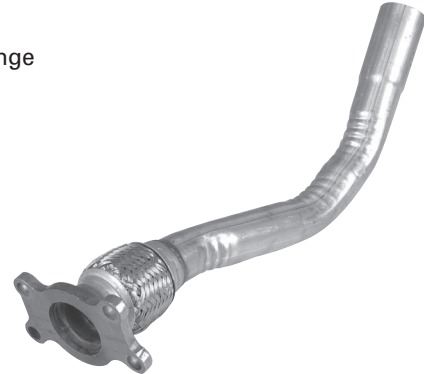

- 96-98 BUICK Skylark 2.4L AT
- 96-98 OLDS Achieva 2.4L AT
- 96-98 PONT Grand Am 2.4L AT

With Inner Braid Flex

121687

Inlet - 2 Bolt Flange
Outlet - 1 3/4" I.D.
O.A.L. - 4 5/8"
Gasket 9238



- 96-97 CHEV S10 Pickup 2.2L
- 96-97 GMC S15 Sonoma Pickup 2.2L
- 96-97 ISUZU Hombre 2.2L

With Inner Braid Flex

GEO/SUZUKI

122617

Inlet - 3 Bolt, Dual Inlet Flange
Outlet - 2 1/4" O.D.
O.A.L. - 21"
Gasket 8734

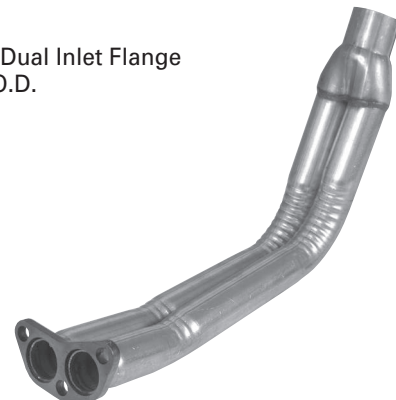

- 89-94 GEO Truck Tracker
- 89-94 SUZUKI Truck Tracker

TOYOTA

122630

Inlet - 3 Bolt, Dual Inlet Flange
Outlet - 2" O.D.
O.A.L. - 17 3/4"
Gasket 8749 (2 required)



- 91-95 TOYOTA Truck Previa

With Inner Braid Flex

VOLKSWAGEN

121689

Inlet - 6 Bolt, Dual Inlet Flange
Outlets - 1 3/4" I.D.
O.A.L. - 3 3/4"
Gasket 9213



- 87-92 VW Jetta & Golf 1.8L
- 98-01 VW Beetle 2.0L AEG Eng
- 99-01 VW Golf 2.0L AEG Eng
- 99-01 VW Jetta 2.0L AEG Eng

PROFESSIONAL INSTALLER PIPES

Sorted by Manufacturer, then Model,
then from Newest to Oldest Application

MAX FIT[®]

with Mandrel Options

- Max Fit consists of Universal, Direct Fits, and Dual Conversion Pipes.
- Max Fit Universal Pre-bent Pipe is designed especially for the professional installer who has a pipe bender. With Max Fit Pipes, all of the tough bends have already been made. Just turn the outlet end down to either side, or cut it off – depending on the application. Job times are cut in half, the fit is always perfect and there is never any wasted material.
- Save time, space and money with the Max Fit line.
- All Max Fit pipes are 100% aluminized and produced using heavy 14-16 gauge O.D. steel, and re-aluminized weld seams to prevent corrosion.
- Premium Mandrel-bent pipe options maximize gas flow and product life.
- Selected Mandrel pipes are also available in 409 stainless steel.

CHRYSLER CORP. – CHRYSLER/DODGE/JEEP/PLYMOUTH/RAM

MAX FIT

RH: **126656** (2 1/2")

LH: **126657** (2 1/2")



04-08 DODGE Dakota, All Engs., Club Cab & Quad Cab 131" WB; Dual Conversion

MANDREL

RH: **X6015** (2 1/2")

LH: **X6016** (2 1/2")

MAX FIT

RH: **126660** (2 1/2")

LH: **126661** (2 1/2")

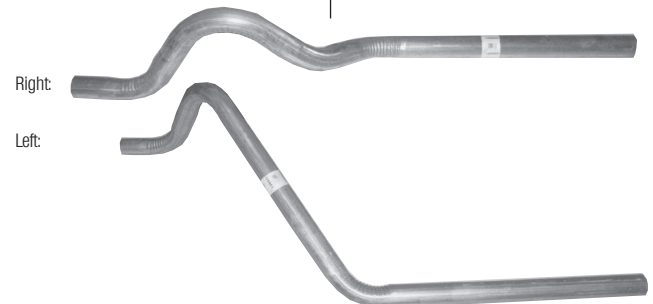

00-03 DODGE Dakota, All Engs., Club Cab & Quad Cab 112", 131" WB; Dual Conversion

MANDREL

RH: **X6018** (2 1/2")

LH: **X6019** (2 1/2")

MAX FIT

RH: **127596** (2 1/2")

LH: **127595** (2 1/2")



87-99 DODGE Dakota; 6 & 8 Cyl; All WB, Dual Conversion

MANDREL

RH: **X6005** (2 1/2")
112" & 131" WB

RH: **X7017** (2 1/2")
124" WB

LH: **X6006** (2 1/2")
112" & 131" WB

LH: **X7016** (2 1/2")
124" WB

MANDREL

RH: **X7041** (2 1/2")
w/OE DUALS

RH: **X7043** (2 1/2")
w/out OE DUALS

LH: **X8006** (2 1/2")
w/OE DUALS

LH: **X8007** (2 1/2")
w/out OE DUALS

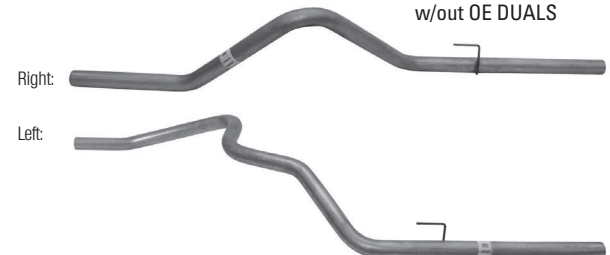

11-12 RAM 1500; 3.7L, 4.7L, 5.7L, Dual Conversion

09-10 DODGE RAM 1500; 3.7L, 4.7L, 5.7L, Dual Conversion

CHRYSLER CORP. - CHRYSLER/DODGE/JEEP/PLYMOUTH/RAM

MAX FIT

RH: **127694** (2 1/2")

LH: **128678** (2 1/2")

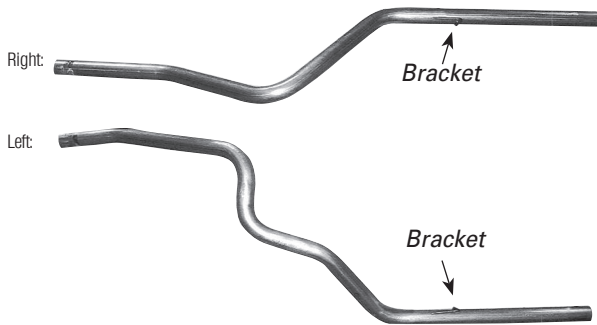

2009 DODGE Ram 1500, 5.7L Eng., 140.5" WB;
Dual Conversion

MAX FIT

RH: **128010** (2 1/4")

RH: **128012** (2 1/2")

LH: **128009** (2 1/4")

LH: **128011** (2 1/2")

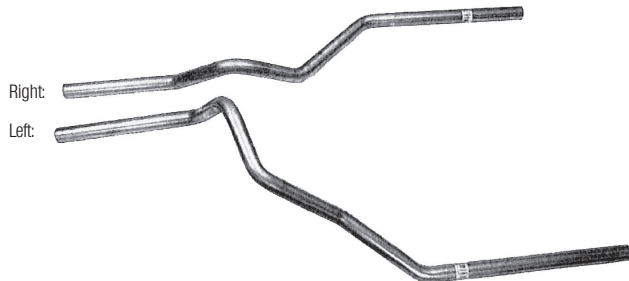

07-08 DODGE Ram Pickup

Pipe Also Fits Ford & Chev./GMC Trucks

MANDREL

RH: **X8010** (2 1/4")

RH: **X8012** (2 1/2")

RH: **XSX8012** (2 1/2")
STAINLESS STEEL

LH: **X8009** (2 1/4")

LH: **X8011** (2 1/2")

LH: **XSX8011** (2 1/2")
STAINLESS STEEL

MAX FIT

RH: **127688** (2 1/2")

LH: **127687** (2 1/2")

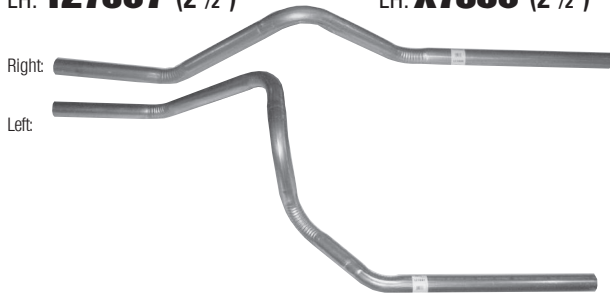

06-08 DODGE Ram 1500, 3.7L, 4.7L, 5.7L Eng., 120", 140"
WB; Dual Conversion

MANDREL

RH: **X7039** (2 1/2")

LH: **X7038** (2 1/2")

MAX FIT

RH: **127681** (2 1/4")

LH: **127682** (2 1/4")

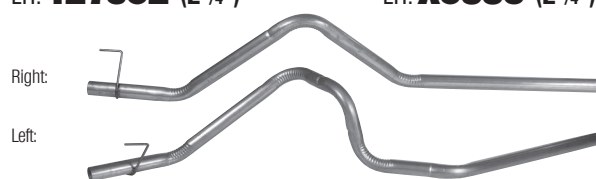

02-05 DODGE Ram 1500/2500 (Under 8800 lbs. GVW);
6 & 8 Cyl; 3.7L, 4.7L; 120" WB; Dual Conversion

MANDREL

RH: **X7033** (2 1/4")

LH: **X8005** (2 1/4")

CHRYSLER CORP. - CHRYSLER/DODGE/JEEP/PLYMOUTH/RAM

MAX FIT

RH: **127676** (2 1/4")

LH: **128677** (2 1/4")



02-05 DODGE Ram 1500/2500 (Under 8800 lbs. GVW);
6 & 8 Cyl; 3.7L, 4.7L Eng., 03-05 5.7L Hemi Eng.,
02-03 5.9L Eng.; 140" WB; Dual Conversion

MANDREL

RH: **X7022** (2 1/4")

LH: **X8004** (2 1/4")

MAX FIT

RH: **126102** (2 1/4")

RH: **126104** (2 1/2")

LH: **126103** (2 1/4")

LH: **126105** (2 1/2")



87-04 DODGE Ram 1500/2500; Dual Conversion

Pipe Also Fits Ford & Chev./GMC Trucks

MANDREL

RH: **X6102** (2 1/4")

RH: **X6104** (2 1/2")

LH: **X6103** (2 1/4")

LH: **X6105** (2 1/2")

MAX FIT

RH: **128594** (2 1/2")

LH: **128593** (2 1/2")

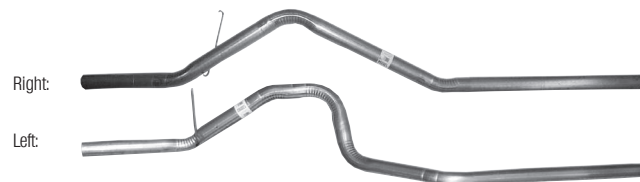

94-01 DODGE Ram 1500/2500 (Under 8800 lbs. GVW);
6 & 8 Cyl; 3.9L, 5.2L, 5.9L; 119", 135", 139" WB; Dual
Conversion

MANDREL

RH: **X7000** (2 1/2")
119" WB

RH: **X8002** (2 1/2")
135" WB

RH: **X7002** (2 1/2")
139" WB

LH: **X8000** (2 1/2")
119" WB

LH: **X8001** (2 1/2")
135" WB

LH: **X7001** (2 1/2")
139" WB

MAX FIT

RH: **128663** (2 1/4")

LH: **128662** (2 1/4")

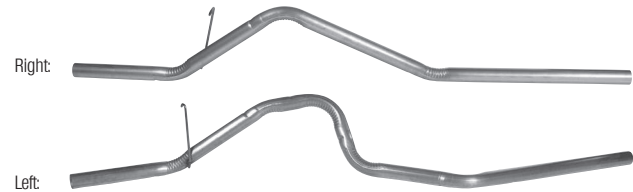

94-01 DODGE Ram 1500/2500 (Under 8800 lbs. GVW);
6 & 8 Cyl; 3.9L, 5.2L, 5.9L; 119", 135", 139" WB;
Dual Conversion

CHRYSLER CORP. - CHRYSLER/DODGE/JEEP/PLYMOUTH/RAM

**MANDREL
X6007 (3")**



88-01 DODGE Full Size, Light-Duty Trucks, 8 Cyl.

Pipe Also Fits Chev./GMC, & Ford Full-Sized Light-Duty Trucks

**MANDREL
X4001 (2 1/4")**



97-06 JEEP Wrangler, 4-6 Cyl. All Eng

**MANDREL
X5008 (2 1/2")**



99-04 JEEP Grand Cherokee, 8 Cyl., 4.7L

**MANDREL
X4000 (2 1/4")**



91-95 JEEP Wrangler, 4-6 Cyl. All Eng

FORD MOTOR CO. - FORD/LINCOLN/MERCURY

MAX FIT

RH: **126555 (2")**

LH: **126582 (2")**

Right:



Left:



83-88 FORD Crown Victoria Sedan

80-82 FORD LTD Sedan

82-88 LINC Town Car

80-83 LINC Continental, Mark VI

83-88 MERC Grand Marquis Sedan

80-82 MERC Marquis Sedan

MAX FIT

125639 (2 1/4")



91-92 FORD Explorer; Resonator Eliminator

Pipe Also Fits Mazda Trucks

PROFESSIONAL INSTALLER PIPES

Sorted by Manufacturer, then Model,
then from Newest to Oldest Application

MAX FIT[®]

with Mandrel Options

FORD MOTOR CO. – FORD/LINCOLN/MERCURY

MAX FIT

RH: **128010** (2 1/4")
RH: **128012** (2 1/2")

LH: **128009** (2 1/4")
LH: **128011** (2 1/2")

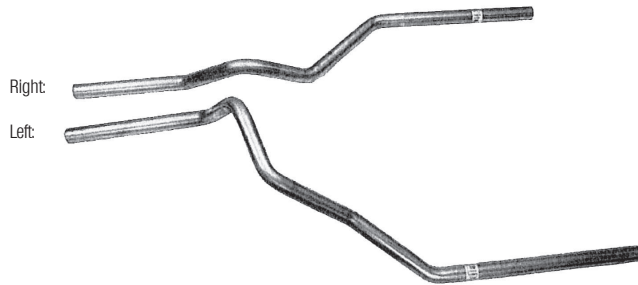

07-11 FORD F-Series Pickup

Pipe Also Fits Dodge & Chev./GMC Trucks

MANDREL

RH: **X8010** (2 1/4")
RH: **X8012** (2 1/2")
RH: **XSX8012** (2 1/2")
STAINLESS STEEL

LH: **X8009** (2 1/4")
LH: **X8011** (2 1/2")
LH: **XSX8011** (2 1/2")
STAINLESS STEEL

MAX FIT

RH: **127686** (2 1/4")
LH: **127685** (2 1/4")

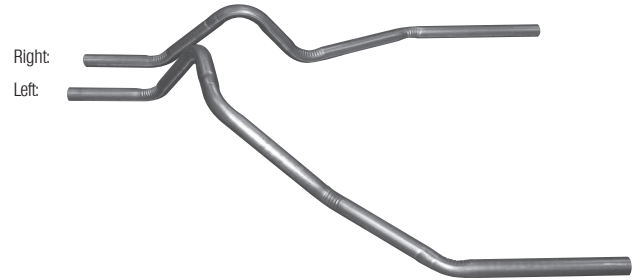

04-08 FORD F150 (New Body Style); 8 Cyl; 4.6L, 5.4L; All WB; Dual Conversion
06-08 LINC Mark LT; 8 Cyl; 5.4L, 139" WB; Dual Conversion

MANDREL

RH: **X7035** (2 1/4")
LH: **X7034** (2 1/4")

MAX FIT

RH: **127666** (2 1/4")
LH: **128667** (2 1/4")

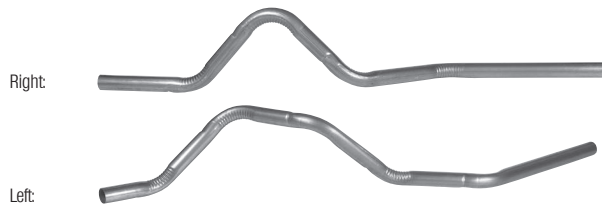

02-03 FORD F150/F250 (Under 8800 lbs. GVW); 6 & 8 Cyl; 4.2L, 4.6L, 5.4L; 120", 139" WB; Dual Conversion

MANDREL

RH: **X7021** (2 1/4")
LH: **X8003** (2 1/4")

MANDREL

X5014 (4")



99-03 FORD F250/F350 Super Duty, 7.3L Diesel Engine

MAX FIT

RH: **126102** (2 1/4")
RH: **126104** (2 1/2")
LH: **126103** (2 1/4")
LH: **126105** (2 1/2")

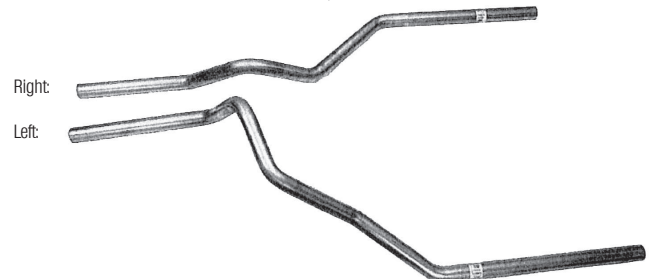

87-02 FORD F Series; Dual Conversion

Pipe Also Fits Dodge & Chev./GMC Trucks

MANDREL

RH: **X6102** (2 1/4")
RH: **X6104** (2 1/2")
LH: **X6103** (2 1/4")
LH: **X6105** (2 1/2")

FORD MOTOR CO. - FORD/LINCOLN/MERCURY

MAX FIT

RH: **127657** (2 1/4")
RH: **127633** (2 1/2")

LH: **127656** (2 1/4")
LH: **127632** (2 1/2")

MANDREL

RH: **X7012** (2 1/2")

LH: **X7011** (2 1/2")

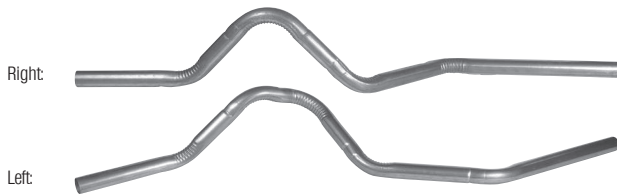

97-01 FORD F150/F250 (Under 8800 lbs. GVW); 6 & 8 Cyl;
4.2L, 4.6L, 5.4L; 120", 139" WB; Dual Conversion

MAX FIT

RH: **126653** (2 1/2")

LH: **127689** (2 1/2")

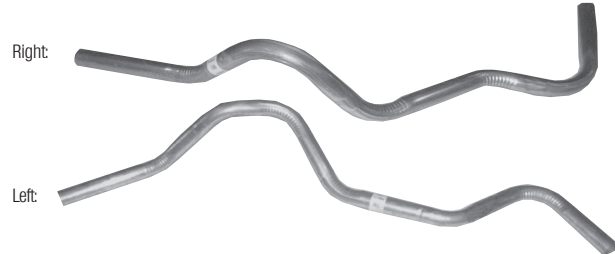

97-01 FORD F150/F250 (Under 8800 lbs. GVW); 4.2L,
4.6L, 5.4L Eng., 120", 139" WBs with 90 Degree
Side Exit; Dual Conversion

MANDREL

X6007 (3")



88-97 FORD Full Size, Light-Duty Trucks, 8 Cyl.

Pipes Also Fit Chev./GMC & Dodge Full-Sized Light Duty Trucks

MAX FIT

125568 (2 1/4")



83-86 FORD F Series; 6 & 8 Cyl.

87-97 FORD F350; 6 Cyl.

MAX FIT

RH: **127580** (2 1/4")
RH: **127612** (2 1/2")

LH: **127581** (2 1/4")
LH: **128611** (2 1/2")

MANDREL

RH: **X7014** (2 1/2")

LH: **X7013** (2 1/2")



87-96 FORD F150/F250 (Under 8500 lbs. GVW); 6 & 8 Cyl;
4.9L, 5.0L, 5.8L; 116", 133", 139" WB;
Dual Conversion

MAX FIT

RH: **126301** (2 1/4")
RH: **126303** (2 1/2")

LH: **126302** (2 1/4")
LH: **126304** (2 1/2")

MANDREL

RH: **X6301** (3")

LH: **X6302** (3")

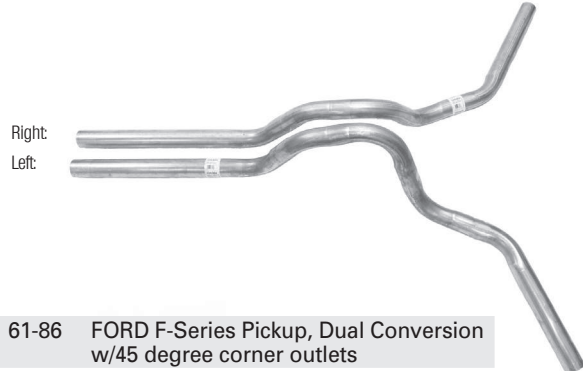

61-86 FORD F-Series Pickup, Dual Conversion
w/45 degree corner outlets

Pipes Also Fit Chev./GMC Trucks

PROFESSIONAL INSTALLER PIPES

Sorted by Manufacturer, then Model,
then from Newest to Oldest Application

MAX FIT[®]

with Mandrel Options

FORD MOTOR CO. – FORD/LINCOLN/MERCURY

MAX FIT

RH: **125636** (2 1/4")

LH: **125637** (2 1/4")

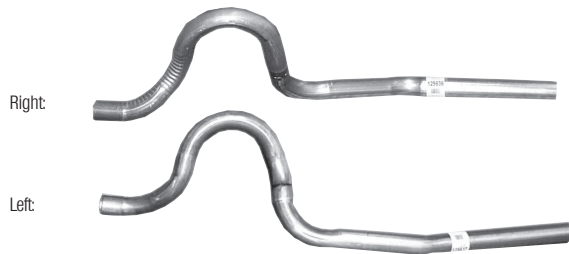

84-04 FORD Mustang, GT, LX

MANDREL

RH: **X5123** (2 1/2")

LH: **X5122** (2 1/2")



96-98 FORD Mustang

MANDREL

RH: **X5001** (2 1/2")
w/STAINLESS STEEL TIP

LH: **X5000** (2 1/2")
w/STAINLESS STEEL TIP



96-97 FORD Mustang, GT, Cobra 8Cyl, 4.6L

87-93 FORD Mustang, LX, Cobra 5.0L

94-95 FORD Mustang, GT, Cobra 8Cyl, 5.0L

1986 FORD Mustang, GT 5.0L

MANDREL

RH: **X5003** (2 1/2")

LH: **X5002** (2 1/2")



87-93 FORD Mustang, GT 8 Cyl, 5.0L

MAX FIT

RH: **126615** (2")

LH: **127614** (2")



93-00 FORD Ranger; 4 & 6 Cyl; 2.3L, 2.5L, 3.0L, 4.0L;
All WB; Dual Conversion

Pipes Also Fit Mazda B-Series Trucks

MANDREL

RH: **X6002** (2 1/4")

LH: **X6001** (2 1/4")

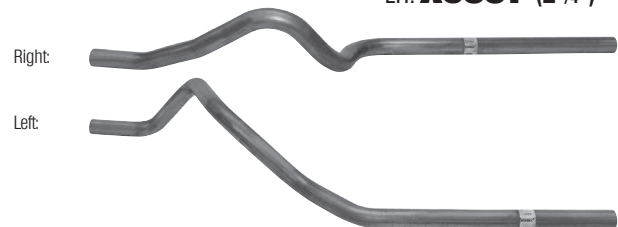

98-00 FORD Ranger 4-6 Cyl, 2.5L, 3.0L, 4.0L; 112" & 126"
WB

93-97 FORD Ranger 4-6 Cyl, 2.5L, 3.0L, 4.0L; 108" & 125"
WB

FORD MOTOR CO. - FORD/LINCOLN/MERCURY

MAX FIT

125564 (2")



83-92 FORD Ranger; 4 & 6 Cyl.

MAX FIT

128551 (2")



84-94 FORD Tempo
84-94 MERC Topaz

GENERAL MOTORS - BUICK/CHEV/GMC/OLDSMOBILE/PONTIAC

MAX FIT

126546 (2 1/4")



88-90 GM Century, 6000 Sedan; 4 Cyl.
85-90 GM Century, Cutlass Ciera; 6 Cyl.
88-89 CHEV Celebrity Sedan; 4 Cyl.
86-89 CHEV Celebrity Eurosport; 6 Cyl.
88-90 OLDS Cutlass Ciera Sedan; 4 Cyl.
86-90 PONT 6000 S/E, STE; 6 Cyl.

MAX FIT

126558 (2")



86-87 BUICK Century; 4 Cyl.
86-87 CHEV Celebrity; 4 Cyl.
86-87 OLDS Cutlass Ciera; 4 Cyl.
86-87 PONT 6000; 4 Cyl.

MAX FIT

126543 (2")



86-87 GM Century, 6000 Sedan, Cutlass Ciera; 4 Cyl.
84-86 BUICK Century; 6 Cyl.
86-87 CHEV Celebrity; 4 Cyl.
84-86 CHEV Celebrity Eurosport; 6 Cyl.
84-86 OLDS Cutlass Ciera; 6 Cyl.
83-86 PONT 6000, 6000 STE, Sedan; 6 Cyl.

MAX FIT

127553 (2")



78-87 BUICK Century, Regal
78-83 CHEV Chevelle, Malibu, Monte Carlo
78-87 OLDS Cutlass, Vista Cruiser
78-87 PONT Bonneville, Grand AM, Grand Prix, LeMans

MAX FIT

RH: **126640** (2 1/4")

LH: **126641** (2 1/4")

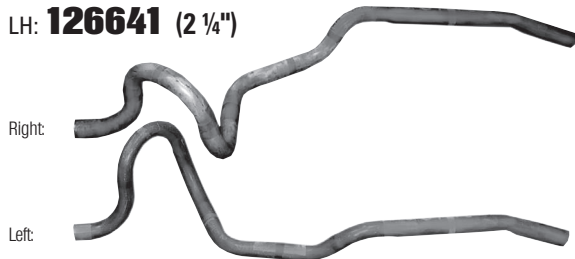

94-96 BUICK Roadmaster Sedan; Resonator Eliminator
94-96 CHEV Caprice Sedan; Resonator Eliminator

MANDREL

RH: **X5034** (2 1/2")

LH: **X5033** (2 1/2")



64-77 GM Chevelle, Skylark, Cutlass, Lemans,
Dual Conversion

GENERAL MOTORS - BUICK/CHEV/GMC/OLDSMOBILE/PONTIAC

MAX FIT

RH: **126664** (2 1/4") w/out last 2 bends

RH: **126666** (2 1/2") w/out last 2 bends

LH: **126663** (2 1/4") w/out last 2 bends

LH: **126665** (2 1/2") w/out last bend

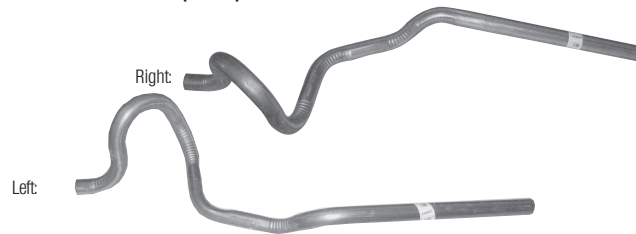

94-96 BUICK/CHEV Roadmaster, Caprice, Impala SS

MAX FIT

RH: **126563** (2")

LH: **126508** (2")



77-90 GM Full Size
64-72 GM Mid Size

MANDREL X5500 (3")



96-02 CHEV Camaro/Firebird 8 Cyl, 350, 5.7L
1995 CHEV Camaro/Firebird 8 Cyl, 350, 5.7L California Only

MAX FIT

126554 (2")



77-85 BUICK Full Size
77-90 CAD Full Size
77-88 CHEV Full Size
77-85 OLDS Full Size
77-86 PONT Full Size

MAX FIT

126642 (2 1/4")



82-92 CHEV/PONT Camaro, Firebird; 8 Cyl.

MANDREL X6501 (2 1/2")



RH: **X3000** (2 1/2")

LH: **X3001** (2 1/2")

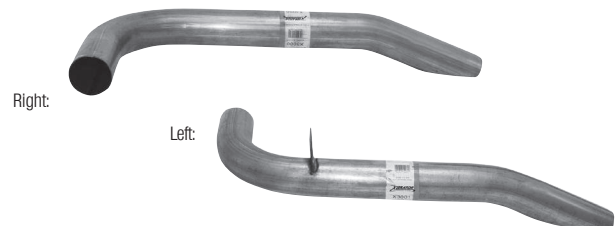

90-92 CHEV Camaro/Firebird 8Cyl, 305 F, 5.0L with one (1) Catalytic Converter
88-92 CHEV Camaro/Firebird 8Cyl, 305 E, 5.0L
85-92 CHEV Camaro/Firebird 6Cyl, 2.8L & 3.1L with one (1) Tailpipes exiting on driver and passenger sides
83-87 CHEV Camaro/Firebird 8Cyl, 305 H, 5.0L excluding Canadian models w/out air tube to converter

GENERAL MOTORS - BUICK/CHEV/GMC/OLDSMOBILE/PONTIAC

**MANDREL
X6500 (3")**



89-92 CHEV Camaro/Firebird 8 Cyl, 350 F, 5.0L with two (2) catalytic converters

**MAX FIT
125640 (2 1/4")**

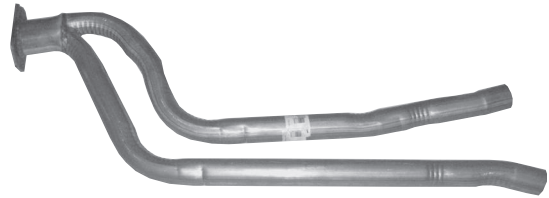

83-88 CHEV Monte Carlo SS 5.0L, VIN 7 & G

MAX FIT

RH: **126688 (2 1/4")**

LH: **126687 (2 1/4")**

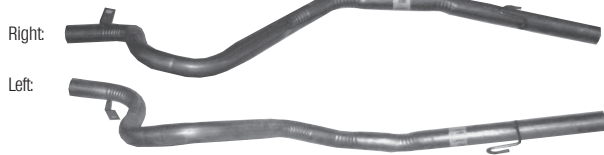

83-88 CHEV Monte Carlo SS 5.0L, VIN 7 & G

MAX FIT

RH: **126667 (2 1/2")**

LH: **127695 (2 1/2")**



MANDREL

RH: **X6020 (2 1/2")**

LH: **X7044 (2 1/2")**

MAX FIT

RH: **128010 (2 1/4")**

RH: **128012 (2 1/2")**

LH: **128009 (2 1/4")**

LH: **128011 (2 1/2")**

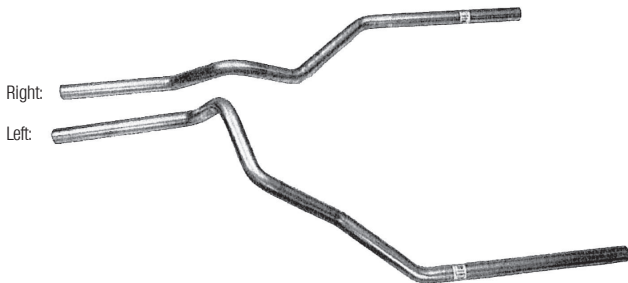

07-11 GM Truck Full Size Pickup

Pipe Also Fits Dodge & Ford Trucks

MANDREL

RH: **X8010 (2 1/4")**

RH: **X8012 (2 1/2")**

RH: **XSX8012 (2 1/2")**
STAINLESS STEEL

LH: **X8009 (2 1/4")**

LH: **X8011 (2 1/2")**

LH: **XSX8011 (2 1/2")**
STAINLESS STEEL

MAX FIT

RH: **127669 (2 1/4")**

LH: **127668 (2 1/4")**



99-08 CHEV/GMC Truck C, K1500, 2500 (99 New Body Style); 6 & 8 Cyl; 4.3L, 4.8L, 5.3L; 1/2 & 3/4 Ton; 119", 133", 143.5" WB; Dual Conversion

GENERAL MOTORS – BUICK/CHEV/GMC/OLDSMOBILE/PONTIAC

MAX FIT

RH: **127671** (2 ½")

LH: **127670** (2 ½")

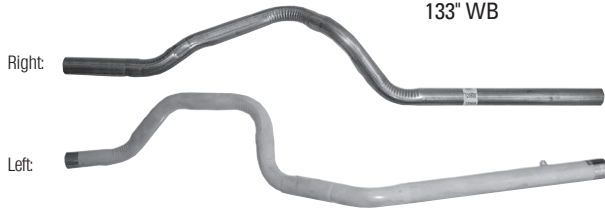

01-06 CHEV/GMC 1500, 2500, 3500HD 6.0L, 8.1L

99-08 CHEV/GMC Truck C, K10, 20, 1500, 2500 (99 New Body Style); 6 & 8 Cyl; 4.3L, 4.8L, 5.3L; ½ & ¾ Ton; 119" WB; 133", 143" WB, 143.5" WB; Dual Conversion

MANDREL

RH: **X6014** (2 ½")
119" & 143.5" WB
RH: **X7028** (2 ½")
133" WB

LH: **X6013** (2 ½")
119" & 143.5" WB
LH: **X7027** (2 ½")
133" WB

MAX FIT

RH: **126102** (2 ¼")
RH: **126104** (2 ½")

LH: **126103** (2 ¼")
LH: **126105** (2 ½")



87-02 CHEV./GMC C, K Series; Dual Conversion

Pipe Also Fits Dodge & Ford Trucks

MANDREL

RH: **X6102** (2 ¼")
RH: **X6104** (2 ½")

LH: **X6103** (2 ¼")
LH: **X6105** (2 ½")

MAX FIT

126584 (3")



88-99 CHEV/GMC Truck, Full Size, Light Duty Trucks (99 Pickups w/ Old Body Style); 8 Cyl; 5.7L Eng; (Exclude 88-90 Suburban)

MANDREL

X6007 (3")



01-06 CHEV/GMC C, K1500, 2500, 3500HD; 6.0L, 8.1L

88-99 CHEV/GMC Truck, Full Size, Light Duty Trucks (99 Pickups w/ Old Body Style); 8 Cyl; 5.7L Eng; (Exclude 88-90 Suburban)

MAX FIT

RH: **127665** (2 ½")

LH: **127664** (2 ½")

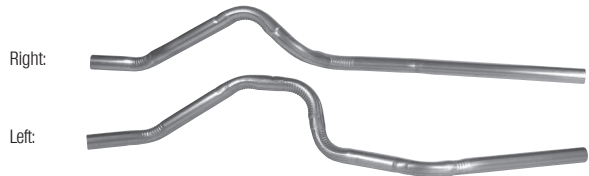

96-99 CHEV/GMC Truck C, K1500, 2500 (Under 8600 lbs. GVW), (99 w/ Old Body Style); 8 Cyl; 350, 5.7L Eng; 117.5", 131.5", 141.5" WB; Dual Conversion

MANDREL

RH: **X7024** (2 ½")
117.5" & 141.5" WB
RH: **X7026** (2 ½")
131.5" WB

LH: **X7023** (2 ½")
117.5" & 141.5" WB
LH: **X7025** (2 ½")
131.5" WB

GENERAL MOTORS - BUICK/CHEV/GMC/OLDSMOBILE/PONTIAC

MANDREL

RH: **X8101** (2 1/2")

LH: **X8102** (2 1/2")



88-98 CHEV/GMC Full-Size Pick-up; Dual Conversion

MAX FIT

RH: **127675** (2 1/2")

LH: **127674** (2 1/2")

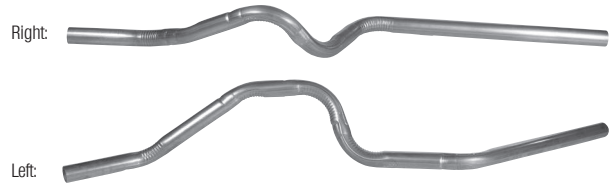

94-95 CHEV/GMC Truck C, K10, 20, 1500, 2500; 6 & 8 Cyl;
262, 4.3L, 305, 5.0L, 350, 5.7L; 117", 131", 141" WB;
Dual Conversion

MANDREL

RH: **X7030** (2 1/2")
117" & 141" WB

RH: **X7032** (2 1/2")
131" WB

LH: **X7029** (2 1/2")
117" & 141" WB

LH: **X7031** (2 1/2")
131" WB

MAX FIT

RH: **127576** (2 1/4")

RH: **127578** (2 1/2")

LH: **127577** (2 1/4")

LH: **127579** (2 1/2")



88-95 CHEV/GMC C, K-Series Truck; Dual Conversion

MAX FIT

OUTER: **125566** (2 1/4")

INNER: **125565** (2 1/4")

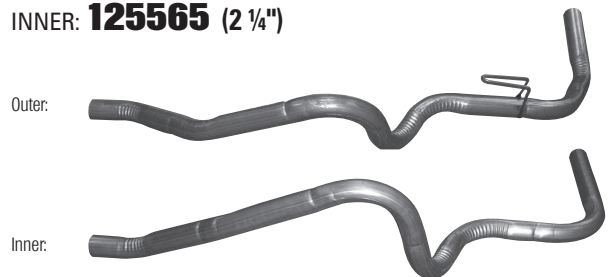

88-95 CHEV/GMC Truck C, K Series; 6 & 8 Cyl.

GENERAL MOTORS – BUICK/CHEV/GMC/OLDSMOBILE/PONTIAC

MAX FIT

RH: **127602** (2 ¼")
RH: **127604** (2 ½")

LH: **127601** (2 ¼")
LH: **127603** (2 ½")

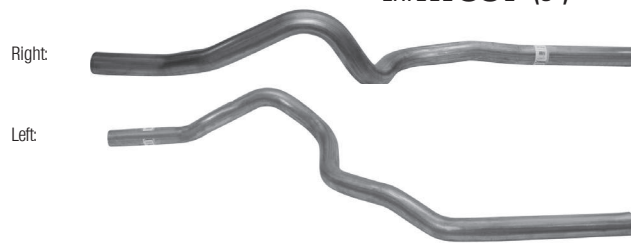

88-93 CHEV/GMC Truck C, K10, 20, 1500, 2500; 8 Cyl;
350, 5.7L; 117", 131", 141" WB (93 w/ OE Converter
Clamped to Front Pipe); Dual Conversion

MANDREL

RH: **X7004** (2 ¼")
RH: **X7006** (2 ½")
RH: **X7008** (3")

LH: **X7003** (2 ¼")
LH: **X7005** (2 ½")
LH: **X7007** (3")

MAX FIT

RH: **127691** (2 ½")

LH: **126658** (2 ½")

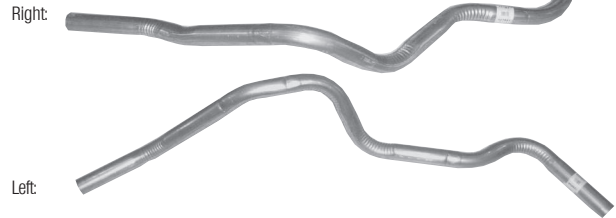

88-93 CHEV/GMC Truck C, K10, 20, 1500, 2500; 8 Cyl;
350, 5.7L; 117", 131", 141" WB (93 w/ OE Converter
Clamped to Front Pipe); Dual Conversion with 90
Degree Side Exit.

MAX FIT

RH: **126301** (2 ¼")
RH: **126303** (2 ½")

LH: **126302** (2 ¼")
LH: **126304** (2 ½")



73-87 CHEV/GMC Full Size Light Duty, Pickup;
Dual Conversion

Pipes Also Fit Ford Trucks

MANDREL

RH: **X6301** (3")

LH: **X6302** (3")

MAX FIT

RH: **126625** (2 ¼")

LH: **126624** (2 ¼")



83-01 CHEV/GMC S10/S15; 4 Cyl; 134-4, 2.2L, 151A, 2.5L;
2 WD; 108.3", 117.9", 122.9" WB; Dual Conversion
88-01 CHEV/GMC S10/S15; 6 Cyl; 173R, 2.8L, 262W, X, Z,
4.3L; 2 WD; 108.3", 117.9", 122.9" WB; Dual Conversion
88-94 CHEV/GMC T10/T15; 6 Cyl; 173R, 2.8L, 262W, Z, 4.3L;
4 WD; 108.3", 117.9", 122.9" WB; Dual Conversion

MANDREL

X6008 (3")



88-90 CHEV/GMC Suburban, Light-Duty Trucks 8 Cyl, 5.7L

MAZDA

MAX FIT

RH: **126615** (2")

LH: **127614** (2")



93-00 MAZDA B Series; 4 & 6 Cyl; 2.3L, 2.5L, 3.0L, 4.0L;
All WB; Dual Conversion

Pipes Also Fit Ford Trucks

MANDREL

RH: **X6002** (2 1/4")

LH: **X6001** (2 1/4")

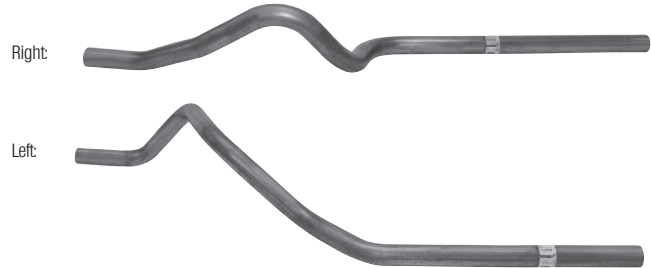

98-00 MAZDA B-Series, 4-6 Cyl, 2.5L, 3.0L, 4.0L; 112",
126" WB

94-97 MAZDA B-Series, 4-6 Cyl, 2.3L, 3.0L, 4.0L; 108",
125" WB

MAX FIT

125639 (2 1/4")



91-92 MAZDA Navajo; Resonator Eliminator

Pipe Also Fits Ford Explorer Trucks

MITSUBISHI

MAX FIT

RH: **126656** (2 1/2")

LH: **126657** (2 1/2")

MANDREL

RH: **X6015** (2 1/2")

LH: **X6016** (2 1/2")



06-08 MITSUBISHI Raider, 6 & 8 Cyl; 3.7L, 4.7L Eng., 131"
WB (Extended Cab and Crew Cab); Dual Conversion

PROFESSIONAL INSTALLER PIPES

Sorted by Manufacturer, then Model,
then from Newest to Oldest Application

MAX FIT[®]

with Mandrel Options

NISSAN

MAX FIT

RH: **127684** (2 1/2")

LH: **127783** (2 1/2")



07-15 NISSAN Titan, Pathfinder, Xterra 5.6L

MANDREL

RH: **X7037** (2 1/2")

LH: **X7046** (2 1/2")

MAX FIT

RH: **127692** (2 1/2")

LH: **126662** (2 1/2")

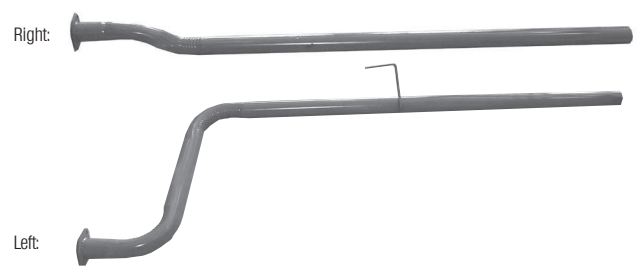

07-08 NISSAN Truck Titan 5.6L 159.8" WB,
Intermediate Pipes

MAX FIT

RH: **125642** (2 1/2")

LH: **125641** (2 1/2")

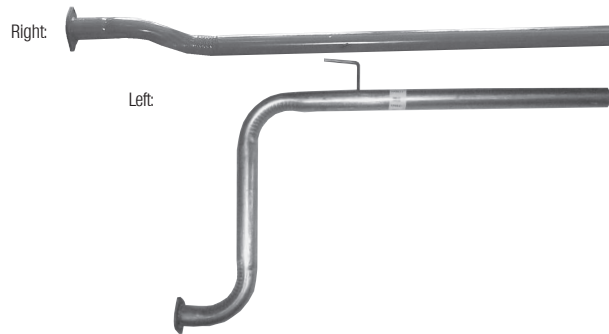

07-08 NISSAN Truck Titan 5.6L 139.8" WB, Intermediate
Pipes

MAX FIT

RH: **127684** (2 1/2")

LH: **127683** (2 1/2")



04-06 NISSAN Titan 8 Cyl; 5.6L (King Cab & Crew Cab),
(XE, SE, LE) (Exc. CA); Dual Conversion

MANDREL

RH: **X7037** (2 1/2")

LH: **X7036** (2 1/2")

TOYOTA

MAX FIT

RH: **128501** (2 1/4")

LH: **128502** (2 1/4")

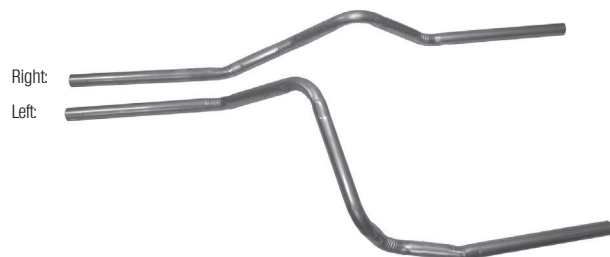

07-14 TOYOTA Tundra; 5.7L

MANDREL

RH: **X8021** (2 1/4")

LH: **X8022** (2 1/4")

MAX FIT

RH: **126650** (2 1/2")

LH: **126651** (2 1/2")



00-06 TOYOTA Tundra; 6 & 8 Cyl; 3.4L, 4.7L Eng (Exc. CA);
Dual Conversion

MANDREL

RH: **X6009** (2 1/2")

LH: **X6010** (2 1/2")

P/N	YEAR	VEHICLE APPLICATION / PART DESCRIPTION	O.A.Length	PART TYPE
121681	95-00	CHRY Cirrus, Sebring 2.4L & 2.5L	8.50"	Exhaust
	95-00	DODGE Stratus 2.0L, 2.4L, & 2.5L		
	98-00	PLYM Breeze 2.0L & 2.4L		
121682	96-00	DODGE/PLYM Caravan, Voyager 3.0L	5.75"	Exhaust
121683	96-00 00-05	CHRY/DODGE/PLYM Town & Country, Caravan, Voyager 3.3L & 3.8L DODGE Neon 2.0L	6"	Exhaust
121685	87-95	FORD Truck E-Series	9.50"	Exhaust
	87-99	FORD Truck F-Series		
121686	96-98	BUICK Skylark 2.4L	4.25"	Exhaust
	96-98	CHEV Cavalier; 97-98 Malibu 2.4L		
	96-98	OLDS Achieva 2.4L		
	96-98	PONT Grand Am, Sunfire 2.4L		
121687	96-97	CHEV/GMC Truck S10, S15 Pickup 2.2L	4.63"	Exhaust
	96-97	ISUZU Hombre Pickup 2.2L		
121688	98-03	CHEV/GMC Truck S10, S15 Pickup 2.2L	4.50"	Exhaust
121689	87-92	VW Jetta & Golf 1.8L (w/ 6 Bolt Flange)	3.75"	Exhaust
121690	00-07	FORD Taurus 3.0L	5.44"	Exhaust
	96-98	MERC Sable 3.0L		
121691	05-07	CHEV Cobalt 2.2L	4"	Exhaust
	06-07	CHEV Cobalt 2.4L		
	06-07	CHEV HHR 2.2L & 2.4L		
	05-07	SATURN Ion 2.2L		
	06-07	SATURN Ion 2.4L		
	07	PONTIAC G5 2.2L & 2.4L		
122617	89-94	GEO/SUZUKI Truck Tracker, Sidekick	21"	Exhaust
122618	99-02	CHEV Cavalier 2.4L	23.50"	Exhaust
	99-00	CHEV Malibu 2.4L		
	99-01	OLDS Alero 2.4L		
	99-01	PONT Grand Am 2.4L		
	99-02	PONT Sunfire 2.4L		
122619	96-98	CHEV/PONT Cavalier, Sunfire 2.4L	21"	Exhaust
	97-98	CHEV Malibu 2.4L		
122620	96-98	CHEV/PONT Cavalier, Sunfire 2.4L	22.50"	Exhaust
	97-98	CHEV Malibu 2.4L		
122621	97-04	BUICK Regal 3.8L	19.50"	Exhaust
	00-05	CHEV Impala, Monte Carlo 3.8L		
	98-99	OLDS Intrigue 3.8L		
	97-03	PONT Grand Prix 3.8L		
122622	2001	CHEV/OLDS/PONT Truck Venture, Silhouette, Montana 3.4L	23.50"	Exhaust
122623	98-99	CHEV Lumina, Monte Carlo 3.8L	20"	Exhaust
122624	97-04	BUICK Century 3.1L	20.50"	Exhaust
	00-04	CHEV Impala, Monte Carlo 3.4L		
	97-04	PONT Grand Prix 3.1L		
122625	96-98	BUICK Skylark 2.4L, Auto. Trans.	20"	Exhaust
	96-98	OLDS Achieva 2.4L, Auto. Trans.		
	96-98	PONT Grand Am 2.4L, Auto. Trans.		
122630	91-95	TOYOTA Truck Previa	17.75"	Exhaust
123529	95-97	FORD/MERC Contour, Mystique 2.0L	32.25"	Exhaust
123530	97-00	CHEV Truck Venture 3.4L	26.50"	Exhaust
	97-00	OLDS Truck Silhouette 3.4L		
	99-00	PONT Truck Montana 3.4L		
	97-98	PONT Truck Trans Sport 3.4L		
123532	98-03	CHEV Malibu 3.1L	25"	Exhaust
	99-04	OLDS Alero 3.4L		
	98-99	OLDS Cutlass 3.1L		
	99-04	PONT Grand Am 3.4L		

BENT PIPES NUMERICAL LISTING

MAX FIT®

P/N	YEAR	VEHICLE APPLICATION / PART DESCRIPTION	O.A.Length	PART TYPE
125564	83-92	FORD Truck Ranger; 4 & 6 Cyl.	59.25"	Tail
125565	88-95	CHEV/GMC Truck C, K Series; 6 & 8 Cyl; Dual Exhaust (Inner Pipe)	58.50"	Tail
125566	88-95	CHEV/GMC Truck C, K Series; 6 & 8 Cyl; Dual Exhaust (Outer Pipe)	60.25"	Tail
125568	83-86	FORD Truck F Series; 6 & 8 Cyl.		Tail
	87-97	FORD Truck F350; 6 Cyl.	55.88"	
125636	84-04	FORD Mustang, GT, LX; Dual Exhaust (Right)	50"	Tail
125637	84-04	FORD Mustang, GT, LX; Dual Exhaust (Left)	50.25"	Tail
125639	91-92	FORD Truck Explorer; Resonator Eliminator		Tail
	91-92	MAZDA Truck Navajo; Resonator Eliminator	49.50"	
125640	83-88	CHEV Monte Carlo SS 5.0L, VIN 7 & G; 4 Bolt Flange Inlet & 2¼" OD Outlets	44.50"	Exhaust
125641	07-08	NISSAN Titan, 8 Cyl., 5.6L Eng., 139.8" WB; Left Intermediate, 2 Bolt Flange Inlet, 2½ OD Outlet	54.37"	Exhaust
125642	07-08	NISSAN Titan, 8 Cyl., 5.6L Eng., 139.8" WB; Right Intermediate, 2 Bolt Flange Inlet, 2½ OD Outlet	53.37"	Exhaust
126102	87-04	DODGE Truck 1500/2500; Dual Conversion (Right); 2¼" Tailpipe		Tail
	87-02	FORD Truck F-Series; Dual Conversion (Right); 2¼" Tailpipe		
	87-02	CHEV/GMC Truck C/K Series; Dual Conversion (Right); 2¼" Tailpipe	91.50"	
126103	87-04	DODGE Truck 1500/2500; Dual Conversion (Left); 2¼" Tailpipe		Tail
	87-02	FORD Truck F-Series; Dual Conversion (Left); 2¼" Tailpipe	101"	
	87-02	CHEV/GMC Truck C/K Series; Dual Conversion (Left); 2¼" Tailpipe		
126104	87-04	DODGE Truck 1500/2500; Dual Conversion (Right); 2½" Tailpipe		Tail
	87-02	FORD Truck F-Series; Dual Conversion (Right); 2½" Tailpipe	91.50"	
	87-02	CHEV/GMC Truck C/K Series; Dual Conversion (Right); 2½" Tailpipe		
126105	87-04	DODGE Truck 1500/2500; Dual Conversion (Left); 2½" Tailpipe		Tail
	87-02	FORD Truck F-Series; Dual Conversion (Left); 2½" Tailpipe	101"	
	87-02	CHEV/GMC Truck C/K Series; Dual Conversion (Left); 2½" Tailpipe		
126301	73-87	CHEV/GMC Truck, 8 Cyl		Tail
	61-86	FORD Truck, Right Side 2 1/4" Tailpipe, Dual Conversion & Single Pipe Side Exit, 8 Cyl	67.12"	
126302	73-87	CHEV/GMC Truck, 8 Cyl		Tail
	61-86	FORD Truck, Left Side 2 1/4" Tailpipe, Dual Conversion, 8 Cyl	66.75"	
126303	73-87	CHEV/GMC Truck, 8 Cyl		Tail
	61-86	FORD Truck, Right Side 2 1/2" Tailpipe, Dual Conversion & Single Pipe Side Exit, 8 Cyl	67.50"	
126304	73-87	CHEV/GMC Truck, 8 Cyl		Tail
	61-86	FORD Truck, Left Side 2 1/2" Tailpipe, Dual Conversion, 8 Cyl	67"	
126508	77-90	GM Full Size; Single & Dual Exhaust (Left)		Tail
	64-72	GM Mid Size; Single & Dual Exhaust (Left)	63"	
126543	86-87	GM Century, 6000 Sedan, Cutlass Ciera; 4 Cyl.		Exhaust
	84-86	BUICK Century; 6 Cyl.	66.50"	
	86-87	CHEV Celebrity; 4 Cyl.		
	84-86	CHEV Celebrity Eurosport; 6 Cyl.		
	84-86	OLDS Cutlass Ciera; 6 Cyl.		
	83-86	PONT 6000, 6000 STE Sedan; 6 Cyl., 2" OD Inlet & Outlet		
126546	88-90	GM Century, 6000 Sedan; 4 Cyl.		Exhaust
	85-90	GM Century, Cutlass Ciera; 6 Cyl.	66.75"	
	88-89	CHEV Celebrity Sedan; 4 Cyl.		
	86-89	CHEV Celebrity Eurosport; 6 Cyl.		
	88-90	OLDS Cutlass Ciera Sedan; 4 Cyl.		
	86-90	PONT 6000 S/E, STE; 6 Cyl., 2¼" OD Inlet & Outlet		
126554	77-85	BUICK Full Size		Tail
	77-90	CAD Full Size	64.75"	
	77-88	CHEV Full Size		
	77-85	OLDS Full Size		
	77-86	PONT Full Size		
126555	83-88	FORD Crown Victoria Sedan; Single & Dual Exhaust (Right)		Tail
	80-82	FORD LTD Sedan; Single & Dual Exhaust (Right)	61.50"	
	82-88	LINC Town Car; Single & Dual Exhaust (Right)		
	80-83	LINC Continental, Mark VI; Single & Dual Exhaust (Right)		

P/N	YEAR	VEHICLE APPLICATION / PART DESCRIPTION	O.A.Length	PART TYPE
	83-88	MERC Grand Marquis Sedan; Single & Dual Exhaust (Right)		
	80-82	MERC Marquis Sedan; Single & Dual Exhaust (Right)		
126558	86-87	BUICK Century; 4 Cyl.	67"	Exhaust
	86-87	CHEV Celebrity; 4 Cyl.		
	86-87	OLDS Ciera; 4 Cyl.		
	86-87	PONT 6000; 4 Cyl., 2" OD Inlet & Outlet		
126563	77-90	GM Full Size; Single & Dual Exhaust (Right)	64.50"	Tail
	64-72	GM Mid Size; Single & Dual Exhaust (Right)		
126582	83-88	FORD Crown Victoria Sedan; Dual Exhaust (Left)	60.25"	Tail
	80-82	FORD LTD Sedan; Dual Exhaust (Left)		
	82-88	LINC Town Car; Dual Exhaust (Left)		
	80-83	LINC Continental, Mark VI; Dual Exhaust (Left)		
	83-88	MERC Grand Marquis Sedan; Dual Exhaust (Left)		
	80-82	MERC Marquis Sedan; Dual Exhaust (Left)		
126584	88-99	CHEV/GMC Truck Full Size, Light Duty Trucks (99 Pickups w/ Old Body Style), 8 Cyl; 5.7L Eng; (Exc. 88-90 Suburban); Side Exit; 3" Tailpipe	61"	Tail
126615	93-00	FORD/MAZDA Truck Ranger/B Series; 4 & 6 Cyl; 2.3L, 2.5L, 3.0L, 4.0L; All WB; Dual Conversion (Right); 2" Tailpipe	70.63"	Tail
126624	83-01	CHEV/GMC Truck S10/15; 4 Cyl; 134-4, 2.2L, 151A, 2.5L; 2 WD; 108.3", 117.9", 122.9" WB; Dual Conversion (Left); 2 1/4" Tailpipe	65"	Tail
	88-01	CHEV/GMC Truck S10/15; 6 Cyl; 173R, 2.8L, 262W, X, Z, 4.3L; 2 WD; 108.3", 117.9", 122.9" WB; Dual Conversion (Left); 2 1/4" Tailpipe		
	88-94	CHEV/GMC Truck T10/15; 6 Cyl; 173R, 2.8L, 262W, Z, 4.3L; 4 WD; 108.3", 117.9", 122.9" WB; Dual Conversion (Left); 2 1/4" Tailpipe		
126625	83-01	CHEV/GMC Truck S10/15; 4 Cyl; 134-4, 2.2L, 151A, 2.5L; 2 WD; 108.3", 117.9", 122.9" WB; Dual Conversion (Right); 2 1/4" Tailpipe	64.75"	Tail
	88-01	CHEV/GMC Truck S10/15; 6 Cyl; 173R, 2.8L, 262W, X, Z, 4.3L; 2 WD; 108.3", 117.9", 122.9" WB; Dual Conversion (Right); 2 1/4" Tailpipe		
	88-94	CHEV/GMC Truck T10/15; 6 Cyl; 173R, 2.8L, 262W, Z, 4.3L; 4 WD; 108.3", 117.9", 122.9" WB; Dual Conversion (Right); 2 1/4" Tailpipe		
126640	94-96	BUICK Roadmaster Sedan; Resonator Eliminator; Single & Dual Exhaust (Right)	60.25"	Tail
	94-96	CHEV Caprice Sedan, Impala SS Sedan; Resonator Eliminator; Single & Dual Exhaust (Right)		
126641	94-96	BUICK Roadmaster Sedan; Resonator Eliminator; Dual Exhaust (Left)	61.25"	Tail
	94-96	CHEV Caprice Sedan, Impala SS Sedan; Resonator Eliminator; Dual Exhaust (Left)		
126642	82-92	CHEV/PONT Camaro, Firebird; 8 Cyl., 2 1/4" OD Outlet	71.75"	Exhaust
126650	00-06	TOYOTA Truck Tundra; 6 & 8 Cyl; 3.4L, 4.7L Eng (Exc. CA); Dual Conversion (Right); 2 1/2" Tailpipe	78"	Tail
126651	00-06	TOYOTA Truck Tundra; 6 & 8 Cyl; 3.4L, 4.7L Eng (Exc. CA); Dual Conversion (Left); 2 1/2" Tailpipe	78"	Tail
126653	97-01	FORD Truck F150/F250 6 & 8 Cyl., 4.2L, 4.6L, & 5.4L Eng., 120", 139" WBs, 90 Degree Side Exit - Right; Dual Conversion	62.50"	Tail
126656	04-08	DODGE Truck Dakota, All Engs., Club & Quad Cab 131" WB - 2.50" Right; Dual Conversion	66.25"	Tail
	06-07	MITSUBISHI Raider; 6 & 8 Cyl., 3.7L, 4.7L Eng., 131" WB (Extended Cab and Crew Cab); Dual Conversion - 2.50" Right		
126657	04-08	DODGE Truck Dakota, All Engs., Club & Quad Cab 131" WB - 2.50" Left; Dual Conversion	66.50"	Tail
	06-07	MITSUBISHI Raider; 6 & 8 Cyl., 3.7L, 4.7L Eng., 131" WB (Extended Cab and Crew Cab); Dual Conversion - 2.50" Left		
126658	88-93	CHEV/GMC Truck C/K 1500/2500 Series, 8 Cyl., 5.7L Eng., 117", 131", & 141" WB, 2.50" 90 Degree Side Exit w/ OE Converter Clamped to Front Pipe - Left; Dual Conversion	58"	Tail
126660	00-03	DODGE Truck Dakota, Quad Cab 112", 131" WB, All Engs., - Right; Dual Conversion	60.75"	Tail
126661	00-03	DODGE Truck Dakota, Quad Cab 112", 131" WB, All Engs., - Left; Dual Conversion	62"	Tail
126662	07-08	NISSAN Truck Titan, 8 Cyl., 5.6L Eng., 159.5" WB - Left Intermediate	68"	Exhaust
126663	94-96	BUICK/CHEV Roadmaster, Caprice, Impala SS, 2.25" Dual Exhaust - Left without the last bend	61"	Tail
126664	94-96	BUICK/CHEV Roadmaster, Caprice, Impala SS, 2.25" Dual Exhaust - Right without the last 2 bends	61"	Tail
126665	94-96	BUICK/CHEV Roadmaster, Caprice, Impala SS, 2.50" Dual Exhaust - Left without the last bend	61"	Tail
126666	94-96	BUICK/CHEV Roadmaster, Caprice, Impala SS, 2.50" Dual Exhaust - Right without the last 2 bends	61"	Tail

BENT PIPES NUMERICAL LISTING

MAX FIT®

P/N	YEAR	VEHICLE APPLICATION / PART DESCRIPTION	O.A.Length	PART TYPE
126667	09-13	CHEV/GMC Silverado/Sierra 1500; 4.3L, 4.8L & 5.3L Engines, Dual Conversion, Right Side 2 1/2" Tailpipe	70"	Tail
126687	83-88	CHEV Monte Carlo SS 5.0L, VIN 7 & G; 2.25" OD - Dual Exhaust - Left	61"	Tail
126688	83-88	CHEV Monte Carlo SS 5.0L, VIN 7 & G; 2.25" OD - Dual Exhaust - Right	61"	Tail
127553	78-87 78-83 78-87 78-87	BUICK Century, Regal CHEV Chevelle, Malibu, Monte Carlo OLDS Cutlass, Vista Cruiser PONT Bonneville, Grand Am, Grand Prix, LeMans, Flare Inlet, 2" OD Outlet	80.88"	Exhaust
127576	88-95	CHEV/GMC Truck; Dual Conversion (Right); 2 1/4" Tailpipe	78.50"	Tail
127577	88-95	CHEV/GMC Truck; Dual Conversion (Left); 2 1/4" Tailpipe	80.50"	Tail
127578	88-95	CHEV/GMC Truck; Dual Conversion (Right); 2 1/2" Tailpipe	81.75"	Tail
127579	88-95	CHEV/GMC Truck; Dual Conversion (Left); 2 1/2" Tailpipe	83.50"	Tail
127580	87-96	FORD Truck F150/250 (Under 8500 lbs.GVW); 6 & 8 Cyl; 4.9L, 5.0L, 5.8L; 116", 133", 139" WB; Dual Conversion (Right); 2 1/4" Tailpipe	81.50"	Tail
127581	87-96	FORD Truck F150/250 (Under 8500 lbs.GVW); 6 & 8 Cyl; 4.9L, 5.0L, 5.8L; 116", 133", 139" WB; Dual Conversion (Left); 2 1/4" Tailpipe	83"	Tail
127595	87-99	DODGE Truck Dakota; 6 & 8 Cyl; 3.9L, 4.7L, 5.9L; All WB (00-01 112", 131" Club Cab & Quad Cab WB); Dual Conversion (Left); 2 1/2" Tailpipe	79.50"	Tail
127596	87-99	DODGE Truck Dakota; 6 & 8 Cyl; 3.9L, 4.7L, 5.9L; All WB (00-01 112", 131" Club Cab & Quad Cab WB); Dual Conversion (Right); 2 1/2" Tailpipe	74.50"	Tail
127601	88-93	CHEV/GMC Truck C, K10, 20, 1500, 2500; 8 Cyl; 350, 5.7L; 117", 131", 141" WB (93 w/ OE Conv. clamped to front pipe); Dual Conversion (Left); 2 1/4" Tailpipe	75.75"	Tail
127602	88-93	CHEV/GMC Truck C, K10, 20, 1500, 2500; 8 Cyl; 350, 5.7L; 117", 131", 141" WB (93 w/ OE Conv. clamped to front pipe) Dual Conversion (Right); 2 1/4" Tailpipe	73.75"	Tail
127603	88-93	CHEV/GMC Truck C, K10, 20, 1500, 2500; 8 Cyl; 350, 5.7L; 117", 131", 141" WB (93 w/ OE Conv. clamped to front pipe) Dual Conversion (Left); 2 1/4" Tailpipe	75.75"	Tail
127604	88-93	CHEV/GMC Truck C, K10, 20, 1500, 2500; 8 Cyl; 350, 5.7L; 117", 131", 141" WB (93 w/ OE Conv. clamped to front pipe) Dual Conversion (Right); 2 1/4" Tailpipe	73.75"	Tail
127612	87-96	FORD Truck F150/250 (Under 8500 lbs. GVW); 6 & 8 Cyl; 4.9L, 5.0L, 5.8L; 116", 133", 139" WB, Dual Conversion (Right); 2 1/2" Tailpipe	80.50"	Tail
127614	93-00	FORD/MAZDA Truck Ranger/B Series; 4 & 6 Cyl; 2.3L, 2.5L, 3.0L, 4.0L; All WB; Dual Conversion (Left); 2" Tailpipe	74.88"	Tail
127632	97-01	FORD Truck F150/F250 (Under 8800 lbs. GVW), 6 & 8 Cyl; 4.2L, 4.6L, 5.4L; 120", 139" WB; Dual Conversion (Left); 2 1/2" Tailpipe	79.50"	Tail
127633	97-01	FORD Truck F150/F250 (Under 8800 lbs. GVW), 6 & 8 Cyl; 4.2L, 4.6L, 5.4L; 120", 139" WB; Dual Conversion (Right); 2 1/2" Tailpipe	74.25"	Tail
127656	97-01	FORD Truck F150/F250 (Under 8800 lbs. GVW); 6 & 8 Cyl; 4.2L, 4.6L, 5.4L; 120", 139" WB; Dual Conversion (Left); 2 1/4" Tailpipe	79.50"	Tail
127657	97-01	FORD Truck F150/F250 (Under 8800 lbs. GVW); 6 & 8 Cyl; 4.2L, 4.6L, 5.4L; 120", 139" WB; Dual Conversion (Right); 2 1/4" Tailpipe	74.25"	Tail
127664	96-99	CHEV/GMC Truck C/K 1500/2500 (Under 8600 lbs. GVW), (99 w/ Old Body Style); 8 Cyl; 350 5.7L Eng; 117.5", 131.5", 141.5" WB; Dual Conversion (Left); 2 1/2" Tailpipe	81"	Tail
127665	96-99	CHEV/GMC Truck C/K 1500/2500 (Under 8600 lbs. GVW), (99 w/ Old Body Style); 8 Cyl; 350 5.7L Eng; 117.5", 131.5", 141.5" WB; Dual Conversion (Right); 2 1/2" Tailpipe	81"	Tail
127666	02-03	FORD Truck F150/F250 (Under 8800 lbs. GVW); 6 & 8 Cyl; 4.2L, 4.6L, 5.4L; 120", 139" WB; Dual Conversion (Right); 2 1/4" Tailpipe	73"	Tail
127668	99-08	CHEV/GMC C/K 1500/2500 (99 New Body Style); 6 & 8 Cyl; 4.3L, 4.8L, 5.3L; 1/2 & 3/4 Ton; 119", 133", 143.5" WB; Dual Conversion (Left); 2 1/4" Tailpipe	81"	Tail
127669	99-08	CHEV/GMC C/K 1500/2500 (99 New Body Style); 6 & 8 Cyl; 4.3L, 4.8L, 5.3L; 1/2 & 3/4 Ton; 119", 133", 143.5" WB; Dual Conversion (Right); 2 1/4" Tailpipe	77"	Tail
127670	99-05	CHEV/GMC Truck C, K10, 20, 1500, 2500 (99 New Body Style); 6 & 8 Cyl; 4.3L, 4.8L, 5.3L; 119" WB (Std. Cab/Short Bed); 133"; 143" WB (Ext. Cab/Short Bed); Dual Conversion (Left); 2 1/2" Tailpipe	69.50"	Tail
127671	99-05	CHEV/GMC Truck C, K10, 20, 1500, 2500 (99 New Body Style); 6 & 8 Cyl; 4.3L, 4.8L, 5.3L; 119" WB (Std. Cab/Short Bed); 133"; 143" WB (Ext. Cab/Short Bed); Dual Conversion (Right); 2 1/2" Tailpipe	75.50"	Tail
127674	94-95	CHEV/GMC C, K10, 20, 1500, 2500; 6 & 8 Cyl; 262, 4.3L, 305, 5.0L, 350, 5.7L; 117", 131", 141" WB; Dual Conversion (Left); 2 1/2" Tailpipe	84"	Tail
127675	94-95	CHEV/GMC C, K10, 20, 1500, 2500; 6 & 8 Cyl; 262, 4.3L, 305, 5.0L, 350, 5.7L; 117", 131", 141" WB; Dual Conversion (Right); 2 1/2" Tailpipe	81"	Tail
127676	02-05	DODGE Truck Ram 1500/2500 (Under 8800 lbs. GVW); 6 & 8 Cyl; 3.7L, 4.7L, 03-05 5.7L Hemi Engine, 02-03 5.9L; 140" WB; (Regular Cab/Short Bed & Quad Cab/Short Bed) Dual Conversion (Right); 2 1/4" Tailpipe	82"	Tail

PIPES

P/N	YEAR	VEHICLE APPLICATION / PART DESCRIPTION	O.A.Length	PART TYPE
127681	02-05	DODGE Truck Ram 1500/2500 (Under 8800 lbs. GVW); 6 & 8 Cyl; 3.7L, 4.7L; 120" WB; Dual Conversion (Left); 2¼" Tailpipe	79"	Tail
127682	02-05	DODGE Truck Ram 1500/2500 (Under 8800 lbs. GVW); 6 & 8 Cyl; 3.7L, 4.7L; 120" WB; Dual Conversion (Right); 2¼" Tailpipe	81"	Tail
127683	04-06	NISSAN Titan; 8 Cyl; 5.6L (King Cab & Crew Cab), (XE, SE, LE) Exc. CA; Dual Conversion (Left); 2½" Tailpipe	79"	Tail
127684	07-15	NISSAN Titan; 8 Cyl; 5.6L (King Cab & Crew Cab), (XE, SE, LE) Exc. CA; Dual Conversion (Right); 2½" Tailpipe	79"	Tail
127685	04-08 06-08	FORD F150 (New Body Style); 8 Cyl; 4.6L, 5.4L; All WBs; Dual Conversion (Left); 2¼" Tailpipe LINC Mark LT; 8 Cyl; 5.4L; 139" WB; Dual Conversion (Left); 2¼" Tailpipe	83.50"	Tail
127686	04-08 06-08	FORD F150 (New Body Style); 8 Cyl; 4.6L, 5.4L; All WBs; Dual Conversion (Right); 2¼" Tailpipe LINC Mark LT; 8 Cyl; 5.4L; 139" WB; Dual Conversion (Right); 2¼" Tailpipe	75.50"	Tail
127687	06-08	DODGE Truck Ram 1500, 3.7L, 4.7L, & 5.7L Engs., 120", 140" WB - Left; Dual Conversion	83"	Tail
127688	06-08	DODGE Truck Ram 1500, 3.7L, 4.7L, & 5.7L Engs., 120", 140" WB - Right; Dual Conversion	81"	Tail
127689	97-01	FORD Truck F150/F250 6 & 8 Cyl., 4.2L, 4.6L, & 5.4L Eng., 120", 139" WB, 90 Degree Side Exit; Dual Conversion- Left	63.75"	Tail
127691	88-93	CHEV/GMC Truck C/K 1500/2500 Series, 8 Cyl., 5.7L Eng., 117", 131", & 141" WB, 2.50" 90 Degree Side Exit w/ OE Converter Clamped to Front Pipe; Dual Conversion - Right	59"	Tail
127692	07-08	NISSAN Truck Titan, 8 Cyl., 5.6L Eng., 159.5" WB - Right Intermediate	74"	Exhaust
127693	07-08	NISSAN Truck Titan, 8 Cyl., 5.6L Eng., (King Cab & Crew Cab), (XE, SE, LE) Exc. CA; 2.50" Dual Conversion - Left	79"	Tail
127694	2009	DODGE Truck Ram 1500, 5.7L Eng., 140.5" WB - Dual Conversion - Right	81.50"	Tail
127695	09-13	CHEV/GMC Silverado/Sierra 1500; 4.3L, 4.8L & 5.3L Engines, Dual Conversion, Left Side 2 1/2" Tailpipe	76"	Tail
127783	07-15	NISSAN Titan, 5.6L Engine, Dual Conversion Tailpipe, Left, 8 Cyl.	79"	Tail
128009	07-08 07-11 07-11	DODGE Ram Full Size (Left); 2¼"; Dual Conversion FORD F-Series Full Size (Left); 2¼"; Dual Conversion GM Truck Full Size (Left); 2¼"; Dual Conversion	89.75"	Tail
128010	07-08 07-11 07-11	DODGE Ram Full Size (Right); 2¼"; Dual Conversion FORD F-Series Full Size (Right); 2¼"; Dual Conversion GM Truck Full Size (Right); 2¼"; Dual Conversion	83.50"	Tail
128011	07-08 07-11 07-11	DODGE Ram Full Size (Left); 2½"; Dual Conversion FORD F-Series Full Size (Left); 2½"; Dual Conversion GM Truck Full Size (Left); 2½"; Dual Conversion	89.75"	Tail
128012	07-08 07-11 07-11	DODGE Ram Full Size (Right); 2½"; Dual Conversion FORD F-Series Full Size (Right); 2½"; Dual Conversion GM Truck Full Size (Right); 2½"; Dual Conversion	83.50"	Tail
128501	07-14	TOYOTA Tundra, 5.7L Engine, Dual Conversion, 2 1/4", Right, 8 Cyl.	88.88"	Tail
128502	07-14	TOYOTA Tundra, 5.7L Engine, Dual Conversion, 2 1/4", Left, 8 Cyl.	91.50"	Tail
128551	84-94 84-94	FORD Tempo MERC Topaz	84.75"	Exhaust
128593	94-01	DODGE Truck Ram 1500/2500 (Under 8800 lbs. GVW); 6 & 8 Cyl; 3.9L, 5.2L, 5.9L; 119", 135", 139" WB; Dual Conversion (Left); 2½" Tailpipe	89"	Tail
128594	94-01	DODGE Truck Ram 1500/2500 (Under 8800 lbs. GVW); 6 & 8 Cyl; 3.9L, 5.2L, 5.9L; 119", 135", 139" WB; Dual Conversion (Right); 2½" Tailpipe	91"	Tail
128611	87-96	FORD Truck F150/F250 (Under 8500 lbs. GVW); 6 & 8 Cyl; 4.9L, 5.0L, 5.8L; 116", 133", 139" WB; Dual Conversion (Left); 2½" Tailpipe	86"	Tail
128662	94-01	DODGE Truck Ram 1500/2500 (Under 8800 lbs. GVW); 6 & 8 Cyl; 3.9L, 5.2L, 5.9L; 119", 135", 139" WB; Dual Conversion (Left); 2¼" Tailpipe	93.50"	Tail
128663	94-01	DODGE Truck Ram 1500/2500 (Under 8800 lbs. GVW); 6 & 8 Cyl; 3.9L, 5.2L, 5.9L; 119", 135", 139" WB; Dual Conversion (Right); 2¼" Tailpipe	91"	Tail
128667	02-03	FORD Truck F150/250 (Under 8800 lbs. GVW); 6 & 8 Cyl; 4.2L, 4.6L, 5.4L; 120", 139" WB; Dual Conversion (Left); 2¼" Tailpipe	80"	Tail
128677	02-05	DODGE Truck Ram 1500/2500 (Under 8800 lbs. GVW); 6 & 8 Cyl; 3.7L, 4.7L Eng., 03-05 5.7L Hemi Engine, 02-03 5.9L; 140" WB; (Regular Cab/Short Bed & Quad Cab/Short Bed) Dual Conversion (Left); 2¼" Tailpipe	87"	Tail
128678	2009	DODGE Truck Ram 1500, 5.7L Eng., 140.5" WB - Dual Conversion - Left	81.50"	Tail

GASKETS

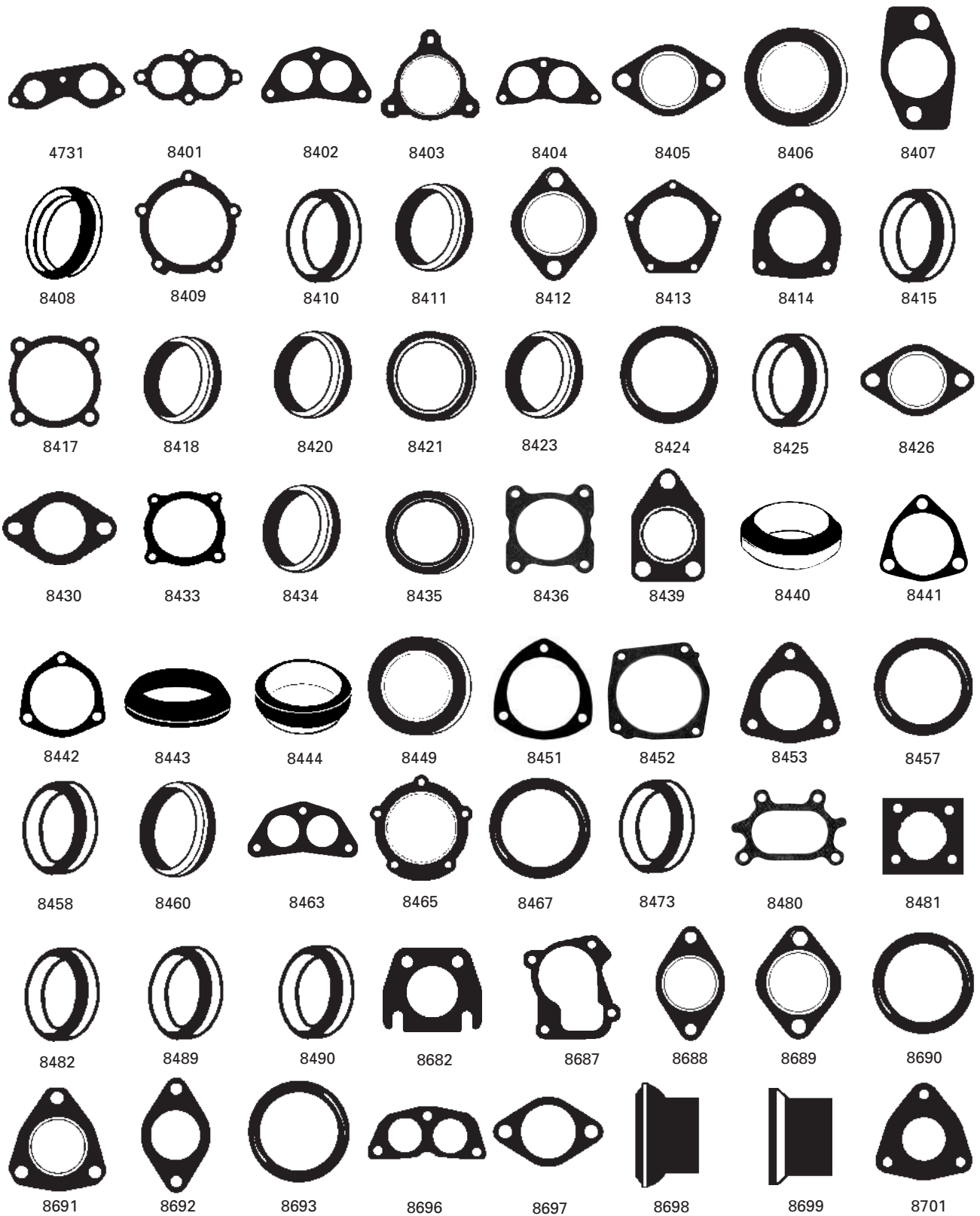

Note: Illustrations are not to scale.

GASKETS

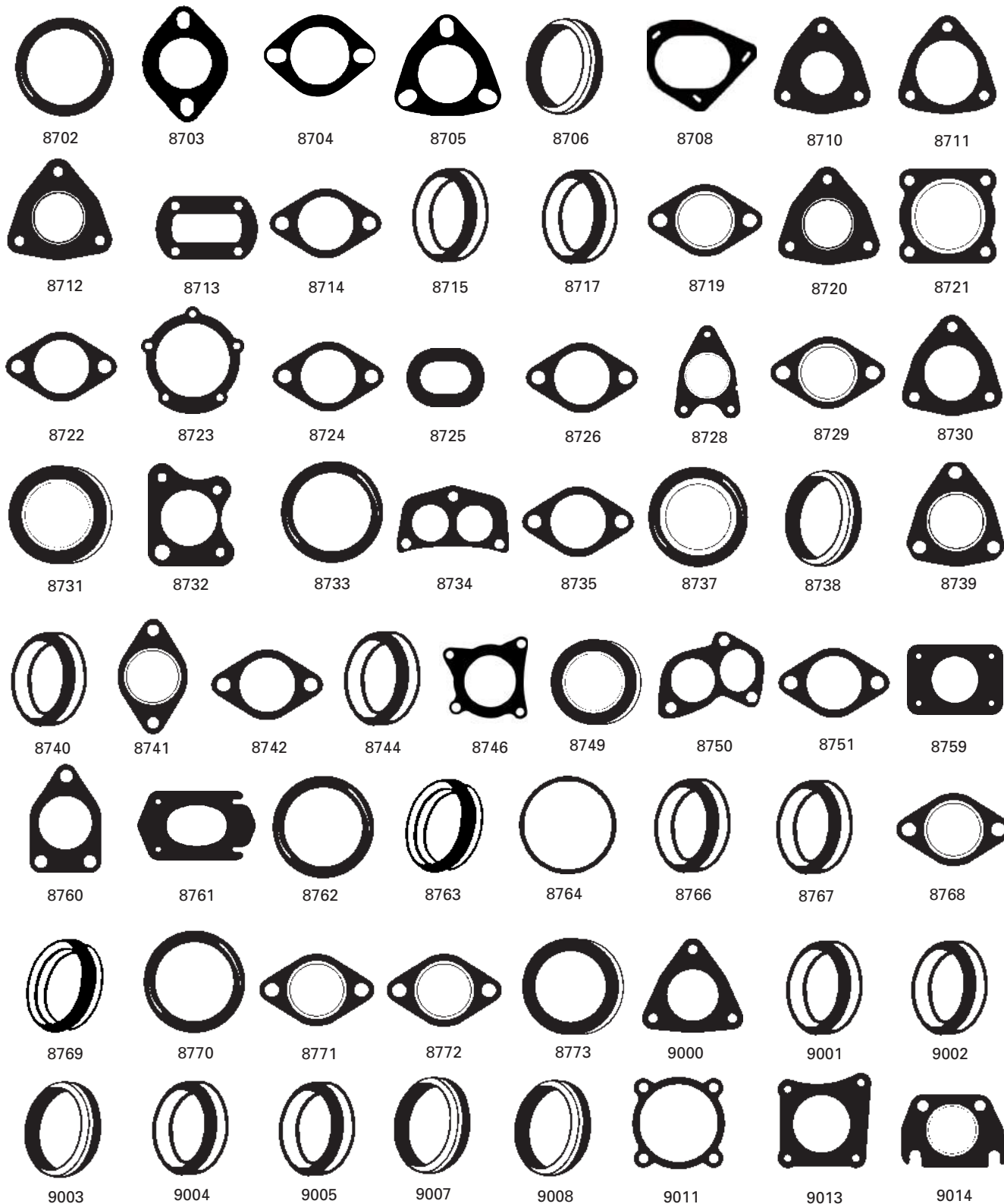

GASKETS

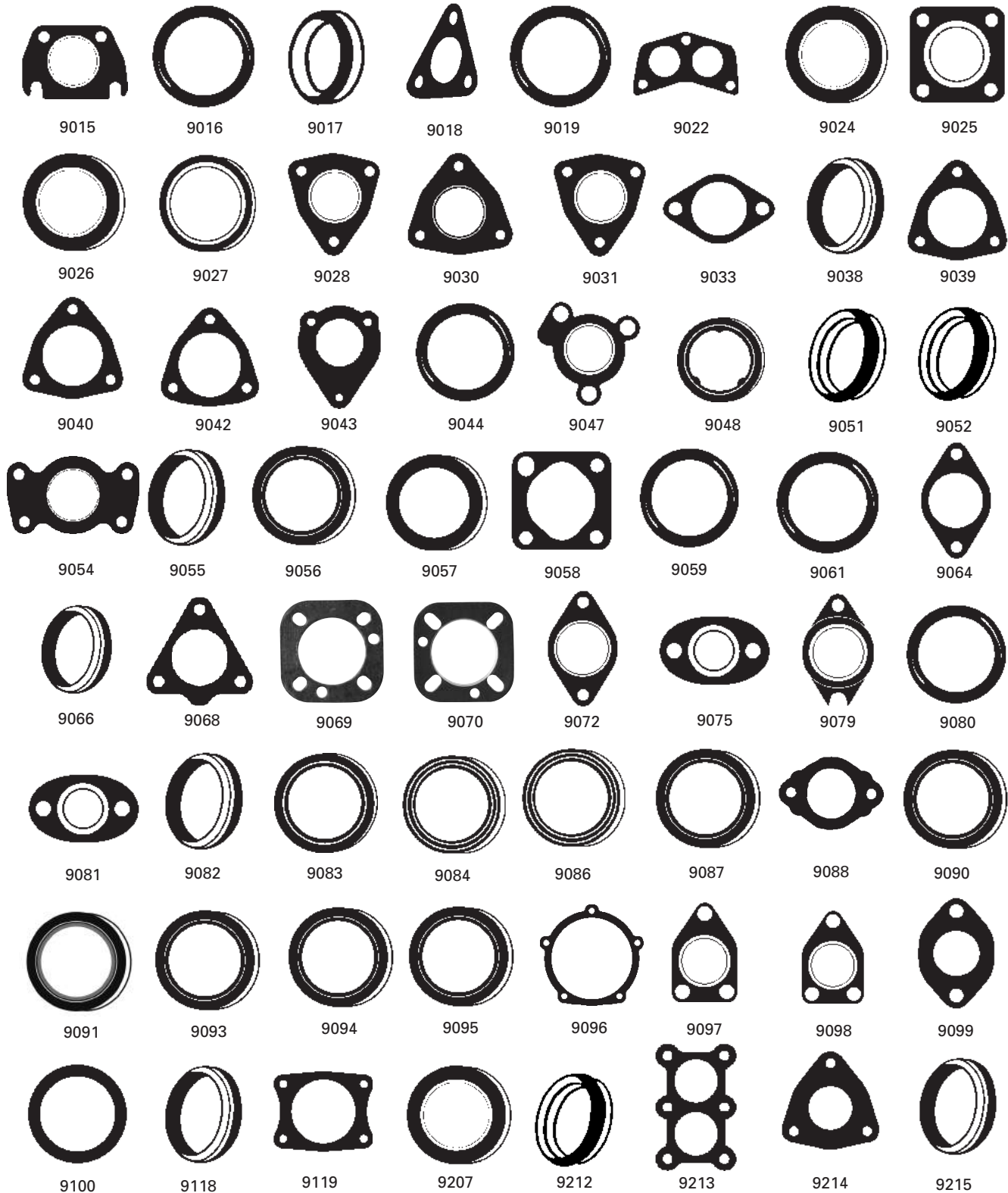

Note: Illustrations are not to scale.

GASKETS



9216



9217



9218



9220



9221



9223



9224



9225

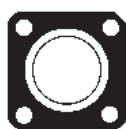

9226



9227



9228



9229



9231



9233



9234



9235



9236



9237



9238



9239



9240



9242



9244



9245



9247



9248



9250



9251



9252



9253

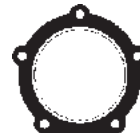

9254



9255



9256



9257



9258



9259



9260



9261



9263



9264



9265



9266



9267



9268



9269



9270



9271



9272



9274



9275



9276



9277



9278



9279



9280



9281



9282



9283



9284



9285



9286



9287



9288



9289

ACCESSORIES

GENERAL INFO



GASKETS



9290 9291 9292 9295 9297 9299 9743

BRACKETS, HANGERS & MISC. PARTS

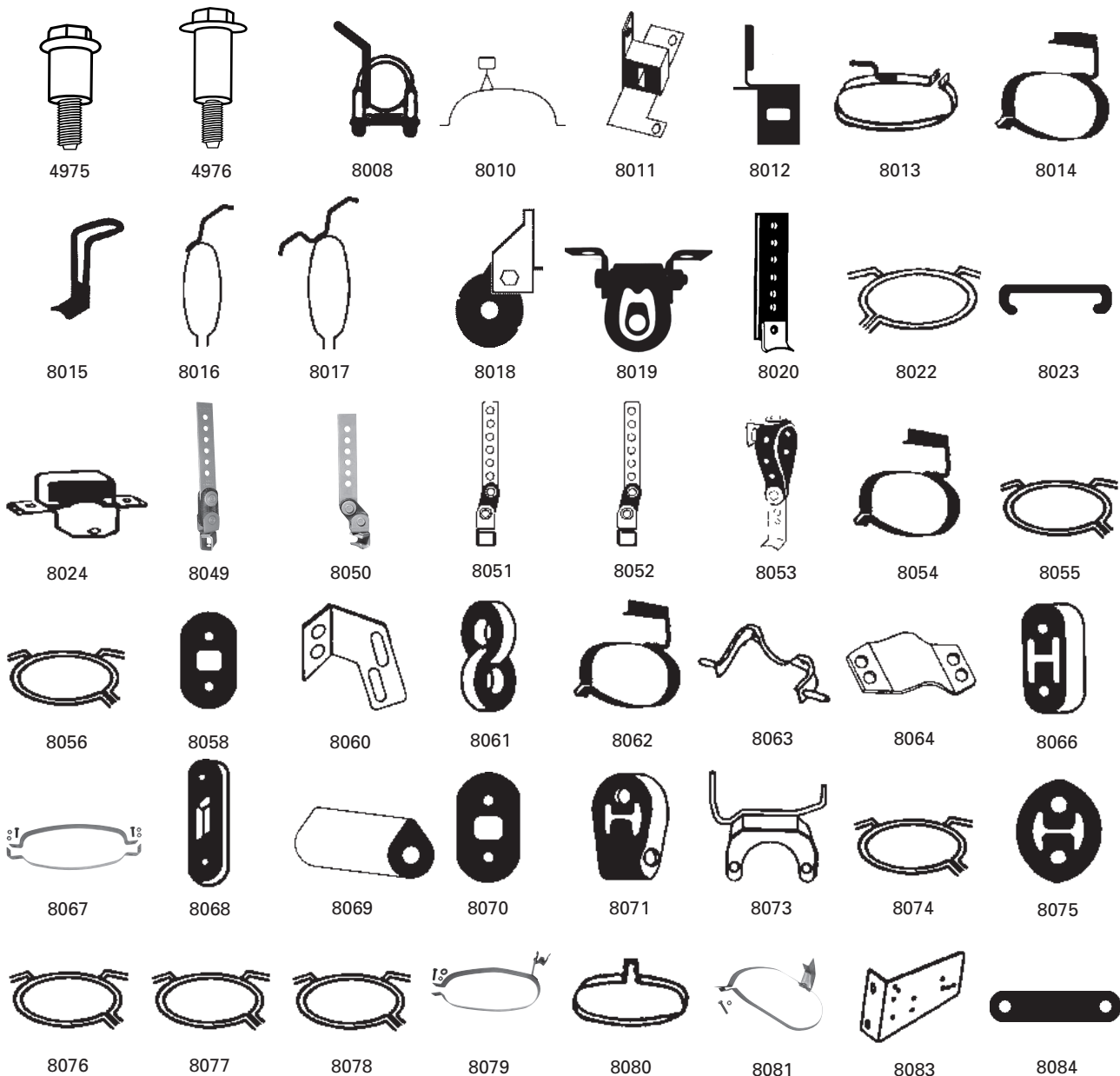

4975 4976 8008 8010 8011 8012 8013 8014
 8015 8016 8017 8018 8019 8020 8022 8023
 8024 8049 8050 8051 8052 8053 8054 8055
 8056 8058 8060 8061 8062 8063 8064 8066
 8067 8068 8069 8070 8071 8073 8074 8075
 8076 8077 8078 8079 8080 8081 8083 8084

Note: Illustrations are not to scale.

BRACKETS, HANGERS & MISC. PARTS

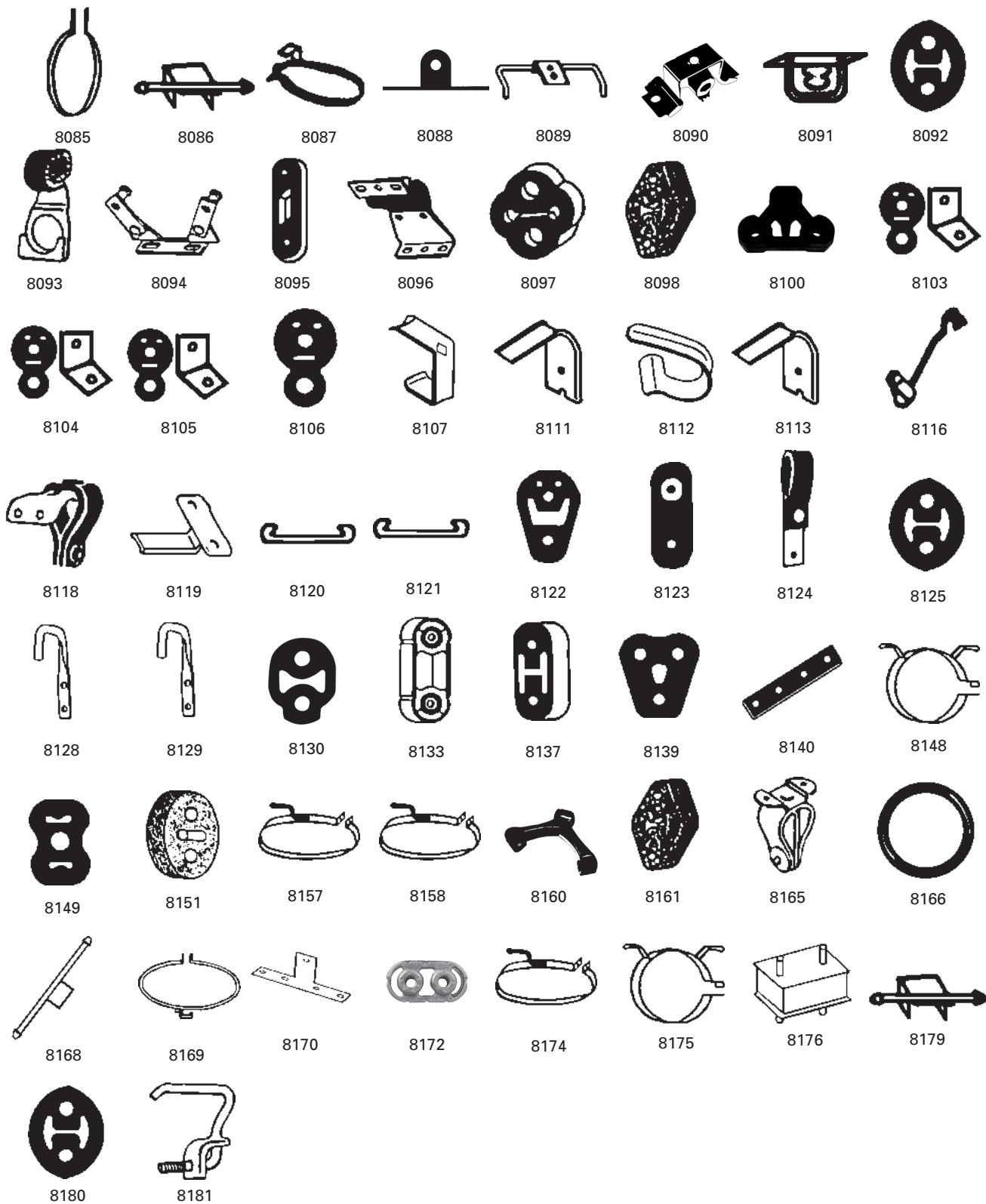

ACCESSORIES

GENERAL INFO



ACCESSORIES

BRACKETS, HANGERS & MISC. PARTS



Note: Illustrations are not to scale.

BRACKETS, HANGERS & MISC. PARTS



8510



8511



8515



8516



8518



8519



8531



8536



8537



8545



8547



8548



8553



8554



8560



8566

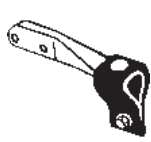

8568



8571



8572

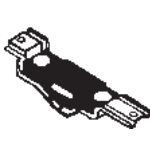

8573



8581



8588



8592



8593



8620



8627



8628



8637

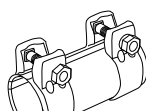

8640

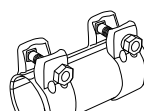

8641

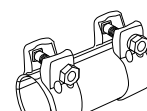

8642

CLAMPS

STANDARD DUTY 5/16" U-BOLT



P/N	SIZE	BOX QTY
U118	1 1/8"	1
U114	1 1/4"	1
U112	1 1/2"	1
U158	1 5/8"	1
U134	1 3/4"	1
U178	1 7/8"	1
U200	2"	1
U218	2 1/8"	1
U214	2 1/4"	1
U212	2 1/2"	1

STANDARD DUTY 5/16" U-BOLT W/ FLANGE NUT



P/N	SIZE	BOX QTY
339976	1 1/2"	50
339977	1 5/8"	50
339978	1 3/4"	50
339979	1 7/8"	50
339980	2"	50
339981	2 1/8"	50
339982	2 1/4"	50
339983	2 1/2"	50

SLOTTED HD 3/8" U-BOLT W/ FLANGE NUT



P/N	SIZE	BOX QTY
339893	1 1/2"	100
339892	1 3/4"	100
339891	1 7/8"	100
339890	2"	100
339889	2 1/4"	100
339888	2 1/2"	100

DGM STYLE 3/8" U-BOLT W/ FLANGE NUT



P/N	SIZE	BOX QTY	P/N	SIZE	BOX QTY
M112	1 1/2"	1	339862	1 1/2"	100
M158	1 5/8"	1			
M134	1 3/4"	1	339880	1 3/4"	100
M178	1 7/8"	1	339879	1 7/8"	100
M200	2"	1	339878	2"	100
M218	2 1/8"	1	339877	2 1/8"	100
M214	2 1/4"	1	339876	2 1/4"	100
M212	2 1/2"	1	339875	2 1/2"	100
M258	2 5/8"	1			
M300	3"	1	9972	3"	50

HEAVY DUTY 3/8" U-BOLT TRUCK CLAMPS



P/N	P/N ZINC	SIZE	BOX QTY
H234P	—	2 3/4"	1
H300P	H300PZ	3"	1
H312P	H312PZ	3 1/2"	1
H400P	H400PZ	4"	1
H412P	H412PZ	4 1/2"	1
H500P	H500PZ	5"	1

EXTRA HEAVY DUTY CLAMPS 3/8" U-BOLT 11 GAUGE SADDLE



P/N	P/N ZINC	SIZE	BOX QTY	P/N	P/N ZINC	SIZE	BOX QTY
H200	—	2"	1	H300*	H300Z	3"	1
H218	—	2 1/8"	1	H314*	—	3 1/4"	1
H214	—	2 1/4"	1	H312*	—	3 1/2"	1
H238	—	2 3/8"	1	H400*	H400Z	4"	1
H212	MC212ZP	2 1/2"	1	H412*	—	4 1/2"	1
H258*	—	2 5/8"	1	H500*	H500Z	5"	1
H234*	—	2 3/4"	1	H600*	H600Z	6"	1

*Welded Saddle

STAINLESS STEEL 3/8" U-BOLT



P/N	SIZE	BOX QTY
SS112	1 1/2"	1
SS134	1 3/4"	1
SS178	1 7/8"	1
SS200	2"	1
SS214	2 1/4"	1
SS212	2 1/2"	1
SS300	3"	1

CLAMPS

FLAT BAND CLAMPS

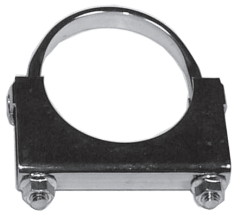

P/N ZINC	P/N CHROME	SIZE	BOX QTY
9501	9490	3"	1
9502	—	3 ½"	1
9503	9492	4"	1
9504	9493	5"	1
9736	—	5 ½"	1
9506	9495	6"	1

HEAVY DUTY GUILLOTINE CLAMPS



P/N	P/N ZINC	P/N CHROME	SIZE	BOX QTY
T234	—	—	2 ¾"	1
T300	T300Z	—	3"	1
T314	—	—	3 ¼"	1
T312	T312Z	—	3 ½"	1
T400	T400Z	9486	4"	1
—	T412Z	—	4 ½"	1
T500	T500Z	9487	5"	1
—	T512Z	—	5 ½"	1
T600	T600Z	9734	6"	1

AIR TUBE SADDLE CLAMPS



P/N	SIZE	BOX QTY
4904	½"	25
4914	⅝"	25
4907	¾"	25
4925	1"	25

AUDI - VW- BMW MUSTANG SLEEVE CLAMPS

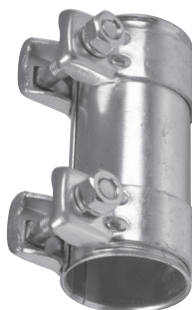

P/N	SIZE	LENGTH	PKG QTY
8640	2 ¼"	5"	1
8641	2"	5"	1
8642	2 ½"	5"	1

PREFORMED CLAMPS W/ GASKET - LAP JOINT



P/N	SIZE	MATERIAL
9700	3"	ALUMINIZED STEEL
9701	3 ½"	ALUMINIZED STEEL
9702	4"	ALUMINIZED STEEL
9703	5"	ALUMINIZED STEEL
9730	3"	BRIGHT 304 STAINLESS STEEL
9731	3 ½"	BRIGHT 304 STAINLESS STEEL
9732	4"	BRIGHT 304 STAINLESS STEEL
9733	5"	BRIGHT 304 STAINLESS STEEL

PREFORMED CLAMPS - LAP JOINT



P/N	SIZE	MATERIAL	P/N	SIZE	MATERIAL
9660	2"	ALUMINIZED STEEL	9664	2"	BRIGHT 304 STAINLESS STEEL
9661	2 ¼"	ALUMINIZED STEEL	9665	2 ¼"	BRIGHT 304 STAINLESS STEEL
9662	2 ½"	ALUMINIZED STEEL	9666	2 ½"	BRIGHT 304 STAINLESS STEEL
9663	2 ¾"	ALUMINIZED STEEL	9667	2 ¾"	BRIGHT 304 STAINLESS STEEL
9604	3"	ALUMINIZED STEEL	9668	3"	BRIGHT 304 STAINLESS STEEL
9605	3 ½"	ALUMINIZED STEEL	9669	3 ½"	BRIGHT 304 STAINLESS STEEL
9606	4"	ALUMINIZED STEEL	9623	4"	BRIGHT 304 STAINLESS STEEL
9607	5"	ALUMINIZED STEEL	9670	4 ½"	BRIGHT 304 STAINLESS STEEL
			9624	5"	BRIGHT 304 STAINLESS STEEL
			9671	6"	BRIGHT 304 STAINLESS STEEL

CLAMPS

PREFORMED CLAMPS - BUTT JOINT



P/N	SIZE	MATERIAL
9676	3"	ALUMINIZED STEEL
9678	3 ½"	ALUMINIZED STEEL
9680	4"	ALUMINIZED STEEL
9682	5"	ALUMINIZED STEEL
9683	6"	ALUMINIZED STEEL

P/N	SIZE	MATERIAL
9684	2"	BRIGHT 304 STAINLESS STEEL
9685	2 ¼"	BRIGHT 304 STAINLESS STEEL
9686	2 ½"	BRIGHT 304 STAINLESS STEEL
9687	2 ¾"	BRIGHT 304 STAINLESS STEEL
9688	3"	BRIGHT 304 STAINLESS STEEL
9690	3 ½"	BRIGHT 304 STAINLESS STEEL
9692	4"	BRIGHT 304 STAINLESS STEEL
9693	4 ½"	BRIGHT 304 STAINLESS STEEL
9694	5"	BRIGHT 304 STAINLESS STEEL
9695	6"	BRIGHT 304 STAINLESS STEEL

FLATBAND EXHAUST CLAMPS



P/N	SIZE	MATERIAL
AS200	2"	ALUMINIZED STEEL
AS214	2 ¼"	ALUMINIZED STEEL
AS212	2 ½"	ALUMINIZED STEEL
AS234	2 ¾"	ALUMINIZED STEEL
AS300	3"	ALUMINIZED STEEL
AS312	3 ½"	ALUMINIZED STEEL
AS400	4"	ALUMINIZED STEEL
AS500	5"	ALUMINIZED STEEL

P/N	SIZE	MATERIAL
SAS200	2"	BRIGHT 430 STAINLESS STEEL
SAS214	2 ¼"	BRIGHT 430 STAINLESS STEEL
SAS212	2 ½"	BRIGHT 430 STAINLESS STEEL
SAS234	2 ¾"	BRIGHT 430 STAINLESS STEEL
SAS300	3"	BRIGHT 430 STAINLESS STEEL
SAS312	3 ½"	BRIGHT 430 STAINLESS STEEL
SAS400	4"	BRIGHT 430 STAINLESS STEEL
SAS500	5"	BRIGHT 430 STAINLESS STEEL
SAS600	6"	BRIGHT 430 STAINLESS STEEL



FLATBAND EXHAUST CLAMPS

P/N	SIZE	MATERIAL
B200	2"	BRIGHT 304 STAINLESS STEEL
B214	2 ¼"	BRIGHT 304 STAINLESS STEEL
B212	2 ½"	BRIGHT 304 STAINLESS STEEL
B234	2 ¾"	BRIGHT 304 STAINLESS STEEL
B300	3"	BRIGHT 304 STAINLESS STEEL
B314	3 ¼"	BRIGHT 304 STAINLESS STEEL
B312	3 ½"	BRIGHT 304 STAINLESS STEEL
B400	4"	BRIGHT 304 STAINLESS STEEL
B412	4 ½"	BRIGHT 304 STAINLESS STEEL
B500	5"	BRIGHT 304 STAINLESS STEEL
B600	6"	BRIGHT 304 STAINLESS STEEL
B800	8"	BRIGHT 304 STAINLESS STEEL
B1000	10"	BRIGHT 304 STAINLESS STEEL



CHRYSLER V-BAND CLAMP

Fits 2 ½" Pre-Cat Inlet

P/N	SIZE	MATERIAL
8610	2 ½"	STAINLESS STEEL

CLAMPS

V-BAND CLAMPS

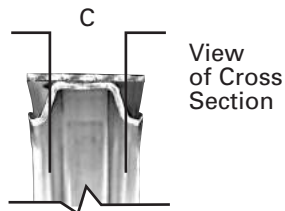
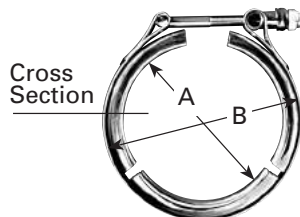

Manufacturer	P/N	Tube Dia.	A	B	C	Application
UNIVERSAL						
	9398	3.00	3.26	4.06	0.02	Fits - OEM MUFFLERS.
	9399	4.00	4.25	4.81	0.21	Fits - FLARED CONNECTORS.
	9616	5.00	4.97	5.25	0.26	Fits - FLARED CONNECTORS.
AIRESEARCH						
	9614	4.00	4.17	4.61	0.16	TEO-699
	9616	5.00	4.97	5.25	0.26	T-1899, TH08A64
BLUE BIRD						
	9618	2.75	2.80	3.20	0.26	REPLACES BLUEBIRD #1334226
	9618	2.75	2.80	3.20	0.26	94-98 BLUEBIRD TC2000 SCHOOL BUS W/5.9L
	9651	4.00	4.13	4.69	0.40	REPLACES BLUEBIRD #125046
	9651	4.00	4.13	4.69	0.40	BLUEBIRD ALL AMERICAN W/CAT3116 /TURBO
	9399	4.00	4.25	4.81	0.21	REPLACES BLUEBIRD #0997791
	9399	4.00	4.25	4.81	0.21	1980-90 BLUEBIRD SCHOOL BUS W/8.2LT
CATERPILLAR						
	9622	3.50	3.63	4.19	0.40	3208T
	9396	3.50	3.94	4.50	0.21	3208T
	9651	4.00	4.13	4.69	0.40	3208T
	9652	4.00	4.12	4.81	0.40	3176T
	9653	4.00	4.19	4.75	0.40	3176T
	9615	5.00	5.32	5.88	0.40	3406, 3406B, 3176
CUMMINS						
	9618	2.75	2.80	3.20	0.26	6BT5.9L, 6BTA5.9L
	9612	3.00	3.32	3.88	0.40	V555, V902, V903
	9627	3.50	3.69	4.25	0.40	VT555, VT-555 MANIFOLD
	9396	3.50	3.94	4.50	0.21	VT555, VT-555 MANIFOLD
	9652	4.00	4.12	4.81	0.40	L10
	9653	4.00	4.19	4.75	0.40	L10
	9615	5.00	5.32	5.88	0.40	750, N, 88NT, NTC, VT
DETROIT DIESEL						
	9395	3.00	3.26	3.82	0.21	6V53, 6V71
	9656	3.50	3.76	4.04	0.26	
	9613	3.50	3.77	4.33	0.21	
	9396	3.50	3.94	4.50	0.21	4-53, 8V71, 8V92
	9617	4.00	4.13	4.75	0.16	8.2LT
	9399	4.00	4.25	4.81	0.21	6-71T, 8.2N, 8.2T, 12V71
	9647	4.00	4.32	4.91	0.29	6-71N
	9735	4.00	4.97	5.25	0.26	8V-71T, 16V-71, 6V-92T, 8V-92, 8V-92T, 16V-92T
	9616	5.00	4.97	5.25	0.26	8V-71T
	9397	5.00	5.32	5.92	0.28	6V-92, 8V-71T (END AWAY FROM TURBO)
	9615	5.00	5.32	5.88	0.40	SERIES 60, 6-71T

CLAMPS

V-BAND CLAMPS (Cont.)

Manufacturer	P/N	Tube Dia.	A	B	C	Application
FORD						
	9610	3.00	3.25	3.87	0.43	FORD #E5HZ5A231B
	9618	2.75	2.80	3.20	0.26	93-95 B600/700 W/5.9LT
	9618	2.75	2.80	3.20	0.26	REPLACES FORD #F3HZ5A281A
	9656	3.50	3.76	4.04	0.26	FORD #E0HZ5A231B
	9625	3.00	3.05	3.62	0.28	REPLACES FORD #F1HZ5C210A, E9HZ5A231B
	9625	3.00	3.05	3.62	0.28	89-95 MED/TRUCK,BUS W/370, 429 GAS
	9395	3.00	3.26	3.82	0.21	ALL MODELS W/DD 6V53, 6V71
	9395	3.00	3.26	3.82	0.21	ALL MODELS W/CUMMINS V555, V902
	9626	3.00	3.17	3.88	0.40	FORD D9HT-51210-DA
	9626	3.00	3.17	3.88	0.40	79-88 FORD MED TRUCK/BUS W/370, 429 GAS
	9611	3.00	3.50	4.06	0.24	8.2L NA
	9622	3.50	3.63	4.19	0.40	REPLACES FORD #E2HZ5A231A
	9622	3.50	3.63	4.19	0.40	87-90 B600/700 SCHOOL BUS CF600/800 W/6.6LT
	9622	3.50	3.63	4.19	0.40	REPLACES FORD #E8HZ5A231E
	9627	3.50	3.69	4.25	0.40	87-94 CF600/800, F600/800 W/7.8LT
	9627	3.50	3.69	4.25	0.40	REPLACES FORD #E7HZ5A231C
	9617	4.00	4.13	4.75	0.16	REPLACES FORD #EOHZ5A231C
	9399	4.00	4.25	4.81	0.21	ALL MODELS W/DD 6-71T, 8.2N, 8.2T, 12V71
FREIGHTLINER						
	9601	3.50"	3.38"	3.75"	0.75"	02-06 FREIGHTLINER BUS W/MERCEDES ENG. OE#A04-19184-000
	9609	4.00	4.19	4.75	0.40	FREIGHTLINER BUS W/MERCEDES 6 CYL. ENG.
	9615	5.00	5.32	5.88	0.40	FLD MODELS W/DD SERIES 60, CAT 3406
	9615	5.00	5.32	5.88	0.40	FLD MODELS W/CUMMINS NTC, VT DIESEL
	9615	5.00	5.32	5.88	0.40	REPLACES FREIGHTLINER #0114596000
GM						
	9656	3.50	3.76	4.04	0.26	
	9611	3.00	3.50	4.06	0.24	80-90-GM MED TRUCK/BUS W/8.2L NA
	9611	3.00	3.50	4.06	0.24	REPLACES GM #2069773
	9652	4.00	4.12	4.81	0.40	TOPKICK/KODIAK W/6.6L
	9652	4.00	4.12	4.81	0.40	REPLACES GM #15647159
	9399	4.00	4.25	4.81	0.21	ALL MODELS W/DD6-71T, 8.2N, 8.2T, 12V71
INTERNATIONAL						
	9627	3.50	3.69	4.25	0.40	86-89 SERIES S TRUCK/BUS W/DT360
	9627	3.50	3.69	4.25	0.40	REPLACES INTERNATIONAL #893944R92
	9613	3.50	3.77	4.33	0.21	REPLACES INTERNATIONAL #338614C1
	9613	3.50	3.77	4.33	0.21	88-94 SERIES S TRUCK BUS W/DT466
	9396	3.50	3.94	4.50	0.21	REPLACES INTERNATIONAL #434252R91
	9396	3.50	3.94	4.50	0.21	ALL MODELS W/DD 4-53, 8V71, 8V92, CAT 3208T
	9396	3.50	3.94	4.50	0.21	ALL MODELS W/CUMMINS VT-555
	9737	3.00	3.28	3.84	0.40	T444E 1994-2000 INTERNATIONAL BUS
	9653	4.00	4.19	4.75	0.40	REPLACES INTERNATIONAL #893945R92
	9653	4.00	4.19	4.75	0.40	7.3L, DT-DTA 360, DT-DTA 466
	9647	4.00	4.32	4.91	0.29	REPLACES INTERNATIONAL #433192R91
	9647	4.00	4.32	4.91	0.29	ALL MODELS W/6-71N
	9735	4.00	4.97	5.25	0.26	9300 SERIES W/DD 8V71, 8V92
	9735	4.00	4.97	5.25	0.26	REPLACES INTERNATIONAL #5132650
	9735	4.00	4.97	5.25	0.26	REPLACES INTERNATIONAL # 780067C91
	9615	5.00	5.32	5.88	0.40	REPLACES INTERNATIONAL #390226C91
	9615	5.00	5.32	5.88	0.40	INTERNATIONAL #1672105C91

CLAMPS

V-BAND CLAMPS (Cont.)

Manufacturer	P/N	Tube Dia.	A	B	C	Application
MACK						
	9396	3.50	3.94	4.50	0.21	ALL MODELS W/DD 4-53, 8V71, 8V92, CAT 3208T
	9396	3.50	3.94	4.50	0.21	ALL MODELS W/CUMMINS VT-555
	9614	4.00	4.17	4.61	0.16	REPLACES MACK #48RU2341
	9614	4.00	4.17	4.61	0.16	DM/MR MODELS
	9399	4.00	4.25	4.81	0.21	ALL MODELS W/DD 6-71T, 8.2N, 8.2T, 12V71
	9619	4.00	4.38	4.94	0.18	REPLACES MACK #11ME29
	9615	5.00	5.32	5.88	0.40	REPLACES MACK #11ME241
PETERBILT						
	9616	5.00	4.97	5.25	0.26	PETERBILT #14-11039
THOMAS						
	9622	3.50	3.63	4.19	0.40	84-90 SAF-T-LINER MODELS W/3208T
	9622	3.50	3.63	4.19	0.40	REPLACES THOMAS #61240207
	9651	4.00	4.13	4.69	0.40	84-89 THOMAS SCHOOL BUS W/ 3208T
	9651	4.00	4.13	4.69	0.40	REPLACES THOMAS #61240208
	9397	5.00	5.32	5.92	5.92	90-93 THOMAS SCHOOL BUS W/6V92
	9397	5.00	5.32	5.92	5.92	REPLACES THOMAS #61240715

CLAMPS

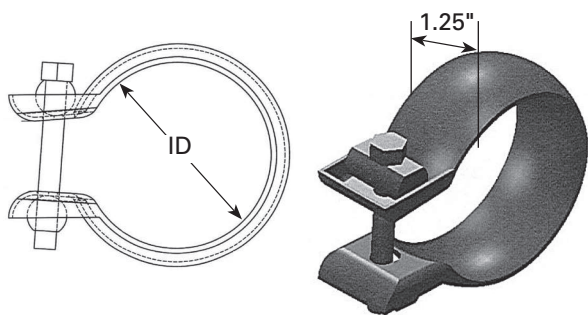

GM SWIVEL JOINT CLAMP

P/N	INSIDE DIAMETER
8620	2.65" ID
8625	2.95" ID

8620
8625

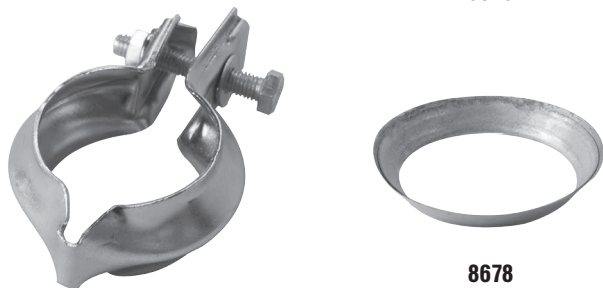

1995-2006 TOYOTA/SCION 1.5L

P/N	O.E. NUMBER
8901	9046115013
8678	9091706082

8901

8678

HANGERS

MUFFLER SHOP HANGER

SADDLE SWIVELS ON RUBBER STRAP

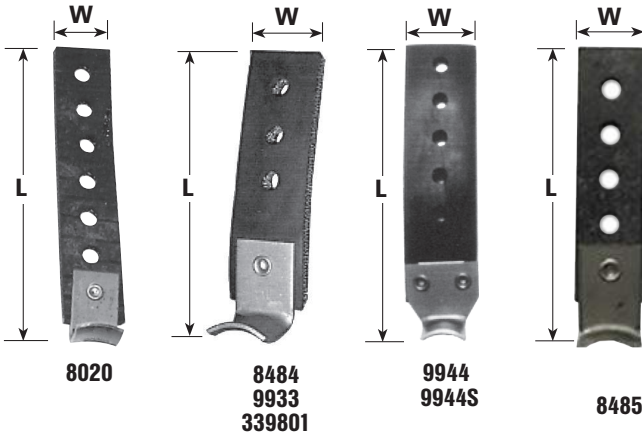

P/N	SIZE	BOX QTY
8484	5 1/2" L x 1 3/8" W x 3/8" D	1
9933	5 1/2" L x 1 3/8" W x 3/8" D	100
339801	5 1/2" L x 1 3/8" W x 3/8" D	100
8485	5 3/4" L x 1 3/8" W x 5/8" D	1
8020	7" L x 1 1/8" W x 5/8" D	1
9944	8" L x 2" W x 1 1/2" D	50
9944S	8" L x 2" W x 1 1/2" D	1

UNIVERSAL HANGER

BULK P/N	BOX QTY	SINGLE PACK P/N	LENGTH	ROD DIA
339816	50	339816S	10"	3/8"
339819	50	339819S	10"	3/8"
339820	25	339820S	10"	1/2"
339821	50		NA	3/8"

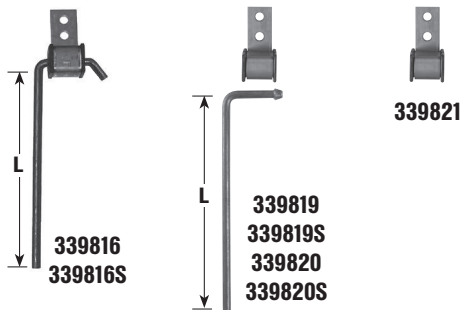

UNIVERSAL HANGER

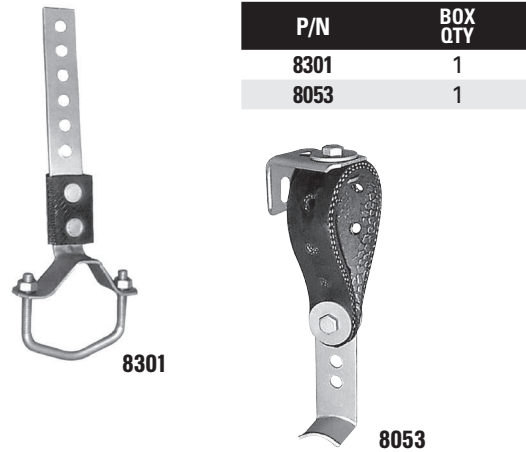

P/N	BOX QTY
8301	1
8053	1

HEAVY DUTY UNIVERSAL TRUCK HANGER



P/N	BOX QTY
8462	1

Fabric has 3 holes for adjusting bracket position.

CHRYSLER HANGER



P/N	BOX QTY
8588	1

GM HANGER

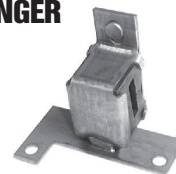

P/N	BOX QTY
8011	1

HANGERS

UNIVERSAL WIRE HANGERS

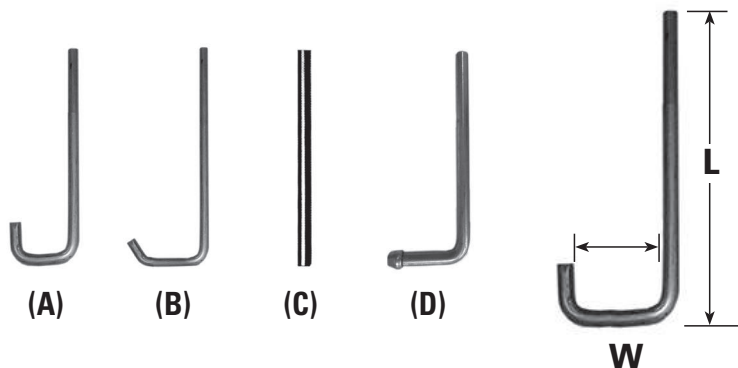

P/N	LENGTH	WIDTH	WIRE ROD	TYPE	BOX QTY
FW2014	14"	—	5/16"	C	25
FW2906	6"	1 1/4"	5/16"	A	25
FW2908	8"	1 1/4"	5/16"	A	25
FW3408	8 1/2"	2"	3/8"	B	25
FW3908	8"	1 1/4"	3/8"	A	25
FW3921	10"	2"	3/8"	A	25
FW3928	8"	2"	3/8"	A	25
FW3951	10"	2"	3/8"	D	25
FW5014	14"	—	1/2"	C	15
FW5908	8"	1 1/2"	1/2"	A	15
FW5951	10"	2"	1/2"	D	15
FW5958	8"	2"	1/2"	D	15

UNIVERSAL WIRE HANGERS

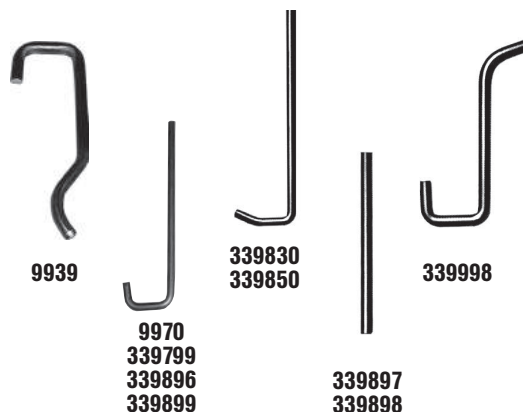

P/N	LENGTH	WIRE ROD	BOX QTY
9939	5 1/2"	3/8"	50
9970	5 1/8"	3/8"	50
339799	7 1/2"	3/8"	25
339830	10"	3/8"	25
339850	10"	1/2"	15
339896	7 1/2"	5/16"	25
339897	14"	3/8"	25
339898	10"	5/16"	25
339899	9"	5/16"	25
339998	6"	5/16"	100

SPECIALTY HANGER



P/N	BOX QTY
339995 (Bulk)	10
8516	1

O-RING/BACKET



P/N	BOX QTY
9959 (Bulk)	50
8166	1

UNIVERSAL BRACKET

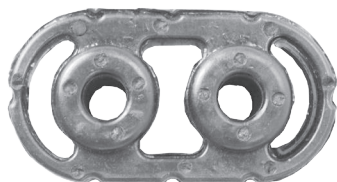

P/N	LENGTH	WIDTH	DEPTH	HOLE DIA.	QTY
8172	2 7/8"	1 1/2"	7/8"	1 1/32"	1

GM UNIVERSAL MIDGET 360° HANGERS

These hangers pivot 90° at two separate points and rotate 360° for maximum flexibility.

OPEN END



9943 - Bulk Part No.
8236 - Single Pack No.

CLOSED END



339860 - Bulk Part No.
339860S - Single Pack No.

360° HANGERS

360° HANGERS

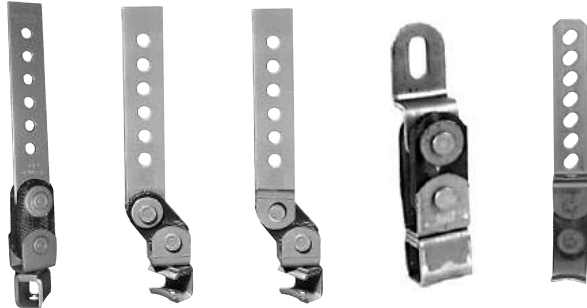

8049
8051
8052
339993

8050
339861

8483
9937

339994

339818
339818S

BULK P/N	BOX QTY	SINGLE PACK P/N	TYPE	LENGTH
—	1	8049	Reg. Closed	9 ½"
—	1	8050	Reg. Open	9 ¾"
—	1	8052	Med. Closed	13 ¼"
—	1	8051	Long Closed	17 ¼"
—	1	8483	Reg. Open	9 ½"
9937	50	—	Reg. Open	9 ½"
339818	50	339818S	Reg. Curved	9 ½"
339861	50	—	Reg. Open	9 ¾"
339993	50	—	Reg. Closed	9 ½"
339994	50	339994S	Short Closed	5 5/8"

BRACKETS

CHRYSLER TAIL PIPE BRACKET



P/N	BOX QTY
9950 (Bulk)	50
8503	1

UNIVERSAL TAIL PIPE BRACKET



P/N	BOX QTY
9952 (Bulk)	10
8251	1

UNIVERSAL BRACKET Individually Boxed



P/N	BOX QTY
8506	1

DUAL TAIL PIPE BRACKET



P/N	BOX QTY
8322	1

GM OFFSET BRACKET



P/N	BOX QTY
8509	1

OPEN GM UNIVERSAL BRACKET



P/N	BOX QTY
8510	1

GM BRACKET



8015



8245
9961



8111

P/N	BOX QTY
8015	1
9961 (Bulk)	25
8245	1
8111	1

BRACKETS

TYPICAL ASSEMBLY OF A UNIVERSAL ROD BRACKET



P/N	BOX QTY
9945	50

BELLY BANDS Individually Boxed



8079
BMW



8637
BMW



8022
Chrysler/Dodge



8055
Chrysler/Dodge



8067
Chrysler/Dodge



8359
Chrysler/Dodge



8016
Ford



8017
Ford



8080
Ford



8085
Ford



8157
Ford



8158
Ford



8174
Ford

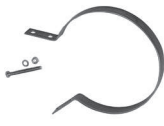

8213
Ford



8013
GM OE Style



8014
GM OE Style



8054
GM



8056
GM



8062
Late Model GM



8081
GM Early Model



8169
GM



8076
Mazda



8175
Mazda



8087
Saturn



8010
Toyota



8074
Volvo



8077
Volvo



8078
Volvo



8148
Volvo

BRACKETS & STRAPS

UNIVERSAL BRACKET



339984
339985

P/N	TYPE	BOX QTY
339984	L-Bracket (2 1/2" x 1 1/2")	10
339985	L-Bracket (2 3/4" x 2 3/4")	50

CHRYSLER BRACKET



P/N	BOX QTY
8227	1

STRAIGHT STEEL STRAP With 3/8" Holes

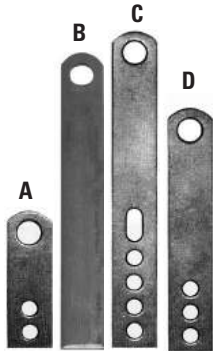

NOTE:
Std. 1/8" Thick
H.D. 3/16" Thick

P/N	LENGTH	TYPE	BOX QTY
9923	3 1/4"	Std. A	10
9924	4 1/2"	Std. D	50
339811	4 1/2"	Std. A	50
339812	4 1/2"	H.D. A	25
9925	5 3/4"	Std. D	50
339813	5 3/4"	H.D. A	25
339814	7"	H.D. A	25
339822	7"	H.D. B	25
339894	7"	Std. C	50
339895	7"	Std. A	50
339800	8 7/8"	H.D. C	25
9926	9"	Std. D	50
339815	9"	H.D. A	25
339823	9"	H.D. B	25
339827	9"	H.D. C	25
339810	11"	H.D. A	25
9927	14"	Std. D	50

90° STEEL STRAP With 3/8" Holes



NOTE:
Std. 1/8" Thick
H.D. 3/16" Thick

P/N	LENGTH	TYPE	BOX QTY
9928	3"	Std. D	50
339803	3"	H.D. A	25
339804	4 1/4"	Std. A	50
339805	4 1/4"	H.D. A	25
9929	5"	Std. D	50
339806	5 1/2"	H.D. A	25
339808	7 1/2"	H.D. A	25
339824	7 1/2"	Std. C	50
339809	9"	H.D. A	25
339825	9"	H.D. C	25
339826	9"	H.D. B	25
339802	12 1/2"	H.D. A	50

GM TRUCK BRACKET



P/N	BOX QTY
9962	50
8560	1

UNIVERSAL STRAP HOOK



8047B10



8048B10

P/N	SIZE	TYPE	BOX QTY
8045B10	In-line	1/2" Rod	10
8046B10	90°	1/2" Rod	10
8047B10	In-line	3/8" Rod	10
8048B10	90°	3/8" Rod	10

RUBBER GROMMETS

RUBBER GROMMET SET



P/N	COLOR	TYPE	BOX QTY
F5118	Black	w/o Washer	100
F5120	Red	w/ Washer	100
F5121	Blue	Hi-Temp, w/ Washer	100

Used with 90° and straight steel strap to prevent frame rattle.

RUBBER GROMMETS (con't)

RUBBER GROMMETS



P/N	TYPE	BOX QTY
F5178	Female Grommets	100
F5179	Male Grommets	100

Used with 90° and straight steel strap to prevent frame rattle.

CLAMP-A-STUD



P/N	SIZE	BOX QTY
8028	¼" - 1 ¾"	1
8027	1 ¼" - 2 ¼"	1
8026	2 ¼" - 3 ¼"	1

HEAT SHIELDS

UNIVERSAL MUFFLER HEAT SHIELD

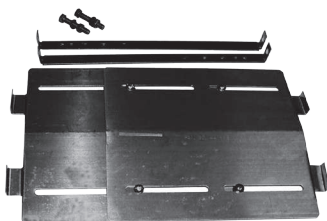

P/N	BOX QTY
9206	1

UNIVERSAL HEAT SHIELD STRAP



P/N	LENGTH	WIDTH
9199	34"	½"

BENDABLE UNIVERSAL PIPE HEAT SHIELD

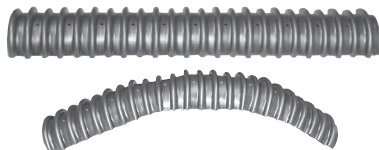

P/N	SIZE	FITS PIPE	BOX QTY
9208	12"	2 ¼" - 3" Diameter	5
9209	18"	2 ¼" - 3" Diameter	5
9210	12"	2" Diameter and less	5
9211	18"	2" Diameter and less	5

HEAT RISERS - Small Block Chevrolet V8

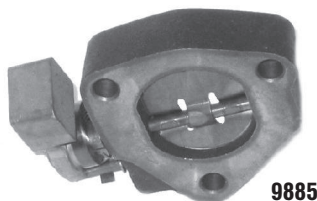

9885

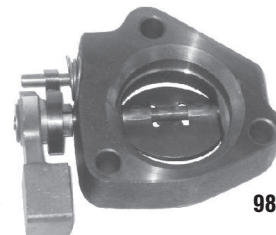

9886

P/N 9885	(OEM #3887023)
65-75	Camaro
68-75	Chevelle
75-78	Chev/GMC Truck

NOTE: Use 8710 Gasket

P/N 9886	(OEM #3887024)
65-69	Chevrolet Full-Size
57-75	Corvette Exc. High Performance

NOTE: Use 8441 Gasket

The HUSH Studfix

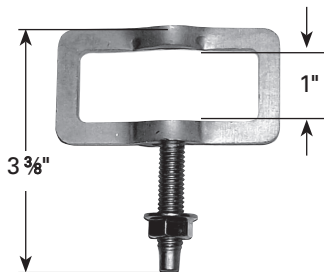

8001 - Pkg. Qty. 2
Ford Trucks

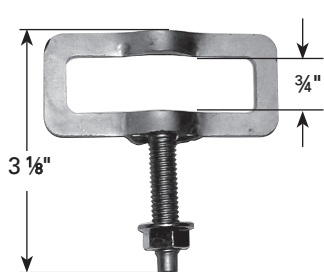

8002 - Pkg. Qty. 2
Ford Cars

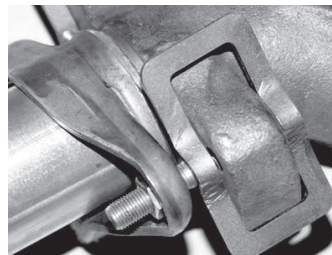

The HUSH Studfix installed

SPLIT FLANGES & MISC.

SPLIT CONVERTER FLANGES

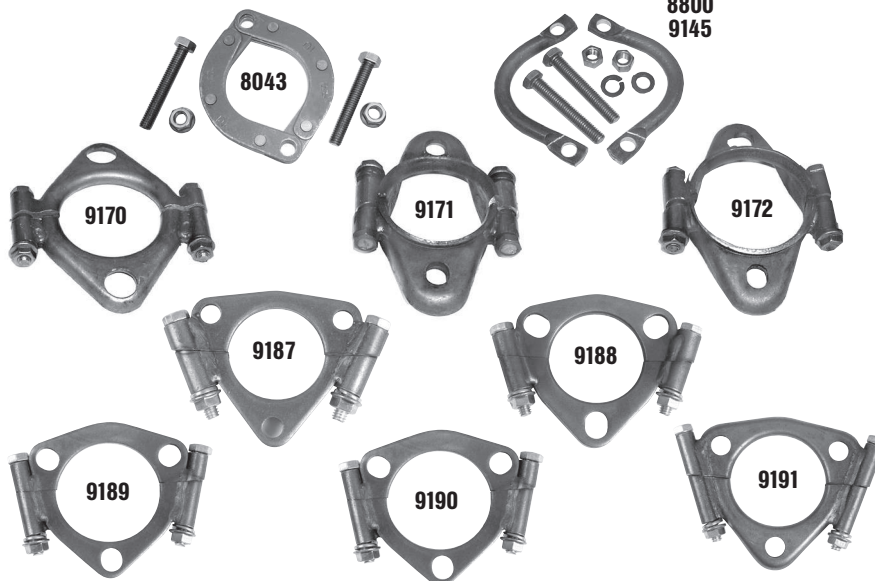

P/N	SIZE	BOX QTY
9145	1 3/4" - 2"	1
9187	1 7/8"	1
8043	2" - 2 1/4"	1
9171	2 3/32"	1
9188	2 1/8"	1
8800	2 1/4" - 2 1/2"	1
9170	2 5/16"	1
9172	2 7/16"	1
9191	2 7/16"	1
9189	2 1/2"	1
9190	2 5/8"	1

SPLIT FLANGES Individually Boxed

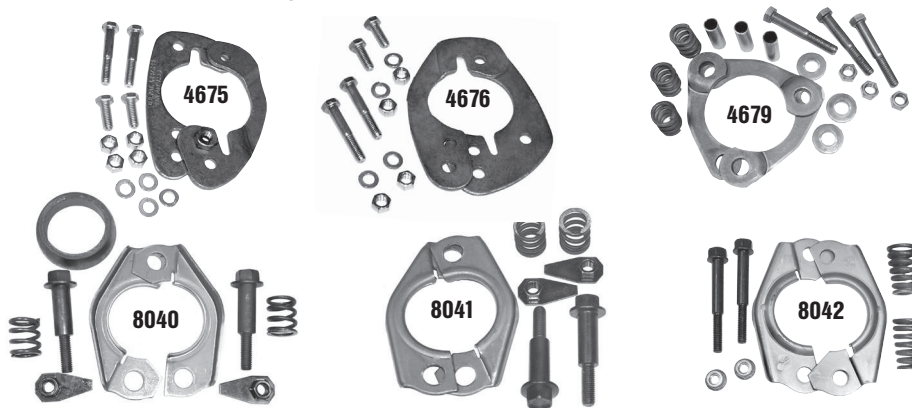

P/N	TYPE
4675	GM
4676	Universal
4679	GM
8040	Ford
8041	Ford
8042	Chrysler

BOLTS, NUTS & SCREWS

HEX HEAD BOLTS – GRADE #2 & #5

Standard Thread Length



P/N	SIZE	GRADE	BOX QTY
F5285	5/16" x 1 1/4"	5	100
F5292	5/16" x 1 1/2"	2	100
F5229	5/16" x 2"	2	100
F5230	5/16" x 2 1/2"	2	100
F5293	3/8" x 1 1/4"	2	100
F5231	3/8" x 1 1/2"	2	100
F5290	3/8" x 1 1/2"	5	100
F5233	3/8" x 3 1/2"	2	50

FULL Thread Length



P/N	SIZE	GRADE	BOX QTY
F5228	5/16" x 1"	2	100
F5284	5/16" x 1"	5	100
F5160	5/16" x 1 1/2"	2	100
F5306	5/16" x 2"	2	100
F5169	3/8" x 1"	2	100
F5288	3/8" x 1"	5	100
F5289	3/8" x 1 1/4"	5	100
F5307	3/8" x 1 1/2"	2	100
F5170	3/8" x 2"	2	100
F5226	3/8" x 2 1/2"	2	50
F5232	3/8" x 3"	2	50

BOLTS, NUTS & SCREWS

METRIC HEX HEAD BOLTS



P/N	SIZE	PITCH	LENGTH	THREAD	BOX QTY
F5222	8MM	1.25	40MM (Full)	Std.	100
F5223	10MM	1.25	30MM (Full)	Fine	50
F5310	10MM	1.50	25MM (Full)	Std.	100
F5312	10MM	1.50	50MM (Std.)	Std.	50

HEX HEAD NUTS

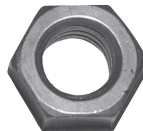

P/N	SIZE	THREAD	BOX QTY	P/N	SIZE	THREAD	BOX QTY
F5161	5/16"	Std.	100	F5240	3/8" (Flange)		100
F5163	3/8"	Std.	100	F5243	1/2" Std.		50
F5164	7/16"	Std.	50	F5301	5/16" (Flange)		100
F5180•	3/8" x 5/8"	Coarse	10	F5302	7/16" x 5/8"	Std.	100
F5181•	7/16" x 5/8"	Coarse	10				

• High Style Brass

SELF TAPPING SCREWS



P/N	SIZE	BOX QTY
F5173	5/16" x 1"	100
F5165	5/16" x 1 1/2"	100
F5250	3/8" x 1"	100
F5251	3/8" x 1 1/2"	100

HEX HEAD NUTS (METRIC)

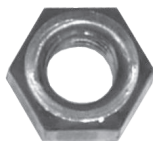

P/N	SIZE	PITCH	THREAD	BOX QTY
F5216	8MM	1.25	Std.	100
F5217	10MM	1.25	Fine	100
F5218	10MM	1.50	Std.	100
F5314	10MM	1.50	Flange	10

STUDS, WASHERS & SHIMS

MANIFOLD STUDS

With Finder Point



Standard Length

P/N	SIZE	BOX QTY
F5298	3/8" x 2"	100
F5300	3/8" x 2 1/4"	100
F5210	3/8" x 2 1/2" (w/ finder pt)	100
F5299	3/8" x 3" (w/ finder pt)	50
F5211	3/8" x 3 1/4"	50
F5254	3/8" x 3 1/2" (w/ finder pt)	50
F5209	7/16" x 2 1/2"	50
F5297	7/16" x 2 3/8" coarse, (w/ finder pt)	50

Metric Length

P/N	SIZE	BOX QTY
F5259	8MM x 1.25 x 40MM	100
F5213	10MM x 1.50 x 50MM	100
F5261	10MM x 1.25 x 42MM	100
F5262	10MM x 1.25 x 48MM	100

Without Finder Point



STUDS, WASHERS & SHIMS

LOCK WASHERS GRADE #2



P/N	SIZE	BOX QTY
F5162	5/16"	100
F5176	3/8"	100
F5177	7/16"	100

FLAT WASHERS GRADE #2



P/N	BOLT SIZE X OD	BOX QTY
F5266	5/16" x 7/8"	100
F5267	5/16" x 9/16"	100
F5174	5/16" x 1 1/4"	100
F5268	3/8" x 1"	100
F5265	3/8" x 1 1/2"	100
F5269	3/8" x 1 3/16"	100
F5271	7/16" x 1 5/16"	100
F5270	7/16" x 1 1/4"	100

MANIFOLD SHOULDER BOLTS & SPRINGS



4678
Acura/Chrysler/
Honda/Subaru



4682
Acura/Honda
(2 each per kit)



4975
Chrysler



4973
Ford/Mazda



4971S (Single)
GM/Ford/Mazda
4971 (10/box)



4976
GM/Chrysler

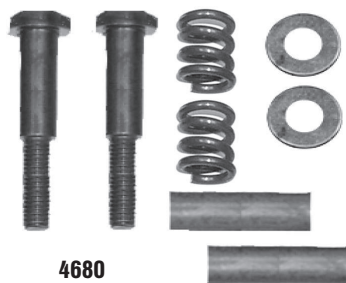

4680
GM/Geo/Suzuki/Toyota



4970
GM/Subaru



4972
GM

MANIFOLD SHOULDER BOLTS & SPRINGS



4974
GM



8037
GM

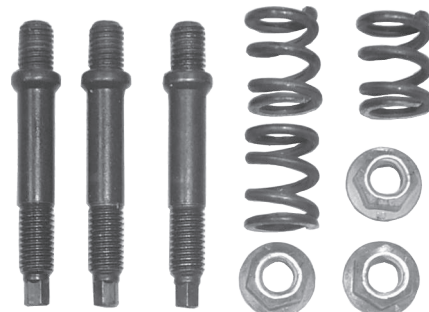

8038
GM



8039
Subaru



4978
Toyota



4979
Toyota



F5309
Universal Spring
(10 per box)

JOINT CONNECTOR

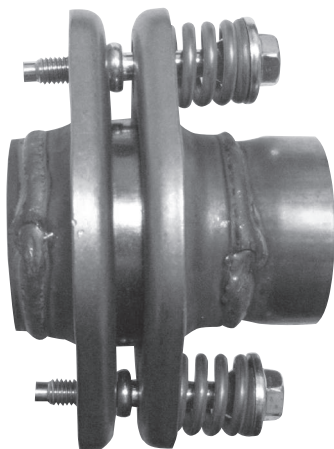

JOINT CONNECTOR

P/N	DESCRIPTION
8802	Fits 1 3/4" and 2" pipes Gasket included. Stainless Steel

UNIVERSAL & SPECIAL APPLICATION FLANGES

3-HOLE UNIVERSAL FLANGE



P/N	SIZE	BOX QTY
9152	2"	10
9152S	2"	1
8032	2 5/8"	1
8033	3 1/16"	1

2-HOLE UNIVERSAL FLANGE



P/N	SIZE	BOX QTY
9153	1 3/4"	10
9153S	1 3/4"	1
8036	1 3/4"	1

Note: 9153, 9153S - 5/16" thick
8036 - 3/8" thick

2-HOLE UNIVERSAL FLANGE



P/N	SIZE	BOX QTY
9154	2 1/8"	10
9154S	2 1/8"	1

2-HOLE UNIVERSAL FLANGE



P/N	SIZE	BOX QTY
9155	2 5/16"	10
9155S	2 5/16"	1
8035	2 3/8"	1

2-HOLE UNIVERSAL FLANGE



P/N	SIZE	BOX QTY
9156	2 9/16"	10
9156S	2 9/16"	1

3-HOLE UNIVERSAL FLANGE



P/N	SIZE	BOX QTY
9158	2 5/16"	10
9158S	2 5/16"	1

4-HOLE GM FLANGE



P/N	SIZE	BOX QTY
9160	2 1/4"	10
9160S	2 1/4"	1

4-HOLE GM FLANGE



P/N	SIZE	BOX QTY
9161	2"	10
9161S	2"	1

OEM STYLE FLANGE - FORD



P/N	SIZE	BOX QTY
8029	2 9/16"	1

OEM STYLE FLANGE - FORD



P/N	SIZE	BOX QTY
8030	2 1/16"	1

OEM STYLE FLANGE - FORD



P/N	SIZE	BOX QTY
8031	2 5/16"	1

EXHAUST PIPE FLANGE CHARTS

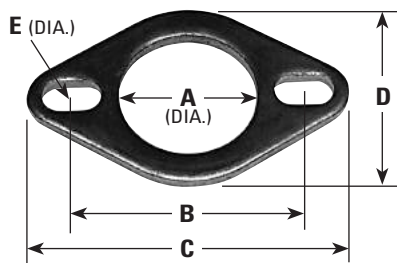

P/N	A	B	C	D	E
8035	2 3/8"	3 7/8"	5 1/4"	3 1/2"	1/2" x 7/8" slot
8036	1 3/4"	3 1/2"	4 3/4"	3"	1/2" x 3/4" slot
8788	2"	3"	4"	2 3/4"	1/2"
8793	2 3/32"	3 1/2"	5"	3 1/32"	7/16"
9128	2 3/32" *	3 1/8"	5"	3 1/32"	1/2" x 29/32" slot
9153#	1 3/4"	3 1/2"	4 3/4"	3"	1/2" x 3/4" slot
9153S	1 3/4"	3 1/2"	4 3/4"	3"	1/2" x 3/4" slot
9154#	2 1/8"	3 1/2"	4 3/4"	3"	1/2" x 3/4" slot
9154S	2 1/8"	3 1/2"	4 3/4"	3"	1/2" x 3/4" slot
9155#	2 5/16"	3 7/8"	5 1/4"	3 1/2"	1/2" x 7/8" slot
9155S	2 5/16"	3 7/8"	5 1/4"	3 1/2"	1/2" x 7/8" slot
9156#	2 9/16"	3 7/8"	5 1/4"	3 1/2"	1/2" x 7/8" slot
9156S	2 9/16"	3 7/8"	5 1/4"	3 1/2"	1/2" x 7/8" slot
9175	1 7/8"	3 1/8"	4 1/4"	2 3/4"	9/16" x 1 1/16" slot
9176	2 1/16"	3 1/16"	4 1/4"	2 3/4"	9/16" x 1 1/16" slot
9179	2 1/16"	3 1/2"	4 7/8"	3 1/16"	7/16" x 7/8" slot
9181	2"	3 1/2"	4 3/4"	3"	1/2" x 3/4" slot
9184	2 1/16"	3"	4"	2 3/4"	1/2"
9185	2 1/4"	3 7/16"	4 1/2"	3"	1/2"

* w/chamfer

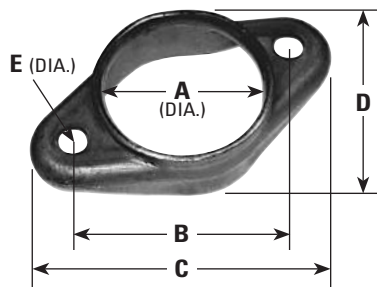

P/N	A	B	C	D	E
8776	2 1/8"	3 1/8"	4 1/2"	3 1/4"	7/16"
8777	2 7/16"	3 5/8"	5"	2 7/8"	7/16" x 9/16" slot
8786	2 7/16"	3 3/4"	5 1/8"	2 15/16"	7/16"
8792	2 11/16"	3 3/4"	5 1/4"	2 7/8"	7/16"
8796	2 1/4"	3 9/16"	5"	2 3/4"	3/8" x 7/16" slot
8798	2 1/8"	3 3/4"	5 1/8"	2 3/8"	7/16"
9569	2 31/32"	4 3/32"	5 1/2"	3 1/2"	7/16"
9147	2 5/16"	4"	5 3/8"	3 3/8"	13/16"
9150	2 1/8"	3 5/8"	4 3/4"	2 9/16"	7/16" x 9/16" slot
9162	2 5/8"	4 3/4"	6 1/8"	3"	7/16"
9166	3 1/12"	4 1/4"	6 5/64"	3 9/16"	7/16"
9167	2 1/2"	4"	5 3/8"	3 3/8"	3/4"

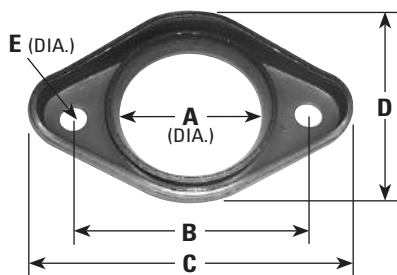

P/N	A	B	C	D	E
8789	2 1/16"	3 1/8"	4 1/8"	3 1/4"	1/2"
9140	2 1/4"	4"	5 7/16"	3 3/8"	7/16"
9164	2 9/16"	3 15/16"	5 1/8"	3 7/16"	23/32"

EXHAUST PIPE FLANGE CHARTS

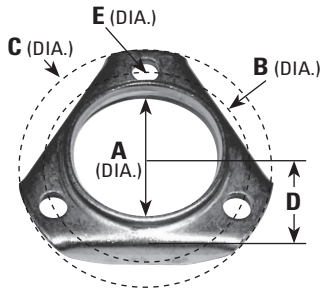

P/N	A	B	C	D	E
8780	2 1/8"	3 1/8"	3 7/8"	1 7/16"	7/16"

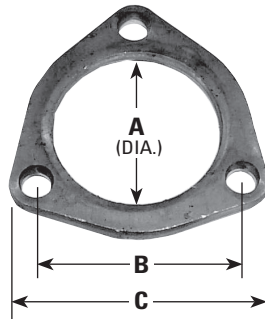

P/N	A	B	C
8032	2 5/8"	3 3/16"	3 7/8"
8033	3 1/16"	3 5/16"	4 1/8"
8034	2 5/8"	3 1/16"	3 7/8"
8799	2 7/16"	2 13/16"	3 5/8"
9152#	2"	2 11/16"	3 3/4"
9152S	2"	2 11/16"	3 3/4"
9158#	2 5/16"	2 11/16"	3 15/16"
9158S	2 5/16"	2 11/16"	3 15/16"
9173	2 1/2"	3 1/8"	3 15/16"
9177	2 1/8"	2 11/16"	3 5/8" (rad.)
9178	2 5/8"	3 1/16"	3 7/8"
9180	3 1/16"	3 5/16"	4 1/8"

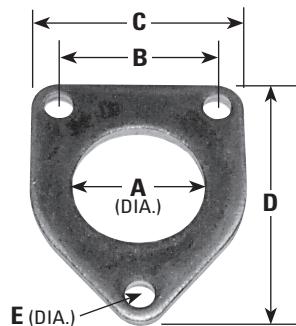

P/N	A	B	C	D	E
9174	2"	2 7/16"	3 3/8"	4 3/16"	7/16"

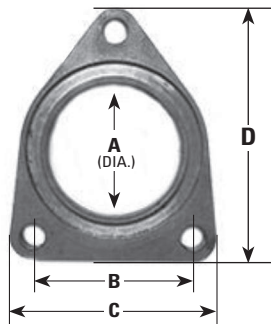

P/N	A	B	C	D
9120	2 17/32" *	3"	3 7/8"	4 3/4"

* w/chamfer

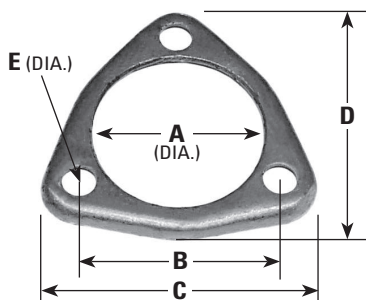

P/N	A	B	C	D	E
8775	2 5/16"	2 7/8"	4 5/16" (rad.)	4 1/2" (rad.)	7/16"
8787	2 11/16"	3 1/8"	4 5/16" (rad.)	4 1/8" (rad.)	1/2"
9146	2 5/8"	3 1/2"	4 33/64" (rad.)	4 19/64" (rad.)	27/64"

EXHAUST PIPE FLANGE CHARTS

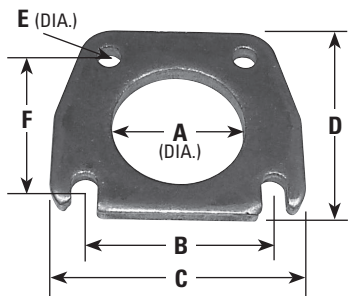

P/N	A	B	C	D	E	F
9160#	2 ¼"	2 ¾"/3 ⅞"	4 ⅝"	3 ⅝"	7/16"	2 ⅞"
9160S	2 ¼"	2 ¾"/3 ⅞"	4 ⅝"	3 ⅝"	7/16"	2 ⅞"
9161#	2"	2 ¾"/3 ⅞"	4 ¼"	3 21/32"	7/16"	2 ⅞"
9161S	2"	2 ¾"/3 ⅞"	4 ¼"	3 21/32"	7/16"	2 ⅞"

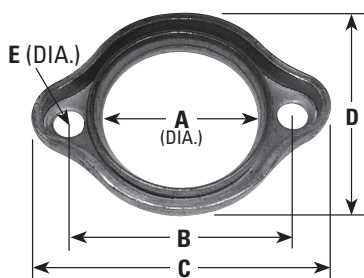

P/N	A	B	C	D	E
8029	2 9/16"	3 ¾"	4 15/16"	3 9/16"	½"
8030	2 1/8"	3 ½"	4 5/8"	3 3/8"	½"
8031	2 5/16"	3 13/16"	4 15/16"	3 9/16"	½"
8778	2 7/8"	4 1/8"	4 ½"	3 9/16"	9/16"
8781	2 1/8"	3 1/8"	4 ¼"	3 ¼"	7/16"
9159	2 1/8"	3 ½"	4 ¾"	3"	½ x ¾" slot

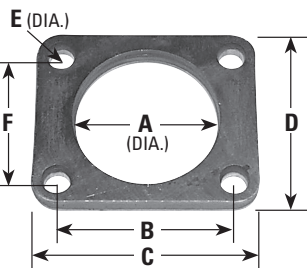

P/N	A	B	C	D	E	F
9143	2 9/16"	2 13/16"	3 9/16"	3 ¼"	3/8"	2 7/16"
9586	4 1/8"	4 3/16"	6"	6"	5/8"	4 3/16"

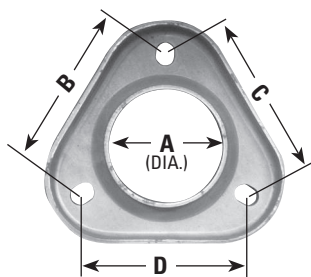

P/N	A	B	C	D
9149	2 9/16"	3 11/16"	3 11/16"	3 13/16"

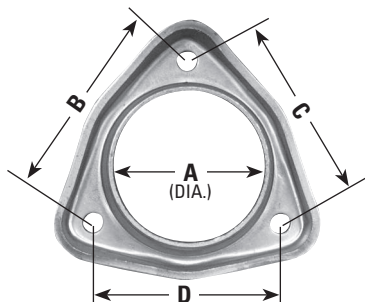

P/N	A	B	C	D
9165	2 27/32"	3 11/16"	3 5/8"	3 13/16"

EXHAUST GASKET CHARTS

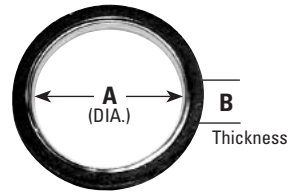

GASKET NO.	A	B
8421	3 3/32"	3/16"
8449	3 13/32"	7/32"
8470	2 13/16"	5/32"
8690	1 3/4"	3/16"
8731°	2"	1/16"
8733	1 15/16"	5/32"
8737	2 5/32"	3/16"
8749	1 13/16"	3/16"
8764°	5 9/64"	3/16"
8770	1 9/16"	3/16"
9016	2 3/8"	3/16"
9024	1 31/32"	3/16"
9026	2 19/32"	3/16"
9027	2 3/16"	1/8"
9066	1 7/8"	3/16"
9100	2 1/16"	1/16"
9207	2 31/32"	3/16"
9218°	2 3/4"	3/16"
9233	2 1/32"	15/32"
9282	2 3/8"	3/16"

° Metal with Fiber Core

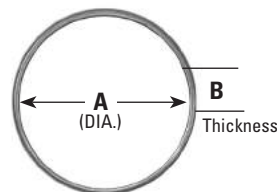

GASKET NO.	A	B
8424	2 7/16"	5/32"
8437	4 7/32"	1/8"
8457	2 29/32"	11/64"
8467	2 9/16"	5/32"
8469	3 3/16"	5/32"
8693	2"	3/16"
8702	2 9/32"	3/16"
8762	2 13/16"	5/32"
9044	2 13/32"	7/32"
9059	2 5/8"	3/16"
9061	2"	1/8"
9080	2 3/32"	5/32"
9252	1 13/16"	3/16"
9267	1 7/8"	3/16"
9268	2 7/32"	5/32"

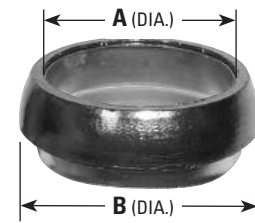

GASKET NO.	A	B
8408	2 5/16"	3 1/8"
8418	2 17/32"	3 7/16"
8444	2 5/16"	3"
8450	2 9/16"	3 1/16"
8698 ²	2 1/8"	2"
8699 ²	2 1/8"	2"
8763	2 1/8"	2 1/8"
8769	1 29/32"	1 7/8"
9051	2 3/8"	2 5/8"
9052	2 3/8"	2 3/8"
9091 ¹	1 11/16"	1 7/8"
9093 ³	1 15/16"	2 1/4"
9212	1 27/32"	2"
9220 ³	1 3/4"	2"
9234	2 1/8"	2 13/32"
9259	2"	2 1/2"
9260	2 3/8"	3 3/16"
9261	2 1/4"	2 1/2"
9272	2 1/8"	2 1/2"

¹ Graphoil Material

² Sintered Iron Material

³ Metal Mesh Material

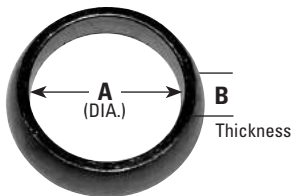

GASKET NO.	A	B
8406	2 9/16"	1 1/16"
8410	1 1/2"	1/2"
8411	2 3/8"	37/64"
8415	2 3/8"	1 1/16"
8423	2 3/16"	1 1/16"
8425	2 31/32"	45/64"
8427	2 9/32"	1/2"
8434	1 23/32"	3/8"
8443	1 31/32"	9/16"
8458	1 55/64"	15/32"
8460	2 27/32"	1/2"
8473	2 17/32"	9/16"
8482	1 25/32"	2 1/32"
8489	1 15/16"	7/16"
8490	2 13/32"	27/64"
8706 ¹	1 25/32"	1/2"

GASKET NO.	A	B
9002	2 3/16"	5/8"
9003 ²	2 1/32"	19/32"
9019	2 1/8"	5/8"
9056 ²	2 1/8"	1/2"
9082 ¹	2 13/16"	19/32"
9084 ²	2 1/8"	3/4"
9087 ¹	2"	1/2"
9090 ¹	2"	5/8"
9094 ¹	1 3/4"	9/16"
9095 ¹	2 5/16"	5/8"
9215	1 29/32"	2 1/32"
9216	2 3/8"	5/8"
9221 ¹	2 1/4"	1/2"
9225 ³	2 5/16"	1 1/16"
9231 ³	2"	9/16"
9236 ¹	1 11/16"	5/8"
9240 ¹	1 11/16"	1/2"
9248 ³	2 1/2"	15/32"
9257	2 5/32"	2 1/32"
9264 ¹	2 1/16"	5/8"
9290 ¹	1 29/32"	5/8"

¹ Graphoil Material

² Sintered Iron Material

³ Metal Mesh Material



GASKET NO.	A	B
8435	2 1/8"	2"

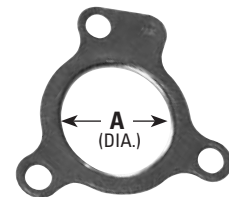

GASKET NO.	A
9047	1 13/16"
9247	2 1/32"
9251	1 15/16"

EXHAUST GASKET CHARTS

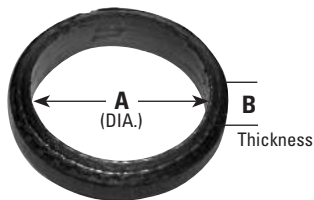

GASKET NO.	A	B
8420 ²	2 ¼"	9/16"
8440	1 13/32"	5/8"
8715	1 7/8"	5/8"
8717	2 1/32"	5/8"
8738	2 ½"	5/8"
8740 ²	1 13/16"	9/16"
8744	2 1/8"	¾"
8766 ^{2,3}	2 1/8"	¾"
8767 ³	2 3/8"	7/8"
8773	2 ¼"	5/8"
9001	1 7/8"	9/16"
9004	1 25/32"	5/8"
9005	1 31/32"	9/16"
9007	2 1/32"	¾"
9008	1 15/16"	9/16"
9017 ^{2,3}	2 9/32"	15/32"
9038 ^{3,4}	1 ¾"	¾"
9055	1 ¾"	5/8"
9057 ^{3,4}	1 5/8"	¾"
9083 ^{3,4}	2"	½"
9086 ²	2 7/32"	5/8"
9118	2 9/16"	½"
9217 ^{2,3}	2 13/32"	13/16"
9295	1 13/16"	¾"
9743 ²	2 ¾"	5/8"

² Sintered Iron Material

³ For Spherical Flare Use

⁴ Formed Metal Material

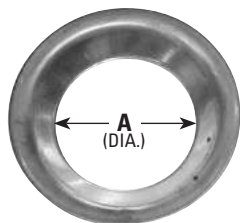

GASKET NO.	A
9244♦	1 9/16"

♦ Copper

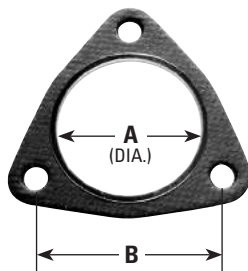

GASKET NO.	A	B
8403	3 9/32"	4 15/32"
8441	2 3/8"	2 ¾"
8442	3 5/32"	3 3/8"
8451	3 9/16"	3 7/8"
8681	2 5/8"	3 3/16"
8691	2 7/16"	3 9/32"
8705+	2 1/16"	2 15/16"
8710	2 3/32"	2 ¾"
8711	2 9/16"	3"

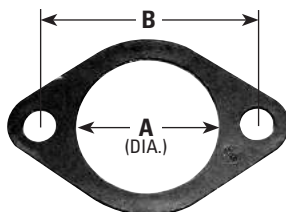

GASKET NO.	A	B
8405	2 ¼"	4"
8412 ⁵	2 19/32"	4 3/32"
8426	2 ¼"	4 1/32"
8428+	2 5/64"	3 ½"
8430+	1 13/16"	3"
8454+	2 19/64"	3 7/8"
8455+	2 13/32"	3 3/8"
8456+	2 19/32"	3 5/16"
8459+	2 5/32"	3 1/8"
8688	2 13/32"	3 15/16"
8689	2 3/8"	3 5/8"
8692	2 1/8"	4"
8697	2"	3 3/8"
8703+	1 49/64"	3"
8704+	2"	3 1/8"
8707+	1 7/8"	3 ¾"
8714	1 31/32"	2 15/16"
8719	1 15/16"	3 1/8"
8722	1 31/32"	3 ¼"
8724	2 5/16"	3 ½"
8726	2 3/16"	3"
8729	2 9/16"	3 11/16"
8735#	1 13/16"	3 1/8"

GASKET NO.	A	B
8720	2 3/32"	2 ¾"
8730	2 11/32"	2 13/16"
8739	1 13/16"	2 5/8"
9000	2 3/16"	3 ½"
9010	2"	2 39/64"
9018	2 19/32"	3 ½"
9028	1 13/16"	2 3/8"
9030	1 7/8"	2 5/8"
9031	2 ¼"	2 7/8"
9039	2 13/16"	3 ¼"
9040	2 13/16"	3 5/16"
9042	2 31/32"	3 1/8"
9068	2 1/8"	3 7/8"
9214	1 13/16"	3 29/32"
9278	2 5/32"	2 15/16"
9280	3 1/16"	4 7/16"
9283	2 5/16"	3 1/8"
9287	2 13/16"	4 5/16"

+ Slotted Bolt Hole

GASKET NO.	A	B
8735S	1 13/16"	3 1/8"
8741	1 31/32"	3 3/8"
8742	2 15/32"	3 7/8"
8751	1 13/16"	3"
8768	2"	3 ½"
8771+	2 ½"	4"
8772+	2 5/16"	3 ½"
9033	1 13/16"	2 13/16"
9064	1 27/32"	2 59/64"
9072	2 1/16"	3 5/32"
9075	2"	3"
9079+	2 5/8"	4 ¼"
9081	2"	3 3/16"
9088	1 27/32"	5 ¼"
9099	2 ½"	4 1/8"
9238	2 ¼"	3 ½"
9250	2 1/16"	4 5/16"
9256	2 3/8"	4 5/16"
9258+	1 13/16"	3 3/8"
9270	2 21/32"	4 1/16"
9274	2 5/16"	4 1/8"
9275	2 ¼"	3 7/8"
9277	1 15/16"	3 5/8"
9279	2 ¼"	3 5/8"
9284	3 1/16"	5 5/32"
9288	2 23/32"	4 7/16"

+ Slotted Bolt Hole

Bulk Packed 10/Box

⁵ Tin Plate With Insert

EXHAUST GASKET CHARTS

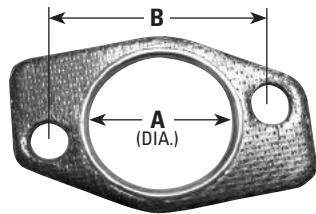

GASKET NO.	A	B
8407	1 27/32"	2 15/16"

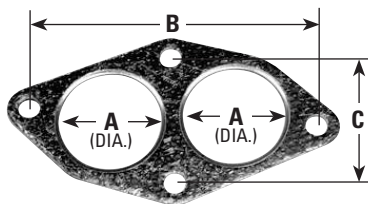

GASKET NO.	A	B	C
9265	1 11/16"	5"	2 3/8"

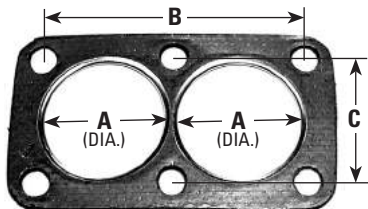

GASKET NO.	A	B	C
9213*	2 3/32"	5 1/16"	2 3/4"

* Hi-temp Graphite

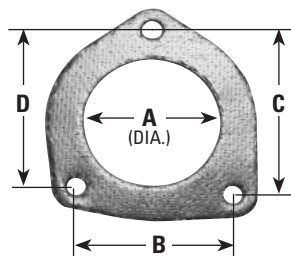

GASKET NO.	A	B	C	D
8414	2 9/16"	2 13/16"	3 9/16"	3 3/8"

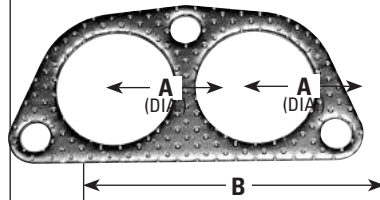

GASKET NO.	A	B
8402	1 13/16"	5 1/8"
8404	2 1/2"	5 5/16"
8463	2"	5"
8696	1 3/4"	4 3/16"
8734	1 11/16"	4"
9022	1 27/32"	4 13/32"
9228	1 7/8"	4 5/16"
9229	2"	4 3/4"
9237	1 1/2"	3 15/16"
9253	1 3/4"	4 5/16"
9255@	1 9/16"	4 3/4"
9281	1 15/32"	3 7/8"
9286+	2 9/16"	7 1/16"

@ Holes Connect

+ Slotted Bolt Hole

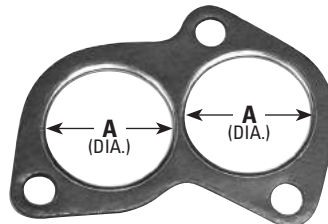

GASKET NO.	A
8750	1 3/16"
9235+	2"

+ Slotted Bolt Hole

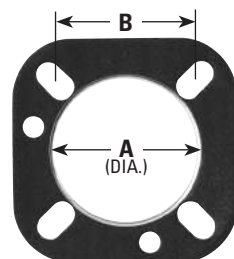

GASKET NO.	A	B
9069	2 29/32"	2 15/16"
9070	3 3/8"	3 7/16"

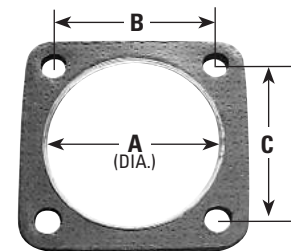

GASKET NO.	A	B	C
8481	3"	3 1/4"	3 1/4"
8759	3 9/32"	2 29/32"	4 31/64"
9025	2 15/16"	2 3/8"	2 3/8"
9058	2 3/4"	2 1/2"	2 3/4"
9226	2 1/2"	2 13/16"	2 1/2"
9227	2 3/4"	3 1/8"	2 1/16"

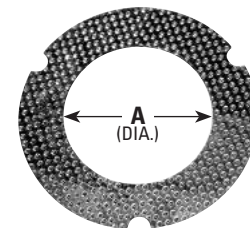

GASKET NO.	A
9223	2 5/8"

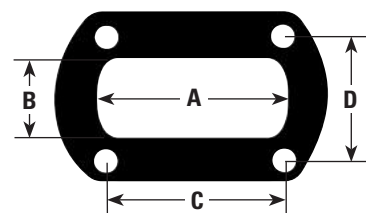

GASKET NO.	A	B	C	D
9245	5 9/16"	2 5/16"	4 9/16"	4 1/4"

EXHAUST GASKET CHARTS

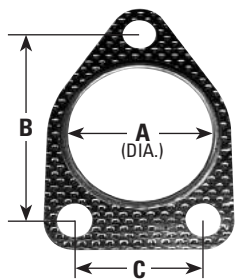

GASKET NO.	A	B	C
8439	2 1/2"	4"	2 43/64"
8453	2 1/4"	3 3/32"	2 23/32"
8701+*	2 1/16"	2 7/8"	2 1/2"
8760	1 13/16"	3 1/4"	2 1/2"
9043	2"	3 1/8"	2 5/16"
9097	2 3/32"	2 15/16"	1 13/16"
9098	1 3/4"	2 13/16"	1 9/16"
9239	2 1/4"	3 3/16"	1 15/16"
9269	2 5/8"	3 5/8"	2 5/16"

+ Slotted Bolt Hole

* Hi-temp Graphite

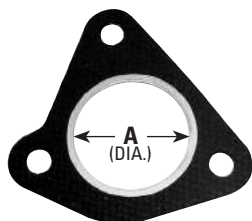

GASKET NO.	A
8712	2 3/32"

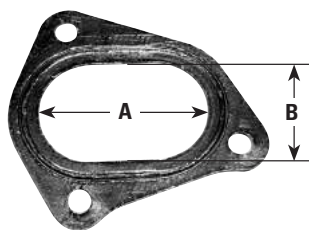

GASKET NO.	A	B
9263	3 7/16"	2 3/16"
8708+	3 25/32"	2 17/32"

+ Slotted Bolt Hole

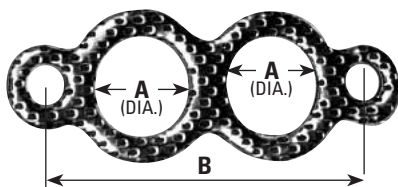

GASKET NO.	A	B
9224	1 5/16"	3 5/16"

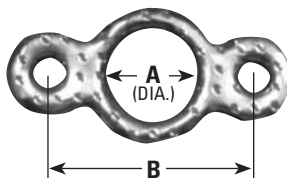

GASKET NO.	A	B
9242	1 3/16"	1 3/4"

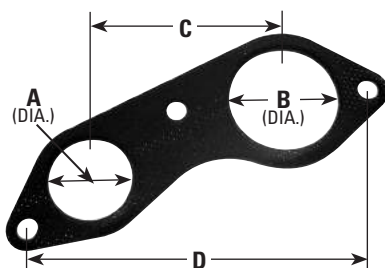

GASKET NO.	A	B	C	D
4731	3 5/32"	3 23/32"	5 5/8"	9 15/16"
9285	2 1/16"	2 3/4"	5 1/4"	9 5/32"

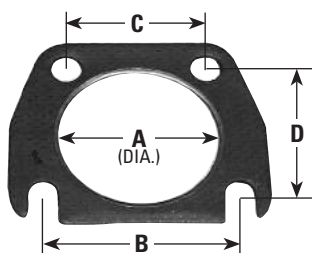

GASKET NO.	A	B	C	D
8682	2 1/16"	2 11/16"	1 15/16"	2 3/16"
9014	2"	3 3/16"	2 3/8"	2 5/8"
9015	2 5/8"	3 3/16"	2 3/8"	2 5/8"

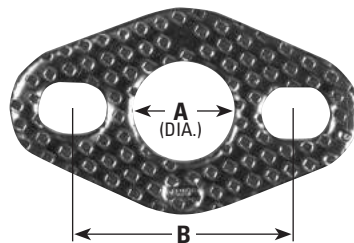

GASKET NO.	A	B
9291+	3/4"	1 11/16"
9299	3/4"	2 1/8"

Airtube / O2 Sensor Gasket

+ Slotted Bolt Hole

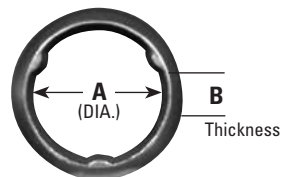

GASKET NO.	A	B
9048	1 27/32"	1 17/32"
9297	2"	9/16"

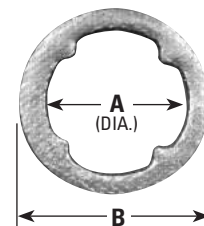

GASKET NO.	A	B
9266	2 9/16"	3 1/2"

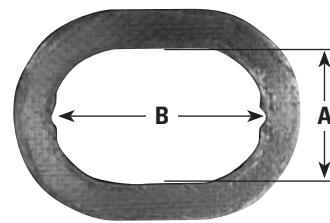

GASKET NO.	A	B
8725	2 7/32"	3 3/8"

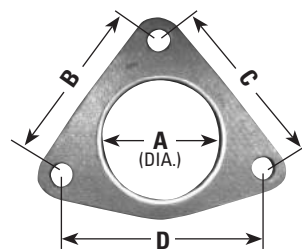

GASKET NO.	A	B	C	D
8468	2 9/16"	4 29/32"	4 29/32"	4 1/2"
9276	2 7/16"	3 1/2"	3 1/2"	4 1/4"

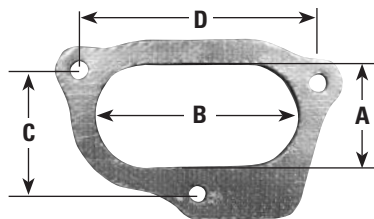

GASKET NO.	A	B	C	D
9271	2 11/32"	4 3/4"	2 15/16"	5 9/16"

EXHAUST GASKET CHARTS

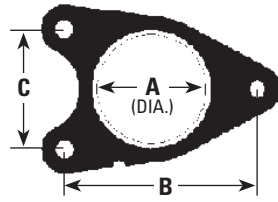

GASKET NO.	A	B	C
8728	2 3/4"	5 9/16"	3 1/8"

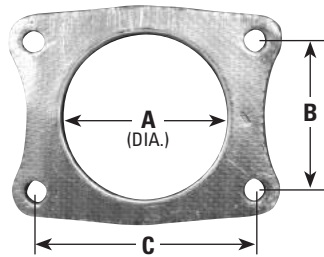

GASKET NO.	A	B	C
9119	3 1/2"	3 1/4"	4 57/64"

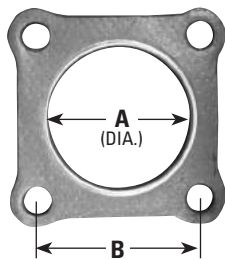

GASKET NO.	A	B
9011	2 11/32"	2 13/16"
9289	2 5/8"	3 1/4"

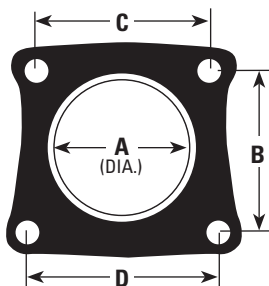

GASKET NO.	A	B	C	D
8721	2 5/8"	2 45/64"	3 21/32"	4 9/64"

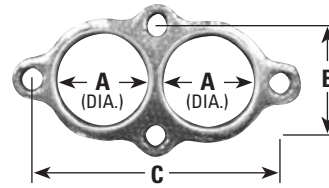

GASKET NO.	A	B	C
8401	1 27/32"	2 1/4"	5 1/8"

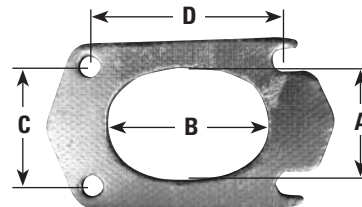

GASKET NO.	A	B	C	D
8761	2 1/2"	3 9/16"	2 3/4"	4 3/8"

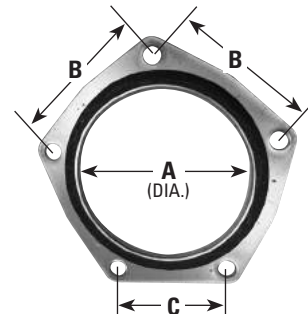

GASKET NO.	A	B	C
8413 ⁵	3 21/32"	3 1/16"	2 17/32"

⁵ Tin Plate With Insert

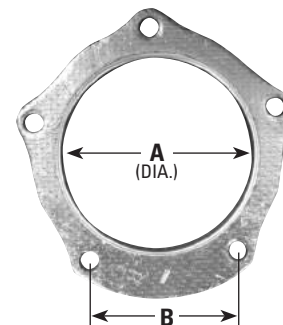

GASKET NO.	A	B
8409	4"	2 7/8"
8465	3 1/2"	3"
8723	3 17/32"	2 13/16"
9096	4 19/32"	3 3/16"
9254	4 1/16"	3 1/8"

EXHAUST GASKET CHARTS

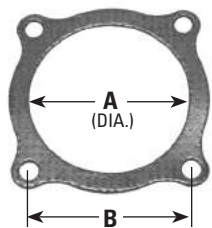

GASKET NO.	A	B
8417	3 9/16"	3 7/32"
8433	4"	3 57/64"

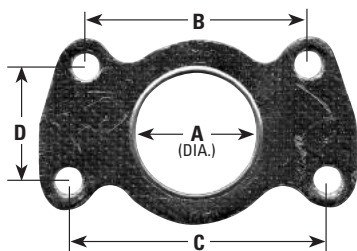

GASKET NO.	A	B	C	D
9054	2"	3 3/4"	4 5/16"	1 15/16"

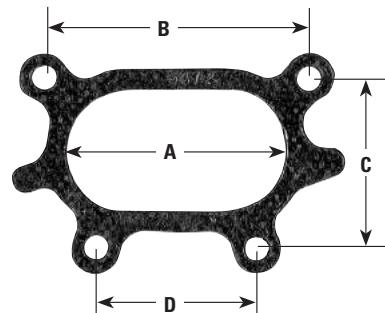

GASKET NO.	A	B	C	D
8480	3 1/4"	3 15/16"	2 1/2"	2 3/8"
8502*	3 5/8"	4 1/4"	2 5/8"	2 1/2"

*No Side Tabs

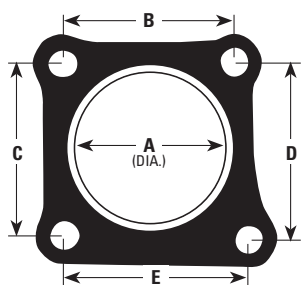

GASKET NO.	A	B	C	D	E
9013	2 1/2"	3 1/4"	3 1/4"	3 1/2"	3 5/8"

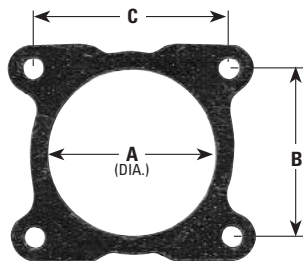

GASKET NO.	A	B	C
8436	3"	3"	3 1/2"

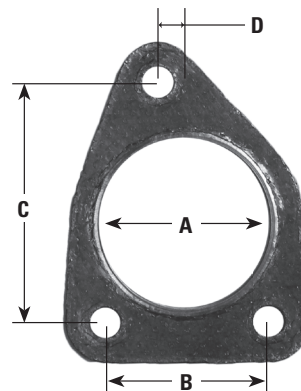

GASKET NO.	A	B	C	D
8685	2 1/4"	2 7/32"	3 3/16"	3/8"

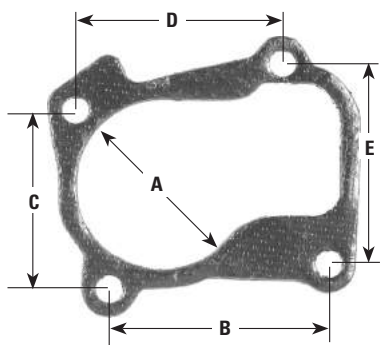

GASKET NO.	A	B	C	D	E
8687	2 1/4"	3"	2 1/2"	2 7/8"	2 49/64"

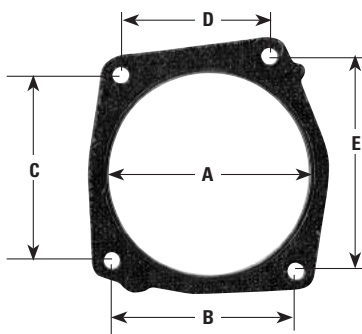

GASKET NO.	A	B	C	D	E
8452	4 43/64"	4 1/4"	4 1/4"	3 1/2"	5"

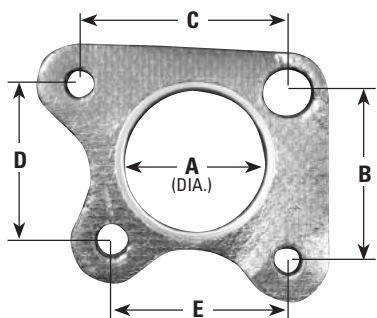

GASKET NO.	A	B	C	D	E
8732	2 1/32"	2 15/32"	3 1/16"	2 1/4"	2 17/32"

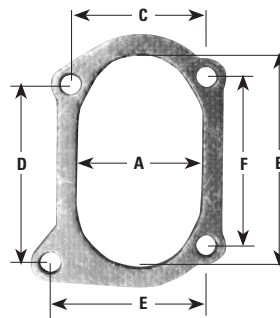

GASKET NO.	A	B	C	D	E	F
8713	2 19/32"	4 15/32"	2 7/8"	3 13/16"	3 5/16"	3 5/8"

EXHAUST GASKET CHARTS

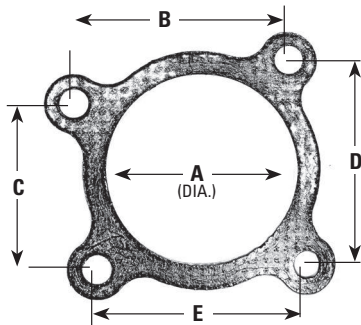

GASKET NO.	A	B	C	D	E
8416	3 7/16"	3 3/4"	3 3/4"	4"	3"

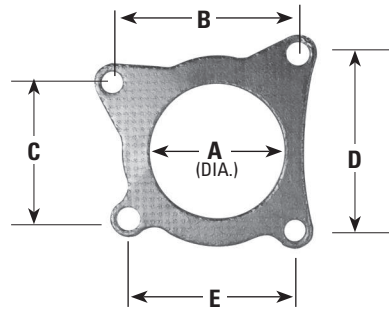

GASKET NO.	A	B	C	D	E
8746	3 3/8"	4 3/16"	3 7/16"	4 7/16"	4 5/8"

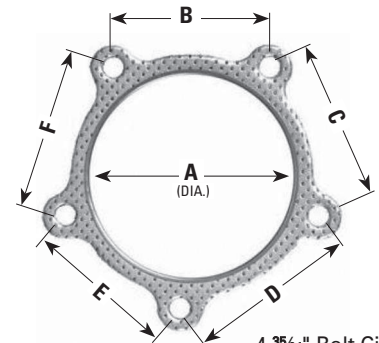

GASKET NO.	A	B	C	D	E	F
8684	3 5/16"	2 5/8"	2 5/8"	2 9/16"	2 13/16"	2 3/4"

4 3/64" Bolt Circle

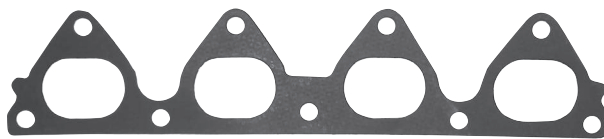

8431

- 96-00 Honda Civic CX/DX/LX 1.6L
- 96-97 Honda Del Sol S 1.6L

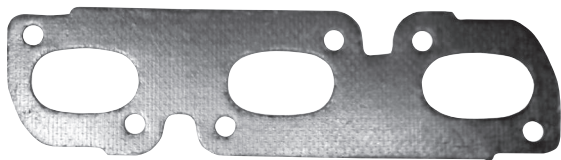

8432

- 01-08 Mazda 3.0L
- 01-12 Ford 3.0L
- 95-02 Ford 2.5L
- 00-01 Mazda 2.5L

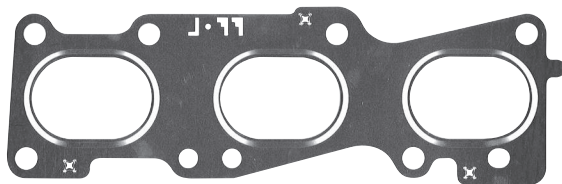

8446

- 07-09 Hyundai, Kia 3.3L
- 07-10 Hyundai, Kia 3.8L

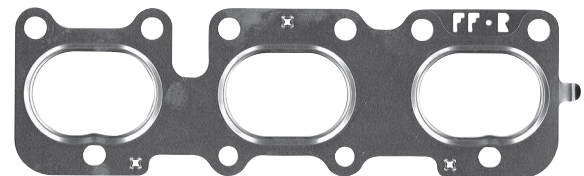

8447

- 07-09 Hyundai, Kia 3.3L
- 07-10 Hyundai, Kia 3.8L

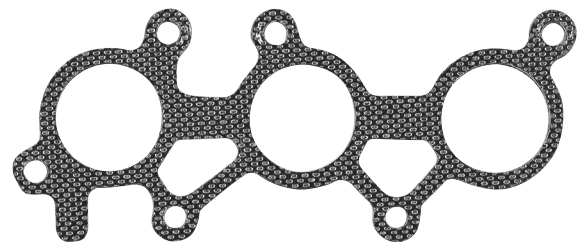

8471

- 06-13 Lexus 2.5L
- 05-15 Lexus, Toyota 3.5L



8472

- 07-15 Nissan Altima, Rogue 2.5L

EXHAUST GASKET CHARTS

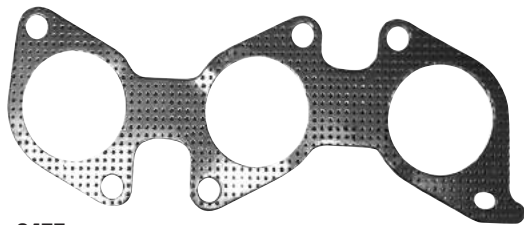

8475

03-09 Toyota 4 Runner 4.0L

07-09 Toyota FJ Cruiser 4.0L

05-15 Toyota Tacoma 4.0L

05-06 Toyota Tundra 4.0L



8476

04-12 GM Colorado/Canyon 3.5L, 3.7L

07-10 Hummer H3 3.7L

06-08 Isuzu Pickup 3.5L, 3.7L



8477

04-12 Chevrolet Malibu 2.2L, 2.4L

06-10 Pontiac G6 2.4L



8479

04-12 GM Colorado/Canyon 2.8L, 2.9L

06-08 Isuzu Pickup 2.8L, 2.9L



8486

09-12 GM Aveo, G3 1.6L, Cruze 1.8L



8491

99-12 Hyundai 2.0L

04-11 Kia 2.0L



8492

01-10 Hyundai/Kia 2.7L



8495

04-10 Infiniti 5.6L

04-15 Nissan 5.6L



8496

01-11 Hyundai 1.6L

06-11 Kia 1.6L



8497

02-15 Nissan Altima, Frontier, Sentra 2.5L

09-12 Suzuki Equator 2.5L

EXHAUST GASKET CHARTS



8499

95-06 Lexus, Toyota 3.0L

04-10 Lexus, Toyota 3.3L



8500

03-09 Toyota 4 Runner 4.7L LH

03-09 Lexus GX470 4.7L LH



8501

03-09 Toyota 4 Runner 4.7L RH

03-09 Lexus GX470 4.7L RH



8504

03-05 Ford Focus 2.3L

05 Ford Focus 2.0L

06-09 Ford Fusion 2.3L Calif.

06-09 Mercury Milan 2.3L Calif.



8507

95-00 Lexus 4.0L

01-10 Lexus 4.3L

98-05 Lexus, Toyota 4.7L



8508

06-15 Mazda 5 2.3L, 2.5L

05-06 Ford Escape, Mariner 2.3L

06-09 Ford Fusion, Milan 2.3L

04-11 Ford Ranger 2.3L

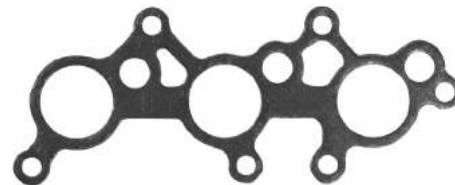

8512

10-13 Toyota 4 Runner 4.0L

10-12 Toyota FJ Cruiser 4.0L

11-14 Toyota Tundra 4.0L



8638

11-14 Hyundai Sonata 2.4L

06-14 Hyundai, Kia 2.0L, 2.4L



8639

12-14 Hyundai, Kia 1.8L, 2.0L



8643

02-07 Mitsubishi Lancer 2.0L except Turbo

EXHAUST GASKET CHARTS

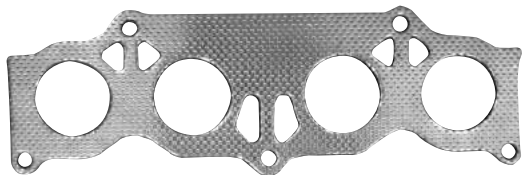

9243

05-13 Scion 2.4L

01-10 Toyota 2.4L

10-13 Toyota 2.5L

09-12 Toyota 2.7L

ELBOWS

WELDING OF ALUMINIZED MATERIAL

Gas Welding

1. Adjust gases until there is a small soft blue flame extending beyond the inner cone $\frac{1}{8}$ " to $\frac{1}{4}$ ".
2. Use an AWS (American Welding Society) Number ER 70S-2 welding rod or the equivalent. This rod has extra elements added to cause the aluminized coating to float on top of the molten puddle away from the inner weld structure.

Tig Welding

Use the same type welding rod as gas welding with argon purge gas.

Mig Welding

For typical exhaust components, use a copper clad, .035 inch to .045 inch diameter wire. Specifically use a low carbon steel wire, AWS Number 70S-3 or the equivalent.

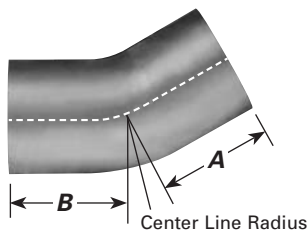

ALUMINIZED 15° ELBOWS

Both ends are O.D.

P/N	DIAMETER	LENGTH A-B	CENTERLINE RADIUS
10684	4"	2"-2"	4 ½"
10685	5"	4"-4"	8"

ALUMINIZED 30° ELBOWS

One end is I.D., the other end is O.D.

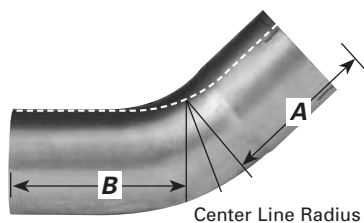

P/N	DIAMETER	STYLE	LENGTH A-B	CENTERLINE RADIUS
10631	3 ½"	ID-OD	4"-4"	5"
10632	4"	ID-OD	4"-4"	5"
10633	5"	ID-OD	4"-4"	6"

Both ends are O.D.

P/N	DIAMETER	STYLE	LENGTH A-B	CENTERLINE RADIUS
10636	4"	OD-OD	4"-4"	5"
10637	5"	OD-OD	4"-4"	6"

ELBOWS

ALUMINIZED & CHROME 45° ELBOWS

One end is I.D., the other end is O.D.

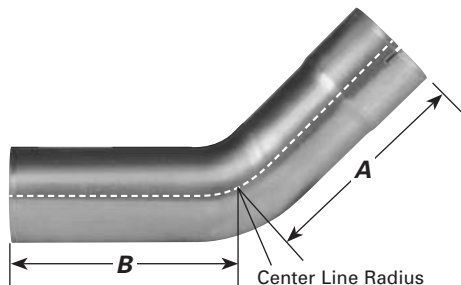

P/N ALUMINIZED	P/N CHROME	DIAMETER	STYLE	LENGTH A-B	CENTERLINE RADIUS
10311	—	2"	ID-OD	6"-6"	5"
10320	—	2 ¼"	ID-OD	6"-6"	4 ½"
10312	—	2 ½"	ID-OD	6"-6"	4"
10725	—	2 ½"	ID-OD	6"-6"	5"
10318	—	2 ¾"	ID-OD	6"-6"	5"
10313	—	3"	ID-OD	7"-7"	6"
10314	—	3 ½"	ID-OD	8"-8"	7"
10736	—	4"	ID-OD	5"-5"	4"
10726	—	4"	ID-OD	6"-6"	6"
10315	—	4"	ID-OD	9 ¼"-9 ¼"	8"
10727	—	4"	ID-OD	12"-12"	6"
10729	—	5"	ID-OD	7"-7"	8"
10730	809738	5"	ID-OD	8"-8"	10"
10317	—	5"	ID-OD	12"-12"	8"
10731	—	5"	ID-OD	12"-12"	10"
10732	—	5"	ID-OD	15"-15"	8"

Both ends are O.D.

P/N ALUMINIZED	P/N CHROME	DIAMETER	STYLE	LENGTH A-B	CENTERLINE RADIUS
10562	—	2 ½"	OD-OD	6"-6"	5"
10742	—	3"	OD-OD	4"-4"	3"
10564	—	3"	OD-OD	7"-7"	6"
10565	—	3 ½"	OD-OD	8"-8"	7"
10743	—	4"	OD-OD	6"-6"	6"
10566	—	4"	OD-OD	8"-8"	4 ½"
10745	—	4"	OD-OD	12"-12"	6"
10567	—	5"	OD-OD	8"-8"	5 ½"
10746	809752	5"	OD-OD	8"-8"	8"
10747	809753	5"	OD-OD	15"-15"	8"
10748	—	6"	OD-OD	7"-7"	10"

ELBOWS

ALUMINIZED 60° ELBOWS

One end is I.D., the other end is O.D.

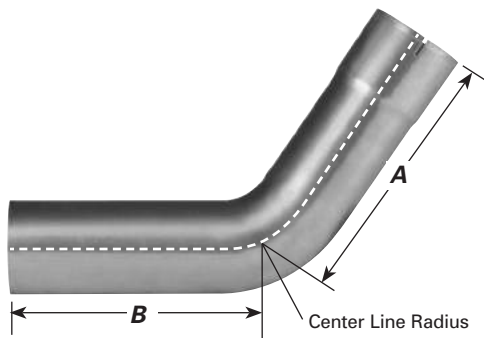

P/N	DIAMETER	STYLE	LENGTH A-B	CENTERLINE RADIUS
10639	3 ½"	ID-OD	8"-8"	5"
10640	4"	ID-OD	8"-8"	5"
10641	5"	ID-OD	8"-8"	6"

Both ends are O.D.

P/N	DIAMETER	STYLE	LENGTH A-B	CENTERLINE RADIUS
10644	4"	OD-OD	8"-8"	5"
10645	5"	OD-OD	8"-8"	6"

ALUMINIZED & CHROME 67° ELBOWS

Both ends are O.D.

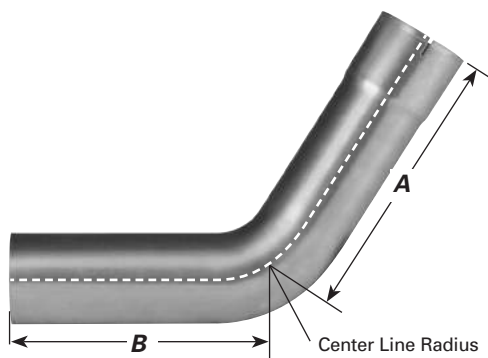

P/N ALUMINIZED	P/N CHROME	DIAMETER	STYLE	LENGTH A-B	CENTERLINE RADIUS
10560	809530	5"	OD-OD	7 ½"-11"	8"

ELBOWS

ALUMINIZED & CHROME 90° ELBOWS

One end is I.D., the other end is O.D.

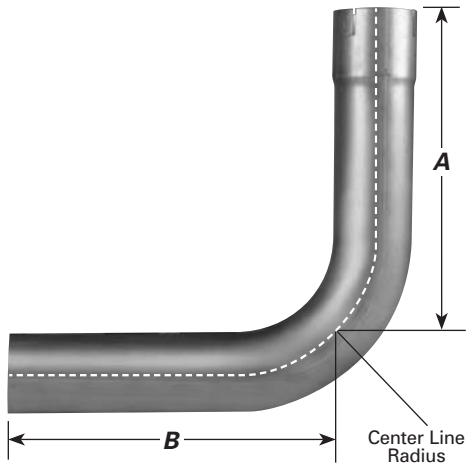

P/N ALUMINIZED	P/N CHROME	DIAMETER	LENGTH A-B	CENTERLINE RADIUS
10922	—	1½"	6½"-6½"	4"
10670	—	1¾"	6¼"-6¼"	4"
10301	—	2"	11"-11"	5"
10671	—	2"	6⅜"-6⅜"	4"
10673	—	2¼"	6⅜"-6⅜"	4½"
10302	—	2¼"	10⅞"-10⅞"	5"
10672	—	2½"	6⅜"-6⅜"	4½"
10303	—	2½"	12"-12"	5"
10674	—	2¾"	6⅜"-6⅜"	5"
10675	—	3"	8"-8¼"	6"
10756	—	3"	8½"-8½"	5"
10757	—	3"	10"-12"	5"
10758	—	3"	12"-12"	5"
10304	—	3"	14"-14"	6"
10795	—	3½"	6¼"-6¼"	3½"
10759	—	3½"	9½"-9¾"	5"
10676	—	3½"	9"-9"	4½"
10305	—	3½"	16"-16"	7"
10681	—	4"	8"-8"	4½"
—	809621	4"	10"-10"	5"
10678	—	4"	10"-10"	4½"
10761	809770	4"	12"-12"	6"
10762	—	4"	16"-16"	8"
10306	809406	4"	18"-18"	8"
10764	—	5"	8½"-8½"	6"
10557	809771	5"	11"-11"	6"
10680	809547	5"	11"-11"	7½"
10765	—	5"	15"-15"	8"
10554	809546	5"	15"-15"	10"
10766	—	5"	16½"-16½"	10"
10308	809408	5"	18"-18"	10"
10556	—	6"	15"-15"	10"

ELBOWS

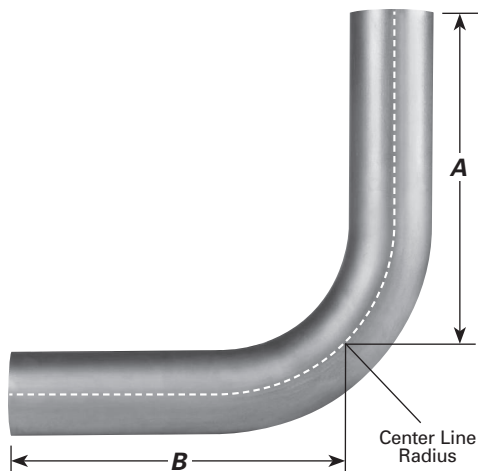

ALUMINIZED & CHROME 90° ELBOWS

Both ends are O.D.

P/N ALUMINIZED	P/N CHROME	DIAMETER	LENGTH A-B	CENTERLINE RADIUS
10773	—	2"	9"-9"	5"
10774	—	2½"	12"-12"	5"
10337	—	3"	3"-3"	3½"
10776	—	3"	6"-6"	3"
10777	—	3"	7"-7"	3"
10534	—	3"	10"-10"	6"
10778	—	3"	14"-14"	8"
10794	—	3½"	6"-6"	3½"
10338	—	3½"	4"-4"	4"
10329	—	3½"	8"-8"	4"
10535	—	3½"	12"-12"	7"
10536	—	3½"	16"-16"	7"
10339	—	4"	4½"-4½"	4½"
10780	—	4"	7"-7"	5"
10781	—	4"	8"-8"	4"
10538	—	4"	9"-15"	4½"
10783	—	4"	10"-10"	6"
10539	—	4"	12"-12"	5½"
10797	—	4"	16"-16"	8"
10537	—	4"	18"-18"	8"
10340	—	5"	5½"-5½"	5½"
10784	—	5"	7½"-7½"	6"
10785	809795	5"	8½"-8½"	6"
10786	—	5"	9"-11½"	5½"
10787	—	5"	8½"-12½"	6"
10788	—	5"	8¾"-14¼"	5½"
10789	—	5"	9½"-9½"	6"
10541	—	5"	11"-16"	5½"
10791	—	5"	12"-12"	6"
—	809796	5"	12"-12"	8"
10796	—	5"	15"-15"	5½"
10540	—	5"	15"-15"	8"
10309	—	5"	20"-20"	8"

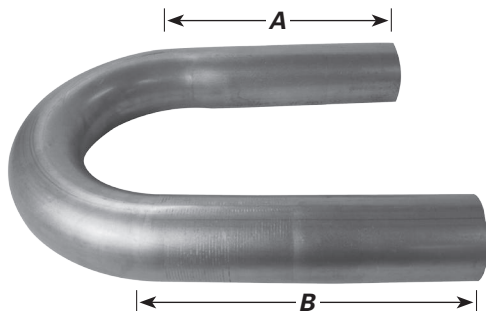

ALUMINIZED 180° Mandrel U-Bends

Both ends are O.D.

P/N ALUMINIZED	P/N CHROME	DIAMETER	LENGTH A-B	CENTERLINE RADIUS
U21208	—	2½"	8"-8"	4½"
U30008	—	3"	8"-8"	5½"

REDUCERS



ALUMINIZED OD - ID REDUCER

Reduces larger I.D. pipe to smaller O.D. pipe.

P/N	OD - ID	LENGTH
8663	1 5/8" - 1 1/2"	4"
8661	1 7/8" - 1 3/4"	4 1/2"
8650	2" - 1 1/2"	4 1/2"
8651	2" - 1 5/8"	4"
8902	2" - 1 3/4"	5 3/4"
8652	2" - 1 7/8"	5 1/8"
8653	2 1/4" - 1 3/4"	5"
8938	2 1/4" - 2"	4"
8941	2 1/2" - 2"	4"
8654	2 1/2" - 2"	9 1/2"
8942	2 1/2" - 2 1/4"	4"
8655	2 1/2" - 2 1/4"	9 1/2"
9600	3" - 2 1/2"	6 1/4"
9334	3" - 2 3/4"	6"
9333	3 1/2" - 3"	6"
9722	4" - 3"	6"
9332	4" - 3 1/2"	6"
9331	5" - 4"	6"
9723	5" - 4 1/2"	6"
8969	6" - 5"	6"



ALUMINIZED ID - OD REDUCER

Reduces larger O.D. pipe to smaller I.D. pipe.

P/N	ID - OD	LENGTH
8925	1 1/2" - 1 3/8"	4"
8926	1 5/8" - 1 1/2"	4"
8927	1 3/4" - 1 1/2"	4"
8928	1 3/4" - 1 5/8"	4"
8929	1 7/8" - 1 1/2"	4"
8935	1 7/8" - 1 3/4"	4 1/2"
8936	2" - 1 3/4"	4 1/2"
8930	2" - 1 13/16"	4"
8660	2" - 1 7/8"	4"
8909	2 1/8" - 2"	5 3/4"
8931	2 1/4" - 1 7/8"	4"
8911	2 1/4" - 2"	5 3/4"
8932	2 1/4" - 2 1/8"	4"
8913	2 1/2" - 2"	5 3/4"
8940	2 1/2" - 2 1/4"	4 1/2"
8959	2 3/4" - 2 1/2"	6"
8960	3" - 2 1/2"	6"
8961	3" - 2 3/4"	6"
8962	3 1/2" - 3"	6"
8963	4" - 3"	6"
8964	4" - 3 1/2"	6"
8965	5" - 4"	6"
9336	6" - 5"	6"



ALUMINIZED ID - ID REDUCER

Reduces O.D. pipes of different sizes.

P/N	ID - ID	LENGTH
8921	1 1/4" - 1 1/2"	4"
8920	1 5/8" - 1 1/2"	4"
8922	2" - 1 1/2"	4"
8923	2" - 1 5/8"	4"
8944	2" - 1 3/4"	4 1/2"
8945	2" - 1 7/8"	4 1/2"
8924	2 1/8" - 2"	4"
8946	2 1/4" - 2"	4 1/2"
8947	2 1/2" - 2"	4 1/2"
8948	2 1/2" - 2 1/4"	4 1/2"
8952	2 3/4" - 2 1/2"	6"
8953	3" - 2 1/2"	6"
8954	3" - 2 3/4"	6"
8955	3 1/2" - 3"	6"
8956	4" - 3"	6"
8957	4" - 3 1/2"	8"
8958	5" - 4"	8"
9721	5" - 4 1/2"	6"
9335	6" - 5"	8"



ALUMINIZED OD - OD REDUCER

Reduces larger O.D. pipe to smaller I.D. pipe.

P/N	OD - OD	LENGTH
8904	2" - 1 13/16"	5 3/4"
8908	2 1/8" - 2"	7 1/4"
8657	2 1/4" - 2"	4"
8912	2 1/4" - 2"	5 3/4"
8658	2 1/2" - 2"	9 1/2"
8659	2 1/2" - 2 1/4"	9 1/2"
9648	4" - 3"	8"
9649	5" - 4"	8"
9720	6" - 4"	6"
9650	6" - 5"	8"

REDUCER BUSHINGS



ALUMINIZED SPLIT REDUCER BUSHINGS

Reduces I.D. of a muffler by 1/8" without increasing its overall length. Made of 16 gauge steel.

P/N	REDUCES FROM - TO
1A	3" - 2 7/8"
2	2 3/4" - 2 5/8"
3	2 5/8" - 2 1/2"
5	2 1/2" - 2 3/8"
6	2 3/8" - 2 1/4"
7	2 1/4" - 2 1/8"

P/N	REDUCES FROM - TO
8	2 1/8" - 2"
9	2" - 1 7/8"
10	1 7/8" - 1 3/4"
11	1 3/4" - 1 5/8"
12	1 5/8" - 1 1/2"

CONNECTORS



ALUMINIZED ID - ID CONNECTOR

Connects O.D. pipes of the same size.

P/N	ID - ID	LENGTH
8916	1 1/2" - 1 1/2"	4"
23075	1 1/2" - 1 1/2"	18"
8949	1 3/4" - 1 3/4"	4 1/2"
23076	1 3/4" - 1 3/4"	18"
8917	1 7/8" - 1 7/8"	4"
23077	1 7/8" - 1 7/8"	18"
14337	2" - 2"	4"
23078	2" - 2"	18"
8950	2 1/8" - 2 1/8"	4 1/2"
8951	2 1/4" - 2 1/4"	4 1/2"
23079	2 1/4" - 2 1/4"	18"
14338	2 1/2" - 2 1/2"	4"
23080	2 1/2" - 2 1/2"	18"
8980	2 3/4" - 2 3/4"	4"
13025	2 3/4" - 2 3/4"	12"
14339	3" - 3"	4"
14601	3" - 3"	6"
13026	3" - 3"	12"
14340	3 1/2" - 3 1/2"	4"
14602	3 1/2" - 3 1/2"	6"
13027	3 1/2" - 3 1/2"	12"
14341	4" - 4"	4"
14603	4" - 4"	6"
13028	4" - 4"	12"
14605	5" - 5"	6"
8974	6" - 6"	6"

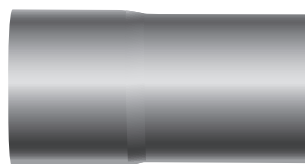

ALUMINIZED ID - OD CONNECTOR

Connects I.D. and O.D. pipes of the same size.

P/N	ID - OD	LENGTH
8662	1 1/2" - 1 1/2"	4 7/8"
13001	1 1/2" - 1 1/2"	12"
23001	1 1/2" - 1 1/2"	18"
23051	1 1/2" - 1 1/2"	24"
33001	1 1/2" - 1 1/2"	36"
13002	1 5/8" - 1 5/8"	12"
23002	1 5/8" - 1 5/8"	18"
8934	1 3/4" - 1 3/4"	4 1/2"
13003	1 3/4" - 1 3/4"	12"
23003	1 3/4" - 1 3/4"	18"
23052	1 3/4" - 1 3/4"	24"
33002	1 3/4" - 1 3/4"	36"
8937	1 7/8" - 1 7/8"	4 1/2"
13004	1 7/8" - 1 7/8"	12"
23004	1 7/8" - 1 7/8"	18"
23053	1 7/8" - 1 7/8"	24"
33003	1 7/8" - 1 7/8"	36"
8933	2" - 2"	5 3/4"
8906	2" - 2"	7 1/4"
13005	2" - 2"	12"
23005	2" - 2"	18"
23054	2" - 2"	24"
33004	2" - 2"	36"
8914	2 1/8" - 2 1/8"	4"
13006	2 1/8" - 2 1/8"	12"
23006	2 1/8" - 2 1/8"	18"
23055	2 1/8" - 2 1/8"	24"
33005	2 1/8" - 2 1/8"	36"

P/N	ID - OD	LENGTH
8939	2 1/4" - 2 1/4"	4 1/2"
8915	2 1/4" - 2 1/4"	9 1/2"
13007	2 1/4" - 2 1/4"	12"
23007	2 1/4" - 2 1/4"	18"
23056	2 1/4" - 2 1/4"	24"
33006	2 1/4" - 2 1/4"	36"
8943	2 1/2" - 2 1/2"	4 1/2"
13008	2 1/2" - 2 1/2"	12"
23008	2 1/2" - 2 1/2"	18"
23057	2 1/2" - 2 1/2"	24"
33007	2 1/2" - 2 1/2"	36"
8975	3" - 3"	6"
13009	3" - 3"	12"
23009	3" - 3"	18"
23058	3" - 3"	24"
33008	3" - 3"	36"
8976	3 1/2" - 3 1/2"	6"
13010	3 1/2" - 3 1/2"	12"
9599	3 1/2" - 3 1/2"	18"
8991	4" - 4"	6"
13011	4" - 4"	12"
23010	4" - 4"	18"
23059	4" - 4"	24"
8978	5" - 5"	6"
13012	5" - 5"	12"
24712	5" - 5"	18"
23060	5" - 5"	24"
8979	6" - 6"	6"

CONNECTORS

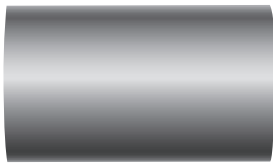

ALUMINIZED OD - OD CONNECTOR

Connects I.D. pipes of the same size.

P/N	OD - OD	LENGTH
8907	2" - 2"	5 ¾"
8918	2 ¼" - 2 ¼"	6"
8919	2 ½" - 2 ½"	4 ½"
8970	3" - 3"	6"
8971	3 ½" - 3 ½"	6"
8972	4" - 4"	8"
8973	5" - 5"	8"

ALUMINIZED TILT CAB CONNECTORS TOP

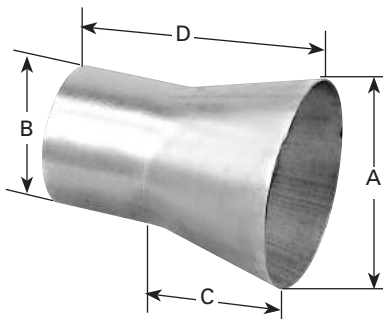

P/N	A	B	C	D
9341	5 ¾" OD	4" OD	2 ½"	7"
9342	6 ¾" OD	5" OD	2 ½"	7 ⅝"

ALUMINIZED TILT CAB CONNECTORS BOTTOM

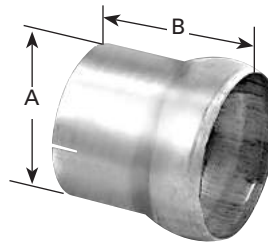

P/N	A	B
9343	4" ID	4 ½"
9344	5" ID	5 ⅝"

ADAPTERS

THREADED ADAPTERS



P/N	OD SIZE	THREAD(NPT)	LENGTH
9514	3"	3"	6"
9516	3 ½"	3 ½"	6"
9518	4"	4"	6"

NPT - National Pipe Thread

ADAPTERS

FLARED ADAPTERS

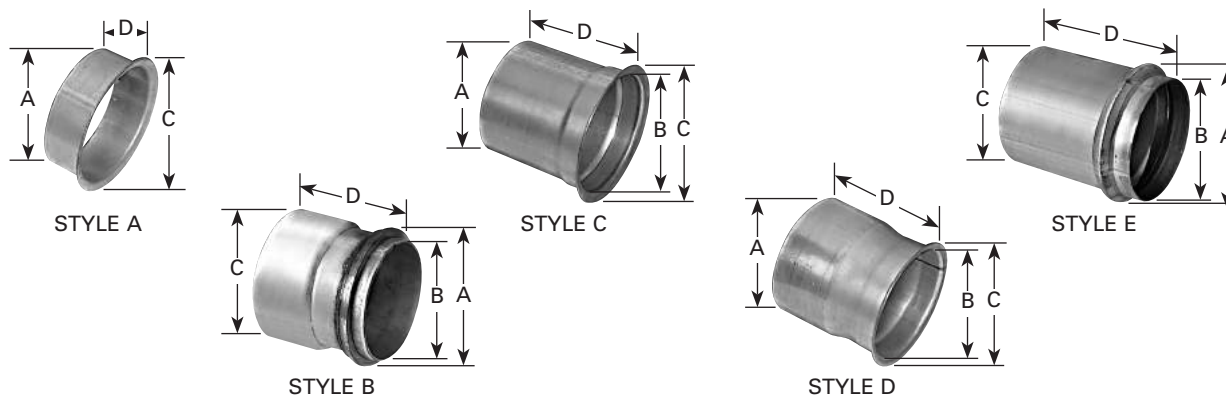

P/N	STYLE	A (O.D.)	B (I.D.)	C (O.D.)	D (LGTH.)	FLARE IN DEG.	APPLICATION	USE W/ V-BAND CLAMP
9706	D	3.977	2.836	3.970	3.482	20		9398
9707	A	2.500	3.345	3.695	1.532	20		9395
9390	A	NA	NA	NA	NA	20	FORD MOTOR CO, DETROIT DIESEL 6V71, 7V73, CUMMINS V555, V902	NA
9470	C	3.005	3.028	3.618	4.181	22	DETROIT DIESEL 6V71	9395
9708	A	3.005	2.869	3.541	3.568	45		NA
9471	C	3.005	3.040	3.775	4.522	45		9395
9479	A	3.183	3.015	3.915	2.200	20	GMC TRUCK/BUS W/ 8.2N	9611
9709	A	3.512	3.385	4.071	4.176	22	CAT 3208T	9611
9710	A	3.350	3.373	4.025	5.018	45	DETROIT DIESEL 6V71	9622
9392	C	3.525	3.505	4.320	6.095	45		9396
9473	C	3.490	3.630	4.165	4.035	22	DETROIT DIESEL 8V-71	9613
9711	C	3.520	3.620	4.270	4.100	22	DETROIT DIESEL 8V-72	9396
9712	C	3.480	3.670	4.212	4.140	22	DETROIT DIESEL 8V-73	9613
9391	A	3.010	2.865	3.905	1.310	20	DETROIT DIESEL 8V92, 4-53	9611
9713	D	3.990	3.605	4.260	4.050	22	DETROIT DIESEL 8V-71	9613
9476	C	NA	NA	NA	NA	22	DETROIT DIESEL 12V71	NA
9472	D	3.960	3.550	4.305	3.868	22	DETROIT DIESEL 8.2N, CUMMINS VT225	9396
9714	C	4.005	3.975	4.500	5.922	45		NA
9474	A	3.950	3.850	4.535	1.810	22	DETROIT DIESEL 6-71, 8.2N, 8.2T, MACK	NA
9475	A	3.985	3.875	4.540	5.170	45	CUMMINS	NA
♣9715	B	5.13	4.250	4.800	1.940	20	DETROIT DIESEL 8V-71T, 16V-71T, 6V-92T, 8V-92T	NA
9393	A	5.005	4.880	5.475	6.275	45	CUMMINS	NA
9478	A	5.035	4.870	5.720	3.025	22	CATERPILLAR TURBO, CUMMINS TURBO, INTERNATIONAL	9616
9716	A	4.990	4.825	5.572	5.608	20	INTERNATIONAL	NA
9717	A	5.010	4.885	5.845	6.287	20	T-50 TURBO CHARGER	9616
9394	C	NA	NA	NA	NA	45	T-50 TURBO CHARGER	NA
9718	B	5.150	4.215	4.780	2.045	20	DETROIT DIESEL 8V-71T, 16V-71, 6V-92T, 8B-92T, 16V-92T	NA
9719	E	5.658	4.825	4.998	6.168	NA	CUMMINS ENGINES	9615

♣ WITH MACHINED RING

FLEX COUPLING

FEATURES	(VALUE)	(PREMIUM)
	200 STAINLESS	300 STAINLESS
2 Ply Bellows for Max Strength	✓	✓
Seamless Convuluted Inner core to prevent leaks	✓	✓
Reduces Vibration Stress Fatigue	✓	✓
Inner Braid Option Adds Longer Life	✓	✓
Large 3" Diameter for Heavy Duty & Perf. Applications		✓
Longest Life for Maximum Corrosion Protection		✓
Highest Temperature Resistance to Fatigue		✓

	200 SERIES W/ INNER BRAID	300 SERIES W/O INNER BRAID	300 SERIES W/ INNER BRAID	INLET DIAMETER	OVERALL LENGTH	FLEX LENGTH
WITHOUT NIPPLE EXTENSION						
	FT13404B	8810	8810IB	1.77"	4"	4"
	FT13406B	8811	8811IB	1.77"	6"	6"
	FT13408B	8812	8812IB	1.77"	8"	8"
	FT13410B	8813	8813IB	1.77"	10"	10"
	FT20004B	8814	8814IB	2.02"	4"	4"
	FT20006B	8815	8815IB	2.02"	6"	6"
	FT20008B	8816	8816IB	2.02"	8"	8"
	FT20010B	8817	8817IB	2.02"	10"	10"
	FT22504B	8818	8818IB	2.27"	4"	4"
	FT22506B	8819	8819IB	2.27"	6"	6"
	FT22508B	8820	8820IB	2.27"	8"	8"
	FT22510B	8821	8821IB	2.27"	10"	10"
	FT25004B	8822	8822IB	2.52"	4"	4"
	FT25006B	8823	8823IB	2.52"	6"	6"
	FT25008B	8824	8824IB	2.52"	8"	8"
	FT25010B	8825	8825IB	2.52"	10"	10"
	—	8826	8826IB	3.02"	4"	4"
	—	8827	8827IB	3.02"	6"	6"
	—	8828	8828IB	3.02"	8"	8"
	—	8829	8829IB	3.02"	10"	10"
	—	8831	8831IB	3.52"	8"	8"
WITH NIPPLE EXTENSION						
	FT13404N	8835	8835IB	1.75"	8"	4"
	FT13406N	8836	8836IB	1.75"	10"	6"
	FT13408N	8837	8837IB	1.75"	12"	8"
	FT13410N	8838	8838IB	1.75"	14"	10"
	FT20004N	8839	8839IB	2.00"	8"	4"
	FT20006N	8840	8840IB	2.00"	10"	6"
	FT20008N	8841	8841IB	2.00"	12"	8"
	FT20010N	8842	8842IB	2.00"	14"	10"
	FT22504N	8843	8843IB	2.25"	8"	4"
	FT22506N	8844	8844IB	2.25"	10"	6"
	FT22508N	8845	8845IB	2.25"	12"	8"
	FT22510N	8846	8846IB	2.25"	14"	10"
	FT25004N	8847	8847IB	2.50"	8"	4"
	FT25006N	8848	8848IB	2.50"	10"	6"
	FT25008N	8849	8849IB	2.50"	12"	8"
	FT25010N	8850	8850IB	2.50"	14"	10"
	—	8851	8851IB	3.00"	8"	4"
	—	8852	8852IB	3.00"	10"	6"
	—	8853	8853IB	3.00"	12"	8"
	—	8854	8854IB	3.00"	14"	10"



- ✓ *Complete Coverage*
- ✓ *Available with or without Expandable Nipple Extensions*
- ✓ *Available with Inner Braid*

Y-PIPES & TUBING

CONVENTIONAL "Y" PIPE

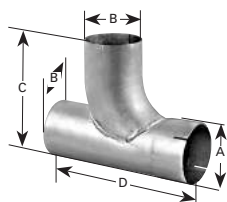

P/N	A	B	C	D
92698	4" ID	3" OD	8½"	14"
92678	4" ID	3½" OD	11"	15"
92679	4" ID	4" OD	9"	14"
92689	5" ID	5" OD	10½"	15"

SPLITTER "T" ADAPTER PIPE

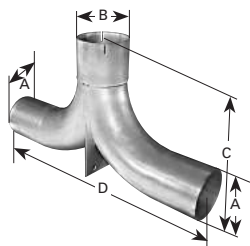

P/N WITHOUT BRACKET	P/N WITH BRACKET	A	B	C	D
92695	—	4" OD	4" ID	12"	20"
—	92673	4" OD	4" ID	11¼"	16"
—	92674	5" OD	5" ID	14"	25"
92696	—	5" OD	5" OD	11"	19"
92697	—	5" OD	5" ID	13½"	22"

UNIVERSAL ALUMINIZED Y-PIPES

UNIVERSAL ALUMINIZED Y-PIPES

P/N	INLET SIZE	OUTLET SIZE	OVERALL SIZE
AVY225	2 ¼" I.D.	2 ¼" O.D.	12"
AVY250	2 ½" I.D.	2 ½" O.D.	12"

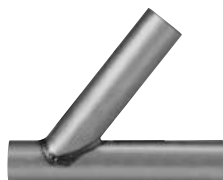

UNIVERSAL ALUMINIZED Y-PIPES

P/N	INLET SIZE	OUTLET SIZE	OVERALL SIZE
AY175	1 ¾" I.D.	1 ¾" O.D.	12 ½"
AY200	2" I.D.	2" O.D.	12 ½"
AY225	2 ¼" I.D.	2 ¼" O.D.	12 ½"
AY250	2 ½" I.D.	2 ½" O.D.	13"
AY300	3" I.D.	2 ½" O.D.	13"



FLANGES & GASKETS

CONVERSION FLANGE AND TUBE



9524 Tube
9569 Flange (Sold Separately)



9586

P/N	SIZE	DESCRIPTION
9524	3"	TUBE
9569	3"	FLANGE
9586	4"	FLANGE 4" NH CUMMINS

SINGLE PIECE INSERTS WITH GASKET



8699



9259

P/N	DESCRIPTION
9260	CHEVROLET/GMC MED TRUCK/BUS w/ 366, 427 ENG.
8698	INTERNATIONAL MED TRUCK/BUS w/ V392 ENG.
8699	INTERNATIONAL MED TRUCK/BUS w/ V304, V345 ENG.
9259	CHEVROLET/GMC MED TRUCK BUS w/ 350 ENG.

FLEXIBLE TUBING

PRE-CUT FLEX HOSE STYLE ID-ID

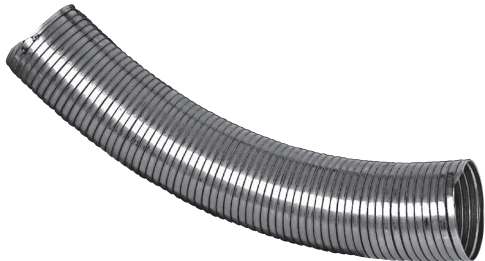

P/N STAINLESS	P/N ALUMINIZED	P/N GALVANIZED	LGTH.
3" DIA			
24675	—	24752	18"
—	—	24930	24"
—	—	34826	36"
3½" DIA			
24676	—	24753	18"
—	—	24849	24"
—	—	34785	36"
4" DIA			
14739	—	14738	12"
24677	24931	24754	18"
24836	—	24835	24"
34673	—	34743	36"
—	—	44786	48"
64791	—	64793	72"
5" DIA			
14737	—	14740	12"
24678	24933	24755	18"
24838	—	24837	24"
34674	—	34744	36"
44867	—	54831	48"
64792	—	64794	72"

PRE-CUT FLEX HOSE STYLE ID-OD

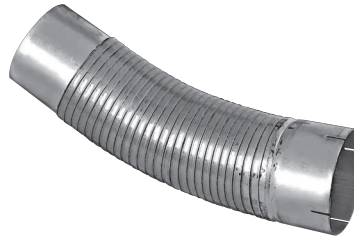

P/N STAINLESS	P/N GALVANIZED	LGTH.
3" DIA		
—	24674	18"
3½" DIA		
—	24935	18"
4" DIA		
—	24654	18"
5" DIA		
—	24936	18"

STAINLESS STEEL BELLOWS PIPE



P/N	DIA	LGTH.
9726	3"	12"
9727	3½"	12"
9728	4"	12"
9729	5"	12"

HEAVY DUTY FORD F750 FLEX BELLOW

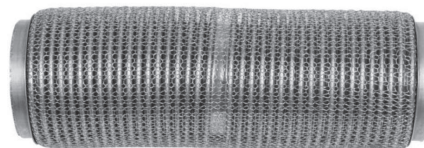

P/N	CROSS-SECTION	OAL
28819	5" OD x 4" ID	14½"

FLEXIBLE TUBING

PROCEDURE FOR CUTTING FLEXIBLE TUBING

NOTE: Flexible tubing coils are in a contracted state. Before cutting, anchor one end and pull and/or snap the coil to bring it back to its proper length.

HACKSAW: (For less frequent cutting)

WIDTH: ½" or ¾"

TEETH: A no set blade is preferred, although it is usually hard to find locally - 14 tooth or finer.

BANDSAW: (For less frequent cutting)

WIDTH: ½" or ¾"

TEETH: A no set blade - 14 tooth, run at 350 feet per minute.

A bi-metal blade gives more cuts per dollar than an ordinary carbon steel blade.

Lenox seems to be the best blade for our applications.



FLEX TUBING 10 FOOT LENGTHS

P/N STAINLESS STANDARD THICKNESS	P/N ALUMINIZED HEAVY DUTY THICKNESS	P/N GALVANIZED HEAVY DUTY THICKNESS	ID
8883	—	8984	2"
8855	—	—	2 ¼"
8884	8858	8985	2 ½"
8885	8859	8986	3"
8886	8876	8987	3 ½"
8887	8856	8988	4"
8888	8857	8989	5"
8895	—	8990	6"
—	—	8893	8"
—	—	8894	10"

FLEX TUBING 25 FOOT LENGTHS

P/N STAINLESS STANDARD THICKNESS	P/N GALVANIZED STANDARD THICKNESS	P/N GALVANIZED HEAVY DUTY THICKNESS	ID
—	8860	—	1"
—	8861	—	1 ⅛"
—	8862	—	1 ¼"
—	8863	—	1 ⅜"
—	8864	—	1 ½"
—	8865	—	1 ⅝"
—	8866	—	1 ¾"
—	8867	—	1 ⅞"
—	8868	—	2"
—	8869	—	2 ⅛"
—	8870	—	2 ¼"
—	8872	—	2 ½"
8982	8875	8880	3"
8983	—	8881	3 ½"
8878	—	8882	4"
8879	—	8877	5"
8899	—	8898	6"

STRAIGHT TUBING ALUMINIZED

- Manufactured from Aluminum Killed Deep Drawing Quality Steel - Prevents Splits and Wrinkles
- Re-aluminized Weld Seam - Better Appearance and Helps Prevent Corrosion
- All the Necessary Diameters, Lengths and Gauges For Your Bending Needs



STRAIGHT TUBING

PART NO.	O.D.	GAUGE	LENGTH
BENDABLE ALUMINIZED TUBING			
112A1016	1 ½"	16	10'
112A7516	1 ½"	16	7.5'
134A1016	1 ¾"	16	10'
134A7516	1 ¾"	16	7.5'
178A7516	1 7/8"	16	7.5'
200A1014	2"	14	10'
200A1016	2"	16	10'
200A7514	2"	14	7.5'
200A7516	2"	16	7.5'
212A1014	2 ½"	14	10'
212A7514	2 ½"	14	7.5'
214A1014	2 ¼"	14	10'
214A7514	2 ¼"	14	7.5'
234A1014	2 ¾"	14	10'
300A1014	3"	14	10'
300A7514	3"	14	7.5'
300A1013	3"	13	10'
300A7513	3"	13	7.5'
312A1014	3 ½"	14	10'
312A1016	3 ½"	16	10'
312A7516	3 ½"	16	7.5'
400A1014	4"	14	10'
400A1016	4"	16	10'
400A7516	4"	16	7.5'
400A1414	4"	14	14'
412A1016	4 ½"	16	10'
500A1016	5"	16	10'
512A1016	5 ½"	16	10'
600A1016	6"	16	10'
800A1016	8"	16	10'

PART NO.	O.D.	GAUGE	LENGTH
BENDABLE ALUMINIZED TUBING			
I.D. SCARFED NO STAMPING ON TUBING			
200A1016SN	2"	16	10'
200A1014SN	2"	14	10'
214A1016SN	2 ¼"	16	10'
214A1014SN	2 ¼"	14	10'
212A1016SN	2 ½"	16	10'
212A1014SN	2 ½"	14	10'
300A1016SN	3"	16	10'
300A1014SN	3"	14	10'

PART NO.	O.D.	GAUGE	LENGTH
BENDABLE 409 STAINLESS TUBING			
200S1016	2"	16	10'
214S1014	2 ¼"	14	10'
212S1014	2 ½"	14	10'
300S1014	3"	14	10'
600S1016	6"	16	10'

PART NO.	O.D.	GAUGE	LENGTH
304 STAINLESS STEEL TUBING			
(NON-BENDABLE)			
312S1016	3 ½"	16	10'
400S1016	4"	16	10'
500S1016	5"	16	10'

PART NO.	O.D.	GAUGE	LENGTH
COLD ROLLED STEEL			
400C1016	4"	16	10'
500C1016	5"	16	10'
600C1016	6"	16	10'

PART NO.	SIZE	LENGTH
ALUMINIZED STEEL TUBING		
(ONE END SWAGED & SLOTTED, OTHER END-O.D.)		
923120	3"	10'
924120	4"	10'
925120	5"	10'

CHROME TIPS

FOREIGN CAR TIPS



P/N	INLET SIZE	OVERALL SIZE
XFC112	1 ½" I.D.	6" x 1 ¾"
XFC134	1 ¾" I.D.	6" x 2"
XFC200	2" I.D.	6" x 2 ¼"

CHEVELLE TIPS



P/N	INLET SIZE	OVERALL SIZE
XWS200	2" I.D.	1 ¾" x 3"
XWT200	2" I.D.	1 ¾" x 3 ¾"
XWT212	2 ½" I.D.	1 ¾" x 3 ¾"
XBT200	2" I.D.	2" x 3"
XST200	2" I.D.	2 ¾" x 2 7/8"
XWT214	2 ¼" I.D.	1 ¾" x 3 ¾"
XCT410	2 ½" I.D.	1 ¾" x 4"

INSIDE ROLL PENCIL TIPS



P/N	INLET SIZE	OVERALL SIZE
XRPT134	1 ¾" I.D.	8" x 2 ½"
XRPT200	2" I.D.	9" x 2 ¼"
XRPT214	2 ¼" I.D.	9" x 2 ½"
XRPT212	2 ½" I.D.	9" x 2 ¾"
XRPT3006	2" I.D.	6" x 3"
XRPT3506	2 ¼" I.D.	6" x 3 ½"
XRPT4006	2 ½" I.D.	6" x 4"
XRPT4012	2 ½" I.D.	12" x 4"
XRPT4018	2 ½" I.D.	18" x 4"
XRPT5012	2 ½" I.D.	12" x 5"
XRPT5018	2 ½" I.D.	18" x 5"
XRPT3512	2 ¼" I.D.	12" x 3 ½"
XRPT35123	3" I.D.	12" x 3 ½"
XRPT4012312	3 ½" I.D.	12" x 4"

DUAL TRANS AM TIPS



P/N	INLET SIZE	OVERALL SIZE
XDT214	2 ¼" I.D.	12" x 2 ½"

CHROME TIPS

DUAL PENCIL TIPS



P/N	INLET SIZE	OVERALL SIZE
XDP200	2" I.D.	11" x 5 1/2" (outlet 2 1/4")

DUAL ANGLE CUT TIPS



P/N	INLET SIZE	OVERALL SIZE
XDA200	2" I.D.	11" x 5 1/2" (outlet 2 1/4")

INSIDE ROLL ANGLE CUT TIPS



P/N	INLET SIZE	OVERALL SIZE
XRAC312	2" I.D.	12" x 3"
XRAC316	2" I.D.	16" x 3"
XRAC324	2" I.D.	24" x 3"
XRAC31212	2 1/4" I.D.	12" x 3 1/2"
XRAC312123	3" I.D.	12" x 3 1/2"
XRAC31216	2 1/4" I.D.	16" x 3 1/2"
XRAC31218	2 1/4" I.D.	18" x 3 1/2"
XRAC31222	2 1/4" I.D.	22" x 3 1/2"
XRAC412	2 1/2" I.D.	12" x 4"
XRAC418	2 1/2" I.D.	18" x 4"
XRAC422	2 1/2" I.D.	22" x 4"

TURN DOWN TIPS



P/N	INLET SIZE	OVERALL SIZE
XTD112	1 1/2" I.D.	8" x 1 3/4"
XTD134	1 3/4" I.D.	8" x 2"
XTD200	2" I.D.	9" x 2 1/4"
XTD214	2 1/4" I.D.	11" x 2 1/2"
XTD212	2 1/2" I.D.	13" x 2 1/2"

PENCIL TIPS



P/N	INLET SIZE	OVERALL SIZE
XPT112	1 1/2" I.D.	8" x 1 3/4"
XPT134	1 3/4" I.D.	8" x 2"
XPT200	2" I.D.	9" x 2 1/4"
XPT214	2 1/4" I.D.	9" x 2 1/2"
XPT212	2 1/2" I.D.	9" x 2 3/4"
XPT312	2" I.D.	12" x 3"
XPT3123	3" I.D.	12" x 3"
XPT316	2" I.D.	16" x 3"
XPT3203	3" I.D.	20" x 3"
XPT324	2" I.D.	24" x 3"
XPT31212	2 1/4" I.D.	12" x 3 1/2"
XPT312123	3" I.D.	12" x 3 1/2"
XPT31218	2 1/4" I.D.	18" x 3 1/2"
XPT31220	2 1/4" I.D.	20" x 3 1/2"
XPT312203	3" I.D.	20" x 3 1/2"
XPT4124	4" I.D.	12" x 4"
XPT416	2 1/2" I.D.	16" x 4"
XPT4184	4" I.D.	18" x 4"

CHROME TIPS

ANGLE CUT TIPS



P/N	INLET SIZE	OVERALL SIZE
XAC112	1 ½" I.D.	8" x 1 ¾"
XAC134	1 ¾" I.D.	8" x 2"
XAC200	2" I.D.	9" x 2 ¼"
XAC214	2 ¼" I.D.	9" x 2 ½"
XAC212	2 ½" I.D.	9" x 2 ¾"
XAC312	2" I.D.	12" x 3"
XAC312214	2 ¼" I.D.	12" x 3"
XAC316	2" I.D.	16" x 3"
XAC316214	2 ¼" I.D.	16" x 3"
XAC3163	3" I.D.	16" x 3"
XAC322	2" I.D.	22" x 3"
XAC3223	3" I.D.	22" x 3"
XAC324	2" I.D.	24" x 3"
XAC324214	2 ¼" I.D.	24" x 3"
XAC31212	2 ¼" I.D.	12" x 3 ½"
XAC31216	2 ¼" I.D.	16" x 3 ½"
XAC312163	3" I.D.	16" x 3 ½"
XAC31218	2 ¼" I.D.	18" x 3 ½"
XAC31222	2 ¼" I.D.	22" x 3 ½"
XAC3122212	2 ½" I.D.	22" x 3 ½"
XAC312223	3" I.D.	22" x 3 ½"
XAC412	2 ½" I.D.	12" x 4"
XAC412312	3 ½" I.D.	12" x 4"
XAC4124	4" I.D.	12" x 4"
XAC416312	3 ½" I.D.	16" x 4"
XAC418	2 ½" I.D.	18" x 4"
XAC4183	3" I.D.	18" x 4"
XAC4184	4" I.D.	18" x 4"
XAC422	2 ½" I.D.	22" x 4"
XAC4223	3" I.D.	22" x 4"
XAC424	2 ½" I.D.	24" x 4"
XAC5124	4" I.D.	12" x 5"
XAC518	2 ½" I.D.	18" x 5"
XAC5184	4" I.D.	18" x 5"
XAC524	2 ½" I.D.	24" x 5"
XAC6184	4" I.D.	18" x 6"

SPECIALTY TURN DOWN TIP - BOLT ON



P/N	INLET SIZE	LENGTH
9818	1 7/8" I.D.	11"

SPECIALTY CHROME TIPS - BOLT ON



P/N	INLET SIZE	LENGTH
9821	1 ½" I.D.	5 ¼"
9822	1 ¾" I.D.	5 ¼"
9817	1 7/8" I.D.	3 3/8"
9820	2" I.D.	5 ¼"
9819	2 ¼" I.D.	5 ¼"

STAINLESS TIPS

SPECIALTY TIPS



1



2



3



4



5



6



7

P/N	INLET SIZE	OVERALL SIZE	TYPE
XSCAM214	2 ¼" I.D.	7 22/25" x 2" - OAL 10"	1
XSCAM234	2 ¾" I.D.	7 ¾" x 2 ¼" - OAL 10"	1
XSSDW4128	2 ¼" I.D.	9" x 4 ½"	2
XSDW3002	2" I.D.	6 ¼" x 3"	3
XSDW41210	2 ¼" I.D.	3 ¼" x 3 ¾" - OAL 7"	4
XSRTPT3507	2 ¼" I.D.	7" x 3 ½"	4
XSOR512	2 ½" I.D.	5 ¼" x 3 ¼" - OAL 7 ½"	5
XSMS625L	2 ¼" I.D.	6 ¼" x 3 ¾" - OAL 12"	6
XSMS625R	2 ¼" I.D.	6 ¼" x 3 ¾" - OAL 12"	6
XSRS600	2 ¼" I.D.	6" Oval - OAL 9"	7

PENCIL TIPS



P/N	INLET SIZE	OVERALL SIZE
XSRPT200	2" I.D.	9" x 2 ¼"
XSRPT214	2 ¼" I.D.	9" x 2 ½"
XSRPT212	2 ½" I.D.	9" x 2 ¾"

CHEVY BOWTIE TIPS



P/N	INLET SIZE	OVERALL SIZE
XSCB214	2 ¼" I.D.	9" x 4 ¾"
XSCB212	2 ½" I.D.	9" x 4 ¾"
XSCB300	3" I.D.	9" x 4 ¾"

INSIDE ROLL ANGLE CUT TIPS



P/N	INLET SIZE	OVERALL SIZE
XSRAC316	2 ¼" I.D.	16" x 3"
XSRAC31212	2 ¼" I.D.	12" x 3 ½"
XSRAC31216	2 ¼" I.D.	16" x 3 ½"
XSRAC31218	2 ¼" I.D.	18" x 3 ½"
XSRAC31222	2 ½" I.D.	22" x 3 ½"
XSRAC418	2 ½" I.D.	18" x 4"
XSBRAC40124	4" Bolt On	12" x 4"
XSBRAC50124	4" Bolt On	12" x 5"
XSBRAC50125	5" Bolt On	12" x 5"
XSBRAC50184	4" Bolt On	18" x 5"
XSBRAC50185	5" Bolt On	18" x 5"

STAINLESS TIPS

ANGLE CUT TIPS



P/N	INLET SIZE	OVERALL SIZE
XSAC200	2" I.D.	9" x 2 ¼"
XSAC214	2 ¼" I.D.	9" x 2 ½"
XSAC212	2 ½" I.D.	9" x 2 ¾"
XSAC312214	2 ¼" I.D.	12" x 3"
XSAC316	2" I.D.	16" x 3"
XSAC316214	2 ¼" I.D.	16" x 3"
XSAC318	2 ¼" I.D.	18" x 3"
XSAC318212	2 ½" I.D.	18" x 3"
XSAC324	2 ½" I.D.	24" x 3"
XSAC31212	2 ¼" I.D.	12" x 3 ½"
XSAC31216	2 ¼" I.D.	16" x 3 ½"
XSAC31218	2 ¼" I.D.	18" x 3 ½"
XSAC31218212	2 ½" I.D.	18" x 3 ½"
XSAC31222	2 ¼" I.D.	22" x 3 ½"
XSAC31222212	2 ½" I.D.	22" x 3 ½"
XSAC412	2 ½" I.D.	12" x 4"
XSAC418	2 ½" I.D.	18" x 4"
XSAC422214	2 ¼" I.D.	22" x 4"

INSIDE ROLL STRAIGHT CUT TIPS



P/N	INLET SIZE	OVERALL SIZE
XSBRPT50124	4" Bolt On	12" x 5"
XSBRPT50125	5" Bolt On	12" X 5"

TURN DOWN TIPS



P/N	INLET SIZE	OVERALL SIZE
XSTD300	3" I.D.	16" x 3"
XSTD312	3 ½" I.D.	16" X 3 ½"
XSTD400	4" I.D.	18" x 4"

O.E. FLARED DIFFUSER TIP



Freightliner O.E. #04-24971-000
Thomas O.E. #135779

P/N	DIA	LGTH.
24011	4" ID	14 ½"

STAINLESS STEEL DIFFUSER TIP



P/N	INLET DIA	LGTH.
TK-6014DIF	4" ID Outlet 6" OD	14 ½"

STAINLESS TIPS

BOLT-ON / CLAMP-ON TIPS



ST1255S



ST1254S



ST1257S



ST1253S



ST1256S

P/N	INLET SIZE	OVERALL SIZE
ST1255S	2 ¼" I.D.	2" x 2 ¼"
ST1253S	2 ¼" I.D.	5 ½" x 3"
ST1257S	2 ¼" I.D.	7" x 3 ½"
ST1254S	2 ½" I.D.	7" x 3 ½"
ST1256S	2 ½" I.D.	10" x 3"

STAINLESS TIPS - OE REPLACEMENT STYLE (BOLT-ON, CLAMP-ON)

TOYOTA / LEXUS TIP



P/N	INLET SIZE	OVERALL SIZE	LENGTH
9850	w/ Mounting Saddle for 2" Pipe	2 ¾" x 3 7/16"	5 1/16"

HONDA/ACURA TIP - TAP ON



P/N	INLET SIZE	OVERALL SIZE
9816	For 1 ½" Pipe	5 ½" x 1 ½"

STAINLESS TIPS - OE REPLACEMENT STYLE (BOLT-ON, CLAMP-ON)

HYUNDAI TIPS



Hyundai, Santa Fe, LH
Hyundai, Veracruz, LH

P/N	INLET SIZE	OVERALL SIZE
ST1261S	2" I.D.	6¾" x 3" x 6"



Hyundai, Santa Fe, RH
Hyundai, Veracruz, RH

P/N	INLET SIZE	OVERALL SIZE
ST1262S	2" I.D.	6¾" x 3" x 6"

GMC TIP



GMC Acadia, LH & RH

P/N	INLET SIZE	OVERALL SIZE
ST1260S	2" I.D.	4½" x 3"

KIA/ACURA TIPS



Kia Sportage, LH
Acura MDX, LH

P/N	INLET SIZE	OVERALL SIZE
ST1265S	2" I.D.	5½" x 3¾" x 5¼"



Kia Sportage, RH
Acura MDX, RH

P/N	INLET SIZE	OVERALL SIZE
ST1266S	2" I.D.	5½" x 3¾" x 5¼"

MAZDA/ACURA TIPS



Mazda CX-9, LH
Acura TL, LH

P/N	INLET SIZE	OVERALL SIZE
ST1267S	2⅞" I.D.	5" x 3" x 7¼"



Mazda CX-9, RH
Acura TL, RH

P/N	INLET SIZE	OVERALL SIZE
ST1268S	2⅞" I.D.	5" x 3" x 7¼"

STAINLESS TIPS - OE REPLACEMENT STYLE (BOLT-ON, CLAMP-ON)

GM TIPS



Buick Enclave, LH

P/N	INLET SIZE	OVERALL SIZE
ST1263S	2 $\frac{3}{8}$ " I.D.	10" x 3" x 6"



Buick Enclave, RH

P/N	INLET SIZE	OVERALL SIZE
ST1264S	2 $\frac{3}{8}$ " I.D.	10" x 3" x 6"

FORD TIP



Ford Mustang GT

P/N	INLET SIZE	OVERALL SIZE
ST1269S	3" I.D.	5 $\frac{1}{2}$ " x 3 $\frac{1}{2}$ "

SPOUTS

TAIL SPOUTS

Recommended for passenger cars and trucks not equipped with a tail pipe. Can also be used with tractor mufflers to deflect exhaust gases away from the operator. For horizontal or vertical mounting.



STYLE A

STYLE B

P/N ALUMINIZED STYLE A (OD)	P/N CHROME STYLE A (OD)	P/N ALUMINIZED STYLE B (ID)	P/N CHROME STYLE B (ID)	DIAMETER	LENGTH
10921	—	—	—	2"	8" NAT
14342	—	—	—	2 $\frac{1}{4}$ "	12"
14343	—	—	—	2 $\frac{1}{2}$ "	10"
14634	—	—	—	2 $\frac{3}{4}$ "	12"
24344	—	14618	814621	3"	12"
—	—	—	824000	3"	18"
24345	—	14619	814622	3 $\frac{1}{2}$ "	12"
—	—	24938	824001	3 $\frac{1}{2}$ "	18"
24346	—	14620	814620	4"	12"
24717	824720	24713	824718	4"	18"
24718	824723	24714	824717	5"	18"
24347	—	24672	824673	5"	20"
—	—	24696	—	6"	20"

NAT = No Angle Trim (outlet)

TOOLS

CUT OFF WHEELS

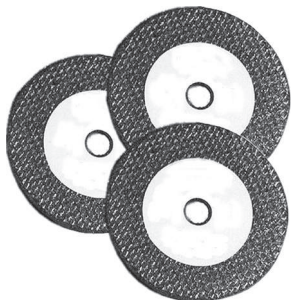

Part No. UP1150

(Three replacement cutting wheels)

PIPE HOOKS

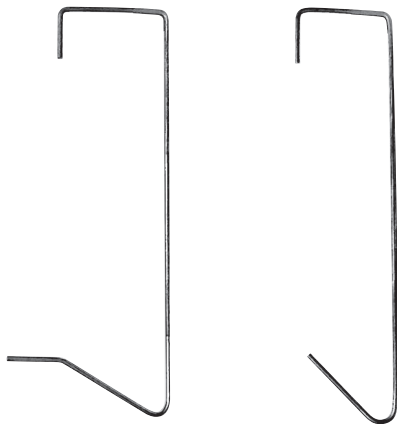

Part No. FPH51 – (1½" to 2½" Dia.)
Foreign car pipe hooks.

Part No. PH450 – (2¾" to 4" Dia.)
H.D. pipe hooks.

Part No. PH50 – (1½" to 2½" Dia.)
Pipe hooks.

Part No. PH550 – (5" to 6" Dia.)
H.D. pipe hooks.

ACCESSORIES

Part No. BB1 – Bin Box

Part No. BB2 – Bin Box

Part No. AP2025 – Gasket/Flange Board

Part No. GC1 – Gasket Cards

MUFFLER CEMENT



Part No. T27 – 16oz.

This high-performance muffler cement applies like putty but dries metal hard. Available in cases of 12 only.