



DEEZEE[®]

The Quality Truck Accessory People

PRODUCT CATALOG



SIDE STEPS

- 4** HEX SERIES SIDE STEPS
HEX SERIES CAST STEPS
BED ACCESS STEP
6" SIDE STEP
- 5** Nxt/NXc RUNNING BOARDS
ROUGH STEP
REAR TRANSIT ROUGH STEP
- 6** MOLDED SIDE STEP
LOUVERED SIDE STEP
3" & 4" NERF BARS
BRITE-TREAD RUNNING BOARD
- 7** SERRATED HITCH STEP
SIDE BOX STEP
BUMPER STEP



JEEP PRODUCTS

- 8** JL FULL ROOF RACK
FREEDOM ROOF RACK
- 9** SOLID CARGO RACK
REAR CARGO RACK
REAR DOOR WORK BENCH
SPARE TIRE ACCESSORY MOUNT
- 10** JEEP CARGO BOXES
LOUVERED SIDE STEPS
HEX SERIES SIDE STEPS
- 11** A-PILLAR LIGHT MOUNT
HOOD COWL LIGHT MOUNTS
CARGO SLIDES
- 12** FRONT & REAR DOORS
JK GRAB HANDLE
DOOR HANGERS
WINDSHIELD LIGHT MOUNT
- 13** LIGHT MOUNTS



BRONCO ACCESSORIES

- 14** REAR WINDOW MOLLE PANEL
FENDER DELETE
- 15** A-PILLAR LIGHT BRACKET
FENDER SIGHT BRACKET
FENDER SIGHT DELETE KIT
DASH ACCESSORY MOUNT
HINGE COVERS
DOOR CARGO POCKET
- 16** REAR DOOR WORK BENCH
REAR CARGO RACK BRACKET
CARGO SLIDE



TRUCK RACKS

- 17** PLATFORM CARGO RACKS
HITCH PLATFORM RACK
- 18** ALUMINUM CAB RACKS
HEX SERIES TRUCK RACK
INVIS-A-RACK
- 20** HALF LADDER RACK
LOUVERED SPORT BAR
LIGHT MOUNTS
TIE DOWNS



OVERLAND KIT & HEX RAILS

- 22** ALUMINUM CAB RACKS
OVERLAND SIDE RAILS
OVERLAND TOP RAILS
OVERLAND MOLLE PANELS
- 23** HEX SERIES SIDE RAILS
HEX SERIES CROSS RAILS
UNIVERSAL CROSS RAILS
HEX SERIES IN-BED RAILS



VEHICLE ACCESSORIES

- 24** TRUCK BED TIE-DOWNS
HEX SERIES TIE-DOWNS
STAINLESS STEEL SIDE RAILS
SIDE BED CAPS
- 25** HEAVY DUTY BED MATS
TAILGATE MAT
TAILGATE PROTECTORS
- 26** TAILGATE ASSIST
GATE GUARDIAN
- 27** TAILGATE BOARD
UNDER SEAT STORAGE DRAWER
- 28** MUD FLAPS
LICENSE PLATE MOUNT
- 29** FLOOR MATS
DITCH LIGHT MOUNTS



TOOL BOXES

- 30** PLATINUM TOOL BOX
BLUE LABEL TOOL BOXES
- 31** RED LABEL TOOL BOXES
STEEL TOOL BOXES
- 32** POLY CROSSOVER TOOL BOX
POLY TRAILER TRIANGLE BOX
- 33** SMALL POLY CHEST
LARGE POLY CHEST
POLY WHEEL WELL TOOL BOX
- 34** 5 DRAWER WHEEL WELL BOX
ALUMINUM WHEEL WELL BOX
TRIANGLE TRAILER BOX
NARROW TOOL BOXES
- 35** ATV TOOL BOXES
TOPSIDER TOOL BOXES
UNDERBED TOOL BOXES
UNDERBED MOUNTING BRACKETS
- 36** ACCESSORIES & REPLACEMENT PARTS



TRANSFER TANKS

- 42** TRANSFER TANKS
AUXILIARY TANKS
COMBO TANKS
COMBO TANK + PUMP
- 43** GAS CAPS
AUX CONNECTOR KITS
BUILD YOUR OWN COMBO



HEX SERIES SIDE STEPS

- Made of extruded aluminum and completed with a protective powder coat to stop corrosion in its tracks
- Integrated channel design allows you to adjust the position of the drop steps for customized placement
- Available in Textured Black or Gloss Black
- Custom bracket kits **(sold separately)**



HEX SERIES CAST STEP

- Enclosed cast step design adds style and a larger step surface
- Integrated channel design allows you to adjust the position of the drop steps for customized placement
- Available in a Textured Black powder coat finish
- Custom bracket kits **(sold separately)**

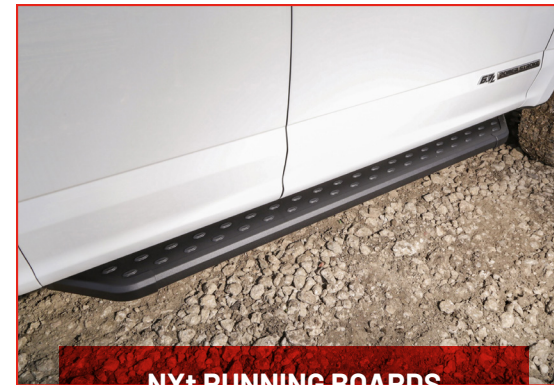

NXt RUNNING BOARDS

- Slip resistant rubber grommets line the 6" wide step area
- Available in black with black trim or black with chrome trim
- Regular Cab = 51" (1.3m), Extended Cab = 73" (1.85m), or Crew Cab = 86" (2.2m)
- Custom bracket kits **(sold separately)**



NXc RUNNING BOARDS

- Slip resistant rubber grommets line the 5" wide step area
- Available in black with black trim, black with chrome trim, or stainless with black trim
- Full-length aluminum protective accent trim
- Standard = 71.5" (1.82m)
- Custom bracket kits **(sold separately)**

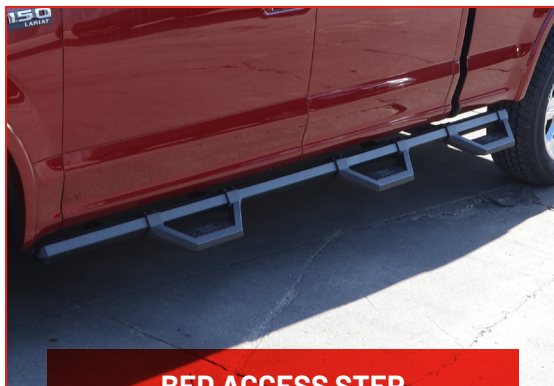

BED ACCESS STEP

- Features three aluminum cast steps on each side
- Gives you a boost up to access the bed of your truck from in front of your rear wheel well
- Available in a textured black powder coat finish
- Utilizes Hex Series extrusion for preferred placement of each cast step
- Custom bracket kits **(sold separately)**



6" SIDE STEP

- Constructed from tough, 16-gauge steel for a sleek clean look or Brite-Tread aluminum for more of a rugged off-road look
- Available in polished stainless steel, Brite-Tread aluminum, or with a textured black powder coat finish
- Molded plastic end caps and step pads
- Custom bracket kits **(sold separately)**



ROUGH STEP

- Aluminum or Steel construction protected by NRT™ powder coating
- Grated step surface allows dirt and debris to fall through and avoid build up
- Regular Cab = 51" (1.3m), Extended Cab = 73" (1.85m), or Crew Cab = 86" (2.2m)
- Custom bracket kits **(sold separately)**



REAR TRANSIT ROUGH STEP

- Aluminum construction protected by NRT™ powder coating
- Grated step surface allows dirt and debris to fall through and avoid build up
- Custom fit bracket kit included



MOLDED SIDE STEP

- Textured poly plastic construction
- Reinforced steel underneath to ensure a sturdy step up
- Extended Cab = 73" (1.85m), or Crew Cab = 86" (2.2m)
- Custom bracket kits **(sold separately)**



LOUVERED SIDE STEP

- Made of heavy-duty steel with fully welded ends
- Allows water and debris to drain through the board and keep the step area clear and slip free
- NRT™ textured black powder coat finish
- Extended Cab = 73" (1.85m), or Crew Cab = 86" (2.2m)
- Custom bracket kits **(sold separately)**



SERRATED HITCH STEP

- Constructed of heavy duty steel finished with a textured black NRT™ powder coat finish
- Rugged grated surface to ensure a safe step up
- Built in bottle opener and 10mm & 13mm hex wrenches
- Installs into 2" trailer hitches **(hitch pin included)**



SIDE BOX STEP

- Gain access to the front of your truck bed or toolbox
- Cast aluminum step with non-slip surface attaches to the frame of your truck
- Black powder coat finish
- Mount using existing factory holes in front of your rear wheel
- 300lb. Capacity • Driver side only



3" ROUND & 4" OVAL NERF BARS

- Constructed from tough, 14-gauge 304 stainless steel material or tough, black 14-gauge mild steel
- Molded plastic step pads at each door to ensure secure footing on the step area



***Custom-fit bracket kit for most applications ensures quick and easy installation Sold Separately**



BRITE-TREAD RUNNING BOARDS

- The classic style that started it all for Dee Zee
- Non-rusting Brite-Tread aluminum construction with front mud flap
- No drill, custom-fit bracing tucks under the vehicle to create a sleek look



BUMPER STEP

- Cast aluminum step with non-slip surface attaches to the frame of your truck
- Black powder coat finish
- Mount using existing factory holes below the bumper
- 300lb. Capacity • Driver side only

MAKE/MODEL	YEARS	SIDE BOX STEP - 6.5' BEDS	BUMPER STEP
SILVERADO / SIERRA 1500	22 - 19	DZ6211F6	DZ6202S
	18 - 14	DZ6202F6	DZ6202S
SILVERADO / SIERRA HD 2500/3500	22 - 20	-	DZ6211S
	19 - 15	DZ6202F6	DZ6202S
DODGE RAM 1500	22 - 19	DZ6207F6	DZ6207S
	18 - 10	DZ6203F6	DZ6203S
DODGE RAM 2500/3500	22 - 20	DZ6207F6	DZ6207S
	19 - 10	DZ6203F6	DZ6203S
FORD F150	22 - 15	DZ6204F6	DZ6204S
FORD SUPER DUTY	22 - 16	DZ6205F6	DZ6205S
NISSAN TITAN	22 - 19	-	DZ6208S
TOYOTA TUNDRA	21 - 19	-	DZ6209S
TOYOTA TACOMA	22 - 16	-	DZ6210S



- Maximize the functionality of your Wrangler JL
- Full roof rack kit includes a 24" rack to cover the front doors AND a 60" rack that covers the backseat and cargo area
- Tested weight capacity:
 - 24" rack: 200 lb. (static & dynamic)
 - 60" rack: 600 lb. (static) | 225 lb. (dynamic)
- Cross-bars can be moved forward and backwards in the aluminum hex extrusion to mount accessories
- Adjustable extrusions make the roof rack ideal for tents, canoes, bikes, or travel
- Installs easily into existing drip rails
- Rubber bumpers leave roof scratch free and provide additional stability
- Available Dee Zee accessories:
 - Solid Cargo Tray (right)
 - Hex Series Tie-Downs (pg. 24)



- 24" rack covers the front or rear doors of your JK/JL Wrangler or Gladiator
- Add another to cover both front AND rear doors
- Installs easily into existing drip rails
- 200 lb. tested weight capacity (**static & dynamic**)
- Cross-bars can be moved forward and backwards in the aluminum hex extrusion to mount accessories
- Rubber bumpers leave roof scratch free and provide additional stability
- Available Dee Zee accessories:
 - Solid Cargo Tray (right)
 - Hex Series Tie-Downs (pg. 24)

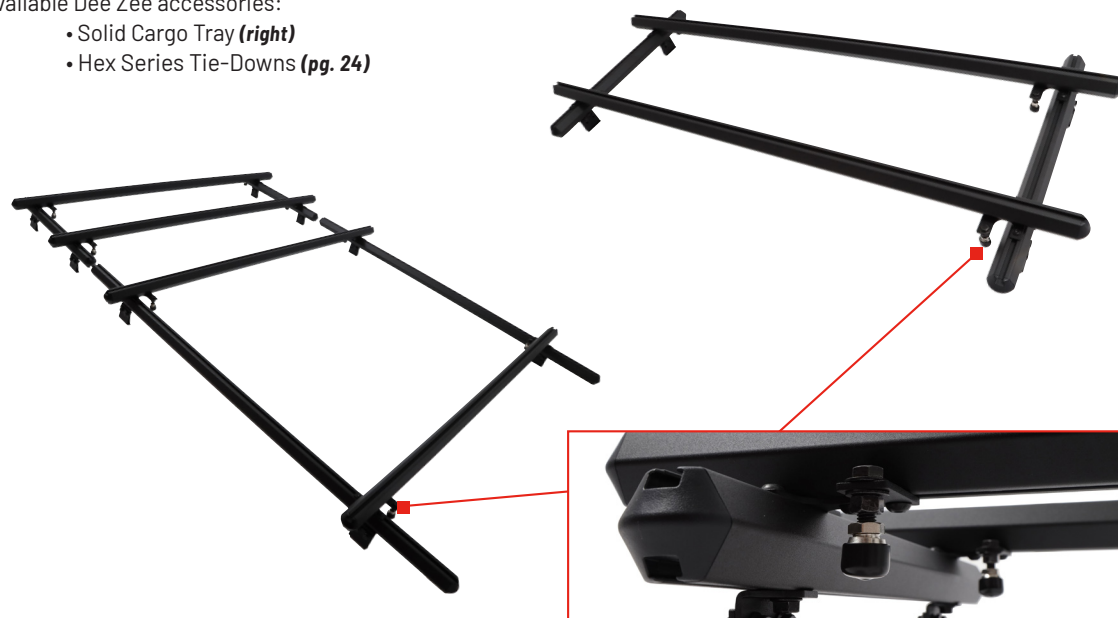

- Great for mounting to roof racks for additional storage space
- Made of durable steel and finished with NRT™ (**No Rust Technology**) texture black powder coat
- Custom bracket kit mounts in rear cargo area using existing factory holes. (**sold separately**)
- No drilling or cutting required



- Made of durable steel and finished with NRT™ (**No Rust Technology**) texture black powder coat
- Features a two-piece bolt together design
- The shelf slides along Hex channel rails to reach cargo easier
- Slide the shelf out for full access to the cargo area
- Comes with two hex series tie downs
- Custom bracket kit for JK & JL models (**sold separately**)



- Add sleek storage that folds when not in use
- Constructed of 14-gauge steel with a texture black coat for long lasting protection
- MOLLE panel design for increased functionality
- Maximum weight limit of 75 lbs.
- No drill installation using factory holes



- An easy way to add accessories to your spare tire
- Fits any vehicle with a rear mounted spare tire
- Elevated MOLLE panel design to secure items
- Steel construction topped with a textured black NRT™ powder coat
- Secured by any strap up to 3" wide (**not included**)



STANDARD JEEP BOX

- L: 36" W: 17" H: 13"
 • Fits 2 door and 4 door models

CARGO BOXES

- Lockable storage for Wrangler JK or JL
- Non-rusting .056 brite-tread aluminum with a texture black powder coat finish
- Pivoting design provides access to lower storage compartment without removing the box
- Thumb bolt secures the box to the floor and can only be accessed inside the tool box
- Water resistant foam gasket around the lid
- No-drill installation using factory holes



WIDE JEEP BOX

- L: 37" W: 31" H: 13"
 • Fits 4 door models Only
 • Angled front avoids interference with the rear door



LOUVERED SIDE STEPS

- Made of heavy duty 16-gauge steel
- Louvers allow mud, water, and debris pass through the step surface
- 6" wide step area
- Custom bracket kits **(sold separately)**



HEX SERIES SIDE STEPS

- Made from extruded aluminum and three powder coat finish options*
 - Integrated channel design allows you to adjust the position of the steps for customized placement
 - No drilling required for installation custom brackets **(sold separately)**
 - Available in hoop step style or cast plate for a larger step surface
- *Cast step available in texture black only**



A-PILLAR LIGHT MOUNT



A-PILLAR LIGHT MOUNTS

- Features an integrated extrusion channel that runs the length of the bracket for customized placement
- Great for attaching accessories like lights or a GoPro to catch the action **(not included)**
- Textured black powder coat finish

DZ4446JL (left)

- Requires Cowl Mount DZ4445JL for installation **(below)**

DZ4446JK (right)

- Mounts directing to existing factory holes
- All installation hardware is included
- *When A-Pillars are installed, windshield cannot be folded down**



HOOD COWL LIGHT MOUNTS

- Utilizes factory mounting locations
- Custom fit applications for no-drill installation **(hardware included)**
- Heavy duty steel construction with texture black powder coat finish
- Compatible with A-Pillars **(above)** and Cube Light Brackets **(pg. 13) (sold separately)**

DZ4445JK (not pictured)



CARGO SLIDE

- Access hard to reach cargo with pull out slides
- Sized to fit common travel refrigerators
- 5 configurations are available **see page 16 for options**
- Slides lock securely in place when not in use and automatic stop at full extension
- Mounts to existing factory bolts with a slotted design
- Constructed of heavy duty steel with a protective NRT™ powder coat finish

When A-Pillars, Cowl/Light Mounts are Installed, Jeep Windshield Cannot Be Folded Down



DZ4454JL

FRONT & REAR DOORS

- Constructed of lightweight extruded aluminum
- Installs in seconds over OEM door pin (includes cap)
- Full length welds with texture black powder coat finish
- Interior door latch for a sleek exterior design
- Door latches meet FMVSS204 requirements for Original Equipment Automotive latches
- Contours to the existing door frame
- Sold as a set of 4
- Fits Wrangler JL and Gladiator



GARAGE DOOR HANGER

DZ4460JP

- Store your factory doors in your garage when they're not in use.



JK INTERIOR GRAB HANDLE

FRONT HANDLES **REAR HANDLES**
DZ4450JKF **DZ4450JKR**
(Sold in pairs) *(Sold in pairs)*

- Grab a boost with a custom fit handle
- Mounts using existing factory holes
- Fits 2007-2018 Wrangler JK models

OTHER OPTIONS

Need a grab handle somewhere else? Wherever there's a hex channel you can mount a handle!

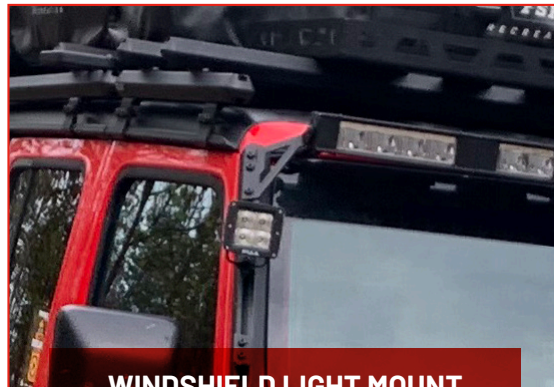

WINDSHIELD LIGHT MOUNT

Light Bar Width Limitations JK & JL/Gladiator: 50.5"

- DZ4462JK** - Requires DZ4446JK to install
- DZ4462JL** *(above)*
- Requires 4445JL & 4446JL to install
- Also mounts to Gladiator
- Made of heavy duty steel with a texture black powder coat finish.
- No drill installation - hardware included
- * Lights not included**



DZ4445JL

DOUBLE LIGHT MOUNT

- Made of heavy duty steel with texture black NRT™ powder coat finish
- No drill mounting using existing bolt locations on your Jeep
- Several mounting locations and configurations available
- * Lights not included**



DZ4452JL

SINGLE LIGHT MOUNT



DZ4453JL

DOUBLE LIGHT MOUNT



A-PILLAR CUBE LIGHT MOUNTS

- Must have A-Pillars to mount *(pg. 11)*
- Slide mount anywhere along the A-Pillar channel for customizable placement

SINGLE LIGHT MOUNT *(above)*
DZ4451JL

SINGLE LIGHT MOUNT
DZ4451JL

*** Lights not included**

****When A-Pillars and Cowl Light Mounts are installed, windshield cannot be folded down**



DZ4456JP

HOOD LIGHT MOUNT

Light Bar Width Limitations
JK: 22.5" • 32.75"
JL/Gladiator: 30.125" • 40.25"

- Mounts directly into hinges
- * Lights not included**

BRONCO ACCESSORIES



- Made of heavy duty 14 gauge steel
- Mounts easily with existing factory bolts
- Provides a convenient/modular mounting surface
- NRT™ black powder coat is a specially designed to increase corrosion protection
- No drilling required for easy installation
- Limited-lifetime warranty



- Constructed of HDPE plastic
- Installation hardware included
- Sold in sets of 4



- Heavy duty steel construction
- Protective black powder coat finish
- No drill installation



- Heavy duty steel construction
- Protective black powder coat finish
- Mount lights and other accessories
- No drill installation



- Made of die-cast aluminum
- Coated with protective powder coat finish
- Installs into existing factory points
- Hardware included



- Add a channel to the dash for mounting
- Installs into factory mounting points
- No drill installation
- Safely mount accessories



- Made of formed plastic
- Creates a sleek look while adding protection for the wiring harness and door hinge posts
- Sold as a set of 4

patent pending



- Add functional storage to the inside of the doors
- Made of therma-formed plastic
- Holds a full size water bottle
- Second storage space for other items



DZ4624
REAR DOOR WORK BENCH

- Constructed of 14-gauge steel
- Folds up out of the way when not in use
- MOLLE panel design for increased functionality
- Protected with texture black powder coat
- Maximum weight limit of 75lbs.
- No drilling required for easy installation
- Limited-lifetime warranty



DZ4622
REAR CARGO RACK BRACKET

- When used as rear storage it will only fit 4 door models
- Made of durable steel
- Protected with texture black powder coat
- Removable when not in use
- No drilling required for easy installation
- Limited-lifetime warranty



PLATFORM ROOF RACK

- Extruded aluminum extrusions
- Texture black powder coat finish
- Die cast aluminum corners
- Custom brackets to eliminate drilling
- Base platform allows for various configurations
- Add stanchions and risers to customize the rack
- Add Hex Series tie downs to provide an anchor point anywhere in the channel to secure cargo



CARGO SLIDE

- Access hard to reach cargo with pull out slides
- Universal fit for rear cargo area, trucks, or garages
- Sized to fit common travel refrigerators
- 5 configurations are available
- Slides lock securely in place when not in use and automatic stop at full extension
- Mounts to existing factory bolts with a slotted design
- Constructed of heavy duty steel with a protective NRT™ powder coat finish



CARGO SLIDE OPTIONS

36" base platform	DZ48800
18" base platform	DZ48801
36" cargo slide requires base	DZ48810
18" cargo slide requires base	DZ48811
16" solid HDPE panel	DZ48812

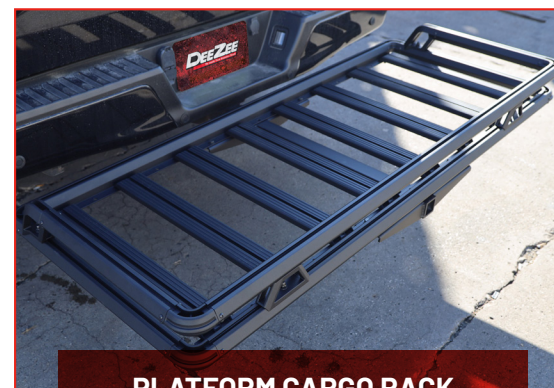

PLATFORM CARGO RACK

- Extruded aluminum extrusions
- Texture black powder coat finish
- Die cast aluminum corners
- Add tie downs anywhere along the rail to secure cargo
- Easily removed when not in use
- Fits standard 2" hitch receivers
- Hitch pin included
- 49"x27" or 65"x27"





CURVED ALUMINUM CAB RACKS

- Integrated channel system offers many accessory possibilities
- Two cast aluminum tie-downs included
- 2.5" hexagonal aluminum tubing
- Bolt-on mounting feet install into existing stake pocket holes
- Heavy-duty ultra mesh (**front**) or open frame (**rear**)
- Use 2 racks to transport longer items such as ladders, lumber, piping, and canoes



ANGLED ALUMINUM CAB RACKS

- ***Warehouse Distributor Exclusive***
- Integrated channel system offers many accessory possibilities (**right**)
- Welded mounting feet install into existing stake pocket holes
- 2.5" hexagonal aluminum tubing
- Heavy-duty ultra mesh (**front**) or open frame (**rear**)
- Use 2 racks to transport longer items

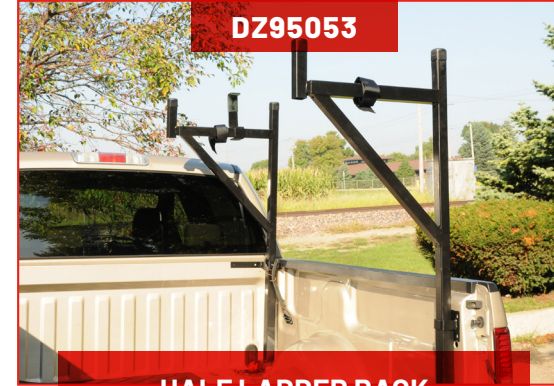

DZ95053
HALF LADDER RACK

- Heavy-duty 1/8" thick steel tubing
- Gloss black powder-coated finish
- Hook and loop straps and ladder stop included
- Adjustable height and width
- Bolt-on installation • drilling required
- Rated for 200 lb. weight capacity per set (2)
- Width: 23" x Height: 52.5"



LOUVERED SPORT BAR

- Made of heavy-duty steel tubing with a textured black powder-coat
- Louvered side panels give an aggressive off-road look
- No-drill installation into the bed's stake pocket holes
- Easily add auxiliary lights in the top track
- ***Lights not included**
- Built-in third brake light **wiring included**



HEX SERIES TRUCK RACK

- Integrated channels allow for adjusting the bars vertically for perfect placement
- Made from extruded hexagonal aluminum
- No-drill installation into existing stake pocket holes
- Durable, plastic end-caps
- Includes six bolts for mounting personalized accessories: **lights/tie-downs not included**
- 300 lb. weight limit



INVIS-A-RACK

- **Invisible to Invaluable...IN SECONDS!**
- Innovative cargo rack system
- Uprights hide away when not in use and pop-up in seconds for use with ladders, kayaks, and more!
- Lightweight, aluminum construction with a textured black powder coat finish
- Installs easily without drilling
- 500 lb. capacity

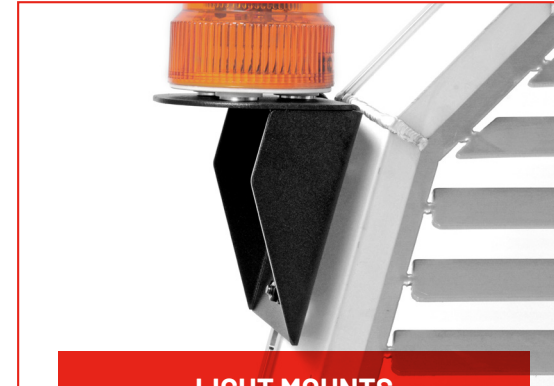

LIGHT MOUNTS

- **DZ95063 Extra Large**
- **DZ95062 Large**
- **DZ95064 Side Mount (above)**
- Black NRT™ powder-coated steel
- Sold individually
- *** Lights not included**



DZ95002

TIE-DOWNS

- Cast-aluminum construction
- Add anchor points to the integrated channels on Dee Zee Cab Racks
- Set of two

ALUMINUM CAB RACKS

MAKE / MODEL	YEARS	SILVER MESH PART # (FRONT)	GLOSS BLACK MESH PART # (FRONT)		TEXTURED BLACK MESH PART # (FRONT)	SILVER NO MESH PART # (REAR)	GLOSS BLACK NO MESH PART # (REAR)	TEXTURED BLACK NO MESH PART # (REAR)
GM SILVERADO/SIERRA	2022-1973	DZ95050R	DZ95050RB		DZ95050RTB	DZ95054R	DZ95054RB	DZ95054RTB
GM COLORADO/CANYON	2022-2015	DZ95070R	DZ95070RB		DZ95070RTB	DZ95071R	DZ95071RB	DZ95071RTB
DODGE RAM 1500	2022-2019	DZ95050R	DZ95050RB		DZ95050RTB	-	-	-
	2018-2009	DZ95050R	DZ95050RB		DZ95050RTB	DZ95054R	DZ95054RB	DZ95054RTB
DODGE RAM 2500/3500	2022-2013	DZ95058R	DZ95058RB		DZ95058RTB	DZ95054R	DZ95054RB	DZ95054RTB
	2012-2010	DZ95057R	DZ95057RB		DZ95057RTB	DZ95054R	DZ95054RB	DZ95054RTB
FORD F-150	2022-1973	DZ95050R	DZ95050RB		DZ95050RTB	DZ95054R	DZ95054RB	DZ95054RTB
FORD SUPER DUTY	2022-2017	DZ95072R	DZ95072RB		DZ95072RTB	DZ95073R	DZ95073RB	DZ95073RTB
	2016-1999	DZ95050WR	DZ95050WRB		DZ95050WRTB	DZ95054WR	DZ95054WRB	DZ95054WRTB
FORD RANGER	2022-2019	DZ95070R	DZ95070RB		DZ95070RTB	DZ95071R	DZ95071RB	DZ95071RTB
JEEP GLADIATOR	2022-2019	DZ95070R	DZ95070RB		DZ95070RTB	DZ95071R	DZ95071RB	DZ95071RTB
TOYOTA TUNDRA	2021-2007	DZ95050R	DZ95050RB		DZ95050RTB	-	-	-
TOYOTA TACOMA	2022-2016	DZ95070R	DZ95070RB		DZ95070RTB	DZ95071R	DZ95071RB	DZ95071RTB

WELDED CAB RACKS

MAKE / MODEL	YEARS	TEXTURED BLACK MESH PART # (FRONT)	TEXTURED BLACK NO MESH PART # (REAR)
GM SILVERADO/SIERRA	2022-1973	DZ95090TB	DZ95094TB
GM COLORADO/CANYON	2022-2015	DZ95091TB	DZ95095TB
DODGE RAM 1500	2022-2019	DZ95090TB	-
	2018-2009	DZ95090TB	DZ95094TB
DODGE RAM 2500/3500	2022-2013	DZ95098TB	DZ95094TB
	2012-2010	-	DZ95094TB
FORD F-150	2022-1973	DZ95090TB	DZ95094TB
FORD SUPER DUTY	2022-2017	DZ95092TB	DZ95093TB
FORD RANGER	2022-2019	DZ95091TB	DZ95095TB
JEEP GLADIATOR	2022-2019	DZ95091TB	DZ95095TB
TOYOTA TUNDRA	2021-2007	DZ95090TB	-
TOYOTA TACOMA	2022-2016	DZ95091TB	DZ95095TB

INVIS-A-RACK

FULL-SIZE TRUCKS*

5.5' Beds	DZ951550
6' & 6.5' Beds	DZ951600
8' Beds	DZ951800

HEX CAB RACKS

MAKE / MODEL	YEARS	TEXTURED BLACK
CHEVY SILVERADO / GMC SIERRA	2022-2007	DZ95250TB
DODGE RAM 1500	2022-2009	DZ95251TB
DODGE RAM 2500/3500	2022-2010	DZ95251TB
FORD F150	2022-2015	DZ95252TB
FORD SUPER DUTY	2022-2016	DZ95253TB

LOUVERED SPORT BAR

MAKE / MODEL	YEARS	SPORT BAR
GM SILVERADO/SIERRA	2022-1999	DZ960050B
DODGE RAM 1500	2018-2002	DZ960051B
DODGE RAM 2500 / 3500	2019-2003	DZ960051B
FORD F-150	2022-2009	DZ960050B
FORD SUPER DUTY	2022-2008	DZ960052B
NISSAN TITAN	2018-2017	DZ960050B
TOYOTA TUNDRA	2016-2007	DZ960050B



START HERE

ALUMINUM CAB RACKS

- Fits mid-size and full size trucks
- Use 2 Dee Zee Cab Racks as a base
 - 1 protective mesh front rack
 - 1 open rear rack
- Select from:
 - CURVED TOP: **Pg. 18**
 - ANGULAR TOP: **Pg. 18**



TIE IT TOGETHER

OVERLAND SIDE RAILS

- DZ95011TB** 5.5' full size
- DZ95012TB** 6.5' full size
- DZ95010TB** Mid-size
- Lightweight, extruded aluminum construction with textured black powder coat
- Adds strength by tying the front/rear racks together
- Includes 4 Side Rails (2 Per Side), such as the Dee Zee Overland MOLLE Panels below

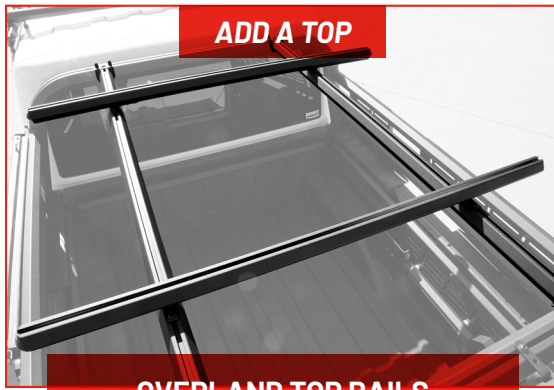

ADD A TOP

OVERLAND TOP RAILS

- DZ95021TB** 5.5' full size
- DZ95022TB** 6.5' full size
- DZ95020TB** mid-size
- Creates a top mounting surface for adding roof top tents, cargo carriers, athletic racks, and more!*
- Includes 2 Top Rails & 2 Cross Rails with integrated channels that allow for custom rail placement
- Weight Capacity: 225 lbs. dynamic & 600 lbs. static**

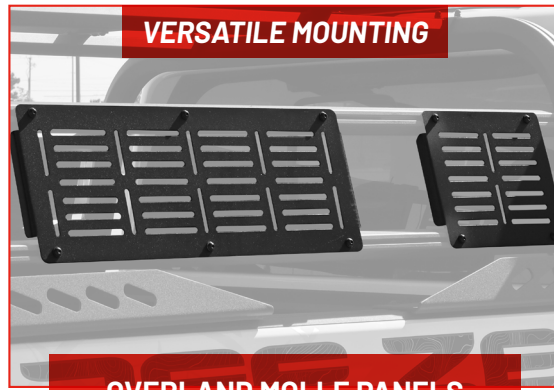

VERSATILE MOUNTING

OVERLAND MOLLE PANELS

- DZ95030TB** 12" wide
- DZ95031TB** 27" wide
- Mounts to Overland Side Rails (**above**) to provide a convenient/modular mounting surface**
- Constructed of 14 gauge steel with a NRT™ textured black powder coat finish



HEX SERIES SIDE RAILS

- Hexagonal aluminum tubing with built-in channel for endless accessory options
- Cast stanchions mount in your stake pockets without drilling
- Add 3D protection and tie-down points to your truck's bed rail (**pg. 24**) (**sold separately**)
- Capacity Evenly Distributed: 200lbs.



#DZ99799TB

HEX SERIES CROSS RAILS

- *Side Rails Sold Separately & Required for Installation*
- Installs onto Dee Zee Hex Series Side Rails (**sold separately**) (**above**)
- Full-length integrated channel design provides endless accessory possibilities such as roof top tents, recreational racks, and more!*
- Extruded aluminum construction protected by a textured black powder coat finish
- Cross bars can slide back & forth along the entire Side Rail channel for ideal placement
- Capacity: Dynamic: 200lbs. & Static: 600lbs.



DZ99780BPT - Toyota install kit
DZ99780BPN - Nissan install kit

UNIVERSAL CROSS RAILS

- DZ99780TB** Mid-Size **DZ99781TB** Full-Size
- Universal design installs under the lip of most truck beds
- Textured black extruded aluminum construction featuring a full-length integrated accessory channel
- Hole pattern in the stanchions provide further customization options:
 - Add Tie-Down Anchors #DZ97903 (**pg. 24**)
 - Add Hex Series Side Rails
- Capacity: Dynamic: 225lbs. & Static: 600lbs.



*Accessories not included

HEX SERIES IN-BED RAILS

- Installs into existing bed mounting points in RAMs and Jeep Gladiators
- Full-length integrated channel for mounting accessories*:
 - Tie-Down Anchors #DZ99700TB (**pg. 24**)
 - MOLLE Panels (**pg. 22**)
- *Dodge applications require Dee Zee Truck Bed Tie-Downs to Install #DZ97913 • x3 Sets ***

*Sold Separately

**Cab Racks and Side Rails Sold Separately & Required for Installation



TRUCK BED TIE DOWNS

- An easy way to add tie-down points for securing cargo
- Rated for up to 250 lbs
- No-drill installation into existing bed mounting points
- Made from cast aluminum
- Available for Silverado, Sierra, Colorado, Canyon, F-150, Super Duty, Ranger, and RAM.



DZ99700TB

HEX SERIES TIE-DOWNS

- Add convenient anchor points to the integrated channels on Dee Zee Hex Series Products:
 - Truck Racks (pg. 18)
 - Side Rails (pg. 23)
 - Cross Rails (pg. 23)
 - Jeep Roof Racks (pg. 8)
 - Overlanding Racks (pg. 22)
- Slide and Lock Design
- Rated for 200 lbs.



HEAVY DUTY BED MATS

- Prevent cargo from shifting and damaging your bed
- Rubber cleats help hold the mat in place & allow water to drain
- Resists most chemical and oil spills
- Custom-fit applications contour wheel wells
- 3/8" (9.52mm) thick, tear-resistant rubber construction
- Universal utility mats also available

More applications available

BED MAT APPLICATIONS		Part #
Silverado/Sierra 1500		
22 - 19	5.5' Bed	DZ87019
	6.5' Bed	DZ87020
Silverado/Sierra 2500/3500		
22 - 20	6.5' Bed	DZ87022
	8' Bed	DZ87021
Ram Pickup 1500 model		
22 - 19	5.5' Bed	DZ87015
	6' Bed	DZ87016
Ram 2500/3500		
22 - 03	5.5' Bed	DZ86996
	6' Bed	DZ86917
F150 Pickup (1997+)		
22 - 15	5.5' Bed	DZ87005
	6.5" Bed	DZ87006
Super Duty Pickup		
22 - 17	6.5' Bed	DZ87011
	8' Bed	DZ87012
Gladiator		
22 - 20		DZ87026
Universal Bed Mat 4' x 8'		DZ85005



STAINLESS STEEL SIDE RAILS

- Polished stainless steel construction
- Custom length applications install into stake pocket holes
- Thick, 1.9" diameter
- No-drill installation on full-size applications
- Mid-size trucks require drilling for installation



SIDE BED CAPS

- Brite-Tread aluminum construction, also available with gloss black powder coat
 - Custom-fit applications
 - Fits perfectly over factory plastic*
 - 2 Styles available: Standard with no holes or with a take pocket holes
- *Tailgate Protectors and Side Bed Caps cannot be installed if factory plastic has been removed*



DZ86700

TAILGATE MAT

- Universal width fits most full-size pickups
- 60" x 19.5" • some trimming may be required
- Extra thick, 3/8" cord-enhanced rubber
- Can be trimmed to fit mid-size trucks
- Mounting hardware included
- Drilling required for installation

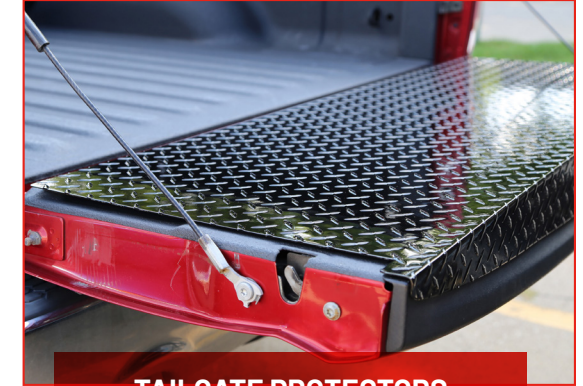

TAILGATE PROTECTORS

- 2 Styles available:
 - Standard Tailgate Cap
 - Full Tailgate Protector (**above**)
 - Brite-Tread aluminum construction, also available with gloss black powder coat
 - Custom-fit applications
 - Fits perfectly over factory plastic*
- *Tailgate Protectors and Side Bed Caps cannot be installed if factory plastic has been removed*



TAILGATE ASSIST

Safely control the drop rate of your truck's tailgate!

- Custom designed specifically by make/model
- High quality, extensively tested for heavy use
- Works in conjunction with factory cables
- Easy, no-drill installation • installs in minutes
- All hardware included • minimal tools required
- Installs on driver side only • 1 unit per truck

MAKE / MODEL	YEARS	PART #	NOTES
CHEVY/GMC			
SILVERADO/SIERRA 2500/3500 HD	2022-2020	DZ43104	Work Truck Trim Only
	2019-2014	DZ43102	
SILVERADO/SIERRA 1500	2022-2019	DZ43103	Work Truck Trim Only
	2018-2014	DZ43102	
SILVERADO/SIERRA 1500/2500/3500	2013-2007	DZ43102	'07 Classic Only
	2007-1999	DZ43100	
COLORADO/CANYON	2020-2015	DZ43105	
DODGE / RAM			
RAM 1500	2022-2019	DZ43302	New body style
	2022-2009	DZ43301	22 - 19 classic body only
	2008-2002	DZ43300	
RAM 2500/3500	2022-2010	DZ43301	
	2009-2003	DZ43300	
JEEP			
GLADIATOR	2022-2020	DZ43303	
FORD			
F-150	2022-2015	DZ43204	
	2014-2004	DZ43200	Not Flareside
	2003-1997	DZ43203	Not Flareside/SuperCrew
SUPER DUTY	2022-2017	DZ43205	
	2016-1999	DZ43203	
RANGER	2022-2019	DZ43206	
MAVERICK	2022-2021	DZ43207	



DZ97970

GATE GUARDIAN

- Theft deterrent for truck tailgates
- Uses tamper resistant security screw to deter thieves
- Foam liners and wrench included for installation
- Installs on passenger side
not compatible with power tailgates
- Patent pending design installs in minutes
- Three year limited warranty

TAILGATE PREP BOARD

CHEVROLET / GMC			
Silverado/Sierra			
22 - 19	1500		DZ284123
22 - 19	1500 multi-function tailgate		DZ284123M
21 - 20	2500/3500		DZ284123
19 - 15	2500/3500		
Colorado/Canyon			
22 - 15			DZ284124

DODGE / RAM TRUCKS

Ram Pickup 1500 model (not 60/40 split tailgate)			
22 - 19			DZ284144

FORD

F150 Pickup (1997+)			
22 - 15			DZ284140
Super Duty Pickup			
22 - 17			DZ284103
Maverick Pickup			
22 - 22			DZ284127
Ranger Pickup			
22 - 19			DZ284126

JEEP

Gladiator			
22 - 19			DZ284151

Tacoma

22 - 16			DZ284172
---------	--	--	----------

UNDER SEAT STORAGE DRAWER

CHEVROLET / GMC

Silverado/Sierra 1500			
22 - 19			DZ700
Silverado/Sierra 2500/3500			
22 - 20			DZ700

FORD

F150			
22 - 15			DZ701
Super Duty Pickup			
22 - 17			DZ701



TAILGATE BOARD

- Solid work surface screws into existing factory holes
- 1/2" thick HDPE polymer composition
- UV and extreme weather resistant
- Maintenance-free, for easy to clean up
- Excellent impact resistance
- Three year warranty



UNDER SEAT STORAGE DRAWER

- Under seat slide and store for full size Chevy and Ford
- Mounts under the rear seat for lockable storage
(hardware included)
- Pull out drawer can be accessed from the driver or passenger side
- Heavy-duty steel construction with texture black NRT™ powder coat
- Three plastic partitions to contain items for transport
- Three year warranty



MUD FLAPS

- Fits most trucks, vans, and SUVs
- Installs in minutes
- Mounting hardware included
- Sold in pairs

UNIVERSAL BRITE-TREAD **1** **DZ1808**

- 11" x 19" (with radius notch)
- Classic Brite-Tread aluminum
- Fits front or rear wheels

UNIVERSAL BLACK-TREAD **2** **DZ1808TB**

- 11" x 19" (with radius notch)
- Textured black powder coat finish
- Fits front or rear wheels

UNIVERSAL PLASTIC **3** **DZ17939**

- 11" x 18" • with notch
- Fits front or rear wheels

BRITE-TREAD **4** **DZ1800**

- 12" x 16"
- Classic Brite-Tread aluminum finish
- Fits full size trucks
- Measure for clearance

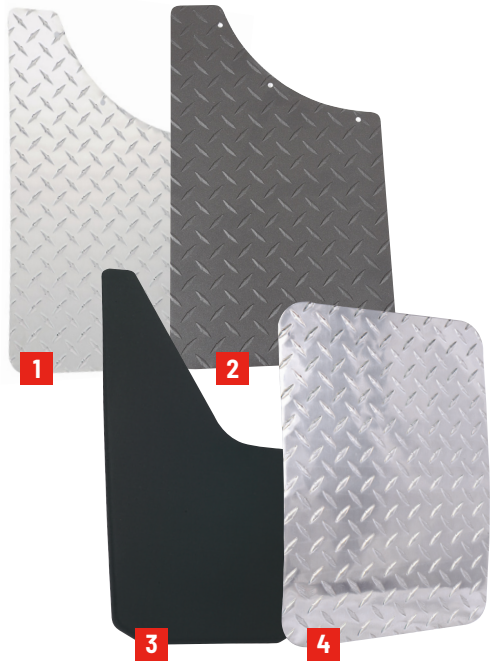

LICENSE PLATE MOUNT

DZLPMOUNT

- Legally relocate your front license plate
- Durable steel construction
- Textured black powder coat finish
- Hardware included



ALL WEATHER FRONT MATS **5**

- 19" x 28"
- Edges can be trimmed

ALL WEATHER TREAD MATS **6**

- Brite-Tread aluminum insert
- 20.5" x 27"

ALL WEATHER REAR MATS **7**

- 17" x 17"

ALL WEATHER FULL-WIDTH MAT **8**

- Sold individually
- 61" x 27" Overall



DITCH LIGHT MOUNTS

- Custom fit for full size trucks
- Installs in minutes
- Mounting hardware included
- *Lights not included*



DITCH LIGHT MOUNTS

CHEVROLET / GMC

Silverado/Sierra		
22 - 19	1500 model	DZ1071

Colorado / Canyon		
22 - 15		DZ1073

DODGE / RAM TRUCKS

Ram Pickup		
22 - 19	1500 model	DZ1076

FORD

F150 Pickup		
22 - 15		DZ1076

Super Duty Pickup		
22 - 17		DZ1077

Ranger		
22 - 19		DZ1078

TOYOTA

Tundra Pickup		
21 - 16		DZ1076

Tacoma		
22 - 07		DZ1074



PLATINUM TOOL BOX

- Automotive-grade handles allow for smooth operation and secure closure
- Constructed of heavy gauge .090 Brite-Tread aluminum
- The automotive-grade rubber seal keeps elements out
- Features a heavy duty steel tray
- Smooth extruded aluminum reinforced lid



Available in: Crossover



BLUE LABEL TOOL BOX

- The automotive-grade rubber seal keeps elements out
- Self-adjusting strikers close tightly no matter how hard you push
- Added security with push button latches
- Full length hidden piano hinge for extra strength
- Removable tool tray in crossover styles
- Built-in divider for convenience and strength



AVAILABLE IN:



RED LABEL TOOL BOXES

- The closed cell foam gasket keeps out the elements
- Adjustable striker for a tight seal
- Added security with lockable paddle or pull handle
- Full length hidden piano hinge for extra strength
- Removable tool tray in crossover styles
- Double v-pan lid stiffener creates strength and rigidity



AVAILABLE IN:



HARDWARE TOOL BOXES • STEEL

Storage products built with the contractor in mind but versatile enough for the rest of us

- Sturdy 20-gauge steel
- NRT™ corrosion resistant powder coating
- Paddle handle latches and adjustable strikers
- Full length piano hinge for extra strength
- Closed cell foam gasket



AVAILABLE IN:





DZ6163P & DZ6170P

POLY CROSSOVER

- Combines the functionality of a crossover box with the benefits of a poly plastic container
- Features a full-length locking rod that engages strikers built into the lid
- Single cam lock secures the lid tightly
- Overlapping lid deflects water
- Double-walled lid for extra support
- Integrated frame supports
- Installation bracket included



DZ91717P

POLY TRIANGLE TRAILER BOX

- Dimensions: Back-36", Front-18", Width-19.5", Height-18"
- Rigid poly plastic frame resists warping
- Lightweight yet solid construction
- Double wall lid for extra support
- Perfect fitment for trailer tongues
- Steel hasp provides security*



DZ6535P

SMALL POLY CHEST



35" x 14" x 13"

- Fits great in SUV's
- Molded locking tabs*
- Double wall lid for extra support

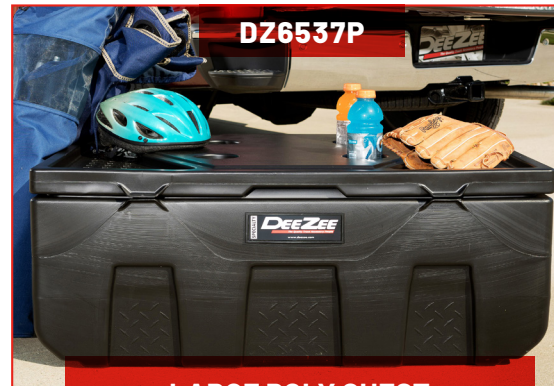

DZ6537P

LARGE POLY CHEST



39" x 27" x 17"



DZ95P

POLY WHEEL WELL BOX



- Fits behind the truck wheel well
- Lid reverses easily for driver or passenger side application
- Sturdy full length hinge
- Lockable lift-up lid
- Does not interfere with most tonneau covers

***PADLOCK NOT INCLUDED**

BLUE LABEL	BRITE-TREAD		GLOSS BLACK	TEXTURED BLACK			L	W	H	L1	W1	H1	W2	H2	Vol.
CROSSOVERS															
STANDARD	DZ9170		DZ9170B	DZ9170TB			69.75"	19.875"	17.5"	60.75"	-	12.5"	-	5"	12.8 cu. ft.
LOW PROFILE	DZ9170L		DZ9170LB	-			69.75"	19.875"	17.5"	60.75"	-	12.5"	-	5"	12.5 cu. ft.
WIDE	DZ9170W		DZ9170WB	-			69.75"	25.8"	14.6"	60.75"	-	9.6"	-	5"	13.9 cu. ft.
CHESTS															
STANDARD	DZ9546		DZ9546B	DZ9546TB			46.5"	20.125"	14.2"	-	-	11.4"	1.4"	-	7.6 cu. ft.
SIDE MOUNTS															
48" SIDE MOUNT	DZ9748		DZ9748B	-			48"	14.25"	11"	-	10"	5"	4.25"	5"	3.75 cu. ft.
68" SIDE MOUNT	DZ9768		DZ9768B	-			68"	14.25"	11"	-	10"	5"	4.25"	5"	5.3 cu. ft.
RED LABEL	HANDLE	BRITE-TREAD	GLOSS BLACK	TEXTURED BLACK	WHITE STEEL	BLACK STEEL	L	W	H	L1	W1	H1	W2	H2	Vol.
CROSSOVER															
STANDARD	PADDLE	DZ8170	DZ8170B	DZ8170TB	DZ8170S	DZ8170SB	69.75"	20"	12.2"	60.75"	17.125"	7.2"	1.44"	6"	8.4 cu. ft.
	PULL	DZ10170	-	DZ10170TB											
MID-SIZE • STANDARD	PADDLE	DZ8163	DZ8163B	-	DZ8163S	DZ8163SB	63"	20"	12.2"	54"	17.125"	7.2"	1.44"	6"	7.4 cu. ft.
DEEP	PADDLE	DZ8170D	DZ8170DB	-			69.75"	20"	18.25"	60.75"	17.125"	13.25	1.44"	6"	12 cu. ft.
LOW-PROFILE	PADDLE	DZ8170L	DZ8170LB	DZ8170LTB			69.75"	20"	12.2"	60.75"	17.125"	11.2"	1.44"	2"	8 cu. ft.
	PULL	DZ10170L	-	DZ10170LTB											
DOUBLE-LID	PADDLE	DZ8370	DZ8370B	-	-	DZ8370SB	69.75"	20"	12.2"	60.75"	17.125"	7.2"	1.44"	6"	8.4 cu. ft.
	PULL	-	-	DZ10370TB											
MID-SIZE • DOUBLE-LID	PADDLE	DZ8363	-	-			63"	20"	12.2"	54"	17.125"	7.2"	1.44"	6"	7.4 cu. ft.
CHESTS															
SMALL CHEST	PADDLE	DZ8537	DZ8537B	-			37.125"	19"	16"		-	13.1"	2.4"	3.9"	6.4 cu. ft.
MID SIZED CHEST	PADDLE	DZ8546	DZ8546B	DZ8546TB	DZ8546S	DZ8546SB	46.5"	19"	16"		16.6"	13.1"	2.4"	3.9"	8 cu. ft.
	PULL	-	-	-											
STANDARD CHEST	PADDLE	DZ8556F	DZ8556FB	-	DZ8556FS	DZ8556FSB	56"	19"	16"		16.6"	13.1"	2.4"	3.9"	9.8 cu. ft.
SLANTED CHEST	PADDLE	DZ8556	DZ8556B	-			56"	19"	16"		12.375"	13.1"	6.625"	3.9"	8.9 cu. ft.
WIDE CHEST	PADDLE	DZ8560W	DZ8560WB	-			60"	24"	18.1"			15.4"	2.4"	3.9"	14.9 cu. ft.
SIDE MOUNTS															
48" SIDE MOUNT	PADDLE	DZ8748	-	-	DZ8748S	DZ8748SB	48"	12.75"	10"		8.5"	6"	4.25"	5"	3 cu. ft.
60" SIDE MOUNT	PADDLE	DZ8760	-	-	DZ8760S	DZ8760SB	60"	12.75"	10"		8.5"	6"	4.25"	5"	3.7 cu. ft.
68" SIDE MOUNT	PADDLE	DZ8768	-	-			68"	12.75"	10"		8.5"	6"	4.25"	5"	5.1 cu. ft.
POLY TOOL BOXES			PART #				L	W	H	L1	H2	Vol.			
CROSSOVER															
MID SIZE CROSSOVER			DZ6163P				63"	14.75"	14.37"	54"	-	5.4 cu. ft.			
STANDARD CROSSOVER			DZ6170P				70.5"	14.75"	14.37"	60.5"	-	6.2 cu. ft.			
CHESTS															
SMALL CHEST			DZ6535P				35"	14"	13"	-	-	3.6 cu. ft.			
LARGE CHEST			DZ6537P				39"	27"	17"	-	-	10.35 cu. ft.			
SPECIALTY BOXES															
TRIANGLE TRAILER BOX			DZ9171P				36" (back)	18.75"	18"	18" (front)	-	6 cu. ft.			
WHEEL WELL BOX			DZ95P				37"	7.75"	19.5"	14"	8.5"	2.2 cu. ft.			

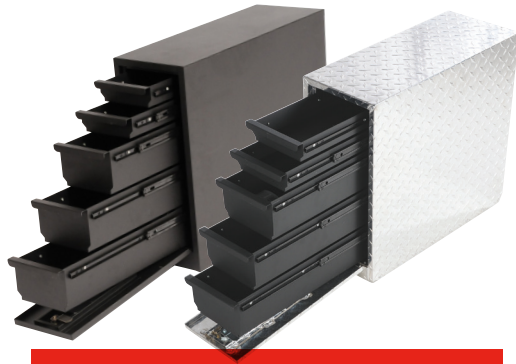

5 DRAWER WHEEL WELL BOX

DZ95D steel
DZ95DA aluminum outer shell

- 5 drawers with single door opening and cam lock
- Quick release mounting plate for easy removal
- Steel constructed drawers with guide rails for smooth operation



ALUMINUM WHEEL WELL BOX

DZ94(B) Driver side
DZ95(B) Passenger side

- Lockable storage behind wheel wells
- Lift-up lid with a sturdy piano hinge
- Fits full size trucks with 6' and 8' beds
- Available in Brite-Tread aluminum and gloss black



ATV TOOL BOXES

M206 Small 35" x 12" x 9"
M207 Large 35" x 12" x 12.5"

- Great for universal storage
- Gloss black powder coat finish
- ATV mounting hardware included



TOPSIDER TOOL BOXES

- Storage for the top rail of the truck bed
- Lockable stainless steel t-handle latch
- Drop down doors for easy access
- Safety chains to support the door
- Water resistant c-channel and bulb seal
- All mounting hardware included

Many sizes available!



Aluminum
Brite-Tread



Textured
White-Tread



Textured
Black-Tread



TRIANGLE TRAILER BOX

- 4 sizes available
- Brite-Tread aluminum construction
 - Lockable paddle handle
 - Gas shock to support the lid
 - Great for trailer tongue storage



NARROW TOOL BOXES

- DZ6163N(B)** Mid size
DZ6170N(B) Full size
- Narrow profile design fits great for today's short bed trucks
 - Lockable paddle handles, gas shocks, and foam gasket to keep the elements out



UNDERBED TOOL BOXES

- Brite-Tread aluminum and steel storage with mounting versatility
- Water-channel and bulb seal help keep out water
- T-handle creates a tight barrier when closed
- Take 4.5" from length & height to get opening dimensions
- Mounting brackets sold separately

Many sizes available!



Aluminum
Brite-Tread



Textured
Black-Tread



Black
Steel



UNDERBED MOUNTING BRACKETS

- DB-2502**
- Securely mount underbed boxes
 - Heavy duty welded steel construction
 - Sold in pairs
 - Required for installation
 - 18" H x 2" W x 18" H

WHEEL WELL TOOL BOXES											
STYLE	STEEL	POLY	BRITE-TREAD	GLOSS BLACK		L	W	H	L1	H2	Vol.
DRAWER WHEEL WELL											
BLACK POWDER COATED STEEL	DZ95D	-	-	-		20.5"	8.5"	18.875"	-	-	1.9 cu. ft.
BRITE-TREAD ALUMINUM BODY	-	-	DZ95DA	-		20.5"	8.5"	18.875"	-	-	1.9 cu. ft.
WHEEL WELL											
DRIVER SIDE (ALUMINUM)	-	-	DZ94	DZ94B		37"	7.75"	19.5"	14"	8.5"	2.2 cu. ft.
PASSENGER SIDE (ALUMINUM)	-	-	DZ95	DZ95B		37"	7.75"	19.5"	14"	8.5"	2.2 cu. ft.
REVERSIBLE POLY	-	DZ95P	-	-		37"	7.75"	19.5"	14"	8.5"	2.2 cu. ft.
SPECIALTY TOOL BOXES											
STYLE	BRITE-TREAD	GLOSS BLACK	TEXTURED BLACK		L	W	H	L1	H1	H2	Vol.
NARROW BOXES											
MID SIZE	DZ6163N	DZ6163NB	-		63"	14"	14.25"	53.5"	9.25"	5"	5 cu. ft.
FULL SIZE	DZ6170N	DZ6170NB	-		69.75"	12"	14.25"	60.75"	9.25"	5"	5.75 cu. ft.
ATV BOXES											
SMALL	-	M206	-		35"	12"	9"	-	-	-	2 cu. ft.
LARGE	-	M207	-		35"	12"	12.5"	-	-	-	3 cu. ft.
JEEP BOXES											
NARROW	-	-	DZ6534JNTB		35"	16"	12"	-	-	-	3.5 cu. ft.
WIDE	-	-	DZ6534JWTB		35"	30"	12"	-	-	-	7 cu. ft.
TRIANGLE TRAILER											
SMALL ALUMINUM	-	-	DZ92716		34" (back)	14.25"	18"	16" (front)	-	-	3.71 cu. ft.
LARGE ALUMINUM	-	-	DZ92717		34" (back)	19"	22.75"	20.75" (front)	-	-	7.24 cu. ft.
LOW PROFILE 1			DZ92716		40.75" (back)	16.75"	9.25"	16.5" (front)	-	-	2.65 cu. ft.
LOW PROFILE 2			DZ92717		32.8" (back)	24.5"	8.25"	20.8" (front)	-	-	3 cu. ft.
POLY	-	DZ91717P	-		37"		19.5"	10"	14"	8.5"	2.2 cu. ft.
TOPSIDER TOOL BOXES											
BRITE-TREAD	TEXTURED BLACK	TEXTURED WHITE		L	W	H	Vol.				
DZ70	DZ70TB	DZ70WH		48"	12"	16"	5.33 cu. ft.				
DZ59	DZ59TB	DZ59WH		60"	15.5"	20"	10.75 cu. ft.				
DZ79	DZ79TB	DZ79WH		72"	15.5"	20"	12.75 cu. ft.				
DZ71	DZ71TB	DZ71WH		90"	15.5"	20"	16 cu. ft.				
DZ67	DZ67TB	DZ67WH		96"	15.5"	20"	17.22 cu. ft.				
ALUMINUM UNDERBEDS						STEEL UNDERBEDS					
BRITE-TREAD	TEXTURED BLACK	L	W	H	Vol.	BLACK STEEL	L	W	H	Vol.	
DZ61	DZ61TB	24"	18"	18"	4.5 cu. ft.	DB-2600	24"	18"	18"	4.5 cu. ft.	
DZ74	DZ74TB	30"	20"	18"	5.94 cu. ft.	DB-2603	30"	18"	18"	5.63 cu. ft.	
DZ77	DZ77TB	36"	20"	18"	7 cu. ft.	DB-2601	36"	18"	18"	6.75 cu. ft.	
DZ75	DZ75TB	48"	20"	18"	9.5 cu. ft.	DB-2602	48"	18"	18"	9 cu. ft.	
DZ76	DZ76TB	60"	20"	18"	11.9 cu. ft.	DB-2604	60"	18"	18"	11.25 cu. ft.	



DZ7365017TB

TOOL BOX RAIL KIT

- Made from Dee Zee's 1.75" Hex Series extruded aluminum
- Tied together with rounded die cast aluminum corners
- Add secure anchor points on top of the lid with Hex Series Tie Downs (**sold separately**) (pg.24)
- All hardware included
- Texture black powder coat
- Fits full size tool boxes

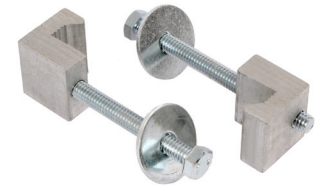

TOOL BOX MOUNTING KIT
DZ97904

- Premium Mounting Kit
- Replaces standard J-bolt
- *Not recommended for Ford Aluminum Beds**

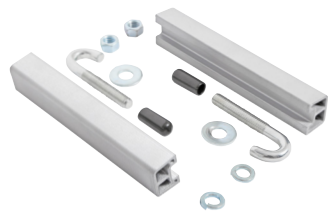

TOOL BOX MOUNTING KIT
DZ97910

- Ford Aluminum Bed Premium Mounting Kit
- Custom-designed for secure fit



GRIP TAPE
DZ46

- 2-11/16" x 12' black adhesive tape
- *Use it anywhere for a non-slip surface**



DZTBSHOCK1

10.5" 80 lb. Shock • ball & socket mount



DZTBSHOCK2

10" 70 lb. Shock • blade/eyelet mount



DZTBSHOCK3

10.5" 60 lb. Shock • ball & socket mount



DZTBSHOCK4

10.875" 40 lb. Shock • ball & socket mount

***Protective sleeve**

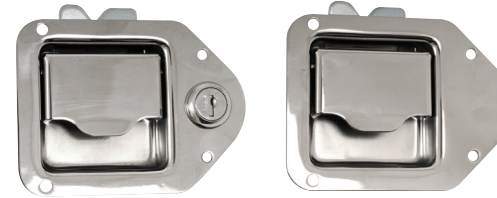

DZTBLATCH1(B) *stainless steel or black*
• Locking-hook style latch ***Lock and keys included**

DZTBLATCH2 *stainless steel*
• Non-locking • hook style latch

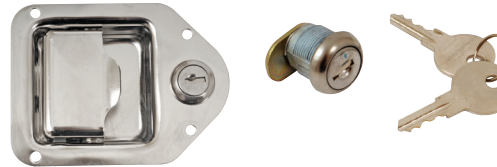

DZTBLATCH3 *stainless steel*
• Locking • post style latch ***Lock and keys included**

DZTBLOCK1
• Replacement lock cylinder with pair of keys



DZTBLATCH4 *stainless steel*
• Locking • pull-handle latch. ***Lock and keys included**

DZTBLATCH4B *black powder coat*
• Locking • pull-handle latch. ***Lock and keys included**

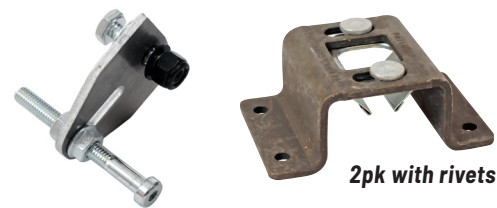

DZTBSTRIKER
• Striker/lid catch for post style latches (**right**)

DZTBSTRIKER2
• Striker/lid catch for hook style latches (**left**)



DZTBTRAY1 *Plastic tool box tray*

- Molded plastic construction
- 10lb. weight limit

DZTBMAT2

- Non-slip mat with no rust™ by Zerust® vapor shield
- 70" x 20"
- .042 thickness



TRANSFER TANKS

- Internal baffles controls flow of liquid and adds strength
- Mounting tabs secures tank to truck bed
- Radius curves design allows liquid to move freely around corners and eliminates pressure on weld points
- Drain plugs allow for draining the tank by gravity
- Lockable breathing cap reduces pressure & eliminates the vacuum when pumping

Available in: Rectangle, Square, Combo, or L-shaped

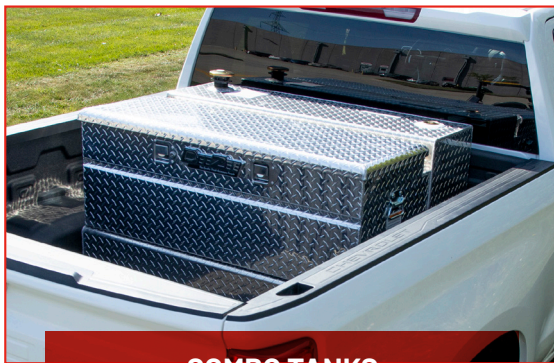

COMBO TANKS

- The convenience of a Utility Chest mounted to a Transfer Tank
- Red Label Utility Chest features lockable paddle handles, lid stiffener, and gas shocks (pg. 31)
- All standard tank features like lockable-Breathing Caps, Drain Plugs, Radius Curves...see above

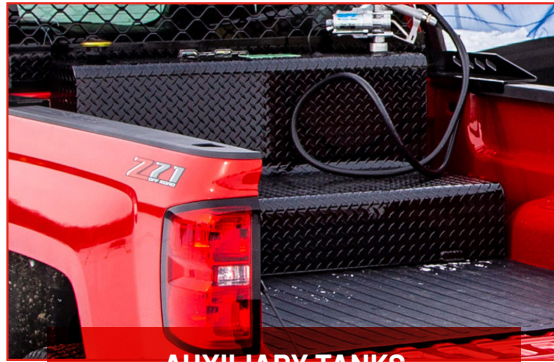

AUXILIARY TANKS

The same great tanks you rely on, now with the ability to feed directly into the fuel line of your diesel vehicle.

- All standard tank features like lockable-Breathing Caps, Drain Plugs, Radius Curves...see left
- Pressure tested to 29 PSI: Federal Regulation 178.814
- Full-size baffles add extra strength and controls motion

Available in: Rectangle, Square, Combo, or L-shaped



COMBO TANK WITH PUMP

- Convenient lockable Storage Bolted onto A Transfer Tank
- Transfer Tank Constructed of .125 Brite-Tread Aluminum
- Utility Chest Features .056 Brite-Tread Aluminum
- Radius Curve Eliminates Weld Pressure Points
- 2 Stability Baffles and Drain Plug
- Comes with a 15 GPM to be mounted inside of the toolbox



DZGASCAP 1

- Vented cap and neck for transfer tanks
- Use padlock for extra security **not included**

DZGASCAP 2

- Replacement vented cap only
- Use padlock for extra security **not included**
- *Does not include threaded neck

DZGASCAP 3

- Built-in lock, vented cap, and neck for transfer tanks
- *Lock & keys included



CONNECTOR KITS

- Feed diesel directly into your fuel line
- All hoses and hardware included; some cutting required to OEM fuel hose
- Not designed for continuous flow. Valve must be closed during vehicle operation

Sold Separately

#DZ97960	2011+ Chevrolet/GMC	#DZ97961	99-10 Chevrolet/GMC
	99-12 Dodge		
	1999+ Ford	#DZ97962	2013+ Dodge
	2016+ Nissan Titan XD		

48" BASE

DZ8546(B)(S)(SB) + DZ92747(B)(S)(SB)



OR

56" BASE

DZ8556F(B)(S)(SB) + DZ92756(B)(S)(SB)

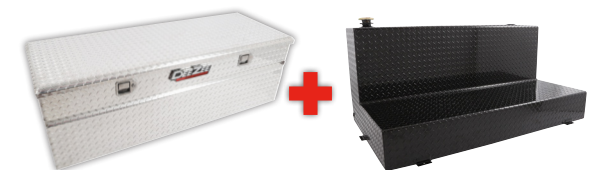

BUILD YOUR OWN COMBO

Mix and match colors and finishes of Red Label Utility Chests (pg. 31) and L-shaped tanks to create your own custom combo tank using **DZBKTCOMBO**



TRANSFER TANKS													
STYLE	BRITE-TREAD ALUMINUM	BLACK-TREAD ALUMINUM	WHITE STEEL	BLACK STEEL		L	W	H	W1	H1	W2	H2	Vol.
RECTANGLE + SQUARE													
WEDGE	DZ92556	DZ92556B	-	-		56"	20"	20"	8.3"	8.3"	-	-	76.2 gal.
SQUARE	DZ91750	-	DZ91750S	DZ91750SB		24"	24"	24"	-	-	-	-	55 gal.
NARROW RECTANGLE	DZ92556N	DZ92556NB	DZ92556NS	DZ92556NSB		56"	9.625"	19"	-	-	-	-	40 gal.
HIGH CAPACITY RECTANGLE	DZ91753	-	DZ91753S	DZ91753SB		48"	24"	24"	-	-	-	-	108 gal.
L-SHAPED													
29" BASE	-	-	DZ91754S	DZ91754SB		29"	31"	24"	10"	8"	21"	16"	55 gal.
48" BASE	DZ92747	DZ92747B	DZ92747S	DZ92747SB		46.75"	32.75"	25.5"	13"	7.75"	19.75"	17.75"	92 gal.
56" BASE	DZ92756	DZ92756B	DZ92756S	DZ92756SB		56"	32.75"	25.5"	13"	7.75"	19.75"	17.75"	111 gal.
COMBO TANK + TOOL CHEST													
48" BASE HIGH CAPACITY	DZ92647	DZ92647B	-	DZ927647SB		46.75"	32.75"	25.5"	13"	7.75"	19"	16"	92 gal.
48" COMBO WITH PUMP	DZ92847	DZ92847TB	-	-		46.75"	30"	24"	-	11"	-	13"	62 gal.
54" BASE	-	-	DZ91740S	DZ91740SB		54"	18"	20"	9"	6.5"	11.5"	12.5"	50 gal.
54" BASE LOW PROFILE	DZ92740	DZ92740B	-	-		54"	18"	16"	9"	6.5"	11.5"	7"	43 gal.
56" BASE HIGH CAPACITY	DZ92656	DZ92656B	-	DZ92656SB		56.25"	32.75"	25.5"	13"	7.75"	19"	16"	111 gal.
56" COMBO WITH PUMP	DZ92856	DZ92856TB	-	-		56.25"	30"	24"	-	11"	-	13"	75 gal.
AUXILIARY TRANSFER TANK													
STYLE	BRITE-TREAD ALUMINUM	BLACK-TREAD ALUMINUM	WHITE STEEL	BLACK STEEL		L	W	H	W1	H1	W2	H2	Vol.
RECTANGLE													
LONG RECTANGLE	DZ91752X	-	-	-		60"	9"	19"	-	-	-	-	40 gal.
HIGH CAPACITY RECTANGLE	DZ91753X	-	-	DZ91753XSB		48"	24"	24"	-	-	-	-	108 gal.
L-SHAPED													
48" BASE	DZ91767X	DZ91767XB	-	-		48"	29"	24"	9"	9"	21"	15"	80 gal.
56" BASE	-	-	-	-		56"	29"	24"	9"	9"	21"	15"	92 gal.
COMBO TANK + TOOL CHEST													
48" BASE	DZ91741X	DZ91741XB	-	-		48"	29"	24"	9"	9"	20"	15"	80 gal.
54" BASE LOW-PROFILE	DZ92740X	DZ92740XB	-	-		54"	18"	16"	6.5"	9"	11.5"	7"	43 gal.
56" BASE	-	DZ91742XB	-	-		56"	29"	24"	9"	9"	20"	15"	92 gal.