

# Hard Drive

AMERICAN V-TWIN PRODUCTS

Contents

- Windshields / Fairings ..... 2
- Audio / Communication ..... 32
- Seats / Luggage ..... 82
- Bars / Mirrors / Controls ..... 149
- Exhaust ..... 254
- Air / Fuel Systems ..... 305
- Engine ..... 354
- Transmission / Driveline ..... 405
- Gaskets/Seals ..... 452
- Electrical ..... 498
- Lighting ..... 583
- Cables ..... 637
- Brakes ..... 661
- Oil Filters ..... 690
- Suspension ..... 695
- Body ..... 722
- Wheels ..... 780
- Tires/Tire Accessories ..... 796
- Bike Accessories ..... 820
- Victory / Indian ..... 857
- Covers / Locks / Tiedowns ..... 888
- Chemicals & Lubes ..... 918
- Tools ..... 990
- Helmets ..... 1084
- Helmet Accessories ..... 1128
- Eyewear ..... 1150
- Apparel / Rider Accessories ..... 1184
- Promotional ..... 1291
- Reference ..... 1310



- WINDSHIELDS / FAIRINGS
- AUDIO / COMMUNICATION
- SEATS / LUGGAGE
- BAR / MIRRORS / CONTROLS
- EXHAUST
- AIR / FUEL SYSTEMS
- ENGINE
- TRANSMISSION / DRIVELINE
- GASKETS / SEALS
- ELECTRICAL
- LIGHTING
- CABLES
- BRAKES
- OIL FILTERS
- SUSPENSION
- BODY
- WHEELS
- TIRES / TIRE ACC.
- BIKE ACC.
- VICTORY / INDIAN
- COVERS / LOCKS / TIEDOWNS
- CHEMICALS
- TOOLS
- HELMETS
- HELMET ACC.
- EYEWEAR
- APPAREL / RIDER ACC.
- PROMOTIONAL
- REFERENCE
- INDEX

- WINDSHIELDS / FAIRINGS
- AUDIO / COMMUNICATION
- SEATS / LUGGAGE
- BARS / MIRRORS / CONTROLS
- EXHAUST
- AIR / FUEL SYSTEMS
- ENGINE
- TRANSMISSION / DRIVELINE
- GASKETS / SEALS
- ELECTRICAL
- LIGHTING
- CABLES
- BRAKES
- OIL FILTERS
- SUSPENSION
- BODY
- WHEELS
- TIRES / TIRE ACC.
- BIKE ACC.
- VICTORY / INDIAN
- COVERS / LOCKS / TIEDOWNS
- CHEMICALS
- TOOLS
- HELMETS
- HELMET ACC.
- EYEWEAR
- APPAREL / RIDER ACC.
- PROMOTIONAL
- REFERENCE
- INDEX



## VSTREAM® WINDSCREENS FOR FLHT/FLHX MODELS

The Tall and Standard size VStream® Windscreens for the FLHT/FLHX are outstanding high-speed highway performers for average size and taller riders. Shorter riders will like the performance of the VStream Low and Ultra Low models.

Enjoy a significant improvement in wind management and riding comfort.

Mounts with existing OEM hardware.

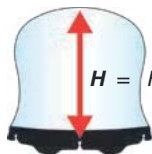

H = Height

VStream Windscreens are measured from bottom center mount hole to top of screen.

## VSTREAM® WINDSCREENS FOR FLTR ROAD GLIDE MODELS

Owners of FLTR Road Glides will appreciate the enhanced performance and stunning appearance of the VStream® Windscreens. Choose from Extra Tall and Standard Touring Size in Clear, Mid-Size in Light Tint, and in a Low Size in Light Tint or Dark Tint.

All FLTR VStream Windscreens include metal compression limiters that spread the load for long life and durability.



Dark Tint

Light Tint

Clear

# VSTREAM® WINDSCREENS

QUIET • COMFORT • OPTICS • STRENGTH



The VStream® gets its name from the unique shape and dimensional contours designed and engineered into the windscreen. The patented "V" profile helps push the turbulent wind out and away from the side of the rider's head, producing a quieter and more comfortable riding experience. This improvement also reduces wind noise and buffeting for the passenger.

- Constructed from thick, durable hardcoated Lexan® polycarbonate material
- Coated with National Cycle's exclusive scratch-resistant Quantum™ hardcoating
- Replaces the stock windscreen and uses the OEM mounting hardware
- All VStream Windscreens are made in the U.S.A. and are covered by National Cycle's exclusive 3-Year Warranty against breakage



Quantum™ is an exclusive product of National Cycle Inc.

All VStream Windscreens are covered by National Cycle's 3-Year Warranty against breakage.

## WHAT ARE THE BENEFITS OF LEXAN® POLYCARBONATE?

Outstanding impact strength! No other thermoplastic comes close to matching the impact strength of polycarbonate, making it the ideal material for motorcycle windshields. It is 20X more impact resistant than acrylic plastic (Lucite®).

So whether it's birds, bugs, rocks or road debris, for the serious rider, a strong polycarbonate windshield is very important.

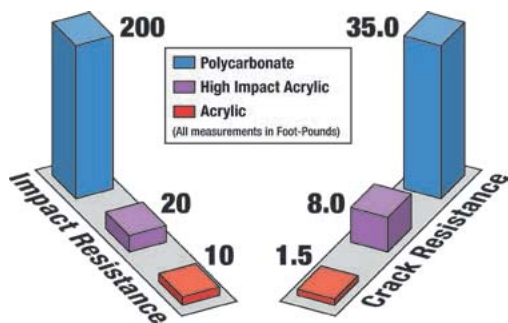

## QUALITY MANUFACTURING

National Cycle engineers and manufactures the plastic and the mount systems of all their windshields. Replacement parts are readily available for years to come.

## REAL WORLD PERFORMANCE

Watch National Cycle's "Polycarbonate vs. Acrylic" video on YouTube™ to see the entire gamut of impact tests.

VStream Windscreens are offered in Clear, Light Tint, and Dark Tint hardcoated polycarbonate. See application charts for details.



VStream Windscreens are measured from bottom center mount hole to top of screen.

Application	Year	Height	Clear	Height	Dark Tint	Height	Light Tint
<b>HARLEY-DAVIDSON</b>							
FLHT/FLHX/FLHTK Touring models (all)	'14-18	14.5"	<b>562-5091C</b>	7.25"	<b>562-5094D</b>	7.25"	<b>562-5094S</b>
		11.5"	<b>562-5092C</b>			9.5"	<b>562-5093S</b>
FLHT/FLHX/FLHTK Touring models (all)	'96-13	17.00"	<b>562-5080C</b>	10.75"	<b>562-5082D</b>	10.75"	<b>562-5082S</b>
		14.00"	<b>562-5081C</b>	7.25"	<b>562-5083D</b>		
FLHTCUTG Triglide	'14-18	14.5"	<b>562-5091C</b>	7.25"	<b>562-5094D</b>	7.25"	<b>562-5094S</b>
		11.5"	<b>562-5092C</b>			9.5"	<b>562-5093S</b>
FLHTCUTG/FLHXXX Tri-Glide/Street Glide Trike	'09-13	17.00"	<b>562-5080C</b>	10.75"	<b>562-5082D</b>	10.75"	<b>562-5082S</b>
		14.00"	<b>562-5081C</b>	7.25"	<b>562-5083D</b>		
FLTR/X/U Road Glide Ultra	'98-13	18.00"	<b>562-5084C</b>	9.25"	<b>562-5086D</b>	9.25"	<b>562-5086S</b>
		15.25"	<b>562-5085C</b>			12.00"	<b>562-5087S</b>
		16.00"	<b>562-5088C</b>	9.00"	<b>562-5088D</b>	12.50"	<b>562-5088S</b>

WINDSHIELDS / FAIRINGS



WAVE® WINDSCREENS FOR FLHT/FLHX/FLTR RIDERS

AUDIO / COMMUNICATION  
SEATS / LUGGAGE  
BARS / MIRRORS / CONTROLS  
EXHAUST  
AIR / FUEL SYSTEMS  
ENGINE  
TRANSMISSION / DRIVELINE  
GASKETS / SEALS  
ELECTRICAL  
LIGHTING  
CABLES  
BRAKES  
OIL FILTERS  
SUSPENSION  
BODY  
WHEELS  
TIRES / TIRE ACC.  
BIKE ACC.  
VICTORY / INDIAN  
COVERS / LOCKS / TIEDOWNS  
CHEMICALS  
TOOLS  
HELMETS  
HELMET ACC.  
EYEWEAR  
APPAREL / RIDER ACC.  
PROMOTIONAL  
REFERENCE  
INDEX



National Cycle's Wave® Windscreens are now available for late-model FLHT, FLHX and FLTR motorcycles.

Quality is evident when you feel the thick gauge, precision cut, smooth radiused edge on these windscreens. Quantum™ hardcoated polycarbonate delivers outstanding strength and unbeatable scratch resistance.

It's stylish... sleek... and sexy.

It's the new Wave. Ride it!



**FLTR Wave Windscreens**

- 10.50" (26.7cm)
- 8.25" (21.0cm)
- 6.25" (15.9cm)

**FLHT/FLHX Wave Windscreens**

- 10.00" (25.4cm)
- 7.75" (19.7cm)
- 5.25" (13.3cm)

Wave Windscreens are measured from the top of the fairing in a vertical line level to the top of the screen. Three different sizes means there's a perfect Wave Windscreen for any rider.



All FLTR Wave Windscreens include metal compression limiters that spread the load for long life and durability.



Description	Year	Height	Clear	Height	Dark Tint	Height	Light Tint
<b>HARLEY-DAVIDSON</b>							
FLHT/FLHX/FLHTK Touring models (all)	'96-13	10.00"	<b>562-20160</b>	5.25"	<b>562-20162</b>	7.75"	<b>562-20161</b>
FLHTCUTG/FLHXXX Tri-Glide/Street Glide Trike	'09-13	10.00"	<b>562-20160</b>	5.25"	<b>562-20162</b>	7.75"	<b>562-20161</b>
FLTR/X/U Road Glide Ultra	'98-13	10.50"	<b>562-20163</b>	6.25"	<b>562-20165</b>	8.25"	<b>562-20164</b>



## WAVE QR™ QUICK RELEASE FAIRINGS

- Have the hottest bike around with National Cycle's new Wave QR™ – the fairing that defines performance on the edge. Whether it's slammed back or raked up, Wave QR's sculpted polycarbonate body captures the spirit of your Harley- Davidson® motorcycle.
- Its jetstreamed looks come from National Cycle's attention to aerodynamics and precision forming. It's removable in just seconds, without tools –thanks to National Cycle's Quick Release Mount Kit! And, it's rake adjustable!
- The highly regarded Quick Release Mount Kit is the same that's used for the SwitchBlade® and Spartan® Windshields, so you not only have a choice between riding with or without a shield – you also have a choice between completely different styles of quick release shields!
- Made from durable FMR hardcoated polycarbonate and covered by National Cycle's 3-Year Warranty against breakage.

See pages 10-12 for Applications.  
Mount Kits sold separately



### 562-20115

Height: 13.00" (33.0cm)  
Width: 16.00" (40.6cm)

25% Tint

### 562-20116

Height: 10.50" (26.7cm)  
Width: 17.00" (43.2cm)

95% Tint

### 562-20117

Height: 12.50" (31.8cm)  
Width: 18.25" (46.3cm)

95% Tint

### 562-20118

Height: 10.50" (26.7cm)  
Width: 18.00" (45.7cm)

95% Tint

## WAVE QR™ FAIRING DIMENSIONS

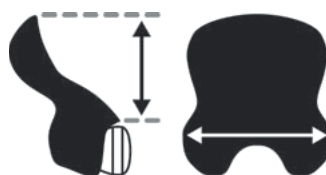

Wave QR™ Fairings are measured from the headlight cutout in a vertical line level to the top of the shield in the fully raked forward position. Width is measured in a straight line across the back of the shield at the widest point.

## WAVE QR™ FAIRING

Description	WPS#
WAVE QR™ for XL models	562-20115
WAVE QR™ for FXD models	562-20116
WAVE QR™ for FLSTF models	562-20117
WAVE QR™ for FLHR models	562-20118

- WINDSHIELDS / FAIRINGS
- AUDIO / COMMUNICATION
- SEATS / LUGGAGE
- BARS / MIRRORS / CONTROLS
- EXHAUST
- AIR / FUEL SYSTEMS
- ENGINE
- TRANSMISSION / DRIVELINE
- GASKETS / SEALS
- ELECTRICAL
- LIGHTING
- CABLES
- BRAKES
- OIL FILTERS
- SUSPENSION
- BODY
- WHEELS
- TIRES / TIRE ACC.
- BIKE ACC.
- VICTORY / INDIAN
- COVERS / LOCKS / TIEDOWNS
- CHEMICALS
- TOOLS
- HELMETS
- HELMET ACC.
- EYEWEAR
- APPAREL / RIDER ACC.
- PROMOTIONAL
- REFERENCE
- INDEX

- WINDSHIELDS / FAIRINGS
- AUDIO / COMMUNICATION
- SEATS / LUGGAGE
- BAR / MIRRORS / CONTROLS
- EXHAUST
- AIR / FUEL SYSTEMS
- ENGINE
- TRANSMISSION / DRIVELINE
- GASKETS / SEALS
- ELECTRICAL
- LIGHTING
- CABLES
- BRAKES
- OIL FILTERS
- SUSPENSION
- BODY
- WHEELS
- TIRES / TIRE ACC.
- BIKE ACC.
- VICTORY / INDIAN
- COVERS / LOCKS / TIEDOWNS
- CHEMICALS
- TOOLS
- HELMETS
- HELMET ACC.
- EYEWEAR
- APPAREL / RIDER ACC.
- PROMOTIONAL
- REFERENCE
- INDEX



**Straight Forks**



**Covered Forks**

## TWO PREMIUM QUICK RELEASE WINDSHIELD LINES



**Polished Stainless Steel**



**Black Powdercoated Stainless Steel**

### THE BEST HARDWARE

- Chromed steel with polished or black powdercoated stainless steel hardware is used throughout for rock-solid strength, dependability and great looks
- Cushion wheels turn and flex, allowing your SwitchBlade or Spartan to securely lock into place
- Sleek and elegant – no exposed fasteners

### EXCLUSIVE QUANTUM™ HARDCOAT

Developed for windshield use by National Cycle, Quantum hardcoat takes motorcycle windshields a "quantum leap" forward in abrasion resistance and outdoor life. National Cycle applies this crystal clear hard coating to polycarbonate material. The combined result is the strongest, most scratch resistant windshield material available worldwide.



### SUPERIOR SCRATCH RESISTANCE



30X more scratch resistance than typical acrylic windshields is saying a lot! Think of it as 30X more miles per windshield. Even compared to FMR coated polycarbonate, Quantum™ has 10X better scratch resistance.

Award-Winning Quantum hardcoating is used in many tough applications. It has withstood over one million windshield wipes in tests for the fully enclosed Benelli Adiva Scooter.

[See pages 10-12 for Applications](#)



### 3-YEAR WARRANTY

Every National Cycle polycarbonate windshield, including the SwitchBlade and Spartan lines, is covered by an unprecedented 3-Year Warranty against breakage!

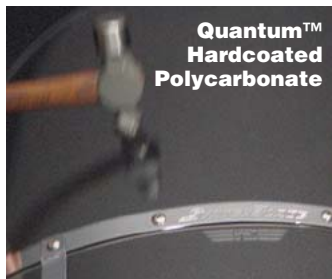

**Quantum™ Hardcoated Polycarbonate**



**Acrylic**

### POLYCARBONATE STRENGTH

SwitchBlade and Spartan Windshields are made from durable 4.0mm thick polycarbonate for 20X more impact resistance than acrylic. This is tough material that you can trust!

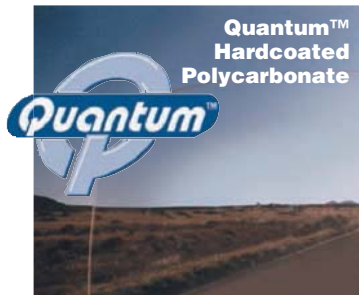

**Quantum™ Hardcoated Polycarbonate**



### GLARE-FREE OPTICS

Think about riding into the sun or at oncoming headlights and not having to look through the glare of fine scratches that eventually show up on your screens. Quantum™ hardcoating gives your windshield much better optical definition and clarity, and your windshield will stay that way a lot longer.

**SWITCHBLADE®**

**national cycle**  
 Made in U.S.A.

WINDSHIELDS / FAIRINGS

AUDIO / COMMUNICATION

SEATS / LUGGAGE

BARS / MIRRORS / CONTROLS

EXHAUST

AIR / FUEL SYSTEMS

ENGINE

TRANSMISSION / DRIVELINE

GASKETS / SEALS

ELECTRICAL

LIGHTING

CABLES

BRAKES

OIL FILTERS

SUSPENSION

BODY

WHEELS

TIRES / TIRE ACC.

BIKE ACC.

VICTORY / INDIAN

COVERS / LOCKS / TIEDOWNS

CHEMICALS

TOOLS

HELMETS

HELMET ACC.

EYEWEAR

APPAREL / RIDER ACC.

PROMOTIONAL

REFERENCE

INDEX

**Quick Release Windshields with Quantum™ Performance!**



**2-Up®**



**Chopped™**



**Shorty®**



**Deflector™**



**ON AND OFF IN LESS THAN FIVE SECONDS... WITHOUT TOOLS!**

- The SwitchBlade® Quick Release Mount System gives you the flexibility to mount any of four sizes of SwitchBlade Windshields... or none at all!
- SwitchBlade Mount Kits (sold separately) are engineered directly on each model bike to ensure perfect fit and function



**SWITCHBLADE® 2-UP®**

- Largest size with maximum wind protection
- Ideal for touring, two-up riding, and cold season commuting
- Add SwitchBlade Chrome Lowers and National Cycle Hand Deflectors for complete wind and weather protection



**SWITCHBLADE® CHOPPED™**

- A cut-down version of the popular 2-Up
- Recontoured top is 4-5" shorter (depending on model) and the trimmed bottom profile is narrower
- Excellent protection for shorter riders/low saddle heights



All SwitchBlade and Spartan Windshields are covered by National Cycle's 3-Year Warranty against breakage.!

[See pages 10-12 for Applications](#)  
[Mount Kits sold separately](#)

WINDSHIELDS / FAIRINGS

AUDIO / COMMUNICATION

SEATS / LUGGAGE

BAR / MIRRORS / CONTROLS

EXHAUST

AIR / FUEL SYSTEMS

ENGINE

TRANSMISSION / DRIVELINE

GASKETS / SEALS

ELECTRICAL

LIGHTING

CABLES

BRAKES

OIL FILTERS

SUSPENSION

BODY

WHEELS

TIRES / TIRE ACC.

BIKE ACC.

VICTORY / INDIAN

COVERS / LOCKS / TIEDOWNS

CHEMICALS

TOOLS

HELMETS

HELMET ACC.

EYEWEAR

APPAREL / RIDER ACC.

PROMOTIONAL

REFERENCE

INDEX



# SWITCHBLADE®



## SWITCHBLADE® SHORTY®

- An ideal choice for shorter riders or for morning commutes
- Short in size but long on looks and quality features
- Keeps wind blast at bay while preserving the "wind in your face" motorcycling experience
- [See pages 10-12 for Applications](#)



## SWITCHBLADE® DEFLECTOR™

- Minimal profile with maximum attitude
- Patented Rake Adjust™ feature lets you easily change the screen angle for appearance or for wind protection
- Perfect shield for warmer weather and boulevard cruising
- High quality chromed steel and stainless steel hardware
- [See pages 10-12 for Applications](#)

## CHROME LOWER DEFLECTORS FOR SWITCHBLADE WINDSHIELDS

- Chrome Lower Deflectors improve the performance of your windshield by preventing unwanted turbulence below the shield
- National Cycle's Chrome Lower Deflectors are engineered for proper fit, clearance and performance
- Mounts to SwitchBlade® Windshield Mount Kits ([See pages 10-12 for Applications](#))
- Superb polishing and chrome plating make National Cycle Chrome Lower Deflectors stand out from the rest





# SPARTAN® national cycle® Made in U.S.A.

562-20104

Shown with 562-21220  
SwitchBlade®  
Holdster™



## SPARTAN® QUICK RELEASE WINDSHIELDS

- The new Spartan® Windshield has a stainless steel frame finished in a stealthy black powdercoat and looks perfect on today's dark custom bikes. You won't find a better quality touring-sized windshield at such a great price!
- This full-size Quantum™ hardcoated polycarbonate windshield comes in two heights – 18.50" and 16.25" – to fit almost any rider
- Mounts to National Cycle's tried-and-true Quick Release Mount Kits with stainless steel hardware and rubber grommet compression limiters that spread the load for long life and durability

Clear



[See pages 10-12 for Applications](#)  
[Mount Kits sold separately](#)

562-20101



562-20105



Simplified fitments are made possible by Spartan's unique, patented parallel slotted tabs that adjust for a perfect, customized fit with different fork widths.

## SPARTAN® WINDSHIELD DIMENSIONS

**N21 200/N21 201/N21 202**  
Cutout to Top: 18.50" (47.0cm)  
Width: 18.00" (45.7cm)

**N21 300/N21 301/N21 302**  
Cutout to Top: 16.25" (41.3cm)  
Width: 18.00" (45.7cm)

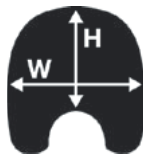

Height is measured from headlight cutout to top of shield. Width is measured in a straight line across the back at the widest point.

## SPARTAN® WINDSHIELD

Description	WPS#
18.5" HT Clear for FLSTC models	<b>562-20100</b>
18.5" HT Clear for FXDC models	<b>562-20101</b>
18.5" HT Clear for XL models	<b>562-20102</b>
17" HT Clear for FLSTC models	<b>562-20103</b>
17" HT Clear for FXDC models	<b>562-20104</b>
17" HT Clear for XL models	<b>562-20105</b>



National Cycle Chrome Lower Deflectors attach to the Quick Release Mount Kits and work great with the new Spartan Windshields!  
[See pages 10-12 for Applications](#)

WINDSHIELDS / FAIRINGS

AUDIO / COMMUNICATION

SEATS / LUGGAGE

BARS / MIRRORS / CONTROLS

EXHAUST

AIR / FUEL SYSTEMS

ENGINE

TRANSMISSION / DRIVELINE

GASKETS / SEALS

ELECTRICAL

LIGHTING

CABLES

BRAKES

OIL FILTERS

SUSPENSION

BODY

WHEELS

TIRES / TIRE ACC.

BIKE ACC.

VICTORY / INDIAN

COVERS / LOCKS / TIEDOWNS

CHEMICALS

TOOLS

HELMETS

HELMET ACC.

EYEWEAR

APPAREL / RIDER ACC.

PROMOTIONAL

REFERENCE

INDEX



# SWITCHBLADE® WINDSHIELD DIMENSIONS

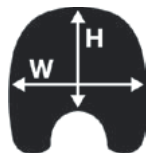

Height is measured from headlight cutout to top of the shield. Width is measured in a straight line across the back of the shield at the widest point.

WPS#	Cutout to top	Overall Height	Width	WPS#	Cutout to top	Overall Height	Width	WPS#	Cutout to top	Overall Height	Width
<b>2-UP SHIELDS</b>				<b>CHOPPED (CONT'D...)</b>				<b>SHORTY (CONT'D...)</b>			
562-2280C	18.50"	26.50"	23.00"	562-2382C	14.90"	21.10"	22.20"	562-2483C	11.30"	18.80"	18.20"
562-2281C	19.50"	26.40"	23.00"	562-2382S	14.90"	21.10"	22.20"	562-2483S	11.30"	18.80"	18.20"
562-2282C	20.00"	26.50"	23.00"	562-2383C	15.60"	21.10"	22.20"	562-2484C	11.80"	18.80"	18.20"
562-2283C	18.50"	26.50"	23.00"	562-2383S	15.60"	21.10"	22.20"	562-2484S	11.80"	18.80"	18.20"
562-2284C	19.00"	26.00"	22.60"	562-2384C	16.00"	23.20"	22.40"	<b>DEFLECTOR</b>			
562-2285C	20.25"	26.25"	23.00"	562-2384S	16.00"	23.20"	22.40"	562-2580C	12.00"	14.50"	13.50"
<b>CHOPPED</b>				562-2385C	15.25"	21.00"	23.00"	562-2580S	12.00"	14.50"	13.50"
562-2380C	13.60"	21.10"	22.20"	562-2385S	15.25"	21.00"	23.00"	562-2581C	12.00"	14.50"	13.50"
562-2380S	13.60"	21.10"	22.20"	<b>SHORTY</b>				562-2581S	12.00"	14.50"	13.50"
562-2381C	13.50"	21.40"	22.20"	562-2481C	11.50"	19.00"	18.50"	562-2582C	12.00"	14.50"	13.50"
562-2381S	13.50"	21.40"	22.20"	562-2481S	11.50"	19.00"	18.50"	562-2582S	12.00"	14.50"	13.50"
				562-2482S	11.25"	18.80"	18.60"				



SwitchBlade® Shorty®



SwitchBlade® 2-Up®

## SWITCHBLADE® 2-UP/CHOPPED/SHORTY APPLICATIONS

Application	Year	Mount Kit	2-UP Clear	Chopped Clear	Chopped Tint	Shorty Clear	Shorty Tint
<b>HARLEY-DAVIDSON</b>							
<b>TOURING</b>							
All Road King models	'94-17	562-21185	562-2285C	562-2385C	562-2385S		
<b>SOFTAIL</b>							
All FL Softail models w/o light bar (except listed below)	'87-17	562-21183	562-2282C	562-2382C	562-2382S		
All FL Softails models w/ light bar	'86-17	562-21184	562-2282C	562-2382C	562-2382S		
FLST Heritage Softail	'86-90	562-21185	562-2285C	562-2385C	562-2385S		
All FX Softail models (except listed below)	'84-12	562-21181	562-2281C	562-2381C	562-2381S		562-2482S
FXSTC Softail Custom	'07-10	562-21183	562-2282C	562-2382C	562-2382S		
FXS Blackline	'11-12	562-21182	562-2283C	562-2383C	562-2383S		562-2483S
<b>DYNA AND FXR</b>							
All models (except listed below and FXDF)	'06-17	562-21182	562-2283C	562-2383C	562-2383S	562-2483C	562-2483S
FXDWG Dyna Wide Glide	'10-17	562-21181	562-2281C	562-2381C	562-2381S		562-2482S
FXDWG Dyna Wide Glide	'06-08	562-21182	562-2284C	562-2384C	562-2384S	562-2484C	562-2484S
FXDL Low Rider	'06-09	562-21182	562-2284C	562-2384C	562-2384S	562-2484C	562-2484S
All models (except listed below)	'88-05	562-21180	562-2280C	562-2380C	562-2380S	562-2481C	562-2481S
FXDS Convertible Dyna Low Rider	'94-00	562-21182	562-2283C	562-2383C	562-2383S	562-2483C	562-2483S
FXDWG Dyna Wide Glide	'93-05	562-21181	562-2281C	562-2381C	562-2381S		562-2482S
FXWG Wide Glide	'80-85	562-21181	562-2281C	562-2381C	562-2381S		562-2482S
FXDG Disc Glide	'83	562-21181	562-2281C	562-2381C	562-2381S		562-2482S
<b>SPORTSTER</b>							
All models (except listed below and XL1200X, XL1200CX)	'88-17	562-21180	562-2280C	562-2380C	562-2380S	562-2481C	562-2481S
XL1200C	'11-17	562-21180					
XL1200T Super Low	'14-17	562-21180					
XL883L Super Low	'11-17	562-21180					



SwitchBlade® Deflector™



Spartan® Quick Release Windshields



Wave QR™ Quick Release Fairings

## DEFLECTOR, SPARTAN® AND WAVE QR™ APPLICATIONS

Application	Year	Mount Kit	Deflector Clear	Deflector Tint	Spartan 18.5"	Spartan 16.25"	WaveQR	Chrome Lower
<b>HARLEY DAVIDSON</b>								
<b>TOURING</b>								
All Road King models	'94-17	562-21185					562-20118	
<b>SOFTAIL</b>								
All FL Softail models w/o light bar (except listed below)	'87-17	562-21183	562-2582C	562-2582S	562-20100	562-20103	562-20117	562-21281
All FL Softail models w/ light bar (except listed below)	'87-17	562-21184	562-2582C	562-2582S	562-20100	562-20103		562-21281
FLST Heritage Softail	'86-90	562-21185			562-20100	562-20103		
FX Softail models (except listed below)	'84-12	562-21181	562-2581C	562-2581S	562-20101	562-20104		562-21280
FXSTC Softail Custom	'07-10	562-21183	562-2582C	562-2582S	562-20101	562-20104		562-21281
FXS Blackline	'11-13	562-21182			562-20101	562-20104		
<b>DYNA AND FXR</b>								
All models (except listed below and FXDF)	'06-17	562-21182			562-20101	562-20104		562-21280
FXDWG Dyna Wide Glide	'10-17	562-21181		562-2581S	562-20101	562-20104		562-21280
FXDWG Dyna Wide Glide	'06-08	562-21182			562-20101	562-20104	562-20116	562-21280
FXDL Low Rider	'06-09	562-21182			562-20101	562-20104	562-20116	562-21280
All models (except listed below)	'88-05	562-21180	562-2580C	562-2580S	562-20102	562-20105		562-21280
FXDWG Dyna Wide Glide	'93-05	562-21181	562-2581C	562-2581S	562-20101	562-20104		562-21280
FXDS Convertible Dyna Low Rider	'94-00	562-21182			562-20102	562-20105		562-21280
FXWG Wide Glide	'80-85	562-21181	562-2581C	562-2581S	562-20101	562-20104		562-21280
FXDG Disc Glide	'83	562-21181	562-2581C		562-20101	562-20104		
<b>SPORTSTER</b>								
All models (except listed below and XL1200X, XL1200CX)	'88-17	562-21180	562-2580C	562-2580S	562-20102	562-20105	562-20115	562-21280
XL1200C Sportster Custom	'11-17	562-21180			562-20102	562-20105		
XL883L/XL1200T Sportster Super Low	'11-17	562-21180			562-20102	562-20105		562-21280



- WINDSHIELDS / FAIRINGS
- AUDIO / COMMUNICATION
- SEATS / LUGGAGE
- BARS / MIRRORS / CONTROLS
- EXHAUST
- AIR / FUEL SYSTEMS
- ENGINE
- TRANSMISSION / DRIVELINE
- GASKETS / SEALS
- ELECTRICAL
- LIGHTING
- CABLES
- BRAKES
- OIL FILTERS
- SUSPENSION
- BODY
- WHEELS
- TIRES / TIRE ACC.
- BIKE ACC.
- VICTORY / INDIAN
- COVERS / LOCKS / TIEDOWNS
- CHEMICALS
- TOOLS
- HELMETS
- HELMET ACC.
- EYEWEAR
- APPAREL / RIDER ACC.
- PROMOTIONAL
- REFERENCE
- INDEX



## SELECTING THE CORRECT WINDSHIELD & MOUNT KIT FOR YOUR BIKE

1. Determine your motorcycle's make, model and year.
2. Choose the appropriate SwitchBlade Mount Kit
3. Determine what style windshield best fits you.
  - Consider your height and saddle position.
  - Determine your riding habits: Daily commutes? Long trips? Weekend rides?
  - Do you want maximum protection? A sporty look? Or a combination?



4. Sit on your bike, measure from a few inches above the headlight to the point horizontally level with the tip of your nose.
5. Pick the appropriate size SwitchBlade, Spartan or Stinger windshield.

Still can't decide? Get two or more windshields. With the Quick Release SwitchBlade Mount Kit, you can change your windshield as quickly as you change your mind!

*Windshield height is a personal preference, but one recognized standard is to be able to look just over the top of your windshield to see the road at a distance of 50 feet in front of you. Generally, this means that a correctly sized windshield mounted to your bike will have a top edge that is horizontally level with the tip of your nose, or just slightly below eye level.*

## SWITCHBLADE®/SPARTAN®/WAVE QR® WINDSHIELD

Description	WPS#
<b>HARLEY DAVIDSON</b>	
2-UP® Clear Narrow	<b>562-2280C</b>
2-UP® Clear Wideglide	<b>562-2281C</b>
2-UP® Clear FL Softail	<b>562-2282C</b>
2-UP® Clear Narrow 49mm Fork	<b>562-2283C</b>
2-UP® Clear Wide 49mm Fork	<b>562-2284C</b>
2-UP® Clear Road King	<b>562-2285C</b>
Chopped™ Clear Narrow	<b>562-2380C</b>
Chopped™ Clear Wideglide	<b>562-2381C</b>
Chopped™ Clear FL Softail	<b>562-2382C</b>
Chopped™ Clear Narrow 49MM fork	<b>562-2383C</b>
Chopped™ Clear Wide 49MM fork	<b>562-2384C</b>
Chopped™ Clear Road King	<b>562-2385C</b>
Chopped™ Tint Narrow	<b>562-2380S</b>
Chopped™ Tint Wideglide	<b>562-2381S</b>
Chopped™ Tint FL Softail	<b>562-2382S</b>
Chopped™ Tint Narrow 49MM fork	<b>562-2383S</b>
Chopped™ Tint Wide 49MM fork	<b>562-2384S</b>
Chopped™ Tint Road King	<b>562-2385S</b>
Shorty™ Clear Narrow	<b>562-2481C</b>
Shorty™ Clear Narrow 49MM fork	<b>562-2483C</b>
Shorty™ Clear Wide 49MM fork	<b>562-2484C</b>
Shorty™ Tint Narrow	<b>562-2481S</b>
Shorty™ Tint Wideglide	<b>562-2482S</b>
Shorty™ Tint Narrow 49MM fork	<b>562-2483S</b>

Description	WPS#
<b>HARLEY DAVIDSON (CONT'D...)</b>	
Shorty™ Tint Wide 49MM fork	<b>562-2484S</b>
Deflector™ Clear Narrow	<b>562-2580C</b>
Deflector™ Clear Wideglide	<b>562-2581C</b>
Deflector™ Clear FL Softail	<b>562-2582C</b>
Deflector™ Tint Narrow	<b>562-2580S</b>
Deflector™ Tint Wideglide	<b>562-2581S</b>
Deflector™ Tint FL Softail	<b>562-2582S</b>
SPARTAN®, 18.5" HT,Clear,Q, for FLSTC models	<b>562-20100</b>
SPARTAN®, 18.5" HT,Clear,Q, for FXDC models	<b>562-20101</b>
SPARTAN®, 18.5" HT,Clear,Q, for XL models	<b>562-20102</b>
SPARTAN®, 17" HT,Clear,Q, for FLSTC models	<b>562-20103</b>
SPARTAN®, 17" HT,Clear,Q, for FXDC models	<b>562-20104</b>
SPARTAN®, 17" HT,Clear Q, for XL models	<b>562-20105</b>
WAVE QR™ for XL models	<b>562-20115</b>
WAVE QR™ for FXD models	<b>562-20116</b>
WAVE QR™ for FLSTF models	<b>562-20117</b>
WAVE QR™ for FLHR models	<b>562-20118</b>
HRDWR KIT XL/FX Narrow Glide	<b>562-21180</b>
HRDWR KIT FX Wide Glide	<b>562-21181</b>
HRDWR KIT 49mm Fork	<b>562-21182</b>
HRDWR KIT FLST w/o lightbar	<b>562-21183</b>
HRDWR KIT FLST with lightbar	<b>562-21184</b>
HRDWR KIT Road King	<b>562-21185</b>

# DAKOTA™

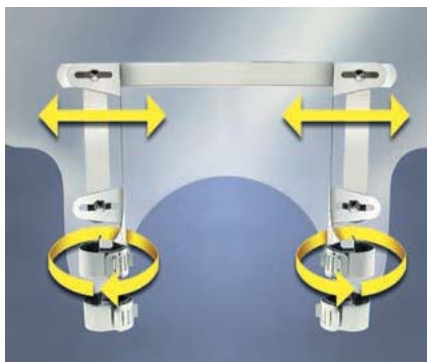
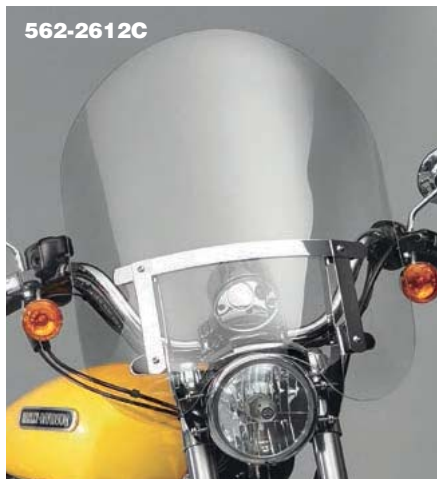

**All Mounting Hardware is Included!**

## DAKOTA 3.0™ WINDSHIELDS

The Dakota™ 3.0 windshield gives a custom look to any narrow glide front end. The patented variable width brackets and adjustable diameter fork clamps are included with the windshield.

Available in short or tall sizes to fit bikes with or without National Cycle's N935 Spotlight Bar.

The Dakota 3.0 is made from High Impact Acrylic for great wind protection at a budget price.



### Bikes Without N935 Spotlight Bar

**NC125A**  
Height: 17.5" (44.5cm)  
Width: 18.3" (46.5cm)

**10% Tint**

**N2310**  
Height: 20.5" (52.0cm)  
Width: 18.3" (46.5cm)

**10% Tint**



### Bikes With N935 Spotlight Bar

**NC125B**  
Height: 17.5" (44.5cm)  
Width: 18.3" (46.5cm)

**10% Tint**

**N2320**  
Height: 20.5" (52.0cm)  
Width: 18.3" (46.5cm)

**10% Tint**

Height is measured from headlight cutout to top of the shield. Width is measured in a straight line across the back of the shield at the widest point.

Application	Year	Dakota 3.0		Dakota 3.0, Tall	
		Low Turnsignals	High Turnsignals	Low Turnsignals	High Turnsignals
<b>SPORTSTER</b>					
All models (except '17 XL1200CX)	'88-17	<b>562-2610C</b>	<b>562-2611C</b>	<b>562-2612C</b>	<b>562-2613C</b>
	'79-85	<b>562-2610C</b>		<b>562-2612C</b>	
<b>FXR</b>					
FXR/FXRS Low Rider	'82-94	<b>562-2610C</b>		<b>562-2612C</b>	
FXDS Dyna Convertible	'94-00	<b>562-2610C</b>	<b>562-2611C</b>	<b>562-2612C</b>	<b>562-2613C</b>



## BEADED WINDSHIELD FOR FXSTS MODELS

National Cycle's Beaded Heavy Duty™ windshield for the FXSTS and FXSTSB is trimmed with a traditional beaded edge that is mechanically applied. No yellowing or cracking of glue joints is possible.

The highly polished chrome mounts attach to the handlebar risers to provide a significant range of adjustment for height and rake.

This rugged windshield features stainless steel and chrome hardware and FMR hardcoated polycarbonate. All necessary mounting hardware is included.

To top it off, it's covered by National Cycle's 3-Year Warranty against breakage!



Height: 13.25" (33.6cm)  
Width: 20.25" (51.4cm)

**Clear**



Description	Year	Height	Clear
FXSTS Springer Softail	'89-07	13.25"	<b>562-20200</b>

- WINDSHIELDS / FAIRINGS
- AUDIO / COMMUNICATION
- SEATS / LUGGAGE
- BAR / MIRRORS / CONTROLS
- EXHAUST
- AIR / FUEL SYSTEMS
- ENGINE
- TRANSMISSION / DRIVELINE
- GASKETS / SEALS
- ELECTRICAL
- LIGHTING
- CABLES
- BRAKES
- OIL FILTERS
- SUSPENSION
- BODY
- WHEELS
- TIRES / TIRE ACC.
- BIKE ACC.
- VICTORY / INDIAN
- COVERS / LOCKS / TIEDOWNS
- CHEMICALS
- TOOLS
- HELMETS
- HELMET ACC.
- EYEWEAR
- APPAREL / RIDER ACC.
- PROMOTIONAL
- REFERENCE
- INDEX



**HERITAGE BEADED WINDSHIELDS**



The National Cycle 5-bolt pattern Beaded Heavy Duty™ Windshield is an authentic three-piece beaded construction manufactured with modern, premium quality materials. The complete windshield is available in polycarbonate with a clear top and your choice of Clear, Red, Blue or Black bottom section, and Early FL-Style or Standard Round adjustable middle window. Outer frame hardware is bright chrome plated steel and internal hardware is non-glare zinc finish. Windshield Mount Kits are available for an extremely wide range of makes and models

Application	Year	Mount Kit	Clear	Red	Blue	Black
<b>HARLEY-DAVIDSON</b>						
<b>TOURING</b>						
All Road King models	'94-17	<b>562-21185</b>	<b>562-2230</b>	<b>562-2231</b>	<b>562-2232</b>	<b>562-2233</b>
<b>SOFTAIL</b>						
All FL Softail models w/o light bar (except listed below)	'87-17	<b>562-21183</b>	<b>562-2230</b>	<b>562-2231</b>	<b>562-2232</b>	<b>562-2233</b>
All FL Softails models w/ light bar	'86-17	<b>562-21184</b>	<b>562-2230</b>	<b>562-2231</b>	<b>562-2232</b>	<b>562-2233</b>
FLST Heritage Softail	'86-90	<b>562-21185</b>	<b>562-2230</b>	<b>562-2231</b>	<b>562-2232</b>	<b>562-2233</b>
All FX Softail models (except listed below)	'84-12	<b>562-21181</b>	<b>562-2230</b>	<b>562-2231</b>	<b>562-2232</b>	<b>562-2233</b>
FXSTC Softail Custom	'07-10	<b>562-21183</b>	<b>562-2230</b>	<b>562-2231</b>	<b>562-2232</b>	<b>562-2233</b>
FXS Blackline	'11-12	<b>562-21182</b>	<b>562-2230</b>	<b>562-2231</b>	<b>562-2232</b>	<b>562-2233</b>
<b>DYNA</b>						
All models (except listed below and FXDF)	'06-17	<b>562-21182</b>	<b>562-2230</b>	<b>562-2231</b>	<b>562-2232</b>	<b>562-2233</b>
FXDWG Dyna Wide Glide	'10-17	<b>562-21181</b>	<b>562-2230</b>	<b>562-2231</b>	<b>562-2232</b>	<b>562-2233</b>
FXDWG Dyna Wide Glide	'06-08	<b>562-21182</b>	<b>562-2230</b>	<b>562-2231</b>	<b>562-2232</b>	<b>562-2233</b>
FXDL Low Rider	'06-09	<b>562-21182</b>	<b>562-2230</b>	<b>562-2231</b>	<b>562-2232</b>	<b>562-2233</b>
FXDS Convertible Dyna Low Rider	'94-00	<b>562-21182</b>	<b>562-2230</b>	<b>562-2231</b>	<b>562-2232</b>	<b>562-2233</b>
FXDWG Dyna Wide Glide	'93-05	<b>562-21181</b>	<b>562-2230</b>	<b>562-2231</b>	<b>562-2232</b>	<b>562-2233</b>
FXWG Wide Glide	'80-85	<b>562-21181</b>	<b>562-2230</b>	<b>562-2231</b>	<b>562-2232</b>	<b>562-2233</b>
FXDG Disc Glide	'83	<b>562-21181</b>	<b>562-2230</b>	<b>562-2231</b>	<b>562-2232</b>	<b>562-2233</b>
<b>EARLY FL MODELS (NOTCHED WINDOW)</b>						
Most models with 41mm front end	'60-84		<b>562-2235</b>	<b>562-2236</b>	<b>562-2237</b>	<b>562-2234</b>

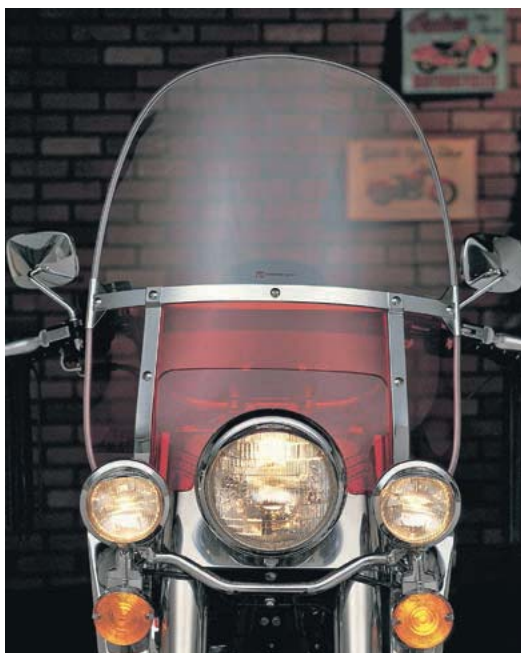

## REPLACEMENT SCREENS FOR FLHR & FLSTC MODELS

Made from 4mm thick polycarbonate (33% thicker than OEM) with National Cycle's exclusive Quantum™ hardcoating.

This replacement windshield plastic fits exactly into the stock hardware of the OEM windshield.

Best of all, you get National Cycle's 3-Year Warranty against breakage!



Height is measured from headlight cutout to top of screen.

Description	Year	Material Color	Height	WPS#
<b>HARLEY-DAVIDSON</b>				
FLHRC/FLHR	'94-17	Poly, Quantum, Clear	20.00"	<b>562-20200C</b>
FLHRC/FLHR	'94-17	Poly, Quantum, Tinted	14.00"	<b>562-20200S</b>
FLSTC	'00-17	Poly, Quantum, Clear	20.00"	<b>562-20202C</b>

## REPLACEMENT SCREENS FOR FLH MODELS



When you're looking for the hard-to-find FLH Replacement Screen for your early model bagger, count on National Cycle for the best quality and the best deal available. Don't be fooled by acrylic imitations. These FMR hardcoated Lexan® polycarbonate windscreens are CNC routed for a precision fit with a smoothly radiused perimeter edge.

Description	Year	Height	Clear	Height	Smoke	Height	Dark Smoke
<b>HARLEY-DAVIDSON</b>							
FLHT/FLHTC/FLHTCU	'96-13	12.75"	<b>562-20230C</b>	12.75"	<b>562-20230S</b>	8.75"	<b>562-20231D</b>
FLHT/FLHTC	'86-95	11.75"	<b>562-20210C</b>	6.25"	<b>562-20211S</b>		



## GLADIATOR™ HEIGHT/RAKE ADJUSTABLE WINDSHIELDS

Finally, a custom looking small windshield that's worthy of your bike – the Gladiator™ from National Cycle!

The custom engineered, fully adjustable DualPivot™ mounting bracket allows a wide range of personalized height and rake positions. There's a perfect setting for any size rider or any weather condition!

The Gladiator is made from FMR hardcoated polycarbonate and is available in Light Tint or Dark Tint. The included mounting hardware comes in brilliant chrome or wrinkle finish black to match your bike's factory finish.



Overall Height: 14.50" (36.8cm)  
Width: 12.50" (31.8cm)

**25% Tint**

**95% Tint**



**A simple wrench is all that's needed to easily change windshield settings. Adjust for rake angle, screen height, or both!**

Application	Year	Chrome		Black	
		Light Tint	Dark Tint	Light Tint	Dark Tint
<b>SOFTAIL</b>					
FLSTF/FLSTFB Fat Boy/Lo	'07-17	562-20137S	562-20137D		
FLST Softail Models (except '07-08 FLSTF)	'86-08	562-20130S	562-20130D	562-20131S	562-20131D
FXST Softail Models	'84-12	562-20130S	562-20130D	562-20131S	562-20131D
<b>DYNA/FXR</b>					
FXDWG/FXDF	'06-17	562-20136S	562-20136D		
FXDC	'07-14	562-20130S	562-20130D	562-20131S	562-20131D
FXDB	'13-16	562-20130S	562-20130D	562-20131S	562-20131D
FXDB	'08-12	562-20136S	562-20136D		
FXD	'06-10			562-20138S	562-20138D
FXDL	'06-09	562-20136S	562-20136D		
FXDB	'06-07	562-20130S	562-20130D	562-20131S	562-20131D
FXD35	'06	562-20130S	562-20130D	562-20131S	562-20131D
FXDS	'94-00	562-20130S	562-20130D	562-20131S	562-20131D
FXDL/FXDWG	'93-05	562-20130S	562-20130D	562-20131S	562-20131D
FXD (Dyna Series)	'93-05	562-20132S	562-20133D	562-20134S	562-20134D
All Models (except '93-94 FXD Dyna Series)	'80-94	562-20130S	562-20130D	562-20131S	562-20131D
<b>SPORTSTER</b>					
All Models (except listed below and XL883 Super Low)	'88-13	562-20132S	562-20133D	562-20134S	562-20134D
XL883N	'09-17			562-20138S	562-20138D
XL1200N	'07-12			562-20138S	562-20138D
XL1200L	'06-11			562-20138S	562-20138D
XL1200C/XL883C	'96-10	562-20135S	562-20135D		

562-20130S  
562-20130D  
562-20131S  
562-20131D

**Stock One-Piece Top Clamp Mount**

562-20132S  
562-20133D  
562-20134S  
562-20134D  
562-20138S  
562-20138D

**Stock Speedo Top Clamp Mount**

562-20135S  
562-20135D

**Stock XL Custom Top Tree Mount**

562-20136S  
562-20136D

**Stock Two-Piece Top Clamp Mount**

562-20137S  
562-20137D

**Stock Two-Piece 1.25" Clamp Mount**



**MOHAWK WINDSHIELDS** **NEW** **national cycle** Made in U.S.A.

WINDSHIELDS / FAIRINGS

AUDIO / COMMUNICATION

SEATS / LUGGAGE

BARS / MIRRORS / CONTROLS

EXHAUST

AIR / FUEL SYSTEMS

ENGINE

TRANSMISSION / DRIVELINE

GASKETS / SEALS

ELECTRICAL

LIGHTING

CABLES

BRAKES

OIL FILTERS

SUSPENSION

BODY

WHEELS

TIRES / TIRE ACC.

BIKE ACC.

VICTORY / INDIAN

COVERS / LOCKS / TIEDOWNS

CHEMICALS

TOOLS

HELMETS

HELMET ACC.

EYEWEAR

APPAREL / RIDER ACC.

PROMOTIONAL

REFERENCE

INDEX

Continuing the minimalist, sporty tradition of our famous Flyscreen®, the Mohawk™ features a taller and wider size with a special 'V' profile for added wind management.

- Manufactured from FMR hardcoated polycarbonate for unbeatable strength and impact resistance
- Linking Arm fork mount system (available in chrome or black) with countersunk screws offers a custom fit for almost any motorcycle with open front forks
- All Mohawk™ windshields are dark gray tinted, 9.25" tall x 11.75" wide and include all hardware needed

If your bike is not listed in the application chart, order by mounting bracket type (universal applications).



Straight Arm Hardware



Curved Arm Hardware



Headlight Mount

Application	Year	Black Hardware	Chrome Hardware
<b>HARLEY-DAVIDSON</b>			
<b>XL MODELS</b>			
All models except listed below	'57-17	<b>562-2850B</b>	<b>562-2850C</b>
XL1200X Sportster Forty-Eight	'16-17	<b>562-2854B</b>	<b>562-2854C</b>
XR1200/XR1200X	'09-12	<b>562-2854B</b>	<b>562-2854C</b>
<b>FXD/FXR MODELS</b>			
All models	'70-05	<b>562-2850B</b>	<b>562-2850C</b>
All models except FXDF	'06-17	<b>562-2854B</b>	<b>562-2854C</b>
<b>FX SOFTAIL MODELS</b>			
All models except listed below	'84-13	<b>562-2850B</b>	<b>562-2850C</b>
FXSB Breakout	'13-15	<b>562-2854B</b>	<b>562-2854C</b>
<b>VRS MODELS</b>			
All models except listed below	'02-17	<b>562-2854B</b>	<b>562-2854C</b>
VRSCDX Night Rod Special	'12-15	<b>562-2855B</b>	<b>562-2855C</b>
<b>STREET</b>			
XG500/750	'14-17	<b>562-2850B</b>	<b>562-2850C</b>
<b>INDIAN</b>			
Spirit	'01-03	<b>562-2850B</b>	<b>562-2850C</b>
Scout	'15-17	<b>562-2850B</b>	<b>562-2850C</b>
<b>UNIVERSAL</b>			
Up to 43 mm fork tube diam., straight arm hardware		<b>562-2850B</b>	<b>562-2850C</b>
Up to 43 mm fork tube diam., curved arm hardware		<b>562-2851B</b>	<b>562-2851C</b>
44 mm to 51 mm fork tube diam., straight arm hardware		<b>562-2854B</b>	<b>562-2854C</b>
44 mm to 51 mm fork tube diam., curved arm hardware		<b>562-2855B</b>	<b>562-2855C</b>
52 mm to 56 mm fork tube diam., straight arm hardware		<b>562-2852B</b>	<b>562-2852C</b>
52 mm to 56 mm fork tube diam., curved arm hardware		<b>562-2853B</b>	<b>562-2853C</b>
Headlight bracket mount		<b>562-2856B</b>	<b>562-2856C</b>





**FLYSCREEN® WINDSHIELDS**



- Made from durable High Impact Acrylic in Light or Dark Tint
- Beautifully finished fork-mount hardware in bright polished chrome with countersunk screws
- Mounts allow custom fitment and height/rake adjustment



Height: 9.00" (23.0cm)  
Width: 9.75" (25.0cm)

**25% Tint**   **95% Tint**



Application	Year	Clear	Clear w/ black hardware	Tint	Tint w/ black hardware
<b>SOFTAIL</b>					
All FX models (except Springer)	'84-13	<b>562-27000</b>	<b>562-27000B</b>	<b>562-27001</b>	<b>562-27001B</b>
FXSB	'13-15	<b>562-27004</b>	<b>562-27004B</b>	<b>562-27005</b>	<b>562-27005B</b>
<b>DYNA/FXR</b>					
FXDWG	'06-17	<b>562-27004</b>	<b>562-27004B</b>	<b>562-27005</b>	<b>562-27005B</b>
All models	'06-15	<b>562-27004</b>	<b>562-27004B</b>	<b>562-27005</b>	<b>562-27005B</b>
	'70-05	<b>562-27000</b>	<b>562-27000B</b>	<b>562-27001</b>	
<b>SPORTSTER</b>					
All models (except listed below)	'57-17	<b>562-27000</b>	<b>562-27000B</b>	<b>562-27001</b>	<b>562-27001B</b>
XR1200/XR1200X	'09-12	<b>562-27004</b>	<b>562-27004B</b>	<b>562-27005</b>	<b>562-27005B</b>
XL1200X/CX	'16-17	<b>562-27004</b>	<b>562-27004B</b>	<b>562-27005</b>	<b>562-27005B</b>
<b>STREET MODELS</b>					
XG500/XG750	'15-17	<b>562-27000</b>	<b>562-27000B</b>	<b>562-27001</b>	<b>562-27001B</b>
<b>V-ROD</b>					
All models (except listed below)	'02-17	<b>562-27004</b>	<b>562-27004B</b>	<b>562-27005</b>	<b>562-27005B</b>
VRSCDX	'12-17	<b>562-27006</b>	<b>562-27006B</b>	<b>562-27007</b>	<b>562-27007B</b>

**plexifairing™**

**PLEXIFAIRING 3™ FAIRINGS**

- Lightweight and fluidly aerodynamic
- Reduces wind fatigue, great for cold weather riding
- Protective rubber gasket for close fit around headlight
- QuickSet™ mounting hardware included



Height: 21.00" (53.3cm)  
Width: 32.00" (81.3cm)

**Clear**

**No-Hole Ballssocket™ mount for perfect adjustments**

**QuickSet™ pivot handlebar mount for clean, easy installation and quick, no-tool removal**

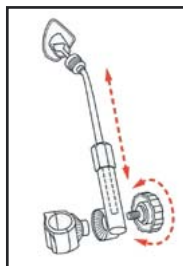

Description	Year	Height	WPS#
<b>SPORTSTER</b>			
XL883N Iron 883	'09-17	21"	<b>562-2750C</b>
XL1200V Sportster 72	'12-17	21"	<b>562-2750C</b>
XL1200N Nightster	'07-12	21"	<b>562-2750C</b>
XL1200/XL883R Sportster	'04-11	21"	<b>562-2750C</b>
XL1200L Sportster Low	'06-11	21"	<b>562-2750C</b>
XL1200C/XL883C Sportster Custom	'96-10	21"	<b>562-2750C</b>
XL883L/ Sportster Low	'05-10	21"	<b>562-2750C</b>
XL1200/XL883 Sportster	'88-03	21"	<b>562-2750C</b>
XL1200S Sportster Sport	'96-03	21"	<b>562-2750C</b>

Description	Year	Height	WPS#
<b>SPORTSTER (cont'd...)</b>			
XL1100/XL883 Sportster	'86-87	21"	<b>562-2750C</b>
XL/XLH/XLCH Sportster	'57-85	21"	<b>562-2750C</b>
XLX Sixty-One	'83-85	21"	<b>562-2750C</b>
XR1000	'83-84	21"	<b>562-2750C</b>
<b>DYNA/FXR</b>			
FXD/FXDL/FXDX/FXDC	'93-05	21"	<b>562-2750C</b>
FXDS Dyna Convertible	'94-00	21"	<b>562-2750C</b>
FXR/FXRS Super Glide/ Low Rider	'82-94	21"	<b>562-2750C</b>



**INTRODUCING THE NEW QUANTUM® national cycle®**  
**HARDCOATED DEFLECTOR SCREEN™** Made in U.S.A.



Our original 2-point QuickSet™ mount Deflector Screen™ was first introduced in 1980 and became an instant hit with riders everywhere. It defined the term "universal windshield." We then followed up with the Street Shield™, a larger screen with a 4-point QuickSet mounting system. Now there's a better reason to stock these popular windshields for your customers: They've been upgraded from High Impact Acrylic to National Cycle's exclusive Quantum® hardcoated polycarbonate – the state-of-the-art in scratch resistance – but with no price increase!

Mount Type	Clear	Tint
<b>U-CLAMP</b>		
Fits 7/8"-1" Bars, Clear	<b>562-2962C</b>	<b>562-2962D</b>
<b>QUICKSET</b>		
Fits 7/8" Bars, Clear	<b>562-2963C</b>	<b>562-2963D</b>
Fits 1" Bars, Clear	<b>562-2964C</b>	<b>562-2964D</b>
Fits 1 1/4" Bars, Clear	<b>562-2965C</b>	<b>562-2965D</b>

- Clear polycarbonate with Quantum® Hardcoating
- 2-point QuickSet™ or U-Clamp mount with RakeAdjust
- Height: 14.00", an excellent compact screen



**STREET SCREEN**

- Clear polycarbonate with Quantum® Hardcoating
- 4-point QuickSet™ or U-Clamp mounting system
- Height: 17.00", an excellent mid-size screen

Mount Type	Clear	Tint
<b>U-CLAMP</b>		
Fits 7/8"-1", Clear	<b>562-2941C</b>	<b>562-2941D</b>
<b>QUICKSET MOUNT, 17" TALL</b>		
Fits 7/8", Clear	<b>562-2942C</b>	<b>562-2942D</b>
Fits 1", Clear	<b>562-2943C</b>	<b>562-2943D</b>
Fits 1 1/4", Clear	<b>562-2944C</b>	<b>562-2944D</b>
<b>QUICKSET MOUNT, EX 18" TALL</b>		
Fits 7/8"		<b>562-2930D</b>
Fits 1"		<b>562-2931D</b>



**Notes**

**Street Shield/Deflector Notes**

**WPS#**

1	Use 562-29000 (BAG#47A) and 562-29005 (BAG#53) for Quickset mount for non-tubular bars	
2	Use 562-29000 (BAG#47A) and 562-29007 (BAG#62) for Non-Quickset mounts for non-tubular bars	
3	Use 562-29005 (BAG#53) and 562-29006 (BAG#54) for Quickset mount for mirror mounts	
4	Use 562-29006 (BAG#54) and 562-29007 (BAG#62) for Non-Quickset mounts for mirror mount	

**REPLACEMENT PARTS/ACCESSORIES**

Quickset mounts for 7/8" handlebars	<b>562-29003</b>
Quickset mounts for 1" handlebars	<b>562-29010</b>
Quickset mounts for 1 1/4" handlebars	<b>562-29011</b>

WINDSHIELDS / FAIRINGS

AUDIO / COMMUNICATION

SEATS / LUGGAGE

BARS / MIRRORS / CONTROLS

EXHAUST

AIR / FUEL SYSTEMS

ENGINE

TRANSMISSION / DRIVELINE

GASKETS / SEALS

ELECTRICAL

LIGHTING

CABLES

BRAKES

OIL FILTERS

SUSPENSION

BODY

WHEELS

TIRES / TIRE ACC.

BIKE ACC.

VICTORY / INDIAN

COVERS / LOCKS / TIEDOWNS

CHEMICALS

TOOLS

HELMETS

HELMET ACC.

EYEWEAR

APPAREL / RIDER ACC.

PROMOTIONAL

REFERENCE

INDEX

- WINDSHIELDS / FAIRINGS
- AUDIO / COMMUNICATION
- SEATS / LUGGAGE
- BAR / MIRRORS / CONTROLS
- EXHAUST
- AIR / FUEL SYSTEMS
- ENGINE
- TRANSMISSION / DRIVELINE
- GASKETS / SEALS
- ELECTRICAL
- LIGHTING
- CABLES
- BRAKES
- OIL FILTERS
- SUSPENSION
- BODY
- WHEELS
- TIRES / TIRE ACC.
- BIKE ACC.
- VICTORY / INDIAN
- COVERS / LOCKS / TIEDOWNS
- CHEMICALS
- TOOLS
- HELMETS
- HELMET ACC.
- EYEWEAR
- APPAREL / RIDER ACC.
- PROMOTIONAL
- REFERENCE
- INDEX



## SWITCHBLADE® HOLDSTER™

- Fits SwitchBlade 2-Up, Chopped and Shorty windshields
- Handy storage for glasses, cell phones, gloves, etc.
- 12.5" x 5" x 3" deep



Description	WPS #
Holdster	562-21220

## FLH/FLT HEAT SHIELDS

- These Heat Shields fit all 2009-16 Touring and Trike models
- Dark tint polycarbonate replaces the OEM black plastic shields and lets more of the engine details show through without the heat waves roasting your thighs
- Simple installation with unique clip-nut fastener system

Applications	Year	WPS#
HARLEY-DAVIDSON		
Touring and Trike models	'09-17	562-20260

## SHIELD WASH™ AND RAINZIP®

- Shield Wash™ is strong enough to clean spotlessly, mild enough to use as needed
- Safe on all motorcycle windshields, face shields and goggles
- Includes 8-oz. bottle of Shield Wash, 1-oz. spray bottle and special microfiber cleaning cloth
- RainZip® rain repellent treatment is formulated for Quantum™ hardcoated polycarbonate but is safe for all windshields
- Comes in a 3-oz. bottle and includes an application cloth and microfiber polishing cloth

Description	WPS #
Shield Wash	562-21100
RainZip	562-21101



## WIND GUARDS

Chrome-plated or black powdercoated, and easy to mount to Glide front ends. Deflects wind away from your legs and feet. A beautiful addition to most Touring models, fits 1983-up FLHT, FLHS, FLHR and FLHRC models. Does not fit models equipped with fairing lowers or lighted fork slider kits. Does not fit FLHX Street Glide models or models equipped with Custom Front Bullet Turn Signal Kits (OEM's 69577-06 and 69492-05).

Application	Description	WPS #
A '83-13 FLH/FLT	Windguard Chrome	830-3260
B	Windguard Black	830-3261

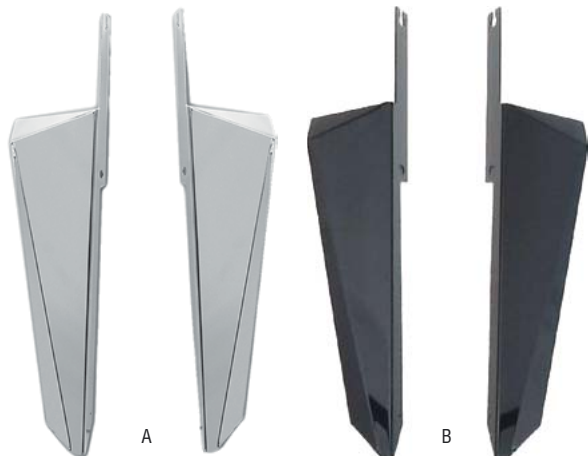

## SWITCHBLADE® STORAGE BAG

- Designed to store and protect any of the four Switchblade Windshields, or any other National Cycle windshield
- Soft inner, durable outer, sturdy zipper and convenient handle
- 29" high x 25" wide



Description	WPS #
Storage Bag	562-21221



## REPLACEMENT WINDSHIELDS

- All replacement shields are made of 3/16" Dupont acrylic plastic
- Meets DOT and ANS1Z26-1 specifications



	Application	Height	Clear	Smoke	Dark Smoke
<b>HARLEY DAVIDSON</b>					
A	FLHT '86-95	10"	<b>56-6700</b>	<b>56-6700S</b>	
		13"	<b>56-6701</b>	<b>56-6701S</b>	
		16"	<b>56-6702</b>	<b>56-6702S</b>	
B	FLHT '96-13	6"		<b>56-6710S</b>	<b>56-6710DS</b>
		8"		<b>56-6711S</b>	<b>56-6711DS</b>
		10"	<b>56-6712</b>	<b>56-6712S</b>	<b>56-6712DS</b>
		13"	<b>56-6713</b>	<b>56-6713S</b>	
		16"	<b>56-6714</b>	<b>56-6714S</b>	
		FLHT '14-17	6"		<b>56-6718S</b>
	8"		<b>56-6719S</b>	<b>56-6719DS</b>	
	10"	<b>56-6715</b>	<b>56-6715S</b>	<b>56-6715DS</b>	
	13"	<b>56-6716</b>	<b>56-6716S</b>		
	16"	<b>56-6717</b>	<b>56-6717S</b>		
C	FLT '84-95	16"	<b>56-6730</b>	<b>56-6730S</b>	
		19"	<b>56-6731</b>	<b>56-6731S</b>	
		21"	<b>56-6732</b>	<b>56-6732S</b>	
FLTR '98-03		8"		<b>56-6740S</b>	
		12"	<b>56-6741</b>	<b>56-6741S</b>	
		15"	<b>56-6742</b>	<b>56-6742S</b>	
		18"	<b>56-6743</b>	<b>56-6743S</b>	
D	FLTR '04-13	12"	<b>56-6750</b>	<b>56-6750S</b>	
		15"	<b>56-6751</b>	<b>56-6751S</b>	
		18"	<b>56-6752</b>	<b>56-6752S</b>	
FLTR '15-17		10"			<b>56-6756DS</b>
		13"	<b>56-6753</b>	<b>56-6753S</b>	
		16"	<b>56-6754</b>	<b>56-6754S</b>	
		19"	<b>56-6755</b>	<b>56-6755S</b>	



### S-06 SPITFIRE

- Compact and streamlined protection
- Fully adjustable and quickly detachable
- Fits round and rectangular headlights

Description	Black Hardware	Chrome Hardware
Clear 7/8" & 1"	56-6523	56-6679
Clear 1 1/4"	56-6651	56-6764
Clear 1 1/2"	56-6766	
Tint 7/8" & 1"	56-6524	56-6763
Tint 1 1/4"	56-6653	56-6765
Tint 1 1/2"	56-6767	



S-06 H15" X W17 1/4"

### SS-10 VIPER

- Quick release mounting system - same as Spitfire
- Unique design gives the rider more upper body protection

Description	Black Hardware	Chrome Hardware
Clear 7/8" & 1"	56-6518	56-6768
Clear 1 1/4"	56-6655	56-6681
Clear 1 1/2"	56-6683	
Tint 7/8" & 1"	56-6519	56-6680
Tint 1 1/4"	56-6657	56-6682
Tint 1 1/2"	56-6684	



S-10H 17 1/4" X W 22

### BULLET AND B-WING

- Billet Aluminum hardware
- Universal Mounts
- Interchangeable glass
- Fully adjustable
- Mirror polished, chrome plated, billet aluminum
- Universal hardware mount

Description	WPS#
Bullet 15" Clear 7/8-1"	56-6675
Bullet 18" Clear 7/8-1"	56-6676
B-Wing 15" Clear 7/8-1"	56-6677
B-Wing 18" Clear 7/8-1"	56-6678



### SS-20 STEALTH

- Flowing sculptured curves, excellent protection, with anodized aluminum hardware
- Comes with 1" hardware

Description	WPS#
Clear	56-6658
Smoke	56-6659
Clamp kit 1 1/2"	56-6693



See pages 24-25 for applications



### SS-32 16/20 FALCON

Description	Chrome	Black
16" Fat	56-6631C	56-6631BK
16" Oversize Fork	56-6587C	56-6587BK
16" Regular Fork	56-6583C	56-6583BK
16" Tapered Fork	56-6584C	56-6584BK
16" Wide Glide	56-6630C	56-6630BK
20" Fat	56-6633C	56-6633BK
20" Oversize Fork	56-6588C	56-6588BK
20" Regular Fork	56-6585C	56-6585BK
20" Tapered Fork	56-6586C	56-6586BK
20" Wide Glide	56-6632C	56-6632BK
Retro-fit hardware	56-6554	

- Quick release mounting system, available in chrome or black powdercoat finish
- Available in 16" and 20" heights X 34½" width for regular, oversize and tapered forks
- Retro-fit hardware kit available to convert older non-quick release windshields to quick release mounting

If your application lists that the Falcon windshield fits with no notes, use the "Regular Fork" version windshield.



SS-30-17

### SS-30 17/22 CLASSIC CRUISER

Description	Chrome	Black
17" Clear Regular Fork	56-6510C	56-6510BK
17" Clear Fat	56-6635C	56-6635BK
17" Clear Oversize	56-6601C	56-6601BK
17" Clear Tapered	56-6526C	56-6526BK
17" Clear Wide Glide	56-6634C	56-6634BK
17" Smoke Regular Fork	56-6511C	56-6511BK
17" Smoke Fat	56-6637C	56-6637BK
17" Smoke Oversize	56-6602C	56-6602BK
17" Smoke Tapered	56-6603C	56-6603BK
17" Smoke Wide Glide	56-6636C	56-6636BK
22" Clear Regular Fork	56-6512C	56-6512BK
22" Clear Fat	56-6639C	56-6639BK
22" Clear Oversize	56-6605C	56-6605BK
22" Clear Tapered	56-6531C	56-6531BK
22" Clear Wide Glide	56-6638C	56-6638BK
22" Smoke Regular Fork	56-6513C	56-6513BK
22" Smoke Fat	56-6641C	56-6641BK
22" Smoke Oversize	56-6607C	56-6607BK
22" Smoke Tapered	56-6606C	56-6606BK
22" Wide Glide	56-6640C	56-6640BK
Retro-fit hardware	56-6554	

- Quick release mounting system, available in chrome or black powdercoat finish
- Windshield is constructed out of 3/16" Lucite® Acrylic
- Available in 17" and 22" height X 23" width for regular, oversize and tapered forks
- Retro-fit hardware kit available to convert older non-quick release windshields to quick release mounting

If your application lists that the Classic Cruiser windshield fits with no notes, use the "Regular Fork" version windshield.



SS-30-22



### SS-34 PHANTOM NEW

Description	WPS#
13" Dark Smoke Regular Fork	56-6781BK
13" Dark Smoke Fat	56-6780BK
13" Dark Smoke Oversize	56-6783BK
13" Dark Smoke Tapered	56-6782BK
13" Dark Smoke Wide Glide	56-6784BK

- Quick release mounting hardware with a black powdercoated finish
- 13" Height X 30" width, for regular, oversize and tapered forks
- Windshield is constructed out of dark smoke 3/16" Lucite® Acrylic

If your application lists that the Phantom windshield fits with no notes, use the "Regular Fork" version windshield.

See pages 24-25 for applications

WINDSHIELDS / FAIRINGS

AUDIO / COMMUNICATION

SEATS / LUGGAGE

BARS / MIRRORS / CONTROLS

EXHAUST

AIR / FUEL SYSTEMS

ENGINE

TRANSMISSION / DRIVELINE

GASKETS / SEALS

ELECTRICAL

LIGHTING

CABLES

BRAKES

OIL FILTERS

SUSPENSION

BODY

WHEELS

TIRES / TIRE ACC.

BIKE ACC.

VICTORY / INDIAN

COVERS / LOCKS / TIEDOWNS

CHEMICALS

TOOLS

HELMETS

HELMET ACC.

EYEWEAR

APPAREL / RIDER ACC.

PROMOTIONAL

REFERENCE

INDEX



### HD-3 TOMBSTONE

- Designed for the riders who don't always want to ride behind a screen
- Quick release mounting system
- Anodized aluminum brackets, 3/16" thick acrylic shield

Description	Black Hardware	Chrome Hardware
Clear 7/8" & 1"	56-6502	56-6685
Clear 1 1/4"	56-6647	56-6687
Clear 1 1/2"	56-6690	
Smoke 7/8" & 1"	56-6503	56-6686
Smoke 1 1/4"	56-6649	56-6688
Smoke 1 1/2"	56-6689	



### HD-0 POLICE

- Designed to replicate the "Harley" police shield
- Quick release mounting hardware allows you to remove shield in seconds
- Features stainless steel straps, anodized aluminum hardware and 3/16" acrylic shield

Description	WPS#
Clear 7/8" & 1"	56-6506
Clear 1 1/4"	56-6643
Clear 1 1/2"	56-6692
Smoke 7/8" & 1"	56-6507
Smoke 1 1/4"	56-6645
Smoke 1 1/2"	56-6691



## WINDSHIELD APPLICATIONS

Application	Year	Enterprise	Spirit	Slipstreamer	Turbo	Spittire	Sport Shield	Viper	Stealth	Hellfire	Hellfire V	Sport	Classic/Falcon/Phantom	Police/Tombstone	
		S-00	S-02	S-03	S-05	S-06	S-08	SS-10	SS-20	SS-24	SS-24V	SS-28	SS 30/32	HD-0/HD-03	
<b>HARLEY DAVIDSON</b>															
<b>SOFTTAILS</b>															
FLS Slim	'12-17					1 1/4"		1 1/4"						1 1/4"	
FLSTF Fat Boy	'01-17					•		•						•	
FLSTFB Fat Boy Lo	'10-17					1 1/4"		1 1/4"						1 1/4"	
FLSTFS Fat Boy S	'16-17					1 1/4"		1 1/4"						1 1/4"	
FLSTN Softail Dix.	'93-17					•		•						•	
FLSTSB Cross Bones	'08-11					•		•						•	
FXSB/SE Breakout	'13-17					1 1/4"		1 1/4"	1 1/4"					1 1/4"	
FXS Blackline	'11-13					•		•	•					•	
FXCW/C Rockers	'08-11					•		•	•				0	•	
FXSTD Duece	'00-07					•		•	•				WG	•	
FXSTB Night Train	'99-09					•		•	•				WG	•	
FXST/C Softails	'87-10					•		•	•				WG	•	
FXSTS/SE Springers	'89-09					•		•						•	
<b>DYNAS</b>															
FXDB Street Bob	'13-17					1 1/4"		1 1/4"	1 1/4"				F	1 1/4"	
	'10-12					•		•	•				0	•	
	'06-09					•		•	•				WG	•	
FXDL Low Rider	'15-17, '06-09					•		•	•				0	•	
	'99-05					•		•	•				•	•	
FXDWG Wide Glide	'07-17					1 1/4"		1 1/4"	1 1/4"				0	1 1/4"	
	'99-06					•		•	•				WG	•	
FXDF/SE Fat Bob	'08-17					1 1/4"		1 1/4"	1 1/4"					1 1/4"	
FLD Switchback	'13-16					•		•						•	

- Fits
- 1" Order windshield with 1" hardware or 56-6562 T-clamp kit
- 1 1/4" Order windshield with 1 1/4" hardware
- 0 Needs oversized fork Falcon or Classic Cruiser windshield
- WG Order windshield with Wide Glide hardware



### WINDSHIELD APPLICATIONS

Application	Year	Enterprise	Spirit	Slipstreamer	Turbo	Spiritfire	Sport Shield	Viper	Stealth	Hellfire	Hellfire V	Sport	Classic/Falcon/ Phantom	Police/ Tombstone	
		S-00	S-02	S-03	S-05	S-06	S-08	SS-10	SS-20	SS-24	SS-24V	SS-28	SS 30/32	HD-0/ HD-03	
<b>HARLEY DAVIDSON</b>															
<b>DYNAS (CONT'D...)</b>															
FXDSE Screamin' Eagle	'08-09					1 1/4"		1 1/4"	1 1/4"						1 1/4"
FXDC Super Glide Custom	'06-14					•		•	•				0		•
FXD Super Glide	'06-10					•		•	•				0		•
FXD/C/X/G Super Glide	pre-'05					•		•	•				•		•
<b>SPORTSTERS</b>															
XL883/C/L/N	'88-17					•		•	•				•		•
XL1200V Seventy-Two	'12-17					•		•	•				•		•
XL1200X Forty-Eight	'10-17					•		•	•				•		•
XL1200C	'11-14					•							WG		•
XR1200X	'11-12					•		•							•
XL1200N Nightster	'07-12					•		•	•				•		•
XL1200R Roadster	'01-08					•		•	•				•		•
XL1200S Sport	'96-03					•		•	•				•		•
XL883 Hugger	All					•		•	•				•		•
XL1100	'86-87					•		•	•				•		•
XL1200/C/L	'88-10					•		•	•				•		•
<b>STREET</b>															
XG500/750	'14-17					•									•
<b>V-ROD</b>															
VRSC/B/R/AW/DX	'02-17					•		•	•						•
VRSCF Muscle	'09-17					1 1/2"		1 1/2"							1 1/2"

- Fits
- 1" Order windshield with 1" hardware or 56-6562 T-clamp kit
- 1 1/4" Order windshield with 1 1/4" hardware
- O Needs oversized fork Falcon or Classic Cruiser windshield
- WG Order windshield with Wide Glide hardware

See pages 21-23 for windshield part numbers



### SPORTSTER WINDSCREENS NEW

Made of 3mm high-impact acrylic and designed through our virtual wind tunnel, ensuring better aerodynamics and superior rider protection against the wind. New Generation windscreens provide a perfect fit in assembly and on finished product. Mounting instructions are provided with all our screens.



Application	Year	Clear	Black	Dark Smoke	Light Smoke
<b>SPORTSTER</b>					
All models (except 48)	'04-18	<b>561-06290CL</b>	<b>561-06290BK</b>	<b>561-06290DS</b>	<b>561-06290LS</b>

- WINDSHIELDS / FAIRINGS
- AUDIO / COMMUNICATION
- SEATS / LUGGAGE
- BARS / MIRRORS / CONTROLS
- EXHAUST
- AIR / FUEL SYSTEMS
- ENGINE
- TRANSMISSION / DRIVELINE
- GASKETS / SEALS
- ELECTRICAL
- LIGHTING
- CABLES
- BRAKES
- OIL FILTERS
- SUSPENSION
- BODY
- WHEELS
- TIRES / TIRE ACC.
- BIKE ACC.
- VICTORY / INDIAN
- COVERS / LOCKS / TIEDOWNS
- CHEMICALS
- TOOLS
- HELMETS
- HELMET ACC.
- EYEWEAR
- APPAREL / RIDER ACC.
- PROMOTIONAL
- REFERENCE
- INDEX



**NEW WINDSHIELDS**

The Dragonfly Cycle Concepts Flip Out Windshields provide excellent air flow over and around the rider while still giving a great appearance to your ride. With making wind protection and audio fairings for over 15 years, Dragonfly really understands the need for letting you have a little wind in your face without Beating you up!

Through extensive testing Dragonfly has developed a full line of the "Flip Out" Windshields.

- Fits All HD Batwing Fairings
- Made of Acrylic it is more scratch resistant than Lexan shields
- Fits all Dragonfly Classic Model Fairings
- Takes wind off of you like taller windshields



Application	Year	Height	Clear	Dark Tint	Black
<b>HARLEY-DAVIDSON</b>					
FLHT/FLHX/FLHTK Touring models (all)	'14-Up	5"	826-02009	826-02010	826-02011
		6.5"	826-02012	826-02013	826-02014
FLHT/FLHX/FLHTK Touring models (all)	'98-13	4"	826-02000	826-02001	826-02002
		6"	826-02003	826-02004	826-02005
		8"	826-02006	826-02007	826-02008
FLTR/X/U Road Glide Ultra	'15-Up	9"	826-02015	826-02016	826-02017

## 2014 STYLE DETACHABLE BATWING FAIRING



"2014 Style" Gives any year Harley Davidson Free Wheeler or Road King the Look of a 2014 and NEWER Street Glide!!!



826-02050



Made from injection-molded LPRTM composite parts with stainless steel mounting brackets formed and bolted inside the fairing from top to bottom providing unmatched strength with NO vibration

The detachable fairing ships FULLY ASSEMBLED with inner/outer shell in black gel-coat finish (this fairing is designed to be painted). Delivered with 6" tinted windshield. Set up for 6"x9" speakers and single DIN stereo (sold separately).

- One Set Stainless Steel Brackets
- One 12-Volt Accessory Port
- Two Speaker Grilles
- One Set Mounting Hardware

Application	WPS#
Fits All Road King Models '94-Up	826-02050
Fits Freewheeler Models '15-Up	826-02051
<b>FAIRING LOCK</b>	
Fits FLHR Models	826-02052



826-02060



## FXRP FAIRING FOR DYNAS



Modeled after the Police/Touring fairing, this is a frame mounted fairing (does not turn with handle bars). We have added the Dragonfly styling touches, and made it audio friendly!

Set up for an Aquatic AV radio or a radio of your choice (sold separately). We have also set it up to have one pair of speakers of your choice added. With room to add amps if desired, this can be a great retro fairing for the increasingly popular Dyna scene.

**Includes:**

- Flat Windshield
- Headlight Cover



826-02062



826-02061

Application	WPS#
Fits All FXDB, FXDL Models '06-17	826-02060
<b>REPLACEMENT PARTS</b>	
Tinted Windshield	826-02061
Clear Headlight Cover	826-02062

WINDSHIELDS / FAIRINGS

AUDIO / COMMUNICATION

SEATS / LUGGAGE

BARS / MIRRORS / CONTROLS

EXHAUST

AIR / FUEL SYSTEMS

ENGINE

TRANSMISSION / DRIVELINE

GASKETS / SEALS

ELECTRICAL

LIGHTING

CABLES

BRAKES

OIL FILTERS

SUSPENSION

BODY

WHEELS

TIRES / TIRE ACC.

BIKE ACC.

VICTORY / INDIAN

COVERS / LOCKS / TIEDOWNS

CHEMICALS

TOOLS

HELMETS

HELMET ACC.

EYEWEAR

APPAREL / RIDER ACC.

PROMOTIONAL

REFERENCE

INDEX

WINDSHIELDS / FAIRINGS

AUDIO / COMMUNICATION

SEATS / LUGGAGE

BARS / MIRRORS / CONTROLS

EXHAUST

AIR / FUEL SYSTEMS

ENGINE

TRANSMISSION / DRIVELINE

GASKETS / SEALS

ELECTRICAL

LIGHTING

CABLES

BRAKES

OIL FILTERS

SUSPENSION

BODY

WHEELS

TIRES / TIRE ACC.

BIKE ACC.

VICTORY / INDIAN

COVERS / LOCKS / TIEDOWNS

CHEMICALS

TOOLS

HELMETS

HELMET ACC.

EYEWEAR

APPAREL / RIDER ACC.

PROMOTIONAL

REFERENCE

INDEX



### CLAMSHELL 1/4 FAIRING

- Constructed from heavy duty precision molded ABS
- Black powder coated brackets (application specific fork clamps sold separately)
- Fits Dynas, F Rs and Sportsters
- Includes dark tinted screen and headlight cover



Application	Description	WPS#
Universal	Clamshell 1/4 Fairing	820-55412

### BATWING FAIRING COMPONENTS



- Quality ABS reproduction inner and outer vented Batwing fairing components
- Effortlessly match up to OEM and most aftermarket components
- Require minimal prep for paint



820-55410

Application	Description	WPS#
Fits Touring Models '14-UP	Outer Fairing	820-55410
	Inner Fairing	820-55411
	Fairing Side Wings	820-55420



820-55411



820-55420

### FLTR GAUGE HOUSING



- Reproduction of OEM gauge housing
- Works with stock and most aftermarket gauges
- Unpainted ABS from precision molds



Description	Application	WPS#
Instrument Housing	Fits FLTR Models '15-UP	820-55432



## DX STYLE FAIRING KIT **NEW**

Application	WPS#
<b>DX FAIRING KIT '06-UP DYNAS</b>	
A Tall Screen	750-01305
B Short Screen	750-01306

- Made of gel coated fiberglass, ready for paint
- Smoked screen made of acrylic resin
- Available in two heights, tall screen measures 1 - /16 , short screen measures 6



A



B

Application	WPS#
<b>BIKINI COWL WITH SCREEN</b>	
A '06-Up Dynas	750-01315
B '04-Up XL (Except XL 48)	750-01314
C '11-Up XL 48	750-01313

## BIKINI COWL W/SCREEN **NEW**

- Updated version of the popular bikini cowl now with a smoked screen
- Lower part made of gel coated fiberglass ready for paint
- Screen made of acrylic resin



A



B



C

WINDSHIELDS / FAIRINGS  
 AUDIO / COMMUNICATION  
 SEATS / LUGGAGE  
 BARS / MIRRORS / CONTROLS  
 EXHAUST  
 AIR / FUEL SYSTEMS  
 ENGINE  
 TRANSMISSION / DRIVELINE  
 GASKETS / SEALS  
 ELECTRICAL  
 LIGHTING  
 CABLES  
 BRAKES  
 OIL FILTERS  
 SUSPENSION  
 BODY  
 WHEELS  
 TIRES / TIRE ACC.  
 BIKE ACC.  
 VICTORY / INDIAN  
 COVERS / LOCKS / TIEDOWNS  
 CHEMICALS  
 TOOLS  
 HELMETS  
 HELMET ACC.  
 EYEWEAR  
 APPAREL / RIDER ACC.  
 PROMOTIONAL  
 REFERENCE  
 INDEX



**T-SPORT FAIRING**

- Lower part made of gel coated fiberglass ready for paint
- Smoked screen made of acrylic resin
- Available in two heights, tall screen measures 1 - /16 , short screen measures 6
- Mounting hardware included

Application	WPS#
<b>FITS '06-UP DYNAS</b>	
A Tall Screen	750-01307
B Short Screen	750-01308
<b>FITS '04-UP SPORTSTERS</b>	
C Tall Screen	750-01309
D Short Screen	750-01310
<b>FITS '15-UP XG MODELS</b>	
E Tall Screen	750-01311
F Short Screen	750-01312



A

B

C



D

E

F



## T-SPORT COWLS

Made of gel coated fiberglass, ready for paint. Mounting hardware included. Sportster version fits models with visor mounted headlight only.



A

B

Application	WPS#
<b>T-SPORT COWL KIT</b>	
A '06-17 Dynas	<b>750-01303</b>
B '04-Up XL models	<b>750-01304</b>

## BIKINI HEADLIGHT COWLS

Whether you're looking for some subtle wind deflection or that cafe custom look, these easy to mount cowl kits are the way to go. All mounting hardware is included.

Application	WPS#
<b>BIKINI COWL KIT</b>	
A '06-17 Dynas	<b>750-01302</b>
B '11-15 XL 48	<b>750-01301</b>
C '04-Up XL w/Visor Mounted Headlights	<b>750-01300</b>

- Gel coated fiberglass material
- Speedometer relocation may be necessary on '04-Up XL models (except XL48)
- Will not fit '06-Up Dynas with riser mounted speedometer
- Check fitment before painting and final installation



A

B

C



products with a watertight reputation

# HARLEY-DAVIDSON BLUETOOTH® STEREOS

## A. BLUETOOTH® RADIO 98-13 HARLEY

- Bluetooth/iPod/iPhone/USB/MP3/AUX
- Sirius XM Ready \*SXV300V1 Required
- AM/FM (US/Euro)
- 2x USB & 3.5mm jack device input
- 3" Color screen w. album artwork display
- 72W x 4 channel @2 Ohm
- 1x pair RCA Auxiliary input
- 2x pair 4V RCA pre-outputs
- Clock
- Built-in 288W Amplifier
- 1x Subwoofer pre-output
- Dummy faceplate/dust cover
- Detachable faceplate
- Internal device tray
- Device charging via USB
- Waterproof IP55
- Retains stock handlebar controls



## B. BLUETOOTH® RADIO-UNIVERSAL

- Bluetooth/iPod/iPhone/USB/MP3/AUX
- AM/FM (US/Euro)
- USB & 3.5mm jack device input
- 3" Color screen w. album artwork display
- 72W x 4 channel @2 Ohm
- 1x pair RCA Auxiliary input
- 2x pair 4V RCA pre-outputs
- Built-in 288W Amplifier
- 1x Subwoofer pre-output
- Detachable faceplate
- Internal device tray
- Device charging via USB
- Waterproof IP55
- DOES NOT use stock controls



## C. BLUETOOTH® RADIO 98-13 HARLEY

- A2DP Bluetooth/MP3/AUX
- AM/FM (US/Euro)
- 3.5mm jack & RCA input
- DOT matrix LCD display
- 72W x 4 channel @2 Ohm
- 1x pair 4V RCA pre-outputs
- Built-in 288W Amplifier
- 1x Subwoofer pre-output
- 1x Subwoofer pre-output
- Detachable faceplate
- Internal device tray
- Device charging via USB
- Waterproof IP55
- Retains stock handlebar controls



Description	WPS#
A Bluetooth, USB and MP3 media players with AM/FM radio and Sirius/XM ready	94-1312
B Bluetooth Universal Radio	94-1310
C Bluetooth and MP3 media players with AM/FM radio	94-1300
Dummy Faceplate/Dust cover	94-1313





# AV ULTRA HARLEY PACKAGE



products with a watertight reputation



Package Includes:

- Sirius XM, Bluetooth, USB Waterproof Harley Stereo
- 1 pair 6.5" Waterproof 360W Harley Speakers
- 1 pair Speaker Grills
- 1 pair Speaker Mounting Rings
- 1 Waterproof 2 Channel 300W Harley Amplifier
- 1 Dummy Faceplate / Dust Cover for Stereo
- 1 Surface Mount USB Socket

Description	WPS#
Ultra Harley Package	94-1317



Adjustable tweeter direction to improve sound quality when traveling at speed!

## 6.5" SPEAKERS



- Fit Electra Glide, Street Glide and Road Glide
- '98-13 models require grill & mounting ring (included)
- '14-18 models do NOT require grill & mounting ring
- 4 Ohm impedance
- Mounting hole diameter 144mm
- Marine grade
- Full-range, 2-way waterproof speakers

Application	Description	WPS#
'98-18 FLH/FLT models with fairing	360W	94-1311
	200W	94-1316



200W



## DIMENSIONS

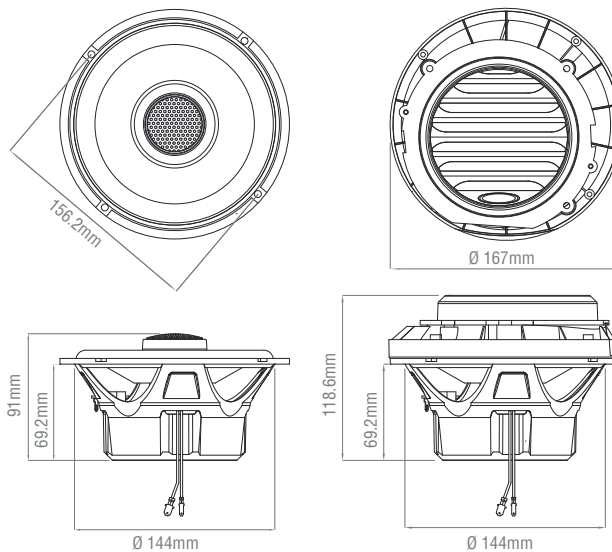

- WINDSHIELDS / FAIRINGS
- AUDIO / COMMUNICATION
- SEATS / LUGGAGE
- BARS / MIRRORS / CONTROLS
- EXHAUST
- AIR / FUEL SYSTEMS
- ENGINE
- TRANSMISSION / DRIVELINE
- GASKETS / SEALS
- ELECTRICAL
- LIGHTING
- CABLES
- BRAKES
- OIL FILTERS
- SUSPENSION
- BODY
- WHEELS
- TIRES / TIRE ACC.
- BIKE ACC.
- VICTORY / INDIAN
- COVERS / LOCKS / TIEDOWNS
- CHEMICALS
- TOOLS
- HELMETS
- HELMET ACC.
- EYEWEAR
- APPAREL / RIDER ACC.
- PROMOTIONAL
- REFERENCE
- INDEX

- WINDSHIELDS / FAIRINGS
- AUDIO / COMMUNICATION**
- SEATS / LUGGAGE
- BAR / MIRRORS / CONTROLS
- EXHAUST
- AIR / FUEL SYSTEMS
- ENGINE
- TRANSMISSION / DRIVELINE
- GASKETS / SEALS
- ELECTRICAL
- LIGHTING
- CABLES
- BRAKES
- OIL FILTERS
- SUSPENSION
- BODY
- WHEELS
- TIRES / TIRE ACC.
- BIKE ACC.
- VICTORY / INDIAN
- COVERS / LOCKS / TIEDOWNS
- CHEMICALS
- TOOLS
- HELMETS
- HELMET ACC.
- EYEWEAR
- APPAREL / RIDER ACC.
- PROMOTIONAL
- REFERENCE
- INDEX



products with a watertight reputation

## AV 2-CHANNEL AMP NEW

- Digital (Class D) bridgeable amplifier
- Waterproof
- RCA inputs, speaker inputs with Auto Detect
- 2 Ohm and 4 ohm stable
- 100W per channel at 4 ohms
- 150W per channel at 2 ohms
- 300W bridged at 2 ohms
- Overload protection



Description	WPS#
Aquatic AV Micro 2 Channel Waterproof Amp	94-1501

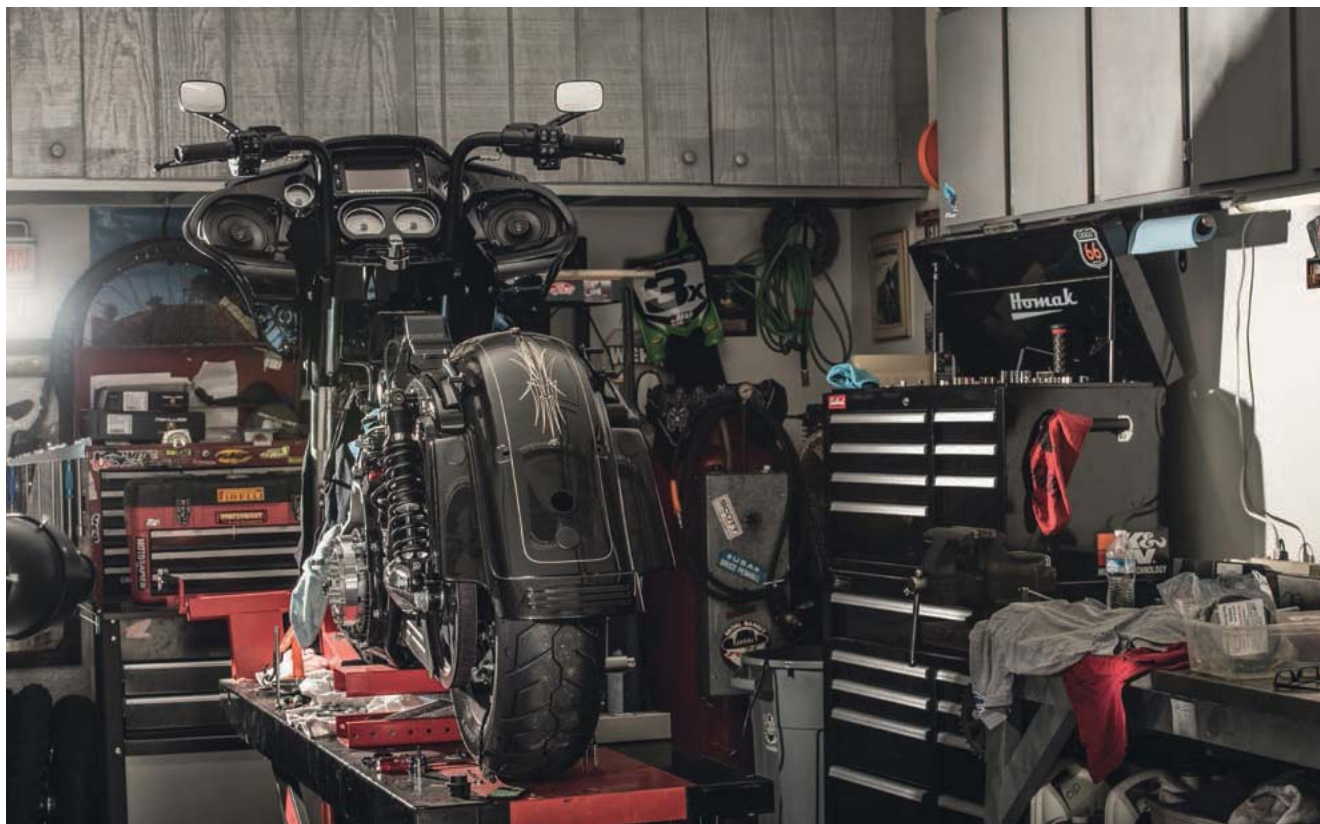
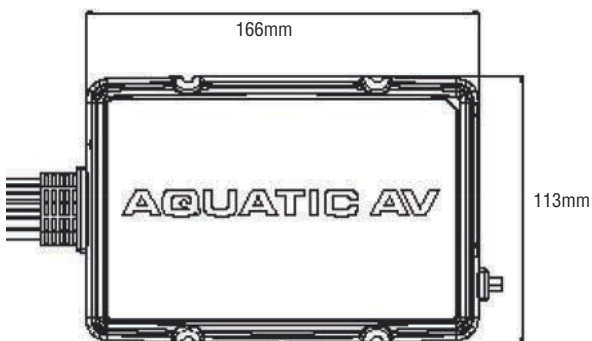

# ROKKER® **XXR EXTREME 330W SPEAKER AND AMP KIT**



- This is the new J&M Custom 2-speaker & amplifier kit
- Fits '14-Up Batwing or '15-Up Road Glide fairing with the Harley BoomBox 6.5GT Premium or 4.3 standard radio
- 2 channel amplifier rated at 165w RMS per channel X 2 to provide up to 330w total RMS power!
- The amplifier's settings have been dialed in & optimized for this exact speaker/radio configuration, to provide the on-highway volume, clarity and overall performance that most
- Includes fully weatherproof 6.71" ROKKER XXR speakers featuring a high-tech woven-fiber woofer cone & a massive high-density high-flux strength Neodymium magnet structure with large center & perimeter positioned voice coil cooling vents, to provide for maximum heat dissipation when operating at high volume levels for extended periods

- The custom designed speaker grills with mounted high-output dome tweeters are also weather-proof and shock-proof for maximum long-term durability
- This custom installation KIT has been engineered to be 100% plug-and-play for your convenience during the installation and to maintain the complete integrity of your Harley's internal wiring harness.

Application	WPS#
A '14-18 FLHX/FLHTCU	<b>94-1307</b>
B '15-18 FLTRX/FLTRU	<b>94-1296</b>



A



B



- WINDSHIELDS / FAIRINGS
- AUDIO / COMMUNICATION
- SEATS / LUGGAGE
- BARS / MIRRORS / CONTROLS
- EXHAUST
- AIR / FUEL SYSTEMS
- ENGINE
- TRANSMISSION / DRIVELINE
- GASKETS / SEALS
- ELECTRICAL
- LIGHTING
- CABLES
- BRAKES
- OIL FILTERS
- SUSPENSION
- BODY
- WHEELS
- TIRES / TIRE ACC.
- BIKE ACC.
- VICTORY / INDIAN
- COVERS / LOCKS / TIEDOWNS
- CHEMICALS
- TOOLS
- HELMETS
- HELMET ACC.
- EYEWEAR
- APPAREL / RIDER ACC.
- PROMOTIONAL
- REFERENCE
- INDEX

WINDSHIELDS / FAIRINGS  
 AUDIO / COMMUNICATION  
 SEATS / LUGGAGE  
 BARS / MIRRORS / CONTROLS  
 EXHAUST  
 AIR / FUEL SYSTEMS  
 ENGINE  
 TRANSMISSION / DRIVELINE  
 GASKETS / SEALS  
 ELECTRICAL  
 LIGHTING  
 CABLES  
 BRAKES  
 OIL FILTERS  
 SUSPENSION  
 BODY  
 WHEELS  
 TIRES / TIRE ACC.  
 BIKE ACC.  
 VICTORY / INDIAN  
 COVERS / LOCKS / TIEDOWNS  
 CHEMICALS  
 TOOLS  
 HELMETS  
 HELMET ACC.  
 EYEWEAR  
 APPAREL / RIDER ACC.  
 PROMOTIONAL  
 REFERENCE  
 INDEX



# ROKKER® **XXRK EXTREME 630W** **SPEAKER AND AMP**

- This is the new custom 630w 4-speaker/amplifier installation kit
- Fits Touring bikes with the Harley BoomBox 6.5GT Premium or 4.3 standard radio
- 4 channel amplifier rated @ 157.5w RMS per channel X 4 to provide up to 630w total RMS power!
- The amplifier's settings have been dialed in & optimized for this exact speaker/radio configuration, to provide the on-highway volume, clarity and overall performance
- Included are J&M's fully weatherproof 6.71" ROKKER XXR fairing speakers featuring a high-tech woven-fiber woofer cone & a massive high-density high-flux strength Neodymium magnet structure with large center & perimeter positioned voice coil cooling vents, to provide for maximum heat dissipation when operating at high volume levels for extended periods
- The custom designed speaker grills with mounted high-output dome tweeters are also weather-proof and shock-proof for maximum long-term durability
- Included with FLHX and FLTRX kits are 2 5X7" ROKKER XX speakers for the rear saddlebag-lid position, 2 saddlebag lid speaker grills, along with the custom complete saddlebag speaker wiring harness (speaker lids NOT included)
- Included with FLHTU/FLHTK and FLTRU kits are fully weatherproof 6.71" ROKKER XXR rear-pod speakers
- This custom installation KIT has been engineered to be 100% plug-and-play for your convenience during the installation and to maintain the complete integrity of your Harley's internal wiring harness

Application	WPS#
A '14-18 FLHX	<b>94-1297</b>
B '15-18 FLTRX	<b>94-1299</b>
C '14-18 FLHTCU/FLHTK	<b>94-1298</b>
D '16-18 FLTRU	<b>94-1308</b>



# ROKKER® XXRP 4 CH. AMPLIFIERS



- 4-channel 630 watt RMS fairing/rear speaker amplifier kit
- Plug-n-play RCA input harnesses included with this amplifier kit
- Provides 4 separate channels of amplification at 157.5 watts RMS continuous power per-channel into a 2 or 4-ohm speaker load
- This is a full range class D digital amplifier properly shielded against RF interference into the AM or FM stereo radio bands
- Amplifiers use advanced digital switching power supply technology to reduce the 12v current demands on the motorcycles electrical system
- Fully programmable thru the internal digital signal processor (DSP)
- Amplifier mounts to the custom made stainless steel 2-piece bracket system, to provide solid and secure mounting inside the fairing, in addition to blocking amplifier heat from being transferred to the radio

- Should you wish to alter these DSP settings using the internal programming dongle already built into this new amplifier, (USB computer connection cable also included with this amplifier kit) all of our specific custom amplifier programs are now available as a consumer download from the J&M site.
- Amplifier itself measures 8 1/4" Long X 5 1/8" Wide X 1 5/8" Tall.

Application	WPS#
A '16-18 FLTRU	* 94-1295
B '15-18 FLTR W/ REAR SPKRS	94-1294
C '14-18 FLHX W/REAR SPKRS	94-1289
D '14-18 FLHTCU/FLHTK	94-1290

\*not for CVO models



A



B



C



D



- WINDSHIELDS / FAIRINGS
- AUDIO / COMMUNICATION
- SEATS / LUGGAGE
- BARS / MIRRORS / CONTROLS
- EXHAUST
- AIR / FUEL SYSTEMS
- ENGINE
- TRANSMISSION / DRIVELINE
- GASKETS / SEALS
- ELECTRICAL
- LIGHTING
- CABLES
- BRAKES
- OIL FILTERS
- SUSPENSION
- BODY
- WHEELS
- TIRES / TIRE ACC.
- BIKE ACC.
- VICTORY / INDIAN
- COVERS / LOCKS / TIEDOWNS
- CHEMICALS
- TOOLS
- HELMETS
- HELMET ACC.
- EYEWEAR
- APPAREL / RIDER ACC.
- PROMOTIONAL
- REFERENCE
- INDEX

- WINDSHIELDS / FAIRINGS
- AUDIO / COMMUNICATION
- SEATS / LUGGAGE
- BARS / MIRRORS / CONTROLS
- EXHAUST
- AIR / FUEL SYSTEMS
- ENGINE
- TRANSMISSION / DRIVELINE
- GASKETS / SEALS
- ELECTRICAL
- LIGHTING
- CABLES
- BRAKES
- OIL FILTERS
- SUSPENSION
- BODY
- WHEELS
- TIRES / TIRE ACC.
- BIKE ACC.
- VICTORY / INDIAN
- COVERS / LOCKS / TIEDOWNS
- CHEMICALS
- TOOLS
- HELMETS
- HELMET ACC.
- EYEWEAR
- APPAREL / RIDER ACC.
- PROMOTIONAL
- REFERENCE
- INDEX



# ROKKER® XXRP 4 CH. AMPLIFIERS

- 4-channel 630 watt RMS fairing/rear speaker amplifier kit
- Plug-n-play RCA input harnesses included with this amplifier kit
- Provides 4 separate channels of amplification at 157.5 watts RMS continuous power per-channel into a 2 or 4-ohm speaker load
- This is a full range class D digital amplifier properly shielded against RF interference into the AM or FM stereo radio bands
- Amplifiers use advanced digital switching power supply technology to reduce the 12v current demands on the motorcycles electrical system
- Fully programmable thru the internal digital signal processor (DSP)
- Amplifier mounts to the custom made stainless steel 2-piece bracket system, to provide solid and secure mounting inside the fairing, in addition to blocking amplifier heat from being transferred to the radio

- Should you wish to alter these DSP settings using the internal programming dongle already built into this new amplifier, (USB computer connection cable also included with this amplifier kit) all of our specific custom amplifier programs are now available as a consumer download from the J&M site.
- Amplifier itself measures 8 1/4" Long X 5 1/8" Wide X 1 5/8" Tall.

Application	WPS#
E '06-13 FLHX W/REAR SPKRS	94-1287
F '06-13 FLHTCU	94-1288
G '11-13 FLTR	94-1293
H '06-13 FLTR W/REAR SPKRS	94-1292
I '98-13 BAGGER MODELS	94-1291



# ROKKER® **XXR - SERIES** **2 CHANNEL AMP KITS**



- Full range class G digital amplifier
- Spec'd at 165watts RMS per channel X2 channels
- 330w total, driven continuous into a 2 ohm load @ 14.4vdc
- Stainless steel 2-piece bracket system, provides solid and secure mounting while blocking amplifier heat from being transferred to the radio
- These amplifiers are now fully programmable thru the internal digital signal processor
- Dialed in for model specific speaker configuration, to provide maximum highway performance from your Harley Davidson audio system

- Should you wish to alter these settings, when adding additional speakers to the system, or changing the impedance of the speakers, J&M will be offering all of our specific custom pre-loaded amplifier programs as a consumer download from the J&M site.
- Custom made plug-n-play wiring harnesses are included with this amplifier kit
- Top quality heavy gauge power/ground wires are used for the fused battery connection
- Comes with all necessary mounting hardware & complete installation/operation instructions
- Amplifier itself measures 7 1/4" X 4 3/4" X 1 3/4"

	Application	WPS#
A	'14-18 FLH models w/ faring	<b>94-1276</b>
B	'06-13 FLH models w/ faring	<b>94-1275</b>
C	'06-13 FLTR models	<b>94-1277</b>

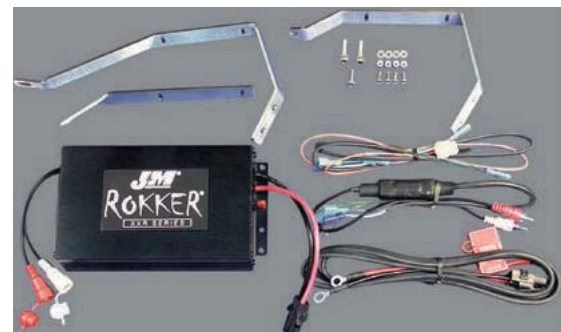

- WINDSHIELDS / FAIRINGS
- AUDIO / COMMUNICATION
- SEATS / LUGGAGE
- BARS / MIRRORS / CONTROLS
- EXHAUST
- AIR / FUEL SYSTEMS
- ENGINE
- TRANSMISSION / DRIVELINE
- GASKETS / SEALS
- ELECTRICAL
- LIGHTING
- CABLES
- BRAKES
- OIL FILTERS
- SUSPENSION
- BODY
- WHEELS
- TIRES / TIRE ACC.
- BIKE ACC.
- VICTORY / INDIAN
- COVERS / LOCKS / TIEDOWNS
- CHEMICALS
- TOOLS
- HELMETS
- HELMET ACC.
- EYEWEAR
- APPAREL / RIDER ACC.
- PROMOTIONAL
- REFERENCE
- INDEX

- WINDSHIELDS / FAIRINGS
- AUDIO / COMMUNICATION
- SEATS / LUGGAGE
- BARS / MIRRORS / CONTROLS
- EXHAUST
- AIR / FUEL SYSTEMS
- ENGINE
- TRANSMISSION / DRIVELINE
- GASKETS / SEALS
- ELECTRICAL
- LIGHTING
- CABLES
- BRAKES
- OIL FILTERS
- SUSPENSION
- BODY
- WHEELS
- TIRES / TIRE ACC.
- BIKE ACC.
- VICTORY / INDIAN
- COVERS / LOCKS / TIEDOWNS
- CHEMICALS
- TOOLS
- HELMETS
- HELMET ACC.
- EYEWEAR
- APPAREL / RIDER ACC.
- PROMOTIONAL
- REFERENCE
- INDEX



## PERFORMANCE SERIES 180 WATT 2-CHANNEL AMP KIT

- This J&M 2-channel 180w fairing speaker amplifier kit has been design specifically for use on the 2015 Road Glide fairing with the stock Harley radio
- Amplifier mounts to the custom made stainless steel 2-piece bracket system, to provide solid and secure mounting inside the Road Glide fairing
- Blocks amplifier heat from being transferred to the radio
- Custom made plug-n-play wiring harnesses are included with this amplifier kit
- All necessary mounting hardware & complete installation/operation instructions included
- Amplifier itself measures 6 1/2" X 4 3/4" X 1 3/4"

Description	WPS#
'15-18 FLTR fairing speaker amplifier kit	94-1271



## PERFORMANCE SERIES 360 WATT 4-CHANNEL AMP KIT

- Designed specifically for the 2017 Road Glide with the stock Harley radio
- This kit takes the 2-channels of audio signal available from the Road Glide radio and provides 4 separate channels of amplification at 90w RMS continuous for each channel
- Amplifier mounts to the custom made stainless steel 2-piece bracket system, to provide solid and secure mounting inside the Road Glide fairing, in addition to blocking amplifier heat from being transferred to the radio.
- Custom made plug-n-play wiring harnesses, top quality heavy gauge power/ground wires, along with all necessary mounting hardware & complete installation/operation instructions all included
- Amplifier itself measures 7 1/4" X 4 3/4" X 1 3/4"

Description	WPS#
'15-18 FLTR w/ stock radio and lower fairing or rear speakers	94-1272



## XXR SERIES 330 WATT 2-CHANNEL AMP KIT

- 2-channel 330w fairing speaker amplifier kit has been designed specifically for use on the 2015 Road Glide with the stock Harley radio
- Amplifier mounts to the custom made stainless steel 2-piece bracket system
- Blocks amplifier heat from being transferred to the radio
- ROKKER XXR series amplifiers come out of the box already dialed in for this specific Road Glide speaker configuration
- Custom made plug-n-play wiring harnesses are included with this amplifier kit, top quality heavy gauge power/ground wires are used for the fused battery connection, along with all necessary mounting hardware & complete installation/operation instructions
- Amplifier itself measures 7 1/4" X 4 3/4" X 1 3/4"

Description	WPS#
'15-18 FLTR w/ stock radio	94-1273





# ROKKER<sup>®</sup> SPEAKER KITS



- WINDSHIELDS / FAIRINGS
- AUDIO / COMMUNICATION
- SEATS / LUGGAGE
- BAR / MIRRORS / CONTROLS
- EXHAUST
- AIR / FUEL SYSTEMS
- ENGINE
- TRANSMISSION / DRIVELINE
- GASKETS / SEALS
- ELECTRICAL
- LIGHTING
- CABLES
- BRAKES
- OIL FILTERS
- SUSPENSION
- BODY
- WHEELS
- TIRES / TIRE ACC.
- BIKE ACC.
- VICTORY / INDIAN
- COVERS / LOCKS / TIEDOWNS
- CHEMICALS
- TOOLS
- HELMETS
- HELMET ACC.
- EYEWEAR
- APPAREL / RIDER ACC.
- PROMOTIONAL
- REFERENCE
- INDEX

- J&M's NEW ROKKER XXR series 6.71" speakers have been designed as exact size component/replacements for the stock 6.5"
- Spec'd at 2 ohms impedance and an impressive 300 watts maximum input (175w RMS - 91db sensitivity), these speakers provide the ultimate in raw audio power and include the new custom grills with built-in high-output tweeters
- Lightweight waterproof one-piece woven-fiber driver cone with super-rigid metal basket design
- High-density lightweight Neodymium magnet structure, specially coated to maintain flux-strength integrity even at extreme operating temperatures

- High efficiency VENTED voice-coil for improved cooling when operating at high volume levels for extended periods
- Custom speaker grills with high-output tweeters for crystal clear sound at highway speeds
- Mounting hole pattern and spade electrical connections are exactly the same as the factory specification, this is a total plug-and-play no-modification solution complete with easy to follow installation instructions
- These are THE most powerful speakers you can buy for your Harley and they will perform extremely well when used with a medium to high-powered accessory amplifier

Application	Description	WPS#
A '14-18 FLH models w/ fairing	XXR series 6.71 Fairing Speaker Kit	<b>94-1306</b>
B '14-18 models w/ trunk and or lower fairing	XXR series 6.71 Rear Trunk Speaker Kit or Lower Fairing Speaker Kit	<b>94-1303</b>
C '15-18 FLTR models	XXR series 6.71 Fairing Speaker Kit	<b>94-1302</b>

A



B



C



WINDSHIELDS / FAIRINGS  
 AUDIO / COMMUNICATION  
 SEATS / LUGGAGE  
 BARS / MIRRORS / CONTROLS  
 EXHAUST  
 AIR / FUEL SYSTEMS  
 ENGINE  
 TRANSMISSION / DRIVELINE  
 GASKETS / SEALS  
 ELECTRICAL  
 LIGHTING  
 CABLES  
 BRAKES  
 OIL FILTERS  
 SUSPENSION  
 BODY  
 WHEELS  
 TIRES / TIRE ACC.  
 BIKE ACC.  
 VICTORY / INDIAN  
 COVERS / LOCKS / TIEDOWNS  
 CHEMICALS  
 TOOLS  
 HELMETS  
 HELMET ACC.  
 EYEWEAR  
 APPAREL / RIDER ACC.  
 PROMOTIONAL  
 REFERENCE  
 INDEX



# ROKKER<sup>®</sup> SERIES SPEAKER KITS

- J&M's ROKKER XXR series 7.25" drivers are the largest diameter speakers that can be installed into the Harley fairings, with cone volume and mass comparable to a 6X9" speaker
- Spec'd at 2 ohms impedance and an impressive 217 watts maximum input (165w RMS continuous - 92db sensitivity), these new speakers provide the ultimate in raw audio power
- This custom speaker installation kit has been designed specifically for the 1998-2013 models
- Lightweight waterproof one-piece polycarbonate driver cone with super-rigid metal basket design
- High-density lightweight Neodymium magnet structure, specially coated to maintain flux-strength integrity even at extreme operating temperatures
- High efficiency VENTED voice-coil for improved cooling when operating at high volume levels for extended periods
- Custom speaker grills with high-output tweeter & midrange for crystal clear sound at highway
- This speaker kit is NOT compatible for direct connection to the 1998-2005 Harley RSI factory radio system, without connecting an amplifier between the RSI radio and the speakers

\* For '98-05 FLTR and '12-13 CVO RoadGlide updated speaker plate adapters are needed WPS# 94-1309

	Application	Description	WPS#
A	'98-13 FLH models w/ fairing	XXR series 7.25 Fairing Speaker Kit	<b>94-1304</b>
B	* '98-13 FLTR models	XXR series 7.25 Fairing Speaker Kit	<b>94-1305</b>
	'98-05 FLTR and '12-13 CVO Road Glide	Speaker plate adapters	<b>94-1309</b>

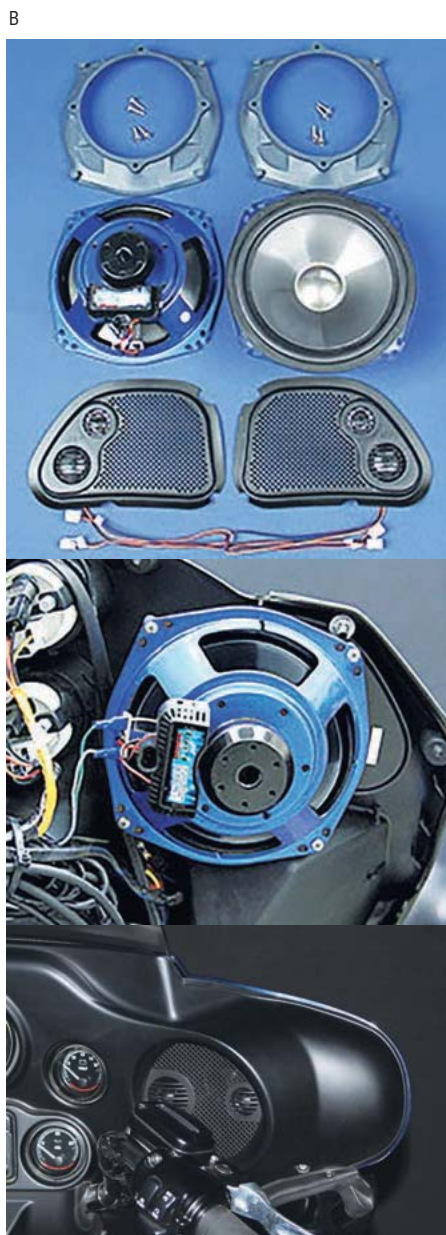
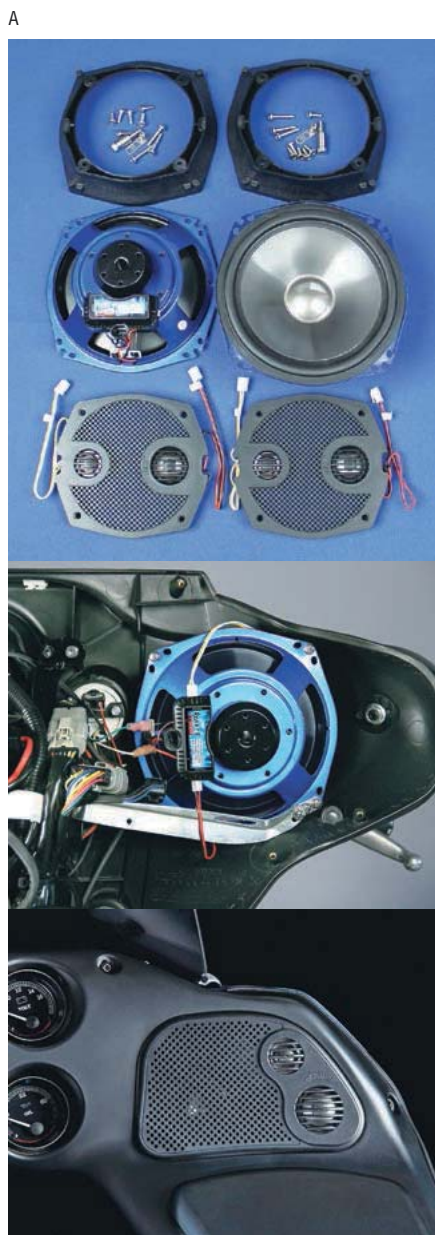

# ROKKER® SERIES SPEAKER KITS



## XT SERIES

- The new three-way high-performance speaker set has been designed specifically for the rear pod position on the 2006-2013 FLHTCU/FLHTK
- Spec'd at 2 ohms impedance and 140+ watts max power
- Superior bass response, along with an extended mid/high frequency range
- Waterproof injection-molded polycarbonate woofer cone
- High-flux strength but light-weight Neodymium magnet
- High efficiency voice coil
- The latest design grillwork with mounted black-titanium tweeter and midrange drivers
- Second set of paintable grills also included
- Plug-and-play installation complete with easy to follow instructions
- Perform extremely well with the stock Harley radio system
- You won't be disappointed

## XX SERIES

- Lightweight waterproof one-piece woven-fiber driver cone
- High-output silk-dome tweeter
- Super high-density lite-weight Neodymium magnet structure, specially coated to maintain flux-strength integrity even at extreme operating temperatures
- High efficiency VENTED voice-coil & magnet structure for improved cooling when operating at high volume levels for extended periods
- Custom max-flow speaker grills for crystal clear sound at highway speeds
- Plug-and-play no-modification solution complete with easy to follow installation instructions
- These are THE most powerful speakers you can buy for your Harley and they will perform extremely well when used with a medium to high-powered accessory amplifier

## XXR SERIES

- Spec'd at 2 ohms impedance and an impressive 300 watts maximum input (175w RMS - 91db sensitivity)
- High-density lite-weight Neodymium magnet structure, specially coated to maintain flux-strength integrity even at extreme operating temperatures
- Custom bridge-mounted high-output tweeter

**These are THE most powerful 5X7" speakers you can buy for your Harley and they will perform extremely well when used with a medium to high-powered accessory amplifier.**



A



B



C



D



A



B



C



D



E



F



G



G



E



F

Application	Description	WPS#
A '06-UP models w/hard saddlebags	XXR series speaker upgrade kit	<b>94-1350</b>
B '06-13 FLHTCU	XT series Rear Speaker Kit	<b>94-1233</b>
D '06-13 models with lower fairings	XX series 7.25 Lower Fairing	<b>94-1225</b>
E '98-13 FLTR models	XX series Speaker Grills	<b>94-1227</b>
F '98-13 FLH models w/ fairing	XX series Speaker Grills	<b>94-1221</b>
'98-13 models w/ hard saddlebags	XXR series 5X7 Saddlebag Lid Speaker Kit	<b>94-1351</b>
'14-UP models w/ hard saddlebags	XXR series 5X7 Saddlebag Lid Speaker Kit	<b>94-1352</b>
G '98-13 FLH/FLTR models w/ fairing	Tweeter Kit	<b>94-1232</b>

- WINDSHIELDS / FAIRINGS
- AUDIO / COMMUNICATION
- SEATS / LUGGAGE
- BARS / MIRRORS / CONTROLS
- EXHAUST
- AIR / FUEL SYSTEMS
- ENGINE
- TRANSMISSION / DRIVELINE
- GASKETS / SEALS
- ELECTRICAL
- LIGHTING
- CABLES
- BRAKES
- OIL FILTERS
- SUSPENSION
- BODY
- WHEELS
- TIRES / TIRE ACC.
- BIKE ACC.
- VICTORY / INDIAN
- COVERS / LOCKS / TIEDOWNS
- CHEMICALS
- TOOLS
- HELMETS
- HELMET ACC.
- EYEWEAR
- APPAREL / RIDER ACC.
- PROMOTIONAL
- REFERENCE
- INDEX

- WINDSHIELDS / FAIRINGS
- AUDIO / COMMUNICATION**
- SEATS / LUGGAGE
- BARS / MIRRORS / CONTROLS
- EXHAUST
- AIR / FUEL SYSTEMS
- ENGINE
- TRANSMISSION / DRIVELINE
- GASKETS / SEALS
- ELECTRICAL
- LIGHTING
- CABLES
- BRAKES
- OIL FILTERS
- SUSPENSION
- BODY
- WHEELS
- TIRES / TIRE ACC.
- BIKE ACC.
- VICTORY / INDIAN
- COVERS / LOCKS / TIEDOWNS
- CHEMICALS
- TOOLS
- HELMETS
- HELMET ACC.
- EYEWEAR
- APPAREL / RIDER ACC.
- PROMOTIONAL
- REFERENCE
- INDEX



# ROKKER® WIRING HARNESSES

- Plug-n-play wiring harness kit connects to lower fairing mounted speakers
- Designed for ROKKER XTP or Performance series amplifier kits
- Kits include exact factory spec wire color coding & plugs for all harness connections



A



B



C



D



E

Application	Description	WPS#
A '14-18 FLHX/FLHTCU/FLHTK	XX Series lower fairing speaker wiring harness	94-1260
B '14-18 FLHX/FLHTCU/FLHTK	XT Series saddlebag lid wiring harness	94-1261
C '14-18 FLHX/FLHTCU/FLHTK/FLTR	XT In-Series upper to lower fairing wiring harness	94-1223
D '06-13 Harley FLT/FLH models	In-Series lower fairing speaker wiring harness	94-1262
E '98-13 Harley FLT/FLH models	XX Series saddlebag Lid or Rear-Pod speaker wiring harness	94-1259

## ACOUSTIC SPEAKER PADS

- Tighten-up-the-bass
- Improve the overall sound quality of your fairing mounted speakers
- These special acoustic foam pads are die-cut with adhesive installed
- Installation is a snap, kit includes complete and detailed installation instructions



A



B

Application	WPS
A '98-13 models w/ FLH fairing	94-1235
B '98-13 FLTR	94-1236

## SINGLE & DOUBLE DIN INSTALL KITS NEW

- Hi Temp factory grade ASA material
- 16 Gauge galvanized metal brackets
- Includes handle bar interface
- Includes antenna adapter
- Includes all parts and interfaces necessary for aftermarket stereo installation.



Application	Description	WPS#
'14-18 FLHX/FLHTCU/FLHTK/FLTR	Double DIN Install Kit	<b>194-01000</b>
	Single DIN Install Kit	<b>194-01001</b>
'98-13 Harley FLT/FLH models	Single DIN Install Kit	<b>194-01002</b>

## AMP INSTALL KITS NEW

- 6 ft 8 or 10 gauge power and ground with nylon mesh cover
  - Works with Harman Kardon system
- Includes:
- Speaker wire, remote turn on wire
  - Weather proof fuse holder
  - All required hardware



Application	Description	WPS#
Harman Kardon Systems	8 Gauge Amp Install Kits	<b>194-01003</b>
	10 Gauge Amp Install Kits	<b>194-01004</b>



- WINDSHIELDS / FAIRINGS
- AUDIO / COMMUNICATION**
- SEATS / LUGGAGE
- BAR / MIRRORS / CONTROLS
- EXHAUST
- AIR / FUEL SYSTEMS
- ENGINE
- TRANSMISSION / DRIVELINE
- GASKETS / SEALS
- ELECTRICAL
- LIGHTING
- CABLES
- BRAKES
- OIL FILTERS
- SUSPENSION
- BODY
- WHEELS
- TIRES / TIRE ACC.
- BIKE ACC.
- VICTORY / INDIAN
- COVERS / LOCKS / TIEDOWNS
- CHEMICALS
- TOOLS
- HELMETS
- HELMET ACC.
- EYEWEAR
- APPAREL / RIDER ACC.
- PROMOTIONAL
- REFERENCE
- INDEX

## AUDIO HARNESSSES NEW

- 194-01043 Plugs into factory harness for use with aftermarket speakers.
- 194-01041 includes 4 x 16 gauge speaker wires
- 194-01040 includes 2 x 12 gauge power & ground wires, 4 x 16 gauge speaker wires, 2 x 18 gauge accessory wires
- All wires made of oxygen free copper

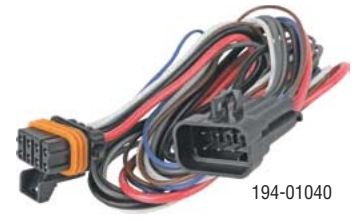

194-01040



194-01043

194-01041

194-01042

Application	Description	WPS#
Fits Touring Models '14-18	Front Speaker Harness	<b>194-01043</b>
Universal	8 Pin Audio Harness 36"	<b>194-01040</b>
	4 Pin Speaker Harness 10"	<b>194-01041</b>
	4 Pin Speaker Harness 10" (pr)	<b>194-01042</b>

## SPEAKER ADAPTERS NEW

Front speaker adapters fit most 6.75" aftermarket speakers. Shallow design for oversized depth. Include weatherproof gasket and hardware. Rear speaker adapters are for Boom Audio lids and convert 5x7 to 6x9 speakers and include hardware.



194-01020

194-01021

Application	Description	WPS#
Fit Touring Models '96-13	Front Speaker Adapter Rings 6.75"	<b>194-01020</b>
Fit Touring Models '06-13	Saddlebag Lid Speaker Adapters 5x7 to 6x9	<b>194-01021</b>

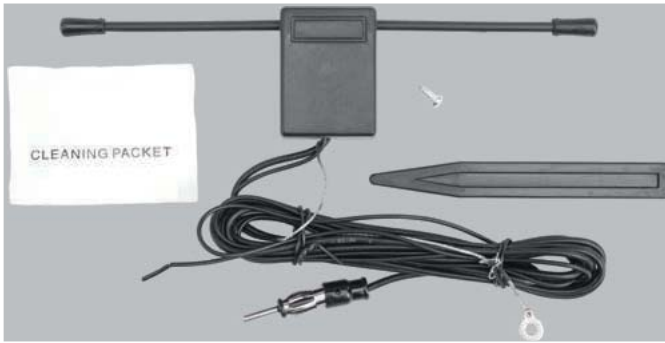

**FAIRING ANTENNA** **NEW**

- Universal amplified FM antenna

Application	Description	WPS#
Universal	Fairing Antenna	194-01030



**USB AUX INPUT** **NEW**

- Relocates AUX & USB from rear of aftermarket radio
- Can mount in cigarette lighter socket
- 1 inch diameter mounting hole
- Charges your device or play music through your stereo

Application	Description	WPS#
Universal	Aux and USB Input 3.5mm	194-01035



**SPEAKER CLOTH** **NEW**

Water repellant speaker cloth, to protect your speakers without compromising sound quality. Two sheets of 13" x 13" cloth.

Application	Description	WPS#
Universal	Hydrophobic Speaker Cloth	194-01050

WINDSHIELDS / FAIRINGS

AUDIO / COMMUNICATION

SEATS / LUGGAGE

BAR / MIRRORS / CONTROLS

EXHAUST

AIR / FUEL SYSTEMS

ENGINE

TRANSMISSION / DRIVELINE

GASKETS / SEALS

ELECTRICAL

LIGHTING

CABLES

BRAKES

OIL FILTERS

SUSPENSION

BODY

WHEELS

TIRES / TIRE ACC.

BIKE ACC.

VICTORY / INDIAN

COVERS / LOCKS / TIEDOWNS

CHEMICALS

TOOLS

HELMETS

HELMET ACC.

EYEWEAR

APPAREL / RIDER ACC.

PROMOTIONAL

REFERENCE

INDEX



## HEAVY DUTY SUPPORT BRACKETS

- Made from thicker gauge steel to eliminate breaking
- Ideal for bikes equipped with amp and speaker upgrades
- Sold in sets

Application	Description	WPS#
A '93-13 FLHT, FLHX Models	Speaker Support Brackets	<b>820-52353</b>
B '93-13 FLHT, FLHX Models	Fairing Support Brackets	<b>820-52354</b>



A



B



- WINDSHIELDS / FAIRINGS
- AUDIO / COMMUNICATION**
- SEATS / LUGGAGE
- BAR / MIRRORS / CONTROLS
- EXHAUST
- AIR / FUEL SYSTEMS
- ENGINE
- TRANSMISSION / DRIVELINE
- GASKETS / SEALS
- ELECTRICAL
- LIGHTING
- CABLES
- BRAKES
- OIL FILTERS
- SUSPENSION
- BODY
- WHEELS
- TIRES / TIRE ACC.
- BIKE ACC.
- VICTORY / INDIAN
- COVERS / LOCKS / TIEDOWNS
- CHEMICALS
- TOOLS
- HELMETS
- HELMET ACC.
- EYEWEAR
- APPAREL / RIDER ACC.
- PROMOTIONAL
- REFERENCE
- INDEX



# BIG BIKE PARTS®

## SOUND SYSTEM

- Waterproof 2½" chrome speakers and 40 watt amplifier provide excellent sound quality
- Chrome 7/8" and 1" handlebar and universal mirror mounts included
- Waterproof volume control with 3.5mm universal input is compatible with most all portable sound and radio systems

**WPS#**

Black	<b>94-13250BK</b>
Chrome	<b>94-13250A</b>



## BLUETOOTH SOUND SYSTEM

- Bluetooth technology handlebar stereo system
- Includes 2½" waterproof speakers and 40 watt waterproof amplifier
- Includes 3 mounting options: 7/8" to 1" handlebar mounts, mirror mounts and surface bracket
- Universal 3.5mm aux. in for non-Bluetooth use (iPod, MP3, MP4, satellite radio etc.)

**Description WPS#**

Black	<b>94-13252BK</b>
Chrome	<b>94-13252C</b>



- WINDSHIELDS / FAIRINGS
- AUDIO / COMMUNICATION**
- SEATS / LUGGAGE
- BARS / MIRRORS / CONTROLS
- EXHAUST
- AIR / FUEL SYSTEMS
- ENGINE
- TRANSMISSION / DRIVELINE
- GASKETS / SEALS
- ELECTRICAL
- LIGHTING
- CABLES
- BRAKES
- OIL FILTERS
- SUSPENSION
- BODY
- WHEELS
- TIRES / TIRE ACC.
- BIKE ACC.
- VICTORY / INDIAN
- COVERS / LOCKS / TIEDOWNS
- CHEMICALS
- TOOLS
- HELMETS
- HELMET ACC.
- EYEWEAR
- APPAREL / RIDER ACC.
- PROMOTIONAL
- REFERENCE
- INDEX



## HANDLEBAR SPEAKER SYSTEMS

### MC650B

- 1200 watts max power
- Bluetooth® audio streaming stream and control your favorite music apps
- Weatherproof
- 3" speakers (2 pairs) Matte Black or Chrome
- 4-ch compact amplifier
- 3.5mm aux input
- In-line volume control
- Adjustable brackets



Color	WPS#
Chrome	63-8032
Black	63-8033

### MC600B

- 800 watts max power
- Bluetooth® audio streaming stream and control your favorite music apps
- Weatherproof
- 2pc 3" speakers Matte Black or Chrome
- 2-ch compact amplifier
- 3.5mm aux input
- In-line volume control
- Adjustable brackets



Color	WPS#
Chrome	63-8030
Black	63-8031

### MC520

- 600 watts max power
- FM tuner
- Bluetooth® audio streaming stream and control your favorite music apps
- Weatherproof
- 2pc 3" speakers Matte Black or Chrome
- 2 ch compact amplifier
- USB and SD ports
- 3.5mm aux input
- Remote control (RF)
- Rubber cover to protect control panel from the elements
- Adjustable brackets



Color	WPS#
Chrome	63-8028
Black	63-8029

WINDSHIELDS / FAIRINGS  
 AUDIO / COMMUNICATION  
 SEATS / LUGGAGE  
 BARS / MIRRORS / CONTROLS  
 EXHAUST  
 AIR / FUEL SYSTEMS  
 ENGINE  
 TRANSMISSION / DRIVELINE  
 GASKETS / SEALS  
 ELECTRICAL  
 LIGHTING  
 CABLES  
 BRAKES  
 OIL FILTERS  
 SUSPENSION  
 BODY  
 WHEELS  
 TIRES / TIRE ACC.  
 BIKE ACC.  
 VICTORY / INDIAN  
 COVERS / LOCKS / TIEDOWNS  
 CHEMICALS  
 TOOLS  
 HELMETS  
 HELMET ACC.  
 EYEWEAR  
 APPAREL / RIDER ACC.  
 PROMOTIONAL  
 REFERENCE  
 INDEX



## HANDLEBAR SPEAKER SYSTEMS



### MC470

- 1000 watts max power
- Bluetooth® audio streaming stream and control your favorite music apps
- Weatherproof
- 3" speakers (2 pairs) Matte Black or Chrome
- 4-ch compact amplifier
- 3.5mm aux input
- In-line volume control
- Adjustable brackets

Color	WPS#
Chrome	63-8026
Black	63-8027



### MC420B

- 600 watt max power
- Bluetooth® audio streaming stream and control your favorite music apps
- Available in chrome and black
- Weatherproof
- 3" chrome speakers
- 2 channel compact amplifier
- 3.5mm aux input
- Volume control
- Adjustable brackets

Description	Color	WPS#
600 Watt BT All Terrain Sound System	Chrome	63-8022
600 Watt BT All Terrain Sound System	Black	63-8023

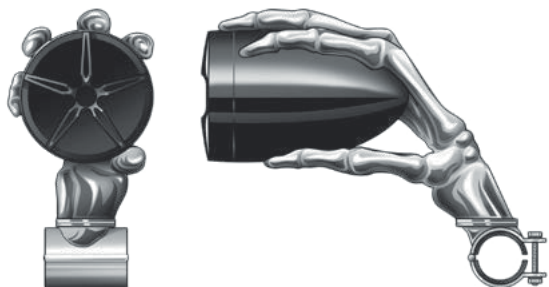

### MCB700SK

- 800 watts max power
- Bluetooth® audio streaming stream and control your favorite music apps
- Weatherproof
- 3" matt black speakers (pair)
- 2-ch compact amplifier
- In-line multi-function control
- Chrome/Black
- Adjustable mounting system

WPS#
63-8034

## BOSS BLUETOOTH® CONTROLLERS UNIVERSAL BLUETOOTH® CONTROLLERS



- Compatible with any amplifier with RCA inputs
- Bluetooth® A2DP wireless audio streaming, stream and control your favorite music apps
- Easy pairing with auto re-connect
- 2 pre-amp outputs
- Remote turn-on output
- 3.5mm aux-input
- USB charging (1a)
- Weather resistant
- IPX5\* weather resistant housing
- Controls: play / pause, track (next/previous), volume up/down
- Backlit illumination
- Soft touch buttons
- Multi-mount system: surface mount, flush mount or handle bar clamp

Description	WPS#
A Bluetooth 150w Amplified Bluetooth	63-8046
B Bluetooth	63-8047
B Bluetooth	63-8048

WINDSHIELDS / FAIRINGS

AUDIO / COMMUNICATION

SEATS / LUGGAGE

BARS / MIRRORS / CONTROLS

EXHAUST

AIR / FUEL SYSTEMS

ENGINE

TRANSMISSION / DRIVELINE

GASKETS / SEALS

ELECTRICAL

LIGHTING

CABLES

BRAKES

OIL FILTERS

SUSPENSION

BODY

WHEELS

TIRES / TIRE ACC.

BIKE ACC.

VICTORY / INDIAN

COVERS / LOCKS / TIEDOWNS

CHEMICALS

TOOLS

HELMETS

HELMET ACC.

EYEWEAR

APPAREL / RIDER ACC.

PROMOTIONAL

REFERENCE

INDEX



## BARNACLE WATERPROOF WIRELESS SPEAKER

Now you have a Bluetooth enabled speaker you can take with you anywhere to do anything! Utilizing Bluetooth 2.0 technology, your device can be up to 30 feet away in case you want to store your device in a secure location while listening to music and taking phone calls. Or, with the Plus model, you can store up to 1000 songs and not have to worry about using a phone to play music. The Barnacle speaker is waterproof, dust proof, and has the capability to answer phone calls. The speaker that is action sport capable.

- Barnacle Plus model has 4GB of storage which will store up to 1000 songs
- Barnacle Plus does not require the use of a phone or Bluetooth to play stored songs
- Durable suction cup allows the Barnacle to be mounted directly on smooth flat surfaces
- IPX68 waterproofing, when power port flap is closed, the Barnacle will withstand depth up to 6 feet for up to 60 minutes
- Fully dust proof for days on the beach, track, desert, woods, etc
- Perfect speaker for working in the garage and in the trailer
- Easy to use, turn the Barnacle on, activate the Bluetooth feature on your phone, sync the two and start listening to music
- Built in microphone for taking hands free calls
- Lasts up to 5 hours once fully charged
- Includes micro usb cable for charging
- Not intended for long term use underwater
- Handlebar mount works for 7/8" diameter bars
- Board mount has adhesive pad for flat surfaces and will lock Barnacle in place



13-0914



13-0900



13-0910



13-0904



13-0901/13-0912



13-0902



13-0903



13-0915



13-0905/13-0913



13-0906/13-0911

Color	Barnacle	Barnacle Plus
Black Pearl	<b>13-0900</b>	
Manta Ray Black		<b>13-0910</b>
The Pearl	<b>13-0904</b>	
Aloha Blue	<b>13-0901</b>	<b>13-0912</b>
Sea Foam	<b>13-0902</b>	
Coral	<b>13-0903</b>	
Callinan Pro Model		<b>13-0915</b>
Kalani Pro Model		<b>13-0914</b>
Koa Pro Model	<b>13-0905</b>	<b>13-0913</b>
Quincy Pro Model	<b>13-0906</b>	<b>13-0911</b>

## HANDLEBAR MOUNTS

- Handlebar mount works for 7/8" diameter bars

Description	Color	WPS#
7/8" Bar Mount	Black	<b>13-0919</b>
Flat Surface Mount	Black	<b>13-0917</b>
Flat Surface Mount	White	<b>13-0918</b>



13-0919



13-0917



13-0918

## ELITE SERIES HELMET HEADSETS



Description	WPS#
A Full-face style	94-1340
B Shorty style	94-1341
C Custom open face/flip style	94-1342
D Open/Flip/Full-face style	94-1343
E Arai-cl/KBC-tk	94-1267
F Shorty slide-in style	94-1344
G Nolan N103/43/90/91	94-1345
Replacement wind sock kit for Aeromike III/V/VI	94-1237

- New hi-intensity mount-in-helmet speakers
- Extra hi-output AeroMike VI
- Ultra-durable Z-Series upper cord
- Easy connection to all factory audio systems using correct lower cord
- Proudly made in the USA



- WINDSHIELDS / FAIRINGS
- AUDIO / COMMUNICATION
- SEATS / LUGGAGE
- BARS / MIRRORS / CONTROLS
- EXHAUST
- AIR / FUEL SYSTEMS
- ENGINE
- TRANSMISSION / DRIVELINE
- GASKETS / SEALS
- ELECTRICAL
- LIGHTING
- CABLES
- BRAKES
- OIL FILTERS
- SUSPENSION
- BODY
- WHEELS
- TIRES / TIRE ACC.
- BIKE ACC.
- VICTORY / INDIAN
- COVERS / LOCKS / TIEDOWNS
- CHEMICALS
- TOOLS
- HELMETS
- HELMET ACC.
- EYEWEAR
- APPAREL / RIDER ACC.
- PROMOTIONAL
- REFERENCE
- INDEX

WINDSHIELDS / FAIRINGS  
 AUDIO / COMMUNICATION  
 SEATS / LUGGAGE  
 BARS / MIRRORS / CONTROLS  
 EXHAUST  
 AIR / FUEL SYSTEMS  
 ENGINE  
 TRANSMISSION / DRIVELINE  
 GASKETS / SEALS  
 ELECTRICAL  
 LIGHTING  
 CABLES  
 BRAKES  
 OIL FILTERS  
 SUSPENSION  
 BODY  
 WHEELS  
 TIRES / TIRE ACC.  
 BIKE ACC.  
 VICTORY / INDIAN  
 COVERS / LOCKS / TIEDOWNS  
 CHEMICALS  
 TOOLS  
 HELMETS  
 HELMET ACC.  
 EYEWEAR  
 APPAREL / RIDER ACC.  
 PROMOTIONAL  
 REFERENCE  
 INDEX



## PERFORMANCE SERIES HELMET HEADSETS

- Full face helmet models feature our AeroMike III miniature chin-bar microphone cartridge
- All models except full face feature our high-output AeroMike III miniature boom microphone
- Tuned for use with all factory installed motorcycle audio systems
- Two wide-fidelity helmet speakers in stereo
- Universal clamp-on mounting system
- Upper section (only) P-series 8-pin right-angle hook-up cord
- Superior ambient noise canceling and wind blocking ability
- These headsets can be connected to any factory installed motorcycle audio system, now and in the foreseeable future, just by interchanging the lower-section hook-up cord

	Description	WPS#
A	Headset for most Full-face style helmets	94-1238
B	Headset for most Flip/Modular style helmets	94-1239
C	Headset for most Open-face style	94-1240
D	Headset for half helmets w/ Flip down visor	94-1241
E	High-output AeroMike III "Boom Only"	94-1242
F	Headset for Open/Flip/Full-face style	94-1243
G	Integrated headset for Nolan helmets	94-1244
H	Integrated Slide-in for most Half helmets	94-1245
	Replacement wind sock kit for Aeromike III/V/VI	94-1237
	Performance Series Headset Universal	94-1347





## HEADSET REPLACEMENT PARTS

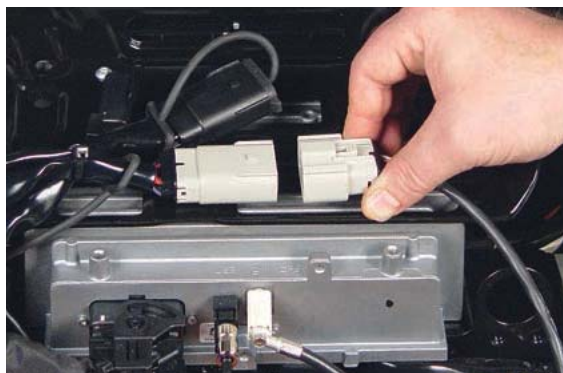

	Description	WPS#
<b>P-SERIES HEADSET CORD</b>		
A	Upper section 8-pin right angle cord	94-1205
B	Lower section 8-pin cord for '98-15 Harley 7-pin systems	94-1210
<b>Z-SERIES HEADSET CORD</b>		
C	Upper section 8-pin right angle cord	94-1206
D	Lower section 8-pin cord for '98-15 Harley 7-pin systems	94-1216
	Lower cord Elite Harley '06-18 7 pin	94-1346
<b>SOLO HEADSET CONNECTION CABLE</b>		
E	Headset connection harness kit for '14-15 FLHX and '15 FLTR	94-1246



## HIDE - A - WAY ANTENNA

- FLEXPPOWER hide-a-way is the best way to hide the CB and radio antennas on the market today
- Eliminate the rear mounted antennas on your Harley
- J&M in-fairing antenna is pre-tuned from our factory
- Is designed for the Harley Batwing or Road Glide fairing, with the factory Harley CB and/or radio
- Installation is a snap, as there are no wires to cut or splice and antenna wire lead is secured in the fairing with included double sided tape clips

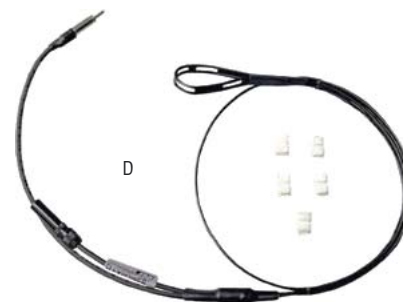
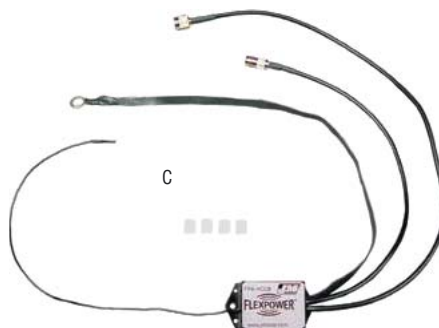

Application	Description	WPS#
A '14-17 FLH models w/ CB antenna	CB fairing antenna	94-1202
B '14-17 Touring models w/ radio	AM/FM/WB fairing antenna	94-1203
C '06-13 Touring models w/ CB antenna	CB fairing antenna	94-1201
D '89-13 Touring models w/ radio	AM/FM/WB fairing antenna	94-1204

- WINDSHIELDS / FAIRINGS
- AUDIO / COMMUNICATION
- SEATS / LUGGAGE
- BARS / MIRRORS / CONTROLS
- EXHAUST
- AIR / FUEL SYSTEMS
- ENGINE
- TRANSMISSION / DRIVELINE
- GASKETS / SEALS
- ELECTRICAL
- LIGHTING
- CABLES
- BRAKES
- OIL FILTERS
- SUSPENSION
- BODY
- WHEELS
- TIRES / TIRE ACC.
- BIKE ACC.
- VICTORY / INDIAN
- COVERS / LOCKS / TIEDOWNS
- CHEMICALS
- TOOLS
- HELMETS
- HELMET ACC.
- EYEWEAR
- APPAREL / RIDER ACC.
- PROMOTIONAL
- REFERENCE
- INDEX

- WINDSHIELDS / FAIRINGS
- AUDIO / COMMUNICATION**
- SEATS / LUGGAGE
- BAR / MIRRORS / CONTROLS
- EXHAUST
- AIR / FUEL SYSTEMS
- ENGINE
- TRANSMISSION / DRIVELINE
- GASKETS / SEALS
- ELECTRICAL
- LIGHTING
- CABLES
- BRAKES
- OIL FILTERS
- SUSPENSION
- BODY
- WHEELS
- TIRES / TIRE ACC.
- BIKE ACC.
- VICTORY / INDIAN
- COVERS / LOCKS / TIEDOWNS
- CHEMICALS
- TOOLS
- HELMETS
- HELMET ACC.
- EYEWEAR
- APPAREL / RIDER ACC.
- PROMOTIONAL
- REFERENCE
- INDEX



## SHORTY ANTENNA UPGRADE

- If you are looking for THE Best performing shorty antenna upgrade look no further than J&M
- This new shorty antenna model from J&M comes out of the packaged pre-tuned for all AM/FM CB & WB frequencies, so that you don't need to worry about which side of the tail trunk or rear fender to mount them on
- The performance improvement compared to stock Harley is especially significant for the CB radio band transmission distance
- Installation is a snap as you simply unscrew the stock Harley antenna and screw on the new J&M shorty
- Both long and short antenna tip cover options are included, with a total overall length of approximately 17"
- Sold individually as one antenna per package with extra screw in trunk mounting stud included

Application	WPS#
'14-17 FLHT/FLT models	<b>94-1199</b>
'09-13 FLHT/FLT models	<b>94-1198</b>
'89-08 FLHT/FLT models	<b>94-1200</b>





# SENA 30K

## **NEW** Bluetooth™ 4.1 MOTORCYCLE COMMUNICATION SYSTEM

Sena Mesh Intercom™ technology is now here and ready to change your ride. Simply press the button on top of the 30K to turn on public mode, and you will be automatically and instantaneously connected to a virtually limitless amount of 30K users within a mile range. Intercom connections are also now more stable than ever with Sena's new Mesh Intercom™ technology. When one of a group's riders goes out of range, the rest of the group remains seamlessly connected while the 30K still intelligently searches for the lost connection and reconnects automatically once back in range. No longer will you have to worry about losing half of your group due to a Bluetooth chain linked connection of the past. With private mode you can invite and communicate with up to 16 riders at a range of up to 2.0 km (1.2 miles), while an endless amount of guests can join to listen in as well. When riding with 5 or more riders, the Mesh Intercom will intelligently keep the group connected at a range of up to 8 km in ideal riding environments (5 miles).



### FEATURES

- Mesh Intercom™
- Bluetooth 4.1
- Audio Multitasking
- Voice command
- Intercom 2 km / 1.2 miles
- Multi-way group intercom
- Advance noise control™
- FM Radio
- Remote Control
- Sena 30K Utility App and Sena RideConnected App (for iPhone and Android)



Description	WPS#
Single	843-01230
Dual pack	843-01231

# SENA 20S EVO

## Bluetooth™ 4.1 MOTORCYCLE COMMUNICATION SYSTEM

(AVAILABLE W/ STANDARD OR SLIM SPEAKER KIT )

The 20S EVO is the next generation of the original 20S, with an updated design and improved intercom functionality and stability to keep up with your ride. The 20S EVO was designed with a fixed type, shark fin antenna as opposed to its predecessor with the flip up antenna. This sleek new antenna design improves upon intercom stability and even secures the intercom distance while updates to the hardware allow for an even more robust general performance updates.



### FEATURES

- Bluetooth® 4.1
- Audio multitasking
- Eight-way universal group intercom with ranges up to 2.0 km (1.2 miles)
- Voice command
- Advanced noise Control™
- FM radio
- Remote control

### 20S SLIM

#### FEATURES

- Same benefits and features as 20S Evo
- Slim speakers for helmets with shallow speaker pockets
- Flip-up antenna



A	20S EVO	WPS#
	Single Pack	843-01240
	Dual Pack	843-01241
B	20S SLIM	
	Single Pack	843-01098

- WINDSHIELDS / FAIRINGS
- AUDIO / COMMUNICATION
- SEATS / LUGGAGE
- BARS / MIRRORS / CONTROLS
- EXHAUST
- AIR / FUEL SYSTEMS
- ENGINE
- TRANSMISSION / DRIVELINE
- GASKETS / SEALS
- ELECTRICAL
- LIGHTING
- CABLES
- BRAKES
- OIL FILTERS
- SUSPENSION
- BODY
- WHEELS
- TIRES / TIRE ACC.
- BIKE ACC.
- VICTORY / INDIAN
- COVERS / LOCKS / TIEDOWNS
- CHEMICALS
- TOOLS
- HELMETS
- HELMET ACC.
- EYEWEAR
- APPAREL / RIDER ACC.
- PROMOTIONAL
- REFERENCE
- INDEX

# SENA

## ACCESSORIES

Description	WPS#
A Mounting Accessories	843-01042
B Universal Helmet Clamp Kit w/Microphones	843-01043
Universal Helmet Clamp Kit w/Slim Speakers	843-01048
C USB Power Cable (Micro-USB Type)	843-01056
D Microphone Sponges 5/PK	843-01214
E Boom Microphone	843-01132
F Wired Boom Microphone	843-01133
G Wired Microphone	843-01134
H 20S EVO / 20S Speakers	843-01045



A



B



C



D



E



F



G

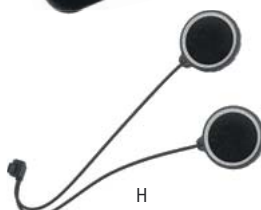

H

## Bluetooth™ 4.1 **SENA 20S**

### HELMET CLAMP KITS FOR HARLEY DAVIDSON AND UNIVERSAL SLIM SPEAKER KITS

#### HD SPEAKERS

The 20S Clamp Kit for CB/Audio Systems allows users to communicate through the motorcycles CB radio and listen to the onboard audio system.

#### FEATURES

- Communicate with the CB radio built into the onboard audio system using the clamp kits microphone. Simply push the PTT button connected to a Harley-Davidson motorcycle to say something through the CB radio.
- All sounds (including CB radio, GPS navigation or FM radio) from the onboard audio system can be mixed with 20S sound sources (intercom, MP3 music, phone etc.) This 20s clamp kit can connect to Harley-Davidson onboard audio system by the adaptor cable.
- You can use the CB/Audio Helmet Clamp with the 20S main module. Without the 20S main module, you can have the helmet clamp with the clamp cover adaptor attached and only use the CB radio and onboard audio system.
- Comes with 2 microphones included (wired boom mic and fixed boom mic)



**RIDE CONNECTED**  
mobile APP available

Description	WPS#
20S Clamp Kit for CB/Audio for Harley-Davidson	843-01044
20S Clamp kit for CB/Audio for Honda Goldwing	843-01135



RIDE CONNECTED  
mobile APP available



# SENA 10S

## Bluetooth™ 4.1 HEADSET AND INTERCOM

The Sena 10S Motorcycle Bluetooth® Communication System is an upgraded version of the original SMH10 system, which has proven itself roadworthy to motorcyclists everywhere. Now in a slimmer profile, the 10S maximizes the enjoyment factor of your ride by keeping you in touch with up to four riding companions via crystal-clear HD audio, up to 1.6 km (1 mile) away, through the One Touch Group Intercom™, the 10S is the best long range Bluetooth headset. The unit also uses the Universal Intercom™ protocol so it can communicate with all Sena motorcycle Bluetooth headsets and non-Sena Bluetooth headsets on the market.



### FEATURES

- Bluetooth 4.1
- Universal 4-way group intercom with ranges up to 1.6 km / 1 mile
- Smartphone app
- Advanced noise control™
- Voice prompts
- Versatile job dial
- FM Radio

Description	WPS#
Single Pack	843-01027
Dual Pack	843-01028

### ACCESSORIES

Description	WPS#
Supplies kit	843-01190
Speakers	843-01191
Helmet clamp kit	843-01192
Wired Boom Microphone	843-01194
Wristband Remote	843-01182
10S helmet clamp kit for Bell Mag-9	843-01196

# SENA 10R



## Bluetooth™ 4.1 HEADSET AND INTERCOM

Low profile, yet rich with high-performance features, the Sena 10R lets riders make hands-free phone calls, listen to music, get GPS directions, and have full-duplex intercom conversations with other riders in crystal-clear audio quality through the stereo Bluetooth® headset. Ultra slim and featherlight, it's a particularly good choice for riders who want to concentrate on their riding technique and minimize fuss factor.



### FEATURES

- Bluetooth 4.1
- Universal 4-way group intercom with ranges up to 900 m / 1/2 mile
- Music sharing
- Voice prompts
- FM Radio
- Advance noise control™
- Light weight and ultra slim
- Ease of use with or without remote control

### INCLUDED:

**Bluetooth® Handlebar Remote Control.**

The innovative Bluetooth® Handlebar Remote puts the controls where you can easily see and use them with a gloved hand, without interrupting the rhythm and safety of your ride.

### ACCESSORIES

Description	WPS#
10R Single Pack w/remote	843-01025
10R Single Pack w/o remote	843-01024
10R Dual w/o remote	843-01023

Description	WPS#
10R Supplies Kit	843-01125
Battery Pack	843-01129
Wired Boom Microphone	843-01127

Description	WPS#
Wired Microphone	843-01128
Earbud Adapter Cable	843-01026
10R Speakers	843-01126

- WINDSHIELDS / FAIRINGS
- AUDIO / COMMUNICATION
- SEATS / LUGGAGE
- BARS / MIRRORS / CONTROLS
- EXHAUST
- AIR / FUEL SYSTEMS
- ENGINE
- TRANSMISSION / DRIVELINE
- GASKETS / SEALS
- ELECTRICAL
- LIGHTING
- CABLES
- BRAKES
- OIL FILTERS
- SUSPENSION
- BODY
- WHEELS
- TIRES / TIRE ACC.
- BIKE ACC.
- VICTORY / INDIAN
- COVERS / LOCKS / TIEDOWNS
- CHEMICALS
- TOOLS
- HELMETS
- HELMET ACC.
- EYEWEAR
- APPAREL / RIDER ACC.
- PROMOTIONAL
- REFERENCE
- INDEX

# SENA 10C Bluetooth™ 4.1

## COMMUNICATION SYSTEM WITH BUILT IN ACTION CAMERA

The 10C is the world's first look at a fully integrated Bluetooth helmet communication system and HD camera rolled into one powerful device. It's capable of full HD video (1080p:30fps and 720p:30/60fps) with 3.5 MP still shot image capture and shot, burst and time-lapse photo modes. Built to handle with ease the rigorous demands of outdoor sports, motorsports, and first responders, it is the complete solution for in-helmet communication and action videography under challenging conditions.



RIDE CONNECTED  
mobile APP available



### FEATURES

- Bluetooth 4.1
- Unibody design
- Universal 4-way group intercom up to 1.6 km / 1 mile
- Lens rotation up to 30°
- Voice prompts
- Smart audio mix
- Advance noise control™
- FM Radio
- Use with or without remote control (sold separate)

### WPS #

843-01031

### ACCESSORIES

Description	WPS#
Mounting accessory kit	843-01036
Supplies kit	843-01037
Speakers	843-01038
Helmet clamp kit	843-01039
Wired boom microphone	843-01018
Lens caps 3pk	843-01021
Earbud adapter cable	843-01029



### MICRO SD CARDS

Description	WPS#
8 GB	510-1510
16 GB	510-1511
32 GB	510-1512
64 GB	510-1513



# SENA 10U HEADSET

## Bluetooth™ 4.1 MOTORCYCLE COMMUNICATION SYSTEM WITH HANDLEBAR REMOTE CONTROL

The Sena 10U motorcycle Bluetooth communication system delivers audiophile-worthy performance for your tunes and conversations in a stealthy setup that fits completely within the interior recesses of some of the world's best helmets. Currently the 10U System is available in 5 different models for the Shoei GT-Air, Neotec and J-Cruise and Arai full-face helmets, with more to come in the future.



### FEATURES

- Bluetooth 4.1
- Invisible beauty
- Universal 4-way group intercom up to 1.6 km / 1 mile
- Remote control
- FM Radio
- Music sharing
- Advanced noise control™
- Voice prompts



Included



Description	WPS #
SENA 10U W/Handlebar Remote (ARAI F/F HELMETS)	<b>843-01032</b>
SENA 10U W/Handlebar Remote (Shoei GT-AIR)	<b>843-01034</b>
SENA 10U W/Handlebar Remote (Shoei NEOTEC)	<b>843-01035</b>
SENA 10U W/Handlebar Remote (Shoei J-Cruise)	<b>843-01046</b>
ACCESSORIES	
10U Supplies kit Shoei J-Cruise	<b>843-01047</b>

## NEW SENA 10U PAD

The 10U pad is available in 3 different models for the HJC IS-17, HJC IS-MAX2, and Shoei RF-1200 helmets (Sizes S-XL). It offers all of the functionality of a Sena Bluetooth headset, but is completely invisible from the outside of the helmet.



### FEATURES

- Bluetooth 4.1
- Invisible beauty
- Universal 4-way group intercom up to 900 m / 1/2 mile in open terrain
- Use with or with out remote control (sold separate)
- FM Radio
- Music sharing
- Advanced noise control™
- Voice prompts

Model	WPS#
HJC IS-17	<b>843-01235</b>

- WINDSHIELDS / FAIRINGS
- AUDIO / COMMUNICATION
- SEATS / LUGGAGE
- BAR / MIRRORS / CONTROLS
- EXHAUST
- AIR / FUEL SYSTEMS
- ENGINE
- TRANSMISSION / DRIVELINE
- GASKETS / SEALS
- ELECTRICAL
- LIGHTING
- CABLES
- BRAKES
- OIL FILTERS
- SUSPENSION
- BODY
- WHEELS
- TIRES / TIRE ACC.
- BIKE ACC.
- VICTORY / INDIAN
- COVERS / LOCKS / TIEDOWNS
- CHEMICALS
- TOOLS
- HELMETS
- HELMET ACC.
- EYEWEAR
- APPAREL / RIDER ACC.
- PROMOTIONAL
- REFERENCE
- INDEX

# SENA TUFFTALK

**OVER-THE-HEAD EARMUFF HEADSET WITH LONG-RANGE Bluetooth™ COMMUNICATION**



**RIDE CONNECTED**  
mobile APP available

- WINDSHIELDS / FAIRINGS
- AUDIO / COMMUNICATION**
- SEATS / LUGGAGE
- BARS / MIRRORS / CONTROLS
- EXHAUST
- AIR / FUEL SYSTEMS
- ENGINE
- TRANSMISSION / DRIVELINE
- GASKETS / SEALS
- ELECTRICAL
- LIGHTING
- CABLES
- BRAKES
- OIL FILTERS
- SUSPENSION
- BODY
- WHEELS
- TIRES / TIRE ACC.
- BIKE ACC.
- VICTORY / INDIAN
- COVERS / LOCKS / TIEDOWNS
- CHEMICALS
- TOOLS
- HELMETS
- HELMET ACC.
- EYEWEAR
- APPAREL / RIDER ACC.
- PROMOTIONAL
- REFERENCE
- INDEX

X

X

**IMPORTANT:** These will be sold as each (one in the box).

Description	WPS #
TUFFTALK single unit	843-01200



## ACCESSORIES

Description	WPS #
TUFFTALK microphone	843-01201
TUFFTALK replacement ear pads	843-01202
TUFFTALK battery cover	843-01203
TUFFTALK antennas	843-01204
TUFFTALK hard hat mount	843-01205
TUFFTALK 2-way radio cable KENWOOD twin-pin connection	843-01206
TUFFTALK 2-way radio cable MOTOROLA twin-pin connection	843-01207

Description	WPS #
TUFFTALK 2-way radio cable MOTOROLA single-pin connection	843-01208
TUFFTALK 2-way radio cable ICOM twin-pin connection	843-01209
TUFFTALK 2-way radio cable YAESU single-pin connection	843-01210
TUFFTALK 2-way radio cable MIDLAND twin-pin connection	843-01211
TUFFTALK 2-way radio cable with an open end	843-01212
TUFFTALK 2-way radio cable with straight type	843-01213
TUFFTALK rechargeable battery	843-01216
Dual battery charger	843-01215



**RIDE CONNECTED**  
mobile APP available

# SENA FREEWIRE

**Bluetooth™ CB AND AUDIO ADAPTER FOR HARLEY DAVIDSON & HONDA GOLDWING**



For Harley Davidson



For Honda Goldwing

**\*IMPORTANT:** This item is compatible with the 20S and 10S models (10R, 10C, and 10U) with current firmware update. (Firmware update coming)

**\*IMPORTANT:** This unit is only compatible with Harley Davidsons that have the 7 Pin Din plug on the tank console or dash. For Harley Davidsons that do not have the 7 Pin Din plug accessible on the front of the bike, a specific Harley Davidson audio/communication cable is required. The Harley Davidson connector cable kit part number is 69200865. This part number is available online or at Harley Davidson dealerships.

**\*IMPORTANT:** Goldwing kit includes 5 Pin Din Plug

## ACCESSORIES

	WPS#
Micro USB to 7 pin din cable for Harley Davidson	<b>843-01137</b>
Micro USB to 5 pin din cable for Honda Goldwing	<b>843-01138</b>
Cigarette charger (Jack type)	<b>843-01139</b>
Freewire supply kit	<b>843-01222</b>

Description	WPS #
Freewire for Harley Davidson (7 pin plug included)	<b>843-01220</b>
Freewire for Honda Goldwing (5 pin plug included)	<b>843-01221</b>

# SENA SM10

**DUAL STREAM Bluetooth™ STEREO TRANSMITTER**



Shown with Handlebar Mounting Kit



**Includes:**  
Dual Stream Bluetooth® Stereo Transmitter Main Unit  
Handlebar Mounting Kit  
Mounting Cradle  
USB Power & Data Cable  
3.5mm 3-pole Stereo Audio Cable  
3.5mm 4-pole Stereo Audio Cable  
Cigarette Charger

## FEATURES

Description	WPS#
Stereo Transmitter	<b>843-01160</b>

## ACCESSORIES

Description	WPS#
USB Power Cable (Micro-USB Type)	<b>843-01075</b>
Cigarette Charger for (Micro-USB Type)	<b>843-01077</b>
Stereo Audio Cable, 3.5mm, Straight	<b>843-01143</b>
Standard Phone Cable, 3.5mm 4 pole, for iPhone, Blackberry, Samsung and HTC	<b>843-01144</b>
3.5mm Stereo Jack to 7 pin DIN Cable for Harley Ultra Classic	<b>843-01161</b>
3.5mm Stereo Jack to 5 pin DIN Cable for Honda Gold Wing	<b>843-01162</b>
3.5mm Stereo Jack to 6 pin DIN Cable BMW	<b>843-01164</b>
3.5mm Stereo Jack to 7 pin DIN Cable	<b>843-01165</b>
3.5mm Stereo Jack to 5 pin DIN Cable	<b>843-01166</b>
2.5mm to 3.5mm Audio Cable	<b>843-01193</b>

- WINDSHIELDS / FAIRINGS
- AUDIO / COMMUNICATION
- SEATS / LUGGAGE
- BARS / MIRRORS / CONTROLS
- EXHAUST
- AIR / FUEL SYSTEMS
- ENGINE
- TRANSMISSION / DRIVELINE
- GASKETS / SEALS
- ELECTRICAL
- LIGHTING
- CABLES
- BRAKES
- OIL FILTERS
- SUSPENSION
- BODY
- WHEELS
- TIRES / TIRE ACC.
- BIKE ACC.
- VICTORY / INDIAN
- COVERS / LOCKS / TIEDOWNS
- CHEMICALS
- TOOLS
- HELMETS
- HELMET ACC.
- EYEWEAR
- APPAREL / RIDER ACC.
- PROMOTIONAL
- REFERENCE
- INDEX

# SENA SR10

## Bluetooth™ TWO-WAY RADIO ADAPTER



RIDE CONNECTED  
mobile APP available



Includes:

- WINDSHIELDS / FAIRINGS
- AUDIO / COMMUNICATION
- SEATS / LUGGAGE
- BARS / MIRRORS / CONTROLS
- EXHAUST
- AIR / FUEL SYSTEMS
- ENGINE
- TRANSMISSION / DRIVELINE
- GASKETS / SEALS
- ELECTRICAL
- LIGHTING
- CABLES
- BRAKES
- OIL FILTERS
- SUSPENSION
- BODY
- WHEELS
- TIRES / TIRE ACC.
- BIKE ACC.
- VICTORY / INDIAN
- COVERS / LOCKS / TIEDOWNS
- CHEMICALS
- TOOLS
- HELMETS
- HELMET ACC.
- EYEWEAR
- APPAREL / RIDER ACC.
- PROMOTIONAL
- REFERENCE
- INDEX

X

X

X

Description	WPS#
Adapter	843-01140

### ACCESSORIES

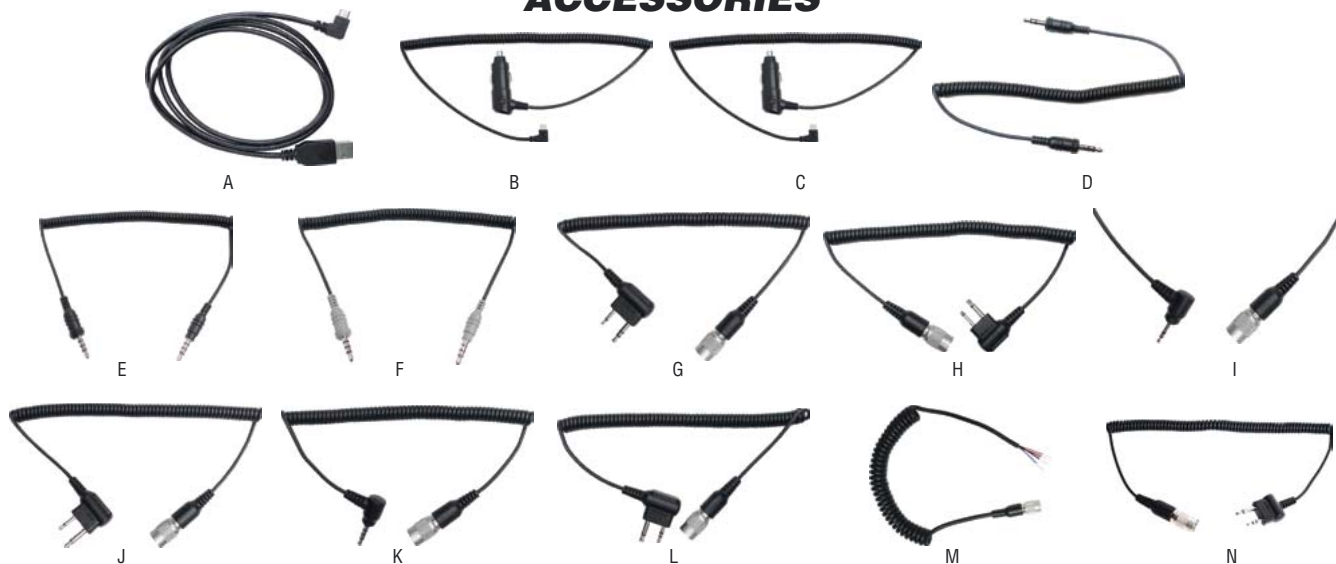

Description	WPS#
A USB Power Cable (Micro-USB Type)	843-01075
B Cigarette Charger for (Micro-USB Type)	843-01077
C Cigarette Charger (Micro-USB Type). Optional 12V bike-powered kit with on/off control by ignition.	843-01142
D Stereo Audio Cable, 3.5mm, Straight	843-01143
E Nokia Phone Cable, 3.5mm 4 pole	843-01145
F Standard Phone Cable, 3.5mm 4 pole, for iPhone, Blackberry, Samsung and HTC	843-01144
<b>2-WAY RADIO CABLE</b>	
G for Kenwood twin-pin connector	843-01146
H for Motorola twin-pin connector	843-01147
I for Motorola single-pin connector	843-01148
J for Icom twin-pin connector	843-01149
K for Yaesu twin-pin connector	843-01150
L for Midland twin-pin connector	843-01151
M Open end	843-01152
N Straight type of Midland and Icom twin-pin connector	843-01153
O Supplies kit	843-01154
P Wired PPT Button	843-01155
Q Extension Cable for Wired PTT Button	843-01156







RIDE CONNECTED  
mobile APP available

# SENA Bluetooth 4.1 REMOTES

## A. HANDLEBAR REMOTE

X



FEATURES

## B. WRISTBAND REMOTE

X



FEATURES

## C. RC3 REMOTE



FEATURES

## D. RC4 REMOTE

X



FEATURES

Description	WPS #
A Handlebar remote	843-01181
B Wristband remote	843-01182
C RC3	843-01183
D RC4	843-01184

- WINDSHIELDS / FAIRINGS
- AUDIO / COMMUNICATION**
- SEATS / LUGGAGE
- BARS / MIRRORS / CONTROLS
- EXHAUST
- AIR / FUEL SYSTEMS
- ENGINE
- TRANSMISSION / DRIVELINE
- GASKETS / SEALS
- ELECTRICAL
- LIGHTING
- CABLES
- BRAKES
- OIL FILTERS
- SUSPENSION
- BODY
- WHEELS
- TIRES / TIRE ACC.
- BIKE ACC.
- VICTORY / INDIAN
- COVERS / LOCKS / TIEDOWNS
- CHEMICALS
- TOOLS
- HELMETS
- HELMET ACC.
- EYEWEAR
- APPAREL / RIDER ACC.
- PROMOTIONAL
- REFERENCE
- INDEX

- WINDSHIELDS / FAIRINGS
- AUDIO / COMMUNICATION**
- SEATS / LUGGAGE
- BAR / MIRRORS / CONTROLS
- EXHAUST
- AIR / FUEL SYSTEMS
- ENGINE
- TRANSMISSION / DRIVELINE
- GASKETS / SEALS
- ELECTRICAL
- LIGHTING
- CABLES
- BRAKES
- OIL FILTERS
- SUSPENSION
- BODY
- WHEELS
- TIRES / TIRE ACC.
- BIKE ACC.
- VICTORY / INDIAN
- COVERS / LOCKS / TIEDOWNS
- CHEMICALS
- TOOLS
- HELMETS
- HELMET ACC.
- EYEWEAR
- APPAREL / RIDER ACC.
- PROMOTIONAL
- REFERENCE
- INDEX

# SENA 3S

## Bluetooth™ 3.0 HEADSET AND INTERCOM



**RIDE CONNECTED**  
mobile APP available

The 3S is a Bluetooth 3.0 stereo headset with Bluetooth intercom designed specifically for motorcycles. With the 3S, you can call handsfree on your Bluetooth mobile phone, listen to stereo music, and have two-way intercom conversations in full duplex with a passenger or other riders.

Thanks to the latest Bluetooth 3.0 and the advanced digital signal processing technology, the 3S offers the best sound quality for both incoming and outgoing sound in its class. Also, the easy-to-access and intuitive two-button operations make the 3S a perfect companion for motorcycles.

### FEATURES

- Bluetooth 3.0.
- Bluetooth Intercom between 2 people including Bike-to-Bike and Rider-to-passenger up to 200 meters (220 yards) in open terrain.
- Bluetooth pairing for dual mobile phones.
- Voice prompts.
- Bluetooth stereo headset by A2DP.
- Bluetooth music playback control by AVRCP: play, pause, track forward and track back.
- Easy operations by two-button.
- Bluetooth handsfree for Bluetooth mobile phones.
- Crystal clear and natural sound quality.
- Talk time: 8 Hours Standby: 7 Days.
- Individual volume control for each audio source.
- Installation friendly unbody design.
- Firmware upgradeable.
- Peace of mind – thanks to the two-year warranty.

### OPEN FACE (Boom Mic)



### FULL FACE (Wired Mic)



Description	WPS#
Boom Microphone Kit Single Pack - Open Face	843-01170
Wired Microphone Kit Single Pack- Full Face	843-01171
Wired Boom Microphone Kit Single - Modular	843-01173
Supplies Kit	843-01172

### MODULAR (Wired Boom Mic)





RIDE CONNECTED  
mobile APP available

# SENA SMH10

## Bluetooth 3.0 HEADSET AND INTERCOM

The SMH10 motorcycle intercom and headset was designed to keep you connected to your riding companions over longer ranges for conversation and Bluetooth music sharing. When paired with a Bluetooth®-enabled phone, it'll also let you make hands-free calls.

### FEATURES

- Bluetooth 3.0
- Universal 4-way intercom up to 900 m / ½ mile
- Bluetooth stereo music
- Playback control
- Advanced noise control™
- Versatile jog dial
- Audio boost
- Firmware upgradeable
- Cross brand compatibility
- Available with universal microphone kit

### SMH10 BLUETOOTH® HEADSET AND INTERCOM



#### Includes:

- Headset Main Unit
- Speaker-Microphone Clamp Unit
- USB Power & Data Cable
- Cigarette Charger
- 3.5mm Stereo Audio Jack Cable
- Glued Surface Mounting Adaptor
- Microphone Sponges
- Velcro Pads
- Allen Wrench
- Speaker Pads
- Microphone Cap

### SMH10 BLUETOOTH® HEADSET AND INTERCOM WITH UNIVERSAL MICROPHONE KIT



#### Includes:

- Headset Main Unit
- Speaker-Microphone Clamp Unit with Universal Microphone Kit
- USB Power & Data Cable
- Cigarette Charger
- 3.5mm Stereo Audio Jack Cable
- Glued Surface Mounting Adaptor
- Microphone Sponges
- Velcro Pads
- Allen Wrench
- Speaker Pads
- Microphone Cap

Description	Single Pack	Dual Pack
SMH10	843-01060	843-01061
SMH10 w/universal mic. kit	843-01062	843-01063

- WINDSHIELDS / FAIRINGS
- AUDIO / COMMUNICATION
- SEATS / LUGGAGE
- BAR / MIRRORS / CONTROLS
- EXHAUST
- AIR / FUEL SYSTEMS
- ENGINE
- TRANSMISSION / DRIVELINE
- GASKETS / SEALS
- ELECTRICAL
- LIGHTING
- CABLES
- BRAKES
- OIL FILTERS
- SUSPENSION
- BODY
- WHEELS
- TIRES / TIRE ACC.
- BIKE ACC.
- VICTORY / INDIAN
- COVERS / LOCKS / TIEDOWNS
- CHEMICALS
- TOOLS
- HELMETS
- HELMET ACC.
- EYEWEAR
- APPAREL / RIDER ACC.
- PROMOTIONAL
- REFERENCE
- INDEX

# SENA SMH10



**RIDE CONNECTED**  
mobile APP available

## Bluetooth™ 3.0 BELL® MAG-9 & QUALIFIER DLX HEADSET AND INTERCOM

The SMH10 is a Bluetooth 3.0 stereo headset with long-range Bluetooth intercom designed specifically for Bell Mag-9 and Bell Qualifer DLX. With the SMH10, you can call handsfree on your Bluetooth mobile phone, listen to stereo music or voice instructions of GPS navigations by Bluetooth wirelessly and have intercom conversations in full duplex with a passenger or other motorcycle riders. The SMH10 offers exceptional sound quality for both incoming and outgoing sound in its class. Also, the easy-to-access and intuitive button operations make the SMH10 a perfect companion for motorcycles.

### FEATURES

- Designed specifically for Bell Mag-9 and Bell Qualifer DLX
- Bluetooth 3.0
- Universal 4-way intercom up to 900 m / 980 yards
- Ideal for rider passenger
- Music sharing w/playback control
- Advanced noise control™
- Versatile jog dial
- Audio boost
- Firmware upgradable

### Includes:

- Headset Main Unit
- Speaker-Microphone Clamp Unit
- USB Power & Data Cable
- Cigarette Charger
- 3.5mm Stereo Audio Jack Cable
- Glued Surface Mounting Adaptor
- Microphone Sp



Description	WPS#
Single SMH10 Bell Mag 9/Qualifier DLX	843-01178
Dual SMH10 Bell Mag 9/Qualifier DLX	843-01179
SMH10 Helmet Clamp Kit for Bell® Mag-9 Helmets	843-01180

## ACCESSORIES

Description	WPS#
A SMH10 main module w/USB cable	843-01064
B Helmet Clamp Kit - Boom microphone	843-01065
C Helmet Clamp Kit - Attachable boom microphone & wired microphone	843-01066
D Helmet Clamp Kit - For earbuds	843-01067
E Helmet Clamp Kit - For earbuds with attachable boom microphone & wired microphone	843-01068
F Helmet Clamp Kit - For speakers & earbuds	843-01069
G Helmet Clamp Kit - For speakers & earbuds with attachable boom & wired microphone	843-01070
H Stereo Audio Cable, 3.5mm	843-01071
I USB Power Cable (Micro-USB type)	843-01075
J Cigarette Charger for (Micro-USB type)	843-01077
K Mounting accessories	843-01078
L Backplate for speaker-microphone clamp unit	843-01079



\*NOTE: Please note which jack type your SMH10 unit has. Older versions of the SMH10 have a DC Power Jack Type and newer versions have a Micro-USB Type.



RIDE CONNECTED  
mobile APP available

# SENA SMH10R

## LOW PROFILE MOTORCYCLE

### Bluetooth 3.0 HEADSET AND INTERCOM

Low profile, yet rich with high-performance features, the SMH10R lets riders make hands-free phone calls, listen to music, get GPS directions, and have full-duplex intercom conversations with other riders in crystal-clear audio quality through the stereo Bluetooth® performance motorcycle headset. Ultra slim and featherlight, it's a particularly good choice for riders who want to concentrate on their riding technique and minimize fuss factor.



- Bluetooth 3.0
- Universal 4-way intercom up to 900 m / ½ mile in open terrain
- Bluetooth stereo w/music sharing
- Voice prompts
- Light weight and ultra slim
- Advanced noise control™

Description	WPS#
Headset and Intercom	843-01050
Low Profile Dual Pack	843-01051

### ACCESSORIES



Description	WPS#
A SMH10R Supplies Kit	843-01052
B World Wide USB Wall Charger	843-01053
C USB Power Cable (Micro-USB Type)	843-01056
D Battery Pack	843-01054
E SMH10R Slim Speakers	843-01055
F Wired Microphone	843-01057
G Earbud Adaptor Cable	843-01058
H SMH10R Large Speakers	843-01097

- WINDSHIELDS / FAIRINGS
- AUDIO / COMMUNICATION
- SEATS / LUGGAGE
- BARS / MIRRORS / CONTROLS
- EXHAUST
- AIR / FUEL SYSTEMS
- ENGINE
- TRANSMISSION / DRIVELINE
- GASKETS / SEALS
- ELECTRICAL
- LIGHTING
- CABLES
- BRAKES
- OIL FILTERS
- SUSPENSION
- BODY
- WHEELS
- TIRES / TIRE ACC.
- BIKE ACC.
- VICTORY / INDIAN
- COVERS / LOCKS / TIEDOWNS
- CHEMICALS
- TOOLS
- HELMETS
- HELMET ACC.
- EYEWEAR
- APPAREL / RIDER ACC.
- PROMOTIONAL
- REFERENCE
- INDEX

# SENA SPH10H-FM

## Bluetooth™ 3.0 HEADSET AND INTERCOM FOR HALF HELMETS

The SPH10H-FM is a Bluetooth Headset and Intercom designed for Half Helmets. By simply attaching the SPH10H-FM to your half helmet, you can call hands free on your Bluetooth mobile phone and listen to stereo music by Bluetooth wirelessly and have intercom conversations in full duplex with other users. The SPH10H-FM offers exceptional sound quality for both incoming and outgoing sound in its class. Also, the easy-to-access and intuitive button operations make the SPH10H-FM a perfect companion for motorcycle riders.

### FEATURES

- Bluetooth 3.0
- Universal 4-way intercom up to 700 m / 760 yards in open terrain
- FM Radio
- Voice prompts
- Bluetooth stereo w/music sharing
- Advanced noise control™
- Easy to install snap fit earpads

**Includes:**  
 Snapfit earpad w/  
 built-in Bluetooth®  
 USB Power Cable  
 Stereo Audio Cable



Description	WPS#
Single Pack - Headset and Intercom w/built in FM tuner	843-01121
Dual Pack - Headset and Intercom w/built in FM tuner	843-01122

## ACCESSORIES

Description	WPS#
A USB Power Cable (Micro-USB Type)	843-01075
B Cigarette Charger for (Micro-USB Type)	843-01077
C Stereo audio cable 2.5mm to 3.5mm	843-01163
D Half Helmet Earpad kit	843-01059



- WINDSHIELDS / FAIRINGS
- AUDIO / COMMUNICATION**
- SEATS / LUGGAGE
- BAR / MIRRORS / CONTROLS
- EXHAUST
- AIR / FUEL SYSTEMS
- ENGINE
- TRANSMISSION / DRIVELINE
- GASKETS / SEALS
- ELECTRICAL
- LIGHTING
- CABLES
- BRAKES
- OIL FILTERS
- SUSPENSION
- BODY
- WHEELS
- TIRES / TIRE ACC.
- BIKE ACC.
- VICTORY / INDIAN
- COVERS / LOCKS / TIEDOWNS
- CHEMICALS
- TOOLS
- HELMETS
- HELMET ACC.
- EYEWEAR
- APPAREL / RIDER ACC.
- PROMOTIONAL
- REFERENCE
- INDEX

# SENA SPH10

## Bluetooth™ HEADSET AND INTERCOM

The SPH10 is a Bluetooth Stereo Headset with long-range Bluetooth Intercom designed specifically for outdoor sports activities. With the SPH10, you can call hands-free on your Bluetooth mobile phone, listen to stereo music or voice instructions of GPS navigations by Bluetooth wireless, and have intercom conversations in full duplex with your companions. Thanks to the latest Bluetooth and the advanced digital processing technology, the SPH10 offers the best sound quality for both incoming and outgoing sound in its class. Also, the easy-to-access and intuitive button operations make the SPH10 a perfect companion for outdoor sports.

**Includes:**  
 Headset Main Unit  
 Boom Microphone  
 Mini Microphone  
 USB Power Cable  
 Stereo Audio Cable  
 Rubber Earpads



**FEATURES**

- Bluetooth 3.0
- Universal 4-way intercom up to 900 m / 980 yards in open terrain
- Advanced noise control™
- Multipoint technology for dual mobile phone usage
- Versatile jog dial
- Bluetooth stereo w/music sharing
- Audio boost

**WPS#**

**843-01100**



**ACCESSORIES**

	Description	WPS#
A	SPH10 Microphones	<b>843-01123</b>
B	USB Power Cable (Micro-USB Type)	<b>843-01075</b>
C	Cigarette Charger for (Micro-USB Type)	<b>843-01077</b>



# SENA EXPAND

## Bluetooth™ 3.0 INTERCOM

The Sena Expand is a Bluetooth® Stereo headset with long-range Bluetooth® intercom designed specifically for outdoor sports activities. With the Sena Expand, users can call handsfree on their Bluetooth® mobile phone, listen to stereo music as well as have intercom conversations in full duplex with up to four companions. Also, the easy-to-access and intuitive headset makes the Sena Expand a perfect companion for outdoor sports.



**FEATURES**

- Bluetooth® 3.0
- Stable and secure fit for active condition
- Durable, sweat and water resistant for active condition
- Bluetooth® intercom up to 700 meters (760 yards) in open terrain
- Bluetooth® Intercom between 4 people including Bike-to-Bike and Rider-to-passenger
- Crystal clear and natural sound quality
- Voice prompts
- Bluetooth® stereo headset for Bluetooth® audio devices such as MP3 players
- Talk time: 10 Hours Standby: 7 Days
- Rich sound level with integrated audio booster
- Bluetooth® hands free for Bluetooth® mobile phones
- Individual volume control for each audio source
- Firmware upgradable
- Peace of mind – thanks to the two-year warranty

Description	WPS#
Bluetooth® Intercom	<b>843-01131</b>

- WINDSHIELDS / FAIRINGS
- AUDIO / COMMUNICATION
- SEATS / LUGGAGE
- BARS / MIRRORS / CONTROLS
- EXHAUST
- AIR / FUEL SYSTEMS
- ENGINE
- TRANSMISSION / DRIVELINE
- GASKETS / SEALS
- ELECTRICAL
- LIGHTING
- CABLES
- BRAKES
- OIL FILTERS
- SUSPENSION
- BODY
- WHEELS
- TIRES / TIRE ACC.
- BIKE ACC.
- VICTORY / INDIAN
- COVERS / LOCKS / TIEDOWNS
- CHEMICALS
- TOOLS
- HELMETS
- HELMET ACC.
- EYEWEAR
- APPAREL / RIDER ACC.
- PROMOTIONAL
- REFERENCE
- INDEX

# SENA SMH5

## Bluetooth™ 3.0 HEADSET AND INTERCOM



RIDE CONNECTED  
mobile APP available

**Includes:**

- Main unit
- Mono speaker
- Clamp kit
- USB power & data cable (Micro USB type)
- Speaker sponges
- Hook and loop fastener for speaker
- Speaker pad
- Microphone port cap

Description	WPS#
Single Pack w/ Wired & Boom Mic	843-01280
Dual Pack w/ Wired & Boom Mic	843-01281
Single Pack With FM Tuner w/Wired & Boom Mic	843-01282
Dual Pack With FM Tuner w/Wired & Boom Mic	843-01283



### ACCESSORIES

Description	WPS#
A Mounting Accessories Kit	843-01088
B Supplies Kit	843-01089
C Clamp Kit w/ Attachable Boom Microphone	843-01090
D Clamp Kit w/ Wired Microphone	843-01091
E Attachable Boom Microphone	843-01092
F Large Speakers w/Locking Type Connector	843-01094
G Slim Speakers	843-01093
H USB Power Cable (Micro-USB Type)	843-01075
I Cigarette Charger for (Micro-USB Type)	843-01077
J Wired microphone	843-01096

- WINDSHIELDS / FAIRINGS
- AUDIO / COMMUNICATION
- SEATS / LUGGAGE
- BARS / MIRRORS / CONTROLS
- EXHAUST
- AIR / FUEL SYSTEMS
- ENGINE
- TRANSMISSION / DRIVELINE
- GASKETS / SEALS
- ELECTRICAL
- LIGHTING
- CABLES
- BRAKES
- OIL FILTERS
- SUSPENSION
- BODY
- WHEELS
- TIRES / TIRE ACC.
- BIKE ACC.
- VICTORY / INDIAN
- COVERS / LOCKS / TIEDOWNS
- CHEMICALS
- TOOLS
- HELMETS
- HELMET ACC.
- EYEWEAR
- APPAREL / RIDER ACC.
- PROMOTIONAL
- REFERENCE
- INDEX



# SENA PRISM TUBE

## ACTION CAMERA



**Accessories included in box:** Lens cap, Rear cap, Rear cap for USB cable, Prism tube Cable for Speaker and Microphone, Wired Microphone, Hook and loop fastener for wired microphone, speaker, hook and loop fastener for speaker, glued surface mounting plate, tube swivel mount kit, Prism USB Power & Data Cable (micro USB type) and allen wrench.

Description	WPS#
Prism Tube Action Camera	843-01010

## ACCESSORIES



Description	WPS#
A SENA Prism Tube Supplies Kit	843-01011
B SENA Prism Tube Helmet Clamp	843-01012
C SENA Prism Tube LENS Cap and Rear Caps	843-01013
D SENA Prism Tube Speaker	843-01014
E SENA Prism Tube USB Cable	843-01015
F SENA USB Wall Charger	843-01053
G SENA Cigarette Charger 5V	843-01017
H SENA USB Power & Data Cable	843-01157
I SENA Wired Microphone	843-01195

## MICRO SD CARDS



Description	WPS#	Description	WPS#
8 GB	510-1510	32 GB	510-1512
16 GB	510-1511	64 GB	510-1513

- WINDSHIELDS / FAIRINGS
- AUDIO / COMMUNICATION**
- SEATS / LUGGAGE
- BARS / MIRRORS / CONTROLS
- EXHAUST
- AIR / FUEL SYSTEMS
- ENGINE
- TRANSMISSION / DRIVELINE
- GASKETS / SEALS
- ELECTRICAL
- LIGHTING
- CABLES
- BRAKES
- OIL FILTERS
- SUSPENSION
- BODY
- WHEELS
- TIRES / TIRE ACC.
- BIKE ACC.
- VICTORY / INDIAN
- COVERS / LOCKS / TIEDOWNS
- CHEMICALS
- TOOLS
- HELMETS
- HELMET ACC.
- EYEWEAR
- APPAREL / RIDER ACC.
- PROMOTIONAL
- REFERENCE
- INDEX

# SENA POWERBANK

## PORTABLE BATTERY PACK



RIDE CONNECTED  
mobile APP available



**Included in box:** Powerbank, mounting adapter, handlebar mount, armband mount and USB power cable

Description	WPS #
Powerbank Battery Pack	843-01049

## SENA Bluetooth™ 3.0 PACK FOR GOPRO®



Description	WPS#
GoPro® Pack	843-01020
Water-proof Housing	843-01022

- WINDSHIELDS / FAIRINGS
- AUDIO / COMMUNICATION
- SEATS / LUGGAGE
- BARS / MIRRORS / CONTROLS
- EXHAUST
- AIR / FUEL SYSTEMS
- ENGINE
- TRANSMISSION / DRIVELINE
- GASKETS / SEALS
- ELECTRICAL
- LIGHTING
- CABLES
- BRAKES
- OIL FILTERS
- SUSPENSION
- BODY
- WHEELS
- TIRES / TIRE ACC.
- BIKE ACC.
- VICTORY / INDIAN
- COVERS / LOCKS / TIEDOWNS
- CHEMICALS
- TOOLS
- HELMETS
- HELMET ACC.
- EYEWEAR
- APPAREL / RIDER ACC.
- PROMOTIONAL
- REFERENCE
- INDEX

**AMP PRO HELMET AUDIO SYSTEM**



**PRODUCT FEATURES:**

Industry leading 10+ person intercom mode

Multi-hop technology

Clearlink app

Amp processor with Bluetooth 4.2

Multi point connectivity

Pulse pro speaker microphone array

Hands free voice activated call pick up

Music share

ABF® technology

Cross brand compatibility

Industry's most portable system



SINGLE SYSTEM INCLUDES

DUAL SYSTEM INCLUDES

Description	WPS#
AMP PRO Single	161230
AMP PRO Dual	161231

- WINDSHIELDS / FAIRINGS
- AUDIO / COMMUNICATION
- SEATS / LUGGAGE
- BARS / MIRRORS / CONTROLS
- EXHAUST
- AIR / FUEL SYSTEMS
- ENGINE
- TRANSMISSION / DRIVELINE
- GASKETS / SEALS
- ELECTRICAL
- LIGHTING
- CABLES
- BRAKES
- OIL FILTERS
- SUSPENSION
- BODY
- WHEELS
- TIRES / TIRE ACC.
- BIKE ACC.
- VICTORY / INDIAN
- COVERS / LOCKS / TIEDOWNS
- CHEMICALS
- TOOLS
- HELMETS
- HELMET ACC.
- EYEWEAR
- APPAREL / RIDER ACC.
- PROMOTIONAL
- REFERENCE
- INDEX

**UCLEAR** AMP PLUS HELMET AUDIO SYSTEM

Amp Plus took the foundation of our ground breaking HBC series, amplified it with a faster more powerful processor, upgraded the connection to powerful Bluetooth 4.2 and added our new Boost Pro microphone speaker system. The AMP Plus is the Bluetooth audio system of choice for any power sports or Motorsports enthusiast. The AMP Plus includes our full duplex intercom technology, which allows you to connect up to 4 other AMP Plus users. Enjoy Studio quality Audio, with deep bass and clear voice. Our patented noise cancelling ABF technology eliminates most external noise and our DSP algorithms triangulate your voice's "Sweet Spot" for exceptional sound clarity during voice communication. So chat it up as you head down the highway or rock out solo to your favorite band the Amp Plus has you dialed.



**PRODUCT FEATURES:**

**6 person intercom mode**  
Six user full duplex private intercom

**Multi-hop technology**  
Multi-hop uses each rider to extend intercom range, the more riders longer the range

**Clearlink app**  
Free Smartphone app with tools to customize and update your amp settings anytime, anywhere

**New faster amp processor with more reliable Bluetooth 4.2**  
Holds 10 times more data at up to 2.5 times faster speeds than previous version

**Multi point connectivity**  
Connect to multiple Bluetooth devices such as GPS systems and smartphones

**Boost pro speaker microphone array**  
Multi-position microphones with bass boosted hi-definition audio

**Hands free voice activated call pick up**  
Take those incoming phone calls with a simple "hello"

**Patented boom-free dual microphone**  
Exclusive dual boom-free speaker microphone array for exceptional voice clarity

**ABF® technology**  
Our patented system eliminates most road and engine noise

**Cross brand compatibility**  
Intercom connect to most Bluetooth helmet communication systems

**Industry's most portable system**  
Transfers easily from helmet to helmet with accessories for any helmet style

**Weather resistant**  
Ride with confidence in wet, cold or warm conditions



- Single System Includes**
- (1) Amp Plus Controller Unit
  - (1) Boost Pro Speaker/Mic Array
  - (1) Permanent Mount
  - (1) Temporary Mount
  - (1) AC Charger
  - (1) USB Charging Cable
  - (1) Velcro Mount Set
  - (1) Quick Start Guide

- Dual System Includes**
- (2) Amp Plus Controller Unit
  - (2) Boost Pro Speaker/Mic Array
  - (2) Permanent Mount
  - (2) Temporary Mount
  - (2) AC and DC Charger
  - (2) USB Charging Cable
  - (2) Velcro Mount Rounds
  - (1) Quick Start Guide

Description	WPS#
AMP PLUS Single	71-8009
AMP PLUS Dual	71-8012

AMP HELMET AUDIO SYSTEM



PRODUCT FEATURES:

Dual intercom mode

Clearlink app

New faster amp processor with more reliable Bluetooth 4.2

Multi point connectivity

Boost plus speakers

Hands free voice activated call pick up

Patented boom- free dual microphone

ABF® technology

Cross brand compatibility

Industry's most portable system

Weather resistant



Single System Includes

Dual System Includes

Description	WPS#
AMP Single	161226
AMP Dual	161227

- WINDSHIELDS / FAIRINGS
- AUDIO / COMMUNICATION
- SEATS / LUGGAGE
- BARS / MIRRORS / CONTROLS
- EXHAUST
- AIR / FUEL SYSTEMS
- ENGINE
- TRANSMISSION / DRIVELINE
- GASKETS / SEALS
- ELECTRICAL
- LIGHTING
- CABLES
- BRAKES
- OIL FILTERS
- SUSPENSION
- BODY
- WHEELS
- TIRES / TIRE ACC.
- BIKE ACC.
- VICTORY / INDIAN
- COVERS / LOCKS / TIEDOWNS
- CHEMICALS
- TOOLS
- HELMETS
- HELMET ACC.
- EYEWEAR
- APPAREL / RIDER ACC.
- PROMOTIONAL
- REFERENCE
- INDEX

- WINDSHIELDS / FAIRINGS
- AUDIO / COMMUNICATION**
- SEATS / LUGGAGE
- BARS / MIRRORS / CONTROLS
- EXHAUST
- AIR / FUEL SYSTEMS
- ENGINE
- TRANSMISSION / DRIVELINE
- GASKETS / SEALS
- ELECTRICAL
- LIGHTING
- CABLES
- BRAKES
- OIL FILTERS
- SUSPENSION
- BODY
- WHEELS
- TIRES / TIRE ACC.
- BIKE ACC.
- VICTORY / INDIAN
- COVERS / LOCKS / TIEDOWNS
- CHEMICALS
- TOOLS
- HELMETS
- HELMET ACC.
- EYEWEAR
- APPAREL / RIDER ACC.
- PROMOTIONAL
- REFERENCE
- INDEX



**UCLEAR**  
DIGITAL

**UNIVERSAL EARBUDS**



71-8016

71-8017

Description	WPS#
Earbuds - short	<b>71-8016</b>
Earbuds - long	<b>11017</b>

**PRO MICROPHONE SPEAKERS**

Description	WPS#
Boost Pro Speakers	<b>11014</b>



**V2 SPEAKERS**



Description	WPS#
Boost Plus V2 Speakers	<b>11015</b>

ACCESSORIES



**A. TEMPORARY MOUNT**



**B. DC CHARGER**



**C. AC WALL CHARGER**



**D. SPEAKER MOUNT ROUNDS**

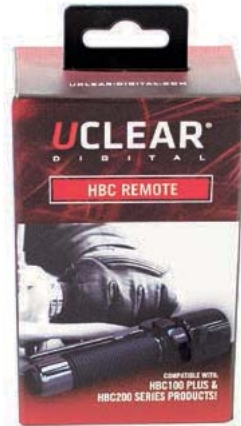

**E. HBC REMOTE**



**F. USB CHARGING CABLE**



	Description	WPS#
A	Temporary helmet mount	11002
B	DC charger	71-8022
C	AC wall charger	71-8021
D	Speaker Mount Rounds	71-8025
E	HBC Remote	71-8028
F	USB charging cable	11003
G	Permanent helmet mount	11001



**G. PERMANENT HELMET MOUNT**

WINDSHIELDS / FAIRINGS

AUDIO / COMMUNICATION

SEATS / LUGGAGE

BAR / MIRRORS / CONTROLS

EXHAUST

AIR / FUEL SYSTEMS

ENGINE

TRANSMISSION / DRIVELINE

GASKETS / SEALS

ELECTRICAL

LIGHTING

CABLES

BRAKES

OIL FILTERS

SUSPENSION

BODY

WHEELS

TIRES / TIRE ACC.

BIKE ACC.

VICTORY / INDIAN

COVERS / LOCKS / TIEDOWNS

CHEMICALS

TOOLS

HELMETS

HELMET ACC.

EYEWEAR

APPAREL / RIDER ACC.

PROMOTIONAL

REFERENCE

INDEX

- WINDSHIELDS / FAIRINGS
- AUDIO / COMMUNICATION
- SEATS / LUGGAGE
- BARS / MIRRORS / CONTROLS
- EXHAUST
- AIR / FUEL SYSTEMS
- ENGINE
- TRANSMISSION / DRIVELINE
- GASKETS / SEALS
- ELECTRICAL
- LIGHTING
- CABLES
- BRAKES
- OIL FILTERS
- SUSPENSION
- BODY
- WHEELS
- TIRES / TIRE ACC.
- BIKE ACC.
- VICTORY / INDIAN
- COVERS / LOCKS / TIEDOWNS
- CHEMICALS
- TOOLS
- HELMETS
- HELMET ACC.
- EYEWEAR
- APPAREL / RIDER ACC.
- PROMOTIONAL
- REFERENCE
- INDEX



## PULSE PLUS SPEAKER KIT



Description	WPS#
Pulse Plus Speaker kit with Android mic	71-8035
Pulse Speaker kit w/out mic	11023

**System Includes**



## PULSE PRO SPEAKER KIT

**Product Features**



Description	WPS#
Pulse Pro Speaker kit	11033

**System Includes**





# OFF ROAD ADVENTURE SYSTEM



With UCLEAR Digital's Off-Road Adventure System you can stay connected to what matters most no matter where your adventure takes you. Now you can have all the great features for music, intercom, calls and GPS without the helmet! Great for Jeeping for your ATV/UTV, Hiking, Fishing,...Now you can go Anywhere with UCLEAR.

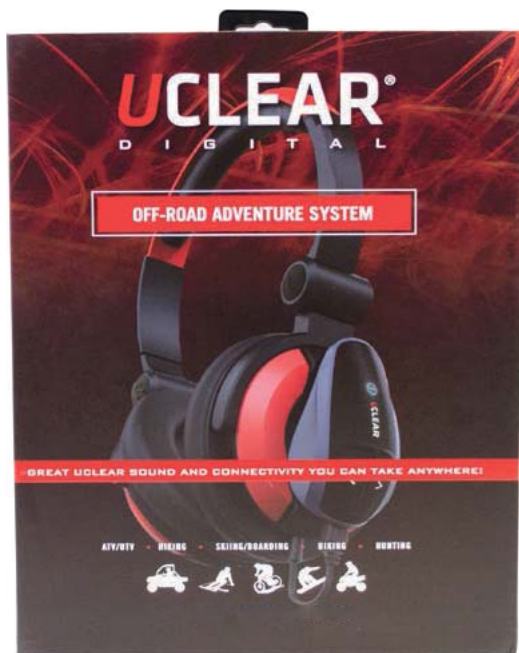

### GENERAL SPECIFICATION (HBC 100 PLUS)

- Bluetooth 2.1
- Firmware Upgradable
- Profiles: HFP, SP, AVRCP, A2DP, Intercom
- Battery: Lithium 10hr Talk Time / 3 week Standby
- Operating Temp: -20C (-4F) to 60C (140F)
- Weather Resistant
- Size: 60x40x18mm (2.9 x 1.75 x 1in)

### GENERAL SPECIFICATION (ANYWHERE HEADSETS)

- Headphone Speaker: 30mm (1.18in)
- Impedance: 32ohm
- Sensitivity: 108db+3db
- Frequency Response: 20khz
- Dual Embedded Microphone
- Microphone Impedance: <58db +3db

### PRODUCT FEATURES:

- Anywhere Headset features Studio Quality Sound
- Collapsible Headset for Easy Storage
- Headset Works with Headphone Jack of any MP3 Player or Phone.
- HBC 100 Plus uses the latest Bluetooth technology allows you to make and take cell phone calls, connect directly with another user, and listen to your favorite music.
- Full-duplex intercom system allows 4 riders to communicate at a distance of up to 500 meters (0.36 miles) each simultaneously.
- Make sure they hear what you're saying. Boom-Free microphone with integrated high-quality speakers, and noise suppression and patented ABF® technologies eliminate road and engine noise and other ambient sounds for clear conversations.
- HBC 100 Plus Firmware upgradable. With our latest firmware you can connect to other brand Bluetooth helmet communicators and enjoy multi-point connectivity to multiple devices.
- Ride in any weather our HBC units are water, heat and cold resistant.
- Operating temperature of -29°C (-20°F) to 60°C (140°F) ensures reliable operation even in extreme weather.
- Voice-activated pick-up allows hands-free operation of incoming phone calls.

Description	WPS#
Off road adventure system	71-8008

- WINDSHIELDS / FAIRINGS
- AUDIO / COMMUNICATION**
- SEATS / LUGGAGE
- BARS / MIRRORS / CONTROLS
- EXHAUST
- AIR / FUEL SYSTEMS
- ENGINE
- TRANSMISSION / DRIVELINE
- GASKETS / SEALS
- ELECTRICAL
- LIGHTING
- CABLES
- BRAKES
- OIL FILTERS
- SUSPENSION
- BODY
- WHEELS
- TIRES / TIRE ACC.
- BIKE ACC.
- VICTORY / INDIAN
- COVERS / LOCKS / TIEDOWNS
- CHEMICALS
- TOOLS
- HELMETS
- HELMET ACC.
- EYEWEAR
- APPAREL / RIDER ACC.
- PROMOTIONAL
- REFERENCE
- INDEX



Designed with IST seating technology engineered to reduce the vibration, compression and shock the body feels from riding to enable longer more comfortable rides. Includes stress relief design features to reduce pressure points on the tail bone and prostate areas of the body so you focus on the experience of riding.



All Danny Gray seats are proudly made in the USA!

## TOURING IST SEATS

Application	Year	Seat Type	WPS#
All models	'08-18	BigIST Solo Leather	<b>830-0106</b>
		BigIST Solo Air-1	<b>830-0100</b>
		BigIST Solo Air-2	<b>830-0103</b>
		MinimalIST Solo Leather	<b>830-0112</b>

### BIGIST SOLO LEATHER

- The BigIST Solo is a wide saddle with moderate back support
- The seating surface is covered in black top-grain leather with a soft subtle texture
- The side panels are matching black vinyl that will keep its shape across the high-stress points of the seat
- Dimensions: 15" W x 22" L Rider height 4.5"



### BIGIST SOLO AIR-1

- The BigIST Solo is a wide saddle with moderate back support
- Added comfort features include integrated DRY FLOATATION® air cell technology used in AIRHAWK® Comfort Seating Systems allowing you to adjust the firmness of every ride
- The seat is cover in a highly durable soft textured black vinyl
- Dimensions: 15" W x 22" L Rider height 4"



### BIGIST SOLO AIR-2

- The BigIST Solo is a wide saddle with moderate back support
- Added comfort features include integrated DRY FLOATATION® air cell technology used in AIRHAWK® Comfort Seating Systems allowing you to adjust the firmness of every ride
- The seating surface is covered in black top-grain leather combined with breathable spacer mesh durable fabric that will keep you cool while looking cool
- Dimensions: 15" W x 22" L Rider height 4"



### MINIMALIST SOLO LEATHER

- The MinimalIST Solo is styled narrow and sleek with minimal back support
- The seating surface is covered in black top-grain leather with a soft subtle texture
- The side panels are matching black vinyl that will keep its shape across the high-stress points of the seat
- Dimensions: 13.5" W x 22" L Rider height 4"



Designed with IST seating technology engineered to reduce the vibration, compression and shock the body feels from riding to enable longer more comfortable rides. Includes stress relief design features to reduce pressure points on the tail bone and prostate areas of the body so you focus on the experience of riding.

All Danny Gray seats are proudly made in the USA!



**TOURING IST SEATS CONT'D...**

Application	Year	Seat Type	WPS#
All models	'08-18	Buttcrack IST Solo Leather	<b>830-0126</b>
		LowIST 2-Up Leather	<b>830-0109</b>
		TourIST 2-Up Leather	<b>830-0121</b>
		TourIST Tall 2-Up Leather	<b>830-0124</b>



**BUTTCRACK IST SOLO LEATHER**

- Sculpted to maximize anatomical support and weight distribution
- Narrow leg pass
- Longer more comfortable rides
- Enhanced, sculpted tailbone relief insures the most comfortable ride possible on a sleek design saddle
- Dimensions: 12" W x " L Rider height"



**LOWIST 2-UP LEATHER**

- The LowIST 2-Up is styled low and narrow with a cut-down rear profile perfect for the rider seeking a low fit without compromising comfort
- The seating surface is covered in black top-grain leather with a soft subtle texture
- The side panels are matching black vinyl that will keep its shape across the high-stress points of the seat
- Dimensions: 13.5" W x 30.5" L Rider height 5.5" Passenger width 10" Passenger height 3"



**TOURIST 2-UP LEATHER**

- The TourIST 2-Up is a mid-touring style with a standard sized saddle and good back support for the rider seeking a traditional seat for long haul adventures
- The seating surface is covered in black top-grain leather with a soft subtle texture
- The side panels are matching black vinyl that will keep its shape across the high-stress points of the seat
- Dimensions: 14.5" W x 30.5" L Rider height 5.5" Passenger width 12" Passenger height 5"



**TOURIST TALL 2-UP LEATHER**

- Rider seat width 15.5 inches
- Passenger seat width 13.0 inches
- Developed for the rider who wants to sit back and lower with comfort
- Wider front and rear for max comfort with feel of the bike and road
- Lowest IST seat yet for the rider and passenger.
- Leather seating surface and tech-grade vinyl siding on Standard IST model

WINDSHIELDS / FAIRINGS  
 AUDIO / COMMUNICATION  
**SEATS / LUGGAGE**  
 BARS / MIRRORS / CONTROLS  
 EXHAUST  
 AIR / FUEL SYSTEMS  
 ENGINE  
 TRANSMISSION / DRIVELINE  
 GASKETS / SEALS  
 ELECTRICAL  
 LIGHTING  
 CABLES  
 BRAKES  
 OIL FILTERS  
 SUSPENSION  
 BODY  
 WHEELS  
 TIRES / TIRE ACC.  
 BIKE ACC.  
 VICTORY / INDIAN  
 COVERS / LOCKS / TIEDOWNS  
 CHEMICALS  
 TOOLS  
 HELMETS  
 HELMET ACC.  
 EYEWEAR  
 APPAREL / RIDER ACC.  
 PROMOTIONAL  
 REFERENCE  
 INDEX

Designed with IST seating technology engineered to reduce the vibration, compression and shock the body feels from riding to enable longer more comfortable rides. Includes stress relief design features to reduce pressure points on the tail bone and prostate areas of the body so you focus on the experience of riding.



All Danny Gray seats are proudly made in the USA!

## TOURING IST SEATS CONT'D...

Application	Year	Seat Type	WPS#
All models	'08-18	TourIST 2-Up Air-1	<b>830-0115</b>
		TourIST 2-Up Air-2	<b>830-0118</b>
		TourIST Tall 2-Up Air-2	<b>830-0125</b>
		Universal Backrest Receiver	<b>830-0129</b>
		Backrest Pad Small	<b>830-0127</b>
		Backrest Pad Large	<b>830-0128</b>

### TOURIST 2-UP AIR-1

- The TourIST 2-Up is a mid-touring style with a standard sized saddle and good back support for the rider seeking a traditional seat for long haul adventures
- Added comfort features include integrated DRY FLOATATION® air cell technology used in AIRHAWK® Comfort Seating Systems allowing you to adjust the firmness of every ride

- The seat is cover in a highly durable soft textured black vinyl
- Dimensions: 14.5" W x 30.5" L Rider height 5.5" Passenger width 12" Passenger height 5"



### TOURIST 2-UP AIR-2

- The TourIST 2-Up is a mid-touring style with a standard sized saddle and good back support for the rider seeking a traditional seat for long haul adventures
- Added comfort features include integrated DRY FLOATATION® air cell technology used in AIRHAWK® Comfort Seating Systems allowing you to adjust the firmness of every ride

- The seating surface is covered in black top-grain leather combined with breathable spacer mesh durable fabric that will keep you cool while looking cool
- Dimensions: 14.5" W x 30.5" L Rider height 5.5" Passenger width 12" Passenger height 5"



### TOURIST TALL 2-UP AIR-2

- The TourIST 2-Up is a mid-touring style with a standard sized saddle and good back support for the rider seeking a traditional seat for long haul adventures
- Added comfort features include integrated DRY FLOATATION® air cell technology used in AIRHAWK® Comfort Seating Systems allowing you to adjust the firmness of every ride

- The seating surface is covered in black top-grain leather combined with breathable spacer mesh durable fabric that will keep you cool while looking cool
- Dimensions: 15.5" W x 30.5" L Rider height 7.5" Passenger width 11.5" Passenger height 4"



### BACKREST W/UNIVERSAL RECEIVER

- Fits Harley Davidson Touring Models 2008– Present HD FLHR, T, X
- Leather surface/vinyl side panel
- Adjusts forward — back with screw adjustment
- Adjusts up — down six settings with allen bolt
- Contoured for back support



Designed with IST seating technology engineered to reduce the vibration, compression and shock the body feels from riding to enable longer more comfortable rides. Includes stress relief design features to reduce pressure points on the tail bone and prostate areas of the body so you focus on the experience of riding.



All Danny Gray seats are proudly made in the USA!

## SOFTAIL IST SEATS

Application	Year	Seat Type	WPS#
Softail models w/ 200mm tire	'06-17	BigIST Solo Leather	<b>830-0108</b>
		BigIST Solo Air-1	<b>830-0102</b>
		BigIST Solo Air-2	<b>830-0105</b>
		MinimalIST Solo Leather	<b>830-0114</b>



### BIGIST SOLO LEATHER

- The BigIST Solo is a wide saddle with moderate back support
- The seating surface is covered in black top-grain leather with a soft subtle texture
- The side panels are matching black vinyl that will keep its shape across the high-stress points of the seat
- Dimensions: 12" W x 22" L Rider height 7"



### BIGIST SOLO AIR-1

- The BigIST Solo is a wide saddle with moderate back support
- Added comfort features include integrated DRY FLOATATION® air cell technology used in AIRHAWK® Comfort Seating Systems allowing you to adjust the firmness of every ride
- The seat is cover in a highly durable soft textured black vinyl
- Dimensions: 12" W x 22" L Rider height 7"



### BIGIST SOLO AIR-2

- The BigIST Solo is a wide saddle with moderate back support
- Added comfort features include integrated DRY FLOATATION® air cell technology used in AIRHAWK® Comfort Seating Systems allowing you to adjust the firmness of every ride
- The seating surface is covered in black top-grain leather combined with breathable spacer mesh across the fabric that will keep you cool while looking cool
- Dimensions: 12" W x 22" L Rider height 7"



### MINIMALIST SOLO LEATHER

- The MinimalIST Solo is styled narrow and sleek with minimal back support
- Excellent for the weekend rider that prefers a classic old school look
- The seating surface is covered in black top-grain leather with a soft subtle texture
- The side panels are matching black vinyl that will keep its shape across the high-stress points of the seat
- Dimensions: 13" W x 19.5" L Rider height 6.5"

- WINDSHIELDS / FAIRINGS
- AUDIO / COMMUNICATION
- SEATS / LUGGAGE
- BARS / MIRRORS / CONTROLS
- EXHAUST
- AIR / FUEL SYSTEMS
- ENGINE
- TRANSMISSION / DRIVELINE
- GASKETS / SEALS
- ELECTRICAL
- LIGHTING
- CABLES
- BRAKES
- OIL FILTERS
- SUSPENSION
- BODY
- WHEELS
- TIRES / TIRE ACC.
- BIKE ACC.
- VICTORY / INDIAN
- COVERS / LOCKS / TIEDOWNS
- CHEMICALS
- TOOLS
- HELMETS
- HELMET ACC.
- EYEWEAR
- APPAREL / RIDER ACC.
- PROMOTIONAL
- REFERENCE
- INDEX

WINDSHIELDS / FAIRINGS  
 AUDIO / COMMUNICATION  
 SEATS / LUGGAGE  
 BARS / MIRRORS / CONTROLS  
 EXHAUST  
 AIR / FUEL SYSTEMS  
 ENGINE  
 TRANSMISSION / DRIVELINE  
 GASKETS / SEALS  
 ELECTRICAL  
 LIGHTING  
 CABLES  
 BRAKES  
 OIL FILTERS  
 SUSPENSION  
 BODY  
 WHEELS  
 TIRES / TIRE ACC.  
 BIKE ACC.  
 VICTORY / INDIAN  
 COVERS / LOCKS / TIEDOWNS  
 CHEMICALS  
 TOOLS  
 HELMETS  
 HELMET ACC.  
 EYEWEAR  
 APPAREL / RIDER ACC.  
 PROMOTIONAL  
 REFERENCE  
 INDEX



Designed with IST seating technology engineered to reduce the vibration, compression and shock the body feels from riding to enable longer more comfortable rides. Includes stress relief design features to reduce pressure points on the tail bone and prostate areas of the body so you focus on the experience of riding.



All Danny Gray seats are proudly made in the USA!

## SOFTAIL IST SEATS CONT'D...

Application	Year	Seat Type	WPS#
Softail models w/ 200mm tire	'06-17	LowIST 2-Up Leather	<b>830-0111</b>
		TourIST 2-Up Leather	<b>830-0123</b>
		TourIST 2-Up Air-1	<b>830-0117</b>
		TourIST 2-Up Air-2	<b>830-0120</b>

### LOWIST 2-UP LEATHER

- The LowIST 2-Up is styled low and narrow with a cut-down rear profile perfect for the rider seeking a low fit without compromising comfort
- The seating surface is covered in black top-grain leather with a soft subtle texture
- The side panels are matching black vinyl that will keep its shape across the high-stress points of the seat
- Dimensions: 13.5" W x 30.5" L Rider height 5.5" Passenger width 10" Passenger height 3"



### TOURIST 2-UP LEATHER

- The TourIST 2-Up is a mid-touring style with a standard sized saddle and good back support for the rider seeking a traditional seat for long haul adventures
- The seating surface is covered in black top-grain leather with a soft subtle texture
- The side panels are matching black vinyl that will keep its shape across the high-stress points of the seat
- Dimensions: 15.5" W x 30.5" L Rider height 5.5" Passenger width 11.5" Passenger height 4"



### TOURIST 2-UP AIR-2

- The TourIST 2-Up is a mid-touring style with a standard sized saddle and good back support for the rider seeking a traditional seat for long haul adventures
- Added comfort features include integrated DRY FLOATATION® air cell technology used in AIRHAWK® Comfort Seating Systems allowing you to adjust the firmness of every ride
- The seating surface is covered in black top-grain leather combined with breathable spacer mesh durable fabric that will keep you cool while looking cool
- Dimensions: 15.5" W x 30.5" L Rider height 7.5" Passenger width 11.5" Passenger height 4"



### TOURIST 2-UP AIR-1

- The TourIST 2-Up is a mid-touring style with a standard sized saddle and good back support for the rider seeking a traditional seat for long haul adventures
- Added comfort features include integrated DRY FLOATATION® air cell technology used in AIRHAWK® Comfort Seating Systems allowing you to adjust the firmness of every ride
- The seat is cover in a highly durable soft textured black vinyl
- Dimensions: 15.5" W x 30.5" L Rider height 7.5" Passenger width 11.5" Passenger height 4"



Designed with IST seating technology engineered to reduce the vibration, compression and shock the body feels from riding to enable longer more comfortable rides. Includes stress relief design features to reduce pressure points on the tail bone and prostate areas of the body so you focus on the experience of riding.



All Danny Gray seats are proudly made in the USA!

## DYNA IST SEATS

Application	Year	Seat Type	WPS#
All models	'06-17	BigIST Solo Leather	<b>830-0107</b>
		BigIST Solo Air-1	<b>830-0101</b>
		BigIST Solo Air-2	<b>830-0104</b>
		MinimalIST Solo Leather	<b>830-0113</b>



### BIGIST SOLO LEATHER

- The BigIST Solo is a wide saddle with moderate back support
- The seating surface is covered in black top-grain leather with a soft subtle texture
- The side panels are matching black vinyl that will keep its shape across the high-stress points of the seat
- Dimensions: 13.5" W x 19" L Rider height 4.5"



### BIGIST SOLO AIR-1

- The BigIST Solo is a wide saddle with moderate back support
- Added comfort features include integrated DRY FLOATATION® air cell technology used in AIRHAWK® Comfort Seating Systems allowing you to adjust the firmness of every ride
- The seat is cover in a highly durable soft textured black vinyl
- Dimensions: 13.5" W x 19" L Rider height 4"



### BIGIST SOLO AIR-2

- The BigIST Solo is a wide saddle with moderate back support
- Added comfort features include integrated DRY FLOATATION® air cell technology used in AIRHAWK® Comfort Seating Systems allowing you to adjust the firmness of every ride
- The seating surface is covered in black top-grain leather combined with breathable spacer mesh durable fabric that will keep you cool while looking cool
- Dimensions: 13.5" W x 19" L Rider height 4"



### MINIMALIST SOLO LEATHER

- The MinimalIST Solo is styled narrow and sleek with minimal back support
- Excellent for the weekend rider that prefers a classic old school look
- The seating surface is covered in black top-grain leather with a soft subtle texture
- The side panels are matching black vinyl that will keep its shape across the high-stress points of the seat
- Dimensions: 12" W x 18.5" L Rider height 4"

- WINDSHIELDS / FAIRINGS
- AUDIO / COMMUNICATION
- SEATS / LUGGAGE**
- BARS / MIRRORS / CONTROLS
- EXHAUST
- AIR / FUEL SYSTEMS
- ENGINE
- TRANSMISSION / DRIVELINE
- GASKETS / SEALS
- ELECTRICAL
- LIGHTING
- CABLES
- BRAKES
- OIL FILTERS
- SUSPENSION
- BODY
- WHEELS
- TIRES / TIRE ACC.
- BIKE ACC.
- VICTORY / INDIAN
- COVERS / LOCKS / TIEDOWNS
- CHEMICALS
- TOOLS
- HELMETS
- HELMET ACC.
- EYEWEAR
- APPAREL / RIDER ACC.
- PROMOTIONAL
- REFERENCE
- INDEX

WINDSHIELDS / FAIRINGS  
 AUDIO / COMMUNICATION  
 SEATS / LUGGAGE  
 BARS / MIRRORS / CONTROLS  
 EXHAUST  
 AIR / FUEL SYSTEMS  
 ENGINE  
 TRANSMISSION / DRIVELINE  
 GASKETS / SEALS  
 ELECTRICAL  
 LIGHTING  
 CABLES  
 BRAKES  
 OIL FILTERS  
 SUSPENSION  
 BODY  
 WHEELS  
 TIRES / TIRE ACC.  
 BIKE ACC.  
 VICTORY / INDIAN  
 COVERS / LOCKS / TIEDOWNS  
 CHEMICALS  
 TOOLS  
 HELMETS  
 HELMET ACC.  
 EYEWEAR  
 APPAREL / RIDER ACC.  
 PROMOTIONAL  
 REFERENCE  
 INDEX



Designed with IST seating technology engineered to reduce the vibration, compression and shock the body feels from riding to enable longer more comfortable rides. Includes stress relief design features to reduce pressure points on the tail bone and prostate areas of the body so you focus on the experience of riding.



All Danny Gray seats are proudly made in the USA!

## DYNA IST SEATS CONT'D...

Application	Year	Seat Type	WPS#
All models	'06-17	LowIST 2-Up Leather	<b>830-0110</b>
		TourIST 2-Up Leather	<b>830-0122</b>
		TourIST 2-Up Air-1	<b>830-0116</b>
		TourIST 2-Up Air-2	<b>830-0119</b>

### LOWIST 2-UP LEATHER

- The LowIST 2-Up is styled low and narrow with a cut-down rear profile perfect for the rider seeking a low fit without compromising comfort
- The seating surface is covered in black top-grain leather with a soft subtle texture
- The side panels are matching black vinyl that will keep its shape across the high-stress points of the seat
- Dimensions: 12" W x 29" L Rider height 5" Passenger width 10" Passenger height 3"



### TOURIST 2-UP LEATHER

- The TourIST 2-Up is a mid-touring style with a standard sized saddle and good back support for the rider seeking a traditional seat for long haul adventures
- The seating surface is covered in black top-grain leather with a soft subtle texture
- The side panels are matching black vinyl that will keep its shape across the high-stress points of the seat
- Dimensions: 15.5" W x 30.5" L Rider height 5.5" Passenger width 11.5" Passenger height 4"



### TOURIST 2-UP AIR-1

- The TourIST 2-Up is a mid-touring style with a standard sized saddle and good back support for the rider seeking a traditional seat for long haul adventures
- Added comfort features include integrated DRY FLOATATION® air cell technology used in
- AIRHAWK® Comfort Seating Systems allowing you to adjust the firmness of every ride
- The seat is cover in a highly durable soft textured black vinyl
- Dimensions: 15.5" W x 30.5" L Rider height 7.5" Passenger width 11.5" Passenger height 4"



### TOURIST 2-UP AIR-2

- The TourIST 2-Up is a mid-touring style with a standard sized saddle and good back support for the rider seeking a traditional seat for long haul adventures
- Added comfort features include integrated DRY FLOATATION® air cell technology used in AIRHAWK® Comfort Seating Systems allowing you to adjust the firmness of every ride
- The seating surface is covered in black top-grain leather combined with breathable spacer mesh durable fabric that will keep you cool while looking cool
- Dimensions: 15.5" W x 30.5" L Rider height 7.5" Passenger width 11.5" Passenger height 4"







## STANDARD SEATS

Application	Description	WPS#
'08-Up Touring models	Short Hop 2up XL	<b>830-0151</b>
	Weekday 2up	<b>830-0152</b>
'08-15 FXS/FLS	Buttcrack Solo	<b>830-0149</b>
	Speed Cradle solo	<b>830-0150</b>



### SHORT HOP 2-UP XL

- Low profile
- Sits 2" back from stock seat (in relation to the handlebars)
- Passenger seat hugs the fender and accentuates curvature of the bike
- Ideal for riders who have occasional passengers



### WEEKDAY 2-UP

- Low profile
- Sits 2" back from stock seat (in relation to the handlebars)
- Provides lower-back support while maintaining a sleek design
- Hugs the frame and matches the fender width
- Ideal for riders who have occasional passengers



### BUTTCRACK SOLO

- Most popular model
- Very low profile
- Sits 2" back from stock seat (in relation to the handlebars)
- Hugs the contours of your body
- "Breaks In" to mold the shape of your body after 1,000 miles



### SPEED CRADLE SOLO

- Low Profile
- Provides comfort and support for improved stability
- Sits at stock seat distance from handlebars
- Ideal for riders under 5'8"

WINDSHIELDS / FAIRINGS

AUDIO / COMMUNICATION

SEATS / LUGGAGE

BARS / MIRRORS / CONTROLS

EXHAUST

AIR / FUEL SYSTEMS

ENGINE

TRANSMISSION / DRIVELINE

GASKETS / SEALS

ELECTRICAL

LIGHTING

CABLES

BRAKES

OIL FILTERS

SUSPENSION

BODY

WHEELS

TIRES / TIRE ACC.

BIKE ACC.

VICTORY / INDIAN

COVERS / LOCKS / TIEDOWNS

CHEMICALS

TOOLS

HELMETS

HELMET ACC.

EYEWEAR

APPAREL / RIDER ACC.

PROMOTIONAL

REFERENCE

INDEX

**HardDrive**  
AMERICAN V-TWIN PRODUCTS



WINDSHIELDS / FAIRINGS  
AUDIO / COMMUNICATION  
SEATS / LUGGAGE  
BARS / MIRRORS / CONTROLS  
EXHAUST  
AIR / FUEL SYSTEMS  
ENGINE  
TRANSMISSION / DRIVELINE  
GASKETS / SEALS  
ELECTRICAL  
LIGHTING  
CABLES  
BRAKES  
OIL FILTERS  
SUSPENSION  
BODY  
WHEELS  
TIRES / TIRE ACC.  
BIKE ACC.  
VICTORY / INDIAN  
COVERS / LOCKS / TIEDOWNS  
CHEMICALS  
TOOLS  
HELMETS  
HELMET ACC.  
EYEWEAR  
APPAREL / RIDER ACC.  
PROMOTIONAL  
REFERENCE  
INDEX

#### Mercedes Grain leather seating surface:

- Leather has a special WATERPROOF finish to repel water
- Heavy Texture grain for great looks & long term durability
- Each leather hide is cut by hand to create the best hide for each individual saddle

#### Automotive Grade Vinyl Side Panels:

- Vinyl is used on the sides of the seat because it can expand & contract continuously with the seat
- Automotive grade vinyl used to deter abrasion
- Passes automotive UV application standards
- Passes automotive mildew standards

#### Full Felt Bottom:

- Provides a nice finish to the entire bottom side of the seat

#### Premium Open Cell Foam Cushion:

- Offers added support & comfort for a great ride
- No break in period needed
- The Premium Open Cell Foam used resists all breakdown & foam degrading

#### Zinc/Chrome Plated Mounting Hardware:

- Prevents rust

## TOURING/ BAGGER SEATS

### CAFÉ 2-UP XL

- Low, thin & fast!
- Shaped leg passage for narrow fit
- Excellent lower back support
- Streamline, tapered seat back is great for a quick ride home for your passenger



### HIGHWAY 2-UP XL

- The low riders position combined with the large comfort seating for the passenger came together to create the ultimate in a low profile touring seat
- Narrowed-leg passage for slim front fit
- The deep bucket riders saddle offers excellent lower back support
- Standard or flame stitch patterns



### ROADTRIP 2-UP XL

- Low, deep & well cushioned the RoadTrip 2-Up XL is the ultimate touring saddles
- Riders saddle is deep comfortable for long rides and has a narrowed leg passage for a trim fit
- Large comfortable passenger seating
- Standard and flame stitch patterns



[See page 92 for application chart](#)

**TOURING/ BAGGER SEATS CONT'D...**

**RIDGEBACK PILLION**

- Integrated form fit to RidgeBack solo seat
- Visible center "Ridge" for custom fit
- Large suction cups & zinc/chrome plated mounting hardware
- Standard or flame stitch patterns
- 9" wide seating surface

**KING SOLO**

- Deep bucket design for added comfort
- Low, deep riding position with center support "Ridge" brings rider deeper into the saddle for a custom fit
- Superior lower back support
- Shaped leg passage for a narrow fit
- Standard or flame stitch patterns

**SHOTGUN 9" & 12" PILLIONS**

- Integrated form fit pillion(s) for "King" Solo seat
- 9" or 12" wide seating surface
- 2 chrome tabs on front that "hook" to the bottom of the rider seat, rear chrome tab mounts to rear fender
- Standard or Flame stitch patterns

**PUSH-UP SOLO**

- Pushes rider down and forward approximately 2 inches
- Excellent for shorter leg riders
- Shaped leg passage for narrow fit
- Added lower back support
- Raised seat tip area keeps rider locked into the saddle
- Standard or flame stitch patterns

**PUSH-UP PILLION**

- Integrated form fit to "Push-UP" Solo seat
- 9" wide seating surface
- Large suction cups and zinc/chrome plated mounting hardware
- Standard or Flame stitch patterns

[See page 92 for application chart](#)

WINDSHIELDS / FAIRINGS

AUDIO / COMMUNICATION

SEATS / LUGGAGE

BARS / MIRRORS / CONTROLS

EXHAUST

AIR / FUEL SYSTEMS

ENGINE

TRANSMISSION / DRIVELINE

GASKETS / SEALS

ELECTRICAL

LIGHTING

CABLES

BRAKES

OIL FILTERS

SUSPENSION

BODY

WHEELS

TIRES / TIRE ACC.

BIKE ACC.

VICTORY / INDIAN

COVERS / LOCKS / TIEDOWNS

CHEMICALS

TOOLS

HELMETS

HELMET ACC.

EYEWEAR

APPAREL / RIDER ACC.

PROMOTIONAL

REFERENCE

INDEX



**TOURING/ BAGGER SEATS CONT'D...**

**TOURPAK KING TOUR BOX PADS**

- Full king style for the ultimate in Touring comfort
- Fits stock Tour Pak Box

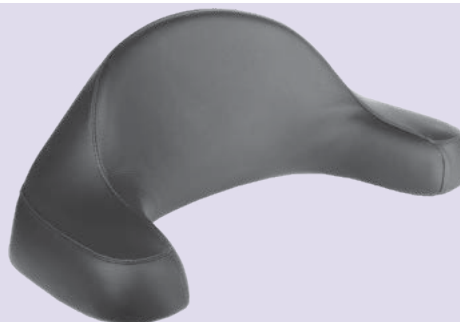

**PASSENGER BACK REST PAD**

- Large sissy bar pad
- Smooth or Flame



**CHOPPED TOUR PAK BACKREST PAD**

- Low-profile, sleek passenger backrest
- Superior comfort plus the custom "Chopped" look



**APPLICATION CHART**

Application	Year	Seat Type	WPS#	Pillion	Pillion Width
<b>TOURING MODELS</b>					
All models	'08-18	Ridgeback Solo smooth		<b>810-8129</b>	9"
		Ridgeback Solo flame		<b>810-8129F</b>	9"
		Push-Up Solo smooth		<b>810-8189</b>	9"
		Push-Up Solo flame		<b>810-8189F</b>	9"
		King Solo flame	<b>810-8209F</b>		
		Shotgun Pillion smooth (designed to fit with King Solo)		<b>810-8229</b>	9"
		Shotgun Pillion flame (designed to fit with King Solo)		<b>810-8229F</b>	9"
		Shotgun Pillion smooth (designed to fit with King Solo)		<b>810-8249</b>	12"
		Shotgun Pillion flame (designed to fit with King Solo)		<b>810-8249F</b>	12"
		Highway 2up XL flame		<b>810-8309F</b>	
RoadTrip 2up XL smooth		<b>810-8329</b>			
RoadTrip 2up XL flame		<b>810-8329F</b>			
FLHT/C/U and FLTR	'97-07	Ridgeback Solo smooth		<b>810-8129</b>	9"
		Ridgeback Solo flame		<b>810-8129F</b>	9"
		PushUp Solo smooth		<b>810-8185</b>	9"
		PushUp Solo flame		<b>810-8185F</b>	9"
All years equipped w/ tourpak or sissy bar		King Tourpak Backrest pad smooth	<b>810-8001</b>		
		Sissy bar Backrest pad smooth	<b>810-8002</b>		
		Sissy bar Backrest pad flame	<b>810-8002F</b>		
Harley Chopped Tourpak	'91-13	Chopped Tourpak back rest pad	<b>830-0148</b>		



**Mercedes Grain leather seating surface:**

- Leather has a special WATERPROOF finish to repel water
- Heavy Texture grain for great looks & long term durability
- Each leather hide is cut by hand to create the best hide for each individual saddle

**Automotive Grade Vinyl Side Panels:**

- Vinyl is used on the sides of the seat because it can expand & contract continuously with the seat
- Automotive grade vinyl used to deter abrasion
- Passes automotive UV application standards
- Passes automotive mildew standards

**Full Felt Bottom:**

- Provides a nice finish to the entire bottom side of the seat

**Premium Open Cell Foam Cushion:**

- Offers added support & comfort for a great ride
- No break in period needed
- The Premium Open Cell Foam used resists all breakdown & foam degrading

**Zinc/Chrome Plated Mounting Hardware:**

- Prevents rust

WINDSHIELDS / FAIRINGS  
 AUDIO / COMMUNICATION  
**SEATS / LUGGAGE**  
 BARS / MIRRORS / CONTROLS  
 EXHAUST  
 AIR / FUEL SYSTEMS  
 ENGINE  
 TRANSMISSION / DRIVELINE  
 GASKETS / SEALS  
 ELECTRICAL  
 LIGHTING  
 CABLES  
 BRAKES  
 OIL FILTERS  
 SUSPENSION  
 BODY  
 WHEELS  
 TIRES / TIRE ACC.  
 BIKE ACC.  
 VICTORY / INDIAN  
 COVERS / LOCKS / TIEDOWNS  
 CHEMICALS  
 TOOLS  
 HELMETS  
 HELMET ACC.  
 EYEWEAR  
 APPAREL / RIDER ACC.  
 PROMOTIONAL  
 REFERENCE  
 INDEX

**SOFTAIL '06 + SEATS**



**RIDGEBACK SOLO**

- Visible center support "Ridge" designed to custom fit a rider's body, bringing the rider into the saddle
- Low seating position with shaped leg passage for a narrow fit
- Added lower back support
- Standard or flame stitch patterns



**PUSH-UP SOLO**

- Pushes rider down & forward approximately 2 inches
- Excellent for shorter leg riders
- Shaped leg passage for narrow fit
- Added lower back support
- Raised seat tip area keeps rider locked into the saddle
- Standard or flame stitch patterns

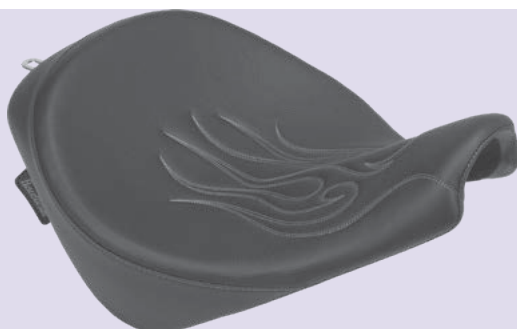

**KING SOLO**

- Deep bucket design for added comfort
- Low, deep riding position with center support "Ridge" brings rider deeper into the saddle for a custom fit
- Superior lower back support
- Shaped leg passage for a narrow fit
- Standard or flame stitch patterns



**SHOTGUN 9" & 12" PILLIONS**

- Integrated form fit pillion(s) for "King" Solo seat
- 9" or 12" wide seating surface
- 2 chrome tabs on front that "hook" to the bottom of the rider seat, rear chrome tab mounts to rear fender
- Standard or Flame stitch patterns

12"

[See page 94 for application chart](#)

WINDSHIELDS / FAIRINGS  
 AUDIO / COMMUNICATION  
**SEATS / LUGGAGE**  
 BARS / MIRRORS / CONTROLS  
 EXHAUST  
 AIR / FUEL SYSTEMS  
 ENGINE  
 TRANSMISSION / DRIVELINE  
 GASKETS / SEALS  
 ELECTRICAL  
 LIGHTING  
 CABLES  
 BRAKES  
 OIL FILTERS  
 SUSPENSION  
 BODY  
 WHEELS  
 TIRES / TIRE ACC.  
 BIKE ACC.  
 VICTORY / INDIAN  
 COVERS / LOCKS / TIEDOWNS  
 CHEMICALS  
 TOOLS  
 HELMETS  
 HELMET ACC.  
 EYEWEAR  
 APPAREL / RIDER ACC.  
 PROMOTIONAL  
 REFERENCE  
 INDEX



## SOFTAIL '06+ SEATS CONT'D...

### CAFÉ 2-UP XL

- Low, thin & fast!
- Shaped leg passage for narrow fit
- Excellent lower back support
- Streamline, tapered seat back is great for a quick ride home for your passenger
- Standard and flame stitch patterns



### HIGHWAY 2-UP XL

- Low, thin & fast!
- Shaped leg passage for narrow fit
- Excellent lower back support
- Streamline, tapered seat back is great for a quick ride home for your passenger
- Standard and flame stitch patterns



### APPLICATION CHART

Year	Seat Type	WPS#	Pillion	Pillion width
<b>ALL SOFTAIL MODELS W/200MM REAR TIRE*</b>				
'06-17	Ridgeback Solo smooth	<b>810-8101</b>		
	Ridgeback Solo flame	<b>810-8101F</b>		
	PushUp Solo flame	<b>810-8161F</b>		
	King Solo smooth	<b>810-8201</b>		
	King Solo flame	<b>810-8201F</b>		
	Shotgun Pillion smooth (designed to fit with King Solo)		<b>810-8221</b>	9"
	Shotgun Pillion flame (designed to fit with King Solo)		<b>810-8221F</b>	9"
	Shotgun Pillion smooth (designed to fit with King Solo)		<b>810-8241</b>	12"
	Shotgun Pillion flame (designed to fit with King Solo)		<b>810-8241F</b>	12"
	Cafe 2up XL smooth	<b>810-8261</b>		
	Cafe 2up XL flame	<b>810-8261F</b>		
	Highway 2up XL smooth	<b>810-8301</b>		
	Highway 2up XL flame	<b>810-8301F</b>		

**\* Notes**

- FXST,FXSTC,FXSTS,FXSTB and FLSTF '07
- Will not fit FLSTC,FLSTN and FXSTD



**Mercedes Grain leather seating surface:**

- Leather has a special WATERPROOF finish to repel water
- Heavy Texture grain for great looks & long term durability
- Each leather hide is cut by hand to create the best hide for each individual saddle

**Automotive Grade Vinyl Side Panels:**

- Vinyl is used on the sides of the seat because it can expand & contract continuously with the seat
- Automotive grade vinyl used to deter abrasion
- Passes automotive UV application standards
- Passes automotive mildew standards

**Full Felt Bottom:**

- Provides a nice finish to the entire bottom side of the seat

**Premium Open Cell Foam Cushion:**

- Offers added support & comfort for a great ride
- No break in period needed
- The Premium Open Cell Foam used resists all breakdown & foam degrading

**Zinc/Chrome Plated Mounting Hardware:**

- Prevents rust

**SOFTAIL '08+ SEATS  
(INCLUDING -08 FLSTN & FLSTC)**

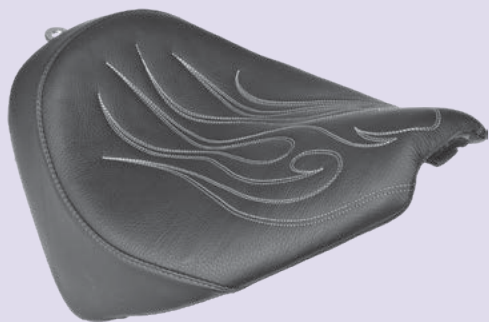

**RIDGEBACK SOLO**

- Visible center support "Ridge" designed to custom fit a rider's body, bringing the rider into the saddle
- Low seating position with shaped leg passage for a narrow fit
- Added lower back support
- Standard or flame stitch patterns



**KING SOLO**

- Deep bucket design for added comfort
- Low, deep riding position with center support "Ridge" brings rider deeper into the saddle for a custom fit
- Superior lower back support
- Shaped leg passage for a narrow fit
- Standard or flame stitch patterns



**HIGHWAY 2-UP**

- Low and deep for the rider plus great daily use comfort for the passenger
- Sleek look while still offering a comfortable passenger ride
- Shaped leg passage for narrow fit
- Standard and flame stitch patterns

**APPLICATION CHART**

Year	Seat Type	WPS#
<b>FLSTC AND FLSTN</b>		
'08-17	Ridgeback Solo smooth	<b>810-8102</b>
	Ridgeback Solo flame	<b>810-8102F</b>
	King Solo smooth	<b>810-8202</b>
	King Solo flame	<b>810-8202F</b>
	Highway 2Up smooth	<b>810-8282</b>
	Highway 2Up flame	<b>810-8282F</b>

WINDSHIELDS / FAIRINGS  
 AUDIO / COMMUNICATION  
**SEATS / LUGGAGE**  
 BARS / MIRRORS / CONTROLS  
 EXHAUST  
 AIR / FUEL SYSTEMS  
 ENGINE  
 TRANSMISSION / DRIVELINE  
 GASKETS / SEALS  
 ELECTRICAL  
 LIGHTING  
 CABLES  
 BRAKES  
 OIL FILTERS  
 SUSPENSION  
 BODY  
 WHEELS  
 TIRES / TIRE ACC.  
 BIKE ACC.  
 VICTORY / INDIAN  
 COVERS / LOCKS / TIEDOWNS  
 CHEMICALS  
 TOOLS  
 HELMETS  
 HELMET ACC.  
 EYEWEAR  
 APPAREL / RIDER ACC.  
 PROMOTIONAL  
 REFERENCE  
 INDEX

WINDSHIELDS / FAIRINGS  
 AUDIO / COMMUNICATION  
**SEATS / LUGGAGE**  
 BARS / MIRRORS / CONTROLS  
 EXHAUST  
 AIR / FUEL SYSTEMS  
 ENGINE  
 TRANSMISSION / DRIVELINE  
 GASKETS / SEALS  
 ELECTRICAL  
 LIGHTING  
 CABLES  
 BRAKES  
 OIL FILTERS  
 SUSPENSION  
 BODY  
 WHEELS  
 TIRES / TIRE ACC.  
 BIKE ACC.  
 VICTORY / INDIAN  
 COVERS / LOCKS / TIEDOWNS  
 CHEMICALS  
 TOOLS  
 HELMETS  
 HELMET ACC.  
 EYEWEAR  
 APPAREL / RIDER ACC.  
 PROMOTIONAL  
 REFERENCE  
 INDEX



**Mercedes Grain leather seating surface:**

- Leather has a special WATERPROOF finish to repel water
- Heavy Texture grain for great looks & long term durability
- Each leather hide is cut by hand to create the best hide for each individual saddle

**Automotive Grade Vinyl Side Panels:**

- Vinyl is used on the sides of the seat because it can expand & contract continuously with the seat
- Automotive grade vinyl used to deter abrasion
- Passes automotive UV application standards
- Passes automotive mildew standards

**Full Felt Bottom:**

- Provides a nice finish to the entire bottom side of the seat

**Premium Open Cell Foam Cushion:**

- Offers added support & comfort for a great ride
- No break in period needed
- The Premium Open Cell Foam used resists all breakdown & foam degrading

**Zinc/Chrome Plated Mounting Hardware:**

- Prevents rust

**SLIM & BLACKLINE**

**RIDGEBACK SOLO**

- Visible Center support “Ridge” designed to custom fit a rider's body, bringing the rider into the saddle
- Low seating position with shaped leg passage for a narrow fit
- Added lower back support
- Standard or flame stitch patterns



**RIDGEBACK PILLION**

- Integrated form fit to RidgeBack Solo and Push-Up Solo seats
- Visible center “Ridge” for custom fit
- Large suction cups & zinc/chrome plated mounting hardware
- Standard or flame stitch patterns
- 9” wide seating surface



**HIGHWAY 2-UP XL**

- Low, thin & fast!
- Shaped leg passage for narrow fit
- Excellent lower back support
- Streamline, tapered seat back is great for a quick ride home for your passenger
- Standard and flame stitch patterns



**APPLICATION CHART**

Year	Seat Type	WPS#	Pillion	Pillion Width
<b>SOFTAIL SLIM AND BLACKLINE</b>				
All years up to '17	Ridgeback flame		<b>810-8184F</b>	9"
	Highway 2-Up XL smooth	<b>810-8304</b>		





**HardDrive**  
AMERICAN V-TWIN PRODUCTS

**Mercedes Grain leather seating surface:**

- Leather has a special WATERPROOF finish to repel water
- Heavy Texture grain for great looks & long term durability
- Each leather hide is cut by hand to create the best hide for each individual saddle

**Automotive Grade Vinyl Side Panels:**

- Vinyl is used on the sides of the seat because it can expand & contract continuously with the seat
- Automotive grade vinyl used to deter abrasion
- Passes automotive UV application standards
- Passes automotive mildew standards

**Full Felt Bottom:**

- Provides a nice finish to the entire bottom side of the seat

**Premium Open Cell Foam Cushion:**

- Offers added support & comfort for a great ride
- No break in period needed
- The Premium Open Cell Foam used resists all breakdown & foam degrading

**Zinc/Chrome Plated Mounting Hardware:**

- Prevents rust

## DYNA '06+ SEATS



### RIDGEBACK SOLO

- Visible Center support "ridge" designed to custom fit a rider's body, bringing the rider into the saddle
- Low seating position with shaped leg passage for a narrow fit
- Added lower back support
- Standard or flame stitch patterns



### RIDGEBACK PILLION

- Integrated form fit to RidgeBack Solo Seat
- Visible center "Ridge" for custom fit
- Large suction cups & zinc/chrome plated mounting hardware
- Standard or flame stitch patterns
- 9" wide seating surface



### PUSH-UP SOLO

- Pushes rider down and forward approximately 2 inches
- Excellent for shorter leg riders
- Shaped leg passage for narrow fit
- Added lower back support
- Raised seat tip area keeps rider locked into the saddle
- Standard or flame stitch patterns



### KING SOLO

- Deep bucket design for added comfort
- Low, deep riding position with center support "Ridge" brings rider deeper into the saddle for a custom fit
- Superior lower back support
- Shaped leg passage for a narrow fit
- Standard or flame stitch patterns



### SHOTGUN 9" & 12" PILLIONS

- Integrated form fit pillion(s) for "King" Solo seat
- 9" or 12" wide seating surface
- 2 chrome tabs on front that "hook" to the bottom of the rider seat, rear chrome tab mounts to rear fender
- Standard or Flame stitch patterns

[See page 98 for application chart](#)

- WINDSHIELDS / FAIRINGS
- AUDIO / COMMUNICATION
- SEATS / LUGGAGE**
- BARS / MIRRORS / CONTROLS
- EXHAUST
- AIR / FUEL SYSTEMS
- ENGINE
- TRANSMISSION / DRIVELINE
- GASKETS / SEALS
- ELECTRICAL
- LIGHTING
- CABLES
- BRAKES
- OIL FILTERS
- SUSPENSION
- BODY
- WHEELS
- TIRES / TIRE ACC.
- BIKE ACC.
- VICTORY / INDIAN
- COVERS / LOCKS / TIEDOWNS
- CHEMICALS
- TOOLS
- HELMETS
- HELMET ACC.
- EYEWEAR
- APPAREL / RIDER ACC.
- PROMOTIONAL
- REFERENCE
- INDEX



## DYNA '06+ SEATS CONT'D...

### CAFÉ 2-UP XL

- Low, thin & fast!
- Shaped leg passage for narrow fit
- Excellent lower back support
- Streamline, tapered seat back is great for a quick ride home for your passenger



### HIGHWAY 2-UP

- Low and deep for the rider plus great daily use comfort for the passenger
- Sleek look while still offering comfortable passenger ride
- Shaped leg passage for narrow fit
- Standard and flame stitch patterns



### HIGHWAY 2-UP XL

- The Low riders position combined with the large comfort seating for the passenger came together to create the ultimate in a low profile touring seat
- Narrowed leg passage for slim front fit
- The deep bucket riders saddle offers excellent lower back support
- Standard or flame stitch patterns



## APPLICATION CHART

Year	Seat Type	Solo	Pillion	Pillion Width
<b>DYNA</b>				
'06-17	RidgeBack Solo smooth	<b>810-8105</b>	<b>810-8125</b>	9"
	RidgeBack Solo flame	<b>810-8105F</b>	<b>810-8125F</b>	9"
	PushUp Solo smooth	<b>810-8165</b>		
	PushUp Solo flame	<b>810-8165F</b>		
EYEWEAR	King Solo smooth	<b>810-8205</b>		
	King Solo flame	<b>810-8205F</b>		
APPAREL / RIDER ACC.	Shotgun Pillion smooth (designed to fit with King Solo)		<b>810-8245</b>	12"
	Shotgun Pillion flame (designed to fit with King Solo)		<b>810-8245F</b>	12"
PROMOTIONAL	Cafe 2up XL smooth	<b>810-8265</b>		
	Cafe 2up XL flame	<b>810-8265F</b>		
REFERENCE	Highway 2up smooth	<b>810-8285</b>		
	Highway 2up flame	<b>810-8285F</b>		
	Highway 2up XL smooth	<b>810-8305</b>		
INDEX	Highway 2up XL flame	<b>810-8305F</b>		



WINDSHIELDS / FAIRINGS  
 AUDIO / COMMUNICATION  
**SEATS / LUGGAGE**  
 BARS / MIRRORS / CONTROLS  
 EXHAUST  
 AIR / FUEL SYSTEMS  
 ENGINE  
 TRANSMISSION / DRIVELINE  
 GASKETS / SEALS  
 ELECTRICAL  
 LIGHTING  
 CABLES  
 BRAKES  
 OIL FILTERS  
 SUSPENSION  
 BODY  
 WHEELS  
 TIRES / TIRE ACC.  
 BIKE ACC.  
 VICTORY / INDIAN  
 COVERS / LOCKS / TIEDOWNS  
 CHEMICALS  
 TOOLS  
 HELMETS  
 HELMET ACC.  
 EYEWEAR  
 APPAREL / RIDER ACC.  
 PROMOTIONAL  
 REFERENCE  
 INDEX

**Mercedes Grain leather seating surface:**

- Leather has a special WATERPROOF finish to repel water
- Heavy Texture grain for great looks & long term durability
- Each leather hide is cut by hand to create the best hide for each individual saddle

**Automotive Grade Vinyl Side Panels:**

- Vinyl is used on the sides of the seat because it can expand & contract continuously with the seat
- Automotive grade vinyl used to deter abrasion
- Passes automotive UV application standards
- Passes automotive mildew standards

**Full Felt Bottom:**

- Provides a nice finish to the entire bottom side of the seat

**Premium Open Cell Foam Cushion:**

- Offers added support & comfort for a great ride
- No break in period needed
- The Premium Open Cell Foam used resists all breakdown & foam degrading

**Zinc/Chrome Plated Mounting Hardware:**

- Prevents rust

**SPORTSTER '04+ (883/1200 4.5 GAL TANK)**



**HIGHWAY SOLO**

- Medium deep bucket design
- Low & comfortable solo for daily use
- Added lower back support
- Shaped leg passage for narrow fit
- Standard or flame stitch patterns



**KING SOLO**

- Deep bucket design for added comfort
- Low, deep riding position with center support "Ridge" brings rider deeper into the saddle for a custom fit
- Superior lower back support
- Shaped leg passage for a narrow fit
- Standard or Flame stitch patterns



**SHOTGUN PILLION**

- Integrated form fit pillion(s) for "King" Solo seat
- 9" wide seating surface
- Large suction cups & zinc/chrome plated mounting hardware
- Standard or flame stitch patterns

[See page 100 for application chart](#)

WINDSHIELDS / FAIRINGS  
 AUDIO / COMMUNICATION  
**SEATS / LUGGAGE**  
 BARS / MIRRORS / CONTROLS  
 EXHAUST  
 AIR / FUEL SYSTEMS  
 ENGINE  
 TRANSMISSION / DRIVELINE  
 GASKETS / SEALS  
 ELECTRICAL  
 LIGHTING  
 CABLES  
 BRAKES  
 OIL FILTERS  
 SUSPENSION  
 BODY  
 WHEELS  
 TIRES / TIRE ACC.  
 BIKE ACC.  
 VICTORY / INDIAN  
 COVERS / LOCKS / TIEDOWNS  
 CHEMICALS  
 TOOLS  
 HELMETS  
 HELMET ACC.  
 EYEWEAR  
 APPAREL / RIDER ACC.  
 PROMOTIONAL  
 REFERENCE  
 INDEX



**SPORTSTER '04+  
 (883/1200 4.5 GAL TANK) CONT'D...**

**CAFÉ 2-UP XL**

- Low, thin & fast!
- Shaped leg passage for narrow fit
- Excellent lower back support
- Streamline, tapered seat back is great for a quick ride home for your passenger
- Standard and flame stitch patterns



**HIGHWAY 2-UP**

- Low and deep for the rider plus great daily use comfort for the passenger
- Sleek look while still offering comfortable passenger ride
- Shaped leg passage for narrow fit
- Standard and flame stitch patterns



**HIGHWAY 2-UP XL**

- The Low riders position combined with the large comfort seating for the passenger came together to create the ultimate in a low profile touring seat
- Narrowed leg passage for slim front fit
- The deep bucket riders saddle offers excellent lower back support
- Standard or flame stitch patterns



**APPLICATION CHART**

Year	Seat Type	WPS#	Pillion	Pillion Width
<b>XL MODELS EQUIPPED W/4.5 GAL FUEL TANK</b>				
'04-18	Highway Solo smooth	<b>810-8146</b>		
	Highway Solo flame	<b>810-8146F</b>		
EYEWEAR	King Solo smooth	<b>810-8206</b>		
	King Solo flame	<b>810-8206F</b>		
APPAREL / RIDER ACC.	ShotGun Pillion smooth (designed to fit with the King Solo)		<b>810-8226</b>	9"
	ShotGun Pillion flame (designed to fit with the King Solo)		<b>810-8226F</b>	9"
PROMOTIONAL	Cafe 2up XL smooth	<b>810-8266</b>		
	Cafe 2up XL flame	<b>810-8266F</b>		
REFERENCE	Highway 2up smooth	<b>810-8286</b>		
	Highway 2up flame	<b>810-8286F</b>		
INDEX	Highway 2up XL smooth	<b>810-8306</b>		
	Highway 2up XL flame	<b>810-8306F</b>		



WINDSHIELDS / FAIRINGS  
 AUDIO / COMMUNICATION  
**SEATS / LUGGAGE**  
 BARS / MIRRORS / CONTROLS  
 EXHAUST  
 AIR / FUEL SYSTEMS  
 ENGINE  
 TRANSMISSION / DRIVELINE  
 GASKETS / SEALS  
 ELECTRICAL  
 LIGHTING  
 CABLES  
 BRAKES  
 OIL FILTERS  
 SUSPENSION  
 BODY  
 WHEELS  
 TIRES / TIRE ACC.  
 BIKE ACC.  
 VICTORY / INDIAN  
 COVERS / LOCKS / TIEDOWNS  
 CHEMICALS  
 TOOLS  
 HELMETS  
 HELMET ACC.  
 EYEWEAR  
 APPAREL / RIDER ACC.  
 PROMOTIONAL  
 REFERENCE  
 INDEX

**Mercedes Grain leather seating surface:**

- Leather has a special WATERPROOF finish to repel water
- Heavy Texture grain for great looks & long term durability
- Each leather hide is cut by hand to create the best hide for each individual saddle

**Automotive Grade Vinyl Side Panels:**

- Vinyl is used on the sides of the seat because it can expand & contract continuously with the seat
- Automotive grade vinyl used to deter abrasion
- Passes automotive UV application standards
- Passes automotive mildew standards

**Full Felt Bottom:**

- Provides a nice finish to the entire bottom side of the seat

**Premium Open Cell Foam Cushion:**

- Offers added support & comfort for a great ride
- No break in period needed
- The Premium Open Cell Foam used resists all breakdown & foam degrading

**Zinc/Chrome Plated Mounting Hardware:**

- Prevents rust

**SPORTSTER '04+ (883/1200 3.3 GAL TANK)**



**HIGHWAY SOLO**

- Medium deep bucket design
- Low & comfortable solo for daily use
- Added lower back support
- Shaped leg passage for narrow fit
- Standard or flame stitch patterns



**KING SOLO**

- Deep bucket design for added comfort
- Low, deep riding position with center support Ridge brings rider deeper into the saddle for a custom fit
- Superior lower back support
- Shaped leg passage for a narrow fit
- Standard or flame stitch patterns



**SHOTGUN 9" & 12" PILLIONS**

- Integrated form fit pillion(s) for "King" Solo seat
- 9" or 12" wide seating surface
- 2 chrome tabs on front that "hook" to the bottom of the rider seat, rear chrome tab mounts to rear fender
- Standard or Flame stitch patterns

[See page 102 for application chart](#)



**SPORTSTER '04+  
(883/1200 3.3 GAL TANK) CONT'D...**

**CAFÉ 2-UP XL**

- Low, thin & fast!
- Shaped leg passage for narrow fit
- Excellent lower back support
- Streamline, tapered seat back is great for a quick ride home for your passenger
- Standard and flame stitch patterns



**HIGHWAY 2-UP**

- Low and deep for the rider plus great daily use comfort for the passenger
- Sleek look while still offering a comfortable passenger ride
- Shaped leg passage for narrow fit
- Standard and flame stitch patterns



**HIGHWAY 2-UP XL**

- The Low riders position combined with the large comfort seating for the passenger came together to create the ultimate in a low profile touring seat
- Narrowed leg passage for slim front fit
- The deep bucket riders saddle offers excellent lower back support
- Standard or flame stitch patterns



**APPLICATION CHART**

Year	Seat Type	WPS#	Pillion	Pillion Width
<b>XL MODELS EQUIPPED W/ 3.3GAL FUEL TANK</b>				
'04-18	Highway Solo smooth	<b>810-8147</b>		
	Highway Solo flame	<b>810-8147F</b>		
EYEWEAR	King Solo smooth	<b>810-8207</b>		
	King Solo flame	<b>810-8207F</b>		
APPAREL / RIDER ACC.	ShotGun Pillion smooth (designed to fit with the King Solo)		<b>810-8226</b>	9"
	ShotGun Pillion flame (designed to fit with the King Solo)		<b>810-8226F</b>	9"
PROMOTIONAL	Cafe 2up XL smooth	<b>810-8267</b>		
	Cafe 2up XL flame	<b>810-8267F</b>		
REFERENCE	Highway 2up smooth	<b>810-8287</b>		
	Highway 2up flame	<b>810-8287F</b>		
INDEX	Highway 2up XL smooth	<b>810-8307</b>		
	Highway 2up XL flame	<b>810-8307F</b>		



Mercedes Grain leather seating surface:

- Leather has a special WATERPROOF finish to repel water
- Heavy Texture grain for great looks & long term durability
- Each leather hide is cut by hand to create the best hide for each individual saddle

Automotive Grade Vinyl Side Panels:

- Vinyl is used on the sides of the seat because it can expand & contract continuously with the seat
- Automotive grade vinyl used to deter abrasion
- Passes automotive UV application standards
- Passes automotive mildew standards

Full Felt Bottom:

- Provides a nice finish to the entire bottom side of the seat

Premium Open Cell Foam Cushion:

- Offers added support & comfort for a great ride
- No break in period needed
- The Premium Open Cell Foam used resists all breakdown & foam degrading

Zinc/Chrome Plated Mounting Hardware:

- Prevents rust

## SPORTSTER 48 SEATS



### RIDGEBACK SOLO

- Visible center support "Ridge" designed to custom fit a rider's body, bringing the rider into the saddle
- Low seating position with shaped leg passage for a narrow fit
- Added Lower back support
- Standard or flame stitch patterns



### HIGHWAY 2-UP

- Low and deep for the rider plus great daily use comfort for the passenger
- Sleek look while still offering comfortable passenger ride
- Shaped leg passage for narrow fit
- Standard and flame stitch patterns

## APPLICATION CHART

Year	Seat Type	WPS#
<b>XL1200X</b>		
'10-18	RidgeBack Solo smooth	<b>810-8108</b>
	RidgeBack Solo flame	<b>810-8108F</b>
	Highway 2up smooth	<b>810-8288</b>
	Highway 2up flame	<b>810-8288F</b>

- WINDSHIELDS / FAIRINGS
- AUDIO / COMMUNICATION
- SEATS / LUGGAGE**
- BARS / MIRRORS / CONTROLS
- EXHAUST
- AIR / FUEL SYSTEMS
- ENGINE
- TRANSMISSION / DRIVELINE
- GASKETS / SEALS
- ELECTRICAL
- LIGHTING
- CABLES
- BRAKES
- OIL FILTERS
- SUSPENSION
- BODY
- WHEELS
- TIRES / TIRE ACC.
- BIKE ACC.
- VICTORY / INDIAN
- COVERS / LOCKS / TIEDOWNS
- CHEMICALS
- TOOLS
- HELMETS
- HELMET ACC.
- EYEWEAR
- APPAREL / RIDER ACC.
- PROMOTIONAL
- REFERENCE
- INDEX

WINDSHIELDS / FAIRINGS  
 AUDIO / COMMUNICATION  
**SEATS / LUGGAGE**  
 BARS / MIRRORS / CONTROLS  
 EXHAUST  
 AIR / FUEL SYSTEMS  
 ENGINE  
 TRANSMISSION / DRIVELINE  
 GASKETS / SEALS  
 ELECTRICAL  
 LIGHTING  
 CABLES  
 BRAKES  
 OIL FILTERS  
 SUSPENSION  
 BODY  
 WHEELS  
 TIRES / TIRE ACC.  
 BIKE ACC.  
 VICTORY / INDIAN  
 COVERS / LOCKS / TIEDOWNS  
 CHEMICALS  
 TOOLS  
 HELMETS  
 HELMET ACC.  
 EYEWEAR  
 APPAREL / RIDER ACC.  
 PROMOTIONAL  
 REFERENCE  
 INDEX



**SOLO SEATS** **NEW**

- West Eagle solo seats are a perfect match for their Sportster custom fender kits but will also work on stock bikes
- High grade vinyl cover material is easily maintained

Application	WPS#
<b>SOLO GUNFIGHTER SEATS FOR '04-UP SPORTSTERS</b>	
A Smooth	<b>750-01550</b>
B Deluxe	<b>750-01551</b>
C Diamond	<b>750-01552</b>
D Tuck & Roll	<b>750-01553</b>
<b>SOLO COBRA SEATS FOR '04-06 AND '10-UP SPORTSTERS</b>	
E Diamond	<b>750-01554</b>
F Tuck & Roll	<b>750-01555</b>
G Pleated	<b>750-01556</b>



A



B



C



D



E



F



G



**SEAT SCREWS**



Stepped



Nasty



Crusader

- Nylon washer included
- Rear bolts sold each
- Side bolts sold in pairs
- Made in USA

Description	WPS#
<b>SIDE SEAT BOLTS (SOFTAIL)</b>	
Vertical Lines	<b>850-05050</b>
Nasty	<b>850-05051</b>

Description	WPS#
<b>REAR SEAT BOLT FINE THREAD</b>	
Stepped Fine	<b>850-05052</b>
Nasty Fine	<b>850-05053</b>
Crusader Fine	<b>850-05054</b>

Description	WPS#
<b>REAR SEAT BOLT COARSE THREAD</b>	
Stepped Coarse	<b>850-05055</b>
Nasty Coarse	<b>850-05056</b>
Crusader Coarse	<b>850-05057</b>

**SEAT SCREWS**



- Models 96-Up require 1/4"-20 thread pitch
- Pre-96 models use the 1/4"-28 thread



820-5700



820-5701



820-5702



820-5703



820-5704



820-5705



820-5706



820-5707



820-5708



820-5709

Description	Chrome	Black
Quarter Turn Thumb Screw 1/4"-28	<b>820-57000</b>	<b>820-57001</b>
Quarter Turn Thumb Screw 1/4"-20	<b>820-57002</b>	<b>820-57003</b>
Knurled Seat Knob 1/4"-28	<b>820-57006</b>	<b>820-57007</b>
Knurled Seat Knob 1/4"-20	<b>820-57004</b>	<b>820-57005</b>
Knurled Seat Knob 1/4"-28, Stepped	<b>820-57008</b>	<b>820-57009</b>
Rear Seat Tab Assembly with Screw (1/4"-20)	<b>820-1511</b>	



**REAR SEAT MOUNTS**

Description	WPS #
Quick Release Seat Mount 1/4"-28 Thread	<b>820-1510</b>
Rear Seat Tab Assembly with Screw (1/4"-20)	<b>820-1511</b>

WINDSHIELDS / FAIRINGS  
 AUDIO / COMMUNICATION  
**SEATS / LUGGAGE**  
 BARS / MIRRORS / CONTROLS  
 EXHAUST  
 AIR / FUEL SYSTEMS  
 ENGINE  
 TRANSMISSION / DRIVELINE  
 GASKETS / SEALS  
 ELECTRICAL  
 LIGHTING  
 CABLES  
 BRAKES  
 OIL FILTERS  
 SUSPENSION  
 BODY  
 WHEELS  
 TIRES / TIRE ACC.  
 BIKE ACC.  
 VICTORY / INDIAN  
 COVERS / LOCKS / TIEDOWNS  
 CHEMICALS  
 TOOLS  
 HELMETS  
 HELMET ACC.  
 EYEWEAR  
 APPAREL / RIDER ACC.  
 PROMOTIONAL  
 REFERENCE  
 INDEX

- WINDSHIELDS / FAIRINGS
- AUDIO / COMMUNICATION
- SEATS / LUGGAGE**
- BARS / MIRRORS / CONTROLS
- EXHAUST
- AIR / FUEL SYSTEMS
- ENGINE
- TRANSMISSION / DRIVELINE
- GASKETS / SEALS
- ELECTRICAL
- LIGHTING
- CABLES
- BRAKES
- OIL FILTERS
- SUSPENSION
- BODY
- WHEELS
- TIRES / TIRE ACC.
- BIKE ACC.
- VICTORY / INDIAN
- COVERS / LOCKS / TIEDOWNS
- CHEMICALS
- TOOLS
- HELMETS
- HELMET ACC.
- EYEWEAR
- APPAREL / RIDER ACC.
- PROMOTIONAL
- REFERENCE
- INDEX



## SOLO SEATS

Sully's Customs, known for building some of the finest bobbers out there have come out with a line of fine US made solo seats. These seats are hand crafted from durable vinyl on 3/4" foam for that slim look while still retaining rider comfort. Choose between different classic stitch patterns and traditional smooth designs. Available in three colors. Mount using front seat hinge and springs (sold separately).

Seat Type	Black	White	Red
A Traditional	880-10100	880-10103	
B Diamond Stitch	880-10101	880-10104	880-10106
C Tuck & Roll	880-10102	880-10105	880-10107



A



B



C



Red



White

## SIGNATURE SOLO SEATS

These seats are the newest addition to Sully's Customs line of solo seats. Additional stitching and inlays set them apart and add that extra touch. Made in the USA from the same quality materials that Sully's seats are known for.

Seat Type	Black
A Tuck & Roll	880-10150
B Arch	880-10151
C Diamond	880-10152



A



B



C

## SIGNATURE SOLO SEATS

Complete that Sporty bobber build with one of Sully's Customs solo or dual seats. Available with diamond or tuck & roll stitching. Handcrafted in the USA out of durable vinyl and high density foam on a steel base plate. For '82-03 Sportsters.

Seat Type	Solo	2-Up
A Diamond Stitch	880-10200	880-10202
B Tuck & Roll	880-10201	880-10203



A



B



2-UP



2-UP



### VINTAGE WIDE SEAT

- Classic solo seat contour with narrow front and wide back
- 13.5" long and 11.5" wide
- Kicks up in the back for support
- Follows shape of rigid and Softail frames nicely
- Vinyl cover with 3/8" thick foam padding for a sleek low profile look

Seat Type	WPS#
Thin	750-01561



A



B



C



D

### SMALL BACK SEATS

- For the narrow chopper
- 12" Long and 10" wide
- Available in different stitch designs or plain black
- Vinyl cover with injected urethane foam

Seat Type	WPS#
A Traditional	750-01501
B Thin	750-01502
C Diamond Stitch	750-01503
D Tuck & Roll	750-01504



A



B



C

### SMALL FLAT SEAT

- Flatter profile than the small back seats
- 12.5" long and 9.5" Wide
- Available with different stitch designs or plain
- Vinyl cover with injected urethane foam

Seat Type	WPS#
A Traditional	750-01541
B Tuck & Roll	750-01542
C Diamond Stitch	750-01543

- WINDSHIELDS / FAIRINGS
- AUDIO / COMMUNICATION
- SEATS / LUGGAGE**
- BARS / MIRRORS / CONTROLS
- EXHAUST
- AIR / FUEL SYSTEMS
- ENGINE
- TRANSMISSION / DRIVELINE
- GASKETS / SEALS
- ELECTRICAL
- LIGHTING
- CABLES
- BRAKES
- OIL FILTERS
- SUSPENSION
- BODY
- WHEELS
- TIRES / TIRE ACC.
- BIKE ACC.
- VICTORY / INDIAN
- COVERS / LOCKS / TIEDOWNS
- CHEMICALS
- TOOLS
- HELMETS
- HELMET ACC.
- EYEWEAR
- APPAREL / RIDER ACC.
- PROMOTIONAL
- REFERENCE
- INDEX



## NARROW BACK SEAT

- Narrow and long seat for choppers and bobbers
- 13.8" Long and 9.5" wide
- Available in different stitch designs including the ever popular white diamond stitch lace design
- Vinyl cover with injected urethane foam

Seat Type	WPS#
A Traditional	750-01522
B Tuck & Roll	750-01521
C Diamond Stitch	750-01520
D Lace-Up White Stitch	750-01523



A



B



C



D

## SEAT PADS

- Universal pillion seat pads with suction cups
- Available in three styles
- Vinyl cover material with injected urethane foam
- Ultra flat pad dimensions: L 10.5" x W 5.5", Thickness 5/8"
- Standard pad dimensions: L 10.5" x W 5.5", Thickness 2"
- Deluxe pad dimensions: L 10.25" x W 5.7", Thickness 2"-3" (front to back)

Pad Type	WPS#
A Ultra Flat	750-01580
B Standard	750-01581
C Deluxe	750-01582



B



A

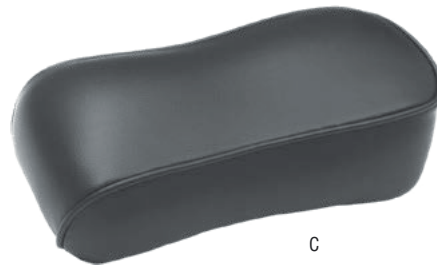

C



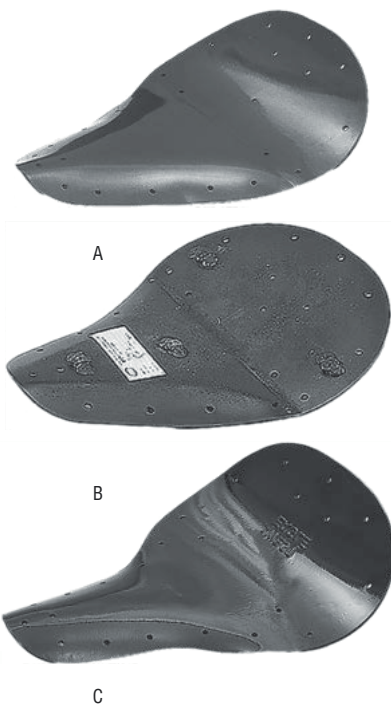

### SOLO SEAT BASES

- Create your own seat with these steel seat bases
- Three styles to choose from
- Add padding, cover material and mounting kit of your choice
- Small Back is 12" x 10"
- Narrow Back is 13.5" x 9.5"
- Vintage Wide is 13.5" x 11.5"

Seat Type	WPS#
A Small Back	750-01500
B Narrow Back	750-01540
C Vintage Wide	750-01560



### FRONT SEAT MOUNTS

- Heavy duty steel front solo seat mounts
- For use with West Eagle solo seats and many other custom solo seats

Description	WPS #
A Front Seat Pivot	750-01006
B Front Seat Mount	750-01007
C Round Front Seat Mount	750-01008



### SEAT SUSPENSION

Mix old school with new school by using this 4" seat shock instead of traditional springs to mount your solo seat. Dual shock mounting bracket (seat side).

- Billet aluminum body
- Spring rate 300lbs per inch
- Fitting bolts included
- Sold each

Description	WPS#
A Single Seat Shock 4"	750-01000
B Dual Seat Shock Bracket (Seat Side)	750-01005



- WINDSHIELDS / FAIRINGS
- AUDIO / COMMUNICATION
- SEATS / LUGGAGE**
- BAR / MIRRORS / CONTROLS
- EXHAUST
- AIR / FUEL SYSTEMS
- ENGINE
- TRANSMISSION / DRIVELINE
- GASKETS / SEALS
- ELECTRICAL
- LIGHTING
- CABLES
- BRAKES
- OIL FILTERS
- SUSPENSION
- BODY
- WHEELS
- TIRES / TIRE ACC.
- BIKE ACC.
- VICTORY / INDIAN
- COVERS / LOCKS / TIEDOWNS
- CHEMICALS
- TOOLS
- HELMETS
- HELMET ACC.
- EYEWEAR
- APPAREL / RIDER ACC.
- PROMOTIONAL
- REFERENCE
- INDEX



## SOLO SEAT MOUNTING KITS

These kits make the clean installation of a sprung solo seat a cinch. The kits include a frame cover, front seat mount, springs, (unless solid mount application) rear bracket and hardware. Suitable for most solo seats (sold separately) with 7" spring mounting post spacing.

- Black steel brackets
- Black gel coated fiberglass frame covers
- 2" seat springs (where applicable) included



Application	WPS#
A Softail Models '08-Up (w/swingarm mounted fender)	750-01017
B Softail Models '08-Up (except Slim and Blackline)	750-01016
C Softail Models '07 only (except Deuce)	750-01015
D Softail Models '00-06 (except Deuce and models w/200mm tire)	750-01014
E Dyna Models '06-Up	750-01010
F Dyna Models '91-05 (spring or solid mount)	750-01011
G Sportster Models '04-06 and '10-Up (spring mount only)	750-01012
H Sportster Models '04-06 and '10-Up (solid mount only)	750-01013



## SOLO SEAT MOUNTING KIT

- TC Bros. Choppers solo seat spring mounts are CNC machined from 1018 cold rolled steel and are ready to weld on
- Stud is 3/8" diameter and base is 1" diameter with a 1 1/8" radius coped into the mount
- Easily fits 1" and 1 1/4" cross tubes
- Includes a pair of hairpins, steel washers, and leather washers to keep your springs quiet and protect your paint
- The pivot bracket is made from one piece of 3/16" steel for the ultimate in strength and simplicity
- Long slotted holes permit a wide range of fitments and allow for adjustability

- The bracket is a black powdercoat finish for durability
- The weld-on pivot mount is raw finish steel and ready to weld
- The hardware is stainless steel
- The replaceable bushings are oil impregnated bronze for a squeak free ride and very long life.
- Fitment possibilities are nearly endless

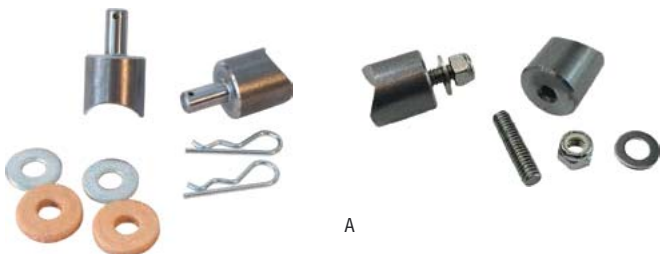

A

	Description	WPS#
A	Solo Seat Spring Mounts, Pinned	563-01200
	Solo Seat Spring Mounts, Threaded	563-01209
B	Weld-On Front Solo Seat Pivot	563-01201
	Solo Seat Mounting Kit (with 3" springs)	563-01202
	Solo Seat Mounting Kit (With 4" Springs)	563-01203
	Solo Seat Mounting Kit (with 5" springs)	563-01204
	Solo Seat Mounting Kit (with 3" torsion springs)	563-01210
C	3 Inch Seat Springs (pair)	563-01205
D	4 Inch Seat Springs (pair)	563-01206
E	5 Inch Seat Springs (pair)	563-01207
F	3" Torsion Seat Springs (pair)	563-01208



B



C



D



E



F

## AIR RIDE SOLO SEAT BRACKETS

- This kit provides the ultimate in comfort, vibration dampening, and adjustability for your hardtailed chopper or bobber
- Single or dual compact rubber air springs available
- The air spring uses a bicycle style schrader fill valve
- Easily inflate the air spring from 1psi-100psi depending on rider weight and desired firmness
- This kit gives you a 2.1" length of travel comparable to a set of 3" seat springs but with better vibration damping
- No "metal on metal" contact!

- Slotted mounting holes on the 1/4" thick steel seat bracket allows universal fitment
- The seat bracket is powdercoated black for durability
- Weld-on frame mounting bracket is formed from one piece of steel
- The frame mounting bracket is coped for perfect fitment on 1 1/8" diameter frame tubing but can easily fit 1" or 1 1/4" crossmembers as well
- The frame bracket is raw finish mild steel for easy weldability



A



B



	Description	WPS#
A	Air Ride Solo Seat Bracket Kit	563-01300
B	Dual Air Ride Solo Seat Kit	563-01301

WINDSHIELDS / FAIRINGS

AUDIO / COMMUNICATION

SEATS / LUGGAGE

BAR / MIRRORS / CONTROLS

EXHAUST

AIR / FUEL SYSTEMS

ENGINE

TRANSMISSION / DRIVELINE

GASKETS / SEALS

ELECTRICAL

LIGHTING

CABLES

BRAKES

OIL FILTERS

SUSPENSION

BODY

WHEELS

TIRES / TIRE ACC.

BIKE ACC.

VICTORY / INDIAN

COVERS / LOCKS / TIEDOWNS

CHEMICALS

TOOLS

HELMETS

HELMET ACC.

EYEWEAR

APPAREL / RIDER ACC.

PROMOTIONAL

REFERENCE

INDEX



## RIGID SEATS

TC Bros. Cobra hardtail chopper seats feature quality American construction and timeless looks. Handmade in the USA, these seats are designed to be a perfect fit to our 1982-03 Sportster weld-on hardtails using our mounting kit, fender, and sissy bar (sold separately). Six 5/16-18 threaded mounts on the heavy 14 ga powder coated steel seat pan make it possible to fit these seats to many other hardtail frames as well. Hand stitched from 100% Marine grade vinyl, these seats look like leather but without the maintenance.



Pleated Solo

Diamond Stitch King Cobra

Pleated Cobra

Pleated King Cobra

Seat Type	Solo	Cobra	King Cobra
A Pleated	<b>563-01254</b>	<b>563-01252</b>	<b>563-01250</b>
B Diamond Stitch	<b>563-01255</b>	<b>563-01253</b>	<b>563-01251</b>

### RIGID SEAT MOUNT KIT

Everything you need to mount your TC Bros. King Cobra Seat. Weld on bracket is coped to fit our Sportster hardtail perfectly. Mounts are slotted if you want to use this for a universal/custom use.



Description	WPS#
King Cobra Seat Mount Kit	<b>563-01211</b>





## REAR SEAT PADS

Nothing will ever provide long distance riding comfort for the motorcycle passenger like a full size seat. The posterior support of a large 13" wide seating area is complemented by an ergonomically correct shape that eliminates pressure on the tail bone!

The ButtyBuddy motorcycle seat provides passengers on-demand comfort when riding on bikes with small pillions or bare fenders. The portable 3 piece seat comes with its own tote and snaps together in seconds, providing correct shape and width necessary for enjoying those long road trips. Thousands have been freed from serious numb-bun pain, and ButtyBuddy will work for you too. This isn't just another motorcycle seat pad, it's a ButtyBuddy!

- **WIDTH** - Butty Buddy is a huge 13.5 inches wide. That's wider than 86% of the pillions on expensive aftermarket seats. Gel pads and Air cushions cannot increase seating width
- **SHAPE** - Butty Buddy's ergonomic shape minimizes pressure at the tail bone. 90% of all aftermarket seat pillions are shaped wrong. Pads and cushions cannot modify seat shape
- **WARRANTY** - ButtyBuddy is unconditionally warranted for a lifetime. Very few expensive aftermarket seats, gel pads or air cushions dare to offer a warranty like ours



Description	WPS#
Butty Buddy for Over Existing Seat Application	823-10001
Butty Buddy for Bare Fender Application with Suction Cups	823-10002

- WINDSHIELDS / FAIRINGS
- AUDIO / COMMUNICATION
- SEATS / LUGGAGE**
- BARS / MIRRORS / CONTROLS
- EXHAUST
- AIR / FUEL SYSTEMS
- ENGINE
- TRANSMISSION / DRIVELINE
- GASKETS / SEALS
- ELECTRICAL
- LIGHTING
- CABLES
- BRAKES
- OIL FILTERS
- SUSPENSION
- BODY
- WHEELS
- TIRES / TIRE ACC.
- BIKE ACC.
- VICTORY / INDIAN
- COVERS / LOCKS / TIEDOWNS
- CHEMICALS
- TOOLS
- HELMETS
- HELMET ACC.
- EYEWEAR
- APPAREL / RIDER ACC.
- PROMOTIONAL
- REFERENCE
- INDEX



## SEAT CUSHIONS

Developed by a pioneer in the medical industry, the technology used in the Airhawk seat cushion was originally developed to prevent pressure injuries of patients who were bed-ridden or confined to a wheelchair. By using interconnected cells, the Airhawk cushion can adapt to the individual contours of the rider, and distribute weight in a way regular seats and pads can't. The non-slip surface on the underside of the pad sits securely on the top of the seat, and also comes with attachment loops for semipermanent mounting and security.

### The last mile will feel like the first!!

- Stress Relief design features reduced pressure points on the tail bone, scrotum and prostate areas
- Cell heights on front lowered for better leg passage
- Ergonomically form fitting design allows better conformity to a multitude of seat shapes and sizes
- The cover is a breathable spacer mesh cloth material w/red vinyl accent, non-skid bottom material
- The inner bladder is manufactured out of Polyurethane
- Airhawk seat cushions have a 2 year warranty



#### Available in six sizes:

- Cruiser R Small: will fit Sport Touring, Sport Bikes, Dual Sports, Standards, and non-Touring Harleys
- Cruiser R Large: Big Cruisers, H-D Touring models and non-H-D Touring models.
- Medium cruiser: fits Big Cruisers, Sport Touring, Standards, and Non-Touring Harleys
- Cruiser pillion: fits passenger seats of Sport touring, Dual Sport, Standards and Non-Touring Harleys.
- DualSport: fits dual sport bikes as well as hard-to-fit seats where the Cruiser and Medium Cruiser are too wide and the Small Cruiser is too long



Fitment	Size	WPS#
Sport Touring, Sport Bikes, Dual Sports, and non-Touring H-D	18" L x 12" W	86-9505



Fitment	Size	WPS#
Big Cruisers, H-D Touring and non H-D Touring	14" L x 14½" W	86-9510



Fitment	Size	WPS#
Big Cruisers, Sport Touring, Standards, and non-Touring H-D	14" L x 14" W	86-9506



Fitment	Size	WPS#
Dual Sport and hard-to-fit seats	11" L x 11" W	86-9511



Fitment	Size	WPS#
Passenger seats: Sport Touring, Dual Sport, Standards, and non-Touring H-D	11" L x 9" W	86-9507



Fitment	Size	WPS#
Sport Touring, Sport Bikes, Dual Sport, Standards, and non-Touring H-D	11" L x 11" W	86-9512

# QUILTED DIAMOND *The Pro Pad* MESH SEAT PAD

- Micro spacer fabric provides a neutral temperature seating surface
- Quilted, Diamond Mesh material with foam backing is breathable and adds to comfort
- This motorcycle seat pad has Pro Pad's 1/2" thick medical grade polymer gel insert inside to reduce vibration while supporting the rider
- Improves the ride by fighting off rear end fatigue
- Seat pad has non-slip bottom and comes with straps
- 2 year MFG replacement warranty against defects
- 30-day money back guarantee
- Color: Black
- Sizes are approximate



Description	WPS#
A Large top pad 16" W x 12" L x 3/4" H	816-0012
B Medium top pad 14" W x 10" L x 3/4" H	816-0011
C Small top pad 7" x 10" L x 3/4" H	816-0013
D Supercruzer top pad 16" W x 17" L x 3/4" H	816-0014
Replacement Straps	816-0010



A

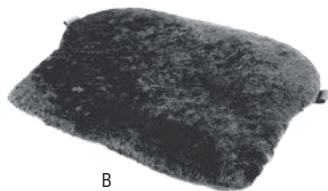

B



C

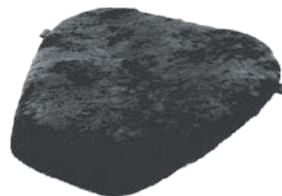

D



E

## SHEEPSKIN GEL SEAT PADS

- Great for Rider and Passenger seats
- Genuine sheepskin is super luxurious and functional
- Natural fiber that repels water, keeps you cooler in the heat and warmer in the cold
- Pro Pad seat pads are made of medical-grade polymer
- Each motorcycle pad comes with a 30 day money back guarantee

Description	WPS#
A Large top pad 16" W x 12" L x 1 1/4" H	816-0002
B Medium top pad 14" W x 10" L x 1"	816-0001
C Small top pad 7" W x 10" L x 1" H	816-0003
D Supercruzer top pad 16" W x 17" L x 1 1/4" H	816-0004
E Touring top pad 16 1/2" W x 14" L x 1 1/4" H	816-0005
Replacement Straps	816-0010

- WINDSHIELDS / FAIRINGS
- AUDIO / COMMUNICATION
- SEATS / LUGGAGE**
- BARS / MIRRORS / CONTROLS
- EXHAUST
- AIR / FUEL SYSTEMS
- ENGINE
- TRANSMISSION / DRIVELINE
- GASKETS / SEALS
- ELECTRICAL
- LIGHTING
- CABLES
- BRAKES
- OIL FILTERS
- SUSPENSION
- BODY
- WHEELS
- TIRES / TIRE ACC.
- BIKE ACC.
- VICTORY / INDIAN
- COVERS / LOCKS / TIEDOWNS
- CHEMICALS
- TOOLS
- HELMETS
- HELMET ACC.
- EYEWEAR
- APPAREL / RIDER ACC.
- PROMOTIONAL
- REFERENCE
- INDEX



## MOTORCYCLE LUGGAGE SYSTEM

- Mix and match each luggage to take only the amount of storage you need
- The unique attachment mechanisms let each bag connect to one another to “build” more luggage storage when you need it
- Attaches to virtually any bike and a wide variety of luggage racks and backrests
- Pack for weekend trips or add more for week-long rallies
- Convenient “His and Hers” luggage set-up
- Easily separate clean from soiled clothes
- Store “wet” gear or bike cover used from “dry” clean clothes and other items

- Separate “riding gear” from “destination items” for added convenience
- Made from durable 1680 polyester
- Each piece includes a rain hood
- Rain hood is made from 300 denier polyester with heat taped waterproof seams

### UNIVERSAL RAIN HOOD

- Protects virtually all sissy bar mounted luggage from the elements
- Unique compression system for a snug fit regardless of the luggage size
- 300 denier polyester with heat taped waterproof seams



A & B



A



B



C



D

	Description	Dimensions	WPS#
A	Main Bag	20" x 11" x 11"	27-6340
B	Overnighter Bag	14" x 9" x 10½"	27-6341
C	Roll Bag	14" x 6½" x 10½"	27-6344
D	Universal Rain Hood	Most sissy bar mounted luggage systems	27-6230

## Rally Pack

### LUGGAGE SET

- Combines the Rally Pack Roll Bag and Jumbo Pack in one part number

#### WPS#

**27-6210**





## TOURING BAGS



### WPS#

A 27-6342

B 27-6349

C 27-6343

D 27-6348



### A. QUEST TOUR RACK BAG

- 1680D Polyester construction, water resistant zippers
- Black reflective piping for added nighttime visibility and safety, external D-rings for added functionality
- Integrated universal mounting system with (4) quick release buckles
- Soft lined top storage pocket, ideal for sunglasses multiple internal mesh storage pockets
- Front pocket organizer, (2) large external side pocket
- Rain cover with optional expansion
- Dual side carrying handles and one top carrying handle
- 43L Capacity, 55L expanded capacity



### B. RUMBLE TAIL BAG

- Two bags in one: large base bag, with optional small bag for added storage or use as a solo bag
- Ready to take on the elements with a water resistant zipper through out
- 1680D polyester construction, MOLLE webbing for modular pouch attachment, (4) 1" quick release buckles for mounting
- Black reflective piping for added nighttime visibility and safety
- (2) large external pockets with elastic straps for storing tools
- 5" bottom, drop down expansion both sides
- Abrasion resistant non-slip material on bottom of bag
- Includes rain covers for each bag
- 38L Anchor bag capacity
- 7L Optional top roll bag capacity, 12L expanded



### C. WEEKENDER SISSY BAR BAG

- 1680D Polyester construction, water resistant zippers
- Internal protective storage sleeve for laptop, soft-lined waterproof sunglass storage pocket
- Large front pocket with multiple storage pocket, (4) external side pockets
- Hidden backpack straps to easily convert to backpack
- Reinforced carrying handle, external D-rings
- Black reflective piping for safety at night
- (2) Snap shackles hooks for quick access
- Includes rain cover
- 29L Capacity



### D. BRUTE LARGE SISSY BAR BAG

- 1680D Polyester construction
- Large capacity main compartment, (2) large external pockets, (2) small soft lined pockets for abrasion resistant storage
- Mesh internal pockets, with Laptop sleeve
- Black reflective piping for added nighttime visibility and safety
- (4) 1" quick release buckles for mounting
- Zipper removes top compartment dividing wall to accommodate large objects
- Non-slip Dowco dot pattern material on bottom
- External D-rings for added functionality and storage options
- Rain cover with optional expansion
- 58L Capacity

WINDSHIELDS / FAIRINGS

AUDIO / COMMUNICATION

SEATS / LUGGAGE

BARS / MIRRORS / CONTROLS

EXHAUST

AIR / FUEL SYSTEMS

ENGINE

TRANSMISSION / DRIVELINE

GASKETS / SEALS

ELECTRICAL

LIGHTING

CABLES

BRAKES

OIL FILTERS

SUSPENSION

BODY

WHEELS

TIRES / TIRE ACC.

BIKE ACC.

VICTORY / INDIAN

COVERS / LOCKS / TIEDOWNS

CHEMICALS

TOOLS

HELMETS

HELMET ACC.

EYEWEAR

APPAREL / RIDER ACC.

PROMOTIONAL

REFERENCE

INDEX



## TOURING BAGS

WPS#

E 27-6351

F 27-6352

### E. FRENZY TAIL BAG

- Bag can be mounted directly on the rear fender, rear seat or luggage rack
- Water-resistant zippers throughout
- MOLLE webbing for modular pouch attachment
- Four 1" quick release buckles for mounting
- Large external pockets
- Black reflective piping for nighttime visibility
- No conversion straps required to mount additional bags on top
- Abrasion resistant non-slip material on bottom of bag
- 16L capacity
- Rain cover included
- Exterior Dimensions 10" x 10" x 10"



### F. MESSENGER

- The perfect messenger bag for work and play
- Water-resistant zippers throughout
- Features mounting straps for sissy bar or luggage rack
- Padded reinforcements throughout, carry handle and shoulder strap
- Soft lined external pockets for delicate items
- Black reflective piping for nighttime visibility
- Multiple internal pockets for laptop (up to 15"), tablet and other items
- Exterior Dimensions 16.5" x 12.5" x 6.75"



### SVT-750 / SVT-250 ALL-WEATHER SURVIVOR

- Electronically heat welded seams makes this bag 100% waterproof
- Air tight roll closure ensures no water enters the bag
- Compression straps easily adjust to volume of content
- Made from waterproof and durable 24oz Tarpaulin PVC
- Firm internal base plate helps support bag
- Coated outer material prevents slipping or marking
- Hi-Visibility reflective accents
- Attaches using our unique "Full-Nelson" mounting system
- Included roll bag can be mounted separately
- Includes a Lifetime "No Hassle" warranty
- Available in Black
- Main compartment measures: 16"L x 10"W x 18"H;
- Roll bag compartment measures: 16"L x 10"W x 8"H
- Dimensions for both bags (exterior): 16"L x 10"W x 26"H
- Main bag holds 47.20 Liters / Roll Bag holds 20.98 Liters



A



B

Description WPS#

A SVT-250 270-3038

B SVT-750 270-3039



Most RIGGPAKS™ luggage features: • Top quality UV-treated Tri-Max® ballistic nylon. • Utilizes innovative universal “Full Nelson” mounting system. • Lined interior. • Highly reflective webbing. • Can be mounted to sit on either luggage rack or passenger seat. • Holds their shape even when empty. • Fail safe heavy duty zippers with pull fobs. • Durable rubber carrying handle. • 100% waterproof rain cover. • Removable padded vanity cover to conceal mounting system and give passenger comfort. • Rigid bottom plate to prevent sagging • Personalized combination lock • Adjustable shoulder strap with shoulder pad • Lifetime “No Hassle” warranty



Description	WPS#
CTB-1000	270-3028

### RIGGPAKS KING ROLLER

- Attaches using our unique “Full-Nelson” mounting system
- Telescopic handle and integrated trolley system for transport off your bike
- Can be mounted to sit on a luggage rack or passenger seat
- Main compartment is expandable and airline carryon friendly
- Fully lined interior with rigid construction to hold bags shape when empty
- Included roll bag can be mounted separately
- Four large easily accessible side pockets
- Bottom side pockets are 2 chambered
- 2 easy access front pockets for convenience
- Includes 100% waterproof rain cover and security combination lock
- Lifetime “No Hassle” warranty
- Main compartment measures: 15”L x 9”W x 19”H Unexpanded, 15”L x 11”W x 19”H Expanded
- Roll bag measures: 13.5”L x 9” Diameter
- Dimensions for both bags (exterior): 15”L x 9”W x 28”H
- Main Bag holds 42.04 Liters / 51.38 Liters expanded



Description	WPS#
CTB-250	270-3034
Rain Cover	270-3037

### RIGGPAKS EXPANDABLE ROLL BAG

- Compatible with CTB-350, CTB-650, CTB-950, CTB-1050
- Attaches using our unique “Full-Nelson” mounting system
- Can be mounted to sit on a luggage rack or passenger seat
- Stiffening panel holds bags shape even when empty
- Expandable ends for when more room is needed
- Side Pockets easily store maps, keys, money, etc.
- Heavy-duty zippers with pull fobs for use with or without gloves
- Highly reflective webbing helps enhance safety for night riding
- Adjustable carrying strap for easy transportation off your bike
- Includes 100% waterproof rain cover
- Lifetime “No Hassle” warranty
- Main compartment measures: 13”L x 9”Diameter / 18”L x 9”W expanded
- Holds 17.26 Liters / 23.89 Liters expanded



### DAYRUNNER

- Detachable straps convert bag into backpack
- External buckles for attaching Roll Bag
- Top loading for easy entry
- Security loops under bag allow a cable lock to be installed
- Four large easily accessible side pockets
- Dimensions: 12”L x 9”W x 19”H
- Holds liters: 33.63

Description	WPS#
CTB-350	270-3001
Rain Cover	270-3065

- WINDSHIELDS / FAIRINGS
- AUDIO / COMMUNICATION
- SEATS / LUGGAGE**
- BARS / MIRRORS / CONTROLS
- EXHAUST
- AIR / FUEL SYSTEMS
- ENGINE
- TRANSMISSION / DRIVELINE
- GASKETS / SEALS
- ELECTRICAL
- LIGHTING
- CABLES
- BRAKES
- OIL FILTERS
- SUSPENSION
- BODY
- WHEELS
- TIRES / TIRE ACC.
- BIKE ACC.
- VICTORY / INDIAN
- COVERS / LOCKS / TIEDOWNS
- CHEMICALS
- TOOLS
- HELMETS
- HELMET ACC.
- EYEWEAR
- APPAREL / RIDER ACC.
- PROMOTIONAL
- REFERENCE
- INDEX



Most RIGGPAKS™ luggage features: • Top quality UV-treated Tri-Max® ballistic nylon. • Utilizes innovative universal "Full Nelson" mounting system. • Lined interior. • Highly reflective webbing. • Can be mounted to sit on either luggage rack or passenger seat. • Holds their shape even when empty. • Fail safe heavy duty zippers with pull fobs. • Durable rubber carrying handle. • 100% waterproof rain cover. • Removable padded vanity cover to conceal mounting system and give passenger comfort. • Rigid bottom plate to prevent sagging • Personalized combination lock • Adjustable shoulder strap with shoulder pad • Lifetime "No Hassle" warranty

## DELUXE TOURER

- Attaches using the unique "Full-Nelson" mounting system
- Can be mounted to sit on a luggage rack or passenger seat
- Fully lined interior with rigid construction to hold bags shape when empty
- Four large easily accessible side pockets
- Bottom side pockets are 2 chambered
- 2 easy access front pockets for convenience
- Main compartment is expandable
- Can accommodate optional top mount roll bag (270-3025)
- Includes 100% waterproof rain cover and security combination lock
- Lifetime "No Hassle" warranty
- Main compartment: 15"L x 9"W x 19"H Unexpanded, 15"L x 11"W x 19"H Expanded



### Description WPS#

CTB-1050 **270-3026**

## DELUXE ROLL BAG

- Compatible with 270-3002, 270-3001 and 270-2029
- Attaches using our unique "Full-Nelson" mounting system
- Can be mounted to sit on a luggage rack or passenger seat
- Bag holds shape even when empty
- Side mesh pockets easily store smaller items
- Heavy-duty zippers with pull fobs for use with or without gloves
- Highly reflective webbing helps enhance safety for night riding
- Adjustable carrying strap for easy transportation off your bike
- Includes 100% waterproof rain cover
- Lifetime "No Hassle" warranty
- Main compartment measures: 13.5"L x 9"Diameter
- Holds 17.26 Liters







## TOURING DELUXE REAR RACK PAKS

- Made from top quality UV-treated Tri-Max® ballistic nylon
- Rigid construction helps bag hold its shape even when empty
- Six strategically placed metal D-rings allow different locations for mounting straps
- Outer pockets for easy access of smaller items
- 2 large outer pockets on lid
- Integrated mesh pocket under lid
- Mounts to most top box luggage racks including Gold Wing
- Includes 100% waterproof rain cover and security lock
- Lifetime “No Hassle” warranty
- Main compartment measures: 20”L x 11”W x 11”H
- Holds 39.66 Liters

Description	WPS#
-------------	------

GWR-1200	270-3027
----------	----------



## COMPRESSION BAGS

Description	WPS#
-------------	------

Small	270-3062
Medium	270-3061
Large	270-3060

- Made from a water resistant light weight “Tri-Max®” polyester
- Allows for the most compact packing of your soft items
- Can store up to 30% more items after bags are compressed
- Great way to separate clean and dirty clothes while on the road
- Available in Black/Gray
- 1 year “No Hassle” warranty
- 3 sizes:  
 Small \*10L: 18-1/2” x 7”  
 Medium \*20L: 22-3/4” x 8-1/2”  
 Large \*35L: 25-1/2” x 11”  
 \* Size is uncompressed



- WINDSHIELDS / FAIRINGS
- AUDIO / COMMUNICATION
- SEATS / LUGGAGE**
- BARS / MIRRORS / CONTROLS
- EXHAUST
- AIR / FUEL SYSTEMS
- ENGINE
- TRANSMISSION / DRIVELINE
- GASKETS / SEALS
- ELECTRICAL
- LIGHTING
- CABLES
- BRAKES
- OIL FILTERS
- SUSPENSION
- BODY
- WHEELS
- TIRES / TIRE ACC.
- BIKE ACC.
- VICTORY / INDIAN
- COVERS / LOCKS / TIEDOWNS
- CHEMICALS
- TOOLS
- HELMETS
- HELMET ACC.
- EYEWEAR
- APPAREL / RIDER ACC.
- PROMOTIONAL
- REFERENCE
- INDEX

- WINDSHIELDS / FAIRINGS
- AUDIO / COMMUNICATION
- SEATS / LUGGAGE**
- BARS / MIRRORS / CONTROLS
- EXHAUST
- AIR / FUEL SYSTEMS
- ENGINE
- TRANSMISSION / DRIVELINE
- GASKETS / SEALS
- ELECTRICAL
- LIGHTING
- CABLES
- BRAKES
- OIL FILTERS
- SUSPENSION
- BODY
- WHEELS
- TIRES / TIRE ACC.
- BIKE ACC.
- VICTORY / INDIAN
- COVERS / LOCKS / TIEDOWNS
- CHEMICALS
- TOOLS
- HELMETS
- HELMET ACC.
- EYEWEAR
- APPAREL / RIDER ACC.
- PROMOTIONAL
- REFERENCE
- INDEX



## SADDLE BAG COOLER

- Bag Size 17x5x11
- The Ultimate Soft-Sided Cooler now makes a Slant Cooler that fits in your Saddle Bag
- For those long rides in the heat, you will now have cold beverages when you stop. When your not using it as a cooler, use it as a duffel bag for your clothes

- Get the cooler everyone is talking about
- Holds ICE longer than any other soft cooler
- Guaranteed not to leak or sweat

**WPS#**  
**45-27119**



# Cruiseline<sup>™</sup>

## QUICK RELEASE SADDLEBAGS

- Easy-to-use, quarter-turn fasteners for no-tool removal of the saddlebags from the mount frames in just seconds!
- A keyed, push-button lock is recessed into the lid
- Lids are hinged in the front and swing forward for easy access to the interior
- Tight-fitting seals conform to the shape of the lid to keep the elements out
- Mount Kits are custom engineered for each model bike to exact specifications and are guaranteed to fit
- Cruiseliner<sup>™</sup> are painted gloss black and ready to mount or custom paint to match your bike



Bags and Mount Kits sold separately. Mount kits available in Black Powdercoat or Chrome, depending on application. Kits include saddlebag mount frames, hardware and instructions.



Quick release quarter-turn fasteners are located inside the bags for easy, no-tool saddlebag removal in seconds.

### Which Cruiseline Style is Right For You?

Choose the "pocket back" style (562-40100) if you wish to retain the stock turn signals mounted on the rear of the fender struts. These bags feature a cutout for turn signal clearance.

If you decide to use an OEM or aftermarket turn signal relocation kit, or if your turn signals have already been mounted by the taillight, you can use the "smooth back" style (562-40101).

National Cycle's 562-40836 (shown above) for late model Sportsters<sup>®</sup> includes all the hardware required for turn signal relocation. With 562-4083C, you can choose the turn signal placement and Cruiseline saddlebag style that's right for you.

WINDSHIELDS / FAIRINGS

AUDIO / COMMUNICATION

SEATS / LUGGAGE

BARS / MIRRORS / CONTROLS

EXHAUST

AIR / FUEL SYSTEMS

ENGINE

TRANSMISSION / DRIVELINE

GASKETS / SEALS

ELECTRICAL

LIGHTING

CABLES

BRAKES

OIL FILTERS

SUSPENSION

BODY

WHEELS

WHEELS

TIRES / TIRE ACC.

BIKE ACC.

VICTORY / INDIAN

COVERS / LOCKS / TIEDOWNS

CHEMICALS

TOOLS

HELMETS

HELMET ACC.

EYEWEAR

APPAREL / RIDER ACC.

PROMOTIONAL

REFERENCE

INDEX



# Cruiseline™

## QUICK RELEASE SADDLEBAGS

Application	Year	Pocketback	Smoothback	Chrome Finish	Black Finish
<b>SPORTSTER MODELS</b>					
All XL models	'04-16	<b>562-40100</b>	<b>562-40101</b> ‡ †	<b>562-4083C</b> ‡ #	
XL1200R/XL883R	'02-03	<b>562-40100</b> ‡			<b>562-4081B</b> ‡
XL1200C/XL883C	'96-03	<b>562-40100</b> ‡			<b>562-4081B</b> ‡
XL1200S	'96-03	<b>562-40100</b> ‡			<b>562-4081B</b> ‡
XLH1200/XLH883	'94-03	<b>562-40100</b> ‡			<b>562-4081B</b> ‡
<b>DYNA MODELS</b>					
FXDWG	'93-05	<b>562-40100</b> ‡			<b>562-4080B</b>
FXDS	'94-05	<b>562-40100</b> ‡			<b>562-4080B</b>
FXD/FXDL/FXDX/FXDC	'93-05	<b>562-40100</b> ‡			<b>562-4080B</b>
<b>FX SOFTAIL MODELS</b>					
All models	'84-05	<b>562-40100</b> ‡			<b>562-4082B</b> ‡
<b>SOFTAIL MODELS</b>					
FLSTC	'87-16		<b>562-40101</b>		<b>562-4082B</b>
FLSTN	'93-96 and '05-16		<b>562-40101</b>	<b>562-4084C</b>	
FLSTSC	'05-07		<b>562-40101</b>	<b>562-4084C</b>	
FLSTF	'90-06	<b>562-40100</b>		<b>562-4084C</b> @ ‡	
FLST	'86-90		<b>562-40101</b>		<b>562-4082B</b>

# XL883N, XL1200N, XL1200V and XL1200X require HD part number 562-41004 License Plate Relocation Kit.

† 562-40101 smooth-back bags may be used when eliminating the turn signal stalks. All hardware provided mount kit.

§ The Bad Boy is all black, the turn signal relocation bracket is chrome plated--the owner may want to paint this bracket to match the motorcycle.

@ The Fat Boy comes with a "Shotgun" style exhaust. In order to use 562-4084C, a low exit exhaust must be used. Staggered dual exhaust is OK. The turn signal relocation bracket will work, but the assembly method for the turn signal is different than the FX Softails and is not documented in the instructions

‡ 562-40101 Smooth Back Saddlebag can be used as long as the turn signals are dealt with in a suitable manner.

### ACCESSORIES AND REPLACEMENT PARTS



Description	WPS #
Inner Duffel Set	<b>562-41003</b>
Replacement Lock	<b>562-41002</b>
Replacement Reflector, Red	<b>562-41000</b>
Replacement Reflector, Amber	<b>562-41001</b>



## REVOLUTION SERIES



### HARDMOUNT

- Injection molded backs contoured to fit exclusive new universal hard mount system (mounting hardware included)
- Powder coated wire frame and reinforced gussets help retain shape
- High quality chrome buckles feature quick release system for fast access to saddlebags
- Front and rear closure snaps aid lid security at high speeds

	Description	Size	WPS#
A	Standard Small	18½" x 10½" x 6"	<b>63-0370</b>
	Standard Large	20½" x 11½" x 6"	<b>63-0371</b>
B	Belted Small	18½" x 10½" x 6"	<b>63-0372</b>
	Retro Small	18½" x 10½" x 6"	<b>63-0374</b>
C	Retro Large	20½" x 11½" x 6"	<b>63-0375</b>
	Swooped Small	18½" x 10½" x 6"	<b>63-0403</b>
	Swooped Large	20½" x 11½" x 6"	<b>63-0402</b>

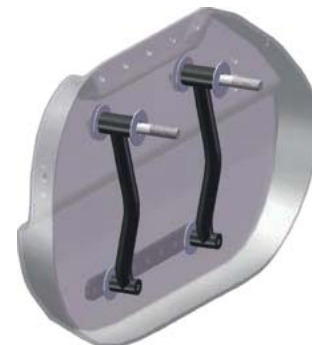

### THROW OVER STYLE

- Reinforced backs provide superior bag stability when compared to "other" throw over styles
- Reinforced yokes for secure universal mounting above or below the seat
- Zip-off yokes and carry handles make removal and transport a breeze

	Description	Size	WPS#
A	Standard Small	18½" x 10½" x 6"	<b>63-0376</b>
	Standard Large	20½" x 11½" x 6"	<b>63-0377</b>
B	Belted Small	18½" x 10½" x 6"	<b>63-0378</b>
	Belted Large	20½" x 11½" x 6"	<b>63-0379</b>
C	Retro Small	18½" x 10½" x 6"	<b>63-0380</b>
	Retro Large	20½" x 11½" x 6"	<b>63-0381</b>
D	Swooped Small	18½" x 10½" x 6"	<b>63-0409</b>



WINDSHIELDS / FAIRINGS

AUDIO / COMMUNICATION

SEATS / LUGGAGE

BARS / MIRRORS / CONTROLS

EXHAUST

AIR / FUEL SYSTEMS

ENGINE

TRANSMISSION / DRIVELINE

GASKETS / SEALS

ELECTRICAL

LIGHTING

CABLES

BRAKES

OIL FILTERS

SUSPENSION

BODY

WHEELS

TIRES / TIRE ACC.

BIKE ACC.

VICTORY / INDIAN

COVERS / LOCKS / TIEDOWNS

CHEMICALS

TOOLS

HELMETS

HELMET ACC.

EYEWEAR

APPAREL / RIDER ACC.

PROMOTIONAL

REFERENCE

INDEX



# REVOLUTION SERIES

## HANDLEBAR BAG

- Universal handlebar bag makes quick storage easy with a high quality chrome quarter turn fastener
- Universal mounting system for maximum usability



Description	Size	WPS#
Handlebar Bag	7½" x 4" x 4"	63-0387

## FORK BAG

- Universal fork bag makes quick storage easy with two high quality chrome quarter turn fasteners
- Universal mounting system for maximum usability



Description	Size	WPS#
Fork Bag	12" x 5½" x 4"	63-0388

## WINDSHIELD BAG

- Mounts to the chrome strap on your windshield for handy storage space when you need it most
- High quality chrome quarter turn fastener keeps content protected



Description	Size	WPS#
Windshield Bag	10½" x 6" x 2½"	63-0389
Fairing Windshield Bag	21 1/4" x 2 1/4" x 6 1/2"	63-03891



## BLACK MAGIC

- These bags have everything; rich, black synthetic leather, highlighted with our deep-grained synthetic leather, 3-strand braid and a large 3" gold and silver eagle
- Plastic reinforced for greater shape retention
- All bags feature quick release buckles (except tool pouch)

Model	Size	WPS#
<b>BLACK MAGIC</b>		
A Super Slant	16" x 11" x 6½"	63-00241
B Compact Slant	12" x 9½" x 5½"	63-00221
C Tool Pouch	12" x 5" x 2½"	63-0027
D Sissy Bar Bag	8" x 10" x 4½"	63-00281
E Max Pax Tail Bag	13" x 9½" x 10"	63-00291





## STANDARD AND TOURING BAGS

- Clean, no-nonsense look that doesn't distract from the graceful lines of your bike
- Constructed of high tech synthetic leather, nickel chrome plated snaps and genuine roller pin buckles
- All bags feature quick release buckles (except tool pouch)



A



B



C



D



E

Model	Size	WPS#
<b>STANDARD AND TOURING BAGS</b>		
A Tool Pouch	12" x 5" x 2½"	<b>63-0126</b>
B Mini Sissy Bag	6" x 8" x 3"	<b>63-01281</b>
C Standard Saddlebag	11" x 12" x 3½"	<b>63-01201</b>
D Max Pax Tail Bag	13" x 9½" x 10"	<b>63-01291</b>
E Touring Saddlebag	14" x 13" x 5½"	<b>63-01301</b>

WINDSHIELDS / FAIRINGS

AUDIO / COMMUNICATION

SEATS / LUGGAGE

BARS / MIRRORS / CONTROLS

EXHAUST

AIR / FUEL SYSTEMS

ENGINE

TRANSMISSION / DRIVELINE

GASKETS / SEALS

ELECTRICAL

LIGHTING

CABLES

BRAKES

OIL FILTERS

SUSPENSION

BODY

WHEELS

TIRES / TIRE ACC.

BIKE ACC.

VICTORY / INDIAN

COVERS / LOCKS / TIEDOWNS

CHEMICALS

TOOLS

HELMETS

HELMET ACC.

EYEWEAR

APPAREL / RIDER ACC.

PROMOTIONAL

REFERENCE

INDEX



## BLACK JACK

- The Black Jack series keeps it clean and simple
- Solid black bags have a textured vinyl front base and black chrome buckles
- Quick release buckles make for easy access
- Plastic reinforcing helps with shape retention



A



B



C



D

	Model	Size	WPS#
A	Slant Saddle Bag Small	12" x 9½" x 5½"	63-0412
B	Slant Saddlebag Large	16" x 11" x 6½"	63-0413
C	Tool Pouch	12" x 5" x 2½"	63-0414
D	Sissy Bar Bag	8" x 10" x 4½"	63-0415





## BRAIDED

- Designed with just enough refinement to offset the rugged good looks of your bike
- Three strand braid outlines this elegant bag
- Genuine roller pin buckles and internal snap flaps add security
- All bags feature quick release buckles (except tool pouch)



A



B



C



D



E



F



G



H

	Model	Size	WPS#
<b>BRAIDED</b>			
A	Tool Pouch	12" x 5" x 2½"	63-0057
B	Sissy Bar Bag	8" x 10" x 4½"	63-00581
C	Max Pax Tail Bag	13" x 9½" x 10"	63-00591
D	Standard Saddlebag	10½" x 11½" x 4"	63-00511
E	Touring	14½" x 12½" x 5½"	63-00551
F	Compact Slant	12" x 9½" x 5½"	63-00521
G	Fleetside Slant	16" x 11" x 6½"	63-00531
H	Standard Slant	14" x 12" x 5½"	63-00541

WINDSHIELDS / FAIRINGS

AUDIO / COMMUNICATION

SEATS / LUGGAGE

BARS / MIRRORS / CONTROLS

EXHAUST

AIR / FUEL SYSTEMS

ENGINE

TRANSMISSION / DRIVELINE

GASKETS / SEALS

ELECTRICAL

LIGHTING

CABLES

BRAKES

OIL FILTERS

SUSPENSION

BODY

WHEELS

TIRES / TIRE ACC.

BIKE ACC.

VICTORY / INDIAN

COVERS / LOCKS / TIEDOWNS

CHEMICALS

TOOLS

HELMETS

HELMET ACC.

EYEWEAR

APPAREL / RIDER ACC.

PROMOTIONAL

REFERENCE

INDEX



## DELUXE BAGS

- Realistic black synthetic leather, clean lines and modest styling to compliment any machine
- Plastic reinforcements and internal snap flaps for added security
- Chrome conchos with lace fringe and genuine roller pin buckles
- All bags feature quick release buckles (except tool pouch)

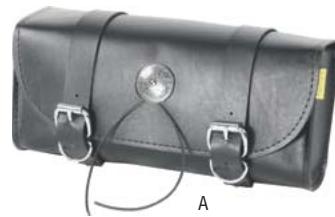

Model	Size	WPS#
<b>DELUXE BAGS</b>		
A Tool Pouch	12" x 5" x 2½"	63-0077
B Sissy Bar Bag	8" x 10" x 4½"	63-00781
C Max Pax Tail Bag	13" x 9½" x 10"	63-00791
D Slant	14" x 12" x 5½"	63-00741
E Compact Slant	12" x 9½" x 5½"	63-00721
F Fleetside Slant	16" x 11" x 6½"	63-00731



## RAPTOR

- New hook & loop securing tabs for quick access and closure
- Clean lines combine with uncluttered styling for a streamlined look for all bikes
- A selection of different slants allows you to find the perfect compliment to your bike
- All bags feature quick release buckles (except tool pouch)



Model	Size	WPS#
<b>RAPTOR</b>		
G Tool Pouch	12" x 5" x 4½"	63-0157
H Sissy Bar Bag	8" x 10" x 4½"	63-01581
I Compact Slant	12" x 9½" x 5½"	63-01521
J Super Slant	16" x 11" x 6½"	63-01541
K Slant	14" x 12" x 5½"	63-01561



## GENUINE LEATHER LUGGAGE

The Willie & Max Leather Luggage Series is a classic design, made in Wisconsin with the same premium cow hides that are used to make OEM bags. 100% Genuine Leather designed and made in the USA



### SADDLEBAGS

- These American hard mount motorcycle saddlebags, must be used in conjunction with a saddlebag bracket system
- Large size gives you plenty of room to carry everything you need wherever the road may take you
- Interior is supported with a plastic liner to help keep the bag from sagging
- Quick release buckles hold the outer flap down while the black buckles give a modern look to the bags
- Includes two bags
- Ventura- Exterior Dimensions 11" x 13" x 8"
- Montana- Exterior Dimensions 11" x 13" x 7"
- Mighty Legend- Exterior Dimensions 11" x 13" x 7"

### WINDSHIELD BAGS

- The size makes it ideal for small items like tools, gloves, sunglasses or other small items you may take on the road with you
- These are available in high or low mount versions, and are available to fit Harley-Davidson or Metric windshields
- Chrome, turnbuckle style closure
- Exterior Dimensions 5" x 10.5" x 3.5"

### FORK BAGS

- This is an authentic retro American leather fork bag made with 100% leather
- The size makes it ideal for small items like tools, gloves, sunglasses or other small items you may take on the road with you
- The bag can be mounted to a variety of locations on your bike, including the swing arm, rear fender support and other places that have structure to support the bag
- Mounted with leather straps to the front fork of your motorcycle or other locations
- Uses traditional belt buckles to close the bag
- Exterior Dimensions 5.5" x 10" x 4"

SADDLEBAGS		WPS#
A	Montana	63-0717
B	Montana Studded	63-0718
C	Ventura	63-0719
D	Mighty Legend	63-0720
E	Mighty Legend	63-0721
WINDSHIELD BAGS		WPS#
	Metric	63-0727
	Metric	63-0723
F	Low Mount Harley	63-0722
	High Mount Harley	63-0726
	Metric	63-0725
	Metric	63-0729
	Studded High Mount Harley	63-0728
G	Studded High Mount Harley	63-0724
FORK BAGS		WPS#
H	No-Studs	63-0730
I	Studs	63-0731

- WINDSHIELDS / FAIRINGS
- AUDIO / COMMUNICATION
- SEATS / LUGGAGE**
- BARS / MIRRORS / CONTROLS
- EXHAUST
- AIR / FUEL SYSTEMS
- ENGINE
- TRANSMISSION / DRIVELINE
- GASKETS / SEALS
- ELECTRICAL
- LIGHTING
- CABLES
- BRAKES
- OIL FILTERS
- SUSPENSION
- BODY
- WHEELS
- TIRES / TIRE ACC.
- BIKE ACC.
- VICTORY / INDIAN
- COVERS / LOCKS / TIEDOWNS
- CHEMICALS
- TOOLS
- HELMETS
- HELMET ACC.
- EYEWEAR
- APPAREL / RIDER ACC.
- PROMOTIONAL
- REFERENCE
- INDEX



## AMERICAN CLASSIC

- The American Classic brings nostalgic memories with it's chrome studs, genuine roller pin buckles, subdued round conchos with fringe and a box style top
- Reinforced with internal plastic
- All bags feature quick release buckles (except tool pouch)

	Model	Size	WPS#
<b>AMERICAN CLASSIC</b>			
A	Tool Pouch	12" x 5" x 2½"	<b>63-0037</b>
B	Sissy Bar Bag	8" x 10" x 4½"	<b>63-00381</b>
C	Standard Saddlebag	14½" x 11½" x 5½"	<b>63-00351</b>

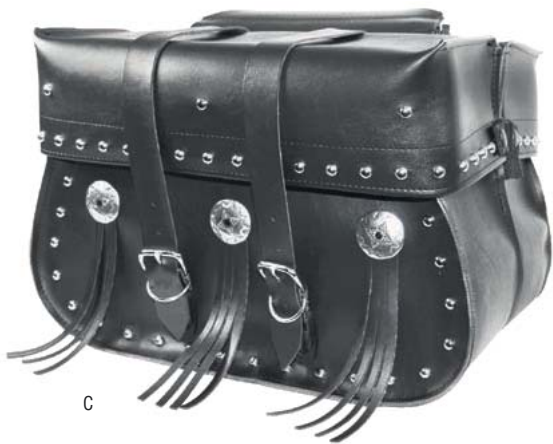

C

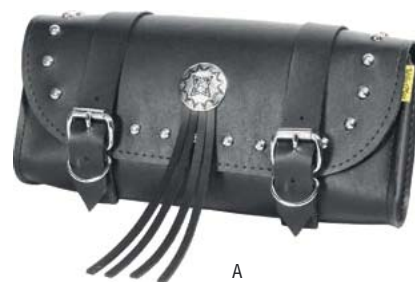

A



B



A

## WARRIOR

- Styled after the look of the 50's and 60's
- Nickel chrome conchos, studs and fringe accent the black synthetic leather
- Internal snap flaps and plastic reinforcing add security and shape retention
- All bags feature quick release buckles (except tool pouch)

	Model	Size	WPS#
<b>WARRIOR</b>			
A	Standard Saddlebag	14" x 10" x 4½"	<b>63-01111</b>
B	Sissy Bar Bag	8" x 10" x 4½"	<b>63-01181</b>
C	Tool Pouch	12" x 5" x 2½"	<b>63-0117</b>
D	Max Pax Tail Bag	13" x 9½" x 10"	<b>63-01191</b>



B

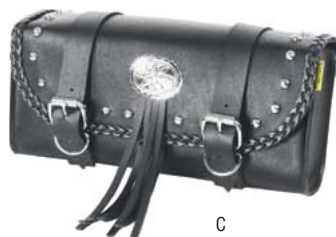

C



D



## BRAIDED GREY THUNDER

- A unique break from the traditional black motorcycle luggage
- Distinctive iron grey trim highlights the rich black synthetic leather allowing the bags to blend well with any bike
- All bags feature quick release buckles (except tool pouch)



A



B



C

	Model	Size	WPS#
<b>BRAIDED GREY THUNDER</b>			
A	Compact Slant	12" x 9½" x 5½"	<b>63-00021</b>
B	Tool Pouch	12" x 5" x 2½"	<b>63-0007</b>
C	Sissy Bar Bag	8" x 10" x 4½"	<b>63-00081</b>

## STUDED GREY THUNDER

- Distinctive iron grey trim highlights the rich black synthetic leather
- Bright nickel chrome plated brass studs, a 3" silver eagle and 3 strand braid accent these bags
- All bags feature quick release buckles

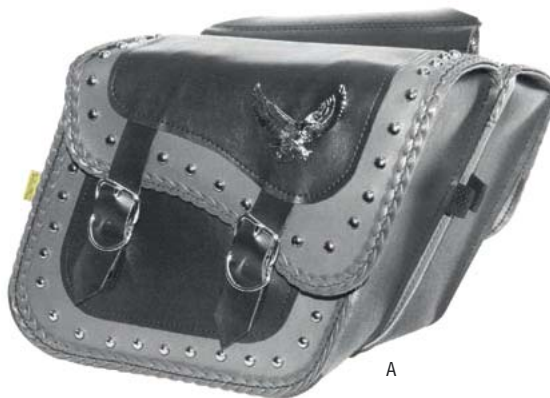

A



B

	Model	Size	WPS#
<b>STUDED GREY THUNDER</b>			
A	Compact Slant	12" x 9½" x 5½"	<b>63-00121</b>
B	Sissy Bar Bag	8" x 10" x 4½"	<b>63-00181</b>

WINDSHIELDS /  
FAIRINGSAUDIO /  
COMMUNICATIONSEATS /  
LUGGAGEBARS / MIRRORS /  
CONTROLS

EXHAUST

AIR /  
FUEL SYSTEMS

ENGINE

TRANSMISSION /  
DRIVELINEGASKETS /  
SEALS

ELECTRICAL

LIGHTING

CABLES

BRAKES

OIL FILTERS

SUSPENSION

BODY

WHEELS

TIRES /  
TIRE ACC.

BIKE ACC.

VICTORY /  
INDIANCOVERS / LOCKS /  
TIEDOWNS

CHEMICALS

TOOLS

HELMETS

HELMET ACC.

EYEWEAR

APPAREL /  
RIDER ACC.

PROMOTIONAL

REFERENCE

INDEX



## RANGER

- Enough capacity to carry your belongings for a few miles or a couple of days
- Convenient easy access pocket for those items you need in a hurry
- All bags feature quick release buckles (except tool pouch)



A



B



C



D



E



F

	Model	Size	WPS#
<b>RANGER</b>			
A	Super Slant	16" x 11" x 6½"	<b>63-0353</b>
B	Super Slant Studded	16" x 11" x 6½"	<b>63-0351</b>
C	Super Slant Braided	16" x 11" x 6½"	<b>63-0352</b>
D	Tool Pouch	12" x 5" x 2½"	<b>63-0356</b>
E	Sissy Bar Bag	8" x 10" x 4½"	<b>63-0358</b>
F	Max Pax	13" x 9½" x 10"	<b>63-0359</b>



# ACCESSORIES

## A. SADDLEBAG HARD MOUNT KIT

- Works with all Willie & Max saddlebags equipped with plastic tube reinforcing
- Can be used with most throw over style bags with reinforced backing
- May require additional hardware depending on application



## B. THE "HOOKER"

- Slips easily under the passenger seat and gives you 4 padded "D" ring mounting points



## C. HANDLEBAR/WINDSHIELD POUCH

- This convenient pouch mounts to the handlebar with ties or adhesive hook & loop



## D. TRUNK LINER



## E. SMALL SADDLEBAG LINER



## F. SADDLEBAG COOLER INSERT



Description	Size	WPS#
A Saddlebag hard mount kit		<b>63-0256</b>
B The Hooker	12" x 7 1/2"	<b>63-0253</b>
C Handlebar/Windshield pouch	7 1/2" x 4" x 2 1/2"	<b>63-0251</b>
D Trunk liner	8" x 11 1/2" x 7 1/2"	<b>63-0390</b>
E Small saddlebag liner	4" x 9 1/2" x 8"	<b>63-0391</b>
F Saddlebag Cooler insert	15" x 4 3/4" x 9 1/4"	<b>63-0393</b>



## UNIVERSAL SADDLE BAG LOCK KIT

- Beautiful design & function
- These new lock kits are easy to install
- Fit most soft-sided saddlebags
- Keep the contents of your existing soft saddlebags safe
- Does not fit FLHRC / FLHRS models

Description	OEM#	WPS#
Saddlebag lock kit	90300017	<b>820-52388</b>



- WINDSHIELDS / FAIRINGS
- AUDIO / COMMUNICATION
- SEATS / LUGGAGE**
- BARS / MIRRORS / CONTROLS
- EXHAUST
- AIR / FUEL SYSTEMS
- ENGINE
- TRANSMISSION / DRIVELINE
- GASKETS / SEALS
- ELECTRICAL
- LIGHTING
- CABLES
- BRAKES
- OIL FILTERS
- SUSPENSION
- BODY
- WHEELS
- TIRES / TIRE ACC.
- BIKE ACC.
- VICTORY / INDIAN
- COVERS / LOCKS / TIEDOWNS
- CHEMICALS
- TOOLS
- HELMETS
- HELMET ACC.
- EYEWEAR
- APPAREL / RIDER ACC.
- PROMOTIONAL
- REFERENCE
- INDEX



## SADDLEBAG SUPPORT BRACKETS

- Chrome plated steel brackets
- Ideal for throw over saddle bags
- Hardware included
- Sold in pairs

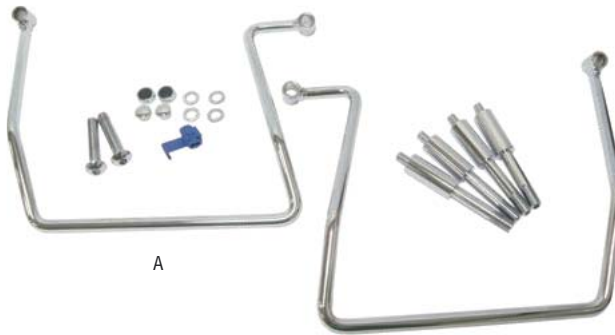

A



B



C



D



E

Application	WPS#
A '91-Up FXD, '93-'08 FXDWG (except '13 FXDB)	<b>820-70500</b>
B '00-Up FXST Single Bolt (except FXSTD/C)	<b>820-70501</b>
C '84-'99 FXST Two Bolt	<b>820-70502</b>
D '06-'10 FXST, '07-'13 FLSTF	<b>820-70503</b>
E '94-'03 XL (except 1200S)	<b>820-70504</b>
'04-Up XL (except 883N, 1200N, 1200X)	<b>820-70505</b>



## SOFT BAG SUPPORT BRACKETS

- Easy no tool installation
- Eliminates the typical sag of Heritage Softtail leather bags

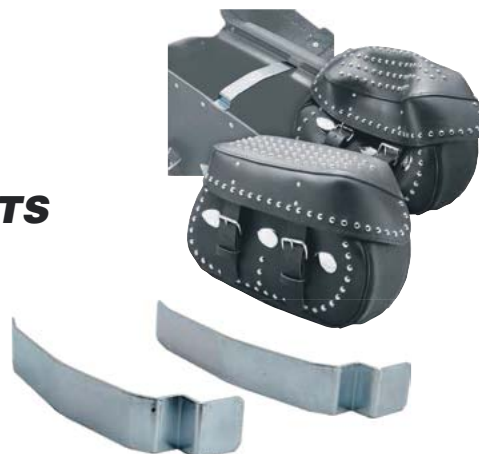

Description	Application	WPS#
Saddlebag Anti-Sag Bracket	FLSTC Soft Bags	<b>812-02000</b>





## LEATHER SWING ARM BAGS

- Fitments include: Sportster and Softails
- Made in USA
- 100% Genuine Leather
- Quick Release Buckle
- Added magnetic reinforcement buckle
- Easy to install with slotted access ports and Speedwrap Hook and Loop cable ties included
- Dimensions: 10.5" x 11.5" x 4.5"

Description		w/ Chrome Buckle	w/ Matte Black Buckle
10.5" x 11.5" x 4.5" Black swing arm bag for Softail models	A	<b>63-0711</b>	B <b>63-0712</b>
10.5" x 11.5" x 4.5" Brown swing arm bag for Softail models		<b>63-0715</b>	
10.5" x 11.5" x 4.5" Black swing arm bag for Sportster models	C	<b>63-0713</b>	D <b>63-0714</b>
10.5" x 11.5" x 4.5" Brown swing arm bag for Sportster models		<b>63-0716</b>	

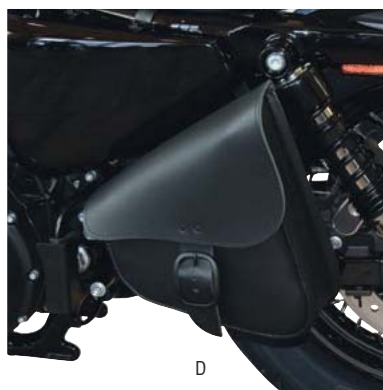

Description	WPS#
<b>UNIVERSAL - IDEAL FOR DUAL SHOCK APPLICATIONS</b>	
A Black Syn. Leather	<b>63-0702</b>
B Vintage Brown	<b>63-0703</b>
<b>UNIVERSAL - IDEAL FOR HIDDEN SHOCK APPLICATIONS</b>	
C Black Syn. Leather	<b>63-0700</b> *
D Vintage Brown	<b>63-0701</b> *

### SWING ARM BAGS

- Rigid plastic backing
- Ideal for bike with a hidden shock
- Includes protective film for swingarm or frame
- Dimensions 10.5" x 11.5" x 4.5"
- \* Must have triangulated swingarm



A



B



C



D



Description	WPS#
<b>SPORTSTERS '92-UP</b> Black Belt Guard Bag	<b>63-0704</b>

### BELT GUARD BAG

- Rigid plastic backing
- Powder coated steel hardware incl.
- Quick release chrome clasps
- 2-tone speed hole match Nightster Forty-Eight belt guard
- Dimensions 11" x 5" x 2.5"

- WINDSHIELDS / FAIRINGS
- AUDIO / COMMUNICATION
- SEATS / LUGGAGE**
- BARS / MIRRORS / CONTROLS
- EXHAUST
- AIR / FUEL SYSTEMS
- ENGINE
- TRANSMISSION / DRIVELINE
- GASKETS / SEALS
- ELECTRICAL
- LIGHTING
- CABLES
- BRAKES
- OIL FILTERS
- SUSPENSION
- BODY
- WHEELS
- TIRES / TIRE ACC.
- BIKE ACC.
- VICTORY / INDIAN
- COVERS / LOCKS / TIEDOWNS
- CHEMICALS
- TOOLS
- HELMETS
- HELMET ACC.
- EYEWEAR
- APPAREL / RIDER ACC.
- PROMOTIONAL
- REFERENCE
- INDEX

# Nash

MOTORCYCLE COMPANY

WINDSHIELDS / FAIRINGS

AUDIO / COMMUNICATION

SEATS / LUGGAGE

BARS / MIRRORS / CONTROLS

EXHAUST

AIR / FUEL SYSTEMS

ENGINE

TRANSMISSION / DRIVELINE

GASKETS / SEALS

ELECTRICAL

LIGHTING

CABLES

BRAKES

OIL FILTERS

SUSPENSION

BODY

WHEELS

TIRES / TIRE ACC.

BIKE ACC.

VICTORY / INDIAN

COVERS / LOCKS / TIEDOWNS

CHEMICALS

TOOLS

HELMETS

HELMET ACC.

EYEWEAR

APPAREL / RIDER ACC.

PROMOTIONAL

REFERENCE

INDEX

## SKATE SACK SIDE BAG

Never be caught without your second set of wheels. Our new Skate Sack makes transporting your other ride even easier. These bags are made inside-out to optimize structure and space, and the adjustable mounting straps allows it to fit on a number of bikes (see photos). As always, the Skate Sack is made in the U.S.A with all-American leather and hardware.



Description	WPS #
Skate Sack LEFT	<b>811-30200</b>
Skate Sack RIGHT	<b>811-30203</b>



## SPORTY SACK SIDE BAG

The sporty sack is the perfect bag for every Sportster. It's nice to have somewhere to store some tools, your paperwork, and a small jacket, whatever it may be. The design of this bag is big enough for storage but small enough to maintain the look of the bike. The sporty sack can be mounted in 2 ways, you can use the adjustable leather straps to attach around the fender strut or the stationary straps with grommets attached to the fender strut bolts. The bag will fit 1957-Up Sportster applications. We have left, and right side available to order.



PLEASE NOTE: Bag may not fit all leather jackets.

Description	WPS #
Sporty Sack, Left	<b>811-30201</b>
Sporty Sack, Right	<b>811-30202</b>



# SIDE BAGS



- Solo side bags for various applications in different styles
- Made of durable vinyl
- Army style bag dimensions: 12" x 16" x 6" universal application
- FL-1 bag dimensions: 11" x 13.5" x 6" universal application
- 750-01800, 750-01801 and 750-01802 fit '04-up Sportster models

	Description	WPS #
A	Diamond Stitch Side Bag	750-01800
B	Adjustable Diamond Stitch Side Bag	750-01801
C	Side Bag with Pockets	750-01802
D	FL-1 Side Bag	750-01803
E	Army Style Side Bag (Leather)	750-01804



- WINDSHIELDS / FAIRINGS
- AUDIO / COMMUNICATION
- SEATS / LUGGAGE**
- BARS / MIRRORS / CONTROLS
- EXHAUST
- AIR / FUEL SYSTEMS
- ENGINE
- TRANSMISSION / DRIVELINE
- GASKETS / SEALS
- ELECTRICAL
- LIGHTING
- CABLES
- BRAKES
- OIL FILTERS
- SUSPENSION
- BODY
- WHEELS
- TIRES / TIRE ACC.
- BIKE ACC.
- VICTORY / INDIAN
- COVERS / LOCKS / TIEDOWNS
- CHEMICALS
- TOOLS
- HELMETS
- HELMET ACC.
- EYEWEAR
- APPAREL / RIDER ACC.
- PROMOTIONAL
- REFERENCE
- INDEX



## DETACHABLE SISSY BARS

- Chrome square sissy bar
- Chrome detachable side plates (sold in pairs)
- Easy on Easy off set up



820-2212



820-2211



820-2207



820-2210



820-2217



820-2221

Application	Detachable Side Plates	Docking Hardware	Turn Signal Relocation Kit	Tall Sissy Bar Height	Short Sissy Bar Height
<b>SPORTSTER</b>					
'04-Up XL models	820-2212	820-2230		820-2215 19.6"	820-2220 15"
'94-03 XL models	820-2211	820-2229		820-2216 16"	820-2221 11"
<b>DYNA</b>					
'06-Up Dyna models (except listed below)	820-2210	820-2226	820-2238	820-2215 19.6"	820-2220 15"
'06-08 FXDWG	820-2210	820-2227		820-2215 19.6"	820-2220 15"
'09-Up FXDB	820-2210	820-2233	820-2238	820-2215 19.6"	820-2220 15"
'10-Up FXDWG	820-2210	820-2239	820-2238	820-2215 19.6"	820-2220 15"
'08-Up FXDF	820-2210	820-2227		820-2218 19.6"	820-2219 15"
'02-05 FXD models (except FXDWG)	820-2214	820-2234		820-2217 16"	820-2222 11"
'91-01 FXD models (except FXDWG)	820-2214	820-2228		820-2216 16"	820-2221 11"
'93-05 FXDWG	820-2213	820-2228		820-2215 19.6"	820-2220 15"
<b>SOFTAIL</b>					
'03-Up FLSTC	820-2209	820-2224		820-2215 19.6"	820-2220 15"
'06-Up FX/FL Softail models w/ 200mm rear tire	820-2207	820-2223	820-2237	820-2218 19.6"	820-2219 15"
'05-Up FLST/N models	820-2207	820-2223		820-2215 19.6"	820-2220 15"
'05-07 FLSTSC	820-2207	820-2224	820-2237	820-2215 19.6"	820-2220 15"
'03-06 FX/FL Softail models (except listed)	820-2207	820-2223	820-2237	820-2215 19.6"	820-2220 15"
'02 FLSTF/FX Softail models	820-2207	820-2225	820-2236	820-2215 19.6"	820-2220 15"
'00-02 FLSTC	820-2209	820-2231		820-2215 19.6"	820-2220 15"
'00-01 FLSTF/FX Softail models	820-2207	820-2225	820-2235	820-2215 19.6"	820-2220 15"
'84-99 Softail models (except FLSTS)	820-2208	820-2232		820-2215 19.6"	820-2220 15"
'84-99	820-2208	820-2232		820-2215 19.6"	820-2220 15"



## RIGID SISSY BARS

820-2215 Shown with 820-2204 Side Plates



- Chrome square bar
- Chrome side plates
- NOTE: on some models the side plates mount inside the struts
- Hardware sold Separately

820-2220 Shown with 820-2200 Side Plates



Application	Side Plates	Tall Sissy Bar	Height	Short Sissy Bar	Height
<b>SPORTSTER</b>					
'94-03 XL models	820-2205	820-2216	16"	820-2221	11"
'04-Up XL models	820-2206	820-2217	16"	820-2222	11"
'04-Up XL Models (rigid side plates only)				820-2243	6"
<b>DYNA</b>					
'96-01 FXD models	820-2202	820-2216	16"	820-2221	11"
'02-05 FXD models	820-2202	820-2217	16"	820-2222	11"
'02-05 FXD models				820-2244	8 3/4"
'06-Up FXD models (except listed below)	820-2203	820-2215	19.6"		15"
'06-08 FXDWG, '08-Up FXDF	820-2204	820-2215	19.6"	820-2220	15"
<b>SOFTAIL</b>					
'00-06 FLSTF	820-2201	820-2215	19.6"	820-2220	15"
'06-Up FLSTF, '05-Up FLSTN	820-2201	820-2218	19.6"	820-2219	15"
<b>TOURING</b>					
'97-08 FLH/FLT	820-2240	820-2215	19.6"	820-2220	15"
'09-13 FLH/FLT	820-2200	820-2215	19.6"	820-2220	15"
<b>SISSY BAR HARDWARE</b>					
1/4"-28 x 5/8" Stainless Button Head	820-2241				



## SISSY BAR PADS

- Hand crafted pads with 1-3/4" thickness for optimal comfort
- Made with high grade vinyl
- Chrome bracket and hardware allows installation on most 6" wide backrests
- Classic design
- Mini backrest pad for mini sissy bars

Description	WPS #
Backrest Pad Smooth Tall 9"	820-2250
Backrest Pad Smooth Short 6"	820-2251
Backrest Pad Button Short 6"	820-2252
Backrest Pad Smooth Mini 3"	820-2242



Back View

- WINDSHIELDS / FAIRINGS
- AUDIO / COMMUNICATION
- SEATS / LUGGAGE**
- BARS / MIRRORS / CONTROLS
- EXHAUST
- AIR / FUEL SYSTEMS
- ENGINE
- TRANSMISSION / DRIVELINE
- GASKETS / SEALS
- ELECTRICAL
- LIGHTING
- CABLES
- BRAKES
- OIL FILTERS
- SUSPENSION
- BODY
- WHEELS
- TIRES / TIRE ACC.
- BIKE ACC.
- VICTORY / INDIAN
- COVERS / LOCKS / TIEDOWNS
- CHEMICALS
- TOOLS
- HELMETS
- HELMET ACC.
- EYEWEAR
- APPAREL / RIDER ACC.
- PROMOTIONAL
- REFERENCE
- INDEX



## DIY SISSY BARS

Kit includes a precision CNC bent sissy bar hoop, axle plate mounting tabs, 3/8-16 threaded radius bungs, mounting bolts, and leather washers to protect your paint. Simply trim the hoop to your desired height and weld the included tabs and bungs to the hoop. The hoop is constructed from premium 1/2" diameter 1018 cold rolled American steel for high strength and easy welding. The threaded radius bungs allow for mounting bolts to be hidden on the underside of your fender for a professional looking installation. Universal design is perfect for both flat or round profile rear fenders and proudly made in the USA!

Application	Description	WPS#
Universal	DIY Sissy Bar Kit, Straight	<b>563-01115</b>
	DIY Sissy Bar Kit, Kickback	<b>563-01116</b>
	DIY Sissy Bar Kit, Straight Long	<b>563-01117</b>
	DIY Sissy Bar Kit, Kickback, Long	<b>563-01118</b>

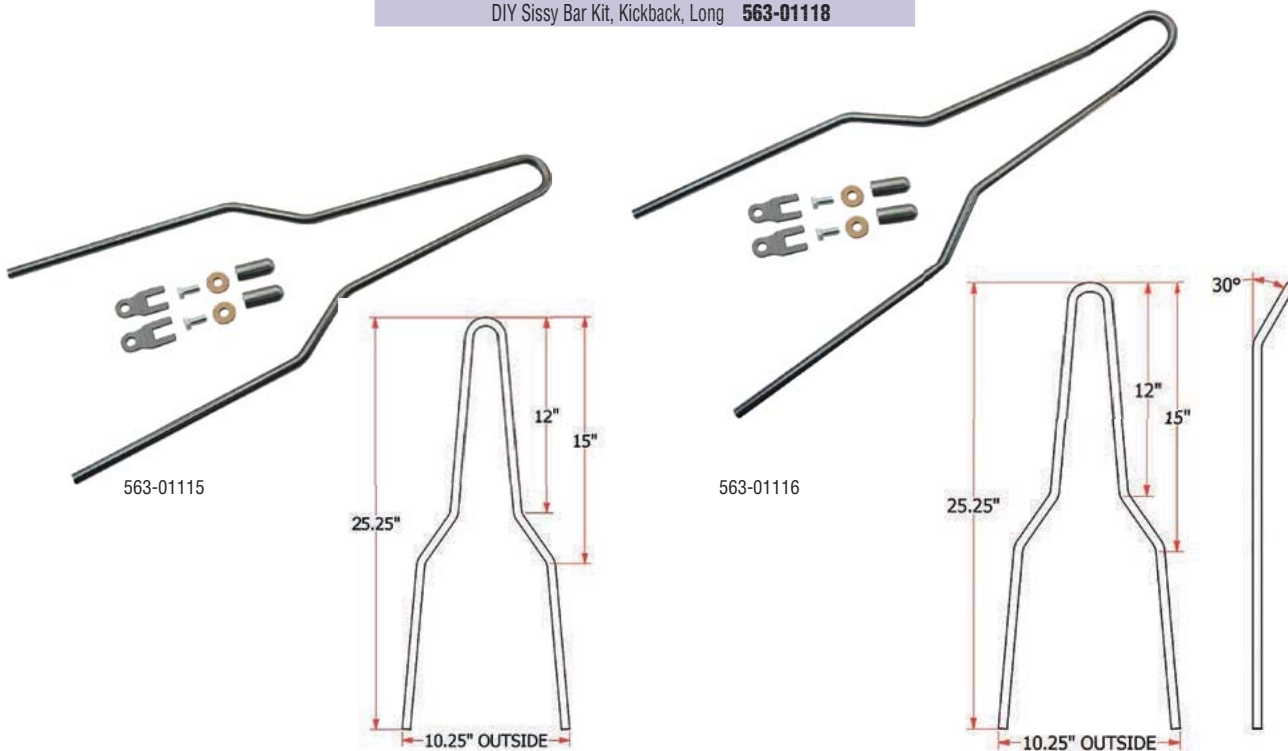

## 4-POINT DOCKING KIT

- Nice chrome finish
- Works with H-D detachable backrest and luggage rack



Description	OEM#	WPS#
Chrome 4-Point docking hardware for '14-Up Touring models	52300353	<b>820-2198</b>



## SISSY BAR DUFFLE BAG

Multipurpose duffle bag that can be mounted to most sissybars and carried with the shoulder strap when you get to your destination. Made of durable weather resistant nylon in either military green or black. Has various pockets and zippers for easy access and loops to attach whatever else you need to take with you. The coolest way to pack your gear on your chopper!

Description	WPS #
Sissybar Dufflebag Black	750-01815
Sissybar Dufflebag Green	750-01816



Back

Front



## TOOL POUCHES

- Tool pouches come in plain, tuck and roll or diamond stitch design
- Available in two sizes, ideal for the range extender bottles (XL 11.5" long, L 10" long)
- Mount to the front fork, handlebars, downtubes or fender struts
- Made of durable, weather resistant vinyl

Description	WPS #
A Traditional Pouch Extra Large	750-01806
C Diamond Stitch Pouch Extra Large	750-01808
D Tuck & Roll Pouch Extra Large	750-01810
E Tuck & Roll Pouch Large	750-01811



Fuel bottle shown in Traditional extra large pouch

## FUEL BOTTLES

- Range extender bottles can be mounted to the bike with West Eagle tool pouches (ideally vertically)
- Can be filled with whatever makes you go farther
- Available in three sizes, made of stainless steel

Description	WPS #
Range Extender Bottle S 500cc	750-01850
Range Extender Bottle L 700cc	750-01851
Range Extender Bottle XL 900cc	750-01852

- WINDSHIELDS / FAIRINGS
- AUDIO / COMMUNICATION
- SEATS / LUGGAGE**
- BARS / MIRRORS / CONTROLS
- EXHAUST
- AIR / FUEL SYSTEMS
- ENGINE
- TRANSMISSION / DRIVELINE
- GASKETS / SEALS
- ELECTRICAL
- LIGHTING
- CABLES
- BRAKES
- OIL FILTERS
- SUSPENSION
- BODY
- WHEELS
- TIRES / TIRE ACC.
- BIKE ACC.
- VICTORY / INDIAN
- COVERS / LOCKS / TIEDOWNS
- CHEMICALS
- TOOLS
- HELMETS
- HELMET ACC.
- EYEWEAR
- APPAREL / RIDER ACC.
- PROMOTIONAL
- REFERENCE
- INDEX



SEATS / LUGGAGE

## PASSENGER GRAB RAIL

Grab rail for passenger or luggage tie down for late Touring models.

Application	Description	WPS#
Fits '14-Up Touring and Tri Glide	Passenger Grab Rail Chrome	<b>820-51005</b>
	Passenger Grab Rail Black	<b>820-51006</b>



## HANDRAIL COVERS

These covers fit over the OEM passenger handrails and offer a larger surface for added grip and comfort.

Description	Application	WPS#
Chrome Handrail Covers	Touring Models '99-13	<b>820-55250</b>





## SOLO LUGGAGE RACKS

- Chrome rack is contour fit to the fender and mounts with existing holes
- Keep your gear off your fender and protect the paint
- Great accessory for solo riders

	Application	WPS#
A	'06-Up FXDB and '10-Up FXDWG	820-2625
B	'06-Up Softail w/ 200mm Tire	820-2626
G	'00-04 Softail models	820-2617
C	'04-Up XL models with stock fender	820-2620
D	'04-Up XL models with custom fender	820-2621
E	'05-Up FLSTF	820-2622
F	'97-05 Touring models	820-2611
G	'97-99 Softail models	820-2616
H	'93-05 FXDWG	820-2614
I	'91-05 Dyna models (except FXDWG)	820-2613
J	'85-03 XL models	820-2612
K	'84-96 Softail models	820-2615

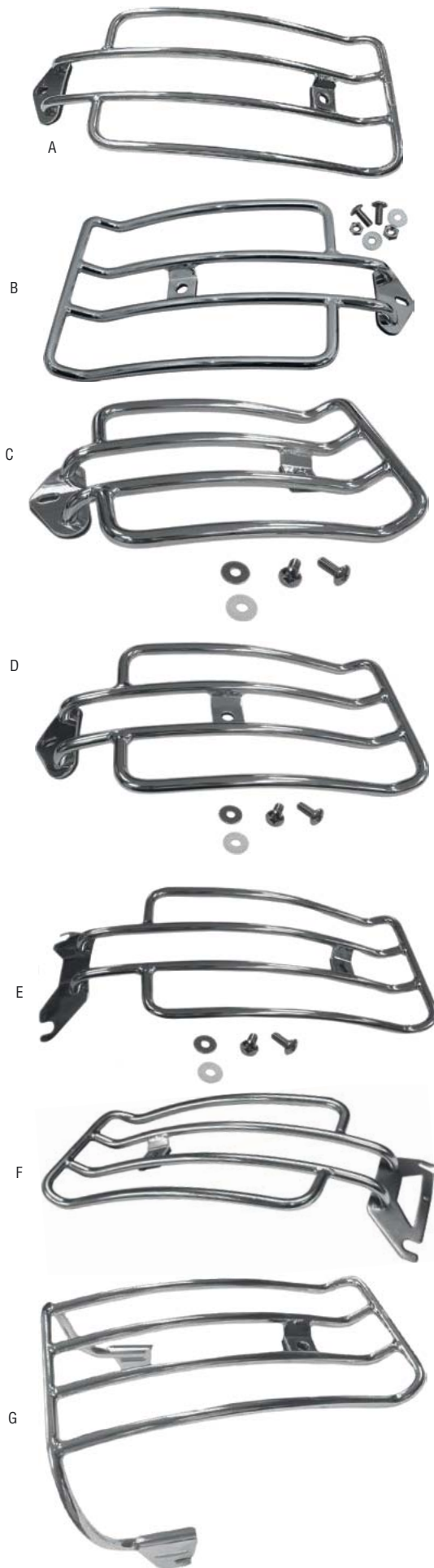

WINDSHIELDS / FAIRINGS

AUDIO / COMMUNICATION

SEATS / LUGGAGE

BAR / MIRRORS / CONTROLS

EXHAUST

AIR / FUEL SYSTEMS

ENGINE

TRANSMISSION / DRIVELINE

GASKETS / SEALS

ELECTRICAL

LIGHTING

CABLES

BRAKES

OIL FILTERS

SUSPENSION

BODY

WHEELS

TIRES / TIRE ACC.

BIKE ACC.

VICTORY / INDIAN

COVERS / LOCKS / TIEDOWNS

CHEMICALS

TOOLS

HELMETS

HELMET ACC.

EYEWEAR

APPAREL / RIDER ACC.

PROMOTIONAL

REFERENCE

INDEX

**HardDrive**  
AMERICAN V-TWIN PRODUCTS

## BOBTAIL FENDER LUGGAGE RACKS

- Custom looking rack for the custom bobtail fender look
- Help protect the paint when carrying extra gear on long or short trips
- Hardware included



Application	WPS#
A '00-Up FXST w/ Bobtail Fender	<b>820-2610</b>
B '06-Up FXST w/ Bobtail Fender	<b>820-2618</b>
C '00-05 FXST models (except FXSTD) 5" L X 11" W	<b>820-2608</b>
D '06-Up FXDWG	<b>820-2619</b>
E '02-05 FXDWG	<b>820-2609</b>
F '93-01 FXDWG 9 1/4" L X 6" W	<b>820-2605</b>
G '80-86 FXDWG, '84-99 FXST w/ Bobtail Fender	<b>820-2603</b>

**LUGGAGE RACKS**

**Hard Drive**  
 AMERICAN V-TWIN PRODUCTS

- Chrome stylish luggage racks
- Keeps rear fender protected from scratches
- Easy to tie down gear for trips



A



B

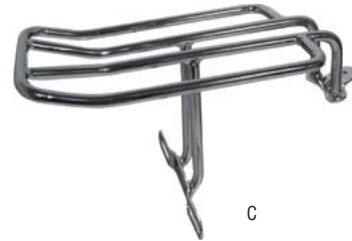

C



D

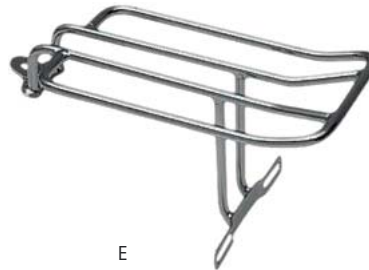

E



F

	Application	WPS#
A	'06-10 FLSTC	<b>820-2623</b>
B	'86-05 FLST models (except FLSTS)	<b>820-2601</b>
C	'06-10 Dyna models (except FXDWG)	<b>820-2624</b>
D	'91-05 FXD models (except FXDWG) 10" L X 6" W	<b>820-2607</b>
E	'82-94 FXR, '76-85 FX models (except FXDB)	<b>820-2604</b>
F	'94-09 XL models 8 1/2" L X 6" W	<b>820-2606</b>
G	'79-93 XL models 8" L X 6" W	<b>820-2602</b>

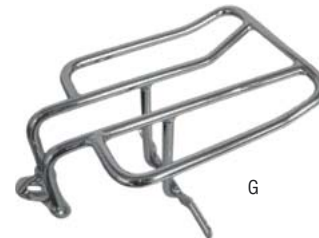

G

**TOUR PACK RACK**

- Easy to attach additional gear for that long ride
- Great chrome accessory to customize your bike
- Keeps gear off of your painted surface

Application	WPS#
'84-13 models w/ chopped or king tour pack	<b>820-2627</b>

WINDSHIELDS /  
FAIRINGSAUDIO /  
COMMUNICATIONSEATS /  
LUGGAGEBARS / MIRRORS /  
CONTROLS

EXHAUST

AIR /  
FUEL SYSTEMS

ENGINE

TRANSMISSION /  
DRIVELINEGASKETS /  
SEALS

ELECTRICAL

LIGHTING

CABLES

BRAKES

OIL FILTERS

SUSPENSION

BODY

WHEELS

TIRES /  
TIRE ACC.

BIKE ACC.

VICTORY /  
INDIANCOVERS / LOCKS /  
TIEDOWNS

CHEMICALS

TOOLS

HELMETS

HELMET ACC.

EYEWEAR

APPAREL /  
RIDER ACC.

PROMOTIONAL

REFERENCE

INDEX



## DELUXE TOUR PACK RACK

- This Deluxe Trunk Luggage Rack is custom designed to match the lines of the Harley trunk
- Includes all hardware for mounting
- This Luggage Tour Rack is available in either chrome or the exclusive black Smoke chrome finish
- The rack accommodates large luggage tour bags
- Fits Harley Tour Packs 1980-2014

Description	Chrome Smoke	Chrome
Large luggage rack 20-1/4 x 14	94-91306SK	94-91306



Chrome Smoke



Chrome

## VANTAGE TOUR PACK RACK

- This elegant but simple all new Six Rail Vantage Rack has no weld joints, making it truly unique and clean
- CNC machined of extruded billet aluminum
- The custom extruded aluminum tubes hold the rails in place with blind screws from below enhancing its clean design
- The mounting feet are also bottom mounted with threaded studs that eliminate the need to weld
- Includes a special angled stainless steel leg washers to properly secure the feet to the trunk lid and minimize the pressure that causes trunk lid cracking
- The Vantage Rack is designed to clear the OEM spoiler

Description	Chrome	Smoke Chrome
6 rail tour pack rack for H-D tour packs	94-91307	94-91307SK



Chrome



Chrome Smoke



## BAGGER APEHANGER BARS



- HardDrive 1 1/4" Bagger Ape Hanger Bars have a comfy feel and a custom look
- Made of heavy duty, high grade steel tubing with expertly welded step-joints, a high quality finish and are knurled for 3 1/2" riser spacing
- Available in Chrome or Satin Black
- Fits Touring models 1980-Up with batwing fairings and models with TBW

Description/Application	Color	Tube Size	Height	Width	Pull Back	WPS#
<b>1-1/4" BAGGER APE HANGER (DRILLED FOR INTERNAL WIRING)</b>						
'80-07 FLH Touring models	Chrome	1.25"	12"	38.5"	8"	<b>820-1180C</b>
	Black	1.25"	12"	38.5"	8"	<b>820-1180B</b>
	Chrome	1.25"	13"	38.5"	8"	<b>820-1181C</b>
	Black	1.25"	13"	38.5"	8"	<b>820-1181B</b>
	Chrome	1.25"	14"	38.5"	9"	<b>820-1182C</b>
	Black	1.25"	14"	38.5"	9"	<b>820-1182B</b>
	Chrome	1.25"	16"	38.5"	10"	<b>820-1183C</b>
	Black	1.25"	16"	38.5"	10"	<b>820-1183B</b>
	Chrome	1.25"	18"	38.5"	11"	<b>820-1184C</b>
	Black	1.25"	18"	38.5"	11"	<b>820-1184B</b>
08-13 FLH Touring models	Chrome	1.25"	12"	38.5"	8"	<b>820-1185C</b>
	Black	1.25"	12"	38.5"	8"	<b>820-1185B</b>
	Chrome	1.25"	13"	38.5"	8"	<b>820-1186C</b>
	Black	1.25"	13"	38.5"	8"	<b>820-1186B</b>
	Chrome	1.25"	14"	38.5"	9"	<b>820-1187C</b>
	Black	1.25"	14"	38.5"	9"	<b>820-1187B</b>
	Chrome	1.25"	16"	38.5"	10"	<b>820-1188C</b>
	Black	1.25"	16"	38.5"	10"	<b>820-1188B</b>
	Chrome	1.25"	18"	38.5"	11"	<b>820-1189C</b>
	Black	1.25"	18"	38.5"	11"	<b>820-1189B</b>
'14-Up FLH Touring models	Chrome	1.25"	12"	37.5"	8"	<b>820-1190C</b>
	Black	1.25"	12"	37.5"	8"	<b>820-1190B</b>
	Chrome	1.25"	13"	37.5"	8"	<b>820-1191C</b>
	Black	1.25"	13"	37.5"	8"	<b>820-1191B</b>
	Chrome	1.25"	14"	37.5"	9"	<b>820-1192C</b>
	Black	1.25"	14"	37.5"	9"	<b>820-1192B</b>
	Chrome	1.25"	16"	37.5"	10"	<b>820-1193C</b>
	Black	1.25"	16"	37.5"	10"	<b>820-1193B</b>
	Chrome	1.25"	18"	37.5"	11"	<b>820-1194C</b>
	Black	1.25"	18"	37.5"	11"	<b>820-1194B</b>

- WINDSHIELDS / FAIRINGS
- AUDIO / COMMUNICATION
- SEATS / LUGGAGE
- BARS / MIRRORS / CONTROLS**
- EXHAUST
- AIR / FUEL SYSTEMS
- ENGINE
- TRANSMISSION / DRIVELINE
- GASKETS / SEALS
- ELECTRICAL
- LIGHTING
- CABLES
- BRAKES
- OIL FILTERS
- SUSPENSION
- BODY
- WHEELS
- TIRES / TIRE ACC.
- BIKE ACC.
- VICTORY / INDIAN
- COVERS / LOCKS / TIEDOWNS
- CHEMICALS
- TOOLS
- HELMETS
- HELMET ACC.
- EYEWEAR
- APPAREL / RIDER ACC.
- PROMOTIONAL
- REFERENCE
- INDEX



## 1 1/4" APE HANGER HANDLEBARS

They fit the OEM 1 1/4" riser setup on the following models: '06-Up FXDWG, '08-13 FXDF, '06-13 FLSTF/B, '10-11 FLSTSE, 2013 FXSBSE, FLHRSE, FLTRXSE. May be fitted to other models with the use of suitable 1 1/4" risers.

- Handlebars are 1 1/4" through the clamping area (see page 164 for risers)
- Dimpled and drilled for internal wiring
- Black or Chrome finish
- These bars go from 1 1/4" to 1" at the grip mount
- Not for Throttle By Wire models



Color	Tube Size	Height	Width	Pull Back	Center Width	WPS#
<b>1-1/4" APE HANGER (DIMPLED FOR WIRING)</b>						
Chrome	1.25"	12"	36"	9"	9"	<b>820-54500</b>
Black	1.25"	12"	36"	9"	9"	<b>820-54505</b>
Chrome	1.25"	14"	36"	9"	9"	<b>820-54501</b>
Black	1.25"	14"	36"	9"	9"	<b>820-54506</b>
Chrome	1.25"	16"	36"	9"	9"	<b>820-54502</b>
Black	1.25"	16"	36"	9"	9"	<b>820-54507</b>
Chrome	1.25"	18"	36"	9"	9"	<b>820-54503</b>
Black	1.25"	18"	36"	9"	9"	<b>820-54508</b>
Chrome	1.25"	20"	36"	9"	9"	<b>820-54504</b>
Black	1.25"	20"	36"	9"	9"	<b>820-54509</b>

- Dimpled and drilled for internal wiring
- Black or Chrome finish
- These bars go from 1 1/4" to 1" at the grip mount and clamping area
- Not for Throttle By Wire models



Color	Tube Size	Height	Width	Pull Back	Center Width	WPS#
<b>1-1/4" APE HANGER (DIMPLED FOR WIRING)</b>						
Chrome	1.25"	12"	37"	8.50"	9"	<b>820-54510</b>
Black	1.25"	12"	37"	8.50"	9"	<b>820-54515</b>
Chrome	1.25"	14"	37"	8.50"	9"	<b>820-54511</b>
Black	1.25"	14"	37"	8.50"	9"	<b>820-54516</b>
Chrome	1.25"	16"	37"	8.50"	9"	<b>820-54512</b>
Black	1.25"	16"	37"	8.50"	9"	<b>820-54517</b>
Chrome	1.25"	18"	37"	8.50"	9"	<b>820-54513</b>
Black	1.25"	18"	37"	8.50"	9"	<b>820-54518</b>
Chrome	1.25"	20"	37"	8.50"	9"	<b>820-54514</b>
Black	1.25"	20"	37"	8.50"	9"	<b>820-54519</b>

**NARROW APE HANGERS**



- Perfect for Sportsters or Dynas or choppers with narrow glide front ends
- Available in three heights and either chrome or satin black finish
- Wrist angle is perfect for that chopper style riding position



A



B



C



Description/Application	Color	Tube Size	Height	Width	Pull Back	Center Width	WPS#
<b>1" NARROW APES</b>							
A 82-Up Dimpled	Chrome	1"	12"	36"	4.5"	7.25"	<b>820-54530</b>
82-Up Dimpled	Black	1"	12"	36"	4.5"	7.25"	<b>820-54531</b>
B 82-Up Dimpled	Chrome	1"	14"	36"	4.5"	7.25"	<b>820-54532</b>
82-Up Dimpled	Black	1"	14"	36"	4.5"	7.25"	<b>820-54533</b>
C 82-Up Dimpled	Chrome	1"	16"	36"	4.5"	7.25"	<b>820-54534</b>
82-Up Dimpled	Black	1"	16"	36"	4.5"	7.25"	<b>820-54535</b>

WINDSHIELDS / FAIRINGS

AUDIO / COMMUNICATION

SEATS / LUGGAGE

**BARS / MIRRORS / CONTROLS**

EXHAUST

AIR / FUEL SYSTEMS

ENGINE

TRANSMISSION / DRIVELINE

GASKETS / SEALS

ELECTRICAL

LIGHTING

CABLES

BRAKES

OIL FILTERS

SUSPENSION

BODY

WHEELS

TIRES / TIRE ACC.

BIKE ACC.

VICTORY / INDIAN

COVERS / LOCKS / TIEDOWNS

CHEMICALS

TOOLS

HELMETS

HELMET ACC.

EYEWEAR

APPAREL / RIDER ACC.

PROMOTIONAL

REFERENCE

INDEX



## APE HANGER HANDLEBARS

- HardDrive 1" dia Ape Hangers are made of high quality steel tubing
- Dimpled for external wiring and knurled for 3 1/2" riser spacing
- From 8" to 16" rise height and have a polished chrome finish
- Fits most models except 1980~Up Touring models with fairings and 2008~Up models with TBW

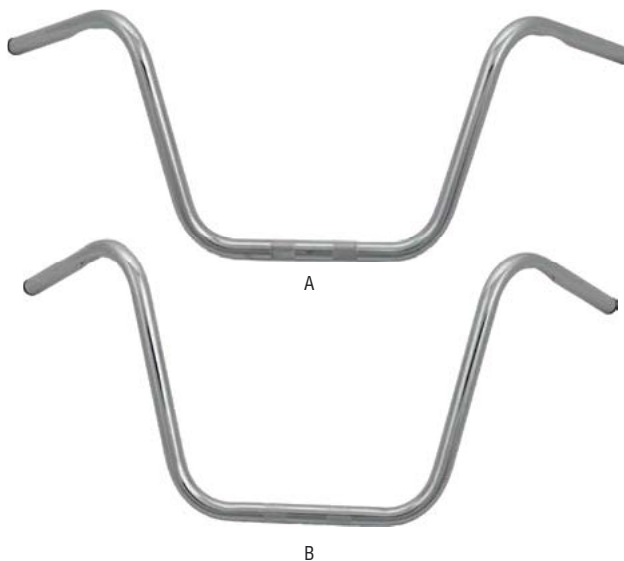

Description/Application	Color	Tube Size	Height	Width	Pull Back	Center Width	WPS#
<b>APE HANGER BAR</b>							
'82-Up w/Dimple for wiring	Chrome	1"	8"	32.5"	8.5"	8"	<b>820-1103</b>
'82-Up w/Dimple for wiring	Chrome	1"	10"	35"	8"	8"	<b>820-1104</b>
<b>A</b> '82-Up w/Dimple for wiring	Chrome	1"	12"	35"	10"	10"	<b>820-1105</b>
<b>B</b> '82-Up w/Dimple for wiring	Chrome	1"	14"	34"	7.5"	8.5"	<b>820-1106</b>
'82-Up w/Dimple for wiring	Chrome	1"	16"	35.5"	6.75"	9"	<b>820-1107</b>

## "BUCKHORN" HANDLEBARS

- Our 1" dia Buckhorn Bars are constructed of high quality steel tubing
- Traditional style and a comfortable ride come along with a deep chrome finish
- Dimpled for external wiring and knurled for 3 1/2" riser spacing
- Fits most models except 1980~Up Touring models with fairings and 2008~Up models with TBW

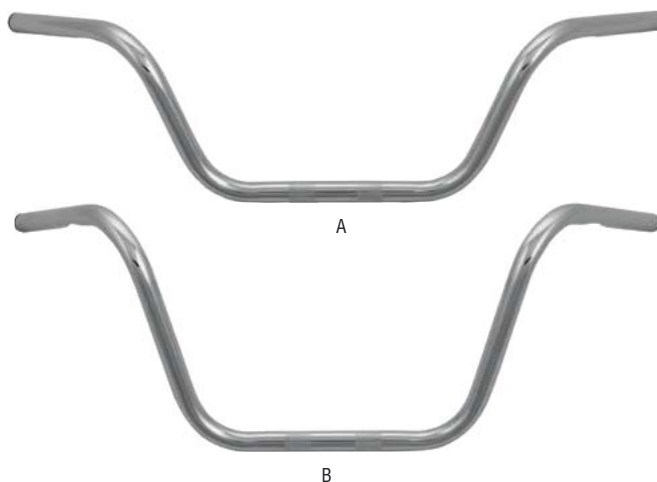

Description/Application	Color	Tube Size	Height	Width	Pull Back	Center Width	WPS#
<b>CUSTOM BUCKHORN BAR (DIMPLED FOR WIRING)</b>							
Low / '82-Up all HD	Chrome	1"	5"	31.25"	7"	8.5"	<b>820-1171</b>
<b>A</b> Medium / '82-Up all HD	Chrome	1"	7"	32.75"	7.25"	8.5"	<b>820-1172</b>
<b>B</b> Low / '82-Up all HD	Chrome	1"	10"	32.75"	9.75"	8.5"	<b>820-1173</b>



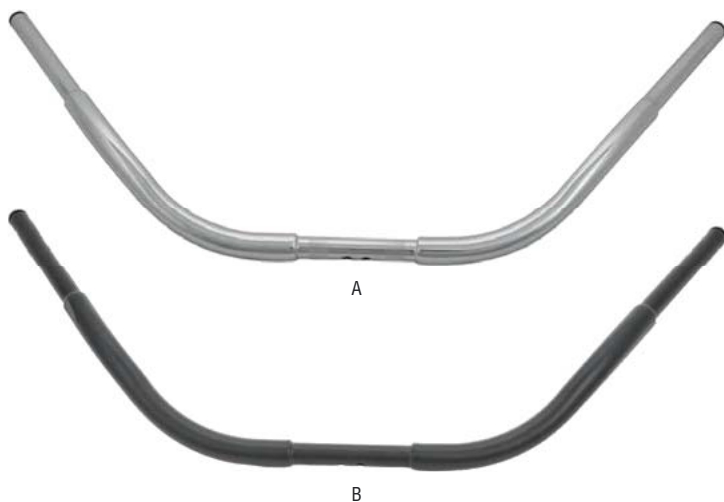

### 1-1/4" FAT HANDLEBARS

- HardDrive 1 1/4" dia Fat Bars are made of heavy duty high grade steel tubing
- They bring plenty of attitude with Fat tubing expertly welded step-joints, dimpled and a wiring pull-cord installed for easy wiring installation Knurled 3 1/2" riser spacing
- Available in chrome or black
- Fits most models except 1980~Up Touring models with fairings and 2008~Up models with TBW

Description/ Application	Color	Tube Size	Height	Width	Pull Back	Center Width	WPS#
<b>FAT BAR W/KNURL AND DRILLED FOR INTERNAL WIRING</b>							
A Bikini Beach	Chrome	1.25"	3.5"	36.5"	15"	10.5"	<b>820-1145C</b>
B Bikini Beach	Black	1.25"	3.5"	36.5"	15"	10.5"	<b>820-1145B</b>

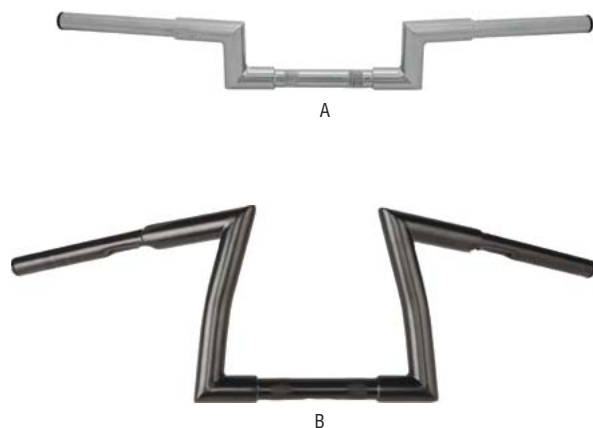

### 1-1/4" FAT-Z HANDLEBARS

- HardDrive 1 1/4" FAT-Z Bars have plenty of attitude and look great
- Made of heavy duty, high grade steel tubing with expertly welded step-joints, a high quality finish and are knurled for 3 1/2" riser spacing
- Comes with pull cord to make installation easy
- Available in chrome or black
- Fits most models except 1980~Up Touring models with fairings and 2008~Up models with TBW

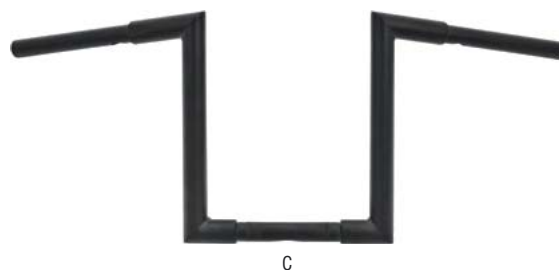

Description/ Application	Color	Tube Size	Height	Width	Pull Back	Center Width	WPS#
<b>1-1/4" FAT-Z BAR (DRILLED FOR INTERNAL WIRING)</b>							
A '82-Up all HD	Chrome	1.25"	4"	31.5"	10.25"	8.5"	<b>820-1121C</b>
'82-Up all HD	Black	1.25"	4"	31.5"	10.25"	8.5"	<b>820-1121B</b>
'82-Up all HD	Chrome	1.25"	9"	30"	5"	11.25"	<b>820-1123C</b>
B '82-Up all HD	Black	1.25"	9"	30"	5"	11.25"	<b>820-1123B</b>
'82-Up all HD	Chrome	1.25"	12"	31.5"	13.5"	8.5"	<b>820-1124C</b>
C '82-Up all HD	Black	1.25"	12"	31.5"	13.5"	8.5"	<b>820-1124B</b>
D '82-Up all HD	Chrome	1.25"	16"	31.5"	10"	8.5"	<b>820-1126C</b>
'82-Up all HD	Black	1.25"	16"	31.5"	10"	8.5"	<b>820-1126B</b>

- WINDSHIELDS / FAIRINGS
- AUDIO / COMMUNICATION
- SEATS / LUGGAGE
- BARS / MIRRORS / CONTROLS
- EXHAUST
- AIR / FUEL SYSTEMS
- ENGINE
- TRANSMISSION / DRIVELINE
- GASKETS / SEALS
- ELECTRICAL
- LIGHTING
- CABLES
- BRAKES
- OIL FILTERS
- SUSPENSION
- BODY
- WHEELS
- TIRES / TIRE ACC.
- BIKE ACC.
- VICTORY / INDIAN
- COVERS / LOCKS / TIEDOWNS
- CHEMICALS
- TOOLS
- HELMETS
- HELMET ACC.
- EYEWEAR
- APPAREL / RIDER ACC.
- PROMOTIONAL
- REFERENCE
- INDEX



## TRADITIONAL Z BARS

- HardDrive 1" Z-bars in the traditional straight format
- Available in chrome or gloss black
- Dimpled for 82-Up applications
- Bars are Not pre-drilled

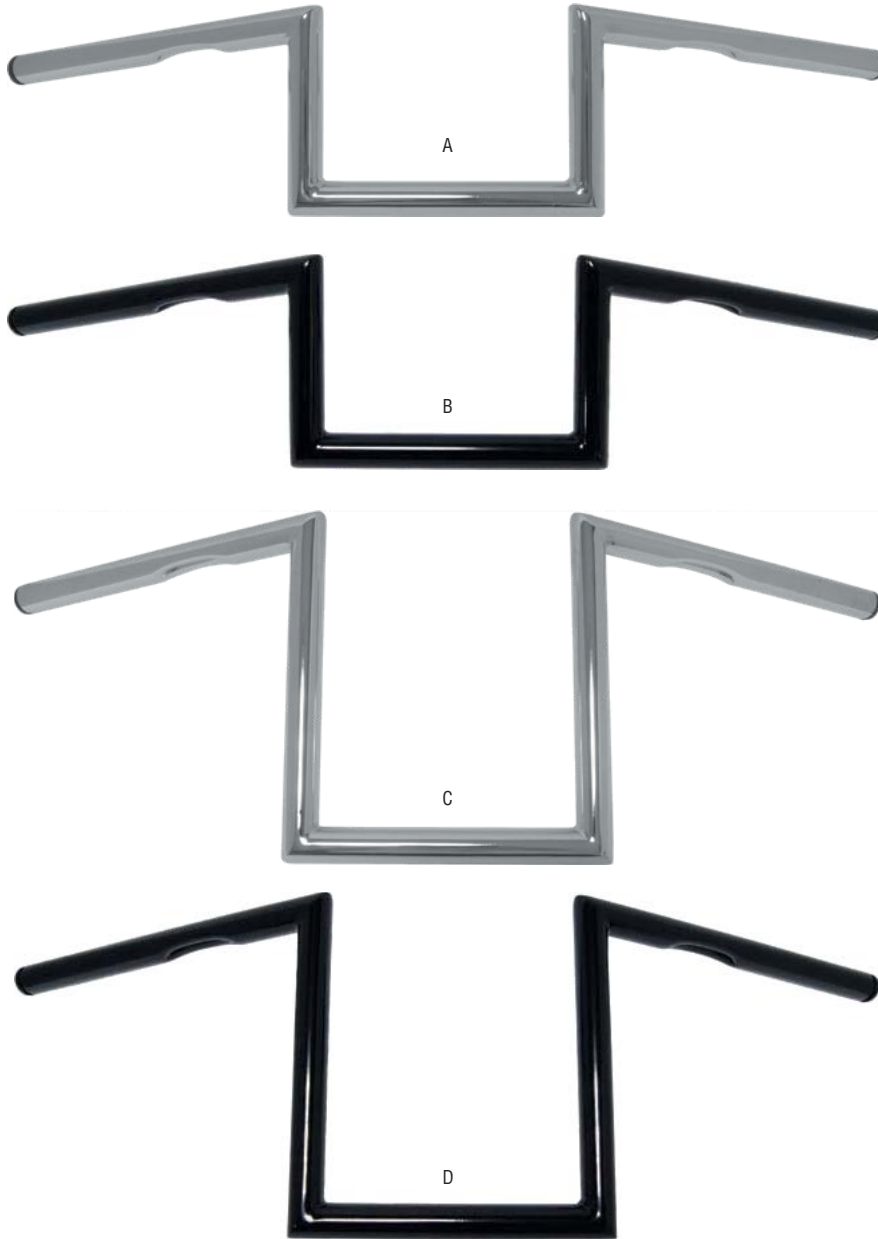

Description/Application	Color	Tube Size	Height	Width	Pull Back	Center Width	WPS#
<b>1" Z-BAR</b>							
82-Up Dimpled	Chrome	1"	4"	28.5"	4.5"	7.25"	<b>820-1206</b>
82-Up Dimpled	Black	1"	4"	28.5"	4.5"	7.25"	<b>820-1207</b>
A 82-Up Dimpled	Chrome	1"	6"	28.5"	4.5"	7.25"	<b>820-1200</b>
B 82-Up Dimpled	Black	1"	6"	28.5"	4.5"	7.25"	<b>820-1201</b>
82-Up Dimpled	Chrome	1"	8"	28.5"	4.5"	7.25"	<b>820-1202</b>
82-Up Dimpled	Black	1"	8"	28.5"	4.5"	7.25"	<b>820-1203</b>
C 82-Up Dimpled	Chrome	1"	10"	28.5"	4.5"	7.25"	<b>820-1204</b>
D 82-Up Dimpled	Black	1"	10"	28.5"	4.5"	7.25"	<b>820-1205</b>



## Z HANDLEBARS

- HardDrive 1" dia bars give a custom cool look and a comfortable ride
- Available in chrome or black, and made of high quality steel tubing
- Meant for custom applications

Description/Application	Color	Tube Size	Height	Width	Pull Back	Center Width	WPS#
<b>1" Z-BAR</b>							
A Pre-82 Not Dimpled or Drilled	Chrome	1"	3"	30"	9"	9"	<b>820-1111C</b>
Pre-82 Not Dimpled or Drilled	Black	1"	3"	30"	9"	9"	<b>820-1111B</b>
Pre-82 Not Dimpled or Drilled	Chrome	1"	9"	33"	7"	11"	<b>820-1113C</b>
B Pre-82 Not Dimpled or Drilled	Black	1"	9"	33"	7"	11"	<b>820-1113B</b>
C Pre-82 Not Dimpled or Drilled	Chrome	1"	12"	28 3/4"	6"	9 7/8"	<b>820-1114C</b>
Pre-82 Not Dimpled or Drilled	Black	1"	12"	28 3/4"	6"	9 7/8"	<b>820-1114B</b>

## Z HANDLEBARS W/LEDS



- 1 1/4" Z Bars w/ Integrated Amber L.E.D Marker Lights
- 1" Clamping and Hand Control Area
- Available in Show Chrome, Gloss Black and Matte Black
- Pre Drilled For Internal Wiring
- TBW Ready

Description/Application	Color	Tube Size	Height	Width	Pull Back	Center Width	WPS#
<b>Z BARS W/ LED MARKER LIGHTS</b>							
82-Up (except batwing fairing)	Chrome	1 1/4"	6"	33.5"	6.8"	5"	<b>820-54536</b>
82-Up (except batwing fairing)	Gloss Black	1 1/4"	6"	33.5"	6.8"	5"	<b>820-54537</b>
82-Up (except batwing fairing)	Matte Black	1 1/4"	6"	33.5"	6.8"	5"	<b>820-54538</b>
82-Up (except batwing fairing)	Chrome	1 1/4"	8"	33.5"	6.8"	5"	<b>820-54539</b>
82-Up (except batwing fairing)	Gloss Black	1 1/4"	8"	33.5"	6.8"	5"	<b>820-54540</b>
82-Up (except batwing fairing)	Matte Black	1 1/4"	8"	33.5"	6.8"	5"	<b>820-54541</b>
82-Up (except batwing fairing)	Chrome	1 1/4"	10"	33.5"	6.8"	5"	<b>820-54542</b>
82-Up (except batwing fairing)	Gloss Black	1 1/4"	10"	33.5"	6.8"	5"	<b>820-54543</b>
82-Up (except batwing fairing)	Matte Black	1 1/4"	10"	33.5"	6.8"	5"	<b>820-54544</b>

## DRAG HANDLEBARS

- HardDrive 1" dia Drag Bars are constructed of high quality steel tubing. Comfortable ride and a performance custom look
- Available in chrome or black
- Knurled for 3 1/2" riser spacing
- Fits most models except Touring models with fairing and 2008-Up models with TBW

Description/Application	Color	Tube Size	Height	Width	Pull Back	Center Width	WPS#
<b>1" DRAG BARS</b>							
A '82-Up all HD except models with fairings and TBW	Chrome	1"	2"	29 3/4"	7 1/2"	8"	<b>820-1131C</b>
'82-Up all HD except models with fairings and TBW	Black	1"	2"	29 3/4"	7 1/2"	8"	<b>820-1131B</b>
'82-Up all HD except models with fairings and TBW	Chrome	1"	0"	28 1/2"	5 1/2"	8 1/2"	<b>820-1132C</b>
B '82-Up all HD except models with fairings and TBW	Black	1"	0"	28 1/2"	5 1/2"	8 1/2"	<b>820-1132B</b>
'82-Up all HD except models with fairings and TBW *	Chrome	1"	0"	27 1/2"	4 7/8"	8"	<b>820-1133C</b>
'82-Up all HD except models with fairings and TBW *	Black	1"	0"	27 1/2"	4 7/8"	8"	<b>820-1133B</b>

\*OEM# 56558-95

- WINDSHIELDS / FAIRINGS
- AUDIO / COMMUNICATION
- SEATS / LUGGAGE
- BARS / MIRRORS / CONTROLS
- EXHAUST
- AIR / FUEL SYSTEMS
- ENGINE
- TRANSMISSION / DRIVELINE
- GASKETS / SEALS
- ELECTRICAL
- LIGHTING
- CABLES
- BRAKES
- OIL FILTERS
- SUSPENSION
- BODY
- WHEELS
- TIRES / TIRE ACC.
- BIKE ACC.
- VICTORY / INDIAN
- COVERS / LOCKS / TIEDOWNS
- CHEMICALS
- TOOLS
- HELMETS
- HELMET ACC.
- EYEWEAR
- APPAREL / RIDER ACC.
- PROMOTIONAL
- REFERENCE
- INDEX



## FAT TILLER HANDLEBARS

- HardDrive's FAT Tillers are available in 1-1/4" and 1-1/2" dia.
- They are custom cool and bring a comfortable ride
- Made of heavy duty, high quality steel tubing and expertly welded and step-jointed
- Available in chrome or black
- Drilled for internal wiring with installed pull-cord for easy wire installation
- Set for 3-1/2" center to center riser mounting
- Fits most models 1982-Up except Springers and Touring models with fairings or TBW



Description/Application	Color	Tube Size	Height	Width	Pull Back	WPS#
<b>TILLER FAT BAR (DRILLED FOR INTERNAL WIRING)</b>						
'82-Up All models except Springer	Chrome	1.25"	6"	29"	7"	<b>820-1161C</b>
'82-Up All models except Springer	Black	1.25"	6"	29"	7"	<b>820-1161B</b>
A '82-Up All models except Springer	Chrome	1.25"	8"	29"	8"	<b>820-1162C</b>
B '82-Up All models except Springer	Black	1.25"	8"	29"	8"	<b>820-1162B</b>
'82-Up All models except Springer	Chrome	1.25"	10"	29"	8"	<b>820-1163C</b>
'82-Up All models except Springer	Black	1.25"	10"	29"	8"	<b>820-1163B</b>
'82-Up All models except Springer	Chrome	1.5"	8"	32.75"	8"	<b>820-1166C</b>
'82-Up All models except Springer	Black	1.5"	8"	32.75"	8"	<b>820-1166B</b>
C '82-Up All models except Springer	Chrome	1.5"	10"	32.75"	8"	<b>820-1167C</b>
'82-Up All models except Springer	Black	1.5"	10"	32.75"	8"	<b>820-1167B</b>

## FAT DRAG HANDLEBARS

- HardDrive FAT Drag bars are available in 1-1/4" and 1-1/2" dia.
- They bring a comfortable ride and great FAT looks
- Made of heavy duty, high quality tubing with expertly welded step-joints and are knurled for 3-1/2" riser spacing
- Available in chrome or black
- Will not fit models with TBW



Description/Application	Color	Tube Size	Height	Width	Pull Back	WPS#
<b>FAT DRAG STYLE (DRILLED FOR INTERNAL WIRING)</b>						
'82-Up Big Twins & Sportsters	Chrome	1.25"	0"	30.5"	6.25"	<b>820-1150C</b>
'82-Up Big Twins & Sportsters	Black	1.25"	0"	30.5"	6.25"	<b>820-1150B</b>
'82-Up Big Twins & Sportsters	Chrome	1.5"	0"	30.5"	6.25"	<b>820-1151C</b>
'82-Up Big Twins & Sportsters	Black	1.5"	0"	30.5"	6.25"	<b>820-1151B</b>



## HANDLEBAR RISERS

Forbidden Motorcycles risers feature a 1-1/8" clamping area for MX style bars. They come in 9" and 11" heights and raw or black anodized finishes. The top clamp is a one piece construction for extreme stability and durability. The FM logo is machined into the T 6061 aluminum. The risers are pre-drilled for internal wiring for a super clean assembly, we also offer FM moto bars by Fly Racing with 1" ends for HD controls and pre-drilled holes for internal wiring to bolt directly onto these risers!

Description	WPS#
FM Risers 9" Raw	825-05000
FM Risers 9" Black	825-05001
FM Risers 11" Raw	825-05002
FM Risers 11" Black	825-05003
<b>RISERS WITH GAUGE MOUNT TABS</b>	
FM Risers 9" Raw	825-05005
FM Risers 9" Black	825-05006
FM Risers 11" Raw	825-05007
FM Risers 11" Black	825-05008
<b>TOP CLAMPS ONLY W/GAUGE MOUNT TABS</b>	
FM Top Clamp Raw	825-05010
FM Top Clamp Black	825-05011

## MOTO STYLE BARS WITH 1" ENDS

These moto style bars are designed by Forbidden Motorcycles and made by Fly Racing! They feature the moto typical 1-1/8" clamping area but taper down to 1" to accommodate stock Harley hand controls, eliminating the need to sleeve them. They are pre drilled for internal wiring, including the holes to run wires through the FM risers. Bars are 32" wide, pullback is 3" and rise is 2.5"



Description	WPS#
FM Moto Style Bar Black	825-05050
FM Moto Style Bar Silver	825-05051
FM Moto Style Bar Gold	825-05052
FM Moto Style Bar Red	825-05053
<b>FOR THROTTLE BY WIRE MODELS</b>	
FM Moto Style Bar Black	825-05054
FM Moto Style Bar Silver	825-05055
FM Moto Style Bar Gold	825-05056
FM Moto Style Bar Red	825-05057

- WINDSHIELDS / FAIRINGS
- AUDIO / COMMUNICATION
- SEATS / LUGGAGE
- BARS / MIRRORS / CONTROLS**
- EXHAUST
- AIR / FUEL SYSTEMS
- ENGINE
- TRANSMISSION / DRIVELINE
- GASKETS / SEALS
- ELECTRICAL
- LIGHTING
- CABLES
- BRAKES
- OIL FILTERS
- SUSPENSION
- BODY
- WHEELS
- TIRES / TIRE ACC.
- BIKE ACC.
- VICTORY / INDIAN
- COVERS / LOCKS / TIEDOWNS
- CHEMICALS
- TOOLS
- HELMETS
- HELMET ACC.
- EYEWEAR
- APPAREL / RIDER ACC.
- PROMOTIONAL
- REFERENCE
- INDEX

- WINDSHIELDS / FAIRINGS
- AUDIO / COMMUNICATION
- SEATS / LUGGAGE
- BARS / MIRRORS / CONTROLS**
- EXHAUST
- AIR / FUEL SYSTEMS
- ENGINE
- TRANSMISSION / DRIVELINE
- GASKETS / SEALS
- ELECTRICAL
- LIGHTING
- CABLES
- BRAKES
- OIL FILTERS
- SUSPENSION
- BODY
- WHEELS
- TIRES / TIRE ACC.
- BIKE ACC.
- VICTORY / INDIAN
- COVERS / LOCKS / TIEDOWNS
- CHEMICALS
- TOOLS
- HELMETS
- HELMET ACC.
- EYEWEAR
- APPAREL / RIDER ACC.
- PROMOTIONAL
- REFERENCE
- INDEX



## OG SLIMS RISERS NEW



Forbidden Motorcycles introduces their NEW OG Slims risers. Still sporting that no non-sense, aggressive look and feel, available in both 9" or 11" rise and your choice of black anodize or raw finish. The new OG's are made from super strong T6061 aluminum with the famous FM one piece top clamp for extreme stability. You asked and Forbidden listened, the OG's are now designed so you can run your favorite MX style bar with a 1" clamping area and OG's use the OEM bolt pattern on the top clamp so you can run the stock Dyna and Sportster gauge mounts.

Description	WPS#
FM Risers 9" Raw	825-05020
FM Risers 9" Black	825-05021
FM Risers 11" Raw	825-05022
FM Risers 11" Black	825-05023



**BAGGER HANDLEBARS** **NEW**



- Made from 1.5" steel tubing
- CNC machined bases with heavy straight knurling providing the most grip possible
- CNC machined step down at the grips to give a seamless flow from the bar to the controls

- Every corner is precision cut and hand deburred to insure a smooth travel path for internal wiring
- Fully TIG welded
- Proudly crafted in the USA!



834-01000



834-01001



834-01020



834-01021



834-01030



834-01031



834-01040



834-01041



Description	Color	Tube Size	Height	Width	WPS #
<b>FOR FLH W/BATWING FAIRING '14-UP</b>					
Square Top	Chrome	1.5"	12"	35"	<b>834-01000</b>
Square Top	Black	1.5"	12"	35"	<b>834-01001</b>
Pointed Top	Chrome	1.5"	12"	36.5"	<b>834-01020</b>
Pointed Top	Black	1.5"	12"	36.5"	<b>834-01021</b>
<b>FOR FLH W/BATWING FAIRING '80-13</b>					
Pointed Top	Chrome	1.5"	12"	36.5"	<b>834-01010</b>
Pointed Top	Black	1.5"	12"	36.5"	<b>834-01011</b>
<b>FOR FLTR '15-UP</b>					
Square Top	Chrome	1.5"	12"	35"	<b>834-01030</b>
Square Top	Black	1.5"	12"	35"	<b>834-01031</b>
Pointed Top	Chrome	1.5"	12"	35"	<b>834-01040</b>
Pointed Top	Black	1.5"	12"	35"	<b>834-01041</b>

- WINDSHIELDS / FAIRINGS
- AUDIO / COMMUNICATION
- SEATS / LUGGAGE
- BARS / MIRRORS / CONTROLS**
- EXHAUST
- AIR / FUEL SYSTEMS
- ENGINE
- TRANSMISSION / DRIVELINE
- GASKETS / SEALS
- ELECTRICAL
- LIGHTING
- CABLES
- BRAKES
- OIL FILTERS
- SUSPENSION
- BODY
- WHEELS
- TIRES / TIRE ACC.
- BIKE ACC.
- VICTORY / INDIAN
- COVERS / LOCKS / TIEDOWNS
- CHEMICALS
- TOOLS
- HELMETS
- HELMET ACC.
- EYEWEAR
- APPAREL / RIDER ACC.
- PROMOTIONAL
- REFERENCE
- INDEX

WINDSHIELDS / FAIRINGS  
 AUDIO / COMMUNICATION  
 SEATS / LUGGAGE  
**BARS / MIRRORS / CONTROLS**  
 EXHAUST  
 AIR / FUEL SYSTEMS  
 ENGINE  
 TRANSMISSION / DRIVELINE  
 GASKETS / SEALS  
 ELECTRICAL  
 LIGHTING  
 CABLES  
 BRAKES  
 OIL FILTERS  
 SUSPENSION  
 BODY  
 WHEELS  
 TIRES / TIRE ACC.  
 BIKE ACC.  
 VICTORY / INDIAN  
 COVERS / LOCKS / TIEDOWNS  
 CHEMICALS  
 TOOLS  
 HELMETS  
 HELMET ACC.  
 EYEWEAR  
 APPAREL / RIDER ACC.  
 PROMOTIONAL  
 REFERENCE  
 INDEX



## UNIVERSAL HANDLEBARS

- Bars are dimpled for 82-Up applications
- Dimensions are measured center to center of pipe
- It may be necessary to change cables and wiring when using these handlebars



**MID BOBBER BAR**



**BOBBER BAR**



**NARROW CHOPPER BAR**



**LOOSE BAR**

Description	Color	Tube Size	Height	Width	Pull Back	WPS #
<b>MID BOBBER BAR</b>						
Stainless Steel with Dimples	Polished	1"	4.5"	28"	6"	<b>750-01212</b>
Steel with Dimples	Black	1"	4.5"	28"	6"	<b>750-01213</b>
<b>BOBBER BAR</b>						
Stainless Steel with Dimples	Polished	1"	7"	29"	6.5"	<b>750-01200</b>
Steel with Dimples	Black	1"	7"	29"	6.5"	<b>750-01201</b>
<b>NARROW CHOPPER BAR</b>						
Steel with Dimples	Chrome	1"	7"	23"	12"	<b>750-01202</b>
<b>LOOSE BAR</b>						
Steel with Dimples	Black	1"	11"	28"	7"	<b>750-01203</b>





## UNIVERSAL HANDLEBARS



**RABBIT BAR**



**ATTACK BAR**



**PULLBACK RISER BAR**



Description	Color	Tube Size	Height	Width	Pull Back	WPS #
<b>RABBIT BAR</b>						
Stainless Steel with Dimples	Polished	1"	8"	18"	11"	<b>750-01204</b>
Steel with Dimples	Black	1"	8"	18"	11"	<b>750-01205</b>
<b>TALL RABBIT BAR</b>						
Stainless Steel with Dimples	Polished	1"	10"	18"	11"	<b>750-01219</b>
Steel with Dimples	Black	1"	10"	18"	11"	<b>750-01220</b>
<b>ATTACK BAR</b>						
Stainless Steel with Dimples 10"	Polished	1"	10"	24"	5"	<b>750-01206</b>
Steel with Dimples 10"	Black	1"	10"	24"	5"	<b>750-01207</b>
Stainless Steel with Dimples 8"	Polished	1"	8"	24"	5"	<b>750-01208</b>
Steel with Dimples 8"	Black	1"	8"	24"	5"	<b>750-01209</b>
<b>PULLBACK RISER BAR</b>						
Stainless Steel with Dimples	Polished	1"	8"	24.5"	6"	<b>750-01210</b>

- WINDSHIELDS / FAIRINGS
- AUDIO / COMMUNICATION
- SEATS / LUGGAGE
- BARS / MIRRORS / CONTROLS**
- EXHAUST
- AIR / FUEL SYSTEMS
- ENGINE
- TRANSMISSION / DRIVELINE
- GASKETS / SEALS
- ELECTRICAL
- LIGHTING
- CABLES
- BRAKES
- OIL FILTERS
- SUSPENSION
- BODY
- WHEELS
- TIRES / TIRE ACC.
- BIKE ACC.
- VICTORY / INDIAN
- COVERS / LOCKS / TIEDOWNS
- CHEMICALS
- TOOLS
- HELMETS
- HELMET ACC.
- EYEWEAR
- APPAREL / RIDER ACC.
- PROMOTIONAL
- REFERENCE
- INDEX



## RISER BARS

This bar is perfect for an upright riding position. Available in chrome or satin black and 1" or 1.25" tube sizes. Fits triple trees with 3.5" center to center riser spacing.



Description	Color	Tube Size	Height	Width	Pull Back	WPS #
<b>RISER BAR</b>						
Steel with Dimples	Black	1"	14"	27"	4"	<b>750-01215</b>
	Chrome	1"	14"	27"	4"	<b>750-01216</b>
Steel with Dimples	Black	1.25"	14"	27"	4"	<b>750-01217</b>
	Chrome	1.25"	14"	27"	4"	<b>750-01218</b>

- WINDSHIELDS / FAIRINGS
- AUDIO / COMMUNICATION
- SEATS / LUGGAGE
- BARS / MIRRORS / CONTROLS**
- EXHAUST
- AIR / FUEL SYSTEMS
- ENGINE
- TRANSMISSION / DRIVELINE
- GASKETS / SEALS
- ELECTRICAL
- LIGHTING
- CABLES
- BRAKES
- OIL FILTERS
- SUSPENSION
- BODY
- WHEELS
- TIRES / TIRE ACC.
- BIKE ACC.
- VICTORY / INDIAN
- COVERS / LOCKS / TIEDOWNS
- CHEMICALS
- TOOLS
- HELMETS
- HELMET ACC.
- EYEWEAR
- APPAREL / RIDER ACC.
- PROMOTIONAL
- REFERENCE
- INDEX



# 1" HANDLEBARS

- American made .109" wall CNC mandrel bent steel tubing
- Precision TIG welded
- Smooth or dimpled for '82-Up applications (except throttle by wire)
- Satin black powdercoat or triple chrome plated
- 1" diameter



WHISKEY BARS

Description	Color	Tube Size	Height	Width	Pull Back	WPS #
<b>WHISKEY BARS</b>						
Pre-'82	Black	1"	9"	24"	3"	<b>563-01700</b>
Dimpled '82-Up	Black	1"	9"	24"	3"	<b>563-01701</b>
Pre-'82	Chrome	1"	9"	24"	3"	<b>563-01702</b>
Dimpled '82-Up	Chrome	1"	9"	24"	3"	<b>563-01703</b>



SPEEDLINE BARS

Description	Color	Tube Size	Height	Width	Pull Back	WPS #
<b>SPEEDLINE BARS</b>						
Pre-'82	Black	1"	7.5"	28"	2"	<b>563-01704</b>
Dimpled '82-Up	Black	1"	7.5"	28"	2"	<b>563-01705</b>
Pre-'82	Chrome	1"	7.5"	28"	2"	<b>563-01706</b>
Dimpled '82-Up	Chrome	1"	7.5"	28"	2"	<b>563-01707</b>



RABBIT BARS

Description	Color	Tube Size	Height	Width	Pull Back	WPS #
<b>RABBIT BARS</b>						
Pre-'82	Black	1"	12"	18"	10"	<b>563-01708</b>
Pre-'82	Chrome	1"	12"	18"	10"	<b>563-01709</b>

- WINDSHIELDS / FAIRINGS
- AUDIO / COMMUNICATION
- SEATS / LUGGAGE
- BARS / MIRRORS / CONTROLS
- EXHAUST
- AIR / FUEL SYSTEMS
- ENGINE
- TRANSMISSION / DRIVELINE
- GASKETS / SEALS
- ELECTRICAL
- LIGHTING
- CABLES
- BRAKES
- OIL FILTERS
- SUSPENSION
- BODY
- WHEELS
- TIRES / TIRE ACC.
- BIKE ACC.
- VICTORY / INDIAN
- COVERS / LOCKS / TIEDOWNS
- CHEMICALS
- TOOLS
- HELMETS
- HELMET ACC.
- EYEWEAR
- APPAREL / RIDER ACC.
- PROMOTIONAL
- REFERENCE
- INDEX



# 1" HANDLEBARS



**BMX BARS**



Description	Color	Tube Size	Height	Width	Pull Back	WPS #
<b>BMX BARS</b>						
Pre-'82	Black	1"	8"	29"	2"	<b>563-01722</b>
Dimpled '82-Up	Black	1"	8"	29"	2"	<b>563-01723</b>
Pre-'82	Chrome	1"	8"	29"	2"	<b>563-01724</b>
Dimpled '82-Up	Chrome	1"	8"	29"	2"	<b>563-01725</b>



**ENDURO BARS**



Description	Color	Tube Size	Height	Width	Pull Back	WPS #
<b>ENDURO BARS</b>						
Pre-'82	Black	1"	4.5"	32"	3"	<b>563-01718</b>
Dimpled '82-Up	Black	1"	4.5"	32"	3"	<b>563-01719</b>
Pre-'82	Chrome	1"	4.5"	32"	3"	<b>563-01720</b>
Dimpled '82-Up	Chrome	1"	4.5"	32"	3"	<b>563-01721</b>

- WINDSHIELDS / FAIRINGS
- AUDIO / COMMUNICATION
- SEATS / LUGGAGE
- BARS / MIRRORS / CONTROLS**
- EXHAUST
- AIR / FUEL SYSTEMS
- ENGINE
- TRANSMISSION / DRIVELINE
- GASKETS / SEALS
- ELECTRICAL
- LIGHTING
- CABLES
- BRAKES
- OIL FILTERS
- SUSPENSION
- BODY
- WHEELS
- TIRES / TIRE ACC.
- BIKE ACC.
- VICTORY / INDIAN
- COVERS / LOCKS / TIEDOWNS
- CHEMICALS
- TOOLS
- HELMETS
- HELMET ACC.
- EYEWEAR
- APPAREL / RIDER ACC.
- PROMOTIONAL
- REFERENCE
- INDEX



# 1" HANDLEBARS



**TRACKER BARS**

Description	Color	Tube Size	Height	Width	Pull Back	WPS #
<b>TRACKER BARS</b>						
Pre-'82	Black	1"	5"	30"	4.5"	<b>563-01714</b>
Dimpled '82-Up	Black	1"	5"	30"	4.5"	<b>563-01715</b>
Pre-'82	Chrome	1"	5"	30"	4.5"	<b>563-01716</b>
Dimpled '82-Up	Chrome	1"	5"	30"	4.5"	<b>563-01717</b>



**BOOTLEGGER BARS**

Description	Color	Tube Size	Height	Width	Pull Back	WPS #
<b>BOOTLEGGER BARS</b>						
Pre-'82	Black	1"	9.5"	25"	5"	<b>563-01710</b>
Dimpled '82-Up	Black	1"	9.5"	25"	5"	<b>563-01711</b>
Pre-'82	Chrome	1"	9.5"	25"	5"	<b>563-01712</b>
Dimpled '82-Up	Chrome	1"	9.5"	25"	5"	<b>563-01713</b>

- WINDSHIELDS / FAIRINGS
- AUDIO / COMMUNICATION
- SEATS / LUGGAGE
- BARS / MIRRORS / CONTROLS**
- EXHAUST
- AIR / FUEL SYSTEMS
- ENGINE
- TRANSMISSION / DRIVELINE
- GASKETS / SEALS
- ELECTRICAL
- LIGHTING
- CABLES
- BRAKES
- OIL FILTERS
- SUSPENSION
- BODY
- WHEELS
- TIRES / TIRE ACC.
- BIKE ACC.
- VICTORY / INDIAN
- COVERS / LOCKS / TIEDOWNS
- CHEMICALS
- TOOLS
- HELMETS
- HELMET ACC.
- EYEWEAR
- APPAREL / RIDER ACC.
- PROMOTIONAL
- REFERENCE
- INDEX



- WINDSHIELDS / FAIRINGS
- AUDIO / COMMUNICATION
- SEATS / LUGGAGE
- BARS / MIRRORS / CONTROLS**
- EXHAUST
- AIR / FUEL SYSTEMS
- ENGINE
- TRANSMISSION / DRIVELINE
- GASKETS / SEALS
- ELECTRICAL
- LIGHTING
- CABLES
- BRAKES
- OIL FILTERS
- SUSPENSION
- BODY
- WHEELS
- TIRES / TIRE ACC.
- BIKE ACC.
- VICTORY / INDIAN
- COVERS / LOCKS / TIEDOWNS
- CHEMICALS
- TOOLS
- HELMETS
- HELMET ACC.
- EYEWEAR
- APPAREL / RIDER ACC.
- PROMOTIONAL
- REFERENCE
- INDEX

## GIMP HANGERS

Get the Gimps! Nash Motorcycle Company features Gimp Hanger Handlebars. These bars are perfect for squaring up your front end and giving your bike a unique look. Made from one inch steel tubing, NMC reinforces the corners for extra added strength. Drilled, dimpled and knurled.. Made in the USA.

Description	Color	Tube Size	Height	Width	Pull Back	WPS #
<b>GIMP HANGERS</b>						
Dimpled '82-Up	Black	1"	12"	33"	5"	<b>811-30000</b>
	Chrome	1"	12"	33"	5"	<b>811-30001</b>
	Black	1"	14"	33"	5"	<b>811-30002</b>
	Chrome	1"	14"	33"	5"	<b>811-30003</b>
	Black	1"	16"	33"	5"	<b>811-30004</b>
	Chrome	1"	16"	33"	5"	<b>811-30005</b>



## MIDGET GIMP HANGERS

Smaller version of the Gimp Hangers, available in 12", 14" and 16" heights, in chrome or black finish. Midget Gimps featuring a 9.5" base for narrow glide front ends. Dimpled, drilled and knurled. Made in the USA.

Description	Color	Tube Size	Height	Width	Pull Back	WPS #
<b>MIDGET GIMPS</b>						
Dimpled '82-Up	Black	1"	12"	31"	5"	<b>811-30006</b>
	Chrome	1"	12"	31"	5"	<b>811-30007</b>
	Black	1"	14"	31"	5"	<b>811-30008</b>
	Chrome	1"	14"	31"	5"	<b>811-30009</b>
	Black	1"	16"	31"	5"	<b>811-30010</b>
	Chrome	1"	16"	31"	5"	<b>811-30011</b>



## PUDGY GIMP HANGERS

Get the Pudge! It's sad to say but too many nights with cookies and milk and the Gimp has gained some weight. Nash Motorcycle Co. is now featuring their 1 1/4" Gimp Hangers.

Description	Color	Tube Size	Height	Width	Pull Back	WPS #
<b>PUDGY GIMPS</b>						
Dimpled '82-Up	Black	1"	12"	35"	5"	<b>811-30026</b>
	Chrome	1"	12"	35"	5"	<b>811-30027</b>
	Black	1"	14"	35"	5"	<b>811-30028</b>
	Chrome	1"	14"	35"	5"	<b>811-30029</b>
	Black	1"	16"	35"	5"	<b>811-30030</b>
	Chrome	1"	16"	35"	5"	<b>811-30031</b>

## SMART GIMPS

No one knew the Gimps would eventually grow rounded corners! Check out the Smart Gimps, the newly designed Gimp Hanger, with a new flare to them. These gimps go off the same shape and feel you get with the traditional gimp hangers but they have rounded corners like an original ape hanger.



Description	Color	Tube Size	Height	Width	Pull Back	WPS #
<b>SMART GIMPS</b>						
Dimpled '82-Up	Black	1"	14"	33"	5"	<b>811-30022</b>
	Chrome	1"	14"	33"	5"	<b>811-30023</b>
Non-Dimpled Pre-'82	Black	1"	16"	33"	5"	<b>811-30024</b>
	Chrome	1"	16"	33"	5"	<b>811-30025</b>
Non-Dimpled Pre-'82	Black	1"	14"	33"	5"	<b>811-30042</b>
	Chrome	1"	14"	33"	5"	<b>811-30043</b>
	Black	1"	16"	33"	5"	<b>811-30044</b>
	Chrome	1"	16"	33"	5"	<b>811-30045</b>

## CIGAR RACER BARS

Race style handlebars brought to you by Nash Motorcycle Company. Featuring a unique BMX race style look along with a center crossbar, which provides excellent strength and support.



Description	Color	Tube Size	Height	Width	Pull Back	WPS #
<b>CIGAR RACER BARS</b>						
Dimpled '82-Up	Black	1"	8"	30"	5"	<b>811-30018</b>
	Chrome	1"	8"	30"	5"	<b>811-30019</b>
Non-Dimpled Pre-'82	Black	1"	8"	30"	5"	<b>811-30038</b>
	Chrome	1"	8"	30"	5"	<b>811-30039</b>

## MIDGET CIGAR RACER BARS

Same style as the famous Cigar Racers these midgets are ideal for narrow front-end bikes and Sportsters.



Description	Color	Tube Size	Height	Width	Pull Back	WPS #
<b>MIDGET CIGAR RACER BARS</b>						
Dimpled '82-Up	Black	1"	8"	30"	5"	<b>811-30020</b>
	Chrome	1"	8"	30"	5"	<b>811-30021</b>
Non-Dimpled Pre-'82	Black	1"	8"	30"	5"	<b>811-30040</b>
	Chrome	1"	8"	30"	5"	<b>811-30041</b>

## PUNCHY BARS

The smaller version of our looky bars but don't get it twisted these bars come with a great punch. With the added crossbar and low stance these bars are sure to get people head turning at your bike.



Description	Color	Tube Size	Height	Width	Pull Back	WPS #
<b>PUNCHY BARS</b>						
Dimpled '82-Up	Black	1"	6.5"	29"	2"	<b>811-30014</b>
	Chrome	1"	6.5"	29"	2"	<b>811-30015</b>
Non-Dimpled Pre-'82	Black	1"	6.5"	29"	2"	<b>811-30034</b>
	Chrome	1"	6.5"	29"	2"	<b>811-30035</b>

- WINDSHIELDS / FAIRINGS
- AUDIO / COMMUNICATION
- SEATS / LUGGAGE
- BARS / MIRRORS / CONTROLS
- EXHAUST
- AIR / FUEL SYSTEMS
- ENGINE
- TRANSMISSION / DRIVELINE
- GASKETS / SEALS
- ELECTRICAL
- LIGHTING
- CABLES
- BRAKES
- OIL FILTERS
- SUSPENSION
- BODY
- WHEELS
- TIRES / TIRE ACC.
- BIKE ACC.
- VICTORY / INDIAN
- COVERS / LOCKS / TIEDOWNS
- CHEMICALS
- TOOLS
- HELMETS
- HELMET ACC.
- EYEWEAR
- APPAREL / RIDER ACC.
- PROMOTIONAL
- REFERENCE
- INDEX



## EL GRINGO BARS

Designed after the El Gringo bike, these one of a kind bars feature a welded cross bar and unique corners. These bars are sure to give your bike that one of a kind look you want.



Description	Color	Tube Size	Height	Width	Pull Back	WPS #
<b>EL GRINGO BARS</b>						
Dimpled '82-Up	Black	1"	4"	29"	5"	<b>811-30016</b>
	Chrome	1"	4"	29"	5"	<b>811-30017</b>
Non-Dimpled Pre-'82	Black	1"	4"	29"	5"	<b>811-30036</b>
	Chrome	1"	4"	29"	5"	<b>811-30037</b>

## DRAG BARS

Racer style Drag Bars with the look of our Gimp Hangers. These are TIG welded and made in the USA by Nash Motorcycle Company. Made from one inch steel tubing in black or chrome finish.



Description	Color	Tube Size	Height	Width	Pull Back	WPS #
<b>DRAG BARS</b>						
Dimpled '82-Up	Black	1"	4.5"	32"	2"	<b>811-30012</b>
	Chrome	1"	4.5"	32"	2"	<b>811-30013</b>
Non-Dimpled Pre-'82	Black	1"	4.5"	32"	2"	<b>811-30032</b>
	Chrome	1"	4.5"	32"	2"	<b>811-30033</b>

## INTERNAL THROTTLE

Fully machined out of mild steel and covered with a black oxide coating to prevent rusting. Both bearings inside the throttle are stainless steel. Three features of our sticky throttle make it a cut above the rest, # 1 being the fact that it's made by Nash Motorcycle Company right here in the good Ol' USA. # 2 being the fact that there is no other throttle on the market that you can actually have cruise control with. This internal throttle can also be run without the cruise control option, by removing the nylon insert. # 3 ease of installation. Our throttle can be installed by anyone that has a saw and a couple Allen wrenches. Please read installation instructions for more details on how to install. The cable offered has a 83" overall length and 69" housing length for anything from drag bars to gimp hangers.



Description	WPS #
Internal Throttle Right	<b>811-30110</b>
Internal Throttle Left	<b>811-30111</b>



# REAPER APE HANGERS



- Combine comfort with attitude
- Drilled for internal wiring
- Made with double wall construction

- Manufactured to make sure the inside corners are smooth so the electrical doesn't get hung up during installation
- Available in show Chrome or Satin black powder coat



Model	Color	Tube Size	Height	Width	Pull Back	Center Width	WPS#
<b>APE HANGER</b>							
Reaper 10" Ape Hanger	Chrome	1.25"	10"	34"	8.5"	9.5"	<b>830-0580</b>
Reaper 10" Ape Hanger	Black	1.25"	10"	34"	8.5"	9.5"	<b>830-0580B</b>
Reaper 12" Ape Hanger	Chrome	1.25"	12"	34.5"	8.5"	9.5"	<b>830-0582</b>
Reaper 12" Ape Hanger	Black	1.25"	12"	34.5"	8.5"	9.5"	<b>830-0582B</b>
Reaper 14" Ape Hanger	Chrome	1.25"	14"	35"	8.5"	9.5"	<b>830-0584</b>
Reaper 14" Ape Hanger	Black	1.25"	14"	35"	8.5"	9.5"	<b>830-0584B</b>
Reaper 16" Ape Hanger	Chrome	1.25"	16"	35.5"	8.5"	9.5"	<b>830-0586</b>
Reaper 16" Ape Hanger	Black	1.25"	16"	35.5"	8.5"	9.5"	<b>830-0586B</b>



Model	Color	Tube Size	Height	Width	Pull Back	Center Width	WPS#
<b>BAGGER APE HANGER</b>							
Reaper 10" Bagger Ape Hanger	Chrome	1.25"	10"	36"	10"	14"	<b>830-0590</b>
Reaper 10" Bagger Ape Hanger	Black	1.25"	10"	36"	10"	14"	<b>830-0590B</b>
Reaper 12" Bagger Ape Hanger	Chrome	1.25"	12"	36"	10"	14"	<b>830-0592</b>
Reaper 12" Bagger Ape Hanger	Black	1.25"	12"	36"	10"	14"	<b>830-0592B</b>
Reaper 14" Bagger Ape Hanger	Chrome	1.25"	14"	36"	10"	14"	<b>830-0594</b>
Reaper 14" Bagger Ape Hanger	Black	1.25"	14"	36"	10"	14"	<b>830-0594B</b>
Reaper 16" Bagger Ape Hanger	Chrome	1.25"	16"	36"	10"	14"	<b>830-0596</b>
Reaper 16" Bagger Ape Hanger	Black	1.25"	16"	36"	10"	14"	<b>830-0596B</b>



Model	Color	Tube Size	Height	Width	Pull Back	Center Width	WPS#
<b>FLATLINE BAR</b>							
Flatline 10" Bar	Chrome	1.25"	10"	24"			<b>830-0566</b>
Flatline 10" Bar	Black	1.25"	10"	24"			<b>830-0566B</b>
Flatline 12" Bar	Chrome	1.25"	12"	24"			<b>830-0567</b>
Flatline 12" Bar	Black	1.25"	12"	24"			<b>830-0567B</b>

- WINDSHIELDS / FAIRINGS
- AUDIO / COMMUNICATION
- SEATS / LUGGAGE
- BARS / MIRRORS / CONTROLS**
- EXHAUST
- AIR / FUEL SYSTEMS
- ENGINE
- TRANSMISSION / DRIVELINE
- GASKETS / SEALS
- ELECTRICAL
- LIGHTING
- CABLES
- BRAKES
- OIL FILTERS
- SUSPENSION
- BODY
- WHEELS
- TIRES / TIRE ACC.
- BIKE ACC.
- VICTORY / INDIAN
- COVERS / LOCKS / TIEDOWNS
- CHEMICALS
- TOOLS
- HELMETS
- HELMET ACC.
- EYEWEAR
- APPAREL / RIDER ACC.
- PROMOTIONAL
- REFERENCE
- INDEX



## CHUBBY® BARS

- All Wild 1 Inc. products are made in the USA
- Demand the best don't settle for less!
- Awesome 1-¼" thick, show chrome plated, pre-drilled for internal wiring, polished welds & diamond knurled
- Work with stock risers, top clamp, controls & grips
- Superior construction, unequalled quality

### BAGGER BARS



Description	Color	Tube Size	Height	Width	Pull Back	Center Width	WPS #
<b>BAGGER BARS</b>							
Chubby Bagger Bar (42 Degree Wrist Angle)	Chrome	1.25"	10"	34.5"	13"	12"	<b>830-0575</b>
Chubby Bagger Bar (42 Degree Wrist Angle)	Black	1.25"	10"	34.5"	13"	12"	<b>830-0575B</b>
Chubby 10" Bagger Ape Hanger	Chrome	1.25"	10"	36.5"	11"	12"	<b>830-0578</b>
Chubby 10" Bagger Ape Hanger	Black	1.25"	10"	36.5"	11"	12"	<b>830-0578B</b>
Chubby 12.5" Bagger Ape Hanger	Chrome	1.25"	12.5"	36.5"	11"	12"	<b>830-0577</b>
Chubby 12.5" Bagger Ape Hanger	Black	1.25"	12.5"	36.5"	11"	12"	<b>830-0577B</b>
Chubby 14" Bagger Ape Hanger	Chrome	1.25"	14"	36.5"	11"	12"	<b>830-0576</b>
Chubby 14" Bagger Ape Hanger	Black	1.25"	14"	36.5"	11"	12"	<b>830-0576B</b>

\*Will fit 2014 and 2015 FLHT and FLHX models

### APEHANGERS



Description	Color	Tube Size	Height	Width	Pull Back	Center Width	WPS #
<b>APEHANGERS</b>							
Chubby Baby Ape Hanger, 8.5"	Chrome	1.25"	8.5"	35"	11.5"	9"	<b>830-0513</b>
Chubby Baby Ape Hanger, 8.5"	Black	1.25"	8.5"	35"	11.5"	9"	<b>830-0513B</b>
Chubby Ape Hanger 10"	Chrome	1.25"	10"	36"	11.5"	9"	<b>830-0515</b>
Chubby Ape Hanger 10"	Black	1.25"	10"	36"	11.5"	9"	<b>830-0515B</b>
Chubby Ape Hanger, 12.5"	Chrome	1.25"	12.5"	36.5"	12"	9"	<b>830-0502</b>
Chubby Ape Hanger, 12.5"	Black	1.25"	12.5"	36.5"	12"	9"	<b>830-0502B</b>
Chubby Ape Hanger, 14.0"	Chrome	1.25"	14"	36.5"	12.5"	9"	<b>830-0572</b>
Chubby Ape Hanger, 14.0"	Black	1.25"	14"	36.5"	12.5"	9"	<b>830-0572B</b>
Chubby Ape Hanger, 16"	Chrome	1.25"	16"	37"	12.5"	9"	<b>830-0509</b>
Chubby Ape Hanger, 16"	Black	1.25"	16"	37"	12.5"	9"	<b>830-0509B</b>
Psycho Chubby Ape Hanger, 18"	Chrome	1.25"	18"	37"	12.5"	9"	<b>830-0570</b>
Psycho Chubby Ape Hanger, 18"	Black	1.25"	18"	37"	12.5"	9"	<b>830-0570B</b>
Psycho Chubby Ape Hanger, 20"	Chrome	1.25"	20"	37"	12.5"	9"	<b>830-0571</b>
Psycho Chubby Ape Hanger, 20"	Black	1.25"	20"	37"	12.5"	9"	<b>830-0571B</b>
Chubby Ape Hanger For Springer, 9.5"	Chrome	1.25"	9.5"	36.5"	11.5"		<b>830-0514</b>
Chubby Ape Hanger For Springer, 9.5"	Black	1.25"	9.5"	36.5"	11.5"		<b>830-0514B</b>
Chubby Ape Hanger For Springer, 12.5"	Chrome	1.25"	12.5"	38.5"	12"		<b>830-0516</b>
Chubby Ape Hanger For Springer, 12.5"	Black	1.25"	12.5"	38.5"	12"		<b>830-0516B</b>
Chubby Ape Hanger For Springer, 16.0"	Chrome	1.25"	16"	37"	12.5"		<b>830-0569</b>
Chubby Ape Hanger For Springer, 16.0"	Black	1.25"	16"	37"	12.5"		<b>830-0569B</b>



## LOW BAGGER BARS

- Fits '84-17 FLHT/C/U/K, FLHX and Trike
- Three inches more pullback than stock bar



Description	Color	Tube Size	Height	Width	Pull Back	WPS #
<b>LOW BAGGER BARS</b>						
Chubby Low Bagger Bar (35 Degree Wrist Angle)	Chrome	1.25"	9"	34"	13"	<b>830-0579</b>
Chubby Low Bagger Bar (35 Degree Wrist Angle)	Black	1.25"	9"	34"	13"	<b>830-0579B</b>



A

## SURE GRIP CLAMPS

Securely hold your ape hangers in place with the solid one piece top clamp, part number 830-0538 for pre-2008 touring models. Part number 830-0539 allows the use of all bars with a 1" clamping area on 2015 and later Road Glides.



B

Description	Application	WPS#
A Solid 1-Piece Top Clamp	Pre-2008 Touring Models	<b>830-0538</b>
B Clamping System	FLTR Models '15-Up	<b>830-0539</b>

- WINDSHIELDS / FAIRINGS
- AUDIO / COMMUNICATION
- SEATS / LUGGAGE
- BARS / MIRRORS / CONTROLS**
- EXHAUST
- AIR / FUEL SYSTEMS
- ENGINE
- TRANSMISSION / DRIVELINE
- GASKETS / SEALS
- ELECTRICAL
- LIGHTING
- CABLES
- BRAKES
- OIL FILTERS
- SUSPENSION
- BODY
- WHEELS
- TIRES / TIRE ACC.
- BIKE ACC.
- VICTORY / INDIAN
- COVERS / LOCKS / TIEDOWNS
- CHEMICALS
- TOOLS
- HELMETS
- HELMET ACC.
- EYEWEAR
- APPAREL / RIDER ACC.
- PROMOTIONAL
- REFERENCE
- INDEX



# CHUBBY® BARS



## OUTLAWZ APEHANGERS

Description	Color	Tube Size	Height	Width	Pull Back	Center Width	WPS #
<b>OUTLAWZ APEHANGERS</b>							
Chubby 10" Outlawz Ape Hanger	Chrome	1.25"	10"	33.5"	8"	9"	830-0610
Chubby 10" Outlawz Ape Hanger	Black	1.25"	10"	33.5"	8"	9"	830-0610B
Chubby 12" Outlawz Ape Hanger	Chrome	1.25"	12"	33.5"	8"	9"	830-0612
Chubby 12" Outlawz Ape Hanger	Black	1.25"	12"	33.5"	8"	9"	830-0612B
Chubby 14" Outlawz Ape Hanger	Chrome	1.25"	14"	33.5"	8"	9"	830-0614
Chubby 14" Outlawz Ape Hanger	Black	1.25"	14"	33.5"	8"	9"	830-0614B
Chubby 16" Outlawz Ape Hanger	Chrome	1.25"	16"	33.5"	8"	9"	830-0616
Chubby 16" Outlawz Ape Hanger	Black	1.25"	16"	33.5"	8"	9"	830-0616B
Chubby Springer 10" Outlawz Ape Hanger	Chrome	1.25"	10"	33.5"	8"		830-0620
Chubby Springer 10" Outlawz Ape Hanger	Black	1.25"	10"	33.5"	8"		830-0620B
Chubby Springer 12" Outlawz Ape Hanger	Chrome	1.25"	12"	33.5"	8"		830-0622
Chubby Springer 12" Outlawz Ape Hanger	Black	1.25"	12"	33.5"	8"		830-0622B
Chubby Springer 14" Outlawz Ape Hanger	Chrome	1.25"	14"	33.5"	8"		830-0624
Chubby Springer 14" Outlawz Ape Hanger	Black	1.25"	14"	33.5"	8"		830-0624B

## DRAG BARS



Description	Color	Tube Size	Height	Width	Pull Back	Center Width	WPS #
<b>DRAG BARS</b>							
Psycho Chubby Drag Bar, 8.0" Straight Risers	Chrome	1.25"	8"	30.5"	7"		830-0562
Psycho Chubby Drag Bar, 8.0" Straight Risers	Black	1.25"	8"	30.5"	7"		830-0562B
Psycho Chubby Drag Bar, 10.0" Straight Risers	Chrome	1.25"	10"	30.5"	8"		830-0563
Psycho Chubby Drag Bar, 10.0" Straight Risers	Black	1.25"	10"	30.5"	8"		830-0563B
Psycho Chubby Drag Bar, 12.0" Straight Risers	Chrome	1.25"	12"	30.5"	9"		830-0564
Psycho Chubby Drag Bar, 12.0" Straight Risers	Black	1.25"	12"	30.5"	9"		830-0564B

## PULLBACK DRAG BARS

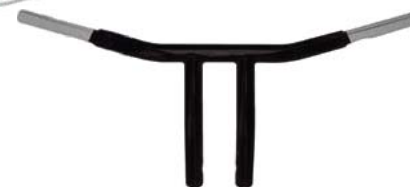

Description	Color	Tube Size	Height	Width	Pull Back	Center Width	WPS #
<b>PULLBACK DRAG BARS</b>							
Chubby Low Profile Drag Bar	Chrome	1.25"	4"	30.5"	14.5"		830-0560
Chubby Low Profile Drag Bar	Black	1.25"	4"	30.5"	14.5"		830-0560B
Chubby Drag Bar, 6" Built In Pull Back Risers	Chrome	1.25"	8"	30.5"	10.5"		830-0500
Chubby Drag Bar, 6" Built In Pull Back Risers	Black	1.25"	8"	30.5"	10.5"		830-0500B
Chubby Drag Bar, 8" Built In Pull Back Risers	Chrome	1.25"	10"	30.5"	11.5"		830-0501
Chubby Drag Bar, 8" Built In Pull Back Risers	Black	1.25"	10"	30.5"	11.5"		830-0501B
Chubby Drag Bars, 10" Built In Pull Back Risers	Chrome	1.25"	12"	30.5"	12.5"		830-0507
Chubby Drag Bars, 10" Built In Pull Back Risers	Black	1.25"	12"	30.5"	12.5"		830-0507B
Chubby Springer Drag Bar, 6.0" Built In Risers	Chrome	1.25"	6"	30.5"	11"		830-0565

# CHUBBY® BARS



- WINDSHIELDS / FAIRINGS
- AUDIO / COMMUNICATION
- SEATS / LUGGAGE
- BARS / MIRRORS / CONTROLS**
- EXHAUST
- AIR / FUEL SYSTEMS
- ENGINE
- TRANSMISSION / DRIVELINE
- GASKETS / SEALS
- ELECTRICAL
- LIGHTING
- CABLES
- BRAKES
- OIL FILTERS
- SUSPENSION
- BODY
- WHEELS
- TIRES / TIRE ACC.
- BIKE ACC.
- VICTORY / INDIAN
- COVERS / LOCKS / TIEDOWNS
- CHEMICALS
- TOOLS
- HELMETS
- HELMET ACC.
- EYEWEAR
- APPAREL / RIDER ACC.
- PROMOTIONAL
- REFERENCE
- INDEX

## DRESSER BARS



Description	Color	Tube Size	Height	Width	Pull Back	Center Width	WPS #
<b>DRESSER BARS</b>							
Chubby Dresser Bar	Chrome	1.25"	0"	34.5"	12.5"		<b>830-0504</b>
Chubby Dresser Bar	Black	1.25"	0"	34.5"	12.5"		<b>830-0504B</b>
Chubby Dresser Bars For Springer	Chrome	1.25"	0"	34.5"	12.5"		<b>830-0510</b>
Chubby Dresser Bars For Springer	Black	1.25"	0"	34.5"	12.5"		<b>830-0510B</b>

## RK & RG BARS



Description	Color	Tube Size	Height	Width	Pull Back	Center Width	WPS #
<b>RK AND RG BARS</b>							
Chubby R.K. Bar	Chrome	1.25"	5.5"	32.5"	16"		<b>830-0508</b>
Chubby R.K. Bar	Black	1.25"	5.5"	32.5"	16"		<b>830-0508B</b>
Chubby R.K. li Bar	Chrome	1.25"	5.5"	35.5"	14.25"		<b>830-0518</b>
Chubby R.K. li Bar	Black	1.25"	5.5"	35.5"	14.25"		<b>830-0518B</b>
Chubby R.G. Bar	Chrome	1.25"	8.5"	31"	14.25"		<b>830-0517</b>
Chubby R.G. Bar	Black	1.25"	8.5"	31"	14.25"		<b>830-0517B</b>

## BEACH BARS



Description	Color	Tube Size	Height	Width	Pull Back	Center Width	WPS #
<b>BEACH BARS</b>							
Chubby Beach Bar	Chrome	1.25"	3.5"	36"	15"		<b>830-0550</b>
Chubby Beach Bar	Black	1.25"	3.5"	36"	15"		<b>830-0550B</b>
Chubby Springer Beach Bar	Chrome	1.25"	2.5"	36"	14.75"		<b>830-0551</b>
Chubby Springer Beach Bar	Black	1.25"	2.5"	36"	14.75"		<b>830-0551B</b>



## CHUBBY® BARS



### STREET FIGHTER BARS

Description	Color	Tube Size	Height	Width	Pull Back	Center Width	WPS #
<b>STREET FIGHTER BARS</b>							
Chubby Street Fighter Bar	Chrome	1.25"	3.5"	33"	8.5"		<b>830-0555</b>
Chubby Street Fighter Bar	Black	1.25"	3.5"	33"	8.5"		<b>830-0555B</b>
Chubby Psycho Street Fighter	Chrome	1.25"	10" total	31.5			<b>830-0556</b>
Chubby Psycho Street Fighter	Black	1.25"	10" total	31.5			<b>830-0556B</b>
Chubby Psycho Street Fighter	Chrome	1.25"	12" total	31.5			<b>830-0557</b>
Chubby Psycho Street Fighter	Black	1.25"	12" total	31.5			<b>830-0557B</b>
Chubby Psycho Street Fighter	Chrome	1.25"	14" total	31.5			<b>830-0558</b>
Chubby Psycho Street Fighter	Black	1.25"	14" total	31.5			<b>830-0558B</b>

### DRAGSTER BARS



Description	Color	Tube Size	Height	Width	Pull Back	Center Width	WPS #
<b>DRAGSTER BARS</b>							
Chubby Dragster Bar	Chrome	1.25"	0"	30.5"	6"		<b>830-0511</b>
Chubby Dragster Bar	Black	1.25"	0"	30.5"	6"		<b>830-0511B</b>
Chubby Dragster / Springer	Chrome	1.25"	0"	30.5"	6"		<b>830-0512</b>
Chubby Dragster / Springer	Black	1.25"	0"	30.5"	6"		<b>830-0512B</b>

### KNUCKLE BARS



Description	Color	Tube Size	Height	Width	Pull Back	Center Width	WPS #
<b>KNUCKLE BARS</b>							
Chubby Knuckle Bar	Chrome	1.25"	0"	35"	8.5"		<b>830-0503</b>
Chubby Knuckle Bar	Black	1.25"	0"	35"	8.5"		<b>830-0503B</b>
Chubby Springer Knuckle Bar	Chrome	1.25"	0"	36.5"	8.5"		<b>830-0519</b>
Chubby Springer Knuckle Bar	Black	1.25"	0"	36.5"	8.5"		<b>830-0519B</b>

# 1" STREET HANDLEBARS

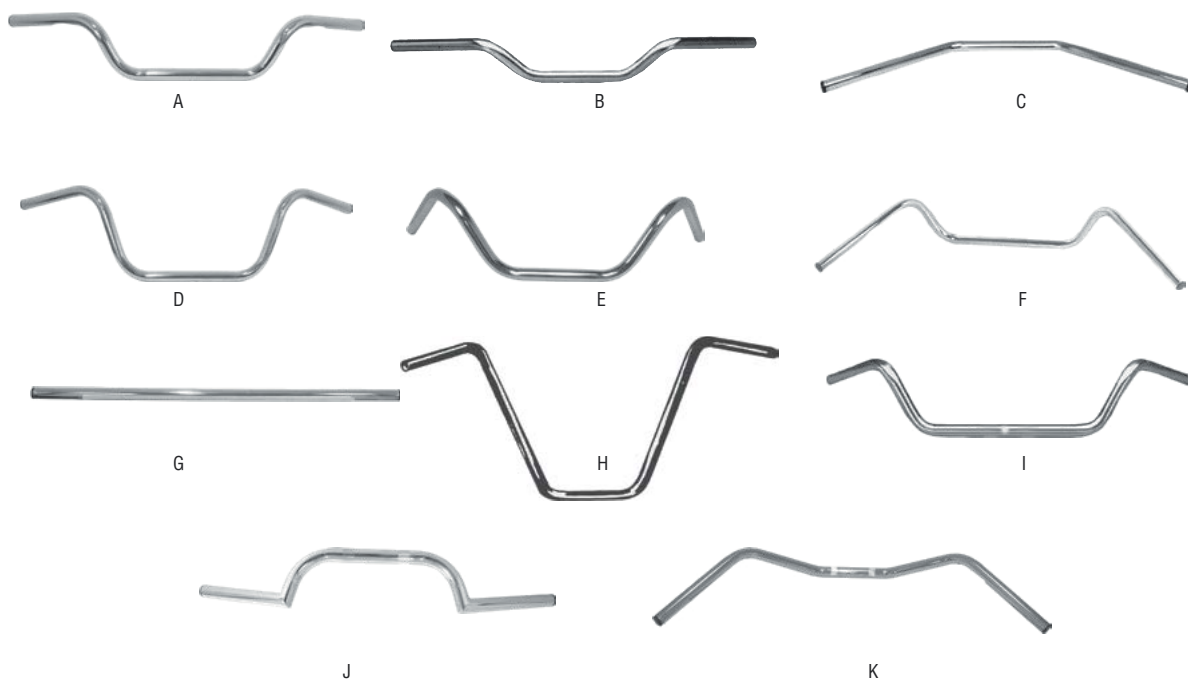

Description	Standard	Dimple (Harley)	Width	Rise	Pullback	Center Width
A Buckhorn						
Low Buckhorn	<b>56-9566C</b>	<b>56-9585C</b>	31"	5"	7"	8½"
Med. Buckhorn	<b>56-9567C</b>	<b>56-9586C</b>	33"	7"	7½"	8½"
High Buckhorn	<b>56-9568C</b>	<b>56-9587C</b>	33"	10"	9"	8½"
B Superbike	<b>56-9569C</b>	<b>56-9588C</b>	29"	2"	5"	5½"
C Drag Bars						
Drag Bar Std.		<b>56-9589C</b>	28½"		5"	7½"
Drag Bar Narrow	<b>56-9570C</b>		24"		4¾"	7½"
Drag Bar Narrow		<b>56-9590C</b>	25¾"		4¼"	7½"
Drag Bar Wide	<b>56-9571C</b>	<b>56-9591C</b>	30"		5"	9"
D Hwy Bars						
Hwy Bar Low	<b>56-9574C</b>	<b>56-9594C</b>	34"	7½"	7"	9"
Hwy Bar Med	<b>56-9573C</b>	<b>56-9593C</b>	34½"	8½"	7½"	9"
Hwy Bar High	<b>56-9572C</b>	<b>56-9592C</b>	34½"	12¼"	8¼"	9"
E Sport Rise	<b>56-9575C</b>	<b>56-9595C</b>	30¼"	6½"	11½"	7"
F Wide Custom	<b>56-9576C</b>	<b>56-9596C</b>	36"	6¾"	12"	12½"
G Broomstick	<b>56-9577C</b>		32"			
H Ape Hangers						
12" rise	<b>56-9578C</b>		32"	12"	7½"	5½"
14" rise	<b>56-9579C</b>		32"	14"	7½"	5½"
16" rise	<b>56-9580C</b>		32"	16"	7½"	5½"
18" rise	<b>56-9581C</b>		32"	18"	7½"	5½"
I Beach Bars						
36" wide	<b>56-9582C</b>		36"	4¾"	15½"	9"
39" wide	<b>56-9583C</b>		39"	4¾"	15½"	9"
J Clubman						
Clubman Chrome	<b>56-9584C</b>		27½"	4½" drop		6"
Clubman Black	<b>56-9584BK</b>		27½"	4½" drop		6"
K Western						
Low Western		<b>56-9600C</b>	34"	4"	10"	7"
Med. Western		<b>56-9601C</b>	38"	4½"	10"	11"
High Western		<b>56-9602C</b>	33"	5½"	10"	12"

- WINDSHIELDS / FAIRINGS
- AUDIO / COMMUNICATION
- SEATS / LUGGAGE
- BARS / MIRRORS / CONTROLS**
- EXHAUST
- AIR / FUEL SYSTEMS
- ENGINE
- TRANSMISSION / DRIVELINE
- GASKETS / SEALS
- ELECTRICAL
- LIGHTING
- CABLES
- BRAKES
- OIL FILTERS
- SUSPENSION
- BODY
- WHEELS
- TIRES / TIRE ACC.
- BIKE ACC.
- VICTORY / INDIAN
- COVERS / LOCKS / TIEDOWNS
- CHEMICALS
- TOOLS
- HELMETS
- HELMET ACC.
- EYEWEAR
- APPAREL / RIDER ACC.
- PROMOTIONAL
- REFERENCE
- INDEX



R O O K E

## RISERS

- Distinct Rooke design riser top clamps
- Machined from 6061 aluminum
- Three finishes to choose from

- Narrow riser base fits well on narrow and mid-glide trees
- Wide base risers fit well on wide glide and mid-glide trees

- Available for 1" bars and 1 1/8" (moto style) bars
- Require riser bolts with 1/2"-13 coarse thread



825-02100



825-02101



825-02102



825-02106



825-02107



825-02108



825-02109



825-02110



825-02111

Description	Height	Raw	Black	Polished
<b>FOR 1" BARS</b>				
Narrow Base Risers	1.75"	<b>825-02100</b>	<b>825-02101</b>	<b>825-02102</b>
	8"	<b>825-02103</b>	<b>825-02104</b>	<b>825-02105</b>
Wide Base Risers	2.25"	<b>825-02106</b>	<b>825-02107</b>	<b>825-02108</b>
	8"	<b>825-02109</b>	<b>825-02110</b>	<b>825-02111</b>
<b>FOR 1 1/8" BARS</b>				
Narrow Base Risers	1.75"	<b>825-02112</b>	<b>825-02113</b>	<b>825-02114</b>
	8"	<b>825-02115</b>	<b>825-02116</b>	<b>825-02117</b>
Wide Base Risers	2.25"	<b>825-02118</b>	<b>825-02119</b>	<b>825-02120</b>
	8"	<b>825-02121</b>	<b>825-02122</b>	<b>825-02123</b>





**BRASS BALLS**  
CYCLES



**RISERS** **NEW**

- Keg Risers are the perfect risers for Springer front ends! Stepped risers add a classic look to your chop.
- Machined from 6061 T6 aircraft grade billet aluminum.

Description	Black	Natural
Keg Risers	826-01120	826-01121
Step Risers 2"	826-01123	826-01122



826-01125



826-01126



826-01127

**TOP CLAMPS** **NEW**

- The Carbon Inlay series uses real carbon fiber inlay. Due to properties of carbon fiber, the laser cut edge is perfectly imperfect. Each top clamp is unique and exquisite. These top clamps are machined from aircraft grade 6061 T6 billet aluminum.
- They are a direct replacement for your stock top clamp and sport a clean aggressive look. Fit '74-later XL, FX, FXR, FX Dyna® and FX Softail® models that have no gauges attached to the top clamp. For use with 1.0" diameter handlebars.
- Machined from aircraft grade 6061 T6 billet aluminum

Description	Natural	Black
Knurled	826-01124	826-01125
Carbon Fiber	826-01126	826-01127
Hammered Copper	826-01128	826-01129



**RISERS** **NEW**

- Available in Show Chrome or Gloss Black
- Machined Grooved Top Caps
- 1/2"-13 Mounting Bolts
- For 1" Handle Bars

Description	WPS #
2" Risers Black	820-1348B
2" Risers Chrome	820-1348C

WINDSHIELDS / FAIRINGS  
AUDIO / COMMUNICATION  
SEATS / LUGGAGE  
BARS / MIRRORS / CONTROLS  
EXHAUST  
AIR / FUEL SYSTEMS  
ENGINE  
TRANSMISSION / DRIVELINE  
GASKETS / SEALS  
ELECTRICAL  
LIGHTING  
CABLES  
BRAKES  
OIL FILTERS  
SUSPENSION  
BODY  
WHEELS  
TIRES / TIRE ACC.  
BIKE ACC.  
VICTORY / INDIAN  
COVERS / LOCKS / TIEDOWNS  
CHEMICALS  
TOOLS  
HELMETS  
HELMET ACC.  
EYEWEAR  
APPAREL / RIDER ACC.  
PROMOTIONAL  
REFERENCE  
INDEX

- WINDSHIELDS / FAIRINGS
- AUDIO / COMMUNICATION
- SEATS / LUGGAGE
- BARS / MIRRORS / CONTROLS**
- EXHAUST
- AIR / FUEL SYSTEMS
- ENGINE
- TRANSMISSION / DRIVELINE
- GASKETS / SEALS
- ELECTRICAL
- LIGHTING
- CABLES
- BRAKES
- OIL FILTERS
- SUSPENSION
- BODY
- WHEELS
- TIRES / TIRE ACC.
- BIKE ACC.
- VICTORY / INDIAN
- COVERS / LOCKS / TIEDOWNS
- CHEMICALS
- TOOLS
- HELMETS
- HELMET ACC.
- EYEWEAR
- APPAREL / RIDER ACC.
- PROMOTIONAL
- REFERENCE
- INDEX



## 1.25" HANDLEBAR RISERS

- Designed for handlebars with 1.25" clamping area (will not work with 1" clamping area)
- Billet aluminum chrome

- Sold in pairs
- Come with upper clamps and necessary hardware
- Require 1/2"-13 coarse riser bolts

	Description	WPS#
A	Fat Bar chrome 5" tall risers w/ separate top clamp	820-54521
	Fat Bar chrome 5" tall risers w/ 1 piece top clamp	820-54522
B	Infinity Risers 1.5" tall risers w/ separate top clamp	820-54520



## PIVOTING HANDLEBAR RISERS

Rox unique patented riser design allows you to pivot the riser in the original clamps and pivot the bar orientation in the top clamps of the riser. This provides an incredible amount of bar positions for you to find the right height and pull-back for your riding position and stature. Rox Risers are incredibly universal with their 2 piece design; clamped into virtually any 1" diameter clamps and then reclamping the bar directly above that, on its original clamping area.

- Machined from 6061-T6 billet aluminum, made for 1" diameter handlebars
- Available in chrome or anodized black
- Universal (2-piece) design attaches to nearly any bar or clamping area with a 1" diameter
- Chrome risers come standard with chrome bolt head buttons
- Re-routing of stock lines and cables or longer lines and cables may be necessary on certain bikes
- 2" center to center height, sold in pairs
- Made in the U.S.A.



Description	Black	Chrome
<b>1" STEM CLAMP, 1" HANDLEBAR</b>		
2" Rise	44-8460BK	44-8460C
3" Rise	44-8465BK	44-8465C
4" Rise	44-8464BK	44-8464C



## OLD STYLE RISERS

Add some vintage look to your ride with modern duraluminum material and precision manufacturing with these West Eagle Old Style risers. Available in two distinct styles in gloss black powder coat or polished finish.

Description	Tube Size	Height	Black	Polished
<b>OLD STYLE RISERS</b>				
A Pullback Style	1"	1"	750-01221	750-01222
B Straight	1"	2"	750-01223	750-01224





## GLIDE STYLE RISERS

Risers for Wide Glide And Paughco springer front ends fit 1" diameter handlebars, and use 1/2"-20 bolts or studs to mount.

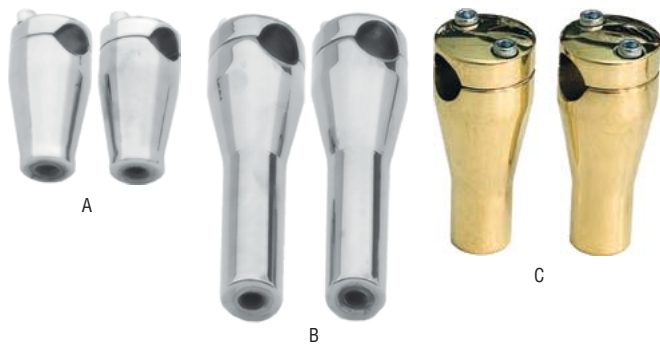

Description	Height	WPS #
A Glide Style Risers	3"	830-3310
B	6"	830-3311
C	4" Brass	830-3309



## POST STYLE RISERS

Post style risers available in triple chrome plated machined steel or solid brass. Sold in pairs.



Description	Height	WPS #
Post Style Risers	3"	830-3307
A	5"	830-3308
	3" Brass	830-3305
B	5" Brass	830-3306



## OFFSET POST RISERS

2" offset, mounted on rubber for maximum comfort. Made from top grade machined steel and triple chrome-plated. Solid brass version also available. Use 1/2"-20 bolts and studs to mount.

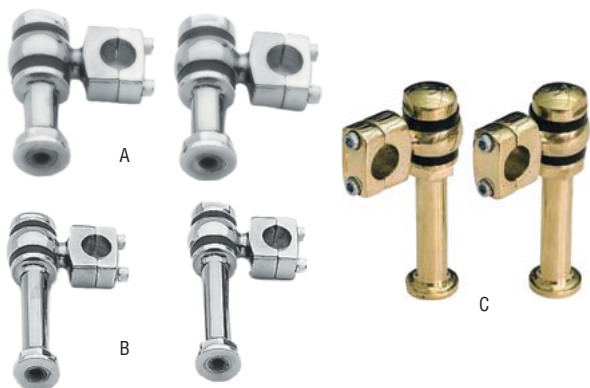

Description	Height	WPS #
A Offset Post Style Risers	3"	830-3300
B	5"	830-3301
	7"	830-3302
C	5" Brass	830-3303
	Repl. Rubbers (4)	830-3304



## RISER CROSSTUBE

A part from the famous 'Captain America' bike as seen in 'Easy Rider.' Use this 1"-diameter cross tube with all of our Dog Bone or Offset risers. Sold each.



Description	WPS#
Riser Cross Tube	830-3353



## RISER HARDWARE



Description	Length	WPS #
A Riser Bolts	1/2"-20 X 2"	830-3350
	1/2"-20 X 1-1/2"	830-3351
B Riser Studs	1/2"-20 X 1-1/2"	830-3352

- WINDSHIELDS / FAIRINGS
- AUDIO / COMMUNICATION
- SEATS / LUGGAGE
- BARS / MIRRORS / CONTROLS
- EXHAUST
- AIR / FUEL SYSTEMS
- ENGINE
- TRANSMISSION / DRIVELINE
- GASKETS / SEALS
- ELECTRICAL
- LIGHTING
- CABLES
- BRAKES
- OIL FILTERS
- SUSPENSION
- BODY
- WHEELS
- TIRES / TIRE ACC.
- BIKE ACC.
- VICTORY / INDIAN
- COVERS / LOCKS / TIEDOWNS
- CHEMICALS
- TOOLS
- HELMETS
- HELMET ACC.
- EYEWEAR
- APPAREL / RIDER ACC.
- PROMOTIONAL
- REFERENCE
- INDEX

- WINDSHIELDS / FAIRINGS
- AUDIO / COMMUNICATION
- SEATS / LUGGAGE
- BARS / MIRRORS / CONTROLS**
- EXHAUST
- AIR / FUEL SYSTEMS
- ENGINE
- TRANSMISSION / DRIVELINE
- GASKETS / SEALS
- ELECTRICAL
- LIGHTING
- CABLES
- BRAKES
- OIL FILTERS
- SUSPENSION
- BODY
- WHEELS
- TIRES / TIRE ACC.
- BIKE ACC.
- VICTORY / INDIAN
- COVERS / LOCKS / TIEDOWNS
- CHEMICALS
- TOOLS
- HELMETS
- HELMET ACC.
- EYEWEAR
- APPAREL / RIDER ACC.
- PROMOTIONAL
- REFERENCE
- INDEX



## SPRINGER RISERS

- These solid mount risers will grip your springer apes like no tomorrow. They are 2" tall and fit FXSTS, FLSTS & Crossbones
- They clamp to all 1" diameter bars or Wild 1 Chubby® bars that are 1" at clamping area and only fit HD OEM springer front ends



Description	Application	Chrome	Black
Stubby Chubby Springer risers	Only OEM Springers	830-0533	830-0533B



## SOLID RISER BUSHINGS

Solid riser bushing conversions eliminate flex in your handlebars often related to worn out rubber bushings. Made from stainless steel, 1/2"-13 x 1-3/4" riser bolts included. Will not fit Softail Deuce or Springer models.



Description	WPS#
Solid Riser Bushing Conversion	750-01225



## RISER BOLTS

- Sold in pairs with washers
- Polished chrome
- Made in the USA



Hex Coarse      Hex Fine      Allen Coarse      Allen Fine

Description	Hex Cap	Allen Head
1/2-13 X 2 1/2 Coarse Thread	830-1072	830-1078
1/2-20 X 2 1/2 Fine Thread	830-1073	830-1079
1/2-13 X 2 3/4 Coarse Thread	830-1074	830-1080
1/2-20 X 2 3/4 Fine Thread	830-1075	830-1081
1/2-13 X 3 Hex Coarse Thread	830-1076	830-1082
1/2-20 X 3 Hex Fine Thread	830-1077	830-1083

**FORGED HANDLEBAR RISERS**



Description	Tube Size	Height	Black	Chrome
<b>HANDLEBAR RISER WITH 1.125" O.D. STEM W/1/2" - 13 THREAD FOR MOUNTING BOLTS</b>				
A Pullback Style	1"	3.5"	<b>820-1341B</b>	<b>820-1341C</b>
B Pullback Style	1"	4.5"	<b>820-1342B</b>	<b>820-1342C</b>
Pullback Style	1"	5.5"	<b>820-1343B</b>	<b>820-1343C</b>
C Straight	1"	3.5"	<b>820-1345B</b>	<b>820-1345C</b>
D Straight	1"	4.5"	<b>820-1346B</b>	<b>820-1346C</b>
E Straight	1"	5.5"	<b>820-1347B</b>	<b>820-1347C</b>

**HANDLEBAR CLAMPS**



Description	Application	WPS#
A Chrome Finned Hbar Clamp w/skirt	'73-Up HD (except Springer Softail)	<b>820-1320C</b>
B Black Finned Hbar Clamp w/skirt	'73-Up HD (except Springer Softail)	<b>820-1320B</b>
C Chrome Finned Hbar Clamp w/out skirt	'73-Up HD (except Springer Softail)	<b>820-1321C</b>
D Black Finned Hbar Clamp w/out skirt	'73-Up HD (except Springer Softail)	<b>820-1321B</b>
E Chrome Plain Hbar Clamp w/skirt	'73-Up HD (except Springer Softail)	<b>820-1325C</b>
F Black Plain Hbar Clamp w/skirt	'73-Up HD (except Springer Softail)	<b>820-1325B</b>
G Chrome Plain Hbar Clamp w/out skirt	'73-Up HD (except Springer Softail)	<b>820-1326C</b>
H Black Plain Hbar Clamp w/out skirt	'73-Up HD (except Springer Softail)	<b>820-1326B</b>
I Replacement Chrome Allen bolts 5/16"-18 thread x 7/8" length	4PK	<b>820-1310</b>
J Chrome Plug cap (also fits any socket head screw w/.25" hexagon)	10PK	<b>820-1178C</b>
K Black Plug cap (also fits any socket head screw w/.25" hexagon)	10PK	<b>820-1179B</b>

WINDSHIELDS / FAIRINGS  
AUDIO / COMMUNICATION  
SEATS / LUGGAGE  
BARS / MIRRORS / CONTROLS  
EXHAUST  
AIR / FUEL SYSTEMS  
ENGINE  
TRANSMISSION / DRIVELINE  
GASKETS / SEALS  
ELECTRICAL  
LIGHTING  
CABLES  
BRAKES  
OIL FILTERS  
SUSPENSION  
BODY  
WHEELS  
TIRES / TIRE ACC.  
BIKE ACC.  
VICTORY / INDIAN  
COVERS / LOCKS / TIEDOWNS  
CHEMICALS  
TOOLS  
HELMETS  
HELMET ACC.  
EYEWEAR  
APPAREL / RIDER ACC.  
PROMOTIONAL  
REFERENCE  
INDEX



## TOP CLAMPS

- These top clamps complement Wild 1 Chubby bars like no other riser and clamp combo
- Made in the USA with top quality materials
- Hidden hardware version available for the cleanest look
- Available in black or chrome finish
- Fit most HD and aftermarket risers with offset bolt pattern



A



B



C



D



E



F



G



H

	Description	Application	Chrome	Black
A&B	Hidden hardware top clamp, smooth	Fits most HD's with offset bolt pattern	<b>830-0535</b>	<b>830-0535B</b>
C&D	Hidden hardware top clamp, ball milled	Fits most HD's with offset bolt pattern	<b>830-0536</b>	<b>830-0536B</b>
E&F	Smooth top clamp	Fits most HD's with offset bolt pattern	<b>830-0505</b>	<b>830-0505B</b>
G&H	Ball milled top clamp	Fits most HD's with offset bolt pattern	<b>830-0506</b>	<b>830-0506B</b>



## RISER BOLTS

- Sold in pairs with washers
- Polished chrome
- Made in the USA

Description	Hex Cap	Allen Head
1/2-13 X 2 1/2 Coarse Thread	<b>830-1072</b>	<b>830-1078</b>
1/2-20 X 2 1/2 Fine Thread	<b>830-1073</b>	<b>830-1079</b>
1/2-13 X 2 3/4 Coarse Thread	<b>830-1074</b>	<b>830-1080</b>
1/2-20 X 2 3/4 Fine Thread	<b>830-1075</b>	<b>830-1081</b>
1/2-13 X 3 Hex Coarse Thread	<b>830-1076</b>	<b>830-1082</b>
1/2-20 X 3 Hex Fine Thread	<b>830-1077</b>	<b>830-1083</b>



Hex Coarse



Hex Fine



Allen Coarse



Allen Fine



## RISER EXTENSIONS

- CNC machined billet aluminum
- Available in chrome or black powdercoat finish
- Smooth or Vertical Mill design
- Requires the use of longer riser bolts (not included)



Description	Black Smooth	Chrome Smooth	Black Milled	Chrome Milled
<b>FOR 1" BARS</b>				
1" Extension	850-05106	850-05100	850-05118	850-05112
1-1/2" Extension	850-05107	850-05101	850-05119	850-05113
<b>FOR 1-1/4" BARS</b>				
1" Extension	850-05108	850-05102	850-05120	850-05114
1-1/2" Extension	850-05109	850-05103	850-05121	850-05115
<b>FOR 1-1/2" BARS</b>				
1" Extension	850-05110	850-05104	850-05122	850-05116
1-1/2" Extension	850-05111	850-05105	850-05123	850-05117



## DEUCE RISER ADAPTERS

- Use when removing stock Deuce risers and replacing with aftermarket.

Description	WPS#
Deuce handlebar adapter kit, chrome	830-0805



## 1.25" RISER ADAPTERS

- Use for models with factory 1 1/4" bars and risers when changing to aftermarket 1 1/4" bars like Wild 1 Chubby bars.

Description	WPS#
1 1/4" Riser adapter	830-0806



## HANDLEBAR ADAPTERS

For use with most aftermarket 1-1/4" handlebars with a clamping area that's 1" diameter, when installing on models with 1-1/4" risers with individual top clamps.

Description	WPS#
Handlebar Adapters (Two Sets Required Per Bar)	750-01214

- WINDSHIELDS / FAIRINGS
- AUDIO / COMMUNICATION
- SEATS / LUGGAGE
- BARS / MIRRORS / CONTROLS**
- EXHAUST
- AIR / FUEL SYSTEMS
- ENGINE
- TRANSMISSION / DRIVELINE
- GASKETS / SEALS
- ELECTRICAL
- LIGHTING
- CABLES
- BRAKES
- OIL FILTERS
- SUSPENSION
- BODY
- WHEELS
- TIRES / TIRE ACC.
- BIKE ACC.
- VICTORY / INDIAN
- COVERS / LOCKS / TIEDOWNS
- CHEMICALS
- TOOLS
- HELMETS
- HELMET ACC.
- EYEWEAR
- APPAREL / RIDER ACC.
- PROMOTIONAL
- REFERENCE
- INDEX

WINDSHIELDS / FAIRINGS  
 AUDIO / COMMUNICATION  
 SEATS / LUGGAGE  
**BARS / MIRRORS / CONTROLS**  
 EXHAUST  
 AIR / FUEL SYSTEMS  
 ENGINE  
 TRANSMISSION / DRIVELINE  
 GASKETS / SEALS  
 ELECTRICAL  
 LIGHTING  
 CABLES  
 BRAKES  
 OIL FILTERS  
 SUSPENSION  
 BODY  
 WHEELS  
 TIRES / TIRE ACC.  
 BIKE ACC.  
 VICTORY / INDIAN  
 COVERS / LOCKS / TIEDOWNS  
 CHEMICALS  
 TOOLS  
 HELMETS  
 HELMET ACC.  
 EYEWEAR  
 APPAREL / RIDER ACC.  
 PROMOTIONAL  
 REFERENCE  
 INDEX



## RISER BUSHINGS

- Designed specifically for tall bars to reduce handlebar movement
- Complete kits with sleeves bushings and washers



Description	WPS#
Firm bushings for Softail, Dyna, Sporty	<b>830-0802</b>
Firm bushings for Touring models	<b>830-0803</b>

## ENERGY SUSPENSION

### RISER BUSHINGS



- Manufactured with proprietary Hyer-Flex™ Polyurethane
- Out Performs and outlast OEM Rubber
- Comes in Stiff or Stock Soft
- Resists Oils and Chemicals
- Chrome or Zinc washers
- With or without sleeves



Application	Description	WPS#
A	Fit all Softails, Dynas and Sportsters '87-Up Firm	<b>770-4001</b>
	Stock	<b>770-4002</b>
B	Firm w/Out Insert	<b>770-4003</b>
	Stock w/Out Insert	<b>770-4004</b>
	Fit Touring Models '87-Up Firm w/Zinc Washers	<b>770-4005</b>
	Firm w/Chrome Washers	<b>770-4006</b>



## HANDLEBAR DAMPER KITS

Application	OEM#	WPS#
<b>HANDLEBAR DAMPER KIT W/RUBBER BUSHING &amp; STEEL SPACER</b>		
A '73-Up most HD models (except '84-Up FLT)	56157-85T	<b>820-1301</b>
<b>POLYURETHANE HANDLEBAR DAMPER KIT W/CHROME CAP WASHERS &amp; STEEL SLEEVES</b>		
B '73-Up most HD models (except '84-Up FLT)	56157-85T	<b>820-1302</b>



A



B

## HANDLEBAR WIRING RETAINERS

Description	WPS#
A 3/8" I.D. hole	<b>820-1175</b> 10/PK
B 1/2" I.D. hole	<b>820-1176</b> 10/PK

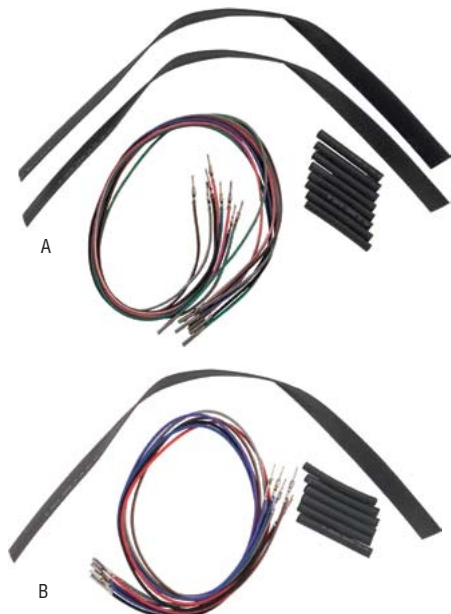

A

B

## 20" HANDLEBAR WIRING EXTENSION KITS

Application	Year	Wires	WPS#
A Touring models with factory radio	'96-06	8	<b>820-1350</b> *
B Touring models with "Throttle by Wire"	'09-13	6	<b>820-1351</b> †
Models w/Cruise control	'96-06	15	<b>820-1352</b>
Models without Cruise control	'96-06	12	<b>820-1355</b>
Models w/Cruise control (except can-bus models)	'07-13	17	<b>820-1353</b>
Models without cruise control and radio (except can-bus models)	'07-13	14	<b>820-1354</b>

\*Requires purchase of 820-1352 or 820-1355 depending on model  
 †Requires purchase of 820-1353 or 820-1354 depending on model

- WINDSHIELDS / FAIRINGS
- AUDIO / COMMUNICATION
- SEATS / LUGGAGE
- BARS / MIRRORS / CONTROLS
- EXHAUST
- AIR / FUEL SYSTEMS
- ENGINE
- TRANSMISSION / DRIVELINE
- GASKETS / SEALS
- ELECTRICAL
- LIGHTING
- CABLES
- BRAKES
- OIL FILTERS
- SUSPENSION
- BODY
- WHEELS
- TIRES / TIRE ACC.
- BIKE ACC.
- VICTORY / INDIAN
- COVERS / LOCKS / TIEDOWNS
- CHEMICALS
- TOOLS
- HELMETS
- HELMET ACC.
- EYEWEAR
- APPAREL / RIDER ACC.
- PROMOTIONAL
- REFERENCE
- INDEX

- WINDSHIELDS / FAIRINGS
- AUDIO / COMMUNICATION
- SEATS / LUGGAGE
- BARS / MIRRORS / CONTROLS**
- EXHAUST
- AIR / FUEL SYSTEMS
- ENGINE
- TRANSMISSION / DRIVELINE
- GASKETS / SEALS
- ELECTRICAL
- LIGHTING
- CABLES
- BRAKES
- OIL FILTERS
- SUSPENSION
- BODY
- WHEELS
- TIRES / TIRE ACC.
- BIKE ACC.
- VICTORY / INDIAN
- COVERS / LOCKS / TIEDOWNS
- CHEMICALS
- TOOLS
- HELMETS
- HELMET ACC.
- EYEWEAR
- APPAREL / RIDER ACC.
- PROMOTIONAL
- REFERENCE
- INDEX



## WIRING EXTENSIONS

- Factory color coded wire with OE style pins
- Instructions and heat shrink tubing included
- Made in USA

**NOTE:** Radio, CB and TBW extension kits must be ordered in addition to the standard wiring kits

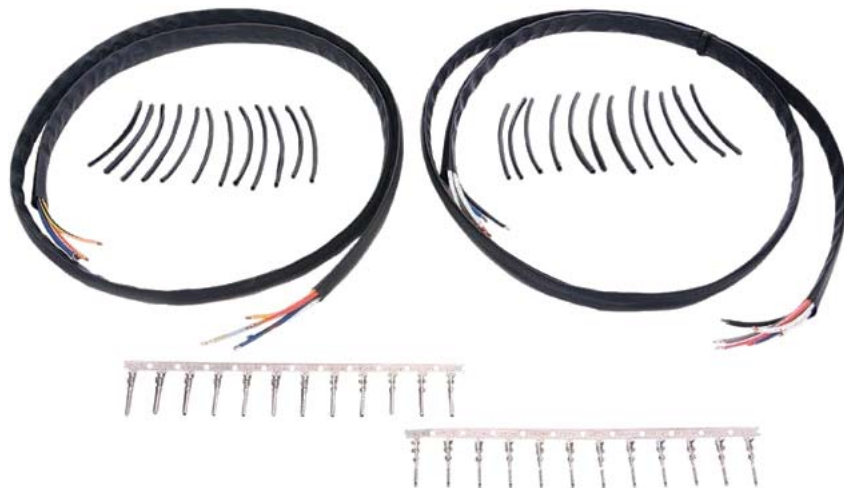

Description	WPS#
<b>ALL MODELS '96-06 W/O CRUISE CONTROL</b>	
4" Extension Kit	850-05200
8" Extension Kit	850-05201
12" Extension Kit	850-05202
15" Extension Kit	850-05203
18" Extension Kit	850-05204
20" Extension Kit	850-05205
24" Extension Kit	850-05206
<b>ALL MODELS '96-06 WITH CRUISE CONTROL</b>	
4" Extension Kit	850-05207
8" Extension Kit	850-05208
12" Extension Kit	850-05209
15" Extension Kit	850-05210
18" Extension Kit	850-05211
20" Extension Kit	850-05212
24" Extension Kit	850-05213
<b>ALL MODELS '07-13 W/O CRUISE CONTROL</b>	
4" Extension Kit	850-05214
8" Extension Kit	850-05215
12" Extension Kit	850-05216
15" Extension Kit	850-05217
18" Extension Kit	850-05218
20" Extension Kit	850-05219
24" Extension Kit	850-05220
<b>ALL MODELS '07-13 WITH CRUISE CONTROL</b>	
4" Extension Kit	850-05256
8" Extension Kit	850-05257
12" Extension Kit	850-05258
15" Extension Kit	850-05259
18" Extension Kit	850-05260
20" Extension Kit	850-05261
24" Extension Kit	850-05262
<b>RADIO EXTENSION KIT FOR FLH/FLT MODELS '96-06</b>	
4" Extension Kit	850-05221
8" Extension Kit	850-05222
12" Extension Kit	850-05223
15" Extension Kit	850-05224
18" Extension Kit	850-05225
20" Extension Kit	850-05226
24" Extension Kit	850-05227

Description	WPS#
<b>RADIO/CB EXTENSION KIT FOR FLH/FLT MODELS '96-06</b>	
4" Extension Kit	850-05228
8" Extension Kit	850-05229
12" Extension Kit	850-05230
15" Extension Kit	850-05231
18" Extension Kit	850-05232
20" Extension Kit	850-05233
24" Extension Kit	850-05234
<b>RADIO/CB EXTENSION KIT FOR FLH/FLT MODELS '07-13</b>	
4" Extension Kit	850-05235
8" Extension Kit	850-05236
12" Extension Kit	850-05237
15" Extension Kit	850-05238
18" Extension Kit	850-05239
20" Extension Kit	850-05240
24" Extension Kit	850-05241
<b>MODELS W/HANDLEBAR MOUNTED TURN SIGNALS '97-13</b>	
4" Extension Kit	850-05242
8" Extension Kit	850-05243
12" Extension Kit	850-05244
15" Extension Kit	850-05245
18" Extension Kit	850-05246
20" Extension Kit	850-05247
24" Extension Kit	850-05248
<b>THROTTLE BY WIRE MODELS '08-16</b>	
4" Extension Kit	850-05249
8" Extension Kit	850-05250
12" Extension Kit	850-05251
15" Extension Kit	850-05252
18" Extension Kit	850-05253
20" Extension Kit	850-05254
24" Extension Kit	850-05255
<b>CAN BUS MODELS '12-17 DYNA AND '11-17 SOFTAIL, TOURING '14-17</b>	
4" Extension Kit	850-05263
8" Extension Kit	850-05264
12" Extension Kit	850-05265
15" Extension Kit	850-05266
18" Extension Kit	850-05267
20" Extension Kit	850-05268
24" Extension Kit	850-05269

**CUSTOM DIE CAST MIRRORS**



These stylish die cast mirrors are small enough to look cool but big enough to see what's coming up behind you! Available in chrome or satin black finish. Sold in pairs.



Description	Chrome	Black
Round Mirrors	<b>820-56000</b>	<b>820-56001</b>
Rectangular Mirrors	<b>820-56002</b>	<b>820-56003</b>
Vintage Style Mirrors	<b>820-56004</b>	<b>820-56005</b>
Tapered Mirrors	<b>820-56006</b>	<b>820-56007</b>

Description	Chrome	Black
Elliptical Mirrors	<b>820-56008</b>	<b>820-56009</b>
Oval Mirrors	<b>820-56010</b>	<b>820-56011</b>
Arrow Head Mirrors	<b>820-56012</b>	<b>820-56013</b>

- WINDSHIELDS / FAIRINGS
- AUDIO / COMMUNICATION
- SEATS / LUGGAGE
- BARS / MIRRORS / CONTROLS**
- EXHAUST
- AIR / FUEL SYSTEMS
- ENGINE
- TRANSMISSION / DRIVELINE
- GASKETS / SEALS
- ELECTRICAL
- LIGHTING
- CABLES
- BRAKES
- OIL FILTERS
- SUSPENSION
- BODY
- WHEELS
- TIRES / TIRE ACC.
- BIKE ACC.
- VICTORY / INDIAN
- COVERS / LOCKS / TIEDOWNS
- CHEMICALS
- TOOLS
- HELMETS
- HELMET ACC.
- EYEWEAR
- APPAREL / RIDER ACC.
- PROMOTIONAL
- REFERENCE
- INDEX



## ALLOY MIRRORS

### FIRE FIGHTER

- Fire Fighter cross gives a custom hero look
- These mirrors feature a custom look and great style to improve the look of your ride
- The chrome finish provides a shine that will last for years to come
- Universal fit
- Sold separately



Description/Application	Color	Left / Right	Sold	WPS#
Universal Fire Fighter mirror w/5" and 3 3/4" stem	Chrome	Left / Right	ea	820-0815

### APACHE

- Apache mirrors are available in matte black or chrome finish
- Unique design gives a one of a kind look for your bike
- Mirror head resembles a survival knife
- Sold separately



Description/Application	Color	Left / Right	Sold	WPS#
Universal Apache mirror w/knife stem	Matte Black	Left	ea	820-0817L
Universal Apache mirror w/knife stem	Matte Black	Right	ea	820-0817R
Universal Apache mirror w/knife stem	Chrome	Left	ea	820-0818L
Universal Apache mirror w/knife stem	Chrome	Right	ea	820-0818R

### FLAME

- Chrome finish with black back drop on the oval mirror makes this mirror one of a kind
- The flame stems seem to engulf the black oval mirror with chrome and style
- Sold as a set



Description/Application	Color	Sold	WPS#
Universal Flame mirror w/Flame stem	Black and Chrome	Set	820-0819

### WARRIOR

- Chrome finish that will last and last, easy upkeep and a great look
- The Warrior has a custom stem and mirror that looks like an arrow deflecting off a shield in battle
- This mirror is sure to give your bike the custom look you need to stand out
- Sold separately



Description/Application	Color	Left / Right	Sold	WPS#
Warrior mirror w/Slayer stem	Chrome	Left / Right	ea	820-0825

**ALLOY MIRRORS**



**SCORPION**

- Chrome finish that will look new and shiny for years
- Custom stem with unique design helps set your bike apart
- A dagger style with sharp edges gives the Scorpion mirror a fast smooth look you are sure to love
- Sold separately

Description/Application	Color	Left / Right	Sold	WPS#
Universal Scorpion mirror w/Tribal raised rib stem	Chrome	Left / Right	ea	<b>820-0824</b>



**FIN**

- The raised ribbed stem continues onto the mirror for a great look
- The Fin mirror has a great shape for good vision and a custom look
- Chrome finish will never disappoint and will keep a beautiful shine for years
- Sold in a set

Description/Application	Color	Sold	WPS#
Universal Caudal Fin mirror w/raised rib stem	Chrome	Set	<b>820-0823</b>



**SKULL**

- Skull mirrors are available in matte black with red eyes and chrome with black eyes
- Bone-like stems lead into a detailed Skull mirror for a complete custom look
- Lead the pack with these one of a kind mirrors that are sold in a set

Description/Application	Color	Sold	WPS#
A Skull Head Mirror Set	Chrome	Set	<b>820-0812C</b>
B Skull Head Mirror Set	Black	Set	<b>820-0812B</b>

WINDSHIELDS / FAIRINGS  
AUDIO / COMMUNICATION  
SEATS / LUGGAGE  
BARS / MIRRORS / CONTROLS  
EXHAUST  
AIR / FUEL SYSTEMS  
ENGINE  
TRANSMISSION / DRIVELINE  
GASKETS / SEALS  
ELECTRICAL  
LIGHTING  
CABLES  
BRAKES  
OIL FILTERS  
SUSPENSION  
BODY  
WHEELS  
TIRES / TIRE ACC.  
BIKE ACC.  
VICTORY / INDIAN  
COVERS / LOCKS / TIEDOWNS  
CHEMICALS  
TOOLS  
HELMETS  
HELMET ACC.  
EYEWEAR  
APPAREL / RIDER ACC.  
PROMOTIONAL  
REFERENCE  
INDEX

- WINDSHIELDS / FAIRINGS
- AUDIO / COMMUNICATION
- SEATS / LUGGAGE
- BARS / MIRRORS / CONTROLS**
- EXHAUST
- AIR / FUEL SYSTEMS
- ENGINE
- TRANSMISSION / DRIVELINE
- GASKETS / SEALS
- ELECTRICAL
- LIGHTING
- CABLES
- BRAKES
- OIL FILTERS
- SUSPENSION
- BODY
- WHEELS
- TIRES / TIRE ACC.
- BIKE ACC.
- VICTORY / INDIAN
- COVERS / LOCKS / TIEDOWNS
- CHEMICALS
- TOOLS
- HELMETS
- HELMET ACC.
- EYEWEAR
- APPAREL / RIDER ACC.
- PROMOTIONAL
- REFERENCE
- INDEX



## UNIVERSAL OVAL ARROW MIRRORS

- These mirrors feature slotted arrowhead stems
- Available in chrome or black
- Sold each



820-55584



820-55585

Description	WPS#
Chrome Oval Arrow Mirror (ea)	<b>820-55584</b>
Black Oval Arrow Mirror (ea)	<b>820-55585</b>

## UNIVERSAL TEAR DROP MIRROR

- Billet chromed mirror can be used for left or right side
- Classic teardrop design
- Sold each



Description	WPS#
Chrome Tear Drop Mirror (ea)	<b>820-55582</b>



## BILLET MIRRORS

Complement your existing Darkside accessories or just add style to your Harley Davidson with our Darkside edition mirrors. CNC machined from 6061-T6 aluminum and available in our unique two-tone chrome or contrast cut black hard anodized finish. Genuine Precision Billet mirrors have a unique 3d design and are detailed with 128 individually placed cone-head set screws to provide an awesome look. Direct bolt-on replacements on all HD models equipped with OEM mirrors. Mirrors measure 6" x 3" x 3/4".



Application	Year	Description	WPS#
<b>HARLEY DAVIDSON</b>			
All models	all	Dark Side Chrome	<b>810-0751</b>
All models	all	Dark Side Black	<b>810-0752</b>



# ALLOY MIRRORS

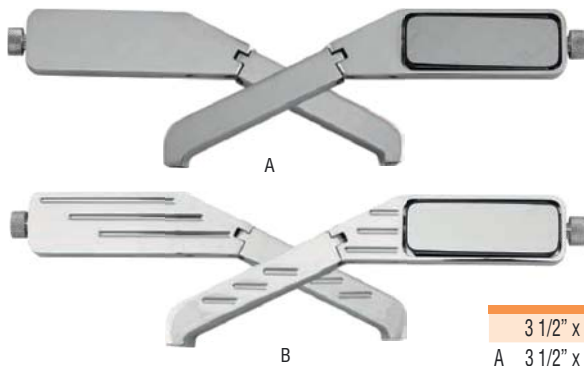

## BILLET RECTANGLE

- You can find your own angle with these chrome adjustable mirrors
- Easily adjusted up, down and side to side
- Thick chrome stem and mirror for a sleek custom design, choose between smooth and ball end grooved
- Sold separately

Description/Application	Color	Left / Right	Sold	WPS#
3 1/2" x 1 1/4" Rectangular Smooth Mirror	Billet	Left	ea	<b>820-0810L</b>
A 3 1/2" x 1 1/4" Rectangular Smooth Mirror	Billet	Right	ea	<b>820-0810R</b>
3 1/2" x 1 1/4" Rectangular Ball End Grooved Mirror	Billet	Left	ea	<b>820-0811L</b>
B 3 1/2" x 1 1/4" Rectangular Ball End Grooved Mirror	Billet	Right	ea	<b>820-0811R</b>



## RECTANGLE

- Rectangle mirrors have a timeless look that never goes out of style
- A slotted chrome stem leads up to a chrome rectangle mirror that will always shine
- You can cruise with confidence and enjoy great vision with these mirrors
- Sold separately

Description/Application	Color	Left / Right	Sold	WPS#
Universal 2" x 4 1/4" Rectangular Mirror	Chrome	Left / Right	ea	<b>820-0813</b>



## OVAL

- Oval mirrors are great for visibility and style
- The slotted stems give the Oval mirrors a unique look
- Chrome plated mirrors that shine will keep you smiling as you cruise down the road
- With 4 styles to choose from, it's easy to cruise your own direction

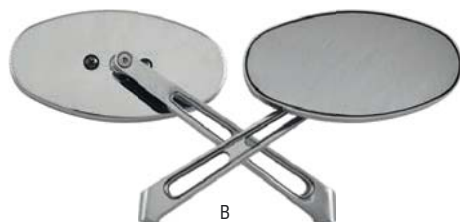

Description/Application	Color	Left / Right	Sold	WPS#
6" Louvered Oval Mirror	Chrome	Left	ea	<b>820-0802L</b>
A 6" Louvered Oval Mirror	Chrome	Right	ea	<b>820-0802R</b>
6" Smooth Oval Mirror	Chrome	Left	ea	<b>820-0803L</b>
B 6" Smooth Oval Mirror	Chrome	Right	ea	<b>820-0803R</b>
5" Custom Oval Mirror	Chrome	Left / Right	ea	<b>820-0804</b>
C 5 1/2" x 3 1/4" Oval Mirror Set	Chrome		Set	<b>820-0806</b>
D Radius Stepped Oval Mirror	Chrome	Left / Right	ea	<b>820-0807</b>



WINDSHIELDS / FAIRINGS  
 AUDIO / COMMUNICATION  
 SEATS / LUGGAGE  
**BARS / MIRRORS / CONTROLS**  
 EXHAUST  
 AIR / FUEL SYSTEMS  
 ENGINE  
 TRANSMISSION / DRIVELINE  
 GASKETS / SEALS  
 ELECTRICAL  
 LIGHTING  
 CABLES  
 BRAKES  
 OIL FILTERS  
 SUSPENSION  
 BODY  
 WHEELS  
 TIRES / TIRE ACC.  
 BIKE ACC.  
 VICTORY / INDIAN  
 COVERS / LOCKS / TIEDOWNS  
 CHEMICALS  
 TOOLS  
 HELMETS  
 HELMET ACC.  
 EYEWEAR  
 APPAREL / RIDER ACC.  
 PROMOTIONAL  
 REFERENCE  
 INDEX

- WINDSHIELDS / FAIRINGS
- AUDIO / COMMUNICATION
- SEATS / LUGGAGE
- BARS / MIRRORS / CONTROLS**
- EXHAUST
- AIR / FUEL SYSTEMS
- ENGINE
- TRANSMISSION / DRIVELINE
- GASKETS / SEALS
- ELECTRICAL
- LIGHTING
- CABLES
- BRAKES
- OIL FILTERS
- SUSPENSION
- BODY
- WHEELS
- TIRES / TIRE ACC.
- BIKE ACC.
- VICTORY / INDIAN
- COVERS / LOCKS / TIEDOWNS
- CHEMICALS
- TOOLS
- HELMETS
- HELMET ACC.
- EYEWEAR
- APPAREL / RIDER ACC.
- PROMOTIONAL
- REFERENCE
- INDEX



## OEM STYLE TAPERED MIRRORS

Modeled after the OEM mirrors on 2003 and later models, these mirrors offer great rearward visibility and are available with a short or long stem and your choice of satin black or chrome finish.



Description	Chrome	Black
Long Stem	<b>820-52800</b>	<b>820-52802</b>
Short Stem	<b>820-52801</b>	<b>820-52803</b>

## ROUND MIRRORS

- Classic look with clean style
- 3" round mirrors
- Available in Chrome or Black



Description/Application	Color	Left / Right	Sold	WPS#
A Universal 3" Round Mirror w/4" Stem	Chrome	L/R	ea	<b>820-0800C</b>
B Universal 3" Round Mirror w/4" Stem	Black	L/R	ea	<b>820-0800B</b>

## OE STYLE

- Keep it simple with OE style mirrors
- Choose from black or chrome
- Long stems for great visibility



Description/Application	Color	Left / Right	Sold	WPS#
A 3 1/2" x 5" Oblong OE Style Mirror	Chrome	Left / Right	ea	<b>820-0814C</b>
B 3 1/2" x 5" Oblong OE Style Mirror	Black	Left / Right	ea	<b>820-0814B</b>





### CHROME OVAL MIRROR

- Universal fitment for left or right side
- Available with short or long stem
- Sold each

Description	Application	WPS#
Chrome Oval Mirror (ea)	Long Stem	820-55570
	Short Stem	820-55571

### RECTANGULAR MIRRORS

- Available in chrome or black
- Sold each

Description	WPS#
Chrome Rectangular Mirror (ea)	820-55576
Black Rectangular Mirror (ea)	820-55577



### UNIVERSAL 4" ROUND MIRRORS

- These 4" mirrors replace OEM #s 91931-92T and 91930-92T
- Available in chrome or black finish

Description	Left	Right
Chrome 4" Round Mirror	820-55572	820-55573
Black 4" Round Mirror	820-55575	820-55574

Left



Right



Right



Left

- WINDSHIELDS / FAIRINGS
- AUDIO / COMMUNICATION
- SEATS / LUGGAGE
- BARS / MIRRORS / CONTROLS**
- EXHAUST
- AIR / FUEL SYSTEMS
- ENGINE
- TRANSMISSION / DRIVELINE
- GASKETS / SEALS
- ELECTRICAL
- LIGHTING
- CABLES
- BRAKES
- OIL FILTERS
- SUSPENSION
- BODY
- WHEELS
- TIRES / TIRE ACC.
- BIKE ACC.
- VICTORY / INDIAN
- COVERS / LOCKS / TIEDOWNS
- CHEMICALS
- TOOLS
- HELMETS
- HELMET ACC.
- EYEWEAR
- APPAREL / RIDER ACC.
- PROMOTIONAL
- REFERENCE
- INDEX



## UNIVERSAL 4" ROUND MIRRORS

- Universal 4" Round mirrors in chrome or black
- Available with 4" stem or 8" stem

Description	Chrome	Black
4" Stem	820-55578	820-55580
8" Stem	820-55579	820-55581



- WINDSHIELDS / FAIRINGS
- AUDIO / COMMUNICATION
- SEATS / LUGGAGE
- BARS / MIRRORS / CONTROLS**
- EXHAUST
- AIR / FUEL SYSTEMS
- ENGINE
- TRANSMISSION / DRIVELINE
- GASKETS / SEALS
- ELECTRICAL
- LIGHTING
- CABLES
- BRAKES
- OIL FILTERS
- SUSPENSION
- BODY
- WHEELS
- TIRES / TIRE ACC.
- BIKE ACC.
- VICTORY / INDIAN
- COVERS / LOCKS / TIEDOWNS
- CHEMICALS
- TOOLS
- HELMETS
- HELMET ACC.
- EYEWEAR
- APPAREL / RIDER ACC.
- PROMOTIONAL
- REFERENCE
- INDEX

## TAPERED FAIRING MIRRORS

- Radium tapered fairing mirrors
- Made from aluminum and beautifully finished in chrome or black
- Fits '14-Up models w/ the Bat Wing fairing
- Sold in pairs.

Chrome	Black
820-52389	820-52390



## CAFE STYLE BAR END MIRRORS

- CNC machined billet 6061-T6 aluminum modular assembly
- Chrome adjustable hardware
- Available in a black or chrome finish
- Fit 1" dia handle bars
- The internal bar-end adaptor is easy to install
- Mirror is 3" diameter
- Sold in pairs ( LH & RH set )

Chrome	Black
820-52392	820-52391



WINDSHIELDS / FAIRINGS

AUDIO / COMMUNICATION

SEATS / LUGGAGE

**BARS / MIRRORS / CONTROLS**

EXHAUST

AIR / FUEL SYSTEMS

ENGINE

TRANSMISSION / DRIVELINE

GASKETS / SEALS

ELECTRICAL

LIGHTING

CABLES

BRAKES

OIL FILTERS

SUSPENSION

BODY

WHEELS

TIRES / TIRE ACC.

BIKE ACC.

VICTORY / INDIAN

COVERS / LOCKS / TIEDOWNS

CHEMICALS

TOOLS

HELMETS

HELMET ACC.

EYEWEAR

APPAREL / RIDER ACC.

PROMOTIONAL

REFERENCE

INDEX



## MIRROR EXTENSIONS

These new mirror extension kits improve visibility to the rear of your bike by repositioning mirrors outward approximately 2" and upward 1". Available in a chrome or black finish and made from billet 6061-T6 aluminum. They fit a wide selection of original mirrors for '06 later Dyna, '08 later Softail and '09 later Road King models.



Application	Chrome	Black
'06-Up Dyna models, '08-Up Softail models and '09-Up Road King and Road Glide models	<b>820-0828</b>	<b>820-0829</b>

## MIRROR MOUNTS

- Keep it all custom with a nice chrome finish mirror mount
- These mirror mounts will start the custom look you're going for
- Looks great with any style of mirror



Description/Application	Color	Left / Right	Sold	WPS#
Two piece adjustable mounting clamp for HD style mirrors	Chrome		ea	<b>820-0827</b>
Billet right side mirror adapter for 96-up HD	Chrome	Right	ea	<b>820-0826</b>

## MIRROR MOUNTS

- CNC Machined 6061 aluminum
- Six different anodized colored options
- Sold each
- Made in the USA



Description	Finish	Milled	Slotted	Description	Finish	Milled	Slotted
7/8" Mirror Mounts	Raw	<b>825-02176</b>	<b>825-02188</b>	1" Mirror Mounts	Raw	<b>825-02170</b>	<b>825-02182</b>
	Black	<b>825-02177</b>	<b>825-02189</b>		Black	<b>825-02171</b>	<b>825-02183</b>
	Polished	<b>825-02178</b>	<b>825-02190</b>		Polished	<b>825-02172</b>	<b>825-02184</b>
	Gold	<b>825-02179</b>	<b>825-02191</b>		Gold	<b>825-02173</b>	<b>825-02185</b>
	Red	<b>825-02180</b>	<b>825-02192</b>		Red	<b>825-02174</b>	<b>825-02186</b>
	Blue	<b>825-02181</b>	<b>825-02193</b>	Blue	<b>825-02175</b>	<b>825-02187</b>	



### CUSTOM GRIPS



- Fully CNC machined from 6061 aluminum with a knurled rubber grip surface
- Unsurpassed comfort and grip
- Made in the USA

- Available in chrome or black finish
- Matching grips and gas caps available
- Sold in pairs



Description	Black	Chrome
<b>CABLE THROTTLE</b>		
A Shock	820-4041	820-4042
B Dash	820-4045	820-4046
C Throttle	820-4049	820-4050

Description	Black	Chrome
<b>FLY BY WIRE THROTTLE</b>		
A Shock	820-4043	820-4044
B Dash	820-4047	820-4048
C Throttle	820-4051	820-4052

**REPLACEMENT RUBBER**  
820-4040



### KNURLED GRIPS

- CNC Machined 6061 aluminum (except brass version)
- Knurled design
- Available for cable throttle and throttle by wire
- Made in the USA

Description	Finish	Cable Throttle	Throttle by Wire
Knurled Grips	Raw	825-02070	825-02074
	Black	825-02071	825-02075
	Polished	825-02072	825-02076
	Brass	825-02073	825-02077



### VENOM CUSTOM GRIPS

- Made of billet aluminum
- Non-slip rubber grip
- Fitment for '73-Up Models w/ cable throttle
- Fitment for '08-Up Models w/ throttle by wire
- Sold in pairs

Description	Chrome	Black
<b>CABLE THROTTLE</b>		
Raw Cut	820-54800	820-54808
Shot Peened	820-54804	820-54812

Description	Chrome	Black
<b>FLY BY WIRE THROTTLE</b>		
Raw Cut	820-54801	820-54809
Shot Peened	820-54805	820-54813
Replacement Rubber for Venom grips		820-54816

- WINDSHIELDS / FAIRINGS
- AUDIO / COMMUNICATION
- SEATS / LUGGAGE
- BARS / MIRRORS / CONTROLS**
- EXHAUST
- AIR / FUEL SYSTEMS
- ENGINE
- TRANSMISSION / DRIVELINE
- GASKETS / SEALS
- ELECTRICAL
- LIGHTING
- CABLES
- BRAKES
- OIL FILTERS
- SUSPENSION
- BODY
- WHEELS
- TIRES / TIRE ACC.
- BIKE ACC.
- VICTORY / INDIAN
- COVERS / LOCKS / TIEDOWNS
- CHEMICALS
- TOOLS
- HELMETS
- HELMET ACC.
- EYEWEAR
- APPAREL / RIDER ACC.
- PROMOTIONAL
- REFERENCE
- INDEX



## CHROME BILLET NO-VIBE GRIPS

- Feature three soft rubber bands set into grips to reduce vibration for added comfort
- Comfortable and stylish
- Billet aluminum construction with a chrome-plated finish



Description/Application	Grip Style	WPS#
A Chrome Billet NoVibe grips w/dual cable throttle sleeve / '76-08-Up HD (except '08 Touring models)	Black Rubber	<b>820-1713</b>
B Chrome Billet NoVibe grip / '08-Up FLT	Black Rubber	<b>820-1714</b>
Replacement Rubber inserts (6pc/Set)		<b>820-1715</b>

## BARREL STYLE TWIST GRIP

- Chrome grips with rubber insert
- Twisted or straight inserts
- Barrel look adds great style to any bike



Description/Application	Grip Style	WPS#
A Straight Rail Grip w/dual cable throttle sleeve / '81-Up HD	Black Rubber	<b>820-1711</b>
B Twisted Rail Grip w/dual throttle sleeve / fits 1" bar & '76-Up HD	Black Rubber	<b>820-1717</b>

## RUBBER BAND O-RING STYLE GRIPS

- Chrome grips for style
- Rubber inserts for comfort
- Style and comfort

Description/Application	Grip Style	WPS#
Rubber Band O-Ring Style grip / '73-Up HD	Black Rubber	<b>820-1724</b>
Replacement Rings / 10pcs/Set		<b>820-1725</b>



## VINTAGE GRIPS



- Black rubber retro grips with chrome accent ring
- Throttle sleeve included
- Available for all years including throttle by wire
- Sold in pairs

Application	WPS#
All Models '73-'95	<b>820-70457</b>
A All Models '96-Up (except TBW)	<b>820-70458</b>
B All Models '08-Up TBW	<b>820-70459</b>

## OLD SCHOOL GRIPS

- Retro grip design, great for bobbers!
- For use with existing throttle sleeve
- Sold in pairs

Description	Application	WPS#
Old School Grips Black	All Models '84-Up (except TBW)	<b>820-70455</b>
Old School Grips White	All Models '84-Up (except TBW)	<b>820-70456</b>

## OEM STYLE GRIPS

- Replica of the OEM rubber grips
- Throttle sleeve included
- Sold in pairs

Application	WPS#
All Models '84-Up (except TBW)	<b>820-70450</b>

## OE STYLE GRIPS

- Get a custom look with chrome end caps and collars
- Great comfort and style
- Durable smooth black leather sleeve or black foam sleeve for a comfortable feel
- NOTE: require throttle sleeve, sold separately

Description/ Application	Grip Style	WPS#
A '74 - Up HD	Smooth Black Leather	<b>820-1701</b>
B '73 - Up HD	Black Foam	<b>820-1702</b>



Description/Application	Grip Style	WPS#
A Rail Grip w/Smooth end caps / '73-Up HD	Black Rubber	<b>820-1705</b>
B Rail Grip w/Skull Head end caps / '73-Up HD	Black Rubber	<b>820-1706</b>
C Rail Grip w/Slotted black painted end caps / '74 - UP HD	Black Rubber	<b>820-1707</b>
D Rail Grip w/Smooth end caps / '08-Up FLT Black Throttle Sleeve	Black Rubber	<b>820-1708</b> <b>820-1709</b>

## RAIL STYLE GRIPS

- Great style with lots of chrome
- Rubber inserts for comfort
- Custom end caps
- Grips 820-1705, 820-1706 and 820-1707 require purchase of throttle sleeve 820-1709



- WINDSHIELDS / FAIRINGS
- AUDIO / COMMUNICATION
- SEATS / LUGGAGE
- BARS / MIRRORS / CONTROLS
- EXHAUST
- AIR / FUEL SYSTEMS
- ENGINE
- TRANSMISSION / DRIVELINE
- GASKETS / SEALS
- ELECTRICAL
- LIGHTING
- CABLES
- BRAKES
- OIL FILTERS
- SUSPENSION
- BODY
- WHEELS
- TIRES / TIRE ACC.
- BIKE ACC.
- VICTORY / INDIAN
- COVERS / LOCKS / TIEDOWNS
- CHEMICALS
- TOOLS
- HELMETS
- HELMET ACC.
- EYEWEAR
- APPAREL / RIDER ACC.
- PROMOTIONAL
- REFERENCE
- INDEX

- WINDSHIELDS / FAIRINGS
- AUDIO / COMMUNICATION
- SEATS / LUGGAGE
- BARS / MIRRORS / CONTROLS**
- EXHAUST
- AIR / FUEL SYSTEMS
- ENGINE
- TRANSMISSION / DRIVELINE
- GASKETS / SEALS
- ELECTRICAL
- LIGHTING
- CABLES
- BRAKES
- OIL FILTERS
- SUSPENSION
- BODY
- WHEELS
- TIRES / TIRE ACC.
- BIKE ACC.
- VICTORY / INDIAN
- COVERS / LOCKS / TIEDOWNS
- CHEMICALS
- TOOLS
- HELMETS
- HELMET ACC.
- EYEWEAR
- APPAREL / RIDER ACC.
- PROMOTIONAL
- REFERENCE
- INDEX



## KNURLED GRIPS NEW

These knurled grips are the pinnacle of grip and performance. Do you ride hard, wheelie from time to time, do the occasional hole-shot? If so, you need these grips. Aggressively knurled for maximum grip. Slight raised arc to fit perfectly in the palm of your hand. Plus, they look amazing!

Description	Finish	Cable Throttle	Throttle by Wire
Knurled Grips	Natural	826-01070	826-01076
	Black	826-01071	826-01077
	Gold	826-01072	826-01078
	Red	826-01074	826-01079



Natural

Black

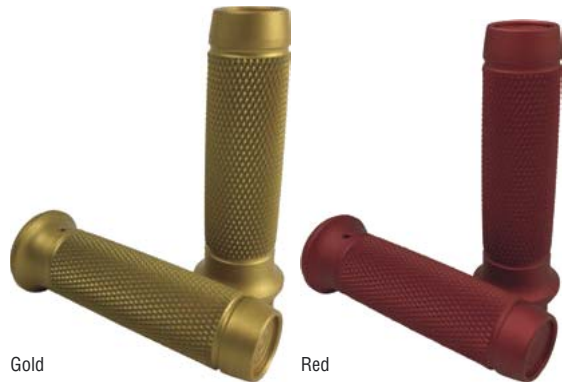

Gold

Red

## LEATHER GRIPS NEW

Your hands engage with your bike on a more personal and tactile level than the rest of your body. They control your bike. Shouldn't your grips be amazing?

Like the leather wrapped steering wheel of a premium automobile, our uniquely designed, precision crafted and hand stitched leather wrapped grips deliver an experience like no other.

First they are CNC machined from billet aircraft grade aluminum with a recessed knurled surface to ensure the leather will not slide or twist. The leather is laser cut to shape then the pattern embossed. Next the leather is dyed & airbrushed. Finally the grips & leather have bonding agent applied. The leather is glued and skillfully hand stitched around the grip.

Description	Finish	Cable Throttle	Throttle by Wire
Leather Grips	Natural/Black - Ribbed	826-01080	826-01089
	Black/Black - Ribbed	826-01083	826-01092
	Black/Tan - Ribbed	826-01084	826-01093
	Black/Dark Brown - Diamond	826-01085	826-01094
	Natural/Black - Diamond	826-01082	826-01091
	Natural/Tan - Honeycomb	826-01081	826-01090



Natural/Black Ribbed

Natural/Tan Honeycomb



Natural Black Diamond

Black/Black Ribbed



Black/Tan Ribbed

Black/dark Brown Diamond





## MEMORY FOAM GRIPS

- The softest, most durable, chemical resistant grip on the market today
- A true vibration dampening grip
- Available in small, medium and large diameters for all Harley-Davidsons
- Chrome and black anodized Aluminum ends
- Fit '84-Up H-D models
- Fits 1" bars
- Sold in pairs

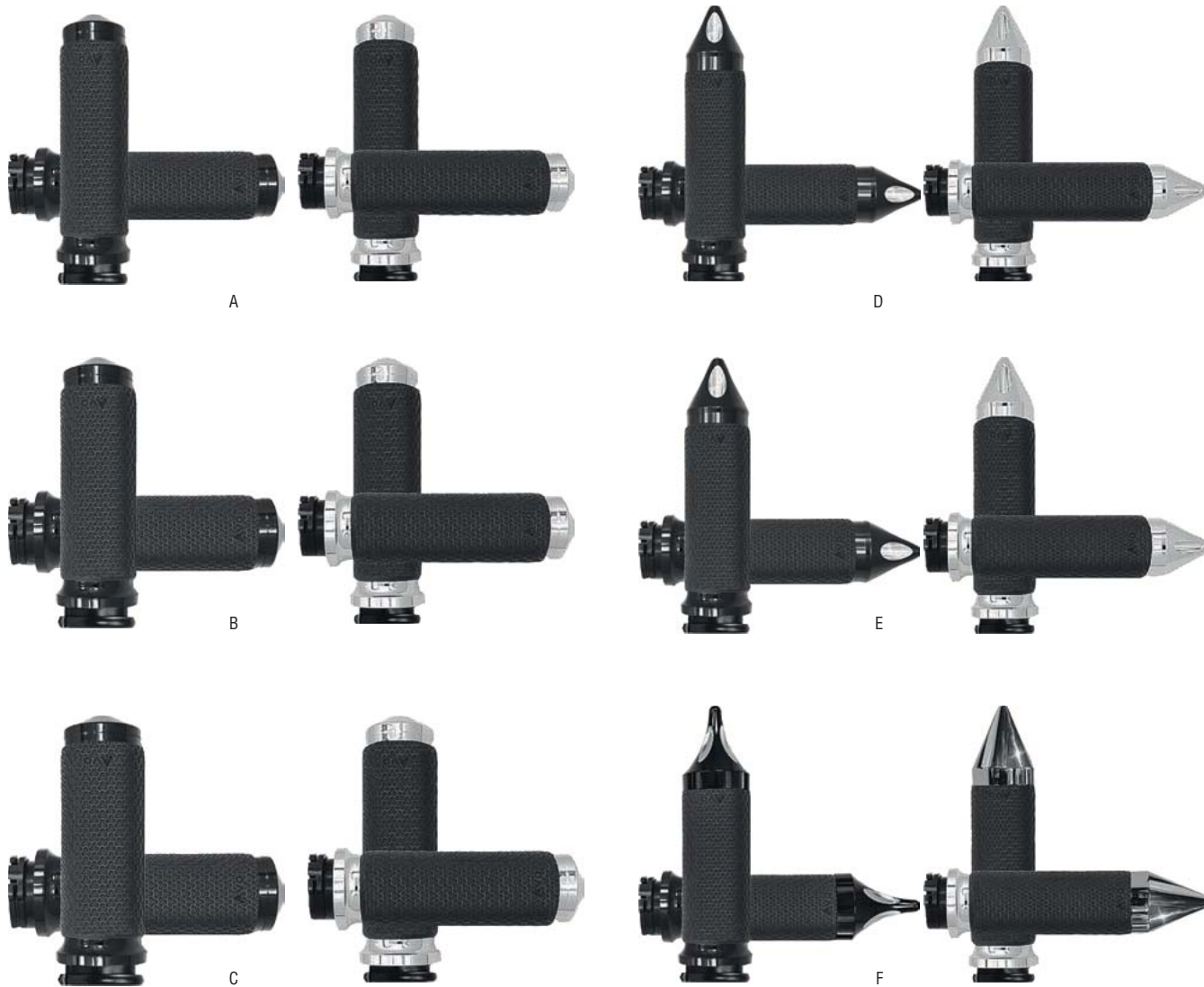

	Description	Black	Chrome
<b>CABLE THROTTLE</b>			
A	Memory Foam 1.375" OD	40-4732BK	40-4732C
B	Memory Foam 1.5" OD	40-4736BK	40-4736C
C	Memory Foam 1.625" OD	40-4740BK	40-4740C
<b>FLY BY WIRE THROTTLE</b>			
D	Memory Foam Spike 1.375" OD	40-4734BK	40-4734C
E	Memory Foam Spike 1.5" OD	40-4738BK	40-4738C
F	Memory Foam Spike 1.625" OD	40-4742BK	40-4742C
A	Memory Foam 1.375" OD	40-4733BK	40-4733C
B	Memory Foam 1.5" OD	40-4737BK	40-4737C
C	Memory Foam 1.625" OD	40-4741BK	40-4741C
D	Memory Foam Spike 1.375" OD	40-4735BK	40-4735C
E	Memory Foam Spike 1.5" OD	40-4739BK	40-4739C
F	Memory Foam Spike 1.625" OD	40-4743BK	40-4743C

- WINDSHIELDS / FAIRINGS
- AUDIO / COMMUNICATION
- SEATS / LUGGAGE
- BARS / MIRRORS / CONTROLS**
- EXHAUST
- AIR / FUEL SYSTEMS
- ENGINE
- TRANSMISSION / DRIVELINE
- GASKETS / SEALS
- ELECTRICAL
- LIGHTING
- CABLES
- BRAKES
- OIL FILTERS
- SUSPENSION
- BODY
- WHEELS
- TIRES / TIRE ACC.
- BIKE ACC.
- VICTORY / INDIAN
- COVERS / LOCKS / TIEDOWNS
- CHEMICALS
- TOOLS
- HELMETS
- HELMET ACC.
- EYEWEAR
- APPAREL / RIDER ACC.
- PROMOTIONAL
- REFERENCE
- INDEX



## CUSTOM CONTOUR GRIPS

- “Contoured for your hands, custom for your bike!”
- Also available in heated version
- Manufactured in the USA with Kraton rubber and feature a very soft serrated texture to help hang on to your bike
- Heated grips have 4 heat settings indicated by LED lights and include a switch
- Finished off with only the best 6061 billet aluminum end caps and collars
- Fit '84-Up H-D models
- Inside length 4.20", OD 1.45"
- Fits 1" bars
- Sold in pairs



	Description	Black	Chrome
<b>CABLE THROTTLE</b>			
A	Custom Contour	<b>40-4350BK</b>	<b>40-4350C</b>
A	Custom Contour Heated	<b>40-4350HBK</b>	<b>40-4350HC</b>
B	Custom Contour w/Throttle Boss	<b>40-4352BK</b>	<b>40-4352C</b>
C	Custom Contour Spike	<b>40-4354BK</b>	<b>40-4354C</b>
C	Custom Contour Spike Heated	<b>40-4354HBK</b>	<b>40-4354HC</b>
D	Custom Contour Excalibur	<b>40-4700BK</b>	<b>40-4700C</b>
E	Custom Contour Gatlin	<b>40-4702BK</b>	<b>40-4702C</b>
F	Custom Contour Rival	<b>40-4704BK</b>	<b>40-4704C</b>
<b>FLY BY WIRE THROTTLE</b>			
A	Custom Contour	<b>40-4351BK</b>	<b>40-4351C</b>
A	Custom Contour Heated	<b>40-4351HBK</b>	<b>40-4351HC</b>
B	Custom Contour w/Throttle Boss	<b>40-4353BK</b>	<b>40-4353C</b>
C	Custom Contour Spike	<b>40-4355BK</b>	<b>40-4355C</b>
C	Custom Contour Spike Heated	<b>40-4355HBK</b>	<b>40-4355HC</b>
D	Custom Contour Excalibur	<b>40-4701BK</b>	<b>40-4701C</b>
E	Custom Contour Gatlin	<b>40-4703BK</b>	<b>40-4703C</b>
F	Custom Contour Rival	<b>40-4705BK</b>	<b>40-4705C</b>
<b>ACCESSORIES</b>			
	Throttle Boss	<b>40-4391BK</b> *	<b>40-4391C</b> *

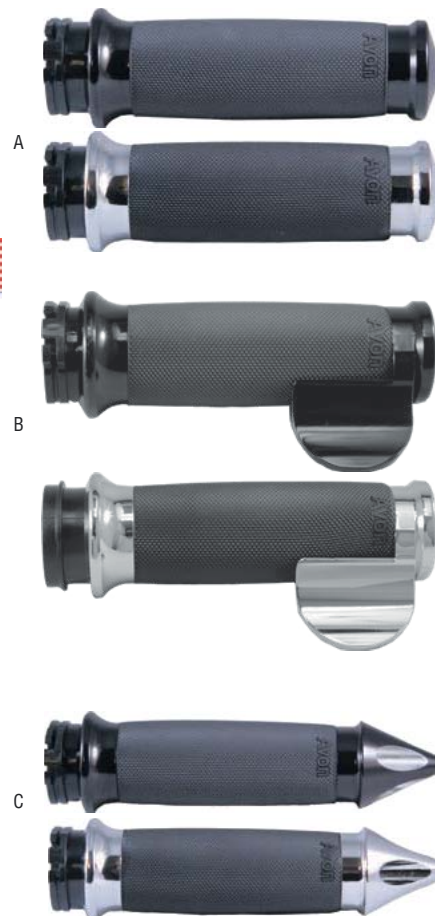

\* Not for use with Excalibur, Gatlin, Rival or spiked grips





A



B



C



D



E



A



B



A



B



B



C



D



E



## AIR SS GRIPS

- The Air-SS incorporates an air cushion system that will reduce some of the unwanted vibrations
- Same grippy texture as the original Air Cushion grip
- Available in triple chrome plated, or black anodized, billet aluminum ends

- Also available in heated version
- Heated grips have 4 heat settings indicated by LED lights and include a switch
- Fit '84-Up H-D models
- Inside length 4.60", OD 1.50"
- Sold in pairs

Description	Black	Chrome
<b>CABLE THROTTLE</b>		
A Air-SS	<b>40-4346BK</b>	<b>40-4346C</b>
B Air-SS w/Throttle Boss	<b>40-4348BK</b>	<b>40-4348C</b>
C Air-SS Excalibur	<b>40-4718BK</b>	<b>40-4718C</b>
D Air-SS Gatlin	<b>40-4720BK</b>	<b>40-4720C</b>
E Air-SS Rival	<b>40-4722BK</b>	<b>40-4722C</b>



Description	Black	Chrome
<b>FLY BY WIRE THROTTLE</b>		
A Air-SS	<b>40-4347BK</b>	<b>40-4347C</b>
B Air-SS w/Throttle Boss	<b>40-4349BK</b>	<b>40-4349C</b>
C Air-SS Excalibur	<b>40-4719BK</b>	<b>40-4719C</b>
D Air-SS Gatlin	<b>40-4721BK</b>	<b>40-4721C</b>
E Air-SS Rival	<b>40-4723BK</b>	<b>40-4723C</b>

## VELVET AIR GRIPS

- Velvet Air is a softer, vibration dampening grip that utilizes air pockets inside of the grip body
- The smooth, "velvet like" surface of these grips makes for a very comfortable ride
- Made with Kraton polymer, and finished off with billet aluminum end caps and collars

- Also available in heated version
- Heated grips have 4 heat settings indicated by LED lights and include a switch
- Fit '84-Up H-D models
- Inside length 4.60", OD 1.60"
- Sold in pairs.

Description	Black	Chrome
<b>CABLE THROTTLE</b>		
A Velvet Air	<b>40-4332BK</b>	<b>40-4332C</b>
B Velvet Air Heated	<b>40-4332HBK</b>	<b>40-4332HC</b>
A Velvet Air w/Throttle Boss	<b>40-4342BK</b>	<b>40-4342C</b>
C Velvet Air Excalibur	<b>40-4712BK</b>	<b>40-4712C</b>
D Velvet air Gatlin	<b>40-4714BK</b>	<b>40-4714C</b>
E Velvet Air Rival	<b>40-4716BK</b>	<b>40-4716C</b>



Description	Black	Chrome
<b>FLY BY WIRE THROTTLE</b>		
A Velvet Air	<b>40-4333BK</b>	<b>40-4333C</b>
A Velvet Air Heated	<b>40-4333HBK</b>	<b>40-4333HC</b>
B Velvet Air w/Throttle Boss	<b>40-4343BK</b>	<b>40-4343C</b>
C Velvet Air Excalibur	<b>40-4713BK</b>	<b>40-4713C</b>
D Velvet Air Gatlin	<b>40-4715BK</b>	<b>40-4715C</b>
E Velvet Air Rival	<b>40-4717BK</b>	<b>40-4717C</b>

ACCESSORIES	Black	Chrome
Throttle Boss	<b>40-4390BK *</b>	<b>40-4390C *</b>

\* Not for use with Excalibur, Gatlin, Rival

- WINDSHIELDS / FAIRINGS
- AUDIO / COMMUNICATION
- SEATS / LUGGAGE
- BARS / MIRRORS / CONTROLS
- EXHAUST
- AIR / FUEL SYSTEMS
- ENGINE
- TRANSMISSION / DRIVELINE
- GASKETS / SEALS
- ELECTRICAL
- LIGHTING
- CABLES
- BRAKES
- OIL FILTERS
- SUSPENSION
- BODY
- WHEELS
- TIRES / TIRE ACC.
- BIKE ACC.
- VICTORY / INDIAN
- COVERS / LOCKS / TIEDOWNS
- CHEMICALS
- TOOLS
- HELMETS
- HELMET ACC.
- EYEWEAR
- APPAREL / RIDER ACC.
- PROMOTIONAL
- REFERENCE
- INDEX

- WINDSHIELDS / FAIRINGS
- AUDIO / COMMUNICATION
- SEATS / LUGGAGE
- BARS / MIRRORS / CONTROLS**
- EXHAUST
- AIR / FUEL SYSTEMS
- ENGINE
- TRANSMISSION / DRIVELINE
- GASKETS / SEALS
- ELECTRICAL
- LIGHTING
- CABLES
- BRAKES
- OIL FILTERS
- SUSPENSION
- BODY
- WHEELS
- TIRES / TIRE ACC.
- BIKE ACC.
- VICTORY / INDIAN
- COVERS / LOCKS / TIEDOWNS
- CHEMICALS
- TOOLS
- HELMETS
- HELMET ACC.
- EYEWEAR
- APPAREL / RIDER ACC.
- PROMOTIONAL
- REFERENCE
- INDEX



## V-CRUISER GRIPS



- V-Cruiser grips have a very traditional Harley look and feel
- Made with Kraton rubber
- Feature a double leather grain texture in a soft but durable grip
- 6061 billet aluminum end caps and collars
- Fit '84-Up H-D models
- Inside length 5.10", OD 1.50"
- Sold in pairs.

Description	Chrome
V-Cruiser w/cable throttle	<b>40-4362C</b>
V-Cruiser w/fly-by-wire throttle	<b>40-4363C</b>



## OLD SCHOOL GRIPS

- Made with Kraton rubber
- These "made to look old" grips will not dry and harden
- They will not stain your hands black and they look and feel great
- Fits H-D 1" bars
- Sold in pairs

Description	WPS#
A Soda Bottle	<b>40-4366BK</b>
B Waffle	<b>40-4367</b>
C Jack Hammer	<b>40-4368</b>

A  
B  
C

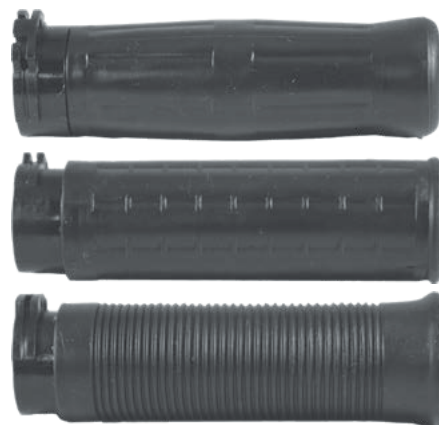

## AIR GEL GRIPS

- The new GEL grips are a very ergonomic grip
- Feature the softest rubber that Avon has used in a street bike grip
- The soft rubber has a unique dimple texture and tacky feel that helps reduce unwanted road and engine vibrations
- The new style grip is complimented by stylish, billet aluminum, triple chrome plated or black anodized end caps and collars

Description	Black	Chrome
Air Gel Grips w/cable throttle	<b>40-4730BK</b>	<b>40-4730C</b>
Air Gel Grips w/fly-by-wire throttle	<b>40-4731BK</b>	<b>40-4731C</b>





# AIR CUSHIONED GRIPS

"Air Ride For Your Hands!"



- The Avon Air Cushion Anodized grips feel great and are very functional too
- Manufactured in the USA with a special core bar that creates air pockets inside the grip body
- Dampen vibrations, help eliminate the tingle in your hands and soften the

- overall feel of the ride
- The soft serrated texture on the grip surface helps you hold on to your bike
- 6061 billet aluminum end caps and collars
- Also available in heated version

- Heated grips have 4 heat settings indicated by LED lights and include a switch
- Fit '84-Up H-D models
- Inside length 4.60", OD 1.625"
- Sold in pairs

Description	Black	Chrome
<b>CABLE THROTTLE</b>		
A Air Cushioned	<b>40-4330BK</b>	<b>40-4330C</b>
A Air Cushioned Heated	<b>40-4330HBK</b>	<b>40-4330HC</b>
B Air Cushioned w/Throttle Boss	<b>40-4340BK</b>	<b>40-4340C</b>
C Air Cushioned Excalibur	<b>40-4706BK</b>	<b>40-4706C</b>
D Air Cushioned Gatlin	<b>40-4708BK</b>	<b>40-4708C</b>
E Air Cushioned Rival	<b>40-4710BK</b>	<b>40-4710C</b>
F Air Cushioned Spike	<b>40-4344BK</b>	<b>40-4344C</b>
G Air Cushioned Castle	<b>40-4261BK</b>	<b>40-4261C</b>
H Air Cushioned Deep Cut	<b>40-4263BK</b>	<b>40-4263C</b>
I Air Cushioned Slots	<b>40-4264BK</b>	<b>40-4264C</b>
J Air Cushioned Elite	<b>40-4266BK</b>	<b>40-4266C</b>

Description	Black	Chrome
<b>FLY BY WIRE THROTTLE</b>		
A Air Cushioned	<b>40-4331BK</b>	<b>40-4331C</b>
A Air Cushioned Heated	<b>40-4331HBK</b>	<b>40-4331HC</b>
B Air Cushioned w/Throttle Boss	<b>40-4341BK</b>	<b>40-4341C</b>
C Air Cushioned Excalibur	<b>40-4707BK</b>	<b>40-4707C</b>
D Air Cushioned Gatlin	<b>40-4709BK</b>	<b>40-4709C</b>
E Air Cushioned Rival	<b>40-4711BK</b>	<b>40-4711C</b>
F Air Cushioned Spike	<b>40-4345BK</b>	<b>40-4345C</b>
G Air Cushioned Castle	<b>40-4260BK</b>	<b>40-4260C</b>
H Air Cushioned Deep Cut	<b>40-4262BK</b>	<b>40-4262C</b>
I Air Cushioned Slots	<b>40-4265BK</b>	<b>40-4265C</b>
J Air Cushioned Elite	<b>40-4267C</b>	

<b>ACCESSORIES</b>		
Throttle Boss	<b>40-4390BK *</b>	<b>40-4390C *</b>

\* Not for use with Excaliber, Gatlin, Rival or spiked grips



- WINDSHIELDS / FAIRINGS
- AUDIO / COMMUNICATION
- SEATS / LUGGAGE
- BARS / MIRRORS / CONTROLS**
- EXHAUST
- AIR / FUEL SYSTEMS
- ENGINE
- TRANSMISSION / DRIVELINE
- GASKETS / SEALS
- ELECTRICAL
- LIGHTING
- CABLES
- BRAKES
- OIL FILTERS
- SUSPENSION
- BODY
- WHEELS
- TIRES / TIRE ACC.
- BIKE ACC.
- VICTORY / INDIAN
- COVERS / LOCKS / TIEDOWNS
- CHEMICALS
- TOOLS
- HELMETS
- HELMET ACC.
- EYEWEAR
- APPAREL / RIDER ACC.
- PROMOTIONAL
- REFERENCE
- INDEX



## HEAT DEMONS GRIP WARMERS

- Installs inside the handlebars allowing for use with any grip
- Custom weatherproof controller with 4 levels of heat
- Fast warm up, easy to install
- 4 color LED lights indicate the heat level selected
- Thermister feedback keeps the grip heat at the selected level regardless of voltage variations or ambient conditions
- Fitments for Harley Davidson and universal metric applications



Description	Black	Chrome
Harley Davidson (w/1" or 1¼" bars, left mount)	40-4212B	40-4212C

## Go CRUISE CRUISE CONTROL

- Easy to install, no tools required
- Install or remove in seconds
- 2 sizes to fit motorcycles with 7/8" and 1" handlebars
- Relieves stress on your wrist on long trips
- Rests on brake lever to hold throttle open
- Roll off throttle manually to disengage Go Cruise

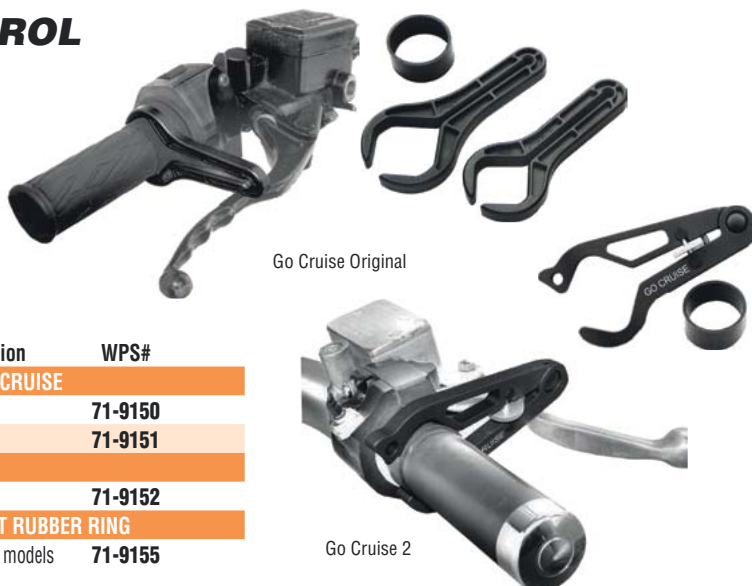

Go Cruise Original

Go Cruise 2

### Original Go Cruise

- Made from high strength black plastic
- Original Go Cruise available in sizes to fit grips on 7/8" and 1" bars

### Go Cruise 2

- Made from CNC machined 6061 aluminum
- Adjustable to fit most any size grips for 7/8" and larger bar sizes

Description	WPS#
<b>ORIGINAL GO CRUISE</b>	
7/8" Bars	71-9150
1" Bars	71-9151
<b>GO CRUISE 2</b>	
Fits all grip sizes	71-9152
<b>REPLACEMENT RUBBER RING</b>	
Fits all Go Cruise models	71-9155



## MOTORCYCLE CRUISE ASSIST

- Wide version available in chrome finish
- Easy installation – no tools needed
- Full throttle control with a relaxed hand
- Reduces hand fatigue and cramping
- Doesn't lock throttle on
- Available for standard (1⅝") and oversize (1½") diameter grips
- Starter pack now available (includes 3 of each crampbuster, excluding chrome, 12 total)



Standard



Wide

Description	Mfr. #	WPS#
Standard grip, narrow	CB1	70-1070
Standard grip, wide	CB2	70-1071
Standard grip, wide chrome	CB2-C	70-1071C
Oversize grip, narrow	CB3	70-1072
Oversize grip, wide	CB4	70-1073
Oversize grip, wide chrome	CB4-C	70-1073C
Starter pack (assortment of 12)	CB5	70-1075

# MASTER CYLINDER COVERS NEW



Copper Inlay



## FRONT MASTER CYLINDER COVERS

Description	Natural	Black
<b>FITS '14-18 FLH/FLT</b>		
Knurled	<b>826-01174</b>	<b>826-01175</b>
Carbon Inlay	<b>826-01176</b>	<b>826-01177</b>
Copper Inlay	<b>826-01178</b>	<b>826-01179</b>
<b>FITS '04-18 XL</b>		
Knurled	<b>826-01170</b>	<b>826-01171</b>
Carbon Inlay	<b>826-01172</b>	<b>826-01173</b>

## CLUTCH MASTER CYLINDER COVERS

Description	Natural	Black
<b>FITS '14-18 FLH/FLT</b>		
Knurled	<b>826-01180</b>	<b>826-01181</b>
Carbon Inlay	<b>826-01182</b>	<b>826-01183</b>
Copper Inlay	<b>826-01184</b>	<b>826-01185</b>



Knurled



Carbon Inlay



- WINDSHIELDS / FAIRINGS
- AUDIO / COMMUNICATION
- SEATS / LUGGAGE
- BARS / MIRRORS / CONTROLS
- EXHAUST
- AIR / FUEL SYSTEMS
- ENGINE
- TRANSMISSION / DRIVELINE
- GASKETS / SEALS
- ELECTRICAL
- LIGHTING
- CABLES
- BRAKES
- OIL FILTERS
- SUSPENSION
- BODY
- WHEELS
- TIRES / TIRE ACC.
- BIKE ACC.
- VICTORY / INDIAN
- COVERS / LOCKS / TIEDOWNS
- CHEMICALS
- TOOLS
- HELMETS
- HELMET ACC.
- EYEWEAR
- APPAREL / RIDER ACC.
- PROMOTIONAL
- REFERENCE
- INDEX



## FRONT MASTER CYLINDER COVERS



820-55004



820-52940



820-52941



820-52921

Description	Chrome	Black
Replacement Brake Master Cylinder Cover '14-Up FLT	<b>820-55004</b>	
Replacement Clutch Master Cylinder Cover '14-Up FLT (w/Gasket)	<b>820-55006</b>	
Replacement Master Cylinder Cover '96-06	<b>820-52940</b>	<b>820-52941</b>
Replacement Master Cylinder Cover '82-95	<b>820-52921</b>	



R O K K E

## MASTER CYLINDER COVERS

Description	Application	Finish	WPS#
Front Master Cylinder Cover	'96-08 Big Twins	Raw	<b>825-02010</b>
		Black	<b>825-02011</b>
		Polished	<b>825-02012</b>
		Gold	<b>825-02013</b>
		Red	<b>825-02014</b>
	'08-13 Touring	Blue	<b>825-02015</b>
		Raw	<b>825-02080</b>
		Black	<b>825-02081</b>
		Polished	<b>825-02082</b>
		Gold	<b>825-02083</b>
	'14-Up Touring	Red	<b>825-02084</b>
		Blue	<b>825-02085</b>
		Raw	<b>825-02530</b>
		Black	<b>825-02531</b>
		Polished	<b>825-02532</b>
Clutch Master Cylinder Cover	'08-Up Touring	Gold	<b>825-02533</b>
		Red	<b>825-02534</b>
		Blue	<b>825-02535</b>
		Raw	<b>825-02515</b>
		Black	<b>825-02516</b>
Rear Master Cylinder Cover	'08-Up Touring	Polished	<b>825-02517</b>
		Gold	<b>825-02518</b>
		Red	<b>825-02519</b>
		Blue	<b>825-02520</b>
		Raw	<b>825-02500</b>
	Black	<b>825-02501</b>	
	Polished	<b>825-02502</b>	
	Gold	<b>825-02503</b>	
	Red	<b>825-02504</b>	
	Blue	<b>825-02505</b>	



Raw



Black



Polished



Gold



Red



Blue







# BILLET UPPER & LOWER BRAKE CYLINDER COVERS



Ace's Wild Upper - Chrome



Ace's Wild Upper - Black



Darkside Upper - Black



Ace's Wild Lower - Chrome



Ace's Wild Lower - Black



Darkside Lower - Chrome



Darkside Lower - Black

Application		Chrome	Black
<b>UPPER MASTERCYLINDER COVER</b>			
Ace's Wild	Softail/Dyna '96-14, Touring '96-07, XL '96-03	<b>810-0163</b>	<b>810-0164</b>
Darkside	Softail/Dyna '96-14, Touring '96-07, XL '96-03	<b>810-0161</b>	<b>810-0162</b>
Ace's Wild	Touring '08-17	<b>810-0153</b>	<b>810-0154</b>
Darkside	Touring '08-17	<b>810-0151</b>	<b>810-0152</b>
Darkside	Sportster '04-13	<b>810-0171</b>	<b>810-0172</b>
<b>LOWER MASTER CYLINDER</b>			
Ace's Wild	Softail '00-17, Dyna '06-17, Touring '99-07	<b>810-0223</b>	<b>810-0224</b>
Darkside	Softail '00-17, Dyna '06-17, Touring '99-07	<b>810-0221</b>	<b>810-0222</b>
Ace's Wild	Touring '08-17	<b>810-0203</b>	<b>810-0204</b>
Darkside	Touring '08-17	<b>810-0201</b>	<b>810-0202</b>

- WINDSHIELDS / FAIRINGS
- AUDIO / COMMUNICATION
- SEATS / LUGGAGE
- BARS / MIRRORS / CONTROLS**
- EXHAUST
- AIR / FUEL SYSTEMS
- ENGINE
- TRANSMISSION / DRIVELINE
- GASKETS / SEALS
- ELECTRICAL
- LIGHTING
- CABLES
- BRAKES
- OIL FILTERS
- SUSPENSION
- BODY
- WHEELS
- TIRES / TIRE ACC.
- BIKE ACC.
- VICTORY / INDIAN
- COVERS / LOCKS / TIEDOWNS
- CHEMICALS
- TOOLS
- HELMETS
- HELMET ACC.
- EYEWEAR
- APPAREL / RIDER ACC.
- PROMOTIONAL
- REFERENCE
- INDEX



**72-81 HAND CONTROLS**



Description	WPS#
Complete Handlebar Controls w/Chrome Switches	<b>820-52900</b>
Complete Handlebar Controls w/Black Switches	<b>820-52901</b>
Complete Handlebar Controls without Switches	<b>820-52902</b>
Master Cylinder Assembly Only	<b>820-52903</b>
Clutch Perch w/Lever	<b>820-52904</b>

Description	WPS#
Clutch Perch ONLY	<b>820-52905</b>
Master Cylinder Rebuild Kit	<b>820-52906</b>
Chrome Brake Lever	<b>820-52907</b>
Chrome Clutch Lever	<b>820-52908</b>
Pin and Nylon Bushing	<b>820-52909</b>
Replacement Decals	<b>820-52910</b>
Custom Pyramid Style Switch Housing	<b>820-52911</b>

- WINDSHIELDS / FAIRINGS
- AUDIO / COMMUNICATION
- SEATS / LUGGAGE
- BARS / MIRRORS / CONTROLS**
- EXHAUST
- AIR / FUEL SYSTEMS
- ENGINE
- TRANSMISSION / DRIVELINE
- GASKETS / SEALS
- ELECTRICAL
- LIGHTING
- CABLES
- BRAKES
- OIL FILTERS
- SUSPENSION
- BODY
- WHEELS
- TIRES / TIRE ACC.
- BIKE ACC.
- VICTORY / INDIAN
- COVERS / LOCKS / TIEDOWNS
- CHEMICALS
- TOOLS
- HELMETS
- HELMET ACC.
- EYEWEAR
- APPAREL / RIDER ACC.
- PROMOTIONAL
- REFERENCE
- INDEX



# HANDLE BAR SWITCHES



820-50823



820-50826



820-50828



820-50829



820-50830



820-50834

Description	Application	WPS#
Handle Bar Horn Switch	41-64 OHV 74	<b>820-50814</b>
Rocker Switch (hi-low)	72-81 All	<b>820-50816</b>
Button Switch	72-81 All	<b>820-50817</b>
Button Cap Long	10 Pack	<b>820-50818</b>
Button Cap Short	10 Pack	<b>820-50819</b>
Stoplight Switch Front	72-81	<b>820-50820</b>
Handle Bar Switch L&R BLK	72-81	<b>820-50821</b>
Handle Bar Switch L&R CHR	72-81	<b>820-50822</b>
Chrome Rocker switch (run-off)	72-81 BLK Letters	<b>820-50823</b>
Chrome Rocker switch (plain)	72-81 w/o letters	<b>820-50824</b>
Chrome Button Caps Long	Turn Signal	<b>820-50825</b>
Dimmer/Horn Switch BLK	82-95	<b>820-50826</b>
Left Turn Signal Switch Assy. BLK	82-95	<b>820-50827</b>
Engine Start/Stop Switch Assy. BLK	82-95	<b>820-50828</b>
Right Turn Signal Switch Assy. BLK	82-95	<b>820-50829</b>
Front Stop Light Switch	82-95	<b>820-50830</b>
Dimmer/Horn Switch Chrome	82-95	<b>820-50831</b>
Left Turn Signal Switch Assy. CHR	82-95	<b>820-50832</b>
Engine Start/Stop Switch Assy. CHR	82-95	<b>820-50833</b>
Right Turn Signal Switch Assy. CHR	82-95	<b>820-50834</b>
Handle Bar Switch Left/Right CHR	82-95	<b>820-50835</b>
Handle Bar Switch Left/Right BLK	82-95	<b>820-50836</b>
Stop Light Switch	96-13	<b>820-50837</b>

# UNIVERSAL THROTTLE KITS



- Perfect for installing a push-pull S&S Super E or G carburetor on 1981 and earlier models that used an OEM pull only throttle assembly on a 1" handlebar
- Designed to work with S&S Super E and Super G carbs using the butterfly bracket
- Cables included in the kit have 90 degree elbows
- Kits include a push/pull screw in style throttle assembly for use on 1" handle bars
- Cable lengths provided with each kit include the vinyl portion of the cable and the step cap into the carb, elbows are not included in lengths
- Throttle cables have 3.75" of free length, idle cables have 4" of free length

Description	WPS#
32.5" Kit	<b>70-12790</b>
38.5" Kit	<b>70-12791</b>
42.5" Kit	<b>70-12792</b>
48.5" Kit	<b>70-12793</b>

WINDSHIELDS / FAIRINGS

AUDIO / COMMUNICATION

SEATS / LUGGAGE

BARS / MIRRORS / CONTROLS

EXHAUST

AIR / FUEL SYSTEMS

ENGINE

TRANSMISSION / DRIVELINE

GASKETS / SEALS

ELECTRICAL

LIGHTING

CABLES

BRAKES

OIL FILTERS

SUSPENSION

BODY

WHEELS

TIRES / TIRE ACC.

BIKE ACC.

VICTORY / INDIAN

COVERS / LOCKS / TIEDOWNS

CHEMICALS

TOOLS

HELMETS

HELMET ACC.

EYEWEAR

APPAREL / RIDER ACC.

PROMOTIONAL

REFERENCE

INDEX



## '82-95 STYLE HAND CONTROLS

These hand controls fit all models '82-95 and will accept the stock switches and wiring. Individual components available.

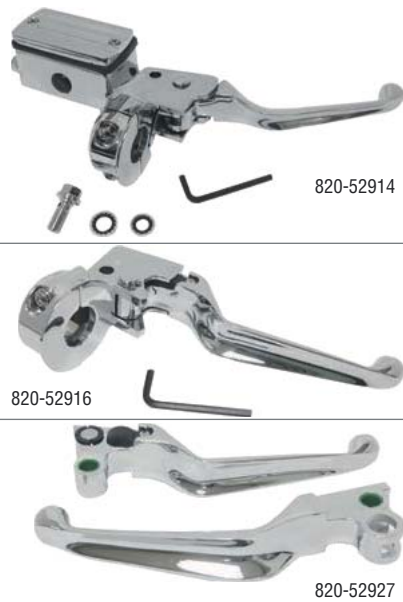
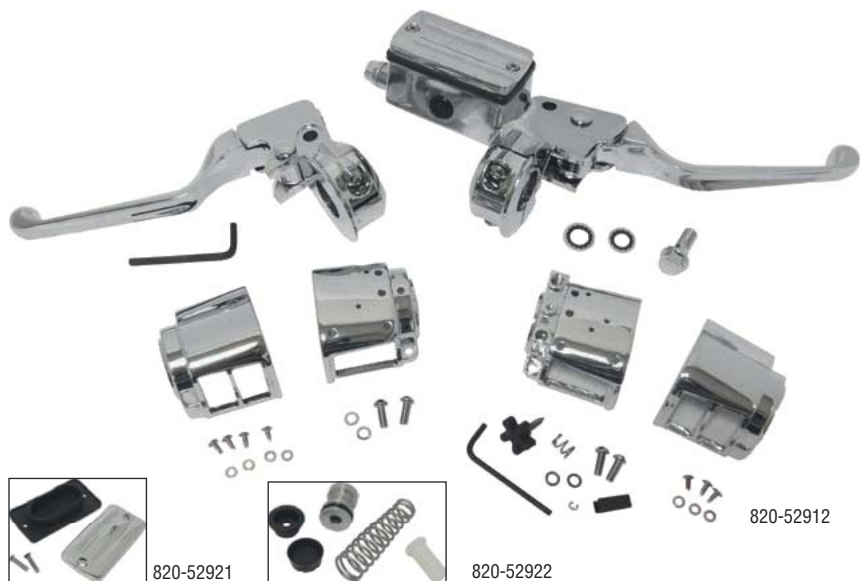

820-52921



820-52922

820-52912

820-52914

820-52916

820-52927

Description	WPS#
Handlebar Controls w/Out Switches 3/4" MC '82-83	<b>820-52912</b>
Handlebar Controls w/Out Switches 5/8" MC '84-95	<b>820-52913</b>
Master Cylinder Only 3/4"	<b>820-52914</b>
Master Cylinder Only 5/8"	<b>820-52915</b>
Clutch Perch Only	<b>820-52916</b>
Switch Housing (Bottom Left)	<b>820-52917</b>
Switch Housing (Bottom Right)	<b>820-52918</b>
Switch Housing (Top Left)	<b>820-52919</b>

Description	WPS#
Switch Housing (Top right)	<b>820-52920</b>
Master Cylinder Cover '82-95	<b>820-52921</b>
Rebuild Kit for 3/4" Master Cylinder	<b>820-52922</b>
Rebuild Kit for 5/8" Master Cylinder	<b>820-52923</b>
Clamp for Master Cylinder or Clutch Perch	<b>820-52924</b>
Brake Lever '82-95	<b>820-52925</b>
Clutch Lever '82-95	<b>820-52926</b>
Wide Blade Lever Set '82-95	<b>820-52927</b>
Nylon Pin	<b>820-52928</b>

## '96-06 HAND CONTROLS

These redesigned '96-06 hand control kits feature hidden mounting hardware on the switch housings and smoothed mounting clamps. Components are not interchangeable with OEM controls. Kits are available with or without switches. They fit all models except Touring with radio and/or cruise control function.



820-52931



820-52933

Description	WPS#
Chrome Handlebar Controls w/Switches 11/16"	<b>820-52929</b>
Chrome Handlebar Controls w/Switches 9/16"	<b>820-52930</b>
Chrome Handlebar Controls w/Out Switches 11/16"	<b>820-52931</b>

Description	WPS#
Chrome Handlebar Controls w/Out Switches 9/16"	<b>820-52932</b>
Black Handlebar Controls w/Out Switches 11/16"	<b>820-52933</b>
Black Handlebar Controls w/Out Switches 9/16"	<b>820-52934</b>

### '14-UP STYLE HAND CONTROLS

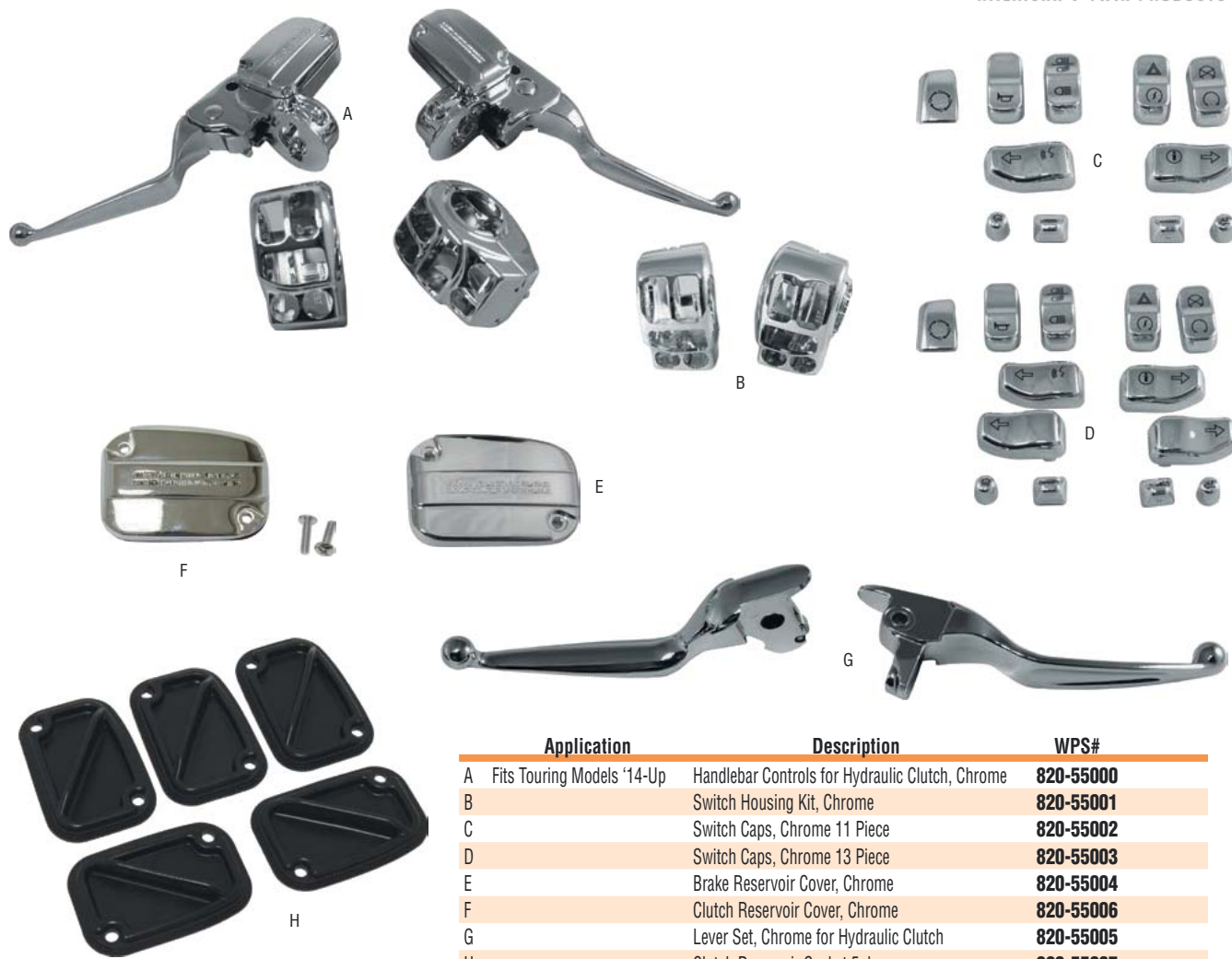

Application	Description	WPS#
A	Fits Touring Models '14-Up Handlebar Controls for Hydraulic Clutch, Chrome	820-55000
B	Switch Housing Kit, Chrome	820-55001
C	Switch Caps, Chrome 11 Piece	820-55002
D	Switch Caps, Chrome 13 Piece	820-55003
E	Brake Reservoir Cover, Chrome	820-55004
F	Clutch Reservoir Cover, Chrome	820-55006
G	Lever Set, Chrome for Hydraulic Clutch	820-55005
H	Clutch Reservoir Gasket 5pk	820-55007

### '14-UP SPORTSTER HAND CONTROLS



- These new handle bar control kits are OEM styled die-cast construction
- Available in a chrome or black finish
- Kit includes switch housings and hardware
- Uses OEM switches & wiring (not included)
- Available for single disc ABS & non-ABS models

Description	Chrome	Black
ABS models	820-54713	820-54715
NON-ABS models	820-54712	820-54714
<b>REPLACEMENT PARTS</b>		
Master cylinder rebuild kit 1/2" bore	820-51819	
Mastrecylinder rebuild kit ABS 14mm bore	820-51818	

- WINDSHIELDS / FAIRINGS
- AUDIO / COMMUNICATION
- SEATS / LUGGAGE
- BARS / MIRRORS / CONTROLS**
- EXHAUST
- AIR / FUEL SYSTEMS
- ENGINE
- TRANSMISSION / DRIVELINE
- GASKETS / SEALS
- ELECTRICAL
- LIGHTING
- CABLES
- BRAKES
- OIL FILTERS
- SUSPENSION
- BODY
- WHEELS
- TIRES / TIRE ACC.
- BIKE ACC.
- VICTORY / INDIAN
- COVERS / LOCKS / TIEDOWNS
- CHEMICALS
- TOOLS
- HELMETS
- HELMET ACC.
- EYEWEAR
- APPAREL / RIDER ACC.
- PROMOTIONAL
- REFERENCE
- INDEX

WINDSHIELDS / FAIRINGS  
 AUDIO / COMMUNICATION  
 SEATS / LUGGAGE  
**BARS / MIRRORS / CONTROLS**  
 EXHAUST  
 AIR / FUEL SYSTEMS  
 ENGINE  
 TRANSMISSION / DRIVELINE  
 GASKETS / SEALS  
 ELECTRICAL  
 LIGHTING  
 CABLES  
 BRAKES  
 OIL FILTERS  
 SUSPENSION  
 BODY  
 WHEELS  
 TIRES / TIRE ACC.  
 BIKE ACC.  
 VICTORY / INDIAN  
 COVERS / LOCKS / TIEDOWNS  
 CHEMICALS  
 TOOLS  
 HELMETS  
 HELMET ACC.  
 EYEWEAR  
 APPAREL / RIDER ACC.  
 PROMOTIONAL  
 REFERENCE  
 INDEX



## UNIVERSAL OLD SCHOOL HAND CONTROLS

- Perfect for bobbers and choppers that require minimal hand controls
- Include 9mm master cylinder for most single disc brakes
- Cable style clutch perch (may require custom made clutch cable)



Description	Chrome	Black
Universal Old School Hand Controls 9/16"	<b>820-55350</b>	<b>820-55351</b>
<b>REPLACEMENT PARTS</b>		
Rebuild Kit 9/16"	<b>820-55352</b>	

## MINI BUTTON/SWITCH KITS NEW

- Switch Kits Available in Dual or Signal Configuration Use For Horn, Starter or Turn Signal
- Clean Custom Look For 1" Handle Bars
- Individual Push Buttons can Be Mount Direct into Handle bar For the Ultimate Clean Look



Description	Chrome	Black	Bronze
Mini Push Button Switch	<b>820-50842</b>	<b>820-50841</b>	<b>820-50840</b>
<b>CUSTOM SWITCH KITS</b>			
Custom Dual Switch Kit	<b>820-50845</b>	<b>820-50843</b>	<b>820-50847</b>
Custom Single Switch Kit	<b>820-50846</b>	<b>820-50844</b>	<b>820-50848</b>

## THROTTLE CLAMPS

These universal throttle clamps are available for dual or single cable applications in chrome or gloss black finish. Throttle sleeve sold separately (WPS# 820-1709).



Description	Chrome	Black
Single Cable	<b>820-52935</b>	<b>820-52936</b>
Dual Cable	<b>820-52937</b>	<b>820-52938</b>

### CUSTOM LEVERS

**VORTEX**

**TRI-HOLE**

**5-HOLE**

**4-HOLE**

**3-SLOT**

**2-SLOT**

**SMOOTH**

Description	Application	Chrome	Black
Smooth	Touring models '17-Up (except Tri-Glide)	820-54342	820-54343
Vortex	Touring models '17-Up (except Tri-Glide)	820-54344	820-54345
Tri-Hole	Touring models '17-Up (except Tri-Glide)	820-54346	820-54347
Vortex	Touring models '14-16 (except Tri-Glide)	820-54320	820-54321
Tri-Hole	Touring models '14-16 (except Tri-Glide)	820-54322	820-54323
Four-Hole	Touring models '14-16 (except Tri-Glide)	820-54326	820-54327
Three-Slot	Touring models '14-16 (except Tri-Glide)	820-54328	820-54329
Smooth	Touring models '14-16 (except Tri-Glide)	820-54336	820-54337
Vortex	Touring models '08-13	820-54316	820-54317
Tri-Hole	Touring models '08-13	820-54318	820-54319
Four-Hole	Softails '15-Up	820-54332	820-54333
Three-Slot	Softails '15-Up	820-54334	820-54335
Smooth	Softails '15-Up	820-54330	820-54331
5-Hole	Big Twin models '07-Up (except '08-Up Touring and '15-Up Softails)	820-54306	820-54307
2-Slot	Big Twin models '07-Up (except '08-Up Touring and '15-Up Softails)	820-54304	820-54305
5-Hole	Big Twin models '96-06 and Sportster models '96-03	820-54302	820-54303
2-Slot	Big Twin models '96-06 and Sportster models '96-03	820-54300	820-54301
4-Hole	Sportster models '14-16	820-54314	820-54315
2-Slot	Sportster models '14-16	820-54312	820-54313
4-Hole	Sportster models '07-13	820-54310	820-54311
2-Slot	Sportster models '07-13	820-54308	820-54309

- WINDSHIELDS / FAIRINGS
- AUDIO / COMMUNICATION
- SEATS / LUGGAGE
- BARS / MIRRORS / CONTROLS**
- EXHAUST
- AIR / FUEL SYSTEMS
- ENGINE
- TRANSMISSION / DRIVELINE
- GASKETS / SEALS
- ELECTRICAL
- LIGHTING
- CABLES
- BRAKES
- OIL FILTERS
- SUSPENSION
- BODY
- WHEELS
- TIRES / TIRE ACC.
- BIKE ACC.
- VICTORY / INDIAN
- COVERS / LOCKS / TIEDOWNS
- CHEMICALS
- TOOLS
- HELMETS
- HELMET ACC.
- EYEWEAR
- APPAREL / RIDER ACC.
- PROMOTIONAL
- REFERENCE
- INDEX



## REPLACEMENT LEVERS

- Choose from black or chrome
- Great price and a great look



Application	Year	Color	Brake	Clutch
Touring	'08-13	A Chrome	<b>820-1511B</b>	B <b>820-1511C</b>
Touring	'08-13	C Black	<b>820-1512B</b>	D <b>820-1512C</b>
XL	'04-06	E Chrome	<b>820-1513B</b>	F <b>820-1513C</b>
XL	'07-Up	G Chrome	<b>820-1514B</b>	H <b>820-1514C</b>
<b>BRAKE AND CLUTCH SET</b>				
Big Twin and XL models	'82-95	Chrome	<b>820-54324</b>	
		Black	<b>820-54325</b>	

## WIDE V-CUT STYLE LEVERS



Application	Year	Color	Brake	Clutch
Big Twin	'96-06	A Chrome	<b>820-1515B</b>	B <b>820-1515C</b>
Big Twin	'96-06	C Black	<b>820-1516B</b>	D <b>820-1516C</b>
Dyna and Softail	'07-13 *	E Chrome	<b>820-1520B</b>	F <b>820-1515C</b>
Dyna and Softail	'07-13 *	Black	<b>820-1519B</b>	<b>820-1516C</b>
XL	'96-03	Chrome	<b>820-1515B</b>	<b>820-1515C</b>
XL	'96-03	Black	<b>820-1516B</b>	<b>820-1516C</b>
XL	'04-13	G Chrome	<b>820-1517B</b>	H <b>820-1517C</b>
XL	'04-13	I Black	<b>820-1518B</b>	J <b>820-1518C</b>

\* Except '08-Up FLHT/FLHR/FLTR/FLHX/HD FL Trike

+ Except '04-Up XL & '08-Up FLT models





### '14-UP SPORTSTER LEVERS



OEM style replacement levers for 2014 and later Sportster models, available in chrome or black finish.

Application	Year	Chrome	Black
XL	'14-UP	<b>820-55050</b>	<b>820-55051</b>

Description	Application	Year	WPS#
A Pivot Pin w/Nylon Bushing Set	Big Twins, Sportsters	88-Up	<b>820-1501</b>
B Chrome Pivot Pin w/clips 10pk	All	'82-Up	<b>820-1502</b>

### WIDE BLADE LEVERS



- Manufactured to OEM specifications
- Available in chrome or polished
- Sold each or in sets
- Replaces Harley Davidson OEM #'s 45017-93 (clutch) and 45016-96 (brake)

Application	Year	Chrome Clutch	Polished Clutch	Chrome Brake	Polished Brake
<b>HARLEY DAVIDSON</b>					
Big Twin models	'96-06	<b>56-9755C</b>	<b>56-9755P</b>	<b>56-9756C</b>	<b>56-9756P</b>
Sportster models	'96-03	<b>56-9755C</b>	<b>56-9755P</b>	<b>56-9756C</b>	<b>56-9756P</b>



### WIDE BLADE LEVERS SETS

Application	Year	Chrome Set	Polished Set
<b>HARLEY DAVIDSON</b>			
Big Twin	'96-06	<b>56-9750C</b>	<b>56-9750P</b>
Sportster	'96-03	<b>56-9750C</b>	<b>56-9750P</b>

\* Upgrade for OEM non-wide blade levers

### ANTHEM ADJUSTABLE LEVERS



- CNC machined levers easily adjust to rider's preference with a dial
- Available in black, chrome or black machine cut finish
- Sold in pairs

Application	Finish	WPS#
Touring models '17-UP	Chrome	<b>581-8904</b>
Touring models '14-16	Black	<b>581-8903</b>
	Chrome	<b>581-8913</b>
	Black Machined	<b>581-8914</b>
Touring models '08-13	Black	<b>581-8915</b>
	Chrome	<b>581-8916</b>
	Black Machined	<b>581-8917</b>
Big Twin models '96-15 XL '96-03 (except 08-Up Touring '15-UP Softail)	Black	<b>581-8910</b>
	Chrome	<b>581-8911</b>
	Black Machined	<b>581-8912</b>

- WINDSHIELDS / FAIRINGS
- AUDIO / COMMUNICATION
- SEATS / LUGGAGE
- BARS / MIRRORS / CONTROLS
- EXHAUST
- AIR / FUEL SYSTEMS
- ENGINE
- TRANSMISSION / DRIVELINE
- GASKETS / SEALS
- ELECTRICAL
- LIGHTING
- CABLES
- BRAKES
- OIL FILTERS
- SUSPENSION
- BODY
- WHEELS
- TIRES / TIRE ACC.
- BIKE ACC.
- VICTORY / INDIAN
- COVERS / LOCKS / TIEDOWNS
- CHEMICALS
- TOOLS
- HELMETS
- HELMET ACC.
- EYEWEAR
- APPAREL / RIDER ACC.
- PROMOTIONAL
- REFERENCE
- INDEX



**STAR SERIES HANDGUARDS FOR H-D** **NEW**

- A great alternative to costly heated grips
- Protect your hands from road debris and that cold winter chill
- On those hot summer days just simply pop off the featured vent cover to allowing the wind to cool off your hands while cruising down the highway
- Protect yourself while giving your ride a little more attitude



A



B



C



D



Hi-Flow vents



E



F



Snap out removable vent cover



G



H

Description	WPS#
A Matte Black	18-95083
B Black/Black	18-95084
C Silver/Black	18-95060
D Yellow/Black	18-95061
E Red/Blk	18-95062
F Green/Black	18-95063
G Blue/Black	18-95064
H Orange/Black	18-95065
I White/Black	18-95066
J Yellow/Black	18-95080



I



J

**HANDGUARD MOUNTS FOR H-D** **NEW**

- Easily add handguard style and functionality to your Harley with the Star Series Harley Davidson Mount Kits
- Each kit works with the PowerMadd Star Series handguards
- Mounting brackets are CNC machined from 6061 billet aluminum and anodized in a black finish

NOTES: Models with turn signals mounted to stock controls will require a turn signal relocation kit not supplied in this kit

† Models w/ mechanical clutch

\* Models w/ hydraulic clutch



18-95087



18-95086



18-95091

Application	Year	WPS#
Touring	'96-07	18-95087
	'08-13 †	18-95086
	'14-16 *	18-95091
	'17-Up	18-95092
Softail	'96-14	18-95087
Dyna	'96-16	18-95087
Sportster	'96-03	18-95087



## HAND DEFLECTORS

- Hand Deflectors are an economical, easy-to-install solution for keeping your hands warm and dry
- Coupled with a windshield, Hand Deflectors protect your entire upper body from cold wind and rain
- Mounts easily and securely to bike's mirror mounts, yet allows plenty of room for brake/clutch lever movement
- Made from High Impact Acrylic, with mounting hardware in chromed steel and black powder coated steel



562-30430



562-30431



562-30408

Harley Davidson	Year	WPS#
<b>TOURING</b>		
All models (except listed below)	'60-16	<b>562-30430</b>
<b>FL SOFTTAILS</b>		
FLST/FLSTC/FLSTN	'86-16	<b>562-30430</b>
FLSTF/FLSTS/FLSTSB	'90-11	<b>562-30431</b>
<b>FX SOFTTAILS</b>		
All models (except listed below)	'87-12	<b>562-30431</b>
FXSTB	'99-09	<b>562-30430</b>

Harley Davidson	Year	WPS#
<b>DYNA/FXR</b>		
All models (except listed below)	'70-16	<b>562-30431</b>
FLD	'12-16	<b>562-30430</b>
<b>SPORTSTERS</b>		
All models	'04-16	<b>562-30433</b>
	'83-03	<b>562-30431</b>
XL1200R/XL883R	'02	<b>562-30433</b>
<b>INDIAN</b>		
Scout	'15-16	<b>562-30408</b>



With spoiler



Without spoiler



## X-FORCE HANDGUARDS

- The X-Force with removable spoiler, offers excellent protection from rocks, roost and harsh weather conditions
- Remove the spoiler for more ventilation or use in less harsh conditions
- Universal mounting kit allows handguards to be mounted above or below levers and cables
- Spoiler and mount kits included

Color	WPS #
Black	<b>21703-20001</b>
White	<b>21703-20002</b>
Blue	<b>21703-20003</b>
Red	<b>21703-20004</b>
Yellow	<b>21703-20005</b>
Green	<b>21703-20006</b>
Pink	<b>21703-20026</b>
Orange	<b>21703-20036</b>
Replacement Mount kit	<b>21703-30001</b>

- WINDSHIELDS / FAIRINGS
- AUDIO / COMMUNICATION
- SEATS / LUGGAGE
- BARS / MIRRORS / CONTROLS
- EXHAUST
- AIR / FUEL SYSTEMS
- ENGINE
- TRANSMISSION / DRIVELINE
- GASKETS / SEALS
- ELECTRICAL
- LIGHTING
- CABLES
- BRAKES
- OIL FILTERS
- SUSPENSION
- BODY
- WHEELS
- TIRES / TIRE ACC.
- BIKE ACC.
- VICTORY / INDIAN
- COVERS / LOCKS / TIEDOWNS
- CHEMICALS
- TOOLS
- HELMETS
- HELMET ACC.
- EYEWEAR
- APPAREL / RIDER ACC.
- PROMOTIONAL
- REFERENCE
- INDEX



## VISION HANDGUARDS

The Vision Handguard is an innovative guard, fitted with adjustable LED lights (LED for low power consumption), giving you effective, additional light for extreme conditions. The handguard is mounted to the end of the bar and has an on/off switch, which can also be mounted on the handlebars. A great solution for an off road bike, atv, or dual road. Comes complete with a universal mount kit.



Color	WPS#
Black	23677-00001



## HAND GUARDS NEW

- Made of gel coated fiberglass, ready for paint
- Brackets and mounting hardware included
- May require relocation of turn signals on some models

Description	Application	WPS#
Hand Guards	'91-17 FXD, '82-94 FXR, '82-03 XL	750-01090



- WINDSHIELDS / FAIRINGS
- AUDIO / COMMUNICATION
- SEATS / LUGGAGE
- BARS / MIRRORS / CONTROLS**
- EXHAUST
- AIR / FUEL SYSTEMS
- ENGINE
- TRANSMISSION / DRIVELINE
- GASKETS / SEALS
- ELECTRICAL
- LIGHTING
- CABLES
- BRAKES
- OIL FILTERS
- SUSPENSION
- BODY
- WHEELS
- TIRES / TIRE ACC.
- BIKE ACC.
- VICTORY / INDIAN
- COVERS / LOCKS / TIEDOWNS
- CHEMICALS
- TOOLS
- HELMETS
- HELMET ACC.
- EYEWEAR
- APPAREL / RIDER ACC.
- PROMOTIONAL
- REFERENCE
- INDEX

# FORWARD CONTROLS



## '00-12 SOFTTAIL (EXCEPT DEUCE / ROCKER MODELS)

Description	Color	WPS#
Forward control kit with rubber pegs and brake pedal, 5/8" bore	Chrome Billet	820-0532



## '91-UP ALL DYNA GLIDE

Description	Application	WPS#
Forward control kit with chrome mounting plates, ribbed foot and shifter pegs	'91-07	820-0531
Forward control kit with chrome mounting plates, w/out pegs	'06-Up	820-55600
Forward control kit with black mounting plates, w/out pegs	'06-Up	820-55601
Extension Kit 2" Forward Chrome		820-55602
Extension Kit 2" Forward Black		820-55603



## '04-13 XL



Description	Color	WPS#
A Forward control kit with rubber band style footpeg	Chrome	820-0530C
B Forward control kit with rubber band style footpeg	Black	820-0530B

- WINDSHIELDS / FAIRINGS
- AUDIO / COMMUNICATION
- SEATS / LUGGAGE
- BARS / MIRRORS / CONTROLS
- EXHAUST
- AIR / FUEL SYSTEMS
- ENGINE
- TRANSMISSION / DRIVELINE
- GASKETS / SEALS
- ELECTRICAL
- LIGHTING
- CABLES
- BRAKES
- OIL FILTERS
- SUSPENSION
- BODY
- WHEELS
- TIRES / TIRE ACC.
- BIKE ACC.
- VICTORY / INDIAN
- COVERS / LOCKS / TIEDOWNS
- CHEMICALS
- TOOLS
- HELMETS
- HELMET ACC.
- EYEWEAR
- APPAREL / RIDER ACC.
- PROMOTIONAL
- REFERENCE
- INDEX

- WINDSHIELDS / FAIRINGS
- AUDIO / COMMUNICATION
- SEATS / LUGGAGE
- BARS / MIRRORS / CONTROLS**
- EXHAUST
- AIR / FUEL SYSTEMS
- ENGINE
- TRANSMISSION / DRIVELINE
- GASKETS / SEALS
- ELECTRICAL
- LIGHTING
- CABLES
- BRAKES
- OIL FILTERS
- SUSPENSION
- BODY
- WHEELS
- TIRES / TIRE ACC.
- BIKE ACC.
- VICTORY / INDIAN
- COVERS / LOCKS / TIEDOWNS
- CHEMICALS
- TOOLS
- HELMETS
- HELMET ACC.
- EYEWEAR
- APPAREL / RIDER ACC.
- PROMOTIONAL
- REFERENCE
- INDEX



## LATE XL FORWARD CONTROLS



TC Bros. Choppers bolt on forward controls to fit all 883 and 1200 Sportster models from 2004-2013 proudly made in the USA!

Kit features CNC machined 6061 aluminum folding footpegs with a knurled, non slip finish for great looks and performance. Heavy duty steel mounting brackets are TIG welded and powdercoated satin black for durability. Stainless steel linkage rods provide smooth shifting and corrosion resistance. Highly detailed mounting instructions allow for simple installation. All pivot points utilize oil impregnated, precision fit bronze bushings for long life. Foot position is the same as a set of OEM Harley forward controls for an all around, comfortable ride.



Application	Description	WPS#
A '04-13 XL Models	Forward Controls	563-01006
B	Forward Controls (No Pegs)	563-01007

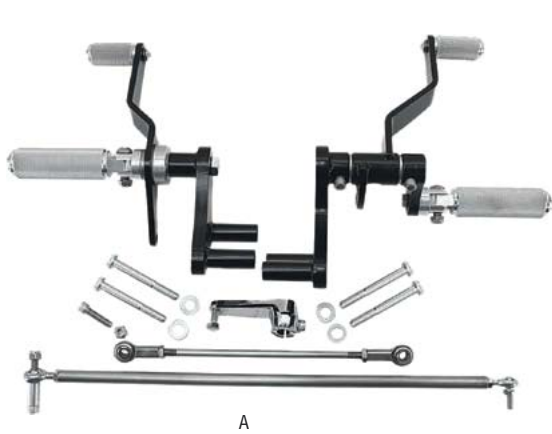

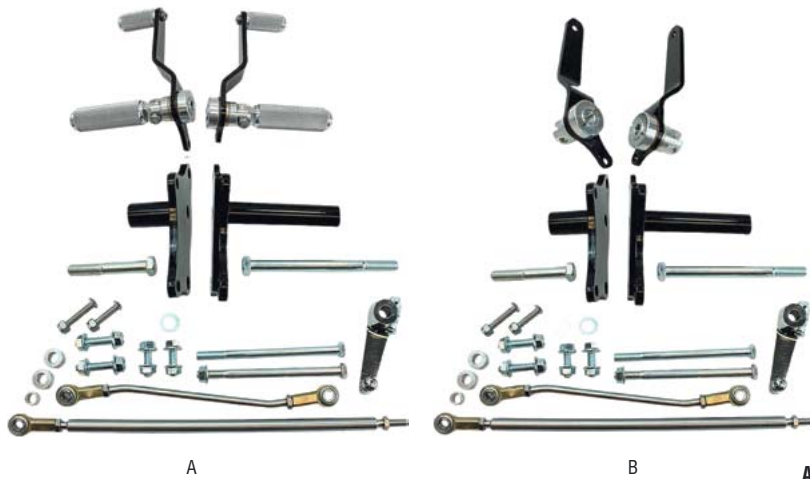

## XL FORWARD CONTROLS

USA made bolt on forward control kit features CNC machined 6061 aluminum folding footpegs with a knurled, non slip finish for great looks and performance. Heavy duty steel mounting brackets are TIG welded and powdercoated gloss black for a highly durable finish. Kit includes detailed mounting instructions, stainless steel linkage rods, as well as everything your need to bolt these to your Sportster, whether it came with factory mid controls or factory forward controls. All pivot points utilize oil impregnated, precision fit bronze bushings for long life. Foot position is the same as a set of OEM Harley forward controls for an all around, comfortable ride.

Application	Description	WPS#
A 91-03 XL Models	Forward Controls	563-01004
B	Forward Controls (without pegs)	563-01005



## UNIVERSAL REARSETS

Loaded Gun Customs aluminum universal fit, bolt on rearsets by TC Bros. Choppers. Can fit virtually any bike if you make mounts and shift/brake linkage rods. Rearsets feature CNC machined 6061 aluminum pegs with precision fit oil impregnated bronze bushings. Each lightweight rearset weighs only 9oz. The pegs are knurled for extra grip. They also include stainless steel mounting bolts that thread into the pegs. Universal linkage kits are not included. These are perfect for Cafe Racer styled bikes and are proudly made in the USA!

Application	WPS#	
Custom Applications	563-01003	

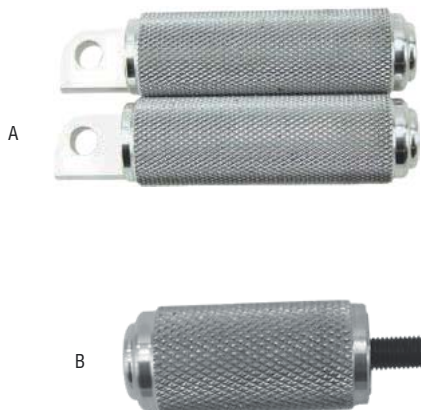

## NOMAD FOOT AND SHIFT PEGS

TC Bros. Nomad Foot Pegs mount directly to your stock Harley female foot peg mounts. Great for use on late-model Harley-Davidson forward controls or even mid-control replacements. High quality, non-slip, knurled finish pegs are CNC machined with a radius end for great looks. Proudly made in the USA! These are also direct replacements for TC Bros. Harley forward control kits.

Application	Description	WPS#
A Fits HD Female Peg Mounts	Nomad Foot Pegs	563-01020
B	Nomad Shift Peg	563-01021

- WINDSHIELDS / FAIRINGS
- AUDIO / COMMUNICATION
- SEATS / LUGGAGE
- BARS / MIRRORS / CONTROLS**
- EXHAUST
- AIR / FUEL SYSTEMS
- ENGINE
- TRANSMISSION / DRIVELINE
- GASKETS / SEALS
- ELECTRICAL
- LIGHTING
- CABLES
- BRAKES
- OIL FILTERS
- SUSPENSION
- BODY
- WHEELS
- TIRES / TIRE ACC.
- BIKE ACC.
- VICTORY / INDIAN
- COVERS / LOCKS / TIEDOWNS
- CHEMICALS
- TOOLS
- HELMETS
- HELMET ACC.
- EYEWEAR
- APPAREL / RIDER ACC.
- PROMOTIONAL
- REFERENCE
- INDEX



## UNIVERSAL FORWARD CONTROL KITS

- Universal forward controls available with and without mounting kit
- Kit includes a pair of universal forward controls and material to make mounts for them
- They can be used to fit virtually any bike
- CNC machined aluminum pegs (knurled for extra grip)
- The mounting plates are 5/16" thick raw steel and the spacers are heavy duty 1/4" wall seamless DOM steel tubing
- You can make bolt on mounts or just weld them to your frame
- Custom shapes can be cut for the unique look that you are going for
- Perfect for custom choppers and bobbers or even stock bikes!
- **KIT INCLUDES:** two 24" Long 5/16" threaded rods, four 5/16" ball joints, two 5/16" ID x 1/2" OD steel tubes\* (to cover rod threads and increase rigidity), eight 5/16" jam nuts, four nylock nuts, and four flat washers.



A



B



C

	Description	WPS#
A	Universal Linkage Kit	* 563-01000
B	Universal Forward Controls	563-01001
C	Universal Forward Controls with Mounting Kit	563-01002

\*The universal linkage kit includes the rods and tubes, they will need to be cut to fit your application





## SPORTSTER MID-CONTROLS

Kit features CNC machined 6061 aluminum folding footpegs with a knurled, non slip finish for great looks and performance. A version without pegs is also available. Heavy duty steel mounting brackets are TIG welded and powdercoated satin black for a highly durable finish. Highly detailed mounting instructions are included for easy installation. All pivot points utilize oil impregnated, precision fit bronze bushings for long life. Foot position is the same as a set of OEM Harley mid controls for an all around, comfortable ride. Proudly made in the USA!



Application	Description	WPS#
Fits XL Models '91-03	Mid Controls	<b>563-01009</b>
	Mid Controls, no pegs	<b>563-01008</b>



## SPORTSTER FORWARD CONTROL EXTENSIONS

These +6" forward control extension plates are machined from 6061 T-6 billet aluminum and powder coated gloss black to match your frame. The shift & brake rods are polished stainless steel. They bolt to the frame where the stock Sportster forward controls mount. The shift & brake arms as well as the foot pegs then mount 6" forward from the stock location helping people with a long inseam stretch out.



Description	Application	WPS#
Forward Control Extensions +6"	'04-13 XL Models	<b>811-20100</b>
	'14-Up XL Models	<b>811-20101</b>

- WINDSHIELDS / FAIRINGS
- AUDIO / COMMUNICATION
- SEATS / LUGGAGE
- BARS / MIRRORS / CONTROLS
- EXHAUST
- AIR / FUEL SYSTEMS
- ENGINE
- TRANSMISSION / DRIVELINE
- GASKETS / SEALS
- ELECTRICAL
- LIGHTING
- CABLES
- BRAKES
- OIL FILTERS
- SUSPENSION
- BODY
- WHEELS
- TIRES / TIRE ACC.
- BIKE ACC.
- VICTORY / INDIAN
- COVERS / LOCKS / TIEDOWNS
- CHEMICALS
- TOOLS
- HELMETS
- HELMET ACC.
- EYEWEAR
- APPAREL / RIDER ACC.
- PROMOTIONAL
- REFERENCE
- INDEX

- WINDSHIELDS / FAIRINGS
- AUDIO / COMMUNICATION
- SEATS / LUGGAGE
- BARS / MIRRORS / CONTROLS**
- EXHAUST
- AIR / FUEL SYSTEMS
- ENGINE
- TRANSMISSION / DRIVELINE
- GASKETS / SEALS
- ELECTRICAL
- LIGHTING
- CABLES
- BRAKES
- OIL FILTERS
- SUSPENSION
- BODY
- WHEELS
- TIRES / TIRE ACC.
- BIKE ACC.
- VICTORY / INDIAN
- COVERS / LOCKS / TIEDOWNS
- CHEMICALS
- TOOLS
- HELMETS
- HELMET ACC.
- EYEWEAR
- APPAREL / RIDER ACC.
- PROMOTIONAL
- REFERENCE
- INDEX



## RAISED MID CONTROLS

Raise the pegs on your Sporty or Dyna up for an ultra cool look, and more cornering clearance. Use OEM or custom pegs (not included). Moves the pegs up 4" and back 1.5" on Dynas. Moves the pegs up 2.5" and back 1.5" on Sportster models (compared to OEM mid controls).



High Mid Control

High Mid Control



750-02000



750-02001



750-02002



750-02003

Application	Description	WPS#
Fits '04-13 XL Models	High Mid Controls	<b>750-02000</b>
Fits '14-Up XL Models	High Mid Controls for Mid Control Models	<b>750-02001</b>
	High Mid Controls for Forward Control Models	<b>750-02002</b>
Fits '06-Up Dynas	High Mid Controls	<b>750-02003</b>



## HARDDRIVE FOOTPEGS

- Machined from billet aluminum
- Available in chrome or black finish
- Made in the USA
- Fit all HD models (except Sportster 48)
- Sold in pairs

Description	Black	Chrome
A Shock Footpeg Set	820-4021	820-4022
B Dash Footpeg Set	820-4023	820-4024
C Throttle Footpeg Set	820-4025	820-4026



A



B



C

## HARDDRIVE SHIFTPEGS

- Designed to match our HardDrive foot pegs
- Made in the USA
- Sold each



A



B



C

Description	Black	Chrome
A Shock Shiftpeg	820-4001	820-4002
B Dash Shiftpeg	820-4003	820-4004
C Throttle Shiftpeg	820-4005	820-4006

- WINDSHIELDS / FAIRINGS
- AUDIO / COMMUNICATION
- SEATS / LUGGAGE
- BARS / MIRRORS / CONTROLS**
- EXHAUST
- AIR / FUEL SYSTEMS
- ENGINE
- TRANSMISSION / DRIVELINE
- GASKETS / SEALS
- ELECTRICAL
- LIGHTING
- CABLES
- BRAKES
- OIL FILTERS
- SUSPENSION
- BODY
- WHEELS
- TIRES / TIRE ACC.
- BIKE ACC.
- VICTORY / INDIAN
- COVERS / LOCKS / TIEDOWNS
- CHEMICALS
- TOOLS
- HELMETS
- HELMET ACC.
- EYEWEAR
- APPAREL / RIDER ACC.
- PROMOTIONAL
- REFERENCE
- INDEX



### VENOM FOOTPEGS

- Made of billet aluminum
- Non-slip grip rubber
- Fit all HD models equipped with male mount foot pegs (except XL 1200X)
- Sold in pairs



Description	Chrome	Black
Raw Cut	820-54802	820-54810
Shot Peened	820-54806	820-54814
Replacement Rubber	820-54817	

### VENOM SHIFT/BRAKE PEGS

- Designed to match HardDrive Venom foot pegs
- Sold as each



Description	Chrome	Black
Raw Cut	820-54803	820-54811
Shot Peened	820-54807	820-54815
Replacement Rubber	820-54818	

### O-RING FOOTPEGS



Description	Application	Mount Type	OE Ref. #	WPS#
A Rider Footpeg set w/ 5/8" mount pr.	'52-'91 FL, FX & XL	Female	52651-85T	820-1941
Rider Footpeg set pr.	'82-UP FXR, '91-UP XL	Male		820-1943
B Passenger Footpeg set pr.	'65-'84 FL, '72-UP FX, '79-UP XL	Male	50901-84T	820-1942

### CUSTOM RAIL FOOTPEGS



Description	Application	Mount	WPS#
A Rider Footpegs	'52-Up Harleys	Female	820-1946
B Rider Footpegs	'80-UP FLST, FXR, FXWR & '91-UP XL	Male	820-1947
Passenger Footpegs	'65-'84 FL, '72-UP FX, '79-UP XL & 79-UP FX, XL highway bars	Male	820-1948

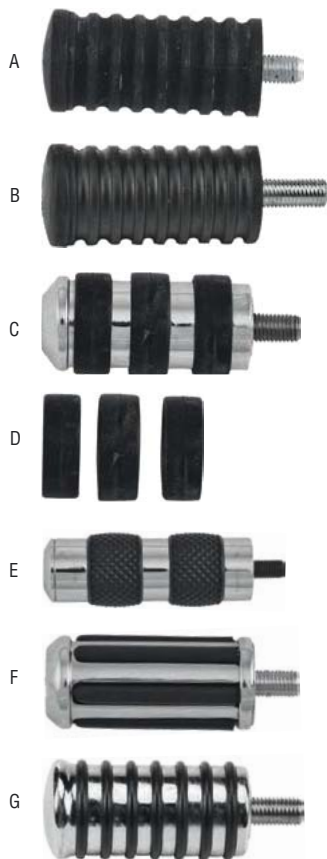

### SHIFT PEGS

- Shifter Pegs Fits all Harleys
- Comfort-Ride Style are Standard Length with 3 rubber bends
- Novibe Comfort Shifter Peg is w/ 1/2" stud, fits 41-UP all Harley Models
- Rail Shift Peg is w/ 1/2" short stud , fits 41-UP all Harley Models
- O-Ring Style - Cushioned Neoprene O-Ring W/Short Stud 1/2", fits 41-UP all Harleys

	Description	Application	OE Ref. #	WPS#
A	1/2" Short Stud Ribbed Rubber Shift Peg	All HDs	34611-65	<b>820-1900</b>
B	3/4" Long Stud Ribbed Rubber Shift Peg	All HDs	34609-52	<b>820-1901</b>
C	1/2" Short Stud Comfort Ride Style Shift Peg	All HDs		<b>820-1904</b>
D	3/pc Rubber replacement	Comfort-Ride Style		<b>820-1904R</b>
E	1/2" Short Stud NoVibe Comfort Shift Peg	'41-Up All HDs		<b>820-1906</b>
F	1/2" Short Stud Rail Style Shift Peg	'41-Up All HDs		<b>820-1909</b>
G	1/2" Short Stud O-Ring Shift Peg	'41-Up All HDs		<b>820-1908</b>

### COMFORT-RIDE FOOT PEGS

Comfort-Ride Footpegs - Chromed comfort-ride footpegs include the replacement hollow core, long lasting neoprene insert, Cleats are isolate mounted on a socket head bolt

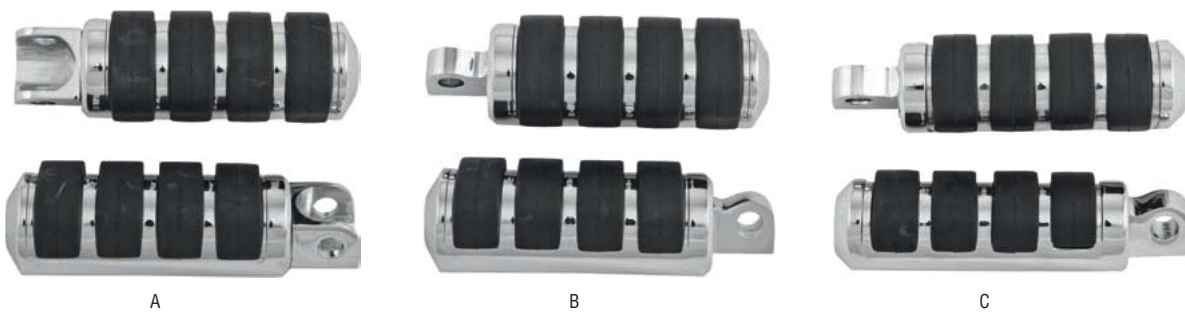

	Description	Application	WPS#
<b>FEMALE MOUNT</b>			
A	Rider Footpegs	'41-Up Harley Models	<b>820-1934</b>
<b>MALE MOUNTS</b>			
B	Rider Footpegs	'80-UP FXR, FXST	<b>820-1935</b>
C	Passenger Footpegs	'72-UP, FX, XL	<b>820-1936</b>
D	No-Vibe Comfort Rider Footpegs	All Harley Models	<b>820-1960</b>
E	Rubber Inserts for Rider Footpegs	8 pcs	<b>820-1937</b>
	Rubber Inserts for Passenger Footpegs	8 pcs	<b>820-1938</b>

WINDSHIELDS / FAIRINGS  
 AUDIO / COMMUNICATION  
 SEATS / LUGGAGE  
**BARS / MIRRORS / CONTROLS**  
 EXHAUST  
 AIR / FUEL SYSTEMS  
 ENGINE  
 TRANSMISSION / DRIVELINE  
 GASKETS / SEALS  
 ELECTRICAL  
 LIGHTING  
 CABLES  
 BRAKES  
 OIL FILTERS  
 SUSPENSION  
 BODY  
 WHEELS  
 TIRES / TIRE ACC.  
 BIKE ACC.  
 VICTORY / INDIAN  
 COVERS / LOCKS / TIEDOWNS  
 CHEMICALS  
 TOOLS  
 HELMETS  
 HELMET ACC.  
 EYEWEAR  
 APPAREL / RIDER ACC.  
 PROMOTIONAL  
 REFERENCE  
 INDEX



# FOOT PEGS



- Match your foot pegs to your Avon grips and shift/brake pegs! Manufactured from 6061 aluminum, Avon foot pegs can be used in place of the rider or folding passenger foot pegs.
- Fits all Harley Davidson models except the 2012 Sportster 48.
- Sold in pairs.

Description	Black	Chrome
A Air Cushioned	<b>40-4303BK</b>	<b>40-4303C</b>
B Air Cushioned Excalibur	<b>40-4253BK</b>	<b>40-4253C</b>
C Air Cushioned Gatlin	<b>40-4254BK</b>	<b>40-4254C</b>
D Air Cushioned Rival	<b>40-4255BK</b>	<b>40-4255C</b>
E Air Cushioned Castle	<b>40-4268BK</b>	<b>40-4268C</b>
F Air Cushioned Deep Cut	<b>40-4269BK</b>	<b>40-4269C</b>
G Air Cushioned Slots	<b>40-4270BK</b>	<b>40-4270C</b>
H Air Cushioned Elite	<b>40-4271BK</b>	<b>40-4271C</b>
I Air Gel	<b>40-4259BK</b>	<b>40-4259C</b>

Description	Black	Chrome
J Custom Contour	<b>40-4300BK</b>	<b>40-4300C</b>
K Custom Contour Excalibur	<b>40-4250BK</b>	<b>40-4250C</b>
L Custom Contour Gatlin	<b>40-4251BK</b>	<b>40-4251C</b>
M Custom Contour Rival	<b>40-4252BK</b>	<b>40-4252C</b>
N Custom Contour Spike	<b>40-4301BK</b>	<b>40-4301C</b>
O Velvet Air	<b>40-4304BK</b>	<b>40-4304C</b>
P Velvet Air Excalibur	<b>40-4256BK</b>	<b>40-4256C</b>
Q Velvet Air Gatlin	<b>40-4257BK</b>	<b>40-4257C</b>
R Velvet Air Rival	<b>40-4258BK</b>	<b>40-4258C</b>

Black

Chrome

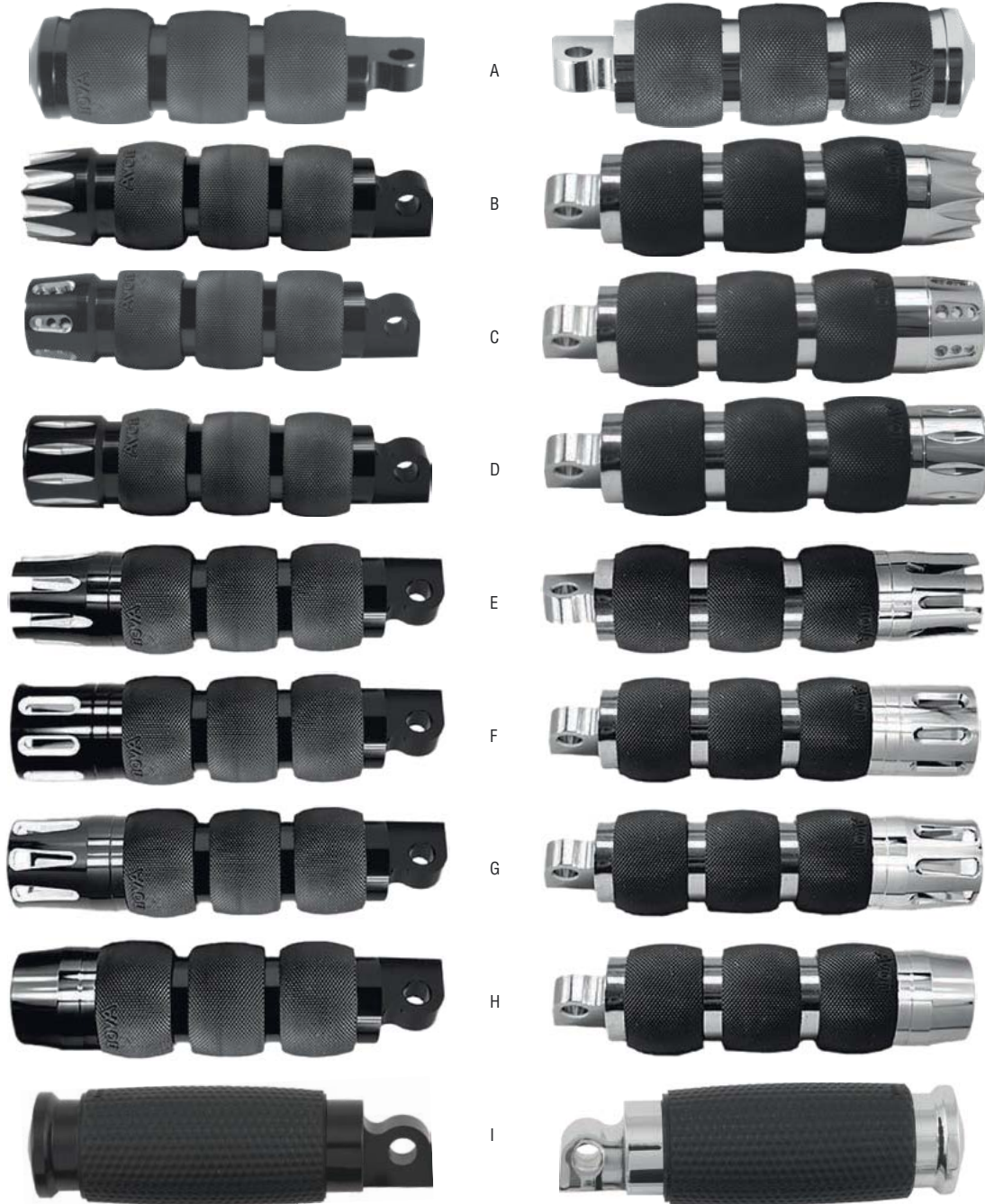

**FOOT PEGS**



Black

Chrome

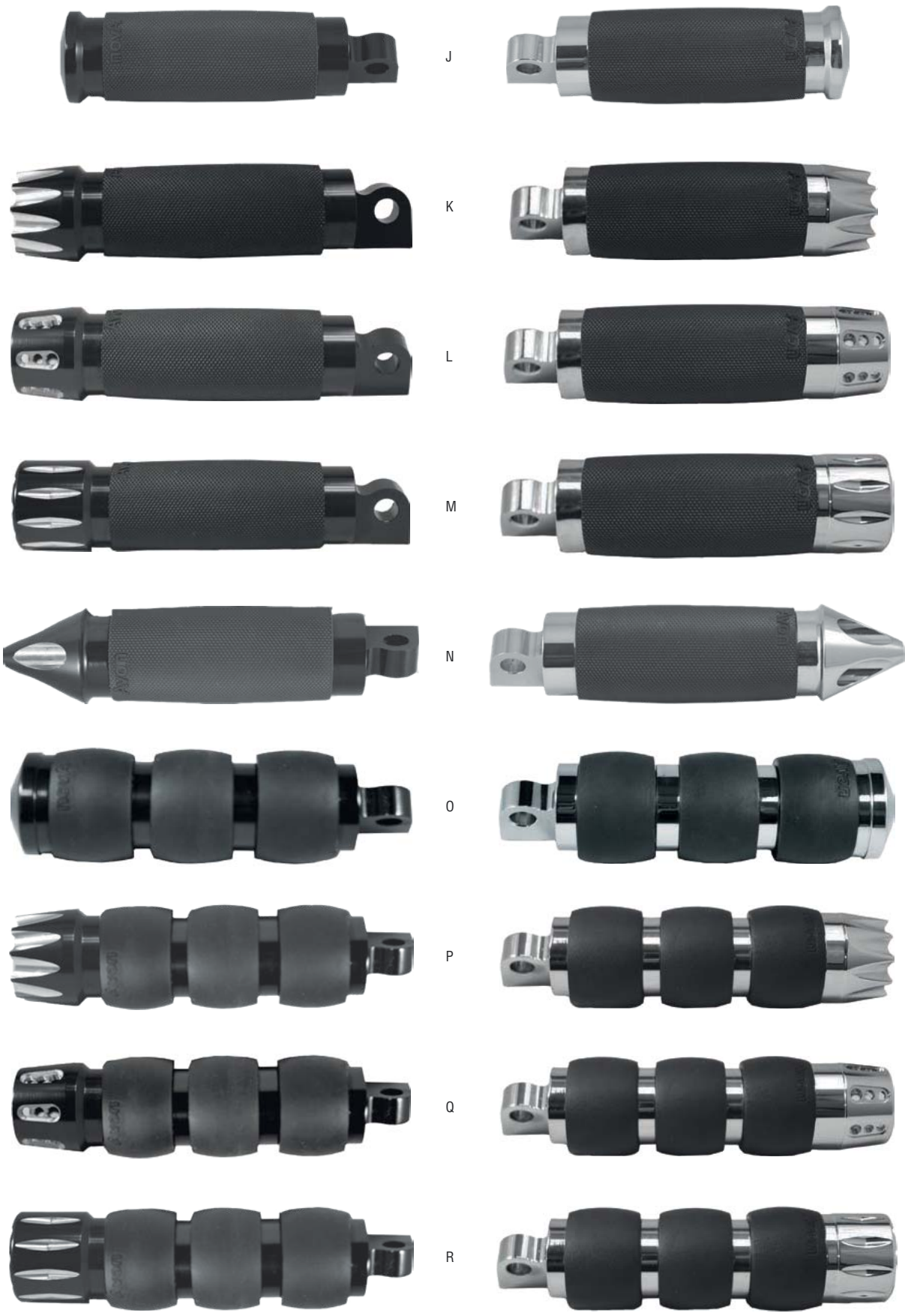

J  
K  
L  
M  
N  
O  
P  
Q  
R

WINDSHIELDS / FAIRINGS
AUDIO / COMMUNICATION
SEATS / LUGGAGE
<b>BARS / MIRRORS / CONTROLS</b>
EXHAUST
AIR / FUEL SYSTEMS
ENGINE
TRANSMISSION / DRIVELINE
GASKETS / SEALS
ELECTRICAL
LIGHTING
CABLES
BRAKES
OIL FILTERS
SUSPENSION
BODY
WHEELS
TIRES / TIRE ACC.
BIKE ACC.
VICTORY / INDIAN
COVERS / LOCKS / TIEDOWNS
CHEMICALS
TOOLS
HELMETS
HELMET ACC.
EYEWEAR
APPAREL / RIDER ACC.
PROMOTIONAL
REFERENCE
INDEX



# SHIFTER / BRAKE PEG



- Match your brake and shifter pegs to your Avon grips and foot pegs!
- Each peg is manufactured from 6061 aluminum. Fits all Harley Davidson models with 5/16"-24 threaded brake/shifter pegs
- Sold each

Description	Black	Chrome
A Air Cushioned	40-4313BK	40-4313C
B Air Cushioned Excalibur	40-4603BK	40-4603C
C Air Cushioned Gatlin	40-4604BK	40-4604C
D Air Cushioned Rival		40-4605C
E Air Cushioned Castle	40-4272BK	40-4272C
F Air Cushioned Deep Cut	40-4273BK	40-4273C
G Air Cushioned Slots	40-4274BK	40-4274C
H Air Cushioned Elite	40-4275BK	40-4275C
I Air Gel	40-4609BK	40-4609C

Description	Black	Chrome
J Custom Contour	40-4310BK	40-4310C
K Custom Contour Excalibur	40-4600BK	40-4600C
L Custom Contour Gatlin	40-4601BK	40-4601C
M Custom Contour Rival		40-4602C
N Custom Contour Spike	40-4311BK	40-4311C
O Velvet Air	40-4314BK	40-4314C
P Velvet Air Excalibur	40-4606BK	40-4606C
Q Velvet Air Gatlin		40-4607C
R Velvet Air Rival	40-4608BK	40-4608C





**SHIFTER / BRAKE PEG**



Black

Chrome

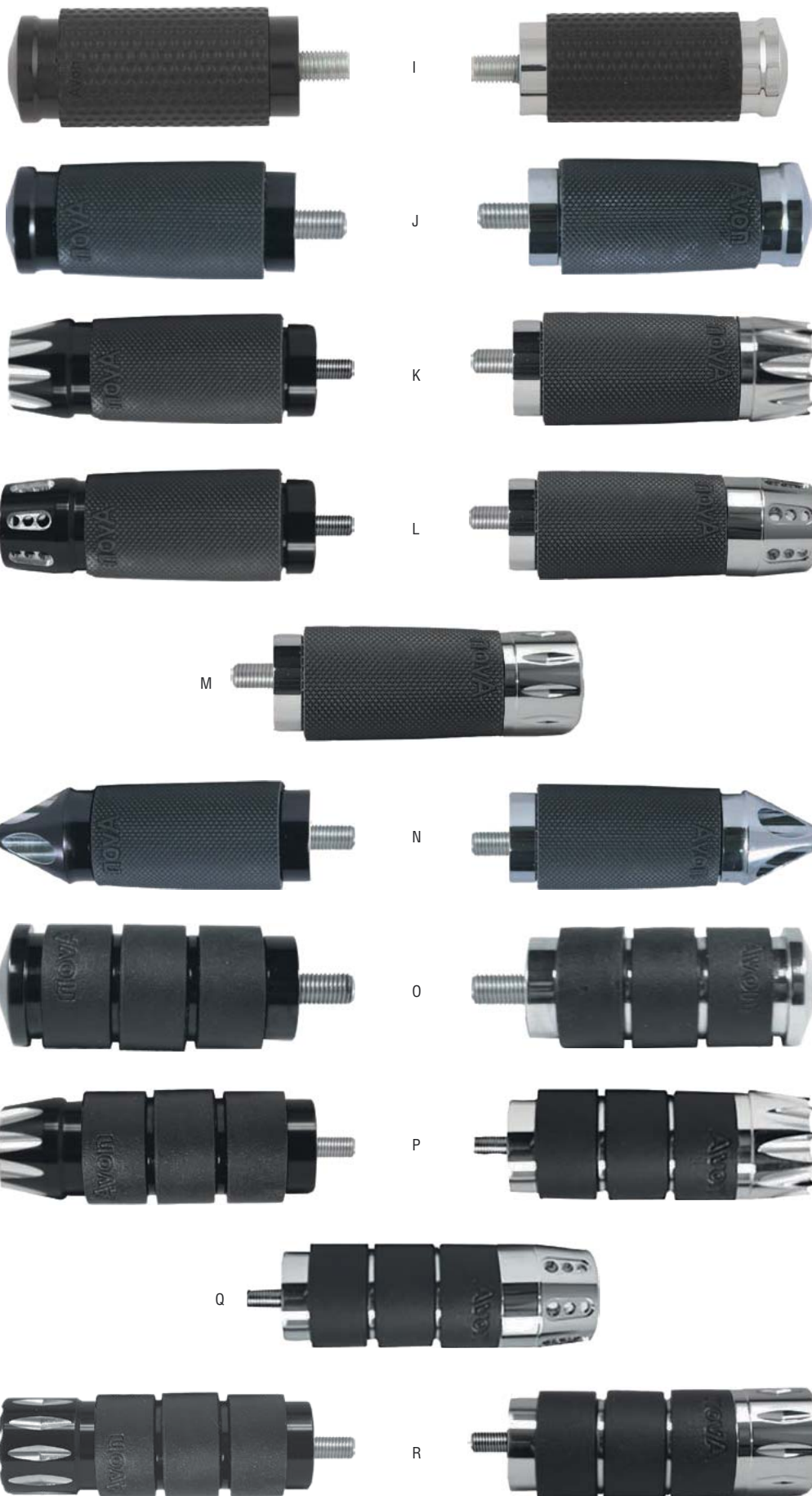

- WINDSHIELDS / FAIRINGS
- AUDIO / COMMUNICATION
- SEATS / LUGGAGE
- BARS / MIRRORS / CONTROLS**
- EXHAUST
- AIR / FUEL SYSTEMS
- ENGINE
- TRANSMISSION / DRIVELINE
- GASKETS / SEALS
- ELECTRICAL
- LIGHTING
- CABLES
- BRAKES
- OIL FILTERS
- SUSPENSION
- BODY
- WHEELS
- TIRES / TIRE ACC.
- BIKE ACC.
- VICTORY / INDIAN
- COVERS / LOCKS / TIEDOWNS
- CHEMICALS
- TOOLS
- HELMETS
- HELMET ACC.
- EYEWEAR
- APPAREL / RIDER ACC.
- PROMOTIONAL
- REFERENCE
- INDEX



## ARGYLE FOOT PEGS

- These new custom pegs are machined from billet 6061-T6 aluminum
- Available in Chrome, Gloss black- raw cut & Matt black SP finish
- The moto peg designed diamond pattern is machined into the contact area which gives a non slip platform in any condition
- Pegs are available in both 45° & Straight mount
- Sold in pairs

Description	Finish	WPS#
A 45° Male peg mount set	Chrome	820-54822
45° Male peg mount set	Gloss Black raw cut	820-54823
B 45° Male peg mount set	Matte Black	820-54824
C Straight male mount set	Chrome	820-54819
D Straight male mount set	Gloss Black raw cut	820-54820
E Straight male mount set	Matte Black	820-54821



A



B



C



D



E

## FOOTPEG REPLACEMENT PARTS

- Replacement pins and d-clips for OE and aftermarket footpegs.

Description	WPS#
Footpeg Mounting Pins for 1" Wide Peg Mounts 10/pk	820-52501
Footpeg Mounting Pins for 15/16" Wide Peg Mounts 10/pk	820-52502
Footpeg Spring Washers 10/pk	820-52507



- WINDSHIELDS / FAIRINGS
- AUDIO / COMMUNICATION
- SEATS / LUGGAGE
- BARS / MIRRORS / CONTROLS**
- EXHAUST
- AIR / FUEL SYSTEMS
- ENGINE
- TRANSMISSION / DRIVELINE
- GASKETS / SEALS
- ELECTRICAL
- LIGHTING
- CABLES
- BRAKES
- OIL FILTERS
- SUSPENSION
- BODY
- WHEELS
- TIRES / TIRE ACC.
- BIKE ACC.
- VICTORY / INDIAN
- COVERS / LOCKS / TIEDOWNS
- CHEMICALS
- TOOLS
- HELMETS
- HELMET ACC.
- EYEWEAR
- APPAREL / RIDER ACC.
- PROMOTIONAL
- REFERENCE
- INDEX



## FOOT PEGS NEW

### BBMX PEGS

These pegs are designed with you in mind. Kick ass design with high functionality. Precision machined from aircraft grade 6061 T6 billet aluminum and anodized. Included with adjustable chrome plated steel clevis. They are light weight and strong. The outermost edge is tapered underside to optimize lean angle on BBMX and Meat Hooks with Brass Balls logo located on the underside.

- BBMX pegs measurements: 3.5" L x 2.5" W x 1" H
- Meat Hooks pegs measurements: 4.40" L x 2.5" W x 1.01" H
- Muzzle Break pegs measurements: 4.06" L x 1.38" W x 1.14" T



### KNEE DRAGGER PEGS

### MEAT HOOKS PEGS

### MUZZLE BREAK PEGS



Description	Black	Clear	Gold	Red
BMX Style	826-01020	826-01021	826-01022	826-01023
Knee Dragger	826-01024	826-01025	826-01026	-
Meat Hooks	826-01027	826-01028	-	826-01029
Muzzle Break	826-01034	826-01033	-	-

## SHIFT PEGS NEW

- These simple beauties replace the boring stock toe pegs. They are machined from aircraft grade billet aluminum and are available in various finishes.
- Sold individually. 5/16 -24 x 1 1/2 stainless bolt included



Description	Black	Clear
Ribbed	826-01052	826-01051
Street	826-01053	826-01054

- WINDSHIELDS / FAIRINGS
- AUDIO / COMMUNICATION
- SEATS / LUGGAGE
- BARS / MIRRORS / CONTROLS**
- EXHAUST
- AIR / FUEL SYSTEMS
- ENGINE
- TRANSMISSION / DRIVELINE
- GASKETS / SEALS
- ELECTRICAL
- LIGHTING
- CABLES
- BRAKES
- OIL FILTERS
- SUSPENSION
- BODY
- WHEELS
- TIRES / TIRE ACC.
- BIKE ACC.
- VICTORY / INDIAN
- COVERS / LOCKS / TIEDOWNS
- CHEMICALS
- TOOLS
- HELMETS
- HELMET ACC.
- EYEWEAR
- APPAREL / RIDER ACC.
- PROMOTIONAL
- REFERENCE
- INDEX



## MOTO STYLE PEGS

- Machined from 7075 T6 aluminum, highly durable and light weight
- Peg measures 2" X 3.125"
- Replaceable stainless steel cleats for extra grip and an aggressive look
- Can be rotated to any angle then locked down with stainless steel hardware (included)

### FOOTPEGS



### SHIFTER PEGS



Description	Silver	Black	Flat Black	Red	Gold
Moto Style Footpeg Set	122-8060	122-8061	122-8063	122-8062	122-8067
Moto Style Shifter Pegs	122-8064	122-8065		122-8066	122-8068
Replacement Cleat Set	122-8050				

## BMX STYLE PEGS



Made from highly durable 6061 T6 aluminum alloy. These pegs measure 3.5" long and 2.7" wide making them almost 1/4" longer and 1/2" wider than the FLO Moto style pegs for added comfort. The larger, flat replaceable cleats give added grip without chewing up footwear.

Description	Silver	Black
BMX Style Footpeg Set	122-8081	122-8080





**ADJUSTABLE SHIFT & BRAKE ARMS**



- Machined from 7075 T6 aluminum, extremely durable and light weight
- Perfect addition to the FLO Moto or BMX style pegs with the matching toe peg
- Three position adjustable for optimal reach of the peg



122-8200



122-8201



122-8202



122-8203



122-8204



122-8205



122-8206

Application	Black
<b>ADJUSTABLE SHIFT LEVERS</b>	
FXD Models '91-17 w/Mid Controls	<b>122-8205</b>
FXR Models '84-94 and '99 w/Mid Controls	<b>122-8206</b>
XL Models '91-03 w/Mid Controls	<b>122-8204</b>

Application	Black
<b>ADJUSTABLE BRAKE LEVERS</b>	
FXD Models '91-17 w/Mid Controls	<b>122-8202</b>
FXR Models '84-94 and '99 w/Mid Controls	<b>122-8203</b>
XL Models '87-03 w/Mid Controls	<b>122-8201</b>
XL Models '04-13 w/Mid Controls	<b>122-8200</b>



- WINDSHIELDS / FAIRINGS
- AUDIO / COMMUNICATION
- SEATS / LUGGAGE
- BARS / MIRRORS / CONTROLS**
- EXHAUST
- AIR / FUEL SYSTEMS
- ENGINE
- TRANSMISSION / DRIVELINE
- GASKETS / SEALS
- ELECTRICAL
- LIGHTING
- CABLES
- BRAKES
- OIL FILTERS
- SUSPENSION
- BODY
- WHEELS
- TIRES / TIRE ACC.
- BIKE ACC.
- VICTORY / INDIAN
- COVERS / LOCKS / TIEDOWNS
- CHEMICALS
- TOOLS
- HELMETS
- HELMET ACC.
- EYEWEAR
- APPAREL / RIDER ACC.
- PROMOTIONAL
- REFERENCE
- INDEX



## ADJUSTABLE HIGHWAY PEG MOUNTS

- Fit 1-1/4" engine guards
- Available in chrome or gloss black
- Long and short reach versions available
- Offer full adjustability for optimum peg position
- Work with most male mount pegs (sold separately)



Description	Chrome	Black
Long Adjustable Peg Mounts	820-55260	820-55261
Short Adjustable Peg Mounts	820-55262	820-55263

## FOOTPEG MOUNT CLAMPS

- Requires 3/8" x 1- 1/2" thru bolt to mount pegs

Description	WPS#
A 1- 1/4" Bar Male End Footpegs	820-1962
B 1- 1/2" Bar Male End Footpegs	820-1963



## PASSENGER PEG MOUNTS

- Passenger Peg mounts, fits 06-15 FXD

Description	WPS#
Black Passenger Peg Mounts	820-1966
Chrome Passenger Peg Mounts	820-1967



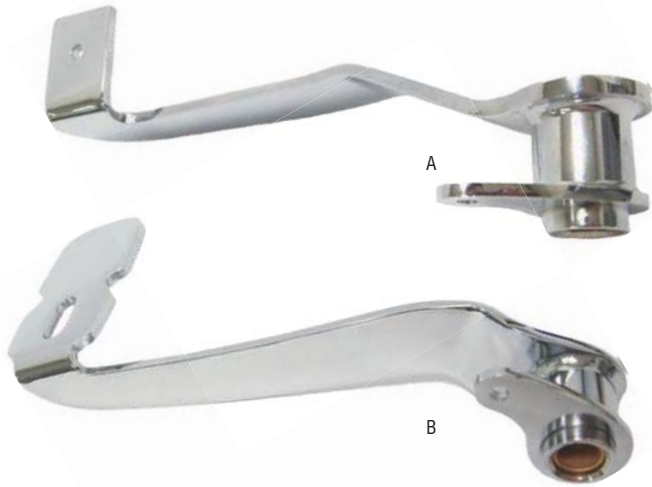

## BRAKE ARMS

- Flawlessly chrome plated replica of the OEM brake arm
- Adjustable version available for some models, allows the rider to adjust pedal reach

	Description	Application	WPS#
A	Brake Arm Chrome	FXST 00-06	<b>820-70010</b>
B	Brake Arm Chrome	FLST 00-06	<b>820-70011</b>
	Adjustable Brake Arm Chrome	FLST 91-99, FLT 96-13	<b>820-70012</b>
		FLST 00-03	<b>820-70013</b>

## BRAKE PEDAL PADS

- Replacement brake pedal pads and rubbers for various applications
- 820-70230 offers a larger surface than stock pad
- 820-70231 can also be used on foot clutches

	Description	Application	WPS#
	Brake Pedal Pad Kit	Most Big Twins 65-86 & 86-87 FLST	<b>820-70230</b>
A	Brake Pedal Pad only	84-Up FLT, 87-Up FLST	<b>820-70231</b>
B	Brake Pedal Pad Small	FXST, FXDWG 84-Up	<b>820-70232</b>
C	Brake Pedal Rubber Early Models	4-Speed FL models	<b>820-70233</b>
D	Brake Pedal Pad 3 line OEM style	'80-17 Touring, '86-12 Softail, and '12 FLD models	<b>820-2628</b>



- WINDSHIELDS / FAIRINGS
- AUDIO / COMMUNICATION
- SEATS / LUGGAGE
- BARS / MIRRORS / CONTROLS**
- EXHAUST
- AIR / FUEL SYSTEMS
- ENGINE
- TRANSMISSION / DRIVELINE
- GASKETS / SEALS
- ELECTRICAL
- LIGHTING
- CABLES
- BRAKES
- OIL FILTERS
- SUSPENSION
- BODY
- WHEELS
- TIRES / TIRE ACC.
- BIKE ACC.
- VICTORY / INDIAN
- COVERS / LOCKS / TIEDOWNS
- CHEMICALS
- TOOLS
- HELMETS
- HELMET ACC.
- EYEWEAR
- APPAREL / RIDER ACC.
- PROMOTIONAL
- REFERENCE
- INDEX



## TOE PEGS & SLIDERS

- Choose from various color options
- Used to customize the appearance of Cycle Pirates levers
- Hardware included

- WINDSHIELDS / FAIRINGS
- AUDIO / COMMUNICATION
- SEATS / LUGGAGE
- BARS / MIRRORS / CONTROLS**
- EXHAUST
- AIR / FUEL SYSTEMS
- ENGINE
- TRANSMISSION / DRIVELINE
- GASKETS / SEALS
- ELECTRICAL
- LIGHTING
- CABLES
- BRAKES
- OIL FILTERS
- SUSPENSION
- BODY
- WHEELS
- TIRES / TIRE ACC.
- BIKE ACC.
- VICTORY / INDIAN
- COVERS / LOCKS / TIEDOWNS
- CHEMICALS
- TOOLS
- HELMETS
- HELMET ACC.
- EYEWEAR
- APPAREL / RIDER ACC.
- PROMOTIONAL
- REFERENCE
- INDEX

Description	WPS#
<b>TOE PEGS</b>	
Chrome	811-50020
Black	811-50021
Orange	811-50022
Blue	811-50023
Red	811-50024
<b>SLIDERS</b>	
Chrome	811-50040
Black	811-50041
Orange	811-50042



## SHORT FOOT PEGS

- CNC machined two piece design
- 4-1/2" long and 1-3/4" diameter
- Anti sag set screw enables adjustment of peg angle

Description	WPS#
Black	811-50070
Chrome	811-50071

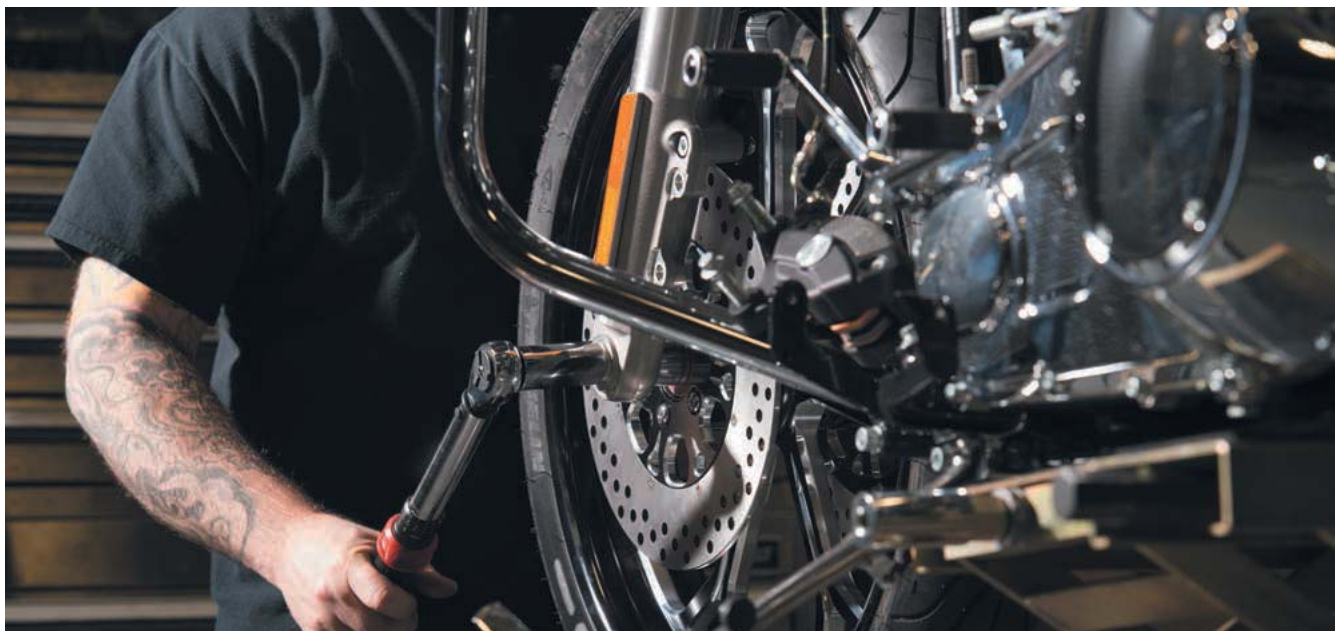





## ADJUSTABLE SHIFT/BRAKE ARMS

- 8 Position adjustable CNC billet shift and brake levers
- Allows for approximately 2 inch extension or 1 inch reduction of reach
- Sliders and toe pegs in different color options available
- Includes knurled toe peg (2-3/4" x 1"), thread lock and hardware

### ADJUSTABLE SHIFT LEVERS



811-50000



811-50002



811-50008



811-50001



811-50003



811-50009

### ADJUSTABLE BRAKE LEVERS



811-50004



811-50006



811-50005



811-50007



811-50060



811-50062



811-50061



811-50063

Application	Black	Chrome
<b>ADJUSTABLE SHIFT LEVERS</b>		
FXD Models '91-14 w/Mid Controls	<b>811-50000</b>	<b>811-50001</b>
FXR Models '84-94 and '99 w/Mid Controls	<b>811-50002</b>	<b>811-50003</b>
XL Models '91-03 w/Mid Controls	<b>811-50008</b>	<b>811-50009</b>
<b>ADJUSTABLE BRAKE LEVERS</b>		
FXD Models '91-14 w/Mid Controls	<b>811-50004</b>	<b>811-50005</b>
FXR Models '84-94 and '99 w/Mid Controls	<b>811-50006</b>	<b>811-50007</b>
XL Models '87-03 w/Mid Controls	<b>811-50060</b>	<b>811-50061</b>
XL Models '04-13 w/Mid Controls	<b>811-50062</b>	<b>811-50063</b>

- WINDSHIELDS / FAIRINGS
- AUDIO / COMMUNICATION
- SEATS / LUGGAGE
- BARS / MIRRORS / CONTROLS**
- EXHAUST
- AIR / FUEL SYSTEMS
- ENGINE
- TRANSMISSION / DRIVELINE
- GASKETS / SEALS
- ELECTRICAL
- LIGHTING
- CABLES
- BRAKES
- OIL FILTERS
- SUSPENSION
- BODY
- WHEELS
- TIRES / TIRE ACC.
- BIKE ACC.
- VICTORY / INDIAN
- COVERS / LOCKS / TIEDOWNS
- CHEMICALS
- TOOLS
- HELMETS
- HELMET ACC.
- EYEWEAR
- APPAREL / RIDER ACC.
- PROMOTIONAL
- REFERENCE
- INDEX



## SHIFT COVERS

- These handy spacers cover up the exposed part of the shift shaft when the heel shifter is removed
- Made from billet aluminum and show chrome plated

Description	WPS#
<b>SHIFT SHAFT COVERS ALL FLT/FLHT/FLSTF</b>	
A Top Hat	850-05070
B Stepped	850-05071
C Warrior	850-05072
<b>HEEL SHIFT ELIMINATOR SPACER 84-08 FLT/FLHT</b>	
D Warrior	850-05075
E Nasty	850-05076
<b>HEEL SHIFT ELIMINATOR SPACER 03-06 FLSTF</b>	
Warrior	850-05073
Nasty	850-05074
<b>SHAFT COVER (ON FLOORBOARD MOUNT) 03-06 FLSTF</b>	
F Warrior	850-05077
G Nasty	850-05078
<b>SHAFT COVER (ON FLOORBOARD MOUNT) 04-06 FLST ONLY</b>	
Warrior	850-05079
Nasty	850-05080



A B



C D E



F G



## HEEL SHIFT ELIMINATOR

- CNC Machined 6061 aluminum
- For use when the heel shift arm is not used on Touring models
- Teflon bushing
- Six different anodized colored options
- Made in the USA

Description	Application	Finish	WPS#
Heel Shift Eliminator	'86-Up FLH/FLT and FLST	Raw	825-02040
		Black	825-02041
		Polished	825-02042
		Gold	825-02043
		Red	825-02044
		Blue	825-02045



## HEEL SHIFT ELIMINATOR



The heel shifter eliminator is used to space the toe shift arm outward when you are removing the heel shifter. These heel shifter eliminators are machined from 6061 T-6 billet aluminum. They are available in either a brilliant chrome plated finish or in black anodized with machined accents.

Description	Chrome	Black
A Grooved	811-20170	811-20171
B Diamond	811-20172	811-20173
C Smooth	811-20174	811-20175





## BRAKE ARMS



- CNC Machined 6061 aluminum
- Replaces OEM brake Lever
- Six color options available
- Toe peg sold separately
- Made in the USA



Description	Application	Raw	Black	Polished	Gold	Red	Blue
Brake Arm	'97-07 Touring Models	825-02050	825-02051	825-02052			
	'08-13 Touring Models	825-02053	825-02054	825-02055	825-02056	825-02057	825-02058
	'14-Up Touring Models	825-02059	825-02060	825-02061	825-02062	825-02063	825-02064

## KNURLED SHIFT PEGS



- CNC Machined 6061 aluminum
- Knurled design
- Six different anodized colored options
- Sold each
- Made in the USA
- Peg is 2" long
- Extension spacer available separately



Description	Application	Finish	WPS#
Knurled Toe Peg	Universal	Raw	825-02220
		Black	825-02221
		Polished	825-02222
		Gold	825-02223
		Red	825-02224
		Blue	825-02225

## SHIFT PEG SPACERS



- CNC Machined 6061 aluminum
- Extends reach of toe peg 1/2"
- Extended hardware sold separately
- Made in the USA

Description	Application	Finish	WPS#
Toe Peg Spacer	Universal	Raw	825-02216
		Black	825-02217
		Polished	825-02218

- WINDSHIELDS / FAIRINGS
- AUDIO / COMMUNICATION
- SEATS / LUGGAGE
- BARS / MIRRORS / CONTROLS**
- EXHAUST
- AIR / FUEL SYSTEMS
- ENGINE
- TRANSMISSION / DRIVELINE
- GASKETS / SEALS
- ELECTRICAL
- LIGHTING
- CABLES
- BRAKES
- OIL FILTERS
- SUSPENSION
- BODY
- WHEELS
- TIRES / TIRE ACC.
- BIKE ACC.
- VICTORY / INDIAN
- COVERS / LOCKS / TIEDOWNS
- CHEMICALS
- TOOLS
- HELMETS
- HELMET ACC.
- EYEWEAR
- APPAREL / RIDER ACC.
- PROMOTIONAL
- REFERENCE
- INDEX

- WINDSHIELDS / FAIRINGS
- AUDIO / COMMUNICATION
- SEATS / LUGGAGE
- BARS / MIRRORS / CONTROLS**
- EXHAUST
- AIR / FUEL SYSTEMS
- ENGINE
- TRANSMISSION / DRIVELINE
- GASKETS / SEALS
- ELECTRICAL
- LIGHTING
- CABLES
- BRAKES
- OIL FILTERS
- SUSPENSION
- BODY
- WHEELS
- TIRES / TIRE ACC.
- BIKE ACC.
- VICTORY / INDIAN
- COVERS / LOCKS / TIEDOWNS
- CHEMICALS
- TOOLS
- HELMETS
- HELMET ACC.
- EYEWEAR
- APPAREL / RIDER ACC.
- PROMOTIONAL
- REFERENCE
- INDEX



R O C K

## SHIFT RODS

- Fits Touring models '99-16 and others with 11-1/4" shift rod
- Works with OEM shift rod ends
- CNC Machined 6061 aluminum
- Six different anodized colored options
- Made in the USA

Application	Finish	WPS#
'99-18 FLT	Raw	<b>825-02150</b>
	Black	<b>825-02151</b>
	Polished	<b>825-02152</b>
	Gold	<b>825-02153</b>
	Red	<b>825-02154</b>
	Blue	<b>825-02155</b>





### BILLET BRAKE LEVER

- Precision Billet is proud to release our brake lever that's compatible for Harley Davidson motorcycles
- Our designers not only added style but also ensured that the lever did not sacrifice any foot surface or change the pivot point of your foot
- Replacing the brake lever is a quick install
- Available in our hard Black anodized contrast cut or our show chrome finish

Application	Year	Description	WPS#
<b>HARLEY DAVIDSON</b>			
Touring models	'08-Up	Bad Axe Chrome	<b>810-0605</b>
Touring models	'08-Up	Bad Axe Black A	<b>810-0606</b>
Touring models	'08-Up	Dark Side Chrome B	<b>810-0601</b>
Touring models	'08-Up	Dark Side Black	<b>810-0602</b>
Touring models	'08-Up	Ace's Wild Chrome	<b>810-0603</b>
Touring models	'08-Up	Ace's Wild Black C	<b>810-0604</b>



### BILLET BRAKE LEVER PAD

- Another finishing touch item for your bike
- Our Darkside brake pedal cover is a direct replacement for your stock Harley pad-style brake pedal
- Hand-crafted from solid 6061 billet aluminum
- Available in our show chrome or black anodized contrast cut finishes

Application	Description	WPS#
<b>HARLEY DAVIDSON</b>		
'84-Up Touring and '86-Up FL Softail models	Ace's Wild Black A	<b>810-0633</b>
	Dark Side Black B	<b>810-0632</b>
	Dark Side Chrome C	<b>810-0631</b>



### BILLET HEEL / TOE SHIFTER

- Our toe shifter is compatible with Harley Davidson motorcycles
- CNC milled shifter lever
- Replacing the shifter lever is a quick install
- Available in our hard black anodized contrast cut or our show chrome finish

Application	Year	Description	WPS#
<b>HARLEY DAVIDSON</b>			
Touring models	All	Bad Axe Chrome	<b>810-0655</b>
Touring models	All	Bad Axe Black A	<b>810-0656</b>
Touring models	All	Ace's Wild Black B	<b>810-0654</b>
Touring models	All	Ace's Wild Chrome	<b>810-0653</b>
Touring models	All	Dark Side Black C	<b>810-0652</b>
Touring models	All	Dark Side Chrome	<b>810-0651</b>



### BILLET SHIFT LINKAGE

- CNC milled, 6061 T6 Billet Aluminum Shift Linkage
- The linkage is fully adjustable and includes heim joints and all mounting hardware
- The custom crafted piece is available in our Black anodized contrast cut or show chrome finish

Application	Year	Description	WPS#
<b>HARLEY DAVIDSON</b>			
Touring models	All	Ace's Wild Black A	<b>810-0454</b>
Touring models	All	Ace's Wild Chrome	<b>810-0453</b>
Touring models	All	Dark Side Black B	<b>810-0452</b>
Touring models	All	Dark Side Chrome	<b>810-0451</b>
Sportsters	'04-Up	Sportster Dark Side Black	<b>810-0472</b>
Sportsters	'04-Up	Sportster Dark Side Chrome C	<b>810-0471</b>

WINDSHIELDS / FAIRINGS

AUDIO / COMMUNICATION

SEATS / LUGGAGE

**BARS / MIRRORS / CONTROLS**

EXHAUST

AIR / FUEL SYSTEMS

ENGINE

TRANSMISSION / DRIVELINE

GASKETS / SEALS

ELECTRICAL

LIGHTING

CABLES

BRAKES

OIL FILTERS

SUSPENSION

BODY

WHEELS

TIRES / TIRE ACC.

BIKE ACC.

VICTORY / INDIAN

COVERS / LOCKS / TIEDOWNS

CHEMICALS

TOOLS

HELMETS

HELMET ACC.

EYEWEAR

APPAREL / RIDER ACC.

PROMOTIONAL

REFERENCE

INDEX

- WINDSHIELDS / FAIRINGS
- AUDIO / COMMUNICATION
- SEATS / LUGGAGE
- BARS / MIRRORS / CONTROLS**
- EXHAUST
- AIR / FUEL SYSTEMS
- ENGINE
- TRANSMISSION / DRIVELINE
- GASKETS / SEALS
- ELECTRICAL
- LIGHTING
- CABLES
- BRAKES
- OIL FILTERS
- SUSPENSION
- BODY
- WHEELS
- TIRES / TIRE ACC.
- BIKE ACC.
- VICTORY / INDIAN
- COVERS / LOCKS / TIEDOWNS
- CHEMICALS
- TOOLS
- HELMETS
- HELMET ACC.
- EYEWEAR
- APPAREL / RIDER ACC.
- PROMOTIONAL
- REFERENCE
- INDEX



## INNER SHIFT LEVER

Accutronix "Diamond" FLH shift arm replaces the stock H-D # 33718-82B lever, gear shifter. The shift rod attaches to the top & the bottom attaches to the splined shift shaft.

Application	Description	Black	Chrome
'86-14 FLH/FLT	Inner Shift Lever	<b>811-20160</b>	<b>811-20161</b>



811-20160 811-20161



## BAGGER FORWARD CONTROLS

Diamond "Nights Series" Forward Controls include rigid "Billet & Rubber" foot & toe peg. They use the factory master cylinder. Installation instructions and mounting hardware is included as required. These forward controls are machined from 6061 T-6 Billet Aluminum and are available in chrome or black anodized and machine cut finish.



Description	Application	Black	Chrome
Forward Controls	'97-08 Touring Models	<b>811-20134</b>	<b>811-20135</b>
	'09-13 Touring Models	<b>811-20136</b>	<b>811-20137</b>
	'14-Up Touring Models	<b>811-20138</b>	<b>811-20139</b>

NOTE: '97-08 version will not fit with factory crash bar.

## SOFTAIL FORWARD CONTROLS

Diamond "Nights Series" Forward Controls include rigid "Billet & Rubber" foot & toe pegs. Installation instructions and mounting hardware is included as required. Machined from 6061 T-6 Billet Aluminum.



Description	Application	Black	Chrome
Forward Controls	'84-99 Softail Models	<b>811-20130</b>	<b>811-20131</b>
	'00-Up Softail Models	<b>811-20132</b>	<b>811-20133</b>

NOTE: May require a custom brake hose with a 3/8"-24 (10mm) 35° banjo fitting at the master cylinder. 2000-2006 bikes require a EVO style kick stand bracket, 2007-Up bikes require a EVO style kick stand assembly.

## MASTER CYLINDERS

These 5/8" bore master cylinders are manufactured from 6061 T-6 Billet Aluminum. The brake hose attaches to the inside front using a 3/8"-24, 10 mm banjo bolt. They have two 5/16"-18 threaded holes 2-1/8" apart for mounting. These are also a replacement master cylinders for all Accutronix Softail forward controls.

Description	Application	Black	Chrome
5/8" Master Cylinder	Universal	<b>811-20210</b>	<b>811-20211</b>



811-20210 811-20211



### BRAKE ARMS

Accutronix "Diamond" FLH brake arm replaces the stock arm and comes with a decorative cap to conceal the mounting hardware. These brake arms match the Accutronix Heal-Toe shifters & Toe-Only shifters. Toe pegs sold separately so you can mix-n-match for a truly custom, one of a kind look.



Description	Application	Black	Chrome
Brake Arm	'97-08 Touring Models	<b>811-20150</b>	<b>811-20151</b>
	'09-13 Touring Models	<b>811-20152</b>	<b>811-20153</b>
	'14-Up Touring Models	<b>811-20154</b>	<b>811-20155</b>



### SHIFTERS

Accutronix "Diamond" shift arm kits replace the stock shift arms for a more custom look. They mount & adjust like stock but conceal the shift shaft. They match the Accutronix "Diamond" brake arm kits, toe pegs are sold separately so you can mix-n-match for a truly custom, one of a kind look.



Application	Description	Black	Chrome
'84-Up FLH/FLT and '86-Up FLST	Heel-Toe Shifters	<b>811-20156</b>	<b>811-20157</b>
	Toe Shifter	<b>811-20158</b>	<b>811-20159</b>

### BILLET FLOORBOARDS NEW

These floor boards are machined from 6061 T-6 Billet Aluminum and are available in a brilliant chrome plated finish or black with machined accents. The top portion of the board features a Raised Hole design inspired by Racing Pedals. The insert is a multidirectional slip-resistant black Pyramid-Top rubber.

Application	Description	Chrome	Black
'84-Up FLH/FLT and '86-17 FLST	Original Drilled Floorboards	<b>811-20115</b>	<b>811-20116</b>
	Vintage Drilled Floorboards	<b>811-20117</b>	<b>811-20118</b>



- WINDSHIELDS / FAIRINGS
- AUDIO / COMMUNICATION
- SEATS / LUGGAGE
- BARS / MIRRORS / CONTROLS**
- EXHAUST
- AIR / FUEL SYSTEMS
- ENGINE
- TRANSMISSION / DRIVELINE
- GASKETS / SEALS
- ELECTRICAL
- LIGHTING
- CABLES
- BRAKES
- OIL FILTERS
- SUSPENSION
- BODY
- WHEELS
- TIRES / TIRE ACC.
- BIKE ACC.
- VICTORY / INDIAN
- COVERS / LOCKS / TIEDOWNS
- CHEMICALS
- TOOLS
- HELMETS
- HELMET ACC.
- EYEWEAR
- APPAREL / RIDER ACC.
- PROMOTIONAL
- REFERENCE
- INDEX

- WINDSHIELDS / FAIRINGS
- AUDIO / COMMUNICATION
- SEATS / LUGGAGE
- BARS / MIRRORS / CONTROLS**
- EXHAUST
- AIR / FUEL SYSTEMS
- ENGINE
- TRANSMISSION / DRIVELINE
- GASKETS / SEALS
- ELECTRICAL
- LIGHTING
- CABLES
- BRAKES
- OIL FILTERS
- SUSPENSION
- BODY
- WHEELS
- TIRES / TIRE ACC.
- BIKE ACC.
- VICTORY / INDIAN
- COVERS / LOCKS / TIEDOWNS
- CHEMICALS
- TOOLS
- HELMETS
- HELMET ACC.
- EYEWEAR
- APPAREL / RIDER ACC.
- PROMOTIONAL
- REFERENCE
- INDEX



## FLOORBOARDS

Accutronix Extended "Instigator" front and rear floor boards, extended 2-1/2" in front & 3/4" wider and 2-1/2" longer in the rear. Mounts like stock with stock hardware. They go nicely with Accutronix Heal-Toe shifters & Brake arm kits. The rear floor boards are extended 1-9/16" in front and 1-9/16" longer in the rear.



Description	Application	Chrome	Black
Rider Floorboards	'84-Up FLH/FLT and '86-Up FLST	<b>811-20110</b>	<b>811-20111</b>
Passenger Floorboards	'87-Up FLH/FLT	<b>811-20112</b>	<b>811-20113</b>



811-20110



811-20111



811-20112



811-20113



R O O K E

## TRAPS FLOORBOARDS

- Handcrafted in the USA
- Stainless steel Rooke logo insert
- Available in gloss or wrinkle black or raw steel finish to customize



Application	Year	Description	Finish	WPS #
FLH/FLT	'86-Up	Traps Floorboards	Black Gloss	<b>825-02300</b>
			Black Wrinkle	<b>825-02301</b>
			Raw	<b>825-02302</b>





## MOTO FLOOR BOARDS NEW

Our Moto Floor Boards are inspired by MotoCross and deliver the grip to prove it. Precision machined from aircraft grade 6061 T6 billet aluminum. Offered in Natural aluminum or black and gold anodized. They are light weight and strong. The outermost edge is tapered underside to optimize lean angel. Brass Balls logo located on the underside.

Measurements: 13.5" L x 4.75" W x .75" H  
 Fitment: HD Touring models  
 Includes 2 boards and mounting hardware

Description	Black	Natural	Gold
Moto Boards	826-01138	826-01137	826-01139



826-01138

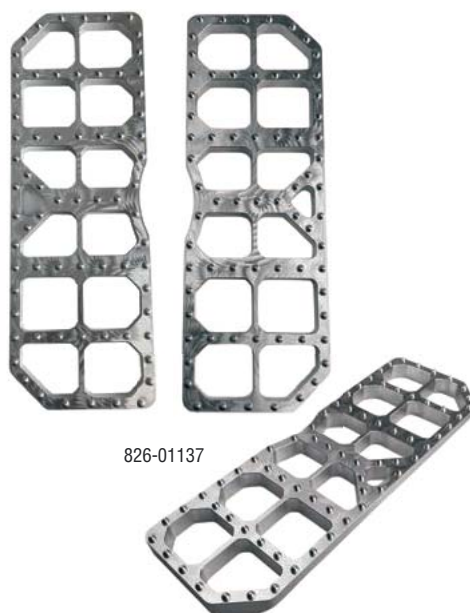

826-01137

## MINI MOTO BOARDS NEW

Our Mini Moto Floor Boards are inspired by MotoCross and deliver the grip to prove it. More surface area provides a firm foundation and the grip is second to none. Precision machined from aircraft grade 6061 T6 billet aluminum. Offered in Natural aluminum or black anodized. Includes adjustable chrome plated steel clevis. They are light weight and strong. The outermost edge is tapered underside to optimize lean angel. Brass Balls logo located on the underside.

Measurements: 5" L x 3.5" W x .93" H  
 Fitment: All HD models  
 Includes 2 boards, 2 HD Male Clevis, 2 socket head cap bolts

Description	Black	Natural
Mini Moto Boards	826-01036	826-01035



826-01136



826-01135

- WINDSHIELDS / FAIRINGS
- AUDIO / COMMUNICATION
- SEATS / LUGGAGE
- BARS / MIRRORS / CONTROLS
- EXHAUST
- AIR / FUEL SYSTEMS
- ENGINE
- TRANSMISSION / DRIVELINE
- GASKETS / SEALS
- ELECTRICAL
- LIGHTING
- CABLES
- BRAKES
- OIL FILTERS
- SUSPENSION
- BODY
- WHEELS
- TIRES / TIRE ACC.
- BIKE ACC.
- VICTORY / INDIAN
- COVERS / LOCKS / TIEDOWNS
- CHEMICALS
- TOOLS
- HELMETS
- HELMET ACC.
- EYEWEAR
- APPAREL / RIDER ACC.
- PROMOTIONAL
- REFERENCE
- INDEX

- WINDSHIELDS / FAIRINGS
- AUDIO / COMMUNICATION
- SEATS / LUGGAGE
- BARS / MIRRORS / CONTROLS**
- EXHAUST
- AIR / FUEL SYSTEMS
- ENGINE
- TRANSMISSION / DRIVELINE
- GASKETS / SEALS
- ELECTRICAL
- LIGHTING
- CABLES
- BRAKES
- OIL FILTERS
- SUSPENSION
- BODY
- WHEELS
- TIRES / TIRE ACC.
- BIKE ACC.
- VICTORY / INDIAN
- COVERS / LOCKS / TIEDOWNS
- CHEMICALS
- TOOLS
- HELMETS
- HELMET ACC.
- EYEWEAR
- APPAREL / RIDER ACC.
- PROMOTIONAL
- REFERENCE
- INDEX



## BILLET FOOT PEGS



- Complete your Darkside kit or just add some very cool pegs to your Harley
- The Darkside pegs fit stock Harley Davidson mounts
- Available in our show chrome or contrast cut black anodized finish



Application	Year	Description	WPS#
<b>HARLEY-DAVIDSON</b>			
Models w/ OE mounts	all	Darkside Chrome pair	<b>810-0401</b>
Models w/ OE mounts	all	Darkside Black pair	<b>810-0402</b>

## BILLET FLOORBOARDS

- Rider and passenger boards are CNC machined from 6061-T6 aluminum
- Available in our show chrome or contrast cut black
- The unique design offers comfort, style and excellent traction
- Direct bolt-on replacements on all HD models equipped with OEM floorboard
- Softtail models may require minor modification
- Made in the USA



### Floorboard Kits include:



- Right & Left Floorboard
- Mounting brackets

Application	Year	Description	WPS#
<b>HARLEY DAVIDSON RIDER FLOORBOARDS</b>			
Big Twin w/ floorboards	all	Bad Axe chrome	A <b>810-0058</b>
Big Twin w/ floorboards	all	Bad Axe black	<b>810-0057</b>
Big Twin w/ floorboards	all	Darkside chrome	<b>810-0051</b>
Big Twin w/ floorboards	all	Darkside black	B <b>810-0052</b>
Big Twin w/ floorboards	all	Ace's Wild chrome	C <b>810-0053</b>
Big Twin w/ floorboards	all	Ace's Wild black	<b>810-0054</b>

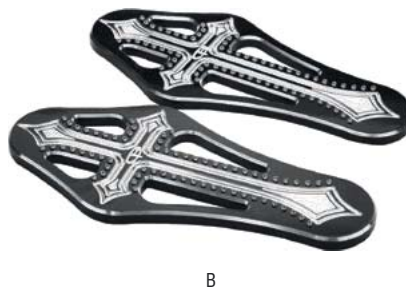

Application	Year	Description	WPS#
<b>HARLEY DAVIDSON PASSENGER FLOORBOARDS</b>			
Touring models	all	Bad Axe chrome	<b>810-0107</b>
Touring models	all	Bad Axe black	<b>810-0108</b>
Touring models	all	Darkside chrome	<b>810-0101</b>
Touring models	all	Darkside black	<b>810-0102</b>
Touring models	all	Ace's Wild chrome	<b>810-0103</b>
Touring models	all	Ace's Wild black	<b>810-0104</b>





56-5703



58-5704

### MINI PASSENGER FLOORBOARDS

- Mini passenger Floorboards for Harley Davidson
- Die Cast, Chrome Plated Mini Floorboard set with non slip rubber matt
- Floorboard measures approx. 4" x 8"
- Replaces male clevis mount foot pegs
- Additional mounting holes allow the floorboards to be rotated 15 degrees to "dial in" the riding position

Description	WPS#
Mounts to existing peg mount	56-5703
Threaded male mount peg mounts to frame	56-5704



### FLOORBOARD KITS

- Choose from three styles, OEM replacement rectangular, retro oval or modern sweeper style
- Stamped steel construction with a chrome finish
- Equipped with vibration dampers for extra comfort
- Mount in stock location, sold in pairs



A



B



C

Description	Application	WPS#
A Rectangular Floorboard Kits	86-Up FLST, '84-Up FLT	820-51100
B Oval Floorboard Kits	86-Up FLST, '84-Up FLT	820-51101
Oval Floorboard Kits w/USA Logo		820-51105
C Sweeper Floorboard Kits	86-Up FLST, '84-Up FLT	820-51102

WINDSHIELDS / FAIRINGS

AUDIO / COMMUNICATION

SEATS / LUGGAGE

BARS / MIRRORS / CONTROLS

EXHAUST

AIR / FUEL SYSTEMS

ENGINE

TRANSMISSION / DRIVELINE

GASKETS / SEALS

ELECTRICAL

LIGHTING

CABLES

BRAKES

OIL FILTERS

SUSPENSION

BODY

WHEELS

TIRES / TIRE ACC.

BIKE ACC.

VICTORY / INDIAN

COVERS / LOCKS / TIEDOWNS

CHEMICALS

TOOLS

HELMETS

HELMET ACC.

EYEWEAR

APPAREL / RIDER ACC.

PROMOTIONAL

REFERENCE

INDEX



## FLOORBOARD MATTS

- Suitable as OE replacement
- Sold in pairs



Description	Application	WPS#
Rectangular Floorboard Pads	'06-14 FLH/FLT	<b>820-51111</b>
Rectangular Floorboard Pads (glue on style)	'84-05 FLH/FLT '86-Up FLST	<b>820-51110</b>
Oval Floorboard Pads Plain	'40-65 FL	<b>820-51103</b>
Oval Floorboard Pads w/USA Logo	'40-65 FL	<b>820-51104</b>
Passenger Floorboard Matts Ribbed	'86-Up FLH/FLT	<b>820-51106</b>
Passenger Floorboard Matts Block	'86-Up FLH/FLT	<b>820-51107</b>

## FRONT FLOORBOARD MOUNTS

Description	Application	WPS#
Chrome Front Floorboard Mounts	FLH/FLT '83-08	<b>820-51109</b>



## PASSENGER FLOORBOARD EXTENSIONS

Description	Application	WPS#
Passenger Floorboard Extensions	FLH/FLT '93-09 and '06-14 CVO Touring	<b>820-1968</b>



## PASSENGER FLOORBOARD COVERS

Description	Application	WPS#
Passenger Floorboard Covers	FLST/FLT '86-Up	<b>820-51108</b>



- WINDSHIELDS / FAIRINGS
- AUDIO / COMMUNICATION
- SEATS / LUGGAGE
- BARS / MIRRORS / CONTROLS**
- EXHAUST
- AIR / FUEL SYSTEMS
- ENGINE
- TRANSMISSION / DRIVELINE
- GASKETS / SEALS
- ELECTRICAL
- LIGHTING
- CABLES
- BRAKES
- OIL FILTERS
- SUSPENSION
- BODY
- WHEELS
- TIRES / TIRE ACC.
- BIKE ACC.
- VICTORY / INDIAN
- COVERS / LOCKS / TIEDOWNS
- CHEMICALS
- TOOLS
- HELMETS
- HELMET ACC.
- EYEWEAR
- APPAREL / RIDER ACC.
- PROMOTIONAL
- REFERENCE
- INDEX

**FLOORBOARD EXTENSION KITS**

- Easily bolts on to your 1983-2018 Touring bike
- It extends your floorboards outward .75"
- You will notice a difference
- On the left side you will be able to use more of the floorboard because you are moving it slightly away from the shifter
- On the right side it gives you some more room from your pipes
- This kit comes with billet aluminum, powder coated spacers and stainless steel hardware



A



B



C



D



E



F



G

Description	Application	WPS#
A Chrome plated floorboard extension kit	'09-11 FLT/FLH CVO models	816-0024
B Chrome plated floorboard extension kit	'12-18 FLT/FLH CVO models	816-0026
C Floorboard extension kit	'09-18 FLT/FLH models (except CVO models)	816-0021
D Floorboard extension kit	'93-08 FLT/FLH models	816-0020
E Floorboard extension kit	'83-92 FLT/FLH models	816-0022
F Passenger floorboard extension kit	'93-09 FLT/FLH models	816-0023
G Passenger floorboard extension kit	'10-18 FLT/FLH models	816-0025

WINDSHIELDS / FAIRINGS

AUDIO / COMMUNICATION

SEATS / LUGGAGE

BARS / MIRRORS / CONTROLS

EXHAUST

AIR / FUEL SYSTEMS

ENGINE

TRANSMISSION / DRIVELINE

GASKETS / SEALS

ELECTRICAL

LIGHTING

CABLES

BRAKES

OIL FILTERS

SUSPENSION

BODY

WHEELS

TIRES / TIRE ACC.

BIKE ACC.

VICTORY / INDIAN

COVERS / LOCKS / TIEDOWNS

CHEMICALS

TOOLS

HELMETS

HELMET ACC.

EYEWEAR

APPAREL / RIDER ACC.

PROMOTIONAL

REFERENCE

INDEX

WINDSHIELDS / FAIRINGS  
 AUDIO / COMMUNICATION  
 SEATS / LUGGAGE  
 BARS / MIRRORS / CONTROLS  
**EXHAUST**  
 AIR / FUEL SYSTEMS  
 ENGINE  
 TRANSMISSION / DRIVELINE  
 GASKETS / SEALS  
 ELECTRICAL  
 LIGHTING  
 CABLES  
 BRAKES  
 OIL FILTERS  
 SUSPENSION  
 BODY  
 WHEELS  
 TIRES / TIRE ACC.  
 BIKE ACC.  
 VICTORY / INDIAN  
 COVERS / LOCKS / TIEDOWNS  
 CHEMICALS  
 TOOLS  
 HELMETS  
 HELMET ACC.  
 EYEWEAR  
 APPAREL / RIDER ACC.  
 PROMOTIONAL  
 REFERENCE  
 INDEX



R O O K E €

## ROOKE CUSTOMS BAGGER EXHAUST

- Race inspired 2 into 1 stepped header design for asphalt shredding performance
- Dual muffler system features the same header design but branches out between transmission and rear wheel to a second muffler on the left side
- All stainless, TIG welded with rebuildable mufflers and brushed finish
- Slip-ons for stock header system feature a polished stainless steel finish
- Complementing intake available

Not legal for sale in California, check local laws before installation.



Application	Year	Description	Finish	WPS #
FLH/FLT	'09-16	2 into 1 System	Brushed Stainless Steel	825-01000
	'09-16	2 into 2 System		825-01010



R O O K E

## DYNA 2 INTO 1 EXHAUST SYSTEM

- Race inspired 2 into 1 stepped header design for asphalt shredding performance
- All stainless, TIG welded with rebuildable muffler and brushed finish
- Fits models with mid controls and forward controls

Not legal for sale in California, check local laws before installation.

Application	Year	Description	Finish	WPS #
FXD	'06-17	2 into 1 System	Brushed Stainless Steel	825-01050



- WINDSHIELDS / FAIRINGS
- AUDIO / COMMUNICATION
- SEATS / LUGGAGE
- BARS / MIRRORS / CONTROLS
- EXHAUST**
- AIR / FUEL SYSTEMS
- ENGINE
- TRANSMISSION / DRIVELINE
- GASKETS / SEALS
- ELECTRICAL
- LIGHTING
- CABLES
- BRAKES
- OIL FILTERS
- SUSPENSION
- BODY
- WHEELS
- TIRES / TIRE ACC.
- BIKE ACC.
- VICTORY / INDIAN
- COVERS / LOCKS / TIEDOWNS
- CHEMICALS
- TOOLS
- HELMETS
- HELMET ACC.
- EYEWEAR
- APPAREL / RIDER ACC.
- PROMOTIONAL
- REFERENCE
- INDEX

# SAWICKI/SPEED/SHOP

## M8 SOFTAIL PIPE



- Designed with performance in mind, for a deadly look and a great sound.
- Hand formed merge collectors, stepped headers
- Anodized billet endcap
- Mandrel bent aircraft quality stainless steel tubing
- All TIG welds done by hand
- Swept-up muffler for enhanced ground clearance
- Fits all M8 Softtail Models
- Available in brushed finish or ceramic black
- Accepts 18mm O2 sensor for a wide range of fitment

Application	Year	Brushed SS	Black
Softails	'18-Up	930-01005	930-01006



- WINDSHIELDS / FAIRINGS
- AUDIO / COMMUNICATION
- SEATS / LUGGAGE
- BARS / MIRRORS / CONTROLS
- EXHAUST**
- AIR / FUEL SYSTEMS
- ENGINE
- TRANSMISSION / DRIVELINE
- GASKETS / SEALS
- ELECTRICAL
- LIGHTING
- CABLES
- BRAKES
- OIL FILTERS
- SUSPENSION
- BODY
- WHEELS
- TIRES / TIRE ACC.
- BIKE ACC.
- VICTORY / INDIAN
- COVERS / LOCKS / TIEDOWNS
- CHEMICALS
- TOOLS
- HELMETS
- HELMET ACC.
- EYEWEAR
- APPAREL / RIDER ACC.
- PROMOTIONAL
- REFERENCE
- INDEX





Not legal for sale in California, check local laws before installation.

Application	Year	Brushed SS	Black
Dyna FXD	'91-17	930-01000	930-01001

DYNOMite test "on 2016-01-04 @ 20-07-35" by Racing Connection

## 2 IN 1 DYNA PIPE

Stainless 2-1 Exhaust systems offer the following features:

- Designed with performance in mind, for a deadly look and a great sound.
- Cad designed
- Hand formed merge collectors
- Anodized billet endcap
- Mandrel bent aircraft quality stainless steel tubing
- All TIG welds done by hand
- High-temp SS wool and packing material
- Swept-up muffler for enhanced ground clearance
- Fits with forward and mid controls
- Available in brushed finish or ceramic black
- Accepts 18mm O2 sensor for a wide range of fitment
- Fits: ALL YEARS OF HARLEY DAVIDSON DYNA MODELS (except Switchback)

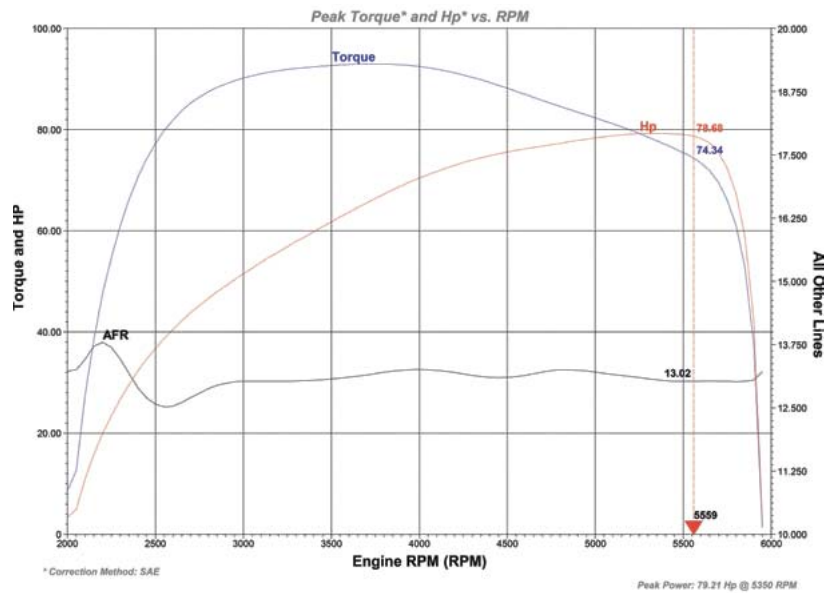

- WINDSHIELDS / FAIRINGS
- AUDIO / COMMUNICATION
- SEATS / LUGGAGE
- BARS / MIRRORS / CONTROLS
- EXHAUST**
- AIR / FUEL SYSTEMS
- ENGINE
- TRANSMISSION / DRIVELINE
- GASKETS / SEALS
- ELECTRICAL
- LIGHTING
- CABLES
- BRAKES
- OIL FILTERS
- SUSPENSION
- BODY
- WHEELS
- TIRES / TIRE ACC.
- BIKE ACC.
- VICTORY / INDIAN
- COVERS / LOCKS / TIEDOWNS
- CHEMICALS
- TOOLS
- HELMETS
- HELMET ACC.
- EYEWEAR
- APPAREL / RIDER ACC.
- PROMOTIONAL
- REFERENCE
- INDEX



**BARITONE SLIP-ONS**

- 4" Muffler bodies in show quality chrome or black ceramic
- Billet aluminum end caps available in chrome, black or contrast cut
- End caps can be rotated to four positions, and blend perfectly with bags when in up-slash position
- Engineered to produce a deep bass tone and increased performance in both stock and modified engines
- Hand crafted with pride in the USA by people who ride motorcycles



940-0230B



940-0230C



940-0231C



940-0232C



940-0231B



940-0232B



940-0233C

Application	Year	Chrome	Black	Chrome w/ contrast tip	Black w/ Contrast Tip
Touring Models	'95-16	<b>940-0230C</b>	<b>940-0230B</b>	<b>940-0231C</b>	<b>940-0231B</b>
	'17-Up	<b>940-0234C</b>	<b>940-0234B</b>	<b>940-0235C</b>	<b>940-0235B</b>
FreeWheeler	'15-17	<b>940-0232C</b>	<b>940-0232B</b>	<b>940-0233C</b>	

## DOUBLE DOWNS TOURING SLIP-ONS



- Twin core baffle technology featuring stainless cores and outlets
- Muscular sound
- Original dual outlet design
- Increased power and torque
- Parts marked with \* are not legal for use in California on pollution controlled vehicles - check local laws before installation
- Will not fit models equipped with extended bags

Application	Year	Chrome
Touring Models	'09-16	<b>940-0170C</b>
	'95-08	<b>940-0171C</b>

\* Not legal for use in California on pollution controlled vehicles - check local laws before installation



## LOOSE CANNONS 4" SLIP-ON MUFFLERS

- Flash suppressor end treatment
- Deep throaty roar
- Race-inspired high performance baffle
- Dual-density muffler packing
- Designed to maximize stock and high performance motors

Application	Year	Chrome	Black	Quiet Insert (each)
Touring Models	'17-Up	<b>940-0104C</b>	<b>940-0104B</b>	
	'09-16	<b>940-0100C</b>	<b>940-0100B</b>	<b>940-0105</b>
	'95-08	<b>940-0101C</b> *	<b>940-0101B</b> *	<b>940-0105</b>

\* Not legal for use in California on pollution controlled vehicles - check local laws before installation



- WINDSHIELDS / FAIRINGS
- AUDIO / COMMUNICATION
- SEATS / LUGGAGE
- BARS / MIRRORS / CONTROLS
- EXHAUST**
- AIR / FUEL SYSTEMS
- ENGINE
- TRANSMISSION / DRIVELINE
- GASKETS / SEALS
- ELECTRICAL
- LIGHTING
- CABLES
- BRAKES
- OIL FILTERS
- SUSPENSION
- BODY
- WHEELS
- TIRES / TIRE ACC.
- BIKE ACC.
- VICTORY / INDIAN
- COVERS / LOCKS / TIEDOWNS
- CHEMICALS
- TOOLS
- HELMETS
- HELMET ACC.
- EYEWEAR
- APPAREL / RIDER ACC.
- PROMOTIONAL
- REFERENCE
- INDEX



## GP TOURING SLIP-ONS

Grand Prix Slip-Ons take Firebrand's aggressive styling to the next level. Don't be fooled by their good looks, the Grand Prix Slip-Ons are not only for show. Inside the 4" muffler bodies are free flowing, stainless core baffles wrapped in dual-density packing. Engineered for today's larger displacement motors, they deliver increased performance, and a sound so deep you can feel it.

- Billet aluminum MotoGP™ inspired end caps
- Deep race sound delivered through high performance stainless core baffles
- Engineered to maximize power in today's larger displacement motors
- Work with extended saddlebags and skirts
- Available in show quality chrome or black ceramic finishes

Not legal for use in California on pollution controlled vehicles - check local laws before installation



Application	Year	Chrome	Black	Quiet Inserts (each)
Touring Models	'17-Up	940-0107C	940-0107B	
	'09-16	940-0102C	940-0102B	940-0105



- WINDSHIELDS / FAIRINGS
- AUDIO / COMMUNICATION
- SEATS / LUGGAGE
- BAR / MIRRORS / CONTROLS
- EXHAUST**
- AIR / FUEL SYSTEMS
- ENGINE
- TRANSMISSION / DRIVELINE
- GASKETS / SEALS
- ELECTRICAL
- LIGHTING
- CABLES
- BRAKES
- OIL FILTERS
- SUSPENSION
- BODY
- WHEELS
- TIRES / TIRE ACC.
- BIKE ACC.
- VICTORY / INDIAN
- COVERS / LOCKS / TIEDOWNS
- CHEMICALS
- TOOLS
- HELMETS
- HELMET ACC.
- EYEWEAR
- APPAREL / RIDER ACC.
- PROMOTIONAL
- REFERENCE
- INDEX

## UPSTARTS 2 IN 2 EXHAUST

Engineered to handle today's higher displacement motors, Upstarts feature 1 3/4" head pipes stepped up to 2 1/2" Quadradical up-slash muffler bodies. Internally, stainless steel, perforated core baffles wrapped in dual density packing complete the system.

Full coverage 2 1/4" head pipe heat shields, 18mm O2 ports with 12mm inserts, and hand crafted, high quality fit and finish round out the package. Finished in show quality chrome or black ceramic coatings, Upstarts are available for Sportsters, Softails and Dynas.

- Custom, hand crafted Quadradical up-slash styling
- Stainless steel, perforated core baffles
- Stepped 2 1/2" muffler bodies for increased performance and quality sound
- O2 sensor eliminator plugs available

Not legal for use in California on pollution controlled vehicles - check local laws before installation

Application	Year	Chrome	Black
XL Models	'04-UP	940-0200C	940-0200B
Softail Models	'07-17	940-0201C	940-0201B
Dyna Models	'06-17	940-0202C	940-0202B



A



B



C



D

## EXHAUST ACCESSORIES

Replacement parts and quiet inserts for all 3" and 4" Firebrand muffler bodies.

Description	WPS#
A 4" Quiet Insert	940-0105
B 3" Quiet Insert	940-0106
C Glass Pack 4" Mufflers	940-0510
Glass Pack 3" Mufflers	940-0511
D O2 Sensor Plugs 18mm	940-0500

- WINDSHIELDS / FAIRINGS
- AUDIO / COMMUNICATION
- SEATS / LUGGAGE
- BARS / MIRRORS / CONTROLS
- EXHAUST**
- AIR / FUEL SYSTEMS
- ENGINE
- TRANSMISSION / DRIVELINE
- GASKETS / SEALS
- ELECTRICAL
- LIGHTING
- CABLES
- BRAKES
- OIL FILTERS
- SUSPENSION
- BODY
- WHEELS
- TIRES / TIRE ACC.
- BIKE ACC.
- VICTORY / INDIAN
- COVERS / LOCKS / TIEDOWNS
- CHEMICALS
- TOOLS
- HELMETS
- HELMET ACC.
- EYEWEAR
- APPAREL / RIDER ACC.
- PROMOTIONAL
- REFERENCE
- INDEX



## FIFTYTWO52 2 IN 1 EXHAUST

Named after the RPM point at which an engine's horsepower equals its torque, The FiftyTwo52 was engineered with one priority: performance. Beginning with the 1 3/4" matched ratio head pipes, exhaust pulses are synchronized to allow for optimized scavenging of exhaust pressure. Flowing into the Powercurve, True-Merge Collector, the exhaust will maintain velocity and experience the smoothest transition possible. Moving into the muffler, a 2 1/2" free flowing, perforated core baffle provides the least interference as the exhaust escapes.

And it doesn't all end with performance. The 20 degree upswept muffler with MotoGP™ inspired end treatment attains a unique and aggressive style, while the dual layer baffle packing produces an incredibly deep race tune. Integrated heat shields and Firebrand's hand crafted quality complete the package.

- Proprietary Powercurve, True-Merge Collector
- Billet aluminum MotoGP™ inspired end cap
- Race inspired, stainless core, high performance baffle
- Unmatched combination of horsepower and torque
- Available in show quality chrome or black ceramic finish

Application	Year	Chrome	Black
XL Models	'04-15	940-0210C	940-0210B
Softail Models	'07-17	940-0211C	940-0211B
Dyna Models	'06-17	940-0212C	940-0212B

Not legal for use in California on pollution controlled vehicles - check local laws before installation



## LOOSE CANNONS FOR SPORTSTERS

- 3" Body with flash-suppressor end treatment
- Race-Inspired high performance baffle with dual density muffler packing
- Available in show quality chrome or ceramic flat black finish
- Deep, throaty sound

Application	Year	Chrome	Black
XL Models	2014-Up	940-0121C	940-0121B
	'04-13	940-0120C	940-0120B

Not legal for use in California on pollution controlled vehicles - check local laws before installation



## LOOSE CANNONS FOR SOFTAILS

- 3" Body with flash-suppressor end treatment
- Race-Inspired high performance baffle with dual density muffler packing



- Available in show quality chrome or ceramic flat black finish
- Deep, throaty sound

Application	Year	Chrome	Black
FLSTC	'07-17	940-0130C	940-0130B
FXCW/C	'08-11	940-0130C	940-0130B
FXSB	'13-17	940-0130C	940-0130B
FXST	2007	940-0130C	940-0130B
FXSTB	'07-09	940-0130C	940-0130B
FXSTC	'07-10	940-0130C	940-0130B
FLSTF	'07-17	940-0135C	940-0135B
FLSTFB	'12-17	940-0135C	940-0135B
FXSTD	2007	940-0135C	940-0135B
FLSTN	'07-17	940-0140C	940-0140B
FLSTSB	'08-11	940-0140C	940-0140B
FLS	'12-17	940-0140C	940-0140B

Not legal for use in California on pollution controlled vehicles - check local laws before installation

## LOOSE CANNONS FOR DYNAS



- 3" Body with flash-suppressor end treatment
- Race-Inspired high performance baffle with dual density muffler packing
- Available in show quality chrome or ceramic flat black finish
- Deep, throaty sound

Application	Year	Chrome	Black
Dyna Models (except models listed below)	'91-17	940-0150C	940-0150B
FXDF	'08-17	940-0155C	940-0155B
FXDWG	'10-17	940-0155C	940-0155B

Not legal for use in California on pollution controlled vehicles - check local laws before installation

## LOOSE CANNON SLIP-ON FOR DYNA SWITCH BACK AND LOWRIDER



The Dyna Low Rider and Switchback are combinations of both classic styling and contemporary appeal. The 4" Loose Cannon slip-on was designed to highlight this unique combination. However, style is not all the 4" Loose Cannon brings to the table. Inside, a 2 1/2" free flowing baffle, featuring a stainless perforated core and dual layer packing, delivers an aggressively deep sound and increased performance.

- Classic 4" muffler body with contemporary flash-suppressor end treatment
- Race inspired high performance baffle delivers deep, throaty sound and increased performance
- Easy to install Quiet Insert available

Application	Year	Chrome	Quiet Insert (each)
Dyna Switchback FLD	'12-15	940-0103C	940-0105
Dyna Lowrider FXDL	'14-17	940-0103C	

Not legal for use in California on pollution controlled vehicles - check local laws before installation

- WINDSHIELDS / FAIRINGS
- AUDIO / COMMUNICATION
- SEATS / LUGGAGE
- BAR / MIRRORS / CONTROLS
- EXHAUST
- AIR / FUEL SYSTEMS
- ENGINE
- TRANSMISSION / DRIVELINE
- GASKETS / SEALS
- ELECTRICAL
- LIGHTING
- CABLES
- BRAKES
- OIL FILTERS
- SUSPENSION
- BODY
- WHEELS
- TIRES / TIRE ACC.
- BIKE ACC.
- VICTORY / INDIAN
- COVERS / LOCKS / TIEDOWNS
- CHEMICALS
- TOOLS
- HELMETS
- HELMET ACC.
- EYEWEAR
- APPAREL / RIDER ACC.
- PROMOTIONAL
- REFERENCE
- INDEX



## RIP - ROD SLIP-ON EXHAUST

Take your bike, throw in some hard tail chopper, a touch of '32 Ford, and a rebellious attitude, and you have Firebrands Rip-Rod slip-ons. Retro style ripple pipe and old school end caps deliver a modern variation on the glory days when guys chopped, channeled and raced whatever they could get their hands on to prove who was coolest.

- 2 ¼" rippled muffler bodies
- Billet aluminum hot rod style end caps
- Maintenance free, removable baffles
- All mounting hardware included (Universal kit includes bracket mount hardware)
- Chrome, Black and Gold End Cap Kits available separately



Application	Year	Chrome w/ black tip	Black w/ gold tips	Gold
XL Models	'04-13	<b>940-0220C</b>	<b>940-0220B</b>	
	'14-17	<b>940-0221C</b>	<b>940-0221B</b>	
Universal fit for 1 3/4" head pipes (sold each)		<b>940-0222C</b>	<b>940-0222B</b>	
End Caps		<b>940-0229C</b>	<b>940-0229B</b>	<b>940-0229G</b>



940-0220C



940-0220B

### END CAPS



940-0229C



940-0229G



940-0229B



### LOOSE CANNON SLIP-ON FOR STREET 500/750



- 4" Body with flash-suppressor end treatment
- Race-Inspired high performance baffle with dual density muffler packing
- Easy to install DB killer available
- Replaces the stock sewing machine sound with a Deep, Throaty Roar!

Application	Year	Black	Quiet Insert (each)
Street 750/500 Models	'14-Up	940-0160B	940-0105

Not legal for use in California on pollution controlled vehicles - check local laws before installation



### GP SLIP-ON FOR STREET 500/750

The Grand Prix Slip-On is a great way to amplify the sporty features of the Harley-Davidson Street. Inspired by the MotoGP™ race circuit, the Grand Prix Slip-On is guaranteed to stand out with its chrome hex end treatment nesting inside a contrasting black ceramic coated billet end cap. Don't be fooled by its good looks, the Grand Prix Slip-On is not just for show.

- 4" Body with billet aluminum MotoGP™ inspired end cap
- Race-inspired high performance stainless core baffle with dual density muffler packing
- Engineered to deliver a deep race sound and improved performance

Not legal for use in California on pollution controlled vehicles - check local laws before installation



Application	Year	Black	Quiet Insert (each)
Street 750/500 Models	'14-Up	940-0161B	940-0105

- WINDSHIELDS / FAIRINGS
- AUDIO / COMMUNICATION
- SEATS / LUGGAGE
- BAR / MIRRORS / CONTROLS
- EXHAUST**
- AIR / FUEL SYSTEMS
- ENGINE
- TRANSMISSION / DRIVELINE
- GASKETS / SEALS
- ELECTRICAL
- LIGHTING
- CABLES
- BRAKES
- OIL FILTERS
- SUSPENSION
- BODY
- WHEELS
- TIRES / TIRE ACC.
- BIKE ACC.
- VICTORY / INDIAN
- COVERS / LOCKS / TIEDOWNS
- CHEMICALS
- TOOLS
- HELMETS
- HELMET ACC.
- EYEWEAR
- APPAREL / RIDER ACC.
- PROMOTIONAL
- REFERENCE
- INDEX



## FLH/FLT 2 INTO 1 TURN-OUT

Feel the **POWER** of **FREEDOM**

- Triple stepped headers 1.75" to 1.875" to 2.00" for increases of 15-18 HP and 13-15 foot lbs. of torque
- Includes a 2-step baffle 2.5"-3" for a deep throaty sound
- Combined 5 steps throughout for **EXTREME POWER**
- System reduces heat concentration by 30%
- Boasting full-coverage one-piece (220°) blue-proof heat shields (available in chrome or ceramic black)
- Customizable with chrome, black or sculpted black tip that rotates to your preferred position to achieve the turn-out, turn-up, or the turn-down look
- Includes O2 sensor ports, plugs & mounting hardware
- Proudly made in the USA with 100% American Steel
- A Head-Turning look and sound

Application	Year	Chrome/ Chr Tip	Chrome/Blk Sculpted Tip	Black/Blk Sculpted Tip	Pitch Black Series	Black/Chr Tip
FLH/FLT	'17-Up	<b>82-00635</b>	<b>82-00636</b>	<b>82-00637</b>	<b>82-00638</b>	<b>82-00639</b>
	'95-16	<b>82-00508</b>	<b>82-00509</b>	<b>82-00510</b>	<b>82-00511</b>	<b>82-00512</b>



82-00508



82-00509



82-00510



82-00511



82-00512

- WINDSHIELDS / FAIRINGS
- AUDIO / COMMUNICATION
- SEATS / LUGGAGE
- BAR / MIRRORS / CONTROLS
- EXHAUST**
- AIR / FUEL SYSTEMS
- ENGINE
- TRANSMISSION / DRIVELINE
- GASKETS / SEALS
- ELECTRICAL
- LIGHTING
- CABLES
- BRAKES
- OIL FILTERS
- SUSPENSION
- BODY
- WHEELS
- TIRES / TIRE ACC.
- BIKE ACC.
- VICTORY / INDIAN
- COVERS / LOCKS / TIEDOWNS
- CHEMICALS
- TOOLS
- HELMETS
- HELMET ACC.
- EYEWEAR
- APPAREL / RIDER ACC.
- PROMOTIONAL
- REFERENCE
- INDEX

# FLH/FLT 2 INTO 1 SHORTY



Feel the POWER of FREEDOM

- Triple stepped headers 1.75" to 1.875" to 2.00" for increases of 15-18 HP and 13-15 foot lbs. of torque
- Includes a 2-step baffle 2.5"-3" for a deep throaty sound
- Combined 5 steps throughout for EXTREME POWER
- System reduces heat concentration by 30%
- Boasting full-coverage one-piece (220°) blue-proof heat shields (available in chrome or ceramic black)
- Customizable with chrome, black or sculpted black tip that rotates to your preferred position
- Includes O2 sensor ports, plugs & mounting hardware
- Proudly made in the USA with 100% American Steel
- A Head-Turning look and sound

Application	Year	Chrome/ Chr Tip	Chrome/Blk Sculpted Tip	Black/Blk Sculpted Tip	Pitch Black Series	Black/Chr Tip
FLH/FLT	'17-Up	<b>82-00640</b>	<b>82-00641</b>	<b>82-00642</b>	<b>82-00643</b>	<b>82-00644</b>
	'95-16	<b>82-00564</b>	<b>82-00565</b>	<b>82-00566</b>	<b>82-00567</b>	<b>82-00568</b>



82-00640



82-00641



- WINDSHIELDS / FAIRINGS
- AUDIO / COMMUNICATION
- SEATS / LUGGAGE
- BARS / MIRRORS / CONTROLS
- EXHAUST**
- AIR / FUEL SYSTEMS
- ENGINE
- TRANSMISSION / DRIVELINE
- GASKETS / SEALS
- ELECTRICAL
- LIGHTING
- CABLES
- BRAKES
- OIL FILTERS
- SUSPENSION
- BODY
- WHEELS
- TIRES / TIRE ACC.
- BIKE ACC.
- VICTORY / INDIAN
- COVERS / LOCKS / TIEDOWNS
- CHEMICALS
- TOOLS
- HELMETS
- HELMET ACC.
- EYEWEAR
- APPAREL / RIDER ACC.
- PROMOTIONAL
- REFERENCE
- INDEX



**COMPLETE EXHAUST FOR HARLEY DAVIDSON  
DRESSER/TOURING FLH/FLT MODELS**

Feel the **POWER** of **FREEDOM**



**SHARP CURVE RADIUS SYSTEMS**

- Exclusive triple stepped headers for max horsepower, torque & performance
- 1-piece full length heat shields prevent chipping, rust and peeling between sections
- Large 2½" 16 gauge heavy duty 220° blue proof shields available in chrome or black hi-temp finish
- Removable baffles
- O2 ports & plugs provided for early models
- Complete with mounting hardware and brackets
- Unmatched sound & performance
- Made in the U.S.A.!



Not legal for use in California on pollution controlled vehicles - check local laws before installation

Application	Year	Chrome Scallop Cut	Black Scallop Cut	Chrome/Chr Tip	Chrome/Blk Tip	Black/Blk Tip
FLH/FLT	'17-Up	82-00645	82-00646	82-00647	82-00648	82-00649
	'95-16	82-00228	82-00229			
Passenger Peg Mount			82-00105A			

\* 2014 models may require additional washer for correct spacing

**RADICAL RADIUS FULL SYSTEMS**

Application	Year	Black	Chrome
FLH/FLT	'95-16	82-00409	82-00408



**UNION 2 INTO 1 SYSTEMS**

- The worlds only 5-step 2-into-1 performance exhaust system
- 3-step header pipes 1¾" to 1 7/8" to 2" for anti-reversion, full range torque and horsepower
- 2½" O.D., 220° one piece heavy duty 16 gauge heat shields
- Exclusive 2-step removable baffle 2½" to 3"
- 4" Diameter slash-cut end cap with rolled edge that mounts slash up or slash down
- O2 ports & plugs provided for early models provided
- Complete with mounting hardware and brackets
- Deep throaty roar!
- Made in the U.S.A.!
- Includes header, muffler, heat shields, and hardware



Not legal for use in California on pollution controlled vehicles - check local laws before installation

Application	Year	Chrome	Chrome/Blk Sculpted Tip	Black/Blk Sculpted Tip	Quiet Baffle
FLH/FLT	'17-Up	82-00650	82-00651	82-00652	
	'95-16	82-00232	82-00376	82-00233	82-09011

\* 2014 models may require a washer for correct spacing

WINDSHIELDS / FAIRINGS  
AUDIO / COMMUNICATION  
SEATS / LUGGAGE  
BARS / MIRRORS / CONTROLS  
EXHAUST  
AIR / FUEL SYSTEMS  
ENGINE  
TRANSMISSION / DRIVELINE  
GASKETS / SEALS  
ELECTRICAL  
LIGHTING  
CABLES  
BRAKES  
OIL FILTERS  
SUSPENSION  
BODY  
WHEELS  
TIRES / TIRE ACC.  
BIKE ACC.  
VICTORY / INDIAN  
COVERS / LOCKS / TIEDOWNS  
CHEMICALS  
TOOLS  
HELMETS  
HELMET ACC.  
EYEWEAR  
APPAREL / RIDER ACC.  
PROMOTIONAL  
REFERENCE  
INDEX

**COMPLETE EXHAUST FOR HARLEY DAVIDSON  
DRESSER/TOURING FLH/FLT MODELS**



Feel the POWER of FREEDOM



**AMERICAN OUTLAW DUAL SYSTEMS**

- The world's only 5-step 4½" Megaphone Dresser exhaust system
- Triple stepped headers for anti-reversion, full range torque and optimal horsepower
- 2½" louvered to 3" stepped "Bandit" performance baffles
- 4½" megaphone with 2½" O.D. full-length, 1-piece 220° heavy duty 16 gauge heat shields
- O2 ports & plugs provided for early models
- Complete with mounting hardware and brackets
- Deep throaty sound
- Made in the U.S.A!

Not legal for use in California on pollution controlled vehicles  
- check local laws before installation

Application	Year	Description	WPS #	Quiet Baffle
FLH/FLT	'95-08	Chrome w/chrome tip	<b>82-00280</b>	<b>82-09006</b>
	'95-08	Chrome w/black tip	<b>82-00281</b>	<b>82-09006</b>
	'95-08	Black w/black tip	<b>82-00283</b>	<b>82-09006</b>
	'95-08	Black w/chrome tip		<b>82-09006</b>
	'09-16	Chrome w/chrome tip	<b>82-00284</b>	<b>82-09006</b>
	'09-16	Chrome w/black tip	<b>82-00285</b>	<b>82-09006</b>
	'09-16	Black w/black tip	<b>82-00287</b>	<b>82-09006</b>

**RACING DUAL SYSTEMS**

- The world's only 5-step 4" performance system
- Triple stepped headers for anti-reversion, full range torque and optimal horsepower
- 2½" to 3" stepped louvered, power thrust baffles
- 4½" muffler with 2½" O.D. full-length, 1-piece 220° heavy duty 16 gauge heat shields
- O2 ports & plugs provided for early models
- Complete with mounting hardware and brackets
- Drag strip rumble
- Made in the U.S.A.!

Not legal for use in California on pollution controlled vehicles  
- check local laws before installation

Application	Year	Description	WPS #	Quiet Baffle
FLH/FLT	'95-08	Chrome w/chrome tip	<b>82-00134</b>	<b>82-09003</b>
	'95-08	Black w/chrome tip	<b>82-00208</b>	<b>82-09003</b>
	'09-16	Chrome w/chrome tip	<b>82-00234</b>	<b>82-09003</b>
	'09-16	Chrome w/black tip	<b>82-00235</b>	<b>82-09003</b>
	'09-16	Black w/black tip	<b>82-00272</b>	<b>82-09003</b>



- WINDSHIELDS / FAIRINGS
- AUDIO / COMMUNICATION
- SEATS / LUGGAGE
- BARS / MIRRORS / CONTROLS
- EXHAUST**
- AIR / FUEL SYSTEMS
- ENGINE
- TRANSMISSION / DRIVELINE
- GASKETS / SEALS
- ELECTRICAL
- LIGHTING
- CABLES
- BRAKES
- OIL FILTERS
- SUSPENSION
- BODY
- WHEELS
- TIRES / TIRE ACC.
- BIKE ACC.
- VICTORY / INDIAN
- COVERS / LOCKS / TIEDOWNS
- CHEMICALS
- TOOLS
- HELMETS
- HELMET ACC.
- EYEWEAR
- APPAREL / RIDER ACC.
- PROMOTIONAL
- REFERENCE
- INDEX



Feel the POWER of FREEDOM

## EXHAUST HEADERS FOR HARLEY DAVIDSON DRESSER/TOURING FLH/FLT MODELS

### TRUE DUAL HEADERS

- True dual headpipes
- Removes OEM stock cross over headpipe
- Reduces heat by 30%
- Independent right & left side 1¾" headpipes
- 2 1/8" 220° heavy duty 16 gauge full coverage heat shields
- Compatible with many major manufacturers slip-ons
- O2 ports & plugs provided for early models
- Complete with mounting hardware and brackets
- Unbeatable performance
- Optional slip-ons shown, sold separately



Not legal for use in California on pollution controlled vehicles - check local laws before installation

Application	Year	Chrome	Black
FLH/FLT	'95-08	<b>82-00095</b>	<b>82-00128</b>
	'09-16	<b>82-00244</b>	<b>82-00245</b>
	'17-Up	<b>82-00655</b>	<b>82-00656</b>
Trike models	* '08-16	<b>82-00244</b>	<b>82-00245</b>

\*82-09025 Adapter kit required for Trike models



### TUCK AND UNDER HEADERS

- Finally your pre-09 Tourer has the new style exhaust routing option
- Keeps exhaust heat away from your passenger
- Works with most major manufacturers slip-ons and OE
- True dual headpipes with no crossover
- Bike runs cooler, eliminates heat under the riders left side
- Front headpipe under frame is not restricted or reduced
- 1¾" headers and 220° 16 gauge heavy duty full coverage 2½" heat shields
- O2 ports & plugs provided for early models
- Complete with mounting hardware and brackets
- Optional slip-ons shown, sold separately

Not legal for use in California on pollution controlled vehicles - check local laws before installation

Application	Year	Chrome	Black
FLH/FLT	'95-08	<b>82-00371</b>	<b>82-00372</b>
	'09-16	<b>82-00238</b>	<b>82-00239</b>
	'17-Up	<b>82-00653</b>	<b>82-00654</b>
Trike models	* '08-16	<b>82-00238</b>	<b>82-00239</b>

\*82-09025 Adapter required for Trike models



- WINDSHIELDS / FAIRINGS
- AUDIO / COMMUNICATION
- SEATS / LUGGAGE
- BARS / MIRRORS / CONTROLS
- EXHAUST
- AIR / FUEL SYSTEMS
- ENGINE
- TRANSMISSION / DRIVELINE
- GASKETS / SEALS
- ELECTRICAL
- LIGHTING
- CABLES
- BRAKES
- OIL FILTERS
- SUSPENSION
- BODY
- WHEELS
- TIRES / TIRE ACC.
- BIKE ACC.
- VICTORY / INDIAN
- COVERS / LOCKS / TIEDOWNS
- CHEMICALS
- TOOLS
- HELMETS
- HELMET ACC.
- EYEWEAR
- APPAREL / RIDER ACC.
- PROMOTIONAL
- REFERENCE
- INDEX

**SLIP-ON EXHAUST FOR HARLEY DAVIDSON  
DRESSER/TOURING FLH/FLT MODELS**



Feel the POWER of FREEDOM



- Freedom Performance slip-ons deliver the perfect sound and performance for Dressers.
- With exceptional engineering, superior manufacturing, stylish finishes and end tips, you'll get the best in quality and performance that your money can buy.
- No matter which slip-ons you choose, you'll get increased power and a unique crisp throttle response.
- For the best power match up available, take a look at the Freedom standard true duals, sold separately.
- Made in the U.S.A.!
- Parts marked \* are not legal for use in California on pollution controlled vehicles - check local laws before installation

**AMERICAN OUTLAW**

Application	Year	Chrome	Chrome/Bik Sculpted Tip	Black/Bik Sculpted Tip	Pitch Black	Quiet Baffle
FLH/FLT and Trikes w/oe Duals	'17-Up	<b>82-00623</b>	<b>82-00624</b>	<b>82-00625</b>	<b>82-00626</b>	<b>82-09006</b>
	'09-16	<b>82-00260</b>	<b>82-00262</b>	<b>82-00263</b>	<b>82-00423</b>	

\* Not legal for use in California on pollution controlled vehicles - check local laws before installation



**LIBERTY**



Application	Year	Chrome/Chrome Tip	Chrome/Bik Sculpted tip	Black/Bik Sculpted Tip	Pitch Black
FLH/FLT and Trikes w/ oe Duals	'17-Up	<b>82-00613</b>	<b>82-00614</b>	<b>82-00615</b>	<b>82-00616</b>
	'09-16	<b>82-00013</b>			

\* Not legal for use in California on pollution controlled vehicles - check local laws before installation



**CLASSIC**

Application	Year	Chrome	Quiet Baffle
FLH/FLT and Trikes w/ oe duals	'09-16	<b>82-00150</b>	<b>82-09002</b>
	'95-08	<b>82-60150 *</b>	

\* Not legal for use in California on pollution controlled vehicles - check local laws before installation



**INVERTED**

Application	Year	Chrome	Quiet Baffle
FLH/FLT and Trikes w/ oe duals	'09-16	<b>82-00140</b>	<b>82-09002</b>
	'95-08	<b>82-60140 *</b>	

\* Not legal for use in California on pollution controlled vehicles - check local laws before installation



**EAGLE**

Application	Year	Chrome	Chrome/Bik Sculpted Tip	Black/Bik Sculpted Tip	Pitch Black
FLH/FLT and Trikes w/ oe duals	'17-Up	<b>82-00617</b>	<b>82-00618</b>	<b>82-00619</b>	<b>82-00620</b>
	'09-16	<b>82-00373</b>	<b>82-00374</b>	<b>82-00375</b>	

\* Not legal for use in California on pollution controlled vehicles - check local laws before installation

WINDSHIELDS / FAIRINGS  
AUDIO / COMMUNICATION  
SEATS / LUGGAGE  
BARS / MIRRORS / CONTROLS  
**EXHAUST**  
AIR / FUEL SYSTEMS  
ENGINE  
TRANSMISSION / DRIVELINE  
GASKETS / SEALS  
ELECTRICAL  
LIGHTING  
CABLES  
BRAKES  
OIL FILTERS  
SUSPENSION  
BODY  
WHEELS  
TIRES / TIRE ACC.  
BIKE ACC.  
VICTORY / INDIAN  
COVERS / LOCKS / TIEDOWNS  
CHEMICALS  
TOOLS  
HELMETS  
HELMET ACC.  
EYEWEAR  
APPAREL / RIDER ACC.  
PROMOTIONAL  
REFERENCE  
INDEX



Feel the POWER of FREEDOM



**SLIP-ON EXHAUST FOR HARLEY DAVIDSON DRESSER/TOURING FLH/FLT MODELS**

- WINDSHIELDS / FAIRINGS
- AUDIO / COMMUNICATION
- SEATS / LUGGAGE
- BAR / MIRRORS / CONTROLS
- EXHAUST**
- AIR / FUEL SYSTEMS
- ENGINE
- TRANSMISSION / DRIVELINE
- GASKETS / SEALS
- ELECTRICAL
- LIGHTING
- CABLES
- BRAKES
- OIL FILTERS
- SUSPENSION
- BODY
- WHEELS
- TIRES / TIRE ACC.
- BIKE ACC.
- VICTORY / INDIAN
- COVERS / LOCKS / TIEDOWNS
- CHEMICALS
- TOOLS
- HELMETS
- HELMET ACC.
- EYEWEAR
- APPAREL / RIDER ACC.
- PROMOTIONAL
- REFERENCE
- INDEX

**4" RACING**



Application	Year	Chrome	Chrome/Blk Sculpted Tip	Black/Blk Sculpted tip	Black/Chrome Tip	Pitch Black	Quiet Baffle
FLH/FLT and Trikes w/ oe Duals	'17-Up	<b>82-00609</b>	<b>82-00610</b>	<b>82-00611</b>		<b>82-00612</b>	
	'09-16	<b>82-00174</b>	<b>82-00178</b>	<b>82-00180</b>	<b>82-00176</b>		<b>82-09002</b>

**4.5" COMBAT SLIP-ONS**



Application	Year	Chrome	Chrome/Blk Sculpted Tip	Black/Blk Sculpted Tip	Pitch Black
FLH/FLT and Trikes w/ oe Duals	'17-Up	<b>82-00627</b>	<b>82-00628</b>	<b>82-00629</b>	<b>82-00630</b>
	'95-16	<b>82-00410</b>	<b>82-00411</b>	<b>82-00412</b>	

**SHARKTAIL**



Application	Year	Size	Chrome	Black
FLH/FLT and Trikes w/ oe Duals	'09-16	2 1/8" OD x 32" (no heat shield)	<b>82-00022</b>	<b>82-00132</b>
	'09-16	2 1/8" OD x 36" (no heat shield)	<b>82-00092</b>	
	'09-16	2 1/2 " OD x 32"	<b>82-00349</b>	



**4" INCH SHARKTAILS**

Application	Year	Chrome	Pitch Black
FLH/FLT w/ oe duals	'17-Up	82-00621	82-00622



- WINDSHIELDS / FAIRINGS
- AUDIO / COMMUNICATION
- SEATS / LUGGAGE
- BAR / MIRRORS / CONTROLS
- EXHAUST**
- AIR / FUEL SYSTEMS
- ENGINE
- TRANSMISSION / DRIVELINE
- GASKETS / SEALS
- ELECTRICAL
- LIGHTING
- CABLES
- BRAKES
- OIL FILTERS
- SUSPENSION
- BODY
- WHEELS
- TIRES / TIRE ACC.
- BIKE ACC.
- VICTORY / INDIAN
- COVERS / LOCKS / TIEDOWNS
- CHEMICALS
- TOOLS
- HELMETS
- HELMET ACC.
- EYEWEAR
- APPAREL / RIDER ACC.
- PROMOTIONAL
- REFERENCE
- INDEX



Feel the POWER of FREEDOM

# COMPLETE EXHAUST FOR HARLEY DAVIDSON SOFTAIL MODELS

## AMERICAN OUTLAW DUAL SYSTEMS



Application	Year	Chrome w/ chrome tip	Chrome w/ black tip	Quiet Baffles
Softail	'07-17	82-00292	82-00293	82-09006

## PATRIOT LG SYSTEMS



Application	Year	Chrome	Black	Quiet Baffle
Softail	'86-17	82-00032	82-00039	82-09013

## UP SWEEPS W/ FISHTAIL ENDCAPS



Application	Exh. Style	Year	Chrome	Black	Quiet Baffle
Softail	Fishtail end cap	'86-17	82-00264	82-00265	82-09013

- WINDSHIELDS / FAIRINGS
- AUDIO / COMMUNICATION
- SEATS / LUGGAGE
- BARS / MIRRORS / CONTROLS
- EXHAUST**
- AIR / FUEL SYSTEMS
- ENGINE
- TRANSMISSION / DRIVELINE
- GASKETS / SEALS
- ELECTRICAL
- LIGHTING
- CABLES
- BRAKES
- OIL FILTERS
- SUSPENSION
- BODY
- WHEELS
- TIRES / TIRE ACC.
- BIKE ACC.
- VICTORY / INDIAN
- COVERS / LOCKS / TIEDOWNS
- CHEMICALS
- TOOLS
- HELMETS
- HELMET ACC.
- EYEWEAR
- APPAREL / RIDER ACC.
- PROMOTIONAL
- REFERENCE
- INDEX

**COMPLETE EXHAUST FOR HARLEY DAVIDSON SOFTAIL MODELS**



**DECLARATION TURN OUT SYSTEMS**

Application	Year	Chrome	Black	Quiet Baffle
Softail	'86-17	<b>82-00034</b>	<b>82-00041</b>	<b>82-09013</b>



**INDEPENDENCE SHORTY AND LG SYSTEMS**



Application	Exh. Style	Year	Chrome	Black	Quiet Baffle
Softail	Shorty	'86-17	<b>82-00033</b>	<b>82-00040</b>	<b>82-09013</b>
Softail	LG	'86-17	<b>82-00031</b>	<b>82-00038</b>	<b>82-09013</b>

**RACING DUAL SYSTEMS**



Application	Year	Chrome w/ chrome tip	Chrome w/ black tip	Black w/ black tip	Quiet Baffle
Softail	'97-06	<b>82-00220</b>	<b>82-00222</b>	<b>82-00221</b>	<b>82-09003</b>
	'07-17	<b>82-00200</b>	<b>82-00204</b>	<b>82-00201</b>	<b>82-09003</b>

- WINDSHIELDS / FAIRINGS
- AUDIO / COMMUNICATION
- SEATS / LUGGAGE
- BARS / MIRRORS / CONTROLS
- EXHAUST**
- AIR / FUEL SYSTEMS
- ENGINE
- TRANSMISSION / DRIVELINE
- GASKETS / SEALS
- ELECTRICAL
- LIGHTING
- CABLES
- BRAKES
- OIL FILTERS
- SUSPENSION
- BODY
- WHEELS
- TIRES / TIRE ACC.
- BIKE ACC.
- VICTORY / INDIAN
- COVERS / LOCKS / TIEDOWNS
- CHEMICALS
- TOOLS
- HELMETS
- HELMET ACC.
- EYEWEAR
- APPAREL / RIDER ACC.
- PROMOTIONAL
- REFERENCE
- INDEX



Feel the POWER of FREEDOM

# COMPLETE EXHAUST FOR HARLEY DAVIDSON SOFTAIL MODELS



EXHAUST

## UNION 2 INTO 1 SYSTEMS

- The world's only 5-step Softail 2 into 1 performance exhaust system
- 3 step header pipes 1 3/4" to 1 7/8" to 2" for anti-reversion, full range torque and horsepower
- Exclusive 2 step removable baffle 2 1/2" to 3" with optional quiet baffle available
- 2 1/2" 220° one piece heavy duty 16 guage heat shields
- 4" diameter slash-cut end cap with rolled edge that mounts slash up or slash down
- O2 ports and plugs provided
- Complete with mounting hardware and brackets

Not legal for use in California on pollution controlled vehicles - check local laws before installation



Application	Year	Chrome	Black	Quiet Baffle
Softail	'86-17	82-00036	82-00109	82-09015

## AMERICAN OUTLAW HIGH 2 INTO 1 SYSTEMS

- Premier performance 5-step, 4 1/2" megaphone 2-into-1 exhaust system
- Triple stepped headers for anti-reversion, full range torque and optimal horsepower
- 2 1/2" to 3" double stepped performance baffles
- 16 gauge heavy duty 220° blue proof shields available in chrome or black hi-temp finish
- O2 ports & plugs provided for early models provided
- Complete with mounting hardware and brackets
- Requires removal of rear pegs
- Deep throaty sound
- Made in the U.S.A.!

Not legal for use in California on pollution controlled vehicles - check local laws before installation



Application	Year	Chrome	Black	Quiet Baffles
Softail	'86-17	82-00296	82-00297	82-09007

WINDSHIELDS / FAIRINGS  
AUDIO / COMMUNICATION  
SEATS / LUGGAGE  
BARS / MIRRORS / CONTROLS  
EXHAUST  
AIR / FUEL SYSTEMS  
ENGINE  
TRANSMISSION / DRIVELINE  
GASKETS / SEALS  
ELECTRICAL  
LIGHTING  
CABLES  
BRAKES  
OIL FILTERS  
SUSPENSION  
BODY  
WHEELS  
TIRES / TIRE ACC.  
BIKE ACC.  
VICTORY / INDIAN  
COVERS / LOCKS / TIEDOWNS  
CHEMICALS  
TOOLS  
HELMETS  
HELMET ACC.  
EYEWEAR  
APPAREL / RIDER ACC.  
PROMOTIONAL  
REFERENCE  
INDEX

**COMPLETE EXHAUST FOR HARLEY DAVIDSON SOFTAIL MODELS**



**SHARKTAIL SYSTEMS**

Application	Year	Muffler Length	Chrome	Black	Quiet Baffle
Softail	'97-06	32"	<b>82-00202</b>	<b>82-00327</b>	<b>82-09013</b>
	'97-06	36"	<b>82-00328</b>		<b>82-09013</b>
	'97-06	39"	<b>82-00450</b>	<b>82-00322</b>	<b>82-09013</b>
	'07-17	32"	<b>82-00203</b>		<b>82-09013</b>
	'07-17	36"	<b>82-00323</b>		<b>82-09013</b>
	'07-17	39"	<b>82-00452</b>		

**RADICAL RADIUS SYSTEMS**



Application	Year	Chrome	Chrome/Blk Tip	Black
Softail	'18-Up	<b>82-00707</b>	<b>82-00708</b>	<b>82-00709</b>
	'86-17	<b>82-00396</b>	<b>82-00425</b>	<b>82-00397</b>

**SHARP CURVE RADIUS SYSTEMS**



Application	Year	Chrome	Chrome/Blk Tip	Black
Softail	'18-Up	<b>82-00701</b>	<b>82-00702</b>	<b>82-00703</b>
	'86-17	<b>82-00210</b>		<b>82-00211</b>

- WINDSHIELDS / FAIRINGS
- AUDIO / COMMUNICATION
- SEATS / LUGGAGE
- BARS / MIRRORS / CONTROLS
- EXHAUST**
- AIR / FUEL SYSTEMS
- ENGINE
- TRANSMISSION / DRIVELINE
- GASKETS / SEALS
- ELECTRICAL
- LIGHTING
- CABLES
- BRAKES
- OIL FILTERS
- SUSPENSION
- BODY
- WHEELS
- TIRES / TIRE ACC.
- BIKE ACC.
- VICTORY / INDIAN
- COVERS / LOCKS / TIEDOWNS
- CHEMICALS
- TOOLS
- EYEWEAR
- APPAREL / RIDER ACC.
- PROMOTIONAL
- REFERENCE
- INDEX



**COMPLETE EXHAUST FOR HARLEY DAVIDSON  
ROCKER SOFTAIL FXC AND BREAKOUT FXSB  
MODELS**

**SHARP CURVE RADIUS SYSTEMS**

Application	Year	Chrome	Black
Rocker FXC	'08-11	<b>82-00242</b>	<b>82-00243</b>
Breakout FXSB	'13-17	<b>82-00242</b>	<b>82-00243</b>



**AMENDMENT SYSTEMS**

Application	Year	Chrome	Black	Quiet Baffle
Rocker FXC	'08-11	<b>82-00248</b>	<b>82-00252</b>	<b>82-09013</b>
Breakout FXSB	'13-17	<b>82-00248</b>	<b>82-00252</b>	<b>82-09013</b>



- WINDSHIELDS / FAIRINGS
- AUDIO / COMMUNICATION
- SEATS / LUGGAGE
- BARS / MIRRORS / CONTROLS
- EXHAUST**
- AIR / FUEL SYSTEMS
- ENGINE
- TRANSMISSION / DRIVELINE
- GASKETS / SEALS
- ELECTRICAL
- LIGHTING
- CABLES
- BRAKES
- OIL FILTERS
- SUSPENSION
- BODY
- WHEELS
- TIRES / TIRE ACC.
- BIKE ACC.
- VICTORY / INDIAN
- COVERS / LOCKS / TIEDOWNS
- CHEMICALS
- TOOLS
- HELMETS
- HELMET ACC.
- EYEWEAR
- APPAREL / RIDER ACC.
- PROMOTIONAL
- REFERENCE
- INDEX

**M8 FATBOB SLIPONS**



Feel the **POWER** of **FREEDOM**



Application	Year	Chrome	Chrome/Blk Tip	Black
Fatbob	'18-Up	<b>82-00718</b>	<b>82-00719</b>	<b>82-00720</b>



- WINDSHIELDS / FAIRINGS
- AUDIO / COMMUNICATION
- SEATS / LUGGAGE
- BARS / MIRRORS / CONTROLS
- EXHAUST**
- AIR / FUEL SYSTEMS
- ENGINE
- TRANSMISSION / DRIVELINE
- GASKETS / SEALS
- ELECTRICAL
- LIGHTING
- CABLES
- BRAKES
- OIL FILTERS
- SUSPENSION
- BODY
- WHEELS
- TIRES / TIRE ACC.
- BIKE ACC.
- VICTORY / INDIAN
- COVERS / LOCKS / TIEDOWNS
- CHEMICALS
- TOOLS
- HELMETS
- HELMET ACC.
- EYEWEAR
- APPAREL / RIDER ACC.
- PROMOTIONAL
- REFERENCE
- INDEX



**SLIP-ON EXHAUST FOR HARLEY DAVIDSON SOFTAIL MODELS**



Feel the POWER of FREEDOM



**3-1/4" RACING SLIP-ONS**

Application	Year	Chrome	Black/Blk Tip	Chrome/Blk Tip	Quiet Baffle
All Softails Except Fatbob	'18-Up	<b>82-00712</b>	<b>82-00714</b>	<b>82-00713</b>	
FLSTF/FXSTD	'07-17	<b>82-00310</b>	<b>82-00359</b>		<b>82-09010</b>
FLSTN/FXSTB	'07-17	<b>82-00311</b>	<b>82-00360</b>		<b>82-09010</b>
FXSTS/FXSTB/FXST/FLSTC/FLST/FXCWC	'07-17	<b>82-00312</b>	<b>82-00361</b>		<b>82-09009</b>



**3-1/4" SIGNATURE SLIP-ONS**

Application	Year	Chrome	Chrome/Blk Tip	Black/Blk Tip	Quiet Baffle
All Softails except Fatbobs	'18-Up	<b>82-00715</b>	<b>82-00716</b>	<b>82-00717</b>	
FLSTF/FXSTD	'07-17	<b>82-00185</b>	<b>82-00188</b>	<b>82-00365</b>	<b>82-09010</b>
FLSTN/FXSTB	'07-17	<b>82-00186</b>	<b>82-00189</b>	<b>82-00366</b>	<b>82-09010</b>
FXSTS/FXSTB/FXST/FLSTC/FLST/FXCWC/FLS	'07-17	<b>82-00187</b>	<b>82-00190</b>	<b>82-00367</b>	<b>82-09009</b>

**COMPLETE EXHAUST FOR HARLEY DAVIDSON SOFTAIL MODELS**

**AMENDMENT SYSTEMS**



Application	Year	Chrome	Quiet Baffle
Softail	'86-17	<b>82-00035</b>	<b>82-09013</b>

- WINDSHIELDS / FAIRINGS
- AUDIO / COMMUNICATION
- SEATS / LUGGAGE
- BARS / MIRRORS / CONTROLS
- EXHAUST**
- AIR / FUEL SYSTEMS
- ENGINE
- TRANSMISSION / DRIVELINE
- GASKETS / SEALS
- ELECTRICAL
- LIGHTING
- CABLES
- BRAKES
- OIL FILTERS
- SUSPENSION
- BODY
- WHEELS
- TIRES / TIRE ACC.
- BIKE ACC.
- VICTORY / INDIAN
- COVERS / LOCKS / TIEDOWNS
- CHEMICALS
- TOOLS
- HELMETS
- HELMET ACC.
- EYEWEAR
- APPAREL / RIDER ACC.
- PROMOTIONAL
- REFERENCE
- INDEX





**COMPLETE EXHAUST FOR HARLEY DAVIDSON DYNA FXD MODELS**



**INDEPENDENCE SHORTY AND LG SYSTEMS**

- 2 step performance system for anti-reversion, full range torque and optimal horsepower
- 2 1/2" O.D. full 220° one-piece 16 gauge heavy duty heat shields
- Removable baffles, quiet style available
- O2 ports & plugs provided for early models
- Offered in Chrome or Black hi-temp finish
- Complete with mounting hardware and brackets
- Hot Rod sound!

Not legal for use in California on pollution controlled vehicles - check local laws before installation



Application	Exh. Style	Year	Chrome	Black	Quiet Baffle
Dyna FXD	Shorty	'91-05	82-00018	82-00070	82-09013
	LG	'91-05	82-00016	82-00068	82-09013
Dyna FXD	Shorty	'06-17	82-00059	82-00046	82-09013
	LG	'06-17	82-00057	82-00044	82-09013

- WINDSHIELDS / FAIRINGS
- AUDIO / COMMUNICATION
- SEATS / LUGGAGE
- BARS / MIRRORS / CONTROLS
- EXHAUST**
- AIR / FUEL SYSTEMS
- ENGINE
- TRANSMISSION / DRIVELINE
- GASKETS / SEALS
- ELECTRICAL
- LIGHTING
- CABLES
- BRAKES
- OIL FILTERS
- SUSPENSION
- BODY
- WHEELS
- TIRES / TIRE ACC.
- BIKE ACC.
- VICTORY / INDIAN
- COVERS / LOCKS / TIEDOWNS
- CHEMICALS
- TOOLS
- HELMETS
- HELMET ACC.
- EYEWEAR
- APPAREL / RIDER ACC.
- PROMOTIONAL
- REFERENCE
- INDEX



**COMPLETE EXHAUST FOR HARLEY DAVIDSON DYNA FXD MODELS**

Feel the **POWER** of **FREEDOM**

**RADICAL RADIUS SYSTEMS**



Application	Year	Chrome	Black
Dyna FXD	'06-17	<b>82-00398</b>	<b>82-00399</b>



**UNION 2 INTO 1 SYSTEMS**

Application	Year	Chrome	Chrome w/ Black Tip
Dyna FXD	'91-05	<b>82-00021</b>	<b>82-00378</b>
	'06-17	<b>82-00062</b>	<b>82-00379</b>



- WINDSHIELDS / FAIRINGS
- AUDIO / COMMUNICATION
- SEATS / LUGGAGE
- BARS / MIRRORS / CONTROLS
- EXHAUST**
- AIR / FUEL SYSTEMS
- ENGINE
- TRANSMISSION / DRIVELINE
- GASKETS / SEALS
- ELECTRICAL
- LIGHTING
- CABLES
- BRAKES
- OIL FILTERS
- SUSPENSION
- BODY
- WHEELS
- TIRES / TIRE ACC.
- BIKE ACC.
- VICTORY / INDIAN
- COVERS / LOCKS / TIEDOWNS
- CHEMICALS
- TOOLS
- HELMETS
- HELMET ACC.
- EYEWEAR
- APPAREL / RIDER ACC.
- PROMOTIONAL
- REFERENCE
- INDEX

**COMPLETE EXHAUST FOR HARLEY DAVIDSON DYNA FXD MODELS**



**PATRIOT LG SYSTEMS**



Application	Year	Chrome	Black	Quiet Baffle
Dyna FXD	'06-17	82-00058	82-00045	82-09013

**DECLARATION TURN-OUTS**



Application	Year	Chrome	Black	Quiet Baffle
Dyna FXD	'91-05	82-00019	82-00071	82-09013
	'06-17	82-00060	82-00047	82-09013

- WINDSHIELDS / FAIRINGS
- AUDIO / COMMUNICATION
- SEATS / LUGGAGE
- BAR / MIRRORS / CONTROLS
- EXHAUST**
- AIR / FUEL SYSTEMS
- ENGINE
- TRANSMISSION / DRIVELINE
- GASKETS / SEALS
- ELECTRICAL
- LIGHTING
- CABLES
- BRAKES
- OIL FILTERS
- SUSPENSION
- BODY
- WHEELS
- TIRES / TIRE ACC.
- BIKE ACC.
- VICTORY / INDIAN
- COVERS / LOCKS / TIEDOWNS
- CHEMICALS
- TOOLS
- HELMETS
- HELMET ACC.
- EYEWEAR
- APPAREL / RIDER ACC.
- PROMOTIONAL
- REFERENCE
- INDEX



**COMPLETE EXHAUST FOR HARLEY DAVIDSON DYNA FXD MODELS**

Feel the POWER of FREEDOM

**SHARP CURVE RADIUS SYSTEMS**



Application	Year	Chrome	Black	Quiet Baffle
Dyna FXD	'91-05	<b>82-00258</b>	<b>82-00259</b>	<b>82-09005</b>
	'06-17	<b>82-00218</b>	<b>82-00219</b>	<b>82-09004</b>



**AMENDMENT SYSTEMS**



Application	Year	Chrome	Black	Quiet Baffle
Dyna FXD	'91-05	<b>82-00020</b>	<b>82-00072</b>	<b>82-09013</b>
	'06-17	<b>82-00061</b>	<b>82-00048</b>	<b>82-09013</b>

- WINDSHIELDS / FAIRINGS
- AUDIO / COMMUNICATION
- SEATS / LUGGAGE
- BARS / MIRRORS / CONTROLS
- EXHAUST**
- AIR / FUEL SYSTEMS
- ENGINE
- TRANSMISSION / DRIVELINE
- GASKETS / SEALS
- ELECTRICAL
- LIGHTING
- CABLES
- BRAKES
- OIL FILTERS
- SUSPENSION
- BODY
- WHEELS
- TIRES / TIRE ACC.
- BIKE ACC.
- VICTORY / INDIAN
- COVERS / LOCKS / TIEDOWNS
- CHEMICALS
- TOOLS
- HELMETS
- HELMET ACC.
- EYEWEAR
- APPAREL / RIDER ACC.
- PROMOTIONAL
- REFERENCE
- INDEX

# SLIP-ON EXHAUST FOR HARLEY DAVIDSON DYNA FXD MODELS



3 1/4" RACING SLIP-ONS

Application	Year	Chrome	Chrome/Blk Tip	Black/Blk Tip	Quiet Baffle
FXD,FXDB,FXDB-D,FXDB-S,FXDC,FXD6,FXDX,FXDS-CONV,FXDXT,FXDL	'91-17	82-00316	82-00317	82-00362	82-09008
FXDF Fat Bob	'08-17	82-00318	82-00319	82-00363	82-09010
FXDWG Dyna Wide Glide	'10-17	82-00318	82-00319	82-00363	82-09010



3 1/4" SIGNATURE SLIP-ONS

Application	Year	Chrome	Chrome/Blk Tip	Black/Blk Tip	Quiet Baffle
FXD,FXDB,FXDB-D,FXDB-S,FXDC,FXD6,FXDX,FXDS-CONV,FXDXT,FXDL	'91-17	82-00191	82-00192	82-00368	82-09008
FXDF FAT BOB	'08-17	82-00194	82-00195	82-00369	82-09010
FXDWG DYNA WIDE GLIDE	'10-17	82-00194	82-00195	82-00369	82-09010



# SLIP-ON EXHAUST FOR HARLEY DAVIDSON DYNA FLD & FXDL MODELS



4" EAGLE SLIP-ONS



Application	Year	Chrome w/ Chrome Tip	Chrome w/ Black Tip	Black w/ Black Tip
FLD/FXDL	'14-17	82-00354	82-00469	82-00470



4" LIBERTY SLIP-ONS



Application	Year	Chrome w/ Chrome Tip	Chrome w/ Black Tip	Black w/ Black Tip
FLD/FXDL	'14-17	82-00471	82-00472	82-00473

- WINDSHIELDS / FAIRINGS
- AUDIO / COMMUNICATION
- SEATS / LUGGAGE
- BARS / MIRRORS / CONTROLS
- EXHAUST**
- AIR / FUEL SYSTEMS
- ENGINE
- TRANSMISSION / DRIVELINE
- GASKETS / SEALS
- ELECTRICAL
- LIGHTING
- CABLES
- BRAKES
- OIL FILTERS
- SUSPENSION
- BODY
- WHEELS
- TIRES / TIRE ACC.
- BIKE ACC.
- VICTORY / INDIAN
- COVERS / LOCKS / TIEDOWNS
- CHEMICALS
- TOOLS
- HELMETS
- HELMET ACC.
- EYEWEAR
- APPAREL / RIDER ACC.
- PROMOTIONAL
- REFERENCE
- INDEX



Feel the POWER of FREEDOM



# COMPLETE EXHAUST FOR HARLEY DAVIDSON SPORTSTER XL MODELS

## STAGGERED DUALS

- 2 step performance system for anti-reversion, full range torque and optimal horsepower
- 2½" O.D. full 220° one-piece 16 gauge heavy duty heat shields
- Removable baffles
- O2 ports & plugs provided for early models
- Complete with mounting hardware and brackets
- Fits forward & mid controls
- Hot Rod sound!

Not legal for use in California on pollution controlled vehicles - check local laws before installation

Application	Year	Chrome w/ Black tip	Black w/ Chrome tip
Sportster XL	'04-17	82-00382	82-00383



## INDEPENDENCE SHORTY AND LG SYSTEMS

- 2 step performance system for anti-reversion, full range torque and optimal horsepower
- 2½" O.D. full 220° one-piece 16 gauge heavy duty heat shields
- Removable baffles
- O2 ports & plugs provided for early models
- Complete with mounting hardware and brackets
- Fits forward & mid controls
- Hot Rod sound!

Not legal for use in California on pollution controlled vehicles - check local laws before installation



Application	Exh. Style	Year	Chrome	Black	Quiet Baffle
Sportster XL	Shorty	'14-17 *	82-00400	82-00403	82-09013
	LG	'04-13	82-00114	82-00115	82-09013

\*Chrome comes with Black Tip  
\*Black comes with Chrome Tip

- WINDSHIELDS / FAIRINGS
- AUDIO / COMMUNICATION
- SEATS / LUGGAGE
- BARS / MIRRORS / CONTROLS
- EXHAUST
- AIR / FUEL SYSTEMS
- ENGINE
- TRANSMISSION / DRIVELINE
- GASKETS / SEALS
- ELECTRICAL
- LIGHTING
- CABLES
- BRAKES
- OIL FILTERS
- SUSPENSION
- BODY
- WHEELS
- TIRES / TIRE ACC.
- BIKE ACC.
- VICTORY / INDIAN
- COVERS / LOCKS / TIEDOWNS
- CHEMICALS
- TOOLS
- HELMETS
- HELMET ACC.
- EYEWEAR
- APPAREL / RIDER ACC.
- PROMOTIONAL
- REFERENCE
- INDEX

**COMPLETE EXHAUST FOR HARLEY DAVIDSON**  **SPORTSTER XL MODELS**

Feel the POWER of FREEDOM



**DECLARATION TURN-OUT SYSTEMS**



Application	Year	Chrome	Black	Quiet Baffle
Sportster XL	'04-17	82-00401	82-00404	82-09013



**PATRIOT INDEPENDENCE LG**



Application	Year	Chrome	Black	Quiet Baffle
Sportster XL	'04-17	82-00118	82-00119	82-09013

- WINDSHIELDS / FAIRINGS
- AUDIO / COMMUNICATION
- SEATS / LUGGAGE
- BARS / MIRRORS / CONTROLS
- EXHAUST**
- AIR / FUEL SYSTEMS
- ENGINE
- TRANSMISSION / DRIVELINE
- GASKETS / SEALS
- ELECTRICAL
- LIGHTING
- CABLES
- BRAKES
- OIL FILTERS
- SUSPENSION
- BODY
- WHEELS
- TIRES / TIRE ACC.
- BIKE ACC.
- VICTORY / INDIAN
- COVERS / LOCKS / TIEDOWNS
- CHEMICALS
- TOOLS
- HELMETS
- HELMET ACC.
- EYEWEAR
- APPAREL / RIDER ACC.
- PROMOTIONAL
- REFERENCE
- INDEX



# COMPLETE EXHAUST FOR HARLEY DAVIDSON SPORTSTER XL MODELS

Feel the POWER of FREEDOM

## XL SHARP CURVE RADIUS HIGH



Application	Year	Chrome	Black
Sportster XL	'86-17	<b>82-00380</b>	<b>82-00381</b>

## SHARP CURVE RADIUS SYSTEMS



Application	Year	Chrome	Black
Sportster XL	'04-13		<b>82-00255</b>
	'14-17	<b>82-00406</b>	<b>82-00407</b>
Passenger peg mount			<b>82-00106A</b>

- WINDSHIELDS / FAIRINGS
- AUDIO / COMMUNICATION
- SEATS / LUGGAGE
- BARS / MIRRORS / CONTROLS
- EXHAUST**
- AIR / FUEL SYSTEMS
- ENGINE
- TRANSMISSION / DRIVELINE
- GASKETS / SEALS
- ELECTRICAL
- LIGHTING
- CABLES
- BRAKES
- OIL FILTERS
- SUSPENSION
- BODY
- WHEELS
- TIRES / TIRE ACC.
- BIKE ACC.
- VICTORY / INDIAN
- COVERS / LOCKS / TIEDOWNS
- CHEMICALS
- TOOLS
- HELMETS
- HELMET ACC.
- EYEWEAR
- APPAREL / RIDER ACC.
- PROMOTIONAL
- REFERENCE
- INDEX



**COMPLETE EXHAUST FOR HARLEY DAVIDSON SPORTSTER XL MODELS**



Feel the POWER of FREEDOM



**AMERICAN OUTLAW HIGH SYSTEMS**



Application	Year	Chrome	Black	Chrome/Black Tip
Sportster XL	'14-17	<b>82-00413</b>	<b>82-00415</b>	<b>82-00414</b>
w/out Heatshields	'14-17	<b>82-00417</b>	<b>82-00418</b>	

**SLIP-ON EXHAUST FOR HARLEY DAVIDSON SPORTSTER XL MODELS**



**3 1/4" RACING SLIP-ONS**

Application	Year	Chrome/Chrome Tip	Chrome/Black Tip	Black/Black Tip	Quiet Baffle
Sportster XL	'04-13	<b>82-00320</b>	<b>82-00321</b>	<b>82-00364</b>	<b>82-09008</b>
	'14-17	<b>82-00389</b>	<b>82-00390</b>	<b>82-00391</b>	<b>82-09008</b>



**3 1/4" SIGNATURE SLIP-ONS**

Application	Year	Chrome/Chrome Tip	Chrome/Blk Tip	Black/Black Tip	Quiet Baffle
Sportster XL	'04-13	<b>82-00197</b>	<b>82-00198</b>	<b>82-00370</b>	<b>82-09008</b>
	'14-17	<b>82-00386</b>	<b>82-00387</b>	<b>82-00388</b>	<b>82-09008</b>



- WINDSHIELDS / FAIRINGS
- AUDIO / COMMUNICATION
- SEATS / LUGGAGE
- BARS / MIRRORS / CONTROLS
- EXHAUST**
- AIR / FUEL SYSTEMS
- ENGINE
- TRANSMISSION / DRIVELINE
- GASKETS / SEALS
- ELECTRICAL
- LIGHTING
- CABLES
- BRAKES
- OIL FILTERS
- SUSPENSION
- BODY
- WHEELS
- TIRES / TIRE ACC.
- BIKE ACC.
- VICTORY / INDIAN
- COVERS / LOCKS / TIEDOWNS
- CHEMICALS
- TOOLS
- HELMETS
- HELMET ACC.
- EYEWEAR
- APPAREL / RIDER ACC.
- PROMOTIONAL
- REFERENCE
- INDEX



**SLIP-ON EXHAUST FOR HARLEY DAVIDSON STREET 750 & 500**

Feel the **POWER** of **FREEDOM**



**4" RACING SLIP-ON**



Application	Year	Chrome/ Chrome Tip	Chrome/ Black Tip	Black/ Black Tip
Street 750 and 500	'15-17	<b>82-00460</b>	<b>82-00461</b>	<b>82-00462</b>

**4" LIBERTY SLIP-ON**



Application	Year	Chrome/ Chrome Tip	Chrome/ Black Tip	Black/Black Tip
Street 750 and 500	'15-17	<b>82-00463</b>	<b>82-00464</b>	<b>82-00465</b>

**4" EAGLE SLIP-ON**



Application	Year	Chrome/ Chrome Tip	Chrome/ Black Tip	Black/ Black Tip
Street 750 and 500	'15-17	<b>82-00466</b>	<b>82-00467</b>	<b>82-00468</b>

- WINDSHIELDS / FAIRINGS
- AUDIO / COMMUNICATION
- SEATS / LUGGAGE
- BARS / MIRRORS / CONTROLS
- EXHAUST**
- AIR / FUEL SYSTEMS
- ENGINE
- TRANSMISSION / DRIVELINE
- GASKETS / SEALS
- ELECTRICAL
- LIGHTING
- CABLES
- BRAKES
- OIL FILTERS
- SUSPENSION
- BODY
- WHEELS
- TIRES / TIRE ACC.
- BIKE ACC.
- VICTORY / INDIAN
- COVERS / LOCKS / TIEDOWNS
- CHEMICALS
- TOOLS
- HELMETS
- HELMET ACC.
- EYEWEAR
- APPAREL / RIDER ACC.
- PROMOTIONAL
- REFERENCE
- INDEX

# SLIP-ON EXHAUST FOR HARLEY DAVIDSON V-ROD VRSCD MODELS



Feel the POWER of FREEDOM



## RACING AND ROLLED EDGE

- 4" Mufflers that fit stock head pipes
- Chrome or black end caps available
- Removable baffles, quiet style available
- Acoustic packing for deep throaty sound
- Bolt on performance and low end torque
- Complete with mounting hardware and brackets
- Fits 2006-2008 Night Rod & 2007-2017 Night Rod Special
- Quiet Baffles sold in pairs

Not legal for use in California on pollution controlled vehicles - check local laws before installation



Application	Exh. Style	Year	Chrome w/ Chrome Tip	Black w/ Black Tip	Quiet Baffle
VRSCD/X	Racing slip-on	'06-17	82-00333	82-00342	82-09012
	Rolled Edge slip-on	'06-17	82-00335		82-09012

## EXHAUST TIPS

- Give your bike a custom look with Freedom End Caps
- Available for most styles in chrome and black
- Change the look of your bike by adding black tips to a chrome pipe or chrome tips to a black pipe
- Easy to install
- Sold each



82-09100



82-09102



82-09101



82-09121



82-09105

Description	Chrome	Black	Black & Contrast
American Outlaw End Cap	82-09100	82-09102	82-09101
Rolled Edge 4"	82-09105		
Racing End Cap 4"	82-09107	82-09108	
Sharktail End Cap 2.5"	82-09125		
Star End Cap 2.5"	82-09115	82-09116	



82-09107



82-09108



82-09125



82-09115



82-09116

- WINDSHIELDS / FAIRINGS
- AUDIO / COMMUNICATION
- SEATS / LUGGAGE
- BARS / MIRRORS / CONTROLS
- EXHAUST**
- AIR / FUEL SYSTEMS
- ENGINE
- TRANSMISSION / DRIVELINE
- GASKETS / SEALS
- ELECTRICAL
- LIGHTING
- CABLES
- BRAKES
- OIL FILTERS
- SUSPENSION
- BODY
- WHEELS
- TIRES / TIRE ACC.
- BIKE ACC.
- VICTORY / INDIAN
- COVERS / LOCKS / TIEDOWNS
- CHEMICALS
- TOOLS
- HELMETS
- HELMET ACC.
- EYEWEAR
- APPAREL / RIDER ACC.
- PROMOTIONAL
- REFERENCE
- INDEX

- WINDSHIELDS / FAIRINGS
- AUDIO / COMMUNICATION
- SEATS / LUGGAGE
- BAR / MIRRORS / CONTROLS
- EXHAUST**
- AIR / FUEL SYSTEMS
- ENGINE
- TRANSMISSION / DRIVELINE
- GASKETS / SEALS
- ELECTRICAL
- LIGHTING
- CABLES
- BRAKES
- OIL FILTERS
- SUSPENSION
- BODY
- WHEELS
- TIRES / TIRE ACC.
- BIKE ACC.
- VICTORY / INDIAN
- COVERS / LOCKS / TIEDOWNS
- CHEMICALS
- TOOLS
- HELMETS
- HELMET ACC.
- EYEWEAR
- APPAREL / RIDER ACC.
- PROMOTIONAL
- REFERENCE
- INDEX



## UPSWEEP PIPE SETS



Description	Application	WPS #
A Upsweep Fishtail Pipes	Fits '86-99 EVOs	<b>830-3500</b>
B	Fits '00-06 Twin Cams	<b>830-3501</b>
C Upsweep Headpipes only	Fits '00-06 Twin Cams	<b>830-3502</b>

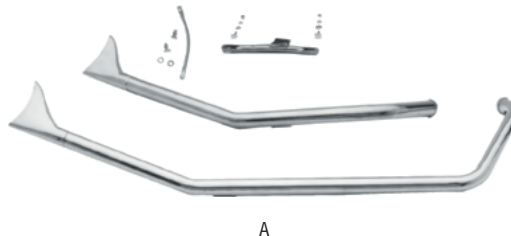

A

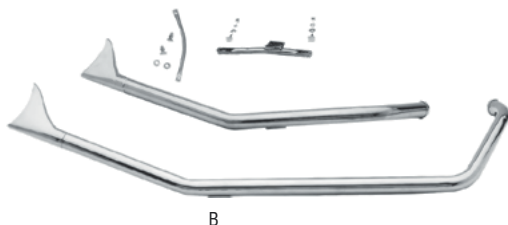

B



C

## SHOVEL HEADPIPES



Application	Description	WPS #
Fits '70-84 4-Spd FL Models	Upsweep Headpipes	<b>830-3505</b>
A	2 into 1 Headpipes	<b>830-3508</b>
	Independent Dual Headpipes	<b>830-3510</b>
B Fits '80-83 5-Spd FLT/FLHT Models		<b>830-3509</b>

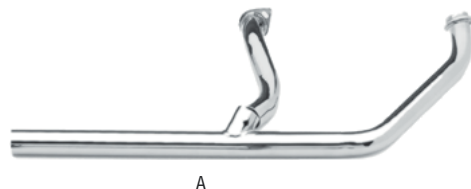

A

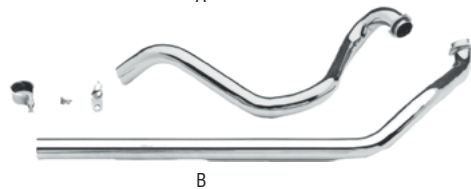

B

## SHOVEL DRAGPIPES



A



B



Application	Description	WPS #
A Fits '70-84 4-Spd FL Models	40" Slash Drag Pipes	<b>830-3506</b>
	Hanger Bracket for 830-3506	<b>830-3512</b>
B	34" Goose Cut Drag Pipes	<b>830-3507</b>

# SPORTY DRAGPIPES



Description	Application	WPS #
40" Drag Pipes	Fits '86-03 XL Models	<b>830-3503</b>
	Fits '04-17 XL Models	<b>830-3504</b>



## FISHTAIL EXTENSIONS

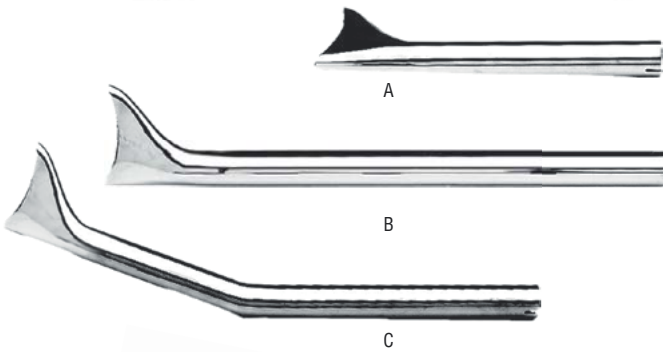

Description	WPS #
A Fishtail Extension 18" Long	<b>830-3026</b>
B Fishtail Extension 31" Long	<b>830-3027</b>
C Fishtail Extension 31" Long Upswept	<b>830-3028</b>

## UNIVERSAL MUFFLERS

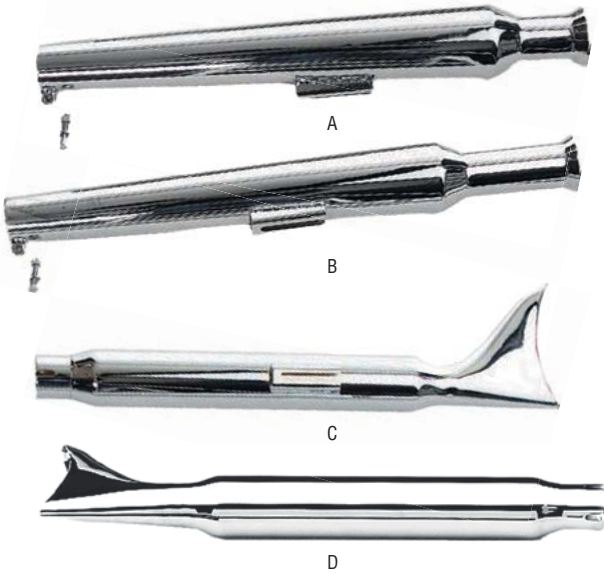

Description	WPS #
3" Turn Down or Turn Out Muffler 31"	<b>830-3020</b>
A Bell Tip Muffler Short 20"	<b>830-3021</b>
B Bell Tip Muffler Long 22"	<b>830-3022</b>
C 2-1/2" Fishtail Muffler 22.5" Right Mounting Slider	<b>830-3023</b>
D 2-1/2" Fishtail Muffler 22.5" No Mounting Slider	<b>830-3024</b>
E 2-1/2" Fishtail Muffler 28"	<b>830-3025</b>

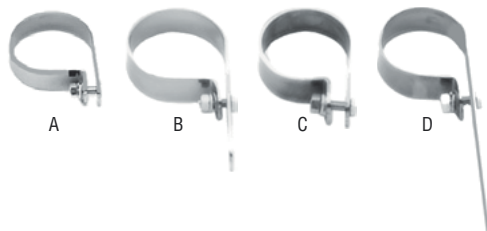
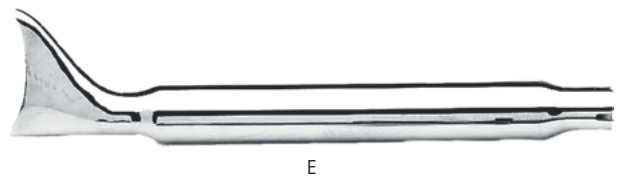

## MUFFLERS CLAMPS



Description	WPS #
Muffler Clamp 3"	<b>830-3050</b>
Muffler P-Clamp 3"	<b>830-3051</b>
Muffler Clamp 2-1/2"	<b>830-3052</b>
Muffler P-Clamp 2-1/2"	<b>830-3053</b>

- WINDSHIELDS / FAIRINGS
- AUDIO / COMMUNICATION
- SEATS / LUGGAGE
- BAR / MIRRORS / CONTROLS
- EXHAUST**
- AIR / FUEL SYSTEMS
- ENGINE
- TRANSMISSION / DRIVELINE
- GASKETS / SEALS
- ELECTRICAL
- LIGHTING
- CABLES
- BRAKES
- OIL FILTERS
- SUSPENSION
- BODY
- WHEELS
- TIRES / TIRE ACC.
- BIKE ACC.
- VICTORY / INDIAN
- COVERS / LOCKS / TIEDOWNS
- CHEMICALS
- TOOLS
- HELMETS
- HELMET ACC.
- EYEWEAR
- APPAREL / RIDER ACC.
- PROMOTIONAL
- REFERENCE
- INDEX

- WINDSHIELDS / FAIRINGS
- AUDIO / COMMUNICATION
- SEATS / LUGGAGE
- BARS / MIRRORS / CONTROLS
- EXHAUST**
- AIR / FUEL SYSTEMS
- ENGINE
- TRANSMISSION / DRIVELINE
- GASKETS / SEALS
- ELECTRICAL
- LIGHTING
- CABLES
- BRAKES
- OIL FILTERS
- SUSPENSION
- BODY
- WHEELS
- TIRES / TIRE ACC.
- BIKE ACC.
- VICTORY / INDIAN
- COVERS / LOCKS / TIEDOWNS
- CHEMICALS
- TOOLS
- HELMETS
- HELMET ACC.
- EYEWEAR
- APPAREL / RIDER ACC.
- PROMOTIONAL
- REFERENCE
- INDEX



## DIY EXHAUST BUILDERS KITS

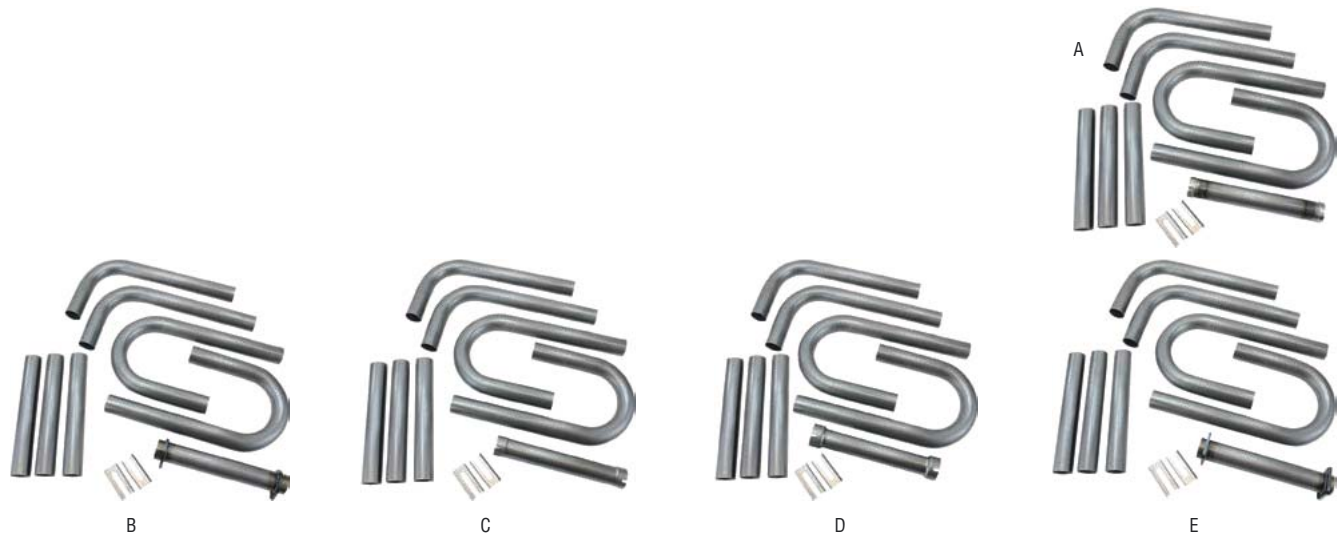

Application	WPS#
A Evo, Twin Cam and Sportster	563-01900
B Shovelhead	563-01901
C Ironhead Sportster '57-85	563-01902
D Panhead	563-01903
E STD Pan and Shovel 3 Bolt	563-01904

## EXHAUST FLANGE KITS



Application	WPS#
A Evo, Twin Cam and Sportster	563-01910
B Shovelhead	563-01911
C Ironhead Sportster	563-01912
D Panhead	563-01913
E STD Pan and Shovel 3 Bolt	563-01914

# UNIVERSAL MUFFLERS

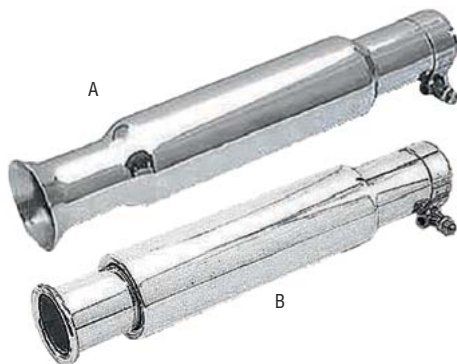

X

Description	WPS #
A Shorty Muffler	750-01700
B Cigar Muffler	750-01701

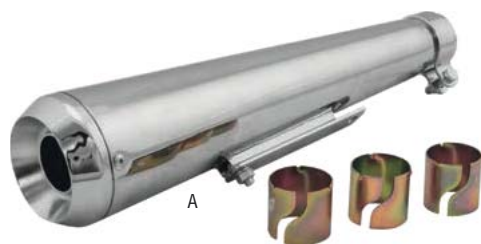

# UNIVERSAL MUFFLERS



Description	WPS#
A Megaphone Muffler	820-0070
B Trumpet w/Black Endcap	820-0071
C Trumpet w/Gold Endcap	820-0072

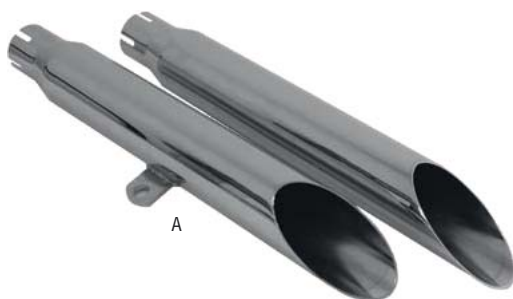

# SLIP-ON MUFFLERS



Application	Year	Type	WPS#
<b>HARLEY DAVIDSON</b>			
A Sportster	'80-03	Slash	56-9770
B Sportster	'04-13	Slash	56-9771
C Sportster	'04-13	Drag	56-9772

- WINDSHIELDS / FAIRINGS
- AUDIO / COMMUNICATION
- SEATS / LUGGAGE
- BAR / MIRRORS / CONTROLS
- EXHAUST**
- AIR / FUEL SYSTEMS
- ENGINE
- TRANSMISSION / DRIVELINE
- GASKETS / SEALS
- ELECTRICAL
- LIGHTING
- CABLES
- BRAKES
- OIL FILTERS
- SUSPENSION
- BODY
- WHEELS
- TIRES / TIRE ACC.
- BIKE ACC.
- VICTORY / INDIAN
- COVERS / LOCKS / TIEDOWNS
- CHEMICALS
- TOOLS
- HELMETS
- HELMET ACC.
- EYEWEAR
- APPAREL / RIDER ACC.
- PROMOTIONAL
- REFERENCE
- INDEX

WINDSHIELDS / FAIRINGS  
 AUDIO / COMMUNICATION  
 SEATS / LUGGAGE  
 BARS / MIRRORS / CONTROLS  
**EXHAUST**  
 AIR / FUEL SYSTEMS  
 ENGINE  
 TRANSMISSION / DRIVELINE  
 GASKETS / SEALS  
 ELECTRICAL  
 LIGHTING  
 CABLES  
 BRAKES  
 OIL FILTERS  
 SUSPENSION  
 BODY  
 WHEELS  
 TIRES / TIRE ACC.  
 BIKE ACC.  
 VICTORY / INDIAN  
 COVERS / LOCKS / TIEDOWNS  
 CHEMICALS  
 TOOLS  
 HELMETS  
 HELMET ACC.  
 EYEWEAR  
 APPAREL / RIDER ACC.  
 PROMOTIONAL  
 REFERENCE  
 INDEX



**UNIVERSAL EXHAUST TIPS**



- Universal exhaust tips for 1-3/4" pipes
- Available in three distinct styles
- Made of machined aluminum or machined brass

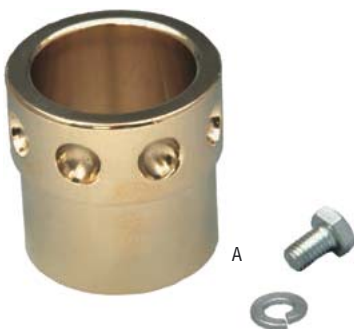

Description	WPS#
A Drilled Exhaust Tip Brass	<b>750-02050</b>
B Drilled Exhaust Tip Contrast	<b>750-02051</b>
C Cage Exhaust Tip Brass	<b>750-02052</b>
D Cage Exhaust Tip Contrast	<b>750-02053</b>
E Revolver Exhaust Tip Brass	<b>750-02054</b>





# UNIVERSAL EXHAUST HEAT SHIELDS



- Fit 1 1/2" - 2" pipes
- Available in black, polished stainless or brass plated steel
- Add a distinctive look to your exhaust while protecting yourself and your gear from excessive heat

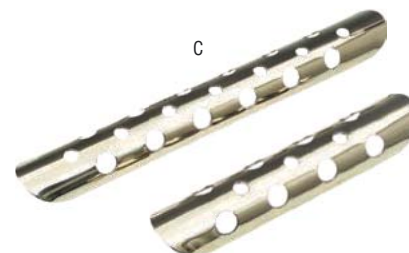

Description	WPS#
A Drilled Heat Shield 10" Long Polished	<b>750-01130</b>
Drilled Heat Shield 16" Long Polished	<b>750-01131</b>
B Bullet Hole Heat Shield 10" Long Black	<b>750-01132</b>
C Bullet Hole Heat Shield 16" Long Brass	<b>750-01133</b>
Bullet Hole Heat Shield 10" Short Brass	<b>750-01134</b>



## HEAT SHIELDS

- Universal clamps fit any pipe, just choose the length you need
- Helps protect you from exhaust pipe heat
- Different styles available to match your bike

Description	Application	WPS#
A Smooth design 7" L x 2.75" W Leg shield	Use on 1.5" - 2" Diameter pipes. Especially useful on '79 Sportster pipes & Shotgun pipes	<b>820-0040</b>
B Slotted design 9" L	fits 1.75" Diameter pipe	<b>820-0043</b>
C Smooth 5" straight shield	fits 1.75" Diameter pipe	<b>820-0063</b>
D Smooth 7" straight shield	fits 1.75" Diameter pipe	<b>820-0064</b>
E Smooth 10" straight shield	fits 1.75" Diameter pipe	<b>820-0060</b>
F Smooth 12" straight shield	fits 1.75" Diameter pipe	<b>820-0061</b>
G Smooth 18" straight shield	fits 1.75" Diameter pipe	<b>820-0062</b>
H Flexible 12" shield	Early Panhead and Knucklehead 1.75" Diameter	<b>820-2656</b>

- WINDSHIELDS / FAIRINGS
- AUDIO / COMMUNICATION
- SEATS / LUGGAGE
- BAR / MIRRORS / CONTROLS
- EXHAUST**
- AIR / FUEL SYSTEMS
- ENGINE
- TRANSMISSION / DRIVELINE
- GASKETS / SEALS
- ELECTRICAL
- LIGHTING
- CABLES
- BRAKES
- OIL FILTERS
- SUSPENSION
- BODY
- WHEELS
- TIRES / TIRE ACC.
- BIKE ACC.
- VICTORY / INDIAN
- COVERS / LOCKS / TIEDOWNS
- CHEMICALS
- TOOLS
- HELMETS
- HELMET ACC.
- EYEWEAR
- APPAREL / RIDER ACC.
- PROMOTIONAL
- REFERENCE
- INDEX

- WINDSHIELDS / FAIRINGS
- AUDIO / COMMUNICATION
- SEATS / LUGGAGE
- BARS / MIRRORS / CONTROLS
- EXHAUST**
- AIR / FUEL SYSTEMS
- ENGINE
- TRANSMISSION / DRIVELINE
- GASKETS / SEALS
- ELECTRICAL
- LIGHTING
- CABLES
- BRAKES
- OIL FILTERS
- SUSPENSION
- BODY
- WHEELS
- TIRES / TIRE ACC.
- BIKE ACC.
- VICTORY / INDIAN
- COVERS / LOCKS / TIEDOWNS
- CHEMICALS
- TOOLS
- HELMETS
- HELMET ACC.
- EYEWEAR
- APPAREL / RIDER ACC.
- PROMOTIONAL
- REFERENCE
- INDEX



## EXHAUST MOUNTING FLANGE KIT

- Chrome plated flange looks great
- Includes retaining rings

Description	Application	WPS#
Exhaust Mounting Flange & Retaining Ring Kit	'84-Up Big Twins; '86-Up XL	<b>820-0160</b>
Exhaust Flange Retaining Rings 10pk		<b>820-50201</b>



## T-BOLT SET

- Sold in pairs
- Replacement for all mufflers



WPS#
<b>820-2642</b>

## RUBBER MUFFLER MOUNTS

- Sold in pairs
- OEM replacement



WPS#
<b>820-2641</b>

## O<sup>2</sup> SENSOR ADAPTERS

- Kit includes sensor bung reducers and rear sensor harness extension (also sold separately)
- Ideal for Touring models and others using a performance exhaust that has bung location near the exhaust port
- Also used for earlier exhausts with 18mm bungs on later model bikes



Application	Description	WPS #
Custom/Aftermarket Exhausts	18mm to 12mm Bung Reducers (PR)	<b>820-0066</b>
Fits '10-16 Touring Models	Rear O2 Sensor Harness Extension	<b>820-0065</b>
	Harness Extension/Reducer Kit	<b>820-0067</b>

## EXHAUST TORQUE VALVE

- Stainless steel
- Sold as each

Application	WPS#
'84-17 Evos, Twin Cams and '86-Up Sportsters	<b>820-2657</b>



## EXHAUST SPIGOT

- Replacement exhaust spigot has been designed and machined from 6061-T6 aluminum extruded tubing
- This spigot allows you to rebuild the exhaust attachment point on you classic Panhead engine



Application	WPS#
Panhead '48-65	<b>191-27789</b>



**O<sup>2</sup> SENSOR PLUG**

Description	WPS#
O2 Sensor Plug 18mm x 1.5	<b>27-5728</b>



**EXHAUST PIPE GASKETS**

- Great use when changing mufflers or to seal up leaky connections
- Knit wire style gaskets for both the headpipe to cylinder and also crossover connectors
- Fits most popular applications

Description	Application	WPS#
A Tapered graphite exhaust port gasket	'84-17 Evos, Twin Cams; '86-Up XL	<b>820-0080</b>
B Exhaust port gasket	'84-17 Evos, Twin Cams; '86-Up XL	<b>820-0081</b>
C Interconnect exhaust gasket	'04-13 XL	<b>820-0100</b>
D Interconnect exhaust gasket	'03-09 Dyna, FXST, FLST	<b>820-0101</b>
E Crossover exhaust gasket	'91-98 Dyna	<b>820-0102</b>
F Crossover exhaust gasket	'82-03 XL & FXR	<b>820-0103</b>
G Muffler Exhaust gasket	'85-94 FLT	<b>820-0104</b>



**EXHAUST CLAMPS**

- Clamp sizes to fit almost all applications
- Sturdy for years of use
- Chrome finish

Description	Application	WPS#
Chromed Super Exhaust Clamps	'57-85 Sportster (48mm dia)	<b>820-0120</b>
A Chromed Super Exhaust Clamps	'48-65 Panhead (54mm dia)	<b>820-0121</b>
B Chromed Heavy Duty Exhaust End Clamps	Universal 1.5"	<b>820-0131</b>
C Chromed Heavy Duty Exhaust End Clamps	Universal 1.625"	<b>820-0132</b>
D Chromed Heavy Duty Exhaust End Clamps	Universal 1.75"	<b>820-0133</b>
E Chromed Heavy Duty Exhaust End Clamps	Universal 1.875"	<b>820-0134</b>
Chromed Heavy Duty Exhaust End Clamps	Universal 2"	<b>820-0135</b>
F Chromed Heavy Duty Exhaust End Clamps	Universal 2.125"	<b>820-0136</b>
Chromed Heavy Duty Exhaust End Clamps	Universal 2.5"	<b>820-0137</b>

WINDSHIELDS / FAIRINGS  
AUDIO / COMMUNICATION  
SEATS / LUGGAGE  
BARS / MIRRORS / CONTROLS  
**EXHAUST**  
AIR / FUEL SYSTEMS  
ENGINE  
TRANSMISSION / DRIVELINE  
GASKETS / SEALS  
ELECTRICAL  
LIGHTING  
CABLES  
BRAKES  
OIL FILTERS  
SUSPENSION  
BODY  
WHEELS  
TIRES / TIRE ACC.  
BIKE ACC.  
VICTORY / INDIAN  
COVERS / LOCKS / TIEDOWNS  
CHEMICALS  
TOOLS  
HELMETS  
HELMET ACC.  
EYEWEAR  
APPAREL / RIDER ACC.  
PROMOTIONAL  
REFERENCE  
INDEX



## EXHAUST WRAP KIT

An all in one kit for wrapping one set of motorcycle pipes. Kit includes two rolls of 2"x15ft wrap, one can of silicone coating and stainless steel locking ties.



Description	WPS#
Motorcycle Exhaust Wrap Kit, Black Wrap/Black Coating	790-01000
Motorcycle Exhaust Wrap Kit, Tan Wrap/ Coating	790-01001
Motorcycle Exhaust Wrap Kit, Tan Wrap/White Coating	790-01002

## EXHAUST WRAP & TIE KITS

Convenient pack with one roll of 2"x25ft wrap and stainless steel locking ties.

Description	WPS#
Wrap and Ties Kit, Black	790-01010
Wrap and Ties Kit, Tan	790-01011
Wrap and Ties Kit, Titanium	790-01012
Wrap and Ties Kit, Black Titanium	790-01013



## INDIVIDUAL EXHAUST WRAP ROLLS

- Decreases exhaust density & increases exhaust flow
- Improves horsepower
- sewn in guide lines for proper overlap
- Tan & black wraps withstand 1200 F direct heat, titanium withstands 1800 F direct heat
- Titanium wrap requires no coating or pre-wetting

Description	WPS#
Black Wrap 2"x50'	790-01030
Tan Wrap 2"x50'	790-01031
Titanium Wrap 2"x50'	790-01032
Black Titanium Wrap 2"x50'	790-01041
Black Wrap 2"x15'	790-01033
Tan Wrap 2"x15'	790-01034
Titanium Wrap 2"x15'	790-01035
Black Titanium Wrap 2"x15'	790-01040





**GEN III ONYX HEATSHIELDS**

DEI has expanded its award winning Flexible Heat Shields to include additional sizes and premium finishes. Each shield uses our reliable stainless standoff bracket and includes mounting hardware for easy installation.



A



B



C



D



E



F

	Description	WPS#
A	Onyx Universal Heatshield Black/Black 3.5"x6.5"	790-01201
B	Onyx Universal Heatshield Black/Black 4"x8"	790-01202
C	Onyx Universal Heatshield Brushed/Black 3.5"x6.5"	790-01203
D	Onyx Universal Heatshield Brushed/Black 4"x8"	790-01205
E	Onyx Universal Heatshield Brushed/Titanium 3.5"x6.5"	790-01204
F	Onyx Universal Heatshield Brushed/Titanium 4"x8"	790-01206



**TITANIUM EXHAUST SLEEVE**

Forget the hassle of wrapping your pipes, simply slip the sleeve over and secure it with ties...done! Same heat protection and great looks of wrapped pipes without the time consuming work trying to get the overlaps straight. Sleeves come in 5 foot lengths and fit 1-3/4"-2" pipe diameters.



Description	WPS#
Titanium Exhaust Sleeve	790-01050

- WINDSHIELDS / FAIRINGS
- AUDIO / COMMUNICATION
- SEATS / LUGGAGE
- BAR / MIRRORS / CONTROLS
- EXHAUST**
- AIR / FUEL SYSTEMS
- ENGINE
- TRANSMISSION / DRIVELINE
- GASKETS / SEALS
- ELECTRICAL
- LIGHTING
- CABLES
- BRAKES
- OIL FILTERS
- SUSPENSION
- BODY
- WHEELS
- TIRES / TIRE ACC.
- BIKE ACC.
- VICTORY / INDIAN
- COVERS / LOCKS / TIEDOWNS
- CHEMICALS
- TOOLS
- HELMETS
- HELMET ACC.
- EYEWEAR
- APPAREL / RIDER ACC.
- PROMOTIONAL
- REFERENCE
- INDEX

- WINDSHIELDS / FAIRINGS
- AUDIO / COMMUNICATION
- SEATS / LUGGAGE
- BAR / MIRRORS / CONTROLS
- EXHAUST**
- AIR / FUEL SYSTEMS
- ENGINE
- TRANSMISSION / DRIVELINE
- GASKETS / SEALS
- ELECTRICAL
- LIGHTING
- CABLES
- BRAKES
- OIL FILTERS
- SUSPENSION
- BODY
- WHEELS
- TIRES / TIRE ACC.
- BIKE ACC.
- VICTORY / INDIAN
- COVERS / LOCKS / TIEDOWNS
- CHEMICALS
- TOOLS
- HELMETS
- HELMET ACC.
- EYEWEAR
- APPAREL / RIDER ACC.
- PROMOTIONAL
- REFERENCE
- INDEX



## ONYX UNIVERSAL HEAT SHIELD

- Aluminum Impregnated fabric outside layer, high temperature resistant fabric (89% silica) inside layer capable of withstanding extreme exhaust heat – up to 1350°F
- Flexible material for easy fit on many pipe diameters
- Stainless steel hardware



Description	WPS#
Onyx Universal Heatshield Black 4"x8"	790-01200

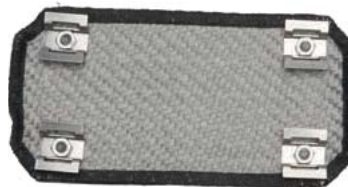

## EXO EXHAUST WRAP

- The EXO Series™ exhaust wrap is a dual-layer design, using a combination of hi-temp fiberglass, covered with a 304 grade stainless steel exoskeleton. The stainless steel exoskeleton hooks together when overlapped, saving time and making installation much easier.
- Each kit includes a 1.5"x 20' roll of wrap, stainless steel locking ties, and installation tool.

Description	WPS#
Exo Wrap Tan	790-01036
Exo Wrap Black	790-01037



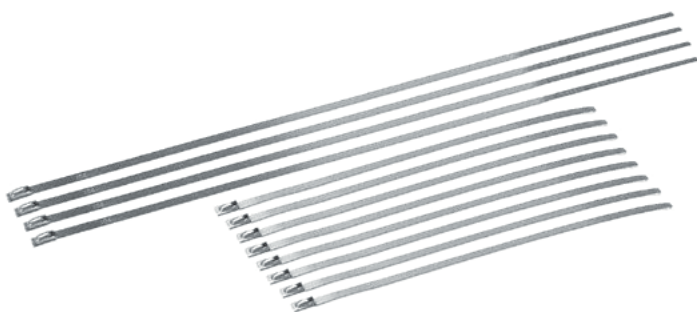

## LOCKING TIES

- Self locking design
- Constructed from high grade 304 stainless steel
- Capable of withstanding in excess of 2500 F
- 100lb tensile strength

Description	WPS#
Stainless Steel Locking Ties 8" (8 pack)	<b>790-01100</b>
Stainless Steel Locking Ties 14" (4 pack)	<b>790-01101</b>
Stainless Steel Locking Ties 20" (10 pack)	<b>790-01102</b>



## HT SILICONE COATING

Recommended for use with DEI non-Titanium exhaust wraps. HT silicone coating penetrates, seals and protects as well as helping to extend the lifespan of exhaust wrap.

- Protects from abrasions, hot oil spills & road grime
- Heat protection up to 1500 F
- For use on engine blocks, pipes, manifolds and more
- 12 oz. can (6 cans in a case)

Description	WPS#
HT Silicone Assortment Case (2 of each color)	<b>790-01150</b>
HT Silicone Coating, Black	<b>790-01151</b>
HT Silicone Coating, Aluminum	<b>790-01152</b>
HT Silicone Coating, White	<b>790-01153</b>



## LOCKING TIE TOOL

The DEI Locking Tie Tool will fit on the end of any standard 1/4" drive extension so working in tight spaces where your hands don't fit is no problem. The tool works with all the popular styles of stainless ties up to 1/2" wide. Simply engage the tie, and twist. This gets the tie nice and secure, without any hassle.

Description	WPS#
Locking Tie Tool	<b>790-01105</b>



- WINDSHIELDS / FAIRINGS
- AUDIO / COMMUNICATION
- SEATS / LUGGAGE
- BARS / MIRRORS / CONTROLS
- EXHAUST**
- AIR / FUEL SYSTEMS
- ENGINE
- TRANSMISSION / DRIVELINE
- GASKETS / SEALS
- ELECTRICAL
- LIGHTING
- CABLES
- BRAKES
- OIL FILTERS
- SUSPENSION
- BODY
- WHEELS
- TIRES / TIRE ACC.
- BIKE ACC.
- VICTORY / INDIAN
- COVERS / LOCKS / TIEDOWNS
- CHEMICALS
- TOOLS
- HELMETS
- HELMET ACC.
- EYEWEAR
- APPAREL / RIDER ACC.
- PROMOTIONAL
- REFERENCE
- INDEX



## SILENCER PACKING

### MUFFLER AND SPARK ARRESTOR REPACK KIT

- More top quality material at nearly half the cost of other kits
- Repack kits attractively packaged
- For use in all repackable silencers 2 & 4 cycle motorcycle, ATVs and watercraft



WPS#  
05-0001



### PRO-PAK SILENCER REPACK KIT

- Dual density repack material
- Reduced noise levels
- Lasts longer than ordinary packing
- Allows your engine to operate at peak performance longer



WPS#  
05-0002

### EXHAUST SCREEN

Stainless steel exhaust screen is used to enclose muffler packing to prevent the packing from blowing out and provides more uniform exhaust flow. .011 diameter stainless steel strands are interlaced together to form a two layer sheet that is crimped on two sides for easy insertion of muffler packing material. Sheets are cut to 12" x 18" to fit most mufflers/ silencers



WPS#  
78-7217



### HEAVY DUTY MUFFLER PACKING KIT

- 11" x 16" x 1"
- Extreme heat capability
- High Density fiberglass



WPS#  
78-7218

### CERAMIC PIPE WRAP

- Holds heat in pipe for consistent horsepower
- Prevents burned hands



Size	Tan	Black
<b>1" WIDE</b>		
25' Roll	<b>78-7201</b>	<b>78-7202</b>
50' Roll	<b>78-7220</b>	<b>78-7226</b>
<b>2" WIDE</b>		
25' Roll	<b>78-7223</b>	<b>78-7229</b>
50' Roll	<b>78-7225</b>	<b>78-7227</b>

### ALUMINIZED HEAT BARRIER

- Foil coated ceramic cloth
- Attaches easily with most adhesives
- Protects large areas from heat, such as hoods, side panels or electrical components

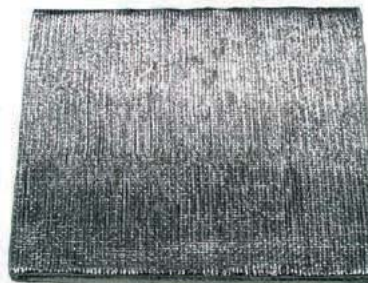

Wide	Long	Thickness	Backing	WPS#
2"	36"	.032	Adhesive	<b>78-7224</b>
2"	15'	.032	Adhesive	<b>78-7200</b>
12"	40"	.063"	Adhesive	<b>78-7221</b>
12"	40"	.063"	No Adhesive	<b>78-7222</b>
18"	18"	.032"	Adhesive	<b>78-7228</b>





## CUSTOM AIR CLEANER ASSEMBLIES

- High flow performance air cleaners designed to match our popular HardDrive wheel designs
- Machined from billet aluminum with breather system integrated into the backing plate
- Due to the increased airflow we highly recommend rejetting your carb or adding a fuel tuner
- **Not legal for use on pollution controlled vehicles-check your local laws before installation**



A



B



C



D



E



F

Application/Year	Style	Finish	WPS#
A Big Twins '91-17 (except TBW and Magneti Marelli EFI)	Luck	Black	<b>820-4300</b>
	Luck	Chrome	<b>820-4302</b>
	Flow	Black	<b>820-4304</b>
	Flow	Chrome	<b>820-4306</b>
	Revolver	Black	<b>820-4308</b>
	Revolver	Chrome	<b>820-4310</b>
Touring Models '08-16, Softails and FXDLS '16-17 with TBW	Luck	Black	<b>820-4301</b>
	Luck	Chrome	<b>820-4303</b>
	Flow	Black	<b>820-4305</b>
	Flow	Chrome	<b>820-4307</b>
	Revolver	Black	<b>820-4309</b>
	Revolver	Chrome	<b>820-4311</b>

- WINDSHIELDS / FAIRINGS
- AUDIO / COMMUNICATION
- SEATS / LUGGAGE
- BAR / MIRRORS / CONTROLS
- EXHAUST
- AIR / FUEL SYSTEMS**
- ENGINE
- TRANSMISSION / DRIVELINE
- GASKETS / SEALS
- ELECTRICAL
- LIGHTING
- CABLES
- BRAKES
- OIL FILTERS
- SUSPENSION
- BODY
- WHEELS
- TIRES / TIRE ACC.
- BIKE ACC.
- VICTORY / INDIAN
- COVERS / LOCKS / TIEDOWNS
- CHEMICALS
- TOOLS
- HELMETS
- HELMET ACC.
- EYEWEAR
- APPAREL / RIDER ACC.
- PROMOTIONAL
- REFERENCE
- INDEX



# BILLET AIR CLEANERS



- Billet aluminum air cleaners, crafted from 6061-T6 Billet aluminum
- Available in our hard Black anodized contrast cut or show Chrome finish
- Unique 3D relief design like nothing else available
- Maximizes air flow to the intake
- Great addition to performance exhaust
- **Not legal for use in California on pollution controlled vehicles - Check local laws before installing**



Application	Description	Chrome	Black
A Twin Cam Models (except '08-16 Touring and '16-17 Softails and FXDLS) Touring Models '08-16 and '16-17 Softails and FXDLS	Ace's Wild	<b>810-0016</b>	<b>810-0017</b>
	Ace's Wild	<b>810-0003</b>	<b>810-0004</b>
B Twin Cam Models (except '08-16 Touring and '16-17 Softails and FXDLS) Touring Models '08-16 and '16-17 Softails and FXDLS	Bad Axe	<b>810-0025</b>	<b>810-0024</b>
	Bad Axe	<b>810-0013</b>	<b>810-0012</b>
C Twin Cam Models (except '08-16 Touring and '16-17 Softails and FXDLS) Touring Models '08-16 and '16-17 Softails and FXDLS	Dark Side	<b>810-0014</b>	<b>810-0015</b>
	Dark Side	<b>810-0001</b>	<b>810-0002</b>



- WINDSHIELDS / FAIRINGS
- AUDIO / COMMUNICATION
- SEATS / LUGGAGE
- BAR / MIRRORS / CONTROLS
- EXHAUST
- AIR / FUEL SYSTEMS**
- ENGINE
- TRANSMISSION / DRIVELINE
- GASKETS / SEALS
- ELECTRICAL
- LIGHTING
- CABLES
- BRAKES
- OIL FILTERS
- SUSPENSION
- BODY
- WHEELS
- TIRES / TIRE ACC.
- BIKE ACC.
- VICTORY / INDIAN
- COVERS / LOCKS / TIEDOWNS
- CHEMICALS
- TOOLS
- HELMETS
- HELMET ACC.
- EYEWEAR
- APPAREL / RIDER ACC.
- PROMOTIONAL
- REFERENCE
- INDEX

# STAINLESS STEEL INTAKE



R O C K



- Brushed stainless forward facing intake
- Fits 08-Up throttle by wire models
- Includes UNI-Filter air cleaner element
- Made in the USA



Application	Year	Description	Finish	WPS #
FLH/FLT	'08-16	Forward Facing Intake	Brushed Stainless Steel	<b>825-01100</b>
		Optional K&N Filter (sold separately)	Chrome End Cap	<b>62-9480</b>

- WINDSHIELDS / FAIRINGS
- AUDIO / COMMUNICATION
- SEATS / LUGGAGE
- BARS / MIRRORS / CONTROLS
- EXHAUST
- AIR / FUEL SYSTEMS**
- ENGINE
- TRANSMISSION / DRIVELINE
- GASKETS / SEALS
- ELECTRICAL
- LIGHTING
- CABLES
- BRAKES
- OIL FILTERS
- SUSPENSION
- BODY
- WHEELS
- TIRES / TIRE ACC.
- BIKE ACC.
- VICTORY / INDIAN
- COVERS / LOCKS / TIEDOWNS
- CHEMICALS
- TOOLS
- HELMETS
- HELMET ACC.
- EYEWEAR
- APPAREL / RIDER ACC.
- PROMOTIONAL
- REFERENCE
- INDEX



## VORTEX AIR CLEANER

- Raw performance “racing” air cleaner, classic round design, simplicity at its best, basic and brutal
- Customizable to your taste, chrome it, polish it, powder coat it or engrave it, the possibilities are endless!
- Central porthole in thermoformed Lexan, “venturi” for a better flow intake and also to watch your accelerator pump from time to time
- Manufactured in die cast aluminum then CNC machined
- Stainless Steel back plate with hardware included
- **Not legal for use in California and on pollution controlled vehicles, check local laws before installation**



**K&N filter and breather not included, please order separately**



Application	Description	WPS#
Fits '86-17 Big Twins (except TBW) and XL Models	Vortex Air Cleaner Raw	<b>866-05700</b>
	Vortex Air Cleaner Black Cut	<b>866-05701</b>
	K&N Filter Element	<b>750100</b>



## BOSSLEY AIR CLEANER

- 4” High performance air cleaner, with black aluminum backing plate
- Available with black fins or polished fins, cover can be mounted horizontally or vertically
- K&N air filter included
- Breather and support brackets sold separately
- **Not legal in California on pollution controlled vehicles, check local laws before installation**



A

B

Application	Description	WPS#
A Sportster and Big Twins (except TBW)	Black Fins	<b>750-01400</b>
B	Polished Fins	<b>750-01401</b>

# CAST AIR CLEANERS



Add classic vintage style to your motorcycle with these TC Bros. Choppers air cleaners in raw cast, black or polished finish. The covers are beautifully hand cast from 356-T6 aluminum right here in the USA. A washable cotton gauze filter element provides high performance air flow to your V-Twin. Kits attach easily using the American made, CNC machined, powder coated steel mounting bracket. These ultra-compact kits are designed to fit all Harley Davidson® Big Twin and Sportster models using factory CV Carburetors or factory electronic fuel injection (EFI) units. They will not fit '95-01 HD Big Twin models equipped with Magneti Marelli fuel injection units using dual bore throttle bodies. If installing on models using a CV carburetor, it is highly recommended to use in conjunction with a support bracket for longevity. Support bracket is not required on EFI models. Note: EVO Big Twins and '91-up Sportsters also require crankcase breathers.

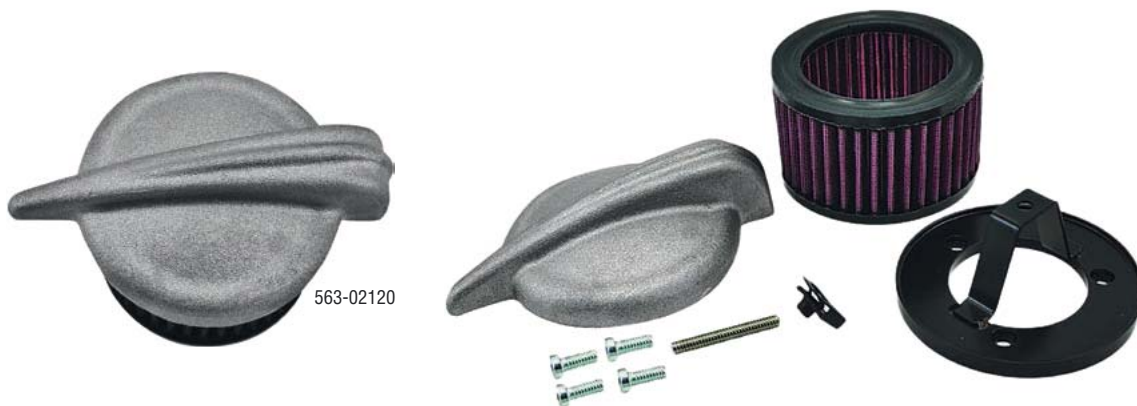

563-02120



563-02120



563-02121



563-02126



563-02127



563-02128



563-02135



563-02133

Not legal for use in California on pollution controlled vehicles-  
check local laws before installation

Description	Raw	Black	Polished
Streamliner Air Cleaner CV & EFI (not for TBW)	563-02120	563-02121	
Streamliner Air Cleaner S&S	563-02123	563-02124	
Finned Air Cleaner CV & EFI (not for TBW)	563-02126	563-02127	563-02128
Finned Air Cleaner S&S	563-02129	563-02130	563-02131
Ripple Air Cleaner CV & EFI (not for TBW)	563-02132	563-02133	563-02134
Ripple Air Cleaner S&S	563-02135	563-02136	563-02137
Repl. High Performance Filter	563-02111		

- WINDSHIELDS / FAIRINGS
- AUDIO / COMMUNICATION
- SEATS / LUGGAGE
- BARS / MIRRORS / CONTROLS
- EXHAUST
- AIR / FUEL SYSTEMS**
- ENGINE
- TRANSMISSION / DRIVELINE
- GASKETS / SEALS
- ELECTRICAL
- LIGHTING
- CABLES
- BRAKES
- OIL FILTERS
- SUSPENSION
- BODY
- WHEELS
- TIRES / TIRE ACC.
- BIKE ACC.
- VICTORY / INDIAN
- COVERS / LOCKS / TIEDOWNS
- CHEMICALS
- TOOLS
- HELMETS
- HELMET ACC.
- EYEWEAR
- APPAREL / RIDER ACC.
- PROMOTIONAL
- REFERENCE
- INDEX

WINDSHIELDS / FAIRINGS  
 AUDIO / COMMUNICATION  
 SEATS / LUGGAGE  
 BARS / MIRRORS / CONTROLS  
 EXHAUST  
**AIR / FUEL SYSTEMS**  
 ENGINE  
 TRANSMISSION / DRIVELINE  
 GASKETS / SEALS  
 ELECTRICAL  
 LIGHTING  
 CABLES  
 BRAKES  
 OIL FILTERS  
 SUSPENSION  
 BODY  
 WHEELS  
 TIRES / TIRE ACC.  
 BIKE ACC.  
 VICTORY / INDIAN  
 COVERS / LOCKS / TIEDOWNS  
 CHEMICALS  
 TOOLS  
 HELMETS  
 HELMET ACC.  
 EYEWEAR  
 APPAREL / RIDER ACC.  
 PROMOTIONAL  
 REFERENCE  
 INDEX



## LOUVERED AIR CLEANERS

- CNC machined, powder coated steel mounting bracket
- Made in the USA 
- Included mounting hardware fits into recessed holes to provide proper sealing surface for included filter element
- Kit includes both a hotrod inspired Tri-Bar wing bolt or standard round head screw hardware
- Ultra-compact
- Designed to fit all Harley Davidson® Big Twin and Sportster models using factory CV Carburetors or factory electronic fuel injection (EFI) units
- A version for S&S® Super E or Super G series carburetors is also available
- Does not fit '95-01 HD Big Twin models equipped with Magneti Marelli fuel injection.
- If installing on models using a CV carburetor, it is highly recommended to use in conjunction with a support bracket for longevity. Support bracket is not required on EFI models. Breathers where applicable sold separately.
- **Not legal for sale in California on pollution controlled vehicles-check local laws before installation**



Description	WPS#
Chrome Louvered Air Cleaner CV & EFI (not for TBW)	563-02100
Chrome Louvered Air Cleaner S&S	563-02101
Repl. High Performance Filter	563-02111



## TEARDROP AIR CLEANERS

- Made from chrome-plated cast aluminum
- Measures 8"-wide x 4½"-tall x 2"-thick
- They fit S&S carbs and most HD induction systems since 1936
- A mini air filter is included as well as any required fittings and hardware
- **Not legal for use in California on pollution controlled vehicles-check local laws before installation**



Description	Application	WPS #
Ribbed Air Cleaner Assemblies	S&S E and G Carbs	830-3402
	CV, Delphi EFI	830-3403

## LINKERT STYLE CARB COVERS

- Perfect reproductions of the late 1930's Linkert carb covers used on Knuckleheads and Flatheads
- They've been redesigned to bolt right onto the immensely popular late model S&S E and G model carburetors
- The backing plate bolts to the rear head for support with the supplied special hardware and spacers
- The '92-Up version uses existing breather hoses and fittings
- **Not legal for use in California on pollution controlled vehicles-check local laws before installation**



Description	Application	WPS #
Linkert Style Carb Cover for S&S E & G	'84-91 no breather	830-3400
	'92-Up	830-3401





### RAM-AIR AIR CLEANERS

- Custom tilt forward air cleaners in chrome or black finish
- Kits include high flow air filter, 90 degree manifold and CNC billet housing
- Air cleaner diameter 4 1/2", length 10" (chopped), 12" (cone)
- Fits Sportster and Big Twin models with applicable breather/bracket (sold separately) [see page 0000](#)
- **Not legal for use in California on pollution controlled vehicles, check local laws before installation**

Description	WPS#
Chrome Coned Ram Air Filter	820-50518
A Black Coned Ram Air Filter	820-50519
B Chr Chopped Ram Air Filter	820-50520
Black Chopped Ram Air Filter	820-50521
Replacement Filter	820-5022

### CORIOLIS HIGH PERFORMANCE AIR CLEANER



- 90 degree manifold for a custom look
- Chrome and Black housing available
- Fits Sportsters and Big Twins with applicable breather bracket (sold separately) [see page](#)

Description	WPS#
High performance air filter Chrome	820-50534
High performance air filter Black	820-50535
Rep. element	820-50536

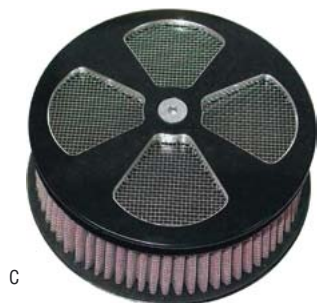
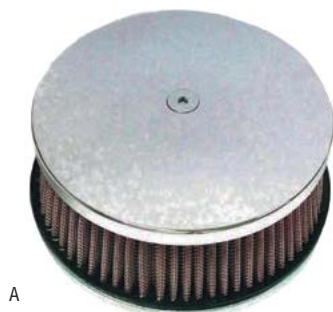

### CUSTOM ROUND AIR CLEANERS

- 5 7/8" diameter custom high performance air cleaners
- Available in chrome or black with machined accents
- Kits include backplate, hi-flow air filter element, mesh filter cover and billet end cover
- Model specific air cleaner support bracket and breather kit sold separately [see page 0000](#)
- **Not legal for use in California on pollution controlled vehicles, check local laws before installation**

Description	WPS#
A Chrome HP Classic Smooth	820-50501
Black HP Classic Smooth	820-50502
Chrome HP 5-Spoke	820-50503
B Black HP 5-Spoke	820-50504
Chrome HP 4-Spoke	820-50505
C Black HP 4-Spoke	820-50506
Chrome HP Notch	820-50507
D Black HP Notch	820-50508

- WINDSHIELDS / FAIRINGS
- AUDIO / COMMUNICATION
- SEATS / LUGGAGE
- BAR / MIRRORS / CONTROLS
- EXHAUST
- AIR / FUEL SYSTEMS**
- ENGINE
- TRANSMISSION / DRIVELINE
- GASKETS / SEALS
- ELECTRICAL
- LIGHTING
- CABLES
- BRAKES
- OIL FILTERS
- SUSPENSION
- BODY
- WHEELS
- TIRES / TIRE ACC.
- BIKE ACC.
- VICTORY / INDIAN
- COVERS / LOCKS / TIEDOWNS
- CHEMICALS
- TOOLS
- HELMETS
- HELMET ACC.
- EYEWEAR
- APPAREL / RIDER ACC.
- PROMOTIONAL
- REFERENCE
- INDEX



## RETRO AIR CLEANERS

- Reproductions of classic air cleaner designs
- Available to fit era correct and modern carbs on some applications
- Replacement filter elements available
- Use of carb support bracket recommended
- **Not legal for use in California on pollution controlled vehicles, check local laws before installation**



Description	Application	WPS#
A Round Air Cleaner	Bendix, Tillotson and Keihin (not CV) Carbs	<b>820-51500</b>
B Drilled Round Air Cleaner		<b>820-51501</b>
C Round Mesh Air Cleaner		<b>820-51503</b>
	Keihin CV Carbs	<b>820-51504</b>
	S&S Carbs	<b>820-51505</b>
REPLACEMENT FILTER ELEMENTS		
Repl. Filter Round Air Cleaner		<b>820-51502</b>
Repl. Filter Mesh Air Cleaner		<b>820-51506</b>



## MINI ED AIR CLEANER

The "Mini Ed" air cleaner measures only 5.5" x 4" x 2 5/8" and has a vintage hot rod look in natural tumbled cast aluminum. If your tired of the typical round filters, tear drops or deflectors then this is perfect for you. Made in USA by Old-Sif cycle and includes a K&N high flow filter element made in the USA.



Application	Finish	WPS#
S&S Super E and G	Polished	<b>880-2120</b>
	Tumbled	<b>880-2121</b>
CV Carbs, '01-07 EFI (support bracket required)	Polished	<b>880-2122</b>
	Tumbled	<b>880-2123</b>







## AIR CLEANER COVERS



- These performance air cleaner covers are a no nonsense, bad ass upgrade for your bike. Machined from 6061 T6 aircraft grade billet aluminum, natural machined finish with carbon fiber inlay.
- Have a round 5.5" diameter air cleaner and want to upgrade the look of your bike? Simply replace your existing air cleaner cover. It's the easiest custom design upgrade you can do.
- \*Fits most 5.5" diameter, center bolt mount air cleaners

Application	Description	Black	Natural
Fits Most 5.5" Air Cleaners	F1 Cover	A <b>826-01000</b>	B <b>826-01002</b>
	Defender Cover	C <b>826-01004</b>	D <b>826-01003</b>

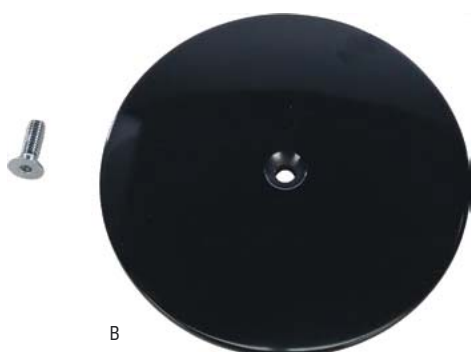

## AIR CLEANER COVERS



Pro One billet air cleaner covers are CNC machined from solid billet aluminum, carefully polished, then show-chrome plated or black anodized to perfection! Hardware included. Evo version diameter is 6.280", Twin Cam version diameter is 5.485".

Application	Description	Chrome	Black
Fit '84-99 Evos	Smooth	A <b>812-02050</b>	B <b>812-02051</b>
Fit '99-15 Twin Cams		C <b>812-02070</b>	D <b>812-02071</b>



## CHOKE KNOB COVERS

Pro One patented choke knob covers fit just about any motorcycle with a choke knob. Popular on Harley Davidsons and metric cruisers with choke knobs. Show-Chrome plated. Easy to install. U.S. Patents #5,836,214 & 418,390

Application	Description	Chrome	Black
Universal	Smooth	<b>812-02040</b>	<b>812-02041</b>
	Milled	<b>812-02042</b>	<b>812-02043</b>

- WINDSHIELDS / FAIRINGS
- AUDIO / COMMUNICATION
- SEATS / LUGGAGE
- BAR / MIRRORS / CONTROLS
- EXHAUST
- AIR / FUEL SYSTEMS**
- ENGINE
- TRANSMISSION / DRIVELINE
- GASKETS / SEALS
- ELECTRICAL
- LIGHTING
- CABLES
- BRAKES
- OIL FILTERS
- SUSPENSION
- BODY
- WHEELS
- TIRES / TIRE ACC.
- BIKE ACC.
- VICTORY / INDIAN
- COVERS / LOCKS / TIEDOWNS
- CHEMICALS
- TOOLS
- HELMETS
- HELMET ACC.
- EYEWEAR
- APPAREL / RIDER ACC.
- PROMOTIONAL
- REFERENCE
- INDEX



# AIR CLEANER BRACKETS

Use these brackets and breather kits when installing an aftermarket aircleaner. If a custom breather system is used, some support brackets are available without the breather system. Spacer 820-50525 can be used in conjunction with breather/bracket kit 820-50512 to mount aftermarket aircleaners with a CV/Delphi EFI bolt pattern to TBW models. **Not legal for use in California on pollution controlled vehicles, check local laws before installation.**

Description	Application	WPS#
A Bracket/Breather Kit Complete	FLH, FLT '08-16	<b>820-50512</b>
B TBW to CV Bolt Pattern Adapter Spacer	FLH, FLT '08-16	<b>820-50525</b>
Bracket/Breather Kit Complete	'93-99 Big Twins	<b>820-50509</b>
Bracket with Bolts and Breather Tube Chrome	'93-Up Big Twins	<b>820-50511</b>
C Bracket with Bolts and Breather Tube Black	'93-Up Big Twins	<b>820-50531</b>
Bracket/Breather Kit Complete	'91-06 XL Models	<b>820-50530</b>
D Bracket/Breather Kit Complete	'07-Up XL Models	<b>820-50529</b>
E Carb Support Bracket Only	'90-Up Big Twins (except TBW/'16-UP)	<b>820-50510</b>
F Carb Support Bracket Only	'07-Up XL Models	<b>820-50517</b>
G Carb Support Bracket Only	'88-06 XL Models	<b>820-50515</b>
H Breather Kit Only	'91-07 XL Models	<b>820-50516</b>
I Breather Kit with Braided Hose	'93-17 Big Twins	<b>820-50543</b>
J Twin Cam Breather Bolts (pr)	'93-16 Custom Applications	<b>820-50544</b>
K Evo Breather Bolts (pr)		<b>820-50513</b>
L Evo Breather Bolts w/Fittings (pr)		<b>820-50514</b>
M Breather Fitting Kit	'91-07 XL Models	<b>820-50547</b>
	'93-17 Big Twins	<b>820-50545</b>

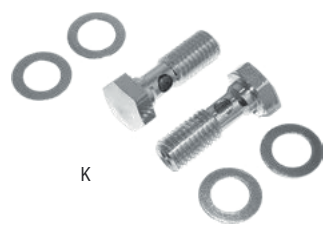
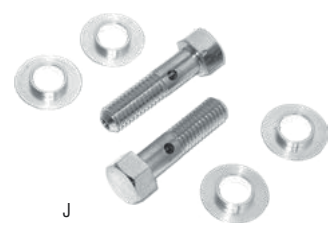
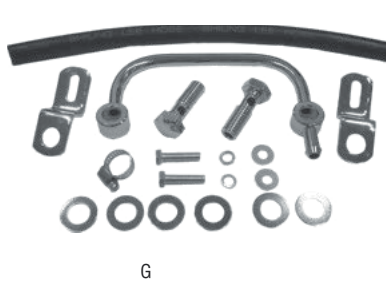
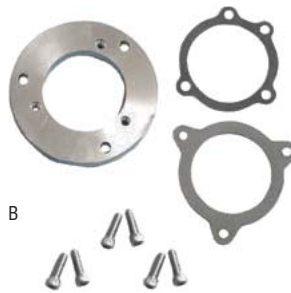

WINDSHIELDS / FAIRINGS  
AUDIO / COMMUNICATION  
SEATS / LUGGAGE  
BARS / MIRRORS / CONTROLS  
EXHAUST  
AIR / FUEL SYSTEMS  
ENGINE  
TRANSMISSION / DRIVELINE  
GASKETS / SEALS  
ELECTRICAL  
LIGHTING  
CABLES  
BRAKES  
OIL FILTERS  
SUSPENSION  
BODY  
WHEELS  
TIRES / TIRE ACC.  
BIKE ACC.  
VICTORY / INDIAN  
COVERS / LOCKS / TIEDOWNS  
CHEMICALS  
TOOLS  
HELMETS  
HELMET ACC.  
EYEWEAR  
APPAREL / RIDER ACC.  
PROMOTIONAL  
REFERENCE  
INDEX



**DUAL BREATHER KIT**



Dual canister breather kit for custom air cleaner applications.

Description	Application	WPS#
Dual Breather Kit	Custom Applications	820-50546



**AIR CLEANER ADAPTER**

- Allows installation of aftermarket CV style air cleaner assemblies on S&S carb & EFI throttle bodies
- Kit includes A/C support bracket, CNC billet adaptor with breather, gaskets & mounting hardware
- Available in black or chrome finish

Application	Chrome	Black
S&S Carb to CV Aircleaner	820-50527	820-50528



**ADJUSTABLE CARB SUPPORT BRACKETS**



Description	Application	WPS#
A Hanging Type Carb Bracket	Pan, Shovel and Ironhead w/S&S E or B	750-02070
B Adjustable Carb Bracket	Pan, Shovel w/S&S E or B	750-02071
C	Evolution w/S&S Carb	750-02072

- Stainless steel with a tumbled finish
- Adjustable for stock length or taller cylinders
- A must have when using velocity stacks or other air cleaners with no backing plate



A



B



C

- WINDSHIELDS / FAIRINGS
- AUDIO / COMMUNICATION
- SEATS / LUGGAGE
- BAR / MIRRORS / CONTROLS
- EXHAUST
- AIR / FUEL SYSTEMS**
- ENGINE
- TRANSMISSION / DRIVELINE
- GASKETS / SEALS
- ELECTRICAL
- LIGHTING
- CABLES
- BRAKES
- OIL FILTERS
- SUSPENSION
- BODY
- WHEELS
- TIRES / TIRE ACC.
- BIKE ACC.
- VICTORY / INDIAN
- COVERS / LOCKS / TIEDOWNS
- CHEMICALS
- TOOLS
- HELMETS
- HELMET ACC.
- EYEWEAR
- APPAREL / RIDER ACC.
- PROMOTIONAL
- REFERENCE
- INDEX

- WINDSHIELDS / FAIRINGS
- AUDIO / COMMUNICATION
- SEATS / LUGGAGE
- BAR / MIRRORS / CONTROLS
- EXHAUST
- AIR / FUEL SYSTEMS
- ENGINE
- TRANSMISSION / DRIVELINE
- GASKETS / SEALS
- ELECTRICAL
- LIGHTING
- CABLES
- BRAKES
- OIL FILTERS
- SUSPENSION
- BODY
- WHEELS
- TIRES / TIRE ACC.
- BIKE ACC.
- VICTORY / INDIAN
- COVERS / LOCKS / TIEDOWNS
- CHEMICALS
- TOOLS
- HELMETS
- HELMET ACC.
- EYEWEAR
- APPAREL / RIDER ACC.
- PROMOTIONAL
- REFERENCE
- INDEX



## SPORTSTER AIR CLEANER ACCESSORIES

- TC Bros. have come up with a super clean solution for crank case breathers on your Harley. No more messing with hoses and bulky filters. These bolts are CNC machined from 6061 aluminum and have internal foam filter elements to keep your motor clean!
- The bracket is used when installing aftermarket air filters to your 91-03 Harley Sportster with stock CV type carb. Gasket included.



A



B

	Description	WPS#
A	Air Cleaner/Carb Support Bracket for 91-03 Sportster	563-01550
B	Breather Bolts For 91-UP Sportster & EVO Big Twin	563-01551



## POWER X INTAKE

X-FORCE AIR FILTER SYSTEM

AIR IS POWER, and Boyesen has channeled that power like never before. With its revolutionary design and ease of installation, adding more power and greater acceleration is now within your reach. Available for all Harley Davidson (FLH) touring models '08-Up. Not for use in California on pollution controlled vehicles.

- Complete bolt-on kit: backing plate, filter and mounting hardware.
- Patented X-Wing design of more power and acceleration.
- X-Wing Venturi increases air speed for added throttle response.
- Oil free/washable filter media – poly-cotton blend.
- XL filter area for increased airflow – filters to 40 microns.
- One piece precision casting with internal breather passages.
- Bolt-on o-ring assembly – no modification required.
- Available in polished silver or matte black.
- Accepts stock filter cover.
- **Not legal for use in California on pollution controlled vehicles- check local laws before installation**



Application	Description	WPS#
Fits '08-16 Touring Models	Power X Intake Silver	59-9001
	Power X Intake Black	59-9002



## STREET METAL INTAKE SYSTEMS

K&N's Street Metal Intake Systems are designed to boost performance and add a custom look to your Harley-Davidson® motorcycle. These intake systems replace the stock intake assembly with a custom built intake system designed to increase horsepower and torque at the rear wheels.



793933



793932

### Guaranteed increase in horsepower

- Developed around an oversized K&N® High-Flow Air Filter™ that is designed to boost performance, filtration and service intervals
- Aluminum backing plate with integrated velocity stack provides solid mounting surface
- Built-in breathers replace external OE breathers\*
- High quality mirror-finish or wrinkle black aluminum cover

Application	Shape	Finish	Ref#	WPS#
<b>HARLEY DAVIDSON</b>				
Softail '01-15 and Dyna models '01-17	Hammer	Mirror	RK-3933	<b>793933</b>
	Flare	Mirror	RK-3932	<b>793932</b>
Touring Models '08-16	Hammer	Mirror	RK-3946	<b>793917</b>
	Flare	Mirror	RK-3947	<b>793934</b>
	Hammer	Black	RK-3946B	<b>793918</b>
	Flare	Black	RK-3947B	<b>793935</b>
	Hammer High Capacity	Mirror	RK-3946X	<b>793919</b>
	Flare High Capacity	Mirror	RK-3947X	<b>793936</b>
Hammer High Capacity	Hammer High Capacity	Black	RK-3946XB	<b>793920</b>
	Flare High Capacity	Black	RK-3947XB	<b>793937</b>
<b>REPLACEMENT ELEMENTS</b>				
	Hammer		HD-0800	<b>720800</b>
	Flare		E-3975	<b>703975</b>



## RK SERIES AIR INTAKE ASSEMBLIES

K&N's RK Series Air Cleaner Assemblies are designed to get more horsepower from your Harley-Davidson motorcycle. These air cleaner assemblies replace the stock air filter and backplate with an oversized K&N® Air Filter and custom aluminum backing plate. K&N's RK Series Air Cleaner Assemblies are designed to give you an increase in power and long service intervals critical for distance rides. This complete assembly fits inside the OE air cleaner cover maintaining stock appearance, while providing outstanding airflow.



- Developed around an oversized K&N® High-Flow Air Filter that is designed to boost performance, filtration and service intervals
- Dyno-tuned velocity stack directs airflow to engine
- Aluminum backing plate provides solid mounting surface
- Built-in breathers replace external OE breathers



Application	Ref #	WPS#
<b>HARLEY DAVIDSON</b>		
Twin Cam '99-07	RK-3909	<b>793909</b> *
Twin Cam, Large Capacity '99-07	RK-3910	<b>793910</b> *
Touring '08-16, Softails and FXDLS '16-17	RK-3930	<b>793930</b>
Softail '08-15	RK-3909	<b>793909</b>
Softail, Large Capacity '08-15	RK-3910	<b>793910</b>
Dyna '08-17 (except 16-17 FXDLS)	RK-3931	<b>793931</b>
Sportster 883/1200 '04-16	RK-3929	<b>793929</b>
<b>REPLACEMENT ELEMENT</b>		
RK-Series	E-3336	<b>703336</b>

\* = Excludes Twin-Cam Engines with the Magnetti-Morelli Fuel Injection System

- WINDSHIELDS / FAIRINGS
- AUDIO / COMMUNICATION
- SEATS / LUGGAGE
- BAR / MIRRORS / CONTROLS
- EXHAUST
- AIR / FUEL SYSTEMS
- ENGINE
- TRANSMISSION / DRIVELINE
- GASKETS / SEALS
- ELECTRICAL
- LIGHTING
- CABLES
- BRAKES
- OIL FILTERS
- SUSPENSION
- BODY
- WHEELS
- TIRES / TIRE ACC.
- BIKE ACC.
- VICTORY / INDIAN
- COVERS / LOCKS / TIEDOWNS
- CHEMICALS
- TOOLS
- HELMETS
- HELMET ACC.
- EYEWEAR
- APPAREL / RIDER ACC.
- PROMOTIONAL
- REFERENCE
- INDEX



## AIRCHARGER INTAKE SYSTEMS

K&N's AIRCHARGER® Performance Intake Kit will get more horsepower from your Harley-Davidson® motorcycle. This High-Flow Intake System increases power by eliminating the restrictive stock OE air cleaner and replacing it with a K&N® High-Flow Air Filter and mandril bent aluminum intake tube. This complete intake system will help relieve the labored feeling associated with two-up riding or loaded touring. K&N's High-Flow Intake System gives your Harley® an aggressive appearance while providing a significant increase in airflow resulting in more power.

- K&N® High-Flow Air Filter significantly increases performance
- Billet aluminum throttle-body mounting plate
- Includes complete breather assembly and mounting hardware
- Aluminum Intake Tube available in two finishes; Bright Mirror or Textured Black
- Guaranteed increase in horsepower
- Custom aluminum throttle-body mounting plate
- **Not legal for use in California on pollution controlled vehicles - Check local laws before installing**



K63-1125 K63-1125P



K63-1126 K63-1126P



K63-122P K63-1122

Application	Black	Polished
Touring* '08-17,'16-17 Softail and FXDLS	<b>K63-1122</b>	<b>K63-1122P</b>
Touring* (F/I models only) '01-07	<b>K63-1125</b>	<b>K63-1125P</b>
Dyna (F/I models only) '01-17 (except '16-17 FXDLS)	<b>K63-1125</b>	<b>K63-1125P</b>
Softail (F/I models only) '01-15	<b>K63-1125</b>	<b>K63-1125P</b>
Sportster '07-17	<b>K63-1126</b>	<b>K63-1126P</b>
<b>REPLACEMENT PARTS</b>		
Air Filter Element	<b>780960</b>	<b>783680</b>
Air Filter Wrap	<b>783680DK</b>	

\* Will not fit models with lower fairings

- WINDSHIELDS / FAIRINGS
- AUDIO / COMMUNICATION
- SEATS / LUGGAGE
- BAR / MIRRORS / CONTROLS
- EXHAUST
- AIR / FUEL SYSTEMS**
- ENGINE
- TRANSMISSION / DRIVELINE
- GASKETS / SEALS
- ELECTRICAL
- LIGHTING
- CABLES
- BRAKES
- OIL FILTERS
- SUSPENSION
- BODY
- WHEELS
- TIRES / TIRE ACC.
- BIKE ACC.
- VICTORY / INDIAN
- COVERS / LOCKS / TIEDOWNS
- CHEMICALS
- TOOLS
- HELMETS
- HELMET ACC.
- EYEWEAR
- APPAREL / RIDER ACC.
- PROMOTIONAL
- REFERENCE
- INDEX



## AIRCHARGER INTAKE SYSTEMS

K&N® AIRCHARGER® Performance Air Intake Systems increase power by eliminating the restrictive stock OE air cleaner and replacing it with a K&N® complete performance intake system.

Built with a heritage of over 45 years of performance, building horsepower and making motorcycles perform to get you moving down the highway! K&N's AIRCHARGER Intake System will give your motorcycle an aggressive appearance while providing a significant increase in airflow resulting in more horsepower and torque delivered to the rear wheels.



- Cast aluminum high-performance intake tube
- Integrated internal velocity stack
- Built-in breathers replace external OE breathers
- K&N® High-Flow cotton air filter provides outstanding performance and protection
- Fits Harley-Davidson Touring Models, without Lower Fairings



Application	Black	Satin
Touring* '08-16, '16-17 Softail and FXDLS	<b>K63-1134</b>	<b>K63-1134S</b>
Touring* (F/I models only) '01-07	<b>K63-1137</b>	<b>K63-1137S</b>
Dyna (F/I models only) '01-17 (except '16-17 FXDLS)	<b>K63-1137</b>	<b>K63-1137S</b>
Softail (F/I models only) '01-17	<b>K63-1137</b>	<b>K63-1137S</b>

## HIGH FLOW AIR FILTER FOR 58MM THROTTLE BODIES

The original High-Flow Air Filter™ invented by K&N®. A perfect upgrade for 2-up rides on your V-Twin motorcycle with filled saddle bags, a long life High-Flow Air Filter™ delivers improved performance and excellent protection for the life of your motorcycle.



- Designed to provide low restriction, resulting in increased airflow and high performance
- Pleated media provides a large filtration area, delivering high capacity and long service intervals
- Durable Zinc Coated top plates for years of protection without corrosion
- Pre-oiled and ready to ride
- Made in the USA

Application	WPS #
All Models with 58mm Throttle Body	<b>720801</b>

- WINDSHIELDS / FAIRINGS
- AUDIO / COMMUNICATION
- SEATS / LUGGAGE
- BAR / MIRRORS / CONTROLS
- EXHAUST
- AIR / FUEL SYSTEMS**
- ENGINE
- TRANSMISSION / DRIVELINE
- GASKETS / SEALS
- ELECTRICAL
- LIGHTING
- CABLES
- BRAKES
- OIL FILTERS
- SUSPENSION
- BODY
- WHEELS
- TIRES / TIRE ACC.
- BIKE ACC.
- VICTORY / INDIAN
- COVERS / LOCKS / TIEDOWNS
- CHEMICALS
- TOOLS
- HELMETS
- HELMET ACC.
- EYEWEAR
- APPAREL / RIDER ACC.
- PROMOTIONAL
- REFERENCE
- INDEX

WINDSHIELDS / FAIRINGS  
 AUDIO / COMMUNICATION  
 SEATS / LUGGAGE  
 BARS / MIRRORS / CONTROLS  
 EXHAUST  
 AIR / FUEL SYSTEMS  
 ENGINE  
 TRANSMISSION / DRIVELINE  
 GASKETS / SEALS  
 ELECTRICAL  
 LIGHTING  
 CABLES  
 BRAKES  
 OIL FILTERS  
 SUSPENSION  
 BODY  
 WHEELS  
 TIRES / TIRE ACC.  
 BIKE ACC.  
 VICTORY / INDIAN  
 COVERS / LOCKS / TIEDOWNS  
 CHEMICALS  
 TOOLS  
 HELMETS  
 HELMET ACC.  
 EYEWEAR  
 APPAREL / RIDER ACC.  
 PROMOTIONAL  
 REFERENCE  
 INDEX



# SHAKER INTAKE SYSTEMS NEW

- Cast aluminum high-volume intake with exaggerated sanded fins
- Oversized K&N® High-Flow Air Filter™ for excellent filtration and long service intervals
- Built-in dyno-tuned velocity-stack directs airflow to the throttle body
- Mounts with integrated breather system
- Available in black satin and satin silver finis



Application	Black	Satin
Touring '08-16, '16-Up Softails, '17-Up Dynas	<b>K63-3951</b>	<b>K63-3951S</b>
Touring (F/I models only) '01-07	<b>K63-3950</b>	<b>K63-3950S</b>
Dyna (F/I models only) '01-16	<b>K63-3950</b>	<b>K63-3950S</b>
Softail (F/I models only) '01-15	<b>K63-3950</b>	<b>K63-3950S</b>





# HIGH FLOW REPLACEMENT AIR FILTERS



- Designed to provide increased horsepower and torque
- Pleated media provides a large filtration area offering long service intervals
- Multi-Layers of woven cotton gauze media offers excellent filtration
- Application specific base seal and sealing bead

- Fuel-Management modifications are not required for increased performance
- Made in the USA for over 40 years
- Washable & reusable, pre-oiled and ready to ride!
- Includes K&N Million-Mile Limited Warranty®



721717

Application	Year	Ref. #	WPS#
<b>HARLEY DAVIDSON</b>			
<b>TOURING</b>			
All models	'84-85	HD-2084	<b>722084</b>
	'86-89	HD-2086	<b>722086</b>
All models w/out fuel injection	'90-98	HD-1390	<b>721390</b>
	'99-01	HD-1499	<b>721499</b>
All models w/ fuel injection†	'96-98	HD-1395	<b>721395</b>
	'99-01	HD-8899	<b>728899</b>
All models†	'02-07	HD-1499	<b>721499</b>
	'08-13	HD-1508	<b>721508</b>
	'14-16	HD-1614	<b>721614</b>
	2017 M8	HD-1717	<b>721717</b>
<b>SOFTAIL</b>			
FLSTCI Heritage Softail Classic F/I	'01	HD-8899	<b>728899</b>
FLS Softail Slim	'12-15	HD-1611	<b>721611</b>
	'16-17	HD-1614	<b>721614</b>
All models*†	'86-89	HD-2086	<b>722086</b>
	'90-99	HD-1390	<b>721390</b>
	'00-15	HD-1499	<b>721499</b>
	'16-17	HD-1614	<b>721614</b>
<b>FXR/DYNA</b>			
All models†	'84-85	HD-2084	<b>722084</b>
	'86-89	HD-2086	<b>722086</b>
	'90-98	HD-1390	<b>721390</b>
	'99-07	HD-1499	<b>721499</b>
Except '16-17 FXDLS	'08-17	HD-9608	<b>729608</b>
<b>V-ROD</b>			
All models	'02-17	HD-1102	<b>721102</b>
<b>SPORTSTER</b>			
XL models	'86-87	HD-2085	<b>722085</b>
	'88-03	HD-1388	<b>721388</b>
	'04-13	HD-8834	<b>728834</b>
	'14-17	HD-1212	<b>721212</b>
XR1200	'08-12	HD-1208	<b>721208</b>
<b>STREET 500/750</b>			
All models	'15-Up	HD-4915	<b>724915</b>
<b>SCREAMIN' EAGLE AIR CLEANER REPL. ELEMENTS</b>			
<b>TOURING MODELS</b>			
FLHRSE3 Screamin Eagle Road King	'07	HD-0800	<b>720800</b>
FLHTCSE2 Screamin Eagle Electra Glide 2	'05	HD-0800	<b>720800</b>
FLHTCUSE2 Screamin Eagle Ultra Classic Electra Glide	'07	HD-0800	<b>720800</b>
FLHTCUSE3 Screamin Eagle Ultra Classic Electra Glide	'08	HD-1508	<b>721508</b>
FLHTCUSE4 CVO Ultra Classic Electra Glide	'09	HD-1508	<b>721508</b>
FLHTCUSE CVO Ultra Classic Electra	'11-13	HD-0910	<b>720910</b>
FLHTKSE CVO Ultra Limited	'14	HD-0910	<b>720910</b>
Touring models replaces H-D # 29244-08	'08	HD-0818	<b>720818</b>
<b>SOFTTAIL MODELS</b>			
FLSTNSE	'14	HD-0910	<b>720910</b>
FXSTSSE Screamin Eagle Softail Springer	'07	HD-0800	<b>720800</b>
FLSS	'16-Up	HD-0818	<b>720818</b>
<b>DYNA</b>			
FXDSE Screamin Eagle Dyna	'07	HD-0800	<b>720800</b>
FXDSE2 Screamin Eagle Dyna	'08	HD-0800	<b>720800</b>
Dyna Models replaces H-D # 29385-08	'08-09	HD-0808	<b>720808</b>
<b>SPORTSTER</b>			
883/1200 Sportster replaces H-D # 29044-04B	'04-09	HD-0900	<b>720900</b>
<b>NON H-D AIR FILTER REPLACEMENT</b>			
Custom S&S	6"OD, 4-5/8"ID, 2-1/16"H;	E-3224	<b>793224</b>
Custom S&S	6"OD, 4-5/8"ID, 2-3/16"H;	E-3225	<b>793225</b>
Custom S&S "E" and "G"	6"OD, 4-5/8"ID, 2-1/2"H	E-3226	<b>793226</b>
Rev Tech	7"OD, 5.5"ID, 2"H	E-4660	<b>794660</b>
Big Sucker		HD-0800	<b>720800</b>

\* Except '01 FLSTCI and '12-13 FLS  
 † Except Screaming Eagle models

- WINDSHIELDS / FAIRINGS
- AUDIO / COMMUNICATION
- SEATS / LUGGAGE
- BARS / MIRRORS / CONTROLS
- EXHAUST
- AIR / FUEL SYSTEMS**
- ENGINE
- TRANSMISSION / DRIVELINE
- GASKETS / SEALS
- ELECTRICAL
- LIGHTING
- CABLES
- BRAKES
- OIL FILTERS
- SUSPENSION
- BODY
- WHEELS
- TIRES / TIRE ACC.
- BIKE ACC.
- VICTORY / INDIAN
- COVERS / LOCKS / TIEDOWNS
- CHEMICALS
- TOOLS
- HELMETS
- HELMET ACC.
- EYEWEAR
- APPAREL / RIDER ACC.
- PROMOTIONAL
- REFERENCE
- INDEX



## CRANKCASE VENT AIR FILTERS

### REMOTE MOUNT

Designed for racing engines where crankcase breathing is essential. Prevents dirt from entering engine on deceleration. Comes in two styles: Remote Mount with rubber top uses tubing to connect filter and vent. Remote Mount with chrome top has 1/4" stud and nut to mount in convenient place.



Vent Size    K&N    Remote Mount    WPS#

**2" DIA. X 1 1/2" METAL BASE**

3/8"	62-1000	Rubber	<b>62-0100</b>
1/2"	62-1010	Rubber	<b>62-0101</b>
3/4"	62-1030	Rubber	<b>62-0103</b>
1/2"	62-1100	Chrome - w/stud	<b>62-0110</b>
5/8"	62-1110	Chrome - w/stud	<b>62-0111</b>
3/4"	62-1120	Chrome - w/stud	<b>62-0112</b>
1"	62-1130	Chrome - w/stud	<b>62-0113</b>

**3" TOP & 2" LONG**

1/2"	62-1050	Rubber	<b>62-0105</b>
------	---------	--------	----------------

*Legal in California ONLY for racing vehicles which may NEVER be used upon a highway*

### DIRECT MOUNT

#### UNIVERSAL CLAMP-ON STYLE CRANKCASE FILTERS

Filters clamp directly to vent tubes on valve cover or crankcase. Ideal for all engines, transmissions, oil and gas tanks.



Vent Size    K&N    Direct Mount    WPS#

**2" DIA. X 1 1/2"**

1/2"	62-1330	Chrome Top	<b>62-0133</b>
5/8"	62-1340	Chrome Top	<b>62-0134</b>
3/4"	62-1360	Chrome Top	<b>62-0136</b>
1"	62-1370	Chrome Top	<b>62-0137</b>

**3" DIA. X 2 1/4"**

1"	62-1420	Chrome Top	<b>62-0142</b>
1 1/4"	62-1380	Rubber Top	<b>62-0138</b>
1 1/4"	62-1390	Chrome Top	<b>62-0139</b>

**UNIVERSAL ADAPTER**

Universal 1/2 Valve cover vent adapter requires drilling 5/8" hole in valve cover    **85-1050**

## K&N CLEANING AND REOILING SUPPLIES:

Recharge your K&N Air Filter with genuine K&N Cleaning Accessories. Cleaning and re-oiling your K&N filters is very simple with the use of K&N's four-step maintenance system designed to recharge your K&N Air Filter. The use of K&N cleaner and filter oil completely restores airflow efficiency so your air filter performs virtually like new.

#### KIT "A" CONTAINS:

- 1 - 12 oz. Air Filter Cleaner Spray Bottle
- 1 - 6.5 oz. Air Filter Oil Aerosol



Size	WPS#
A 12/case	<b>62-1514</b>
B 12/case	<b>62-1515</b>

*NOTE: Use of other cleaning or oiling methods, cleaners or oils could damage the filter and void K&N Warranty*

#### KIT "B" CONTAINS:

- 1 - 12 oz. Air Filter Cleaner Spray Bottle
- 1 - 8 oz. Squeeze Oil and Service Decal



### POWER KLEEN™

- Air filter cleaner/degreaser dissolves dirt build-up and old filter oil



Size	WPS#
12 oz 12/case	<b>62-1530</b>
32 oz 12/case	<b>62-1532</b>
1 gal 4/case	<b>62-1531</b>
5 gal Bucket	<b>62-1533</b>

### AIR FILTER OIL

- Penetrates into the pleated cotton media to provide outstanding air filtration



Size	WPS#
6.5 oz 12/case	<b>62-1506</b>
12 oz 12/case	<b>62-1512</b>
1 gal	<b>62-1513</b>

### SEALING GREASE

Provides an airtight fit around sealing surfaces on all types of air filter elements. It resists heat and will not melt and run off. Not to be used on clamp-on filter elements.

Size	WPS#
6 oz 12/case	<b>62-1509</b>





## OEM STYLE REPLACEMENT AIR FILTERS

Emgo Air Filters meet or exceed OEM quality. All air filters are individually boxed with complete up-to-date application information printed on each box.

Application	Year	OEM #	WPS #
<b>TOURING</b>			
FLHT/FLHTC/FLHTP/FLHTU †	'83-04	29259-93	<b>78-9703</b>
FLHS †	'90-98	29259-93	<b>78-9703</b>
FLTC/FLTCU †	'81-95	29259-93	<b>78-9703</b>
FL/FLH/FLT	'78-86	28255-78	<b>78-9702</b>
<b>SOFTAIL</b>			
All models	'84-98	29259-93	<b>78-9703</b>
<b>DYNA AND FXR</b>			
FXDB/FXDBD/FXDBWG/FXDBS †	'91-96	29259-93	<b>78-9703</b>
FXLR †	'87-94	29259-93	<b>78-9703</b>
FX/FXB/FXE/FXR/FXS/FXW	'79-94	28255-78	<b>78-9702</b>
<b>SPORTSTER</b>			
XL Models	'88-03	29036-88A	<b>78-9704</b>
XLH/XLHS/XLHX/XLHXR	'79-85	28255-78	<b>78-9702</b>
<b>REPLACEMENT PAPER ELEMENT</b>			
S&S type air cleaner or EMGO 07-16030 and 07-16070 air cleaners			<b>78-9701</b>

† Carbureted models only



Application	Year	OEM #	WPS #
<b>BIG TWINS</b>			
All	'41-66	29036-41	<b>NU-3412</b>
FL/FX	'67-75	29036-72	<b>NU-3403</b>
	'77-78	29086-75	<b>NU-3405</b>
All	'86-88	29259-86	<b>NU-3423</b>
	'89-92	29259-89	<b>NU-3425</b>
All Carbureted	'93-00	29259-93	<b>NU-3427</b>
<b>SPORTSTER</b>			
XL Models	'83-85	29036-72	<b>NU-3403</b>
	'88-01	29036-88	<b>NU-3424</b>
XLH/XLHS/XLHX/XLHXR	'66-73	29036-72	<b>NU-3403</b>
	'75-78	29086-75	<b>NU-3405</b>
<b>BUELL</b>			
XB9/XB12	'02-10		<b>NU-3431</b>
<b>CUSTOM/AFTERMARKET APPLICATIONS</b>			
S&S E Series No. 379 Element	All		<b>NU-3426</b>

## OEM STYLE REPLACEMENT AIR FILTERS

- Fits exactly like the original equipment air filter
- High flow Uni-filter will improve performance and provide the best filtration and engine protection available
- Uni-filters can be easily cleaned and reused
- "Flow Matched" filters need no rejetting

- WINDSHIELDS / FAIRINGS
- AUDIO / COMMUNICATION
- SEATS / LUGGAGE
- BARS / MIRRORS / CONTROLS
- EXHAUST
- AIR / FUEL SYSTEMS**
- ENGINE
- TRANSMISSION / DRIVELINE
- GASKETS / SEALS
- ELECTRICAL
- LIGHTING
- CABLES
- BRAKES
- OIL FILTERS
- SUSPENSION
- BODY
- WHEELS
- TIRES / TIRE ACC.
- BIKE ACC.
- VICTORY / INDIAN
- COVERS / LOCKS / TIEDOWNS
- CHEMICALS
- TOOLS
- HELMETS
- HELMET ACC.
- EYEWEAR
- APPAREL / RIDER ACC.
- PROMOTIONAL
- REFERENCE
- INDEX

- WINDSHIELDS / FAIRINGS
- AUDIO / COMMUNICATION
- SEATS / LUGGAGE
- BAR / MIRRORS / CONTROLS
- EXHAUST
- AIR / FUEL SYSTEMS
- ENGINE
- TRANSMISSION / DRIVELINE
- GASKETS / SEALS
- ELECTRICAL
- LIGHTING
- CABLES
- BRAKES
- OIL FILTERS
- SUSPENSION
- BODY
- WHEELS
- TIRES / TIRE ACC.
- BIKE ACC.
- VICTORY / INDIAN
- COVERS / LOCKS / TIEDOWNS
- CHEMICALS
- TOOLS
- HELMETS
- HELMET ACC.
- EYEWEAR
- APPAREL / RIDER ACC.
- PROMOTIONAL
- REFERENCE
- INDEX



# MASTERTUNE SYSTEM FOR V-TWIN



The TTS MasterTune System is designed specifically to tune all 2001 and later Delphi-equipped Harley-Davidson® motorcycles, and includes four powerful Windows®-based programs, including:

### MasterTune2-HD:

An ECM calibration development tool that allows you to:

- Choose from a wide selection of base maps
- Save and Restore current calibration (factory or other)
- Modify many critical ECM tables and constants
- Graph tables in 2D or 3D
- Quickly compare changes in tables
- Correct speedometer calibration
- Change primary ratio

### VTune3-HD:

Assists you with:

- Calibrating VE tables
- Calibrating spark tables
- Calibrating EGR correction tables
- Verifying injector sizing

### DataMaster2-HD:

A diagnostic and calibration support tool that allows you to:

- Check and Clear diagnostic codes
- Utilize VTune Histogram for tuning development
- View real time engine parameters
- Playback recorded data
- Analyze Camshaft settings
- Analyze IAC warmup settings
- Simulate dyno and ¼ mile results

### Flight Recorder:

Configures a Communications Interface to allow you to:

- Record data without a computer
- Record as much as 8 hours of data
- Store up to 64 recordings
- Automatically start and stop recordings

Not legal for use in California on pollution controlled vehicles - Check local laws before installing



Communication Interfaces	WPS#
MasterTune 2 Single Bike (Blue)	133-5000
MasterTune 2 Dual Bike (Blue)	133-5001
Analog MasterTune Single Bike (Green)	133-5002
CABLE KITS REQUIRED	
Touring Models '14-18	133-5003
Touring Models '02-13	133-5004
Softail Models '11-18	133-5003
Softail Models '01-10	133-5004
Dyna Models '12-17	133-5003
Dyna Models '04-11	133-5004
Sportster Models '14-18	133-5003
Sportster Models '07-13	133-5004
V-Rod Models '02-17	133-5004
Street 750/500 Models '15-18	133-5003
REPLACEMENT CABLES	
6-Pin CAN Cable	133-5005
4-Pin J1850 Cable	133-5006
USB to Serial Conversion Cable	133-5007

- All TTS MasterTune software is compatible with 32- and 64- bit versions of Windows 7 and newer
- Cables sold separately
- Made in USA



## TIER1 FUEL OPTIMIZER FOR HARLEY DAVIDSON



**CCT is an acronym for “Consecutive Cycle Tuning”. We use CCT to describe our fuel tuning process, which is the measuring of consecutive cycles of power, with unique amounts of fuel to determine which fuel amount provides the best acceleration.**

The process, in many ways, is identical to the acceleration measuring procedure used in today’s most popular tuning dynamometers, such as, those made by Dynojet and other companies. The important thing to remember is the time between consecutive cycles of power and between fuel adjustments on a dynamometer are measured in minutes and is based on one style of load or acceleration simulation at any given time, while the Tier 1 Tuners innovative +CCT Acceleration Tuner technology has a time between consecutive cycles of power and tuning of fuel that is measured in milliseconds and is based on Real Time/Real Life constant feedback.

The Tier 1 Tuners +CCT Acceleration Tuner can now provide your motorcycle with Real Time fuel adjustments that will optimize acceleration and compensate for the constantly changing Real Life conditions, (i.e. 1up/2up, head winds, tailwinds, uphill, down hills, etc.) which substantially affects the performance mode operations of your motorcycle throughout your normal daily driving.

### The +CCT’s patented technology adds a “Closed Loop” control system to your bikes fuel injection system.

Almost all motorcycle fuel injection systems in use today are using “open loop” control systems when they are being driven in a performance manner. “Open loop” refers to a control system that does not have feedback to adapt to conditions outside of its current programming, while a “closed loop” control system functions by its ability to take feedback from an engine sensor. For example, the oxygen sensors common on many of today’s motorcycles use this type of system in cruise, but not in power mode.

The +CCT Acceleration Tuner unit will add a “closed loop” control system to your current fuel injection system while it is in performance mode. The +CCT Acceleration Tuner adjusts fuel while receiving feedback from the engine’s acceleration in Real Time/Real Life. The fuel is changed to whatever is needed to optimize the engine’s acceleration while in performance mode.

### Tier1Tuners +CCT Acceleration Tuner can provide up to 95% optimization under Real Time/Real Life performance acceleration.

Most motorcycles today that use an “open loop” control system during power mode operation are typically about 70% optimized (because of various Real Time/Real Life road conditions). When optimizing the fuel map to 70%, a 30% margin is created to maintain good drivability over the full range of acceleration rates found in real life performance driving. The +CCT Acceleration Tuner’s “closed loop” functionality cuts this margin of error from 30% to only 5% thus giving you up to 95% optimization under Real Time/Real Life performance.

**Tier1Tuners new +CCT Acceleration Tuner is a standalone performance product. It requires no other modifications to deliver its performance potential.** The +CCT Acceleration Tuner derives its benefit from its Real Time/Real Life “closed loop” functionality, not from making a better or different open loop fuel map.



- Real Time Fuel Adjustments
- Up To 95% Optimization Under Real Life Acceleration
- Works On Stock Or Currently Mapped Bikes
- Measures only 2"x1"x1/4"
- Made In The U.S.A



Application	Year	WPS#
<b>HARLEY DAVIDSON</b>		
Milwaukee-Eight	2017	134-30007
Touring	14-16	134-30002
Touring	08-13	134-30001
Touring Police	08-09	134-30002
Touring	2007	134-30003
Softail Dyna	06-16	134-30003
Sportster 1200	14-17	134-30008
Sportster 883	14-17	134-30009
Sportster 1200	07-13	134-30004
Sportster 883	07-13	134-30005
Street 750	ALL	134-30006
Softail CVO	2007	134-30007
Big Twin	95-06	134-30000

- WINDSHIELDS / FAIRINGS
- AUDIO / COMMUNICATION
- SEATS / LUGGAGE
- BARS / MIRRORS / CONTROLS
- EXHAUST
- AIR / FUEL SYSTEMS**
- ENGINE
- TRANSMISSION / DRIVELINE
- GASKETS / SEALS
- ELECTRICAL
- LIGHTING
- CABLES
- BRAKES
- OIL FILTERS
- SUSPENSION
- BODY
- WHEELS
- TIRES / TIRE ACC.
- BIKE ACC.
- VICTORY / INDIAN
- COVERS / LOCKS / TIEDOWNS
- CHEMICALS
- TOOLS
- HELMETS
- HELMET ACC.
- EYEWEAR
- APPAREL / RIDER ACC.
- PROMOTIONAL
- REFERENCE
- INDEX



# ELECTRONIC JET KIT

The EJK (Gen 3 Electronic Jet Kit) evolved out of the need to address the ever-increasing complexity of factory fuel injection. For the new-comer to the market or professionals wanting an easier method for tuning fuel injection, the EJK is a customizable solution for the shop that wants to take control of their tuning needs.



- No computer needed
- No dyno required
- Quick "plug and play" installation, initial settings are all preset based on make/model
- Full range tunability, does not interfere with stock ECU
- Simple push button adjustment interface
- 2 year warranty
- **Not legal for use in California on pollution controlled vehicles - Check local laws before installing**

Application	Year	WPS#
<b>BUELL</b>		
All models (unless listed below)	'99-07	<b>912-0262</b>
1125R	'08-10	<b>912-0301</b>
XB9	'08-10	<b>912-0309</b>
XB12	'08-10	<b>912-0309</b>
<b>HARLEY DAVIDSON</b>		
Street 500/750	'15-17	<b>912-0447</b> *
Big Twins	'95-05	<b>912-0265</b>
Dyna	'06-11	<b>912-0305</b> *
Dyna 103"	'12-17	<b>912-0388</b> *
Dyna 110"	'16-17	<b>912-0449</b> *
Softail (exc. CVO)	'06	<b>912-0267</b>
	'07-11	<b>912-0305</b> *
	'12-15	<b>912-0388</b> *
	'16-17	<b>912-0449</b> *
Softail CVO Models	'11	<b>912-0411</b>
	'12	<b>912-0412</b>
	'13-14	<b>912-0445</b>
	'15	<b>912-0412</b>
Sportster	'07-13	<b>912-0306</b> *
	'14-17	<b>912-0423</b> *

Application	Year	WPS#
<b>HARLEY DAVIDSON (CONT'D...)</b>		
Touring models exc. below	'06	<b>912-0267</b>
	'07	<b>912-0305</b> *
	'08-09	<b>912-0307</b> *
	'10-13	<b>912-0333</b>
	'14-16	<b>912-0422</b> *
Milwaukee-Eight 107"	'17	<b>912-0468</b> *
CVO/Milwaukee-Eight 114"	'17	<b>912-0469</b> *
V-Rod	'02-07	<b>912-0269</b>
	'08-11	<b>912-0308</b> *
	'12-17	<b>912-0389</b> *
<b>INDIAN</b>		
Chief	'09-13	<b>912-0365</b>
	'14-17	<b>912-0436</b> *
Chieftain	'14-17	<b>912-0436</b> *
Roadmaster	'15-17	<b>912-0436</b> *
Scout/Scout Sixty	'15-17	<b>912-0446</b> *
Springfield	'16-17	<b>912-0436</b> *
<b>VICTORY</b>		
All models	'00-07	<b>912-0279</b>
	'08-15	<b>912-0420</b> *
All models exc. Octane	'16-17	<b>912-0448</b> *
Octane	'17	<b>912-0462</b> *

## AFR+ FUEL TUNER

GEN 4 TECHNOLOGY

The AFR+ brings together two technologies within one system to make it the most powerful, user-friendly tuning device on the market. AFR+ combines an EFI controller with a wideband O2 sensor and AFR gauge to provide a user instant fuel trimming ability and feedback about their vehicle's state of tune.



- Maximizes power and fuel economy
- Plug and play installation
- On the fly tuning, no dyno required
- Works with all ECU downloads and all brands of aftermarket ECU controllers
- Does not interfere with stock ECU operation
- Includes air/fuel ratio gauge (2 1/8" diameter), wideband controller and Bosch O2 sensor (gauge mount and O2 sensor bung not included)
- Harley Davidson AFR gauge is chrome w/white face/orange needle
- 1 Year warranty, will not void any OEM factory warranties
- **Not legal for use in California on pollution controlled vehicles - Check local laws before installing**

Application	Year	WPS#
<b>HARLEY DAVIDSON</b>		
Big Twin	'95-01	<b>131-12001</b>
	'02-04	<b>131-12002</b>
	'05	<b>131-12001</b>
Dyna	'06-11	<b>131-12004</b>
Dyna 103"	'12-17	<b>131-12007</b>
Dyna 110"	'16-17	<b>131-12022</b>

Application	Year	WPS#
<b>HARLEY DAVIDSON (CONT'D...)</b>		
Softail	'06	<b>131-12003</b>
	'07-11	<b>131-12004</b>
	'12-15	<b>131-12007</b>
	'16-17	<b>131-12022</b>
Softail CVO Models	'11	<b>131-12012</b>
	'12, '15	<b>131-12015</b>
Sportster	'07-13	<b>131-12011</b>
	'14-15	<b>131-12017</b>
Street 500/750	'16-17	<b>131-12020</b>

Application	Year	WPS#
<b>HARLEY DAVIDSON (CONT'D...)</b>		
Touring	'06	<b>131-12003</b>
	'07	<b>131-12004</b>
	'08-09	<b>131-12005</b>
	'10-13	<b>131-12006</b>
	'14-16	<b>131-12016</b>
V-Rod	'02-07	<b>131-12008</b>
	'08-11	<b>131-12009</b>
	'12-17	<b>131-12010</b>

# TWIN TUNER



The Twin Tuner allows you to easily adjust your fuel injection to match the requirements of performance parts including camshafts, free flowing exhausts, and low restriction air filters. You can add up to +30% or subtract down to -20% fuel.

You can use the mode and up/down pushbutton switches to make fuel trim adjustments in the RPM and throttle position ranges required by most applications. The fuel trim value is displayed on a bright daylight readable LED display. The Twin Tuner also has an advanced mode, where you can use the optional USB Interface and PC Link Tuner software to make precise fuel adjustments. The USB interface also allows you to make independent adjustments to the front and rear cylinders.



- Increases horsepower
- Improves throttle response
- Easy plug-in installation and setup
- Very compact size - only 4" L x 2" W x 1/2" H
- Optional USB interface and PC link tuner software available to make precise fuel adjustments
- Oxygen sensor eliminator kits available separately (model depending) for more precise tuning at idle and partial throttle
- Low cost

Not legal for use in California on pollution controlled vehicles - Check local laws before installing

Application	Year	WPS #
<b>HARLEY DAVIDSON</b>		
All Twin Cam w/36 pin Delphi system (except below)	'01-11	<b>132-7000</b>
All Twin Cam w/36 pin Delphi system (50 state legal)	'01-08	<b>132-7001</b> *
Twin Cam Touring models w/73 pin Delphi system	'08-16	<b>132-7002</b>
Dyna w/CAN data bus (except '16-Up FXDLS)	'12-17	<b>132-7005</b>
Softail w/36 pin Delphi system	'11	<b>132-7004</b>
Softail w/CAN data bus	'12-15	<b>132-7005</b>
Sportster	'07-17	<b>132-7004</b>
Buell	'03-07	<b>132-7032</b>

\* 50 state legal

# TWIN TUNER II

The Twin Tuner II has all of the features of the Twin Tuner and also allows retarding of the spark timing up to 10° to help prevent pre-ignition knocking.

The user interface consists of up/down push buttons and a bright daylight readable LED display to select and change the fuel trim and spark retard in the RPM and throttle position ranges required by most applications.

Not legal for use in California on pollution controlled vehicles - Check local laws before installing



Application	Year	WPS#
<b>HARLEY DAVIDSON</b>		
Dyna® w/CAN data bus (except '16-17 FXDLS)	'12-17	<b>132-7013</b>
Softail® w/CAN data bus	'12-17	<b>132-7013</b>
Sportster® w/36 pin Delphi system	'07-17	<b>132-7010</b>
Twin Cam w/36 pin Delphi system	'01-11	<b>132-7010</b>
Twin Cam Touring models w/73 pin Delphi system	'08-16	<b>132-7011</b>
V-Rod™ w/36 pin Delphi system	'02-17	<b>132-7012</b>

- WINDSHIELDS / FAIRINGS
- AUDIO / COMMUNICATION
- SEATS / LUGGAGE
- BARS / MIRRORS / CONTROLS
- EXHAUST
- AIR / FUEL SYSTEMS**
- ENGINE
- TRANSMISSION / DRIVELINE
- GASKETS / SEALS
- ELECTRICAL
- LIGHTING
- CABLES
- BRAKES
- OIL FILTERS
- SUSPENSION
- BODY
- WHEELS
- TIRES / TIRE ACC.
- BIKE ACC.
- VICTORY / INDIAN
- COVERS / LOCKS / TIEDOWNS
- CHEMICALS
- TOOLS
- HELMETS
- HELMET ACC.
- EYEWEAR
- APPAREL / RIDER ACC.
- PROMOTIONAL
- REFERENCE
- INDEX



## TCFI EFI CONTROLLERS

- Fully programmable plug-in replacement for 36 pin Delphi controller with J1850 data bus
- Quickly auto-tune fuel curves for front and rear cylinders on a dyno or on-road with new WEGO IIID dual channel wide-band oxygen sensor interface
- Robust alpha-N (throttle position and RPM based) fuel control eliminates problems with long duration/high overlap camshafts
- Extended data logging and diagnostics
- DataFLASH memory stores full 60 minutes of operating data at 10 samples/second
- Powerful Windows software for custom programming and data analysis
- Programmable user input for functions (not available in TCFI EX version)
- Programmable user output for functions (not available in TCFI EX version)
- Billet aluminum housing with black anodized finish
- Support for new 6th gear indicator on '07-13 models
- Easy plug-in installation Supports all sensors including theft/security module

**Not legal for use in California on pollution controlled vehicles - check local laws before installation**



The TCFI kit includes the WEGO IIID dual channel wide-band exhaust gas oxygen interface that allows quick auto-tuning on a dyno or on-road during actual riding conditions. The kit includes Bosch LSU 4.2 wide-band sensors for both front and rear cylinders. The TCFI solves tuning problems with highly modified engines. Competitive "band-aid" products that interface to the Delphi® controller still rely on speed-density fuel control. Long duration/high overlap camshafts wreak havoc with manifold pressure - especially at idle and cruise RPM. Speed-density based fuel control simply can't cope.

Model #	Application	Year	WPS #
TCFI 4 Kit	All Twin Cam w/36 pin Delphi system (except TBW)	'01-11	<b>132-7070</b>
TCFI 4 Kit	All Sportster w/36 pin Delphi system	'07-13	<b>132-7071</b>
TCFI 4 Kit	Turbo/Supercharged Twin Cam models w/36 pin Delphi system (except TBW)	'01-11	<b>132-7072</b>
VRFI 4 Kit	All V-Rod Models	'02-17	<b>132-7073</b>
TCFI EX Kit	All Twin Cam w/36 pin Delphi system (except 2006 Dyna)	'01-06	<b>132-7074 *</b>
TCFI 5 Kit	All Twin Cam w/36 pin CAN BUS system (except '11 Softail)	'12-17	<b>132-7075</b>
TCFI 6 Kit	All Twin Cam w/73 pin Delphi Throttle by Wire	'08-13	<b>132-7076</b>
TCFI 7 Kit	All Touring Models	'14-16	<b>132-7082</b>

\* 50 state legal



## IGNITION & FUEL MODULE BY DYNATEK

The new Fusion FI controller combines both fuel and ignition tuning into one device and comes equipped with factory connectors for easy installation.

- PC programmable fuel & ignition maps
- 2 position map switching function
- Gear position input
- Analog input for 0-5 volt input for boost mapping
- Individual cylinder mapping
- 100/+250% fuel adjustment range
- Can use Power Commander maps
- Self Tuning with the DynaTune autotune kit

**Not legal for use in California on pollution controlled vehicles - check local laws before installation**



Application	Years	WPS#	Application	Years	WPS#
Touring Models	'02-06	<b>133-2006</b>	Dyna Models	'12-17	<b>133-2015</b>
Touring Models	'07	<b>133-2007</b>	883 Sportsters	'07-09	<b>133-2001</b>
Touring Models	'08-13	<b>133-2008</b>	883 Sportsters	'10-13	<b>133-2002</b>
Touring Models	'14-16	<b>133-2019</b>	883 Sportsters	'14-17	<b>133-2021</b>
Touring Models	'17-Up	<b>133-2025</b>	1200 Sportsters	'07-09	<b>133-2003</b>
Softail Models	'01-06	<b>133-2009</b>	1200 Sportsters	'10-13	<b>133-2004</b>
Softail Models	'07-11	<b>133-2010</b>	1200 Sportsters	'14-16	<b>133-2020</b>
Softail Models	'12-15	<b>133-2011</b>	XR1200	'09-12	<b>133-2005</b>
Softail Models	'16-17	<b>133-2024</b>	V-Rod	'02-07	<b>133-2016</b>
Softail Deluxe / Heritage	'09-11	<b>133-2012</b>	V-Rod	'08-11	<b>133-2017</b>
Softail Models	2018	<b>133-2026</b>	V-Rod	'12-17	<b>133-2018</b>
Dyna Models	'04-05	<b>133-2013</b>	Street 500	'15-16	<b>133-2022</b>
Dyna Models	'06-11	<b>133-2014</b>	Street 750	'15-16	<b>133-2023</b>





**NOTE:** Only works in conjunction with Dynatek Fusion Control Module, it is not a stand alone tuner.

### DYNATUNE AUTOTUNE KIT

The DynaTune kit monitors the fuel mixture (by installing the included Wide Band O2 sensor(s) in the exhaust). It then sends this information to the Dynatek Fusion Control Module and automatically corrects it as you ride, letting you feel the changes as they happen. Each map that we offer has preset Air/Fuel ratio target values included that we find to be the best overall settings.

This lets you simply plug in the unit and let it do the work. For advanced users who would like to change the Air/Fuel ratios from our baseline, they are fully adjustable. Each throttle opening/rpm combination is individually adjustable, so that you can have both fuel economy, during cruise, while maintaining peak output at larger throttle openings. For most models of bikes it is also possible to adjust the Air/Fuel ratios "per gear". make adjustments.

This gives you total control of the fueling in every gear and throttle/rpm area if required. The DynaTune kit can be configured to run and make adjustments at all times or by using the "map switch port" on the Dynatek Control Module you can set it up so that you can switch back and forth between the tuning mode and the base map settings. You can also configure the DynaTune kit to wait until the bike is at a certain operating temperature before beginning to make adjustments.

Description	Year	WPS#
All Harley-Davidson w/ O2 sensors		<b>133-1052</b>
Softail	'11-12	<b>133-1053</b>
Dyna	'12	<b>133-1053</b>

Not legal for use in California on pollution controlled vehicles - Check local laws before installing

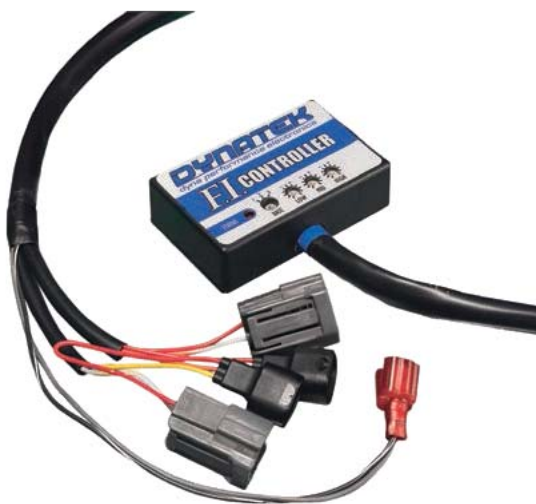

### FI CONTROLLER

The new Dyna Fuel Injection Controller is a plug in module that offers 3 user selectable base fuel curves that are designed to improve engine operation and can be modified to suit a wide variety of modifications. These adjustments are made via 3 potentiometers that adjust the fuel curve in the proper ranges for the application. Fuel mixture can be enriched or leaned as required.

The Dyna FI Controller uses the factory connectors for easy installation and there is no PC required for tuning or adjusting the fuel curves. There are no modifications to the stock ECU and removing the Dyna FI controller returns the vehicle to the factory configuration.

Not legal for use in California on pollution controlled vehicles - Check local laws before installing

Application	Years	WPS #
Evo Touring Models	'97-98	<b>133-1001</b>
Twin Cam Touring Models	'99-01	<b>133-1002</b>
Twin Cam Touring Models	'02-05	<b>133-1003</b>
Twincam Touring Models	'06	<b>133-1006</b>
Twincam Touring Models	'07	<b>133-1009</b>
Twincam Touring Models	'08	<b>133-1014</b>
Twincam Touring Models	'09-13	<b>133-1015</b>

Application	Years	WPS #
Softail & Dyna Models	'01-05	<b>133-1004</b>
Softail Models	'06	<b>133-1007</b>
Dyna Models	'06	<b>133-1008</b>
Softail Models	'07-11	<b>133-1010</b>
Dyna Models	'07-11	<b>133-1011</b>
Sportster 883	'07-13	<b>133-1012</b>
Sportster 1200	'07-13	<b>133-1013</b>
V-Rod Models	'02-14	<b>133-1005</b>

- WINDSHIELDS / FAIRINGS
- AUDIO / COMMUNICATION
- SEATS / LUGGAGE
- BAR / MIRRORS / CONTROLS
- EXHAUST
- AIR / FUEL SYSTEMS**
- ENGINE
- TRANSMISSION / DRIVELINE
- GASKETS / SEALS
- ELECTRICAL
- LIGHTING
- CABLES
- BRAKES
- OIL FILTERS
- SUSPENSION
- BODY
- WHEELS
- TIRES / TIRE ACC.
- BIKE ACC.
- VICTORY / INDIAN
- COVERS / LOCKS / TIEDOWNS
- CHEMICALS
- TOOLS
- HELMETS
- HELMET ACC.
- EYEWEAR
- APPAREL / RIDER ACC.
- PROMOTIONAL
- REFERENCE
- INDEX



FLASH TUNER



The Power Vision incorporates a very sophisticated, yet simple touch screen display that DOES NOT require the use of a computer to flash your bike or to use Auto Tune! Simply select the tune, follow the on-screen prompts to download the tune, and if you'd like, edit your tune without ever touching a computer! That's right, you can flash and make changes to your tune without ever getting off your bike.

Power Vision downloads and stores the stock calibration, and lets you select up to 8 different tunes that are stored on the device, and can be flashed to your bike. The types of tunes include:

- Dynojet Preconfigured Tunes - Tunes for YOUR bike pre-loaded on the device... ready to go, right out of the box! Power Vision identifies your bike's information and automatically sorts hundreds of applicable dyno proven tunes for you to choose from.
- Custom Tunes – loaded by a custom tuning shop, or received via email and loaded on the device.
- Copy of Original or Copy of Current - a version of the Original calibration that was saved when the Power Vision was married to the ECM. Or a version of the Current calibration that is currently saved in the ECM.

Power Vision provides insightful, valuable information on how your bike is running:

- Display all J1850 and CAN H-D vehicle data as well as wide band air/fuel ratio1 and various channels (such as MPG instant and trip MPG)
- AutoTune2 Basic and Pro– AutoTune is built into the Power Vision so you can modify your tune as you ride without using a computer
- Check and clear diagnostic codes
- Reset adaptive fuel trims and idle offset (with bike running)
- **Not legal for sale in California, check local laws before installation.**



133-4051



133-4052



133-4050



133-4071

Application	Description	WPS#
'02-13 Touring, '01-10 Softail, '04-11 Dyna, '07-13 XL Models	Power Vision J1850 Chrome	<b>133-4050</b>
	Power Vision J1850 Black	<b>133-4051</b>
'14-16 Touring and XL, '11-17 Softail, '12-17 Dyna Models	Power Vision CAN-BUS Chrome	<b>133-4052</b>
	Power Vision CAN-BUS Black	<b>133-4053</b>
<b>ACCESSORIES</b>		
'02-13 Touring, '01-10 Softail, '04-11 Dyna, '07-13 XL Models	Autotune for Powervision J1850	<b>133-4054</b>
	Autotune for Powervision J1850 w/Bungs	<b>133-4055</b>
'11-17 Softail and '12-17 Dyna Models	Target Tune CAN-BUS	<b>133-4071</b>
'14-16 Touring Models	Target Tune CAN-BUS	<b>133-4072</b>
	Replacement Wide Band Sensor	<b>133-4060</b>
	Power Vision Claw Black	<b>133-4061</b>
	Power Vision Claw Chrome	<b>133-4062</b>
	Y-Adapter 4-Pin J1850	<b>133-4063</b>
	Y-Adapter 6-Pin CAN-BUS	<b>133-4064</b>
	CAN Link Cable	<b>133-4065</b>
	Power Vision to Diag Plug J1850	<b>133-4066</b>
	Power Vision to Diag Plug CAN-BUS	<b>133-4067</b>
	Adapter for Autotune 6-Pin to 4-Pin	<b>133-4068</b>
	Adapter for Autotune 4-Pin to 6-Pin	<b>133-4069</b>
	Techmount for Power Vision	<b>133-4070</b>



**SHOP TUNER KIT**



**Power Vision Shop Tuner Kit includes the following items:**

- Power Vision Unit with cables for J1850 and CAN-BUS
- Autotune Pro module with two wide band O2 sensors
- All necessary cables

Description	WPS#
Power Vision Shop Tuner Kit	133-4056



Not legal for use in California on pollution controlled vehicles - Check local laws before installing



**Power Tuner Cable Kit includes:**

- J1850 and CAN-BUS cables
- All necessary cables to use a Power Vision and Autotune

Description	WPS#
Power Tuner Cable Kit	133-4057



**Stealth Extraction Kit Case includes:**

- Rivet nut tool, rivet nuts
- Manifold for Dynojet dyno Air/Fuel system hose
- M10 drill bit, nuts and washers

Description	WPS#
Stealth Extraction Kit	133-4058

- WINDSHIELDS / FAIRINGS
- AUDIO / COMMUNICATION
- SEATS / LUGGAGE
- BAR / MIRRORS / CONTROLS
- EXHAUST
- AIR / FUEL SYSTEMS**
- ENGINE
- TRANSMISSION / DRIVELINE
- GASKETS / SEALS
- ELECTRICAL
- LIGHTING
- CABLES
- BRAKES
- OIL FILTERS
- SUSPENSION
- BODY
- WHEELS
- TIRES / TIRE ACC.
- BIKE ACC.
- VICTORY / INDIAN
- COVERS / LOCKS / TIEDOWNS
- CHEMICALS
- TOOLS
- HELMETS
- HELMET ACC.
- EYEWEAR
- APPAREL / RIDER ACC.
- PROMOTIONAL
- REFERENCE
- INDEX



## USB INTERFACE

Provides USB connectivity for custom mapping. Includes 6 foot USB cable and Windows XP/Vista/7 drivers on CDROM.

Allows for editing of various tables and parameters. 3D tables are used for front and rear cylinder fuel trim. 3D fuel trim tables are accompanied by chart displays that help visualize the data.

**WPS #**

**132-7060**



## BLUETOOTH INTERFACE

- Provides wireless connectivity for TCFI/VRFI series engine controls
- Requires laptop PC with Bluetooth capability
- Windows 7 recommended
- Required when using TwinView application on Android tablets
- **Not legal for sale or use on pollution controlled vehicles**
- **Not for sale in California**

**WPS#**

**132-7057**



## O2 SENSORS

- Cycle Pro Oxygen Sensors are precision made for outstanding performance and manufactured to meet and exceed all OEM specifications
- Direct Fit, No Modifications Needed
- Extra High temperature Dual Shield End
- Improved Engine Performance
- USA Made



Description	Application	WPS#
A Replaces OEM 27719-07	'07-09 FLT,'08-16 XL,'09 TRIKE	<b>865-01000</b>
B Replaces OEM 27683-07	'07-11 Softail/Dyna	<b>865-01001</b>
C Replaces OEM 27703-08	'09-11 VRod	<b>865-01002</b>
D Replaces OEM 27729-10	'10-17 FLT Rear	<b>865-01003</b>
E Replaces OEM 27703-08	'10-16 FLT Front	<b>865-01004</b>
F Replaces OEM 32700005	'12-17 Softail Front	<b>865-01005</b>
Replaces OEM 32700006	'12-17 Softail/Dyna,'17 XL Rear	<b>865-01006</b>
G Replaces OEM 32700026	'17 XL Front	<b>865-01007</b>
H Replaces OEM 27690-08		<b>865-01008</b>

## HardDrive FUEL INJECTOR

AMERICAN V-TWIN PRODUCTS

- Upgraded version of the OEM fuel injector for '06-Up 96" and 103" Twin Cams (except FLH/FLT '08-16, '16-Up Softails)
- 25 Degree spray angle with 6 spray holes
- Replaces OEM# 27709-06A
- Sold each



Description	WPS#
Fuel Injector '06-16 Big Twin except Touring	<b>820-57200</b>



# FUEL INJECTORS

- Ten different flow rates with part numbers for 2001 and later models
- Made in the USA using the latest injector technology
- Sold in matched sets (two injectors)
- Detailed test report included with each set
- **Not for use in California**



Flow Rating (lb. per hour)	Flow rating (gr/sec) @58 psi	Application	WPS#	Flow Rating (lb. per hour)	Flow rating (gr/sec) @58 psi	Application	WPS#
35.71	4.6	'01-05 F/I Twin Cam models	<b>132-7083</b>	42.86	5.4	'08-16 Touring models	<b>132-7091</b>
42.86	5.4	'01-05 F/I Twin Cam models	<b>132-7084</b>	49.21	6.2	'08-16 Touring models	<b>132-7092</b>
49.21	6.2	'01-05 F/I Twin Cam models	<b>132-7085</b>	56.35	7.1	'08-16 Touring models	<b>132-7093</b>
56.35	7.1	'01-05 F/I Twin Cam models	<b>132-7086</b>	61.91	7.8	'08-16 Touring models	<b>132-7094</b>
30.95	3.9	'06-17 Twin Cam models (except '08-16 Touring models)	<b>132-7087</b>	42.7	5.38	'17-Up M8 motors	<b>132-7095</b>
42.86	5.4	'06-17 Twin Cam models (except '08-16 Touring models)	<b>132-7088</b>	49.52	6.24	'17-Up M8 motors	<b>132-7096</b>
49.21	6.2	'06-17 Twin Cam models (except '08-16 Touring models)	<b>132-7089</b>	56.19	7.08	'17-Up M8 motors	<b>132-7097</b>
56.35	7.1	'06-17 Twin Cam models (except '08-16 Touring models)	<b>132-7090</b>	61.83	7.79	'17-Up M8 motors	<b>132-7098</b>
				67.38	8.49	'17-Up M8 motors	<b>132-7099</b>
				73.18	9.22	'17-Up M8 motors	<b>132-7100</b>
				78.56	9.90	'17-Up M8 motors	<b>132-7101</b>
				84.29	10.62	'17-Up M8 motors	<b>132-7102</b>



# FUEL INJECTOR CLEANERS

- Easily cleans most fuel injectors
- Will flush and back flush injectors for best possible cleaning process
- No compressed air required
- Requires aerosol can of fuel injection cleaner (not included)
- Push button switch to turn fuel injector on with LED indicator light
- Durable anodized billet aluminum construction
- Built tough for everyday shop use
- 9 volt battery included
- Replacement pigtails available
- Patent pending



KITS	WPS#
EV1 Late Model H-D	<b>57-8594</b>
EV6 Older Model H-D	<b>57-8595</b>
PIGTAILS	
A EV1 Late Model H-D	<b>57-8598</b>
B EV6 Older Model H-D	<b>57-8599</b>

- WINDSHIELDS / FAIRINGS
- AUDIO / COMMUNICATION
- SEATS / LUGGAGE
- BARS / MIRRORS / CONTROLS
- EXHAUST
- AIR / FUEL SYSTEMS**
- ENGINE
- TRANSMISSION / DRIVELINE
- GASKETS / SEALS
- ELECTRICAL
- LIGHTING
- CABLES
- BRAKES
- OIL FILTERS
- SUSPENSION
- BODY
- WHEELS
- TIRES / TIRE ACC.
- BIKE ACC.
- VICTORY / INDIAN
- COVERS / LOCKS / TIEDOWNS
- CHEMICALS
- TOOLS
- HELMETS
- HELMET ACC.
- EYEWEAR
- APPAREL / RIDER ACC.
- PROMOTIONAL
- REFERENCE
- INDEX



## 42/45 HSR CARBURETOR EASY KITS FOR EVO SPORTSTER, EVO BIG TWIN AND TWIN CAM ENGINES

- Keep your stock look with our uniquely designed Easy Kit
- Uses the stock manifold and cables
- Our special adapter retains your stock airbox or use the Screamin' Eagle performance air filter kit
- Kits are not legal for use on pollution controlled vehicles, check local laws before installation

Description	Model	Year	Mikuni#	WPS#
<b>BIG TWIN EASY KITS</b>				
42mm HSR Carburetor w/ airbox adapter	Twin Cam 88	'99-06	42-18	<b>14-2016</b> #
45mm HSR Carburetor w/ airbox adapter	Twin Cam 88	'99-06	45-5	<b>14-2023</b> *
42mm HSR Carburetor w/ airbox adapter and chrome cover	EVO models	'90-99	42-7	<b>14-2015</b>
42mm HSR Carburetor w/ airbox adapter	EVO models	'90-99	42-18	<b>14-2016</b> #
45mm HSR Carburetor w/ airbox adapter	EVO models	'90-99	45-5	<b>14-2023</b> *
<b>SPORTSTER EASY KITS</b>				
42mm HSR Carburetor	XL1200 models	'94-06	42-11	<b>14-2018</b> ‡
42mm HSR Carburetor w/ airbox adapter	XL1200 models	'94-06	42-10	<b>14-2017</b> †

# Will not work with stock air box      † Requires the use of the stock oval cover and a SE high flow air cleaner  
 \* Must use HD Screaming Eagle manifold kit      ‡ Must use with aftermarket performance air filter



## HSR 45/42 TOTAL CARBURETOR KITS FOR BIG TWIN EVO AND TWIN CAM MODELS

- Go for high flow!
- Total Kits allow fitment of HSR42 or 45mm carburetor to any Big Twin EVO or Twin Cam model
- Our high flow filter supports 100 horsepower with no loss from filter restriction

Description	Model	Year	Mikuni#	WPS#
<b>BIG TWIN TOTAL KITS</b>				
42mm HSR Carburetor	Twin Cam	'99-06	42-19	<b>14-2019</b>
45mm HSR Carburetor w/ intake manifold	Twin Cam	'99-06	45-4	<b>14-2022</b>
45mm HSR Carburetor w/ intake manifold	EVO models	'84-99	45-2	<b>14-2020</b>
45mm HSR Carburetor w/o intake manifold	EVO models	'84-99	45-3	<b>14-2021</b>
42mm HSR Carburetor	EVO models	'84-99	42-8	<b>14-2008</b> *

\* Includes breather kit for '93-99 models, '84-89 models require cables from '90-95 models



- Total Kit includes:**
- A special manifold
  - Rubber flange
  - High flow air filter
  - (Manifold clamps and seals are not included in kit).

## SMOOTHBORE CARBURETORS FOR CUSTOM INSTALLATIONS

- 45mm carb for use on modified engines requiring the maximum in carburetion (Manifolds not included)
- 42mm carb for use in custom applications on many different types of engines (Now uses OEM Harley cables)

Application	Description	WPS#
48-2	48mm smoothbore Carb	<b>14-2037</b>
48-2P	48mm smoothbore Polished	<b>14-2038</b>
TM45-1	45mm smoothbore Carb	<b>14-1989</b>
TM45-2pk	45mm smoothbore Polished	<b>14-1992</b>
TM42-1	42mm smoothbore Carb	<b>14-1988</b>
TM42-6pk	42mm smoothbore Polished	<b>14-1991</b>

### OPTIONAL AND REPLACEMENT PARTS

HS-40	Rebuild Kit HSR40	<b>14-1996</b>
HS-40	Air Filter	<b>14-1998</b>
HSR-42	Air Filter	<b>14-1980</b>
HSR-42	Chrome Cover	<b>14-1981</b>
HSR-42	Push Cable (throttle)	<b>14-1983</b>
HSR-42	Optional Breather Kit	<b>14-1999</b>
HSR-42	Air Box Adapter Kit, Chrome	<b>14-2011</b>
HSR-42	Air Box Adapter Kit, Standard Finish	<b>14-2012</b>
HSR-42	Adapter Screws	<b>14-2013</b>
HSR-42	O-Ring Seal for Air box Adapter	<b>14-2024</b>
HSR-42	High Performance Air Filter (3")	<b>14-2025</b>
HSR-42 (early)	Rubber Flange Adapter for '84-99 EVO	<b>14-1984</b>

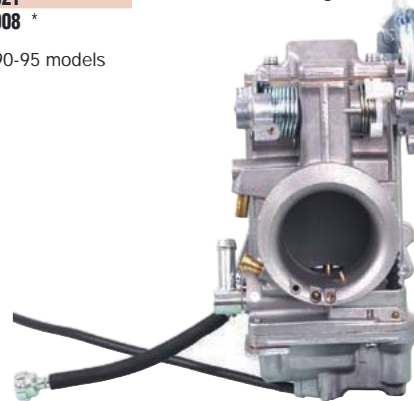

Application	Description	WPS#
HSR-42	Rubber Flange Adapter '99-06 Twin Cam	<b>14-2028</b>
HSR-45 (early)	Rubber Flange Adapter for '84-99 EVO	<b>14-1985</b>
HSR-45	Rubber Flange Adapter '99-06 Twin Cam	<b>14-2029</b>
HSR-48	Rubber Mounting Flange	<b>14-1986</b>
HSR-42/45	Rebuild Kit HSR42/45	<b>14-1997</b>
HSR-42/45	Intake Manifold EVO style w/out hole	<b>14-2026</b>
HSR-42/45	Intake Manifold Twin Cam style w/ MAPS hole	<b>14-2027</b>
HSR-42/45/48	Idle Screw Adjuster (short)	<b>14-2009</b>
HSR-42/45/48	Choke Cable Assembly	<b>14-2010</b>
HSR-42/45/48	Long Idle Cable Adjuster Screw	<b>14-2030</b>
HSR-42/45/48	Float Bowl O-ring	<b>14-2508</b>
HSR-42/45/48	Float	<b>14-2509</b>
HSR-42/45/48	Float Bowl short screw	<b>14-2512</b>
HSR-42/45/48	Float Pin	<b>14-04622</b>
HSR-42/45/48	Float Pin Screw	<b>14-2512</b>



### THUNDERSLIDE KIT

These kits incorporate a custom made slide. The unique configuration allows precise control over the slide's range of movement and creates a stronger signal, which improves fuel atomization. This provides more power, increased throttle response and improved fuel economy.

Not legal for sale in California, check local laws before installation.

Application	WPS#	Application	WPS#
'90-00 Evo 1340 Stage 1	<b>133-4010</b>	1999 Twin Cam 88 Stage 7	<b>133-4015</b>
'90-00 Evo 1340 Stage 7	<b>133-4011</b>	'00-06 Twin Cam 88 Stage 1	<b>133-4016</b>
'89-03 XL1200	<b>133-4012</b>	'00-06 Twin Cam 88 Stage 7	<b>133-4017</b>
'04-06 XL 1200C/R	<b>133-4013</b>	All 1340 Evo Models with 44mm Keihin Carb	<b>133-4018</b>
1999 Twin Cam 88 Stage 1	<b>133-4014</b>	All Twin Cam 88 Models with 44mm Keihin Carb	<b>133-4019</b>



### DYNOJET JET KIT

Dynojet Jet Kits increase power and smoothness throughout the entire rev range, while maintaining optimum fuel economy. Each Dynojet Jet Kit includes comprehensive instructions which show step-by-step installation and testing procedures to ensure a perfect setup every time.

Not legal for sale in California, check local laws before installation.

Application	WPS#
'88-89 XL 883/1200 Models (no accelerator pump)	<b>133-4000</b>
'89-95 XL and Big Twin Models	<b>133-4001</b>
'96-03 XL and '96-00 Evo Models	<b>133-4002</b>
'04-06 XL 883/C	<b>133-4003</b>
'04-06 XL 1200C/R	<b>133-4004</b>
'99-06 Twin Cam 88	<b>133-4005</b>



### CARBURETOR TOP COVER

- Chrome finish
- Replaces OEM# 27040-88



Description	Application	WPS#
A Plain design top cover for CV carbs	'88-90 XL and '90-Up Big Twin models	<b>820-2681</b>
B Louvered design top cover for CV carbs	'88-90 XL and '90-Up Big Twin models	<b>820-2682</b>



### CARB TOP COVER SET

- Polished chrome plated
- Made in the USA



Description	WPS#
Keihin carburetor constant velocity top cover fasteners	<b>830-1024</b>

- WINDSHIELDS / FAIRINGS
- AUDIO / COMMUNICATION
- SEATS / LUGGAGE
- BAR / MIRRORS / CONTROLS
- EXHAUST
- AIR / FUEL SYSTEMS**
- ENGINE
- TRANSMISSION / DRIVELINE
- GASKETS / SEALS
- ELECTRICAL
- LIGHTING
- CABLES
- BRAKES
- OIL FILTERS
- SUSPENSION
- BODY
- WHEELS
- TIRES / TIRE ACC.
- BIKE ACC.
- VICTORY / INDIAN
- COVERS / LOCKS / TIEDOWNS
- CHEMICALS
- TOOLS
- HELMETS
- HELMET ACC.
- EYEWEAR
- APPAREL / RIDER ACC.
- PROMOTIONAL
- REFERENCE
- INDEX

# EBC

All EBC jets on this page that begin with a three digit prefix are now sold in a 2 or 4 pack.

## PILOT JETS

SOLD 4/PK



Used in Mikuni HSR series carburetors, Mikuni # VM28/486

WPS#	Jet Size	WPS#	Jet Size
114-0010	10	114-00425	42.5
114-00125	12.5	114-0045	45
114-0015	15	114-00475	47.5
114-00175	17.5	114-0050	50
114-0020	20	114-00525	52.5
114-00225	22.5	114-0055	55
114-0025	25	114-00575	57.5
114-00275	27.5	114-0060	60
114-0030	30	114-00625	62.5
114-00325	32.5	114-0065	65
114-0035	35	114-00675	67.5
114-00375	37.5	114-0070	70
114-0040	40		

## OE STYLE PILOT JETS

SOLD 4/PK

Fits Harley D Keihin BH Carbs

WPS#	Jet Size
124-2535	35
124-2538	38
124-2540	40
124-2542	42
124-2545	45
124-2548	48
124-2550	50
124-2552	52
124-2555	55
124-2558	58
124-2560	60
124-2562	62
124-2565	65

## LARGE ROUND MAIN JETS

SOLD 4/PK

Fits Mikuni HSR series Carburetors.



WPS#	Jet Size	WPS#	Jet Size	WPS#	Jet Size
114-70725	72.5	114-7120	120		
114-7075	75	114-71225	122.5		
114-70775	77.5	114-7125	125		
114-7080	80	114-71275	127.5		
114-70825	82.5	114-7130	130		
114-7085	85	114-71325	132.5		
114-70875	87.5	114-7135	135		
114-7090	90	114-71375	137.5		
114-70925	92.5	114-7140	140		
114-7095	95	114-71425	142.5		
114-70975	97.5	114-7145	145		
114-7100	100	114-71475	147.5		
114-71025	102.5	114-7150	150		
114-7105	105	114-71525	152.5		
114-71075	107.5	114-7155	155		
114-7110	110	114-71575	157.5		
114-71125	112.5	114-7160	160		
114-7115	115	114-7170	170		
114-71175	117.5				

## OE STYLE MAIN JETS

SOLD 4/PK

Fits Keihin CV carburetors



WPS#	Jet Size
124-27165	165
124-27170	170
124-27175	175
124-27180	180
124-27185	185
124-27190	190
124-27195	195
124-27200	200
124-27205	205

## OE STYLE MAIN JET KIT

Includes 2 each of sizes 165-205

Description	WPS#
Slot Head Round Main Jet Kit	124-12KIT



## PILOT JETS

SOLD 4/pk



Used in Mikuni RS and HS carburetors. Mikuni No. VM28/486.

WPS #	Jet Size	WPS #	Jet Size
134-0015	15	134-0045	45
134-00175	17.5	134-0050	50
134-0020	20	134-00525	52.5
134-00225	22.5	134-0055	55
134-0025	25	134-0060	60
134-00275	27.5	134-00625	62.5
134-0030	30	134-0065	65
134-0035	35	134-0070	70
134-0040	40		

## LARGE ROUND MAIN JETS

SOLD 4/pk



WPS#	Size	WPS#	Size	WPS#	Size
134-7060	60	134-71125	112.5	134-7155	155
134-7065	65	134-7115	115	134-71575	157.5
134-70675	67.5	134-71175	117.5	134-7160	160
134-70725	72.5	134-7120	120	134-71625	162.5
134-7075	75	134-71225	122.5	134-7165	165
134-7080	80	134-7125	125	134-71675	167.5
134-7085	85	134-71275	127.5	134-7170	170
134-70875	87.5	134-7130	130	134-71725	172.5
134-7090	90	134-71325	132.5	134-7175	175
134-70925	92.5	134-7135	135	134-71775	177.5
134-7095	95	134-71375	137.5	134-7180	180
134-70975	97.5	134-7140	140	134-71825	182.5
134-7100	100	134-71425	142.5	134-7185	185
134-71025	102.5	134-7145	145	134-71875	187.5
134-7105	105	134-71475	147.5	134-7190	190
134-71075	107.5	134-7150	150	134-71925	192.5
134-7110	110	134-71525	152.5	134-7195	195
				134-7200	200

Description	Leaner	Standard	Richer	Richest
Jet Needle for HSR42	14-2507	14-2506	14-2505	14-2504
Jet Needle for HSR45	14-2503	14-2502	14-2501	14-2500





All jets are made of brass optimizing high precision and flow calibrated for extremely accurate fuel flow rate

### KEIHIN CV CARB PILOT JETS

SOLD 5/pk

WPS#	Size	
865-01160	40	Lean
865-01161	42	
865-01162	44	
865-01163	45	
865-01164	46	
865-01165	48	
865-01166	50	
865-01167	52	
865-01168	54	Rich
865-01169	55	



### KEIHIN BH CARB MAIN JETS

SOLD 5/pk

WPS#	Size
865-01150	165
865-01151	170
865-01152	175
865-01153	180



### S & S SLOW JETS

SOLD 5/pk

WPS#	Size	
865-01133	.025	Lean
865-01134	.026	
865-01135	.028	
865-01136	.029	
865-01137	.031	
865-01138	.032	
865-01139	.033	
865-01140	.036	
865-01141	.040	

### S & S MAIN JETS

SOLD 5/pk

WPS#	Size		WPS#	Size		WPS#	Size	
865-01100	.040	Lean	865-01112	.064	Lean	865-01123	.086	Lean
865-01101	.042		865-01113	.066		865-01124	.088	
865-01102	.044		865-01114	.068		865-01125	.090	
865-01103	.046		865-01115	.070		865-01126	.092	
865-01104	.048		865-01116	.072		865-01127	.094	
865-01105	.050		865-01117	.074		865-01128	.096	
865-01106	.052		865-01118	.076		865-01129	.098	
865-01107	.054		865-01119	.078		865-01130	.100	
865-01108	.056	865-01120	.080	865-01131	.102	Rich		
865-01109	.058	865-01121	.082	865-01132	.104			
865-01110	.060	Rich	865-01122	.084				
865-01111	.062							



### PRO JET ASSORTMENTS

- All jets are made of brass optimizing high precision and flow calibrated for extremely accurate fuel flow rate
- One of the most comprehensive jet kits on the market
- Kit packaged in plastic tray with part reference for easy identification for re-ordering

Description	WPS#
CV Main Jet Assortment, 5 of Each Size, 14 Sizes	865-01050
CV Slow Jet Assortment, 5 of Each Size, 10 Sizes	865-01051
Master Jet Kit CV Carb, 2 of Each Size, 23 Sizes	865-01053
Master Jet Kit Butterfly Carb, 2 of Each Size, 20 Sizes	865-01054
Master Jet Kit S&S Carbs, 2 of each Size, 42 Sizes	865-01052

- WINDSHIELDS / FAIRINGS
- AUDIO / COMMUNICATION
- SEATS / LUGGAGE
- BARS / MIRRORS / CONTROLS
- EXHAUST
- AIR / FUEL SYSTEMS
- ENGINE
- TRANSMISSION / DRIVELINE
- GASKETS / SEALS
- ELECTRICAL
- LIGHTING
- CABLES
- BRAKES
- OIL FILTERS
- SUSPENSION
- BODY
- WHEELS
- TIRES / TIRE ACC.
- BIKE ACC.
- VICTORY / INDIAN
- COVERS / LOCKS / TIEDOWNS
- CHEMICALS
- TOOLS
- HELMETS
- HELMET ACC.
- EYEWEAR
- APPAREL / RIDER ACC.
- PROMOTIONAL
- REFERENCE
- INDEX



All jets are made of brass optimizing high precision and flow calibrated for extremely accurate fuel flow rate

### CV CARB RECALIBRATION KIT

- Main Jet Assortment for precision tuning #150, #160, #170, #180 and #190
- Cures throttle flat spots, backfiring, and poor throttle response
- Comes complete with instructions

Application	Description	WPS#
A	All Keihin CV Carbs Tuner Kit	<b>865-01010</b>
B	Tuner Kit w/Gaskets	<b>865-01011</b>
	Tuner Kit Jets 5 packs	#1.40 <b>865-01012</b>
		#1.45 <b>865-01013</b>
		#1.50 <b>865-01014</b>
		#1.55 <b>865-01015</b>
		#1.60 <b>865-01016</b>
		#1.65 <b>865-01017</b>
		#1.70 <b>865-01018</b>
		#1.75 <b>865-01019</b>
		#1.80 <b>865-01020</b>
		#1.85 <b>865-01021</b>
		#1.90 <b>865-01022</b>
		#1.95 <b>865-01023</b>
		#2.00 <b>865-01024</b>
		#2.05 <b>865-01025</b>

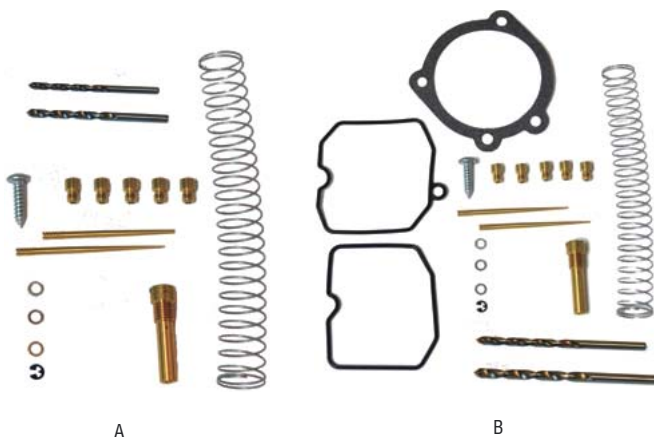

### EZ TUNER KITS

- Direct fit, no drilling needed
- Made of high quality brass components, NOT aluminum
- Improved engine performance
- EZ install
- Kits include Cycle Pro flow jets
- Detailed instructions for jetting your motor from stock to modified
- Components made in the USA



Description	Application	WPS#
A EZ Tuner Kit	'88-03 XL 1200 Models	<b>865-01060</b>
B	'04-06 XL Models	<b>865-01061</b>

Description	Application	WPS#
C	'95-99 Evo Big Twins	<b>865-01062</b>
	'99-06 Twin Cam 88	<b>865-01063</b>
	'97-02 XL 1200S, Buell 1200	<b>865-01064</b>
	'88-03 XL 883, Buell Blast	<b>865-01065</b>
	'89-94 Evo Big Twins	<b>865-01066</b>

# PRO CARB REBUILD KITS

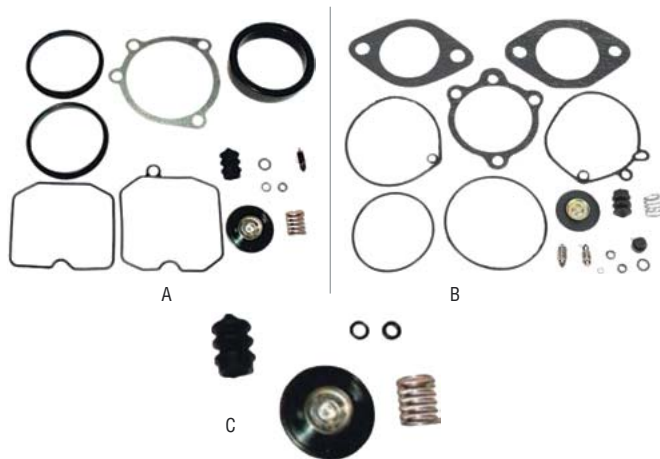

- Complete kit to rebuild Keihin style carburetors.
- Kit includes gaskets, float needle, all carburetor o-rings and Manifold seals.
- This is the most complete kit in the industry. Gaskets are made in the USA.

Application	Description	WPS#
A All Keihin CV Carbs '90-Up	Rebuild Kit	<b>865-01036</b>
B All Keihin CV Carbs '76-89	Rebuild Kit	<b>865-01035</b>
C All Keihin CV Carbs	Accelerator Pump Rebuild Kit	<b>865-01037</b>

## PRO CARB REBUILD KITS

- Various hard to find replacement parts for Keihin carbs
- Quality reproductions of the original parts found on stock carbs



Application	Description	WPS#
A All Keihin CV Carbs	Accelerator Pump Upgrade Kit	<b>865-01030</b>
B	Emulsion Tube MKJ4 Nozzle	<b>865-01031</b>
C	Slide Assembly	<b>865-01032</b>
D	Mixture Screw	<b>865-01034</b>
E	Idle Mix Needle Repack Kit	<b>865-01038</b>
F	Carb Diaphragm (10pk)	<b>865-01039</b>
G	Float Valve (10pk) OE 27337-76	<b>865-01040</b>
H	Float Valve (10pk) OE 27886-78	<b>865-01041</b>
I	Rubber Boot Accelerator Pump	<b>865-01042</b>
J Butterfly Carbs	Mixture Screw	<b>865-01033</b>



## IDLE MIXTURE SCREWS

Mixture screw and repack kit for Keihin CV carbs.



Description	Application	WPS#
A Mixture Screw	Keihin CV Carbs	<b>820-50541</b>
B Air/Idle Mix Repack Kit		<b>820-50542</b>

## CHOKE CABLE CAP

Choke cable cap for Keihin CV carbs, replaces OEM 27581-88.



Description	Application	WPS#
Choke Cable Cap	All Keihin CV Carbs	<b>820-50921</b>

- WINDSHIELDS / FAIRINGS
- AUDIO / COMMUNICATION
- SEATS / LUGGAGE
- BAR / MIRRORS / CONTROLS
- EXHAUST
- AIR / FUEL SYSTEMS
- ENGINE
- TRANSMISSION / DRIVELINE
- GASKETS / SEALS
- ELECTRICAL
- LIGHTING
- CABLES
- BRAKES
- OIL FILTERS
- SUSPENSION
- BODY
- WHEELS
- TIRES / TIRE ACC.
- BIKE ACC.
- VICTORY / INDIAN
- COVERS / LOCKS / TIEDOWNS
- CHEMICALS
- TOOLS
- HELMETS
- HELMET ACC.
- EYEWEAR
- APPAREL / RIDER ACC.
- PROMOTIONAL
- REFERENCE
- INDEX



## CARB REBUILD KITS

Quality carb rebuild kits from James Gaskets include all essential parts needed to rebuild Keihin, Bendix and Linkert carburetors.



A



B



C



D

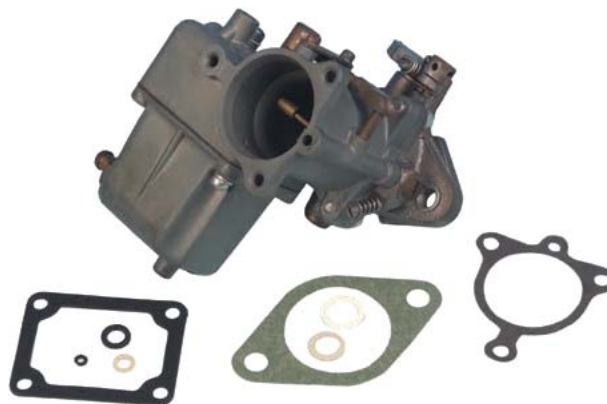

E

Application	WPS#
A All Keihin CV Carbs '90-Up	<b>681-4423</b>
B All Keihin CV Carbs '76-89	<b>681-4777</b>
C All Bendix Carbs '72-76	<b>681-5509</b>
D All Linkert Carbs '36-65	<b>681-5167</b>
E All Linkert DC Carbs '57-66	<b>681-5168</b>

- WINDSHIELDS / FAIRINGS
- AUDIO / COMMUNICATION
- SEATS / LUGGAGE
- BAR / MIRRORS / CONTROLS
- EXHAUST
- AIR / FUEL SYSTEMS
- ENGINE
- TRANSMISSION / DRIVELINE
- GASKETS / SEALS
- ELECTRICAL
- LIGHTING
- CABLES
- BRAKES
- OIL FILTERS
- SUSPENSION
- BODY
- WHEELS
- TIRES / TIRE ACC.
- BIKE ACC.
- VICTORY / INDIAN
- COVERS / LOCKS / TIEDOWNS
- CHEMICALS
- TOOLS
- HELMETS
- HELMET ACC.
- EYEWEAR
- APPAREL / RIDER ACC.
- PROMOTIONAL
- REFERENCE
- INDEX



### MANIFOLD FLANGE ADAPTER

- Precision machined from billet aluminum
- Converts old two bolt flange style manifolds to accept Mikuni HSR and late Keihin CV carbs

Description	Application	WPS#
40mm Manifold Flange Adapter	Flange Type to CV & Mikuni HSR	820-50526



### INTAKE MANIFOLD COVER

- Chrome steel
- Comes with gasket and washers
- OEM replacement

Application	WPS#
'02-Up Touring, '01-Up Softail, and '04-Up Dyna models	820-2634



### INTAKE MANIFOLD MOUNTING FLANGE

- OEM replacement

Description	Application	WPS#
A Front intake manifold mounting flange	'86-Up XL and '90-Up Big Twin models	820-2694
B Rear intake manifold mounting flange	'86-Up XL and '90-Up Big Twin models	820-2695
Manifold Flange Set	'86-Up XL and '90-Up Big Twin models	820-50532
Billet Flange Set for Oversize EFI Throttle Bodies	'07-Up Softail and Dyna	820-50533

### INTAKE CLAMP SET

- Sold in pairs
- O-rings and or seals supplied as pictured
- OEM replacement



Description	Application	WPS#
A Stainless Steel Aircraft style	'55-E78 Panhead, Shovelhead and XL models	820-2693
B Brass	'55-E78 Panhead, Shovelhead and XL models	820-2687
C Chrome	'55-E78 Panhead, Shovelhead and XL models	820-2686
D Stainless Steel Aircraft style	'L78-85 Shovelhead and XL models	820-2692
E Brass	'L78-85 Shovelhead and XL models	820-2688
F Chrome	'L78-85 Shovelhead and XL models	820-2685



C

D

E

F

- WINDSHIELDS / FAIRINGS
- AUDIO / COMMUNICATION
- SEATS / LUGGAGE
- BAR / MIRRORS / CONTROLS
- EXHAUST
- AIR / FUEL SYSTEMS**
- ENGINE
- TRANSMISSION / DRIVELINE
- GASKETS / SEALS
- ELECTRICAL
- LIGHTING
- CABLES
- BRAKES
- OIL FILTERS
- SUSPENSION
- BODY
- WHEELS
- TIRES / TIRE ACC.
- BIKE ACC.
- VICTORY / INDIAN
- COVERS / LOCKS / TIEDOWNS
- CHEMICALS
- TOOLS
- HELMETS
- HELMET ACC.
- EYEWEAR
- APPAREL / RIDER ACC.
- PROMOTIONAL
- REFERENCE
- INDEX

- WINDSHIELDS / FAIRINGS
- AUDIO / COMMUNICATION
- SEATS / LUGGAGE
- BAR / MIRRORS / CONTROLS
- EXHAUST
- AIR / FUEL SYSTEMS
- ENGINE
- TRANSMISSION / DRIVELINE
- GASKETS / SEALS
- ELECTRICAL
- LIGHTING
- CABLES
- BRAKES
- OIL FILTERS
- SUSPENSION
- BODY
- WHEELS
- TIRES / TIRE ACC.
- BIKE ACC.
- VICTORY / INDIAN
- COVERS / LOCKS / TIEDOWNS
- CHEMICALS
- TOOLS
- HELMETS
- HELMET ACC.
- EYEWEAR
- APPAREL / RIDER ACC.
- PROMOTIONAL
- REFERENCE
- INDEX



## CARB FLOAT

- Meets or exceeds OEM Specifications

Description	Application	WPS#
Carb Float Repl. OEM 27576-92	Keihin 40mm CV Carbs	865-01043



## THROTTLE SLIDE MEMBRANE

These new membrane seals replace punctured or torn seals on throttle slides fitted to Keihin CV Carburetors, Fits all stock Keihin CV carburetors on 1988 to present Sportsters, 1990-1999 Big Twins & 1999 to 2006 Twin Cam models. Why buy a complete slide assembly when you can now replace the seal only in a cost effective manner, these seals are not available or sold separately from the OEM.



Description	Application	WPS#
Throttle Slide Vacuum Membrane	Keihin CV Carbs	820-50920

## INTAKE MANIFOLD GASKETS

Description	Application	WPS#
A Seal kit	'86-87 & '89-Up Sportsters	820-0001
B Seal kit - 2 intake manifold lower case seals & 1 carb seal	'86-Up all Evolution Big Twins & Sportsters, consists of 2 intake manifold lower case seals & 1 carb seal	820-0002
C Seal kit - 6 pcs	'75-85 Sportsters & Shovelhead	820-0003



## BREATHER HOSES

- Replacement for deteriorated OEM breather hoses
- Sold in pairs

Description	WPS#
Fits '93-99 Softails '93-98 Dyna and FLT '95-03 XL repl. OEM 24922-93	820-50570
Fits '00-12 Softails '99-07 Touring '01-07 Dyna repl. OEM 29476-99	820-50571
Fits '08-13 Touring repl. OEM 29502-08A	820-50572



## FUEL INLET



Fuel Inlet stock on '79-80 Big Twins and '76-80 Sportsters

Description	Application	WPS #
Fuel Inlet Fitting	76-06 Replaces OEM# 27594-76	820-50569





WPS#  
62-5100

### FUEL SHARING SYSTEM

- No tools required, no modifications or permanent attachments are needed to your bike
- Fits 2001 and newer fuel injected Harley-Davidson models
- Entire connection and disconnection takes only seconds, transfers fuel at roughly one quart every 20 seconds
- Will not stall engine while in use
- Small & compact size, stores anywhere, includes storage pouch



### CARBURETOR POCKET TUNER



WPS#  
13-2430

- Pocket size slide calculator
- Helps determine required jetting changes in carburetors due to temperature and altitude change
- For single & multiple carburetion on 2 & 4 stroke engines
- Comes with a guide for determining rich or lean conditions
- A must for riders and mechanics that demand maximum performance

### CARBURETOR PRODUCTS CATALOG

A complete guide to Mikuni carburetors, components, and accessories. 32 pages of photos, drawings, and technical descriptions of all Mikuni products.

WPS#  
13-9999



### CARBURETOR LEAK DETECTOR

Check needle & seat holding pressure, crankshaft seals, crankcase surfaces, & many other critical parts with this simple tool.



Description	WPS#
30 psi Mikuni	13-2767
100 psi Mikuni	13-2768



### MIKUNI CARB TOOL KIT

Handy kit includes all tools necessary to completely disassemble carb, change jets, etc.

WPS#  
12-1866

- WINDSHIELDS / FAIRINGS
- AUDIO / COMMUNICATION
- SEATS / LUGGAGE
- BARS / MIRRORS / CONTROLS
- EXHAUST
- AIR / FUEL SYSTEMS**
- ENGINE
- TRANSMISSION / DRIVELINE
- GASKETS / SEALS
- ELECTRICAL
- LIGHTING
- CABLES
- BRAKES
- OIL FILTERS
- SUSPENSION
- BODY
- WHEELS
- TIRES / TIRE ACC.
- BIKE ACC.
- VICTORY / INDIAN
- COVERS / LOCKS / TIEDOWNS
- CHEMICALS
- TOOLS
- HELMETS
- HELMET ACC.
- EYEWEAR
- APPAREL / RIDER ACC.
- PROMOTIONAL
- REFERENCE
- INDEX



## CHECK VALVE REBUILD KIT

- Eliminate the need for replacing expensive check valve and fuel line when only a rebuild is needed
- Fits 2001 and newer fuel injected Harley Davidson models
- Long lasting, high quality DuPont Viton O-rings, solid brass nickel plated check valve, stainless steel springs

**WPS#**

**62-5112**



## CHECK VALVE REPLACEMENT O-RINGS

- Sold each or in packs of 5
- Eliminate the need for replacing expensive check valve and fuel line when only an O-Ring is needed
- Fits 2001 and newer fuel injected Harley-Davidson models
- Long lasting, high quality DuPont Viton O-ring

**WPS**

**62-5110** each

**62-5111** 5 pack



## CHECK VALVE REBUILD TOOL

- Provides for fast and easy professional installation of check valve O-ring or rebuild kit without having to remove tank from the bike
- For 2001 and newer fuel injected Harley-Davidson models
- High quality, professional grade

**WPS**

**62-5101**



## FUEL PRESSURE GAUGE

- Provides for simple, fast and accurate fuel pressure checks, push button completely releases all fuel through the drain line
- Quickly diagnoses: Loss of power, poor fuel economy, hesitation & stalling
- Fits 2001 and newer fuel injected Harley-Davidson models
- Solid brass adapter and release valve, steel housing (100 psi) gauge, stainless steel springs, Viton O-Rings, O-Ring lubricant and nylon storage pouch

**WPS**

**62-5102**



WINDSHIELDS / FAIRINGS  
AUDIO / COMMUNICATION  
SEATS / LUGGAGE  
BARS / MIRRORS / CONTROLS  
EXHAUST  
AIR / FUEL SYSTEMS  
ENGINE  
TRANSMISSION / DRIVELINE  
GASKETS / SEALS  
ELECTRICAL  
LIGHTING  
CABLES  
BRAKES  
OIL FILTERS  
SUSPENSION  
BODY  
WHEELS  
TIRES / TIRE ACC.  
BIKE ACC.  
VICTORY / INDIAN  
COVERS / LOCKS / TIEDOWNS  
CHEMICALS  
TOOLS  
HELMETS  
HELMET ACC.  
EYEWEAR  
APPAREL / RIDER ACC.  
PROMOTIONAL  
REFERENCE  
INDEX





### FUEL INJECTION LINES

These Goodridge EFI lines are designed to replace the OEM EFI line and is ready to snap into place. They are available in black or stainless steel braid and provide superior abrasion and heat resistance in addition to an aesthetically pleasing appearance.

Description	Black	Clear
Fits Touring Models '08-16	<b>817-02102</b>	<b>817-02103</b>
Fits Touring '02-06 Dyna '04-17 Softail '01-17	<b>817-02100</b>	<b>817-02101</b>
Fits Touring Models '95-99		<b>817-02106</b>
Fits Sportster Models '07-17	<b>817-02104</b>	<b>817-02105</b>



### FUEL CROSSOVER LINES

- Quick disconnect crossover lines feature a high quality quick disconnect valve and durable hose finishers for simple attachment to standard hose barbs
- The braided hoses are compatible with gasoline or ethanol
- The hose finishers feature a stainless gear drive hose clamp for a reliable, long lasting seal
- Chrome plated quick disconnect features Viton o-rings and stainless shut off valves to eliminate fuel loss during tank removal
- Rated at 250 psi
- Universal design fits most models with split tanks

Description	WPS#
Stainless Quick Disconnect Crossover Line	<b>817-02150</b>
Black Quick Disconnect Crossover Line	<b>817-02151</b>
Replacement O-rings 2pk	<b>817-02152</b>



### FUEL TANK FITTING COVER

- ABS chrome
- O-rings and hardware included
- OEM replacement

Description	WPS#
Fits '03-Up Touring, '02-Up Softail and '04-07 Dyna EFI models	<b>820-2636</b>



- WINDSHIELDS / FAIRINGS
- AUDIO / COMMUNICATION
- SEATS / LUGGAGE
- BAR / MIRRORS / CONTROLS
- EXHAUST
- AIR / FUEL SYSTEMS**
- ENGINE
- TRANSMISSION / DRIVELINE
- GASKETS / SEALS
- ELECTRICAL
- LIGHTING
- CABLES
- BRAKES
- OIL FILTERS
- SUSPENSION
- BODY
- WHEELS
- TIRES / TIRE ACC.
- BIKE ACC.
- VICTORY / INDIAN
- COVERS / LOCKS / TIEDOWNS
- CHEMICALS
- TOOLS
- HELMETS
- HELMET ACC.
- EYEWEAR
- APPAREL / RIDER ACC.
- PROMOTIONAL
- REFERENCE
- INDEX



## EFI LINES / CHECK VALVE ASSEMBLIES

- Designed as OEM replacement
- Includes check valve, fuel line and fittings

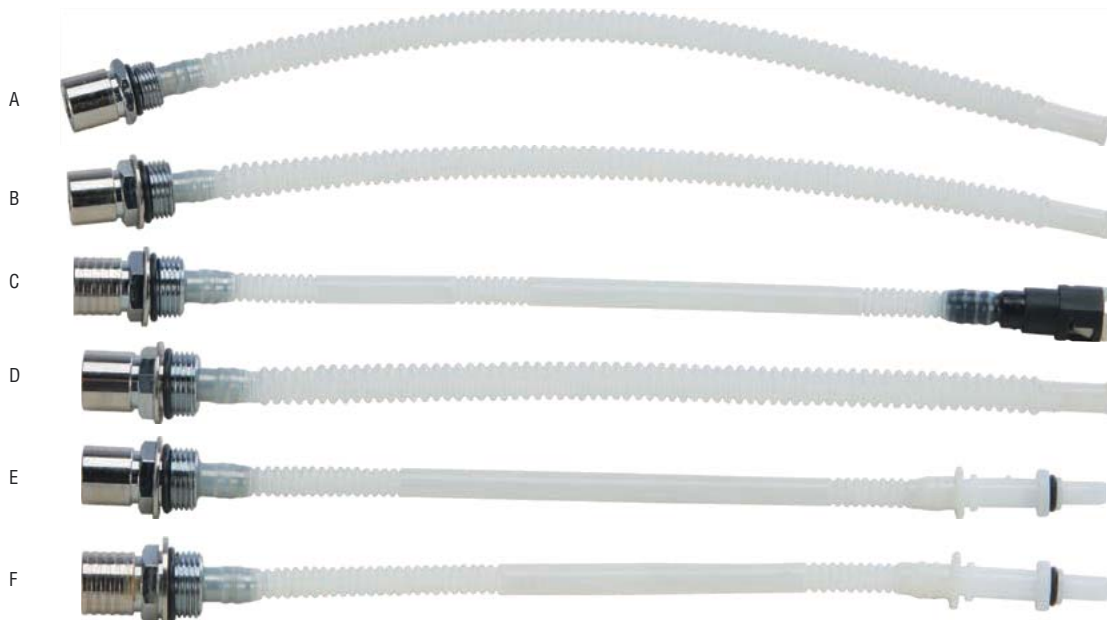

Description	WPS#
<b>CHECK VALVE ASSEMBLY WITH LINE</b>	
A Fits Touring Models '00-02 repl. OEM 61408-00A	<b>820-50554</b>
B Fits Touring Models '03-07 repl. OEM 62228-03	<b>820-50555</b>
C Fits Touring Models '08-Up repl. OEM 62228-08A	<b>820-50556</b>
D Fits Softail Models '01-07 repl. OEM 62189-01A	<b>820-50557</b>
E Fits Softail Models '08-Up repl. OEM 62189-08	<b>820-50558</b>
F Fits Dyna Models '04-Up repl. OEM 62194-04B	<b>820-50559</b>
<b>PUMP TO FILTER LINE ONLY</b>	
Fits Touring Models '00-07 Softails '02-07 repl. OEM 65327-00	<b>820-50566</b>

## EFI LINES / EXTERNAL

Description	WPS#
A Fits Touring Models '08-13 repl. OEM 62905-08	<b>820-50550</b>
Fits Touring '02-06 Dyna '04-Up repl. OEM 62349-04F	<b>820-50551</b>
Fits Touring 2007 FXST/FLST '01-Up repl. OEM 62900-01D	<b>820-50552</b>
B Fits Sportster '07-Up (ex. 1200XV) repl. OEM 27693-07	<b>820-50553</b>





A



B

### EFI PRESSURE REGULATORS

- These parts are intended as OEM replacements
- Please verify the OEM part number to ensure you are ordering the correct part
- Sold each

	Description	WPS#
A	Fits Touring Models '02-07 Softails '01-08 repl. OEM 27408-01	<b>820-50560</b>
B	Fits Touring and Softail Models '08-Up FXD '04-Up repl. OEM 61015-04A	<b>820-50561</b>

	Description	WPS#
A	Fits Touring Models '02-07 Softails '01-08 repl. OEM 61001-01	<b>820-50562</b>
B	Fits Touring and Softail Models '08-Up FXD '04-Up repl. OEM 61011-04A	<b>820-50563</b>
C	Fits Touring Models '95-99 repl. OEM 61343-95	<b>820-50564</b>
D	Fits Sportster Models '07-Up repl. OEM 75304-07A	<b>820-50565</b>

### EFI FUEL FILTERS

- Includes parts as pictured, filter, o-ring, clamps where applicable
- Designed as OEM replacements



WINDSHIELDS / FAIRINGS

AUDIO / COMMUNICATION

SEATS / LUGGAGE

BAR / MIRRORS / CONTROLS

EXHAUST

**AIR / FUEL SYSTEMS**

ENGINE

TRANSMISSION / DRIVELINE

GASKETS / SEALS

ELECTRICAL

LIGHTING

CABLES

BRAKES

OIL FILTERS

SUSPENSION

BODY

WHEELS

TIRES / TIRE ACC.

BIKE ACC.

VICTORY / INDIAN

COVERS / LOCKS / TIEDOWNS

CHEMICALS

TOOLS

HELMETS

HELMET ACC.

EYEWEAR

APPAREL / RIDER ACC.

PROMOTIONAL

REFERENCE

INDEX



## FUEL PUMPS

- Lifetime Warranty
- Pumps come with hoses pre-installed and all components necessary for installation
- OEM or better performance
- Polished corrosion-resistant case to help minimize seizing during non-operation
- Specifically designed for quiet operation
- Drop-in replacement
- Gradient density fuel strainer for superior contaminant filtration (intank pumps only)
- Patented check valve technology
- Compatible with modern ethanol-infused pump gasoline



A



B



C



D

Description	WPS#
A Fits Touring Models '00-07 Softails '01-07 Vrods '00-03	<b>821-03000</b>
B Fits Dynas '02-16 Softails '08-16 Vrods '04-16	<b>821-03001</b>
C Fits Touring Models '08-16	<b>821-03002</b>
D Fits Touring Models '95-99	<b>821-03003</b>
Fits Sportsters '07-16	<b>821-03004</b>



## HIGH FLOW FUEL PETCOCKS

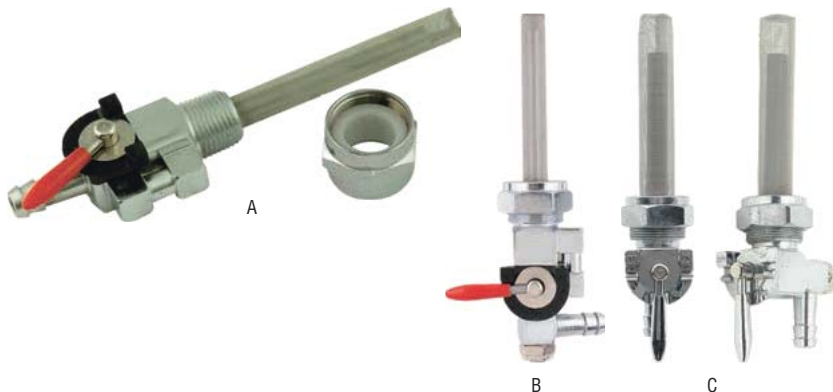

- Assure your bike isn't starving for fuel
- Recommended for any bike with performance modifications
- Built in 100 micron screen filter
- 3 position On/Off/Reserve
- Show quality chrome
- For all models with 22mm bungs

Description	WPS #
A Hi-flow Petcock, Straight	<b>274-0300</b>
B Hi-flow Petcock, Rotates Horizontally	<b>274-0301</b>
C Hi-flow Petcock, Rotates Vertically	<b>274-0302</b>

## REPLACEMENT PETCOCKS



- These petcocks are highly polished and then chrome plated
- Petcocks are designed to maximize fuel flow in both main and reserve modes
- 22mm metric petcocks fit all 1975 to present Big Twin and Sportster models as well most Custom tanks



Application	Description	WPS#
Tanks with 13/16" Bungs ('75-Up)	Straight Down Spigot	<b>820-52250</b>
A	Left Spigot	<b>820-52251</b>
B	Right Spigot	<b>820-52252</b>
C Tanks with 3/8" NPT Bungs (Pre '75)	Right Spigot	<b>820-52253</b>
D	Straight Down Spigot	<b>820-52254</b>
Tanks with 1/4" NPT Bungs	Right Spigot	<b>820-52255</b>
	Straight Down Spigot	<b>820-52256</b>

Application	Description	WPS#
E Tank with 13/16" Bungs ('75-Up)	Straight Down Spigot BLK	<b>820-52235</b>
	Left Spigot BLK	<b>820-52236</b>
	Right Spigot BLK	<b>820-52237</b>
F Tank with 13/16" Bungs ('75-Up)	Round Chrome Right Spigot	<b>820-50567</b>
G	Round Chrome Straight Down Spigot	<b>820-50568</b>
Replacement Gaskets (10 pk)	4 Hole Viton Gasket	<b>820-52257</b>
	3 Hole Viton Gasket	<b>820-52258</b>



Description	WPS#
Left side position 22mm round	<b>820-52238</b>
Right side position 22mm round	<b>820-52239</b>
Downward side position 22mm round	<b>820-52240</b>
Left side position 3/8 round	<b>820-52241</b>
Right side position 3/8 round	<b>820-52242</b>
Downward side position 3/8 round	<b>820-52243</b>
Left side position 22mm hex	<b>820-52244</b>
Right side position 22mm hex	<b>820-52245</b>
Downward side position 22mm hex	<b>820-52246</b>
Left side position 3/8 hex	<b>820-52247</b>
Right side position 3/8 hex	<b>820-52248</b>
Downward side position 3/8 hex	<b>820-52249</b>

## BRASS PETCOCKS

- These new Hi-flow petcocks feature a round or hexagonal body
- Brass finish
- Three position knob, on, off, reserve
- 5/16" fuel outlet
- Fit most stock and custom tanks with 22mm or 3/8" outlets
- Sold each

- WINDSHIELDS / FAIRINGS
- AUDIO / COMMUNICATION
- SEATS / LUGGAGE
- BAR / MIRRORS / CONTROLS
- EXHAUST
- AIR / FUEL SYSTEMS
- ENGINE
- TRANSMISSION / DRIVELINE
- GASKETS / SEALS
- ELECTRICAL
- LIGHTING
- CABLES
- BRAKES
- OIL FILTERS
- SUSPENSION
- BODY
- WHEELS
- TIRES / TIRE ACC.
- BIKE ACC.
- VICTORY / INDIAN
- COVERS / LOCKS / TIEDOWNS
- CHEMICALS
- TOOLS
- HELMETS
- HELMET ACC.
- EYEWEAR
- APPAREL / RIDER ACC.
- PROMOTIONAL
- REFERENCE
- INDEX



## TYGON® GRAY AND BLACK FUEL LINE

- Use with any type of gasoline
- Resists swelling and hardening
- Resistant to direct sunlight, hardening and/or cracking
- Flexible in temperatures from -35F to +165F
- Fuel line stretches easily over fittings or petcocks
- Sold in 25' rolls
- Made in the U.S.A.



I.D.	O.D.	Grey 25'	Black 25'	Grey 3'	Black 3'
3/16" (5mm)	5/16" (8mm)	12-0031	12-0040	12-0049	12-0050
1/4" (6mm)	9/16" (11mm)	12-0032	12-0041	12-0052	12-0053
5/16" (8mm)	1/2" (12.5mm)	12-0033	12-0042	12-0055	12-0056

## BRAIDED VINYL FUEL LINE

- Nylon-reinforced vinyl fuel line
- Braided nylon within the wall gives added strength
- Recommended where higher pressure is involved
- Outstanding appearance for custom fuel lines
- Sold in 25' rolls
- Made in the U.S.A.



I.D.	O.D.	Roll Length	WPS#
3/16" (5mm)	3/8" (10mm)	25'	12-0009
1/4" (6mm)	1/2" (12.5mm)	25'	12-0010
5/16" (8mm)	9/16" (14mm)	25'	12-0011
3/8" (10mm)	5/8" (16mm)	25'	12-0012

## CLEAR VINYL FUEL LINE

- Constructed of plasticized PVC
- Soft flexible tubing
- Safe to use with any type of gasoline or alcohol type fuel
- Smooth hard bore helps prevent interior build up
- Sold in 25' rolls
- Made in the U.S.A.



I.D.	O.D.	Roll Length	WPS#	3' roll
<b>STANDARD FUEL LINE</b>				
1/8" (3mm)	1/4" (6mm)	25'	12-0000	
3/16" (5mm)	5/16" (8mm)	25'	12-0001	
1/4" (6mm)	7/16" (11mm)	25'	12-0002	
5/16" (8mm)	1/2" (12.5mm)	25'	12-0003	
3/8" (10mm)	9/16" (14mm)	25'	12-0004	
<b>PREMIUM FUEL LINE</b>				
3/16" (5mm)	5/16" (8mm)	25'	12-0043	12-0051
1/4" (6mm)	7/16" (11mm)	25'	12-0044	12-0054
5/16" (8mm)	1/2" (12.5mm)	25'	12-0045	12-0057



## CLEAR FUEL AND PRIMER LINE

- Top grade 100% polyurethane
- Not affected by subzero temperatures
- Visual confirmation of fuel flow
- OEM quality vent lines keep fuel off your engine

Size	Roll Length	WPS#
3/16" ID	50' roll	12-12022
1/4" ID	50' roll	12-12024
5/16" ID	50' roll	12-12026



## STEPLESS CLAMP KIT

- Convenient kit includes 80 or 85 pcs of hardware and a convenient fuel line clamp size chart
- 80pc kit includes a Motion Pro Side Jaw Pincer tool
- Warning: not for use with fuel injection systems
- Kit includes following items packed in a convenient storage box:

## STEEL O-CLIPS

- Ideally suited for clamping vinyl or Nitrile fuel line to fittings
- One piece construction assures positive clamping action without damage to the hose
- O-Clip pincer tool is made specifically to install and to remove the clips

Description	Quantity	WPS#
Side jaw pincer tool (for use in limited space)	1	57-12073
Standard pincer tool only	1	12-0240
Stepless clamp kit 8-18mm with pincer tool	80 pc	12-0830
Stepless clamp kit 15-47mm w/o tool	85 pc	57-10065
Stepless clamp 7.8-9.5mm	10/pk	57-20074
Stepless clamp 8.8-10.5mm	10/pk	57-20084
Stepless clamp 9.6-11.3mm	10/pk	57-20081
Stepless clamp 10.3-12.8mm	10/pk	57-20075
Stepless clamp 10.8-13.38mm	10/pk	57-20076
Stepless clamp 12-14.5mm	10/pk	57-20077
Stepless clamp 14.8-18.0mm	10/pk	57-20078
Stepless clamp 13.2-15.7mm	10/pk	57-20082
Stepless clamp 17-21mm	10/pk	57-10066
Stepless clamp 21-24mm	10/pk	57-10067
Stepless clamp 24-27mm	10/pk	57-10068
Stepless clamp 27-30mm	10/pk	57-10069
Stepless clamp 30-33mm	10/pk	57-10070
Stepless clamp 33-37mm	10/pk	57-10071
Stepless clamp 37-40mm	5/pk	57-10072
Stepless clamp 41-44mm	5/pk	57-10073
Stepless clamp 44-47mm	5/pk	57-10074
5/16 O-Clips for 3/16 hose	10/pk	12-0250
7/16 O-Clips for 1/4 hose	10/pk	12-0260
1/2 O-Clips for 5/16 hose	10/pk	12-0270
9/16 O-Clips for 3/8 hose	10/pk	12-0280

## STAINLESS STEEL HOSE CLAMPS

- Made of corrosion-resistant stainless steel
- Conventional-type worm drive hose clamps
- 1/4" hex head with screwdriver slot
- Sold in packs of 10

Description	Pack	WPS#
For 1/4" - 5/8" hose	10/pk	12-0022
For 7/16" - 25/32" hose	10/pk	12-0023

- WINDSHIELDS / FAIRINGS
- AUDIO / COMMUNICATION
- SEATS / LUGGAGE
- BARS / MIRRORS / CONTROLS
- EXHAUST
- AIR / FUEL SYSTEMS
- ENGINE
- TRANSMISSION / DRIVELINE
- GASKETS / SEALS
- ELECTRICAL
- LIGHTING
- CABLES
- BRAKES
- OIL FILTERS
- SUSPENSION
- BODY
- WHEELS
- TIRES / TIRE ACC.
- BIKE ACC.
- VICTORY / INDIAN
- COVERS / LOCKS / TIEDOWNS
- CHEMICALS
- TOOLS
- HELMETS
- HELMET ACC.
- EYEWEAR
- APPAREL / RIDER ACC.
- PROMOTIONAL
- REFERENCE
- INDEX



## PREMIER QUALITY CLAMPS

- Highest quality clamps available
- Stainless steel throughout including the drive
- Superior in strength, appearance and functionality
- The band's worm drive is raised to give a smooth surface preventing hose damage
- Rolled edges eliminate hose damage found with normal clamps
- Short housing saddle, smooth underside and tapered tail end provide maximum circumference sealing at minimum torque

Clamping Range, Inch	mm		WPS#
3/8" to 5/8"	10-16	10/pak	<b>14-0030</b>
1/2" to 3/4"	12-20	10/pak	<b>14-0033</b>
5/8" to 1"	16-25	10/pak	<b>14-0035</b>
3/4" to 1 1/4"	20-32	10/pak	<b>14-0037</b>
1" to 1-5/8"	25-40	10/pak	<b>14-0039</b>
1 1/4" to 2"	32-50	10/pak	<b>14-0041</b>
1-5/8" to 2-3/8"	40-60	10/pak	<b>14-0042</b>
2" to 2 3/4"	50-70	10/pak	<b>14-0043</b>
2-3/8" to 3 1/2"	60-80	10/pak	<b>14-0044</b>
3-1/8" to 4"	80-100	10/pak	<b>14-0046</b>
4" to 4 3/4"	100-120	10/pak	<b>14-0047</b>
4 3/4" to 5 1/2"	120-140	10/pak	<b>14-0048</b>

## 90 PIECE DEALER KIT

Norma Dispenser Kit with Torro Worm Drive Hose Clamps, covering a range from 8mm (5/16") to 80mm (4")



Description	WPS#
90 piece Dealer Kit: Includes 10 each of 9 sizes	<b>14-0090</b>



## SELF TENSIONING WIRE HOSE CLAMP

- Zinc plated, 5 ea. to fit 5/16, 3/8 and 7/16 OD tubing
- Self compensating design

Description	WPS#
15 pc Assorted Sizes	<b>14-0050</b>
150pc Assorted sizes	<b>14-0051</b>
150 pc 5/16" O.D.	<b>14-0054</b>
150 pc 3/8" O.D.	<b>14-0055</b>
150 pc 7/16" O.D.	<b>14-0056</b>



## STAINLESS STEEL HOSE CLAMP

Clamp Size	Pack	WPS#
6-16mm	10/Pk	<b>14-0060</b>
8-22mm	10/Pk	<b>14-0061</b>
10-25mm	10/Pk	<b>14-0062</b>
13-32mm	10/Pk	<b>14-0063</b>
19-44mm	10/Pk	<b>14-0064</b>
26-51mm	10/Pk	<b>14-0065</b>
32-58mm	10/Pk	<b>14-0066</b>
58-83mm	10/Pk	<b>14-0067</b>

- Narrower width than most clamps
- Great for intake manifold clamps



## HOSE PROTECTORS

- Made from stainless steel
- Protects hoses from abrasion
- Sizes for fuel and coolant lines
- Measure outside diameter of hose for fitment

Size	WPS#
3/8" x 10"	<b>14-0370</b>
7/16" x 10"	<b>14-0371</b>
1" x 10"	<b>14-0372</b>
1 1/2" x 10"	<b>14-0373</b>



## FUEL LINE CLIPS

- Zinc plated
- Easy to install and remove
- Convenient 10/pak packaging

Clip	Hose	Pack	WPS#
5/16"	3/16"	10/Pk	<b>14-0093</b>
7/16"	1/4"	10/Pk	<b>14-0094</b>
1/2"	5/16"	10/Pk	<b>14-0095</b>





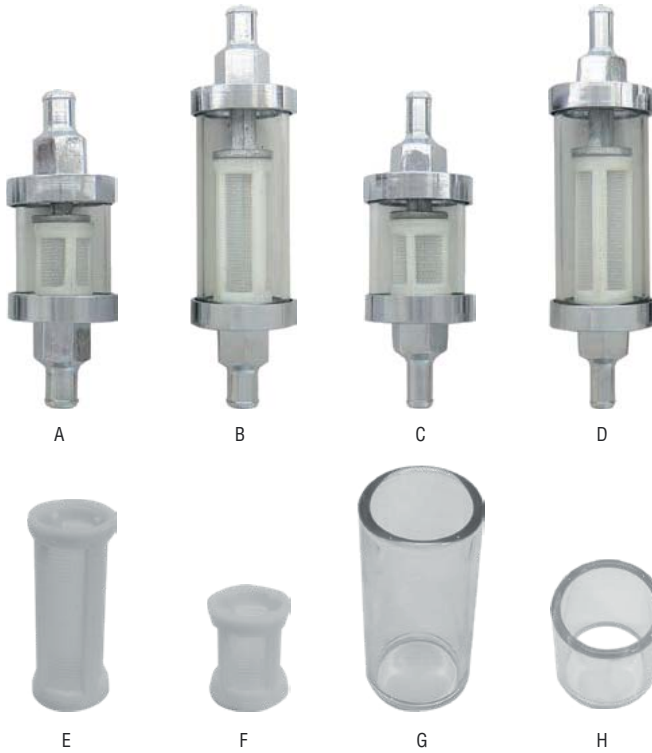

### SEE-FLOW FUEL FILTER

- Glass body with with chrome end caps
- Nylon filter element
- Replacement parts available

	Size	Application	WPS#
A	3 1/4" L x 1 1/8" dia.	5/16" fuel line	<b>820-2647</b>
B	3 7/8" L x 1 1/8 " dia	5/16" fuel line	<b>820-2648</b>
C	3 1/4" L x 1 1/8" dia.	1/4" fuel line	<b>820-2653</b>
D	3 7/8" L x 1 1/8" dia.	1/4" fuel line	<b>820-2654</b>
REPLACEMENT PARTS			
E	Fuel filter nylon element	Long	<b>820-2650</b>
F		Short	<b>820-2649</b>
G	Fuel filter glass tube	Long	<b>820-2652</b>
H		Short	<b>820-2651</b>



### SUPER SIPHON

- Allows you to siphon fluids without sucking on the hose with your mouth
- Just wiggle hose up and down to start siphoning

**WPS#**  
**12-1201**



### SIPHON PUMP

- Sucks water out of the tightest areas

**WPS#**  
**23-0250**

- WINDSHIELDS / FAIRINGS
- AUDIO / COMMUNICATION
- SEATS / LUGGAGE
- BAR / MIRRORS / CONTROLS
- EXHAUST
- AIR / FUEL SYSTEMS**
- ENGINE
- TRANSMISSION / DRIVELINE
- GASKETS / SEALS
- ELECTRICAL
- LIGHTING
- CABLES
- BRAKES
- OIL FILTERS
- SUSPENSION
- BODY
- WHEELS
- TIRES / TIRE ACC.
- BIKE ACC.
- VICTORY / INDIAN
- COVERS / LOCKS / TIEDOWNS
- CHEMICALS
- TOOLS
- HELMETS
- HELMET ACC.
- EYEWEAR
- APPAREL / RIDER ACC.
- PROMOTIONAL
- REFERENCE
- INDEX



# ROCKER COVERS

Dress up your motor and give it a custom old school look with these EMD upper rocker covers. Made from cast aluminum and then CNC machined for precise fit.

- Available in raw cast or black powder coat finish
- Different classic engine styles to choose from, Shovel, Ironhead and XR
- Covers sold in pairs
- Look great with other EMD drivetrain covers, i.e. cam, tranny and primary covers!



A



B



D

Description	Raw	Black
<b>FITS '86-03 XL MODELS</b>		
Shovel Style Rocker Cover	<b>866-05037</b>	<b>866-05038</b>
A Ironhead Style Rocker Cover	<b>866-05043</b>	<b>866-05044</b>
B XR Style Rocker Cover	<b>866-05049</b>	<b>866-05050</b>
C Ribbed Rocker Covers	<b>866-05023</b>	<b>866-05024</b>
<b>FITS '04-17 XL MODELS</b>		
D Shovel Style Rocker Cover	<b>866-05039</b>	<b>866-05040</b>
Ironhead Style Rocker Cover	<b>866-05045</b>	<b>866-05046</b>
XR Style Rocker Cover	<b>866-05051</b>	<b>866-05052</b>
Ribbed Rocker Covers	<b>866-05025</b>	<b>866-05026</b>
<b>FITS '84-99 EVO BIG TWINS</b>		
Shovel Style Rocker Cover	<b>866-05041</b>	<b>866-05042</b>
Ironhead Style Rocker Cover	<b>866-05047</b>	<b>866-05048</b>
E Ribbed Rocker Covers	<b>866-05027</b>	<b>866-05028</b>
<b>FITS '99-17 TWIN CAMS</b>		
Ribbed Rocker Covers	<b>866-05029</b>	<b>866-05030</b>
F Sherman Rocker Covers	<b>866-05059</b>	<b>866-05060</b>



C



E



F



## ROCKER COVER KITS

- Chrome plated rocker covers for Big Twins and Sportsters
- Sold as pictured



A



B



C



D



E



G



F

Application	Description	WPS#
A '99-17 Twin Cam	Chrome Rocker Box Covers	820-51572
B '92-99 Evolution Big Twin	Chrome Rocker Box	820-51571
C '86-03 Sportster	Chrome Rocker Box	820-51570
D '48-65 Panheads	Chrome Rocker Cover Set	820-51573
E	Chrome D-rings	820-51574
F '84-99 Big Twin	Chrome Rocker Box Kit	820-51583
G '99-17 Twin Cam	Rocker Box base Gasket	820-51584



## ROCKER BOX COVER SETS

- Made in the USA!
- Available in Chrome plated and Polished

Application	Year	WPS#
Shovelhead	* '66-81	830-1028
Shovelhead	* '81-84	830-1029
EVO Big Twin models	'84-99	830-1030
Touring models	'99-16	830-1031
Softail and Dyna 99-Up	'00-Up	830-1031
Touring models (polished)	'99-16	830-1032
Softail and Dyna '99-Up (polished)	'00-Up	830-1032

\*requires drilling to 3/8 diameter hole

- WINDSHIELDS / FAIRINGS
- AUDIO / COMMUNICATION
- SEATS / LUGGAGE
- BAR / MIRRORS / CONTROLS
- EXHAUST
- AIR / FUEL SYSTEMS
- ENGINE**
- TRANSMISSION / DRIVELINE
- GASKETS / SEALS
- ELECTRICAL
- LIGHTING
- CABLES
- BRAKES
- OIL FILTERS
- SUSPENSION
- BODY
- WHEELS
- TIRES / TIRE ACC.
- BIKE ACC.
- VICTORY / INDIAN
- COVERS / LOCKS / TIEDOWNS
- CHEMICALS
- TOOLS
- HELMETS
- HELMET ACC.
- EYEWEAR
- APPAREL / RIDER ACC.
- PROMOTIONAL
- REFERENCE
- INDEX



## BRASS ROCKER BOX OIL LINES

- Old-STF Ironhead Sportster loop rocker box lines. 1/4" Brass oil lines pre-bent with all necessary fittings. Easy install, all lines and fittings are polished. Install loop up or down.
- No hassle kit for Shovelheads 1966-84. Heavy 1/4" Brass oil lines are pre bent with all necessary fittings. These lines will eliminate the problem of the "starving front head"
- All compression fittings are pre tightened, thread sealant is provided for the npt to case and rockers. A stainless allen plug is provided for the rear rocker when installed is flush and unseen.
- Made in the USA.

Description	Application	WPS#
Rocker Box Split Oil Line	Shovel Heads '66-84	880-2110
Rocker Box Oil Line	Iron Head Sportsters	880-2111



## PAN ROCKER COVERS

Covers are chrome plated stamped steel and sold in pairs. Sockethead screw sets come in packs of 24.

Description	WPS #
A Panhead Rocker Arm Covers Smooth	830-3200
B Panhead Rocker Arm Covers Ribbed	830-3201
Rocker Cover Screws '48-54 (10-24 X 3/4)	830-3202
Rocker Cover Screws '55-65 (10-24 X 1-1/4)	830-3203

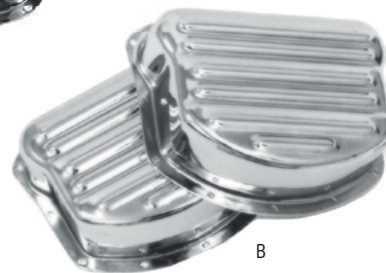



### SHOVEL ROCKER ARMS

- Rocker arms and shafts for Big Twins '66-84
- Rocker arms include bushings

Description	WPS#
Rocker Arm Rear Exh/Front Int	820-51575
Rocker Arm Front Exh/Rear Int	820-51576
Rocker Shaft	820-51577



### ROCKER SHAFT END PLUG AND CAP KIT

- Meets or exceeds OEM specifications
- Made in the USA!
- Chrome plated allen style

Application	WPS#
'71-Up Shovelhead and '71-85 XL models	830-1112



### ROCKER BOX NUT KIT

- Plated hex nuts and flat washers
- Clean, detailed and stock look
- Made in the USA!

Application	WPS#
'66-84 Shovelhead	830-1113



### ROCKER ARM BUSHING

- Our bronze rocker bushing material meets the high standards we set for success
- KPMI® tested and analyzed several bearing-bronze materials for anti friction qualities, hardness, and resistance to deformation under high loads
- KPMI® Rocker arm bushings are held to tight dimensional tolerances, have an excellent surface finish, machine well, and have a tapered lead on each end to ease installation
- Made from US mill certified SAE 660 bearing bronze bar stock

Description	Application	WPS#
0.6795" O.D. (8 Pack)	Evo Big Twin '84-99, Evo Sporster '86-17, and Shovelhead '66-83	191-57088



- WINDSHIELDS / FAIRINGS
- AUDIO / COMMUNICATION
- SEATS / LUGGAGE
- BAR / MIRRORS / CONTROLS
- EXHAUST
- AIR / FUEL SYSTEMS
- ENGINE**
- TRANSMISSION / DRIVELINE
- GASKETS / SEALS
- ELECTRICAL
- LIGHTING
- CABLES
- BRAKES
- OIL FILTERS
- SUSPENSION
- BODY
- WHEELS
- TIRES / TIRE ACC.
- BIKE ACC.
- VICTORY / INDIAN
- COVERS / LOCKS / TIEDOWNS
- CHEMICALS
- TOOLS
- HELMETS
- HELMET ACC.
- EYEWEAR
- APPAREL / RIDER ACC.
- PROMOTIONAL
- REFERENCE
- INDEX



# HYPEREUTECTIC CAST PISTONS

KB Hypereutectic alloy pistons are cast with a 16% high silicon content that has very high thermal barrier properties along with a low thermal expansion rate, allowing tight piston to cylinder wall clearances. This makes them ideal for air-cooled engines, offering optimal ring seal, quieter engine running and reduced wear. Hypereutectics are best suited for stock or mild compression ratios up to 10.5:1 running on pump fuel.



824-01000

824-01100

Application	Year	Disp. ci	Disp. cc	Bore Size	Stroke	WPS #	Ring Set	Wrist Pin	Lock
<b>HARLEY-DAVIDSON®</b>									
<b>Twin Cam 88"</b> 1450cc Stock Bore and Stroke Gasket Kit, Stock Bore (Required) 8.8:1 w/85cc Flat Top with +1cc	'99-06	88"	1450	3.750"/Std 3.755"/.005 3.760"/.010 3.770"/.020 3.780"/.030	4.000"	<b>824-01350</b> <b>824-01351</b> <b>824-01352</b> <b>824-01353</b> <b>824-01354</b>	<b>824-02008</b>	<b>824-02015</b>	<b>824-02018</b>
<b>Twin Cam 88"</b> 1450cc Stock Bore and Stroke Gasket Kit, Stock Bore (Required) 10.6:1 w/85cc Dome with -16.8cc	'99-06	88"	1450	3.750"/Std 3.755"/.005 3.760"/.010 3.770"/.020 3.780"/.030	4.000"	<b>824-01356</b> <b>824-01357</b> <b>824-01358</b> <b>824-01359</b> <b>824-01360</b>	<b>824-02008</b>	<b>824-02015</b>	<b>824-02018</b>
<b>Twin Cam 88" to 95" Big Bore</b> 1550cc with Stock Stroke Gasket Kit, Big Bore (Required) 9.3:1 w/85cc Flat Top with +1cc	'99-06	95"	1550	3.875"/Std 3.880"/.005 3.885"/.010 3.895"/.020 3.905"/.030	4.000"	<b>824-01361</b> <b>824-01362</b> <b>824-01363</b> <b>824-01364</b> <b>824-01365</b>	<b>824-02009</b>	<b>824-02014</b>	<b>824-02018</b>
<b>Twin Cam 88" to 95" Big Bore</b> 1550cc with Stock Stroke Gasket Kit, Big Bore (Required) 10.5:1 w/85cc Dome with -11.2cc	'99-06	95"	1550	3.875"/Std 3.880"/.005 3.885"/.010 3.895"/.020 3.905"/.030	4.000"	<b>824-01367</b> <b>824-01368</b> <b>824-01369</b> <b>824-01370</b> <b>824-01371</b>	<b>824-02009</b>	<b>824-02014</b>	<b>824-02018</b>
<b>Twin Cam 96" to 103" Big Bore</b> 1688cc with Stock Stroke Gasket Kit, Big Bore (Required) 10.0:1 w/85cc Flat Top with +1.9cc	'07-17	103"	1688	3.875"/Std 3.880"/.005 3.885"/.010 3.895"/.020 3.905"/.030 3.915"/.040	4.375"	<b>824-01373</b> <b>824-01374</b> <b>824-01375</b> <b>824-01376</b> <b>824-01377</b> <b>824-01378</b>	<b>824-02000</b>	<b>824-02015</b>	<b>824-02018</b>
<b>Evo Big Twin 80"</b> 1340cc with Stock Stroke Gasket Kit Stock Bore (Required) 8.6:1 w/80cc Flat Top with +0.8cc	'84-99	80"	1340	3.498"/Std 3.503"/.005 3.508"/.010 3.518"/.020 3.528"/.030 3.538"/.040	4.250"	<b>824-01000</b> <b>824-01001</b> <b>824-01002</b> <b>824-01003</b> <b>824-01004</b> <b>824-01005</b>	<b>824-02003</b>	<b>824-02016</b>	<b>824-02019</b>
<b>Evo Big Twin 80"</b> 1340cc with Stock Stroke Gasket Kit Stock Bore (Required) 9.6:1 w/80cc Dome with -9cc	'84-99	80"	1340	3.498"/Std 3.503"/.005 3.508"/.010 3.518"/.020 3.528"/.030 3.538"/.040	4.250"	<b>824-01006</b> <b>824-01007</b> <b>824-01008</b> <b>824-01009</b> <b>824-01010</b> <b>824-01011</b>	<b>824-02003</b>	<b>824-02016</b>	<b>824-02019</b>
<b>Evo Big Twin 80"</b> 1340cc with Stock Stroke Gasket Kit Stock Bore (Required) 10.5:1 w/80cc Dome with -16.5cc	'84-99	80"	1340	3.498"/Std 3.503"/.005 3.508"/.010 3.518"/.020 3.528"/.030 3.538"/.040	4.250"	<b>824-01012</b> <b>824-01013</b> <b>824-01014</b> <b>824-01015</b> <b>824-01016</b> <b>824-01017</b>	<b>824-02003</b>	<b>824-02016</b>	<b>824-02019</b>
<b>Knuckle/Pan/Shovel 74"</b> 1200cc with Stock Stroke Gasket Kit Stock Bore (Required) 8.0:1 w/112cc Hemi Dome with -42.3cc	'41-79	74"	1200	3.437"/Std 3.442"/.005 3.447"/.010 3.457"/.020 3.467"/.030 3.477"/.040 3.487"/.050 3.497"/.060 3.507"/.070 3.517"/.080	3.969"	<b>824-01100</b> <b>824-01101</b> <b>824-01102</b> <b>824-01103</b> <b>824-01104</b> <b>824-01105</b> <b>824-01106</b> <b>824-01107</b> <b>824-01108</b> <b>824-01109</b>	<b>824-02006</b>	<b>824-02016</b>	<b>824-02019</b>

# HYPEREUTECTIC CAST PISTONS



Application	Year	Disp. ci	Disp. cc	Bore Size	Stroke	WPS #	Ring Set	Wrist Pin	Lock
<b>HARLEY-DAVIDSON® (CONT'D...)</b>									
<b>Shovelhead 80"</b> 1340cc with Stock Stroke Gasket Kit Stock Bore (Required) 7.2:1 w/117cc Hemi Dome with -29.3cc	'78-84	80"	1340	3.498"/Std	4.250"	824-01150	824-02007	824-02016	824-02019
				3.503"/.005		824-01151			
				3.508"/.010		824-01152			
				3.518"/.020		824-01153			
				3.528"/.030		824-01154			
3.538"/.040	824-01155								
<b>Shovelhead 80"</b> 1340cc with Stock Stroke Gasket Kit Stock Bore (Required) 8.3:1 w/117cc Hemi Dome with -45.4cc	'78-84	80"	1340	3.498"/Std	4.250"	824-01156	824-02007	824-02016	824-02019
				3.503"/.005		824-01157			
				3.508"/.010		824-01158			
				3.518"/.020		824-01159			
				3.528"/.030		824-01160			
3.538"/.040	824-01161								
<b>Shovelhead 88"-98" Big Bore Stroker</b> '48-84 1450cc with 4.250" Stroke 1606cc with 4.750" Stroke Gasket Kit Big Bore (Required) 8.5:1 w/117cc with 4.250" Stroke 9.4:1 w/117cc with 4.750" Stroke Hemi Dome with -42.3cc	'48-84	88-98"	1340	3.625"/Std	4.250" to 4.750"	824-01162	824-02010	824-02016	824-02019
				3.630"/.005		824-01163			
				3.635"/.010		824-01164			
				3.645"/.020		824-01165			
				3.655"/.030		824-01166			
				3.665"/.040		824-01167			

## CAST SPORTSTER PISTONS



824-01256



824-01300

Application	Year	Disp. ci	Disp. cc	Bore Size	Stroke	WPS #	Ring Set	Wrist Pin	Lock
<b>HARLEY-DAVIDSON®</b>									
<b>Sportster 883</b> 883cc Stock Bore and Stroke Gasket Kit, Stock Bore (Required) 9.0:1 w/49cc Flat Top with +1.2cc	'86-Up	54"	883	3.000"/Std	3.812"	824-01200	824-02011	824-02014	824-02019
				3.010"/.010		824-01201			
				3.020"/.020		824-01202			
				3.030"/.030		824-01203			
				3.040"/.040		824-01204			
<b>Sportster 1200</b> 1200cc Stock Bore and Stroke Gasket Kit, Stock Bore (Required) 8.9:1 w/69cc Flat Top with +1.6cc	'88-Up	74"	1200	3.498"/Std	3.812"	824-01205	824-02003	824-02014	824-02019
				3.503"/.050		824-01206			
				3.508"/.010		824-01207			
				3.518"/.020		824-01208			
				3.528"/.030		824-01209			
3.538"/.040	824-01210								
<b>Sportster 1000</b> 1000cc Stock Bore and Stroke Gasket Kit, Stock Bore (Required) 8.2:1 w/110cc Dome with -48.9cc	'72-85	61"	1000	3.188"/Std	3.812"	824-01300	824-02012	824-02014	824-02019
				3.198"/.010		824-01301			
				3.208"/.020		824-01302			
				3.218"/.030		824-01303			
				3.228"/.040		824-01304			
<b>Sportster 883 to 1200 Conversion</b> 1200cc Big Bore and Stock Stroke Gasket Kit, Big Bore (Required) 10.0:1 w/51cc Flat Top with +10cc	'86-Up	74"	1200	3.498"/Std	3.812"	824-01256	824-02003	824-02014	824-02019
				3.503"/.050		824-01257			
				3.508"/.010		824-01258			
				3.518"/.020		824-01259			
				3.528"/.030		824-01260			

- WINDSHIELDS / FAIRINGS
- AUDIO / COMMUNICATION
- SEATS / LUGGAGE
- BAR / MIRRORS / CONTROLS
- EXHAUST
- AIR / FUEL SYSTEMS
- ENGINE**
- TRANSMISSION / DRIVELINE
- GASKETS / SEALS
- ELECTRICAL
- LIGHTING
- CABLES
- BRAKES
- OIL FILTERS
- SUSPENSION
- BODY
- WHEELS
- TIRES / TIRE ACC.
- BIKE ACC.
- VICTORY / INDIAN
- COVERS / LOCKS / TIEDOWNS
- CHEMICALS
- TOOLS
- HELMETS
- HELMET ACC.
- EYEWEAR
- APPAREL / RIDER ACC.
- PROMOTIONAL
- REFERENCE
- INDEX



# FORGED ALLOY PISTONS

KB forged pistons are made from 4032 forged alloy with an 11% silicon content, formed in a forging press and then fully machined. Due to the material and manufacturing process these pistons have superior crack resistance under detonation or pre-ignition. They are suited for Street or Race applications with power adders such as NOS or boost. All Twin Cam and Sportster application feature coated skirts.



824-01500

824-01550

824-01612

824-01650

824-01706

Application	Year	Disp. ci	Disp. cc	Bore Size	Stroke	WPS #	Ring Set	Wrist Pin	Locks
<b>HARLEY-DAVIDSON®</b>									
<b>Twin Cam 88" to 95" Big Bore</b>	'99-06	95"	1550	3.875"/Std	4.000"	<b>824-01500</b>	<b>824-02000</b>	<b>824-02013</b>	<b>824-02018</b>
1550cc with Stock Stroke				3.880"/.005		<b>824-01501</b>			
Gasket Kit, Big Bore (Required)				3.885"/.010		<b>824-01502</b>			
9.25:1 w/85cc				3.895"/.020		<b>824-01503</b>			
Dome with 1.0cc				3.905"/.030		<b>824-01504</b>			
<b>Twin Cam 88" to 95" Big Bore</b>	'99-06	95"	1550	3.875"/Std	4.000"	<b>824-01506</b>	<b>824-02000</b>	<b>824-02013</b>	<b>824-02018</b>
1550cc with Stock Stroke				3.880"/.005		<b>824-01507</b>			
Gasket Kit, Big Bore (Required)				3.885"/.010		<b>824-01508</b>			
10.5:1 w/85cc				3.895"/.020		<b>824-01509</b>			
Dome with -11.3cc				3.905"/.030		<b>824-01510</b>			
<b>Twin Cam 96" to 103" Big Bore</b>	'07-17	103"	1688	3.875"/Std	4.375"	<b>824-01522</b>	<b>824-02000</b>	<b>824-02013</b>	<b>824-02018</b>
1688cc with Stock Stroke				3.880"/.005		<b>824-01523</b>			
Gasket Kit, Big Bore (Required)				3.885"/.010		<b>824-01524</b>			
9.5:1 w/85cc				3.895"/.020		<b>824-01525</b>			
Dish with +6.9cc				3.905"/.030		<b>824-01526</b>			
<b>Twin Cam 96" to 103" Big Bore</b>	'07-17	103"	1688	3.875"/Std	4.375"	<b>824-01527</b>	<b>824-02000</b>	<b>824-02013</b>	<b>824-02018</b>
1688cc with Stock Stroke				3.880"/.005		<b>824-01528</b>			
Gasket Kit, Big Bore (Required)				3.885"/.010		<b>824-01529</b>			
10.5:1 w/85cc				3.895"/.020		<b>824-01530</b>			
Dome with -3.6cc				3.905"/.030		<b>824-01531</b>			
<b>Evo Big Twin 80"</b>	'84-99	80"	1340	3.498"/Std	4.250"	<b>824-01600</b>	<b>824-02003</b>	<b>824-02016</b>	<b>824-02019</b>
1340cc with Stock Stroke				3.503"/.005		<b>824-01601</b>			
Gasket Kit Stock Bore (Required)				3.508"/.010		<b>824-01602</b>			
8.5:1 w/80cc				3.518"/.020		<b>824-01603</b>			
Dish with +2.1cc				3.528"/.030		<b>824-01604</b>			
<b>Evo Big Twin 80"</b>	'84-99	80"	1340	3.498"/Std	4.250"	<b>824-01605</b>	<b>824-02003</b>	<b>824-02016</b>	<b>824-02019</b>
1340cc with Stock Stroke				3.538"/.040		<b>824-01606</b>			
Gasket Kit Stock Bore (Required)				3.503"/.005		<b>824-01607</b>			
9.5:1 w/80cc				3.508"/.010		<b>824-01608</b>			
Dome with -8.5cc				3.518"/.020		<b>824-01609</b>			
<b>Evo Big Twin 80"</b>	'84-99	80"	1340	3.498"/Std	4.250"	<b>824-01610</b>	<b>824-02003</b>	<b>824-02016</b>	<b>824-02019</b>
1340cc with Stock Stroke				3.528"/.030		<b>824-01611</b>			
Gasket Kit Stock Bore (Required)				3.538"/.040		<b>824-01612</b>			
10.5:1 w/80cc				3.503"/.005		<b>824-01613</b>			
Dome with -16.7cc				3.508"/.010		<b>824-01614</b>			
<b>Evo Big Twin 80"</b>	'84-99	80"	1340	3.498"/Std	4.250"	<b>824-01615</b>	<b>824-02003</b>	<b>824-02016</b>	<b>824-02019</b>
1340cc with Stock Stroke				3.518"/.020		<b>824-01616</b>			
Gasket Kit Stock Bore (Required)				3.528"/.030		<b>824-01617</b>			
10.5:1 w/80cc				3.538"/.040		<b>824-01618</b>			
Dome with -16.7cc									
<b>HARLEY-DAVIDSON®</b>									
<b>Sportster 883 to 1200 Conversion</b>	'86-Up	74"	1200	3.498"/Std	3.812"	<b>824-01656</b>	<b>824-02003</b>	<b>824-02017</b>	<b>824-02019</b>
1200cc Big Bore and Stock Stroke				3.503"/.050		<b>824-01657</b>			
Gasket Kit, Big Bore (Required)				3.508"/.010		<b>824-01658</b>			
10.5:1 w/51cc				3.518"/.020		<b>824-01659</b>			
Dish with +6.3cc				3.528"/.030		<b>824-01660</b>			
				3.538"/.040		<b>824-01661</b>			



# WHY USE **W** **WISeco** ?

Performance Products

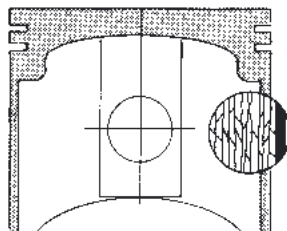

**FORGED**  
Interwoven grain structure for superior strength

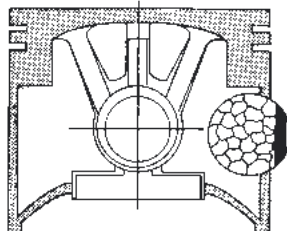

**CAST**  
Random grain pattern

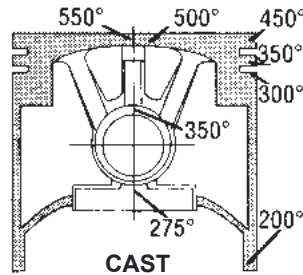

**CAST**

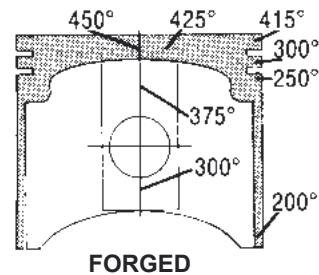

**FORGED**

### 1) FORGED

All Wiseco Pistons are forged from high silicon, low expansion aluminum which offers superior strength, reduced weight, improved heat transfer, and longer life.

### 2) ADVANCED MANUFACTURING TECHNIQUES

Diamond turned finish from one of the many CNC computer controlled turning centers guarantees you a perfect finish with no size variation. Wiseco pistons can be installed in any of today's cylinder bore compositions (cast iron, chrome, nikasil and boron composite) with confidence.

### 3) OVERSIZE OPTIONS

Wiseco's wide range of oversize pistons increase the life of cast iron lined cylinders. With the availability of replacement cylinder sleeves, chrome, nikasil and boron composite cylinders can be resleeved to accept Wiseco's oversizes.

### 4) COMPUTERIZED

Wiseco's state-of-the-art computerized manufacturing facility is dedicated to supplying both the high-performance racer and recreational enthusiast with the finest forged piston available in today's market place.

### 5) EASY AVAILABILITY

Three WPS warehouses offer you one of the largest Wiseco inventories available. Our telephone sales staff can verify availability at the time of your order. Pistons that we don't have in stock are rushed in air freight and are available for shipment to you within two to three working days.

**Note:** Some piston kits change displacement, compression ratio, etc. and may be illegal for use on pollution controlled vehicles, check your local laws before installation.

**Note:** Replacement Rings and Circlips sold per piston



Application	Year	Disp. ci	Disp. cc	Bore Size	Stroke	Piston Kits WPS #	Replacement			
							Piston	Rear Piston	Ring Set	Circlips & Wrist Pin
<b>HARLEY-DAVIDSON®</b>										
<b>883 Evo Sportster®</b>	'86-17	73	1200	3.498"/Std	3.812"	<b>K1655</b>	<b>4718PS</b>		<b>3497X</b>	<b>W5731 S-530</b>
<b>1200cc Big Bore Comp 9.5:1</b>			1207	3.508"/.010		<b>K1656</b>	<b>4718P1</b>	<b>3507X</b>		
Cylinder Boring Required			1214	3.518"/.020		<b>K1657</b>	<b>4718P2</b>	<b>3517X</b>		
No cylinder head modification required			1221	3.528"/.030		<b>K1658</b>	<b>4718P3</b>			
'08-Up models must use Sportster 1200cc cylinders			1228	3.538"/.040		<b>K1659</b>	<b>4718P4</b>			
ArmorGlide™ skirt coated	'86-87				<b>W5911</b>					
Gasket Kit, Big Bore (Required)	'88-90				<b>W5912</b>					
	'91-03				<b>W5918</b>					
	'04-17				<b>W6378</b>					
<b>883 Evo Sportster</b>	'86-17	73	1200	3.498"/Std	3.812"	<b>K1682</b>	<b>4719PS</b>		<b>3497X</b>	<b>W5731 S-530</b>
<b>1200cc Big Bore Comp 10.0:1</b>			1207	3.508"/.010		<b>K1683</b>	<b>4719P1</b>	<b>3507X</b>		
Cylinder Boring Required			1214	3.518"/.020		<b>K1684</b>	<b>4719P2</b>	<b>3517X</b>		
No cylinder head modification required										
ArmorGlide™ skirt coated										
Gasket Kit, Big Bore (Required)	'86-87				<b>W5911</b>					
	'88-90				<b>W5912</b>					
	'91-03				<b>W5918</b>					
	'04-17				<b>W6378</b>					

- WINDSHIELDS / FAIRINGS
- AUDIO / COMMUNICATION
- SEATS / LUGGAGE
- BAR / MIRRORS / CONTROLS
- EXHAUST
- AIR / FUEL SYSTEMS
- ENGINE**
- TRANSMISSION / DRIVELINE
- GASKETS / SEALS
- ELECTRICAL
- LIGHTING
- CABLES
- BRAKES
- OIL FILTERS
- SUSPENSION
- BODY
- WHEELS
- TIRES / TIRE ACC.
- BIKE ACC.
- VICTORY / INDIAN
- COVERS / LOCKS / TIEDOWNS
- CHEMICALS
- TOOLS
- HELMETS
- HELMET ACC.
- EYEWEAR
- APPAREL / RIDER ACC.
- PROMOTIONAL
- REFERENCE
- INDEX



WINDSHIELDS / FAIRINGS  
AUDIO / COMMUNICATION  
SEATS / LUGGAGE  
BARS / MIRRORS / CONTROLS  
EXHAUST  
AIR / FUEL SYSTEMS  
**ENGINE**  
TRANSMISSION / DRIVELINE  
GASKETS / SEALS  
ELECTRICAL  
LIGHTING  
CABLES  
BRAKES  
OIL FILTERS  
SUSPENSION  
BODY  
WHEELS  
TIRES / TIRE ACC.  
BIKE ACC.  
VICTORY / INDIAN  
COVERS / LOCKS / TIEDOWNS  
CHEMICALS  
TOOLS  
HELMETS  
HELMET ACC.  
EYEWEAR  
APPAREL / RIDER ACC.  
PROMOTIONAL  
REFERENCE  
INDEX

Application	Year	Disp. ci	Disp. cc	Bore Size	Stroke	Piston Kits WPS #	Replacement			
							Piston	Rear Piston	Ring Set	Circlips & Wrist Pin
<b>HARLEY-DAVIDSON® (cont'd...)</b>										
<b>1100 Evo Sportster</b>	'86-87	73	1200	3.498"/Std	3.812"	<b>K1660</b>	<b>4720PS</b>		<b>3497X</b>	<b>W5731</b>
<b>1200 Evo Sportster</b>	'88-03		1207	3.508"/.010		<b>K1661</b>	<b>4720P1</b>		<b>3507X</b>	<b>S-530</b>
Comp 9:1 No cylinder head modification required			1214	3.518"/.020		<b>K1662</b>	<b>4720P2</b>		<b>3517X</b>	
Gasket Kit	'86-87					<b>W5911</b>				
	'88-90					<b>W5912</b>				
	'91-03					<b>W5918</b>				
<b>1100 Evo Sportster</b>	'86-87	73	1200	3.498"/Std	3.812"	<b>K1685</b>	<b>4721PS</b>		<b>3497X</b>	<b>W5731</b>
<b>1200 Evo Sportster</b>	'88-03		1207	3.508"/.010		<b>K1686</b>	<b>4721P1</b>		<b>3507X</b>	<b>S-530</b>
Comp 10.5:1 No cylinder head modification required			1214	3.518"/.020		<b>K1687</b>	<b>4721P2</b>		<b>3517X</b>	
Gasket Kit	'86-87		1221	3.528"/.030		<b>K1688</b>	<b>4721P3</b>			
	'88-90					<b>W5911</b>				
	'91-03					<b>W5912</b>				
						<b>W5918</b>				
<b>1200 Evo Sportster</b>	'04-16	73	1200	3.498"/Std	3.812"	<b>K1746</b>	<b>4891PS</b>		<b>3497X</b>	<b>W5731</b>
Comp 10.5:1 ArmorGlide™ skirt coated			1207	3.508"/.010		<b>K1747</b>	<b>4891P1</b>		<b>3507X</b>	
Gasket Kit	'04-16		1214	3.518"/.020		<b>K1748</b>	<b>4891P2</b>		<b>3517X</b>	
						<b>W6378</b>				
<b>1200 Evo Sportster</b>	'04-16	88	1426	3.8125"	3.812"	<b>K1735</b>	<b>4830PS</b>		<b>38125XN</b>	<b>W5731</b>
88 Big Bore Comp 10.5:1 Must use aftermarket big bore cylinders Crankcase Boring Required										<b>S-572</b>
Gasket Kit, Big Bore (Required)	'04-17					<b>W6003</b>				
<b>1340 Evo Big Twin</b>	'84-99	80	1340	3.498"/Std	4.250"	<b>K1640</b>	<b>4722PS</b>		<b>3497X</b>	<b>W5731</b>
Comp 8.5:1 (9.5:1 with SE heads) ArmorGlide™ skirt coated			1345	3.508"/.010		<b>K1641</b>	<b>4722P1</b>		<b>3507X</b>	
			1353	3.518"/.020		<b>K1642</b>	<b>4722P2</b>		<b>3517X</b>	
			1361	3.528"/.030		<b>K1643</b>	<b>4722P3</b>			
			1369	3.538"/.040		<b>K1644</b>	<b>4722P4</b>			
<b>1340 Evo Big Twin</b>	'84-99	80	1340	3.498"/Std	4.250"	<b>K1665</b>	<b>4724PS</b>	<b>4725PS</b>	<b>3497X</b>	<b>W5731</b>
Comp 10:1 ArmorGlide™ skirt coated			1342	3.503"/.005		<b>K1675</b>	<b>4724P05</b>	<b>4725P05</b>	<b>3504X</b>	
			1345	3.508"/.010		<b>K1666</b>	<b>4724P1</b>		<b>3507X</b>	
			1353	3.518"/.020		<b>K1667</b>	<b>4724P2</b>		<b>3517X</b>	
			1361	3.528"/.030		<b>K1668</b>	<b>4724P3</b>	<b>4725P3</b>		
<b>Twin Cam 88</b>	'99-06	88	1448	3.750"/Std	4.000"	<b>K2726</b>	<b>4995PS</b>		<b>3750VM</b>	<b>W5752</b>
Comp 10.5:1 ArmorGlide™ skirt coated NEW VM Ring technology									<b>S-594</b>	
<b>Twin Cam 88</b>	'99-06	95	1546	3.875"/ STD	4.000"	<b>VT2719</b>	<b>4994PS</b>		<b>3875VM</b>	<b>W5752</b>
95 Big Bore Comp 9:1 ArmorGlide™ skirt coated			1550	3.880"/.005		<b>VT2720</b>	<b>4994P005</b>		<b>3880VM</b>	<b>S-594</b>
NEW VM Ring technology Gasket Kit, Big Bore (Included)			1554	3.885"/.010		<b>VT2721</b>	<b>4994P1</b>		<b>3885VM</b>	
						<b>W5786</b>				
<b>Twin Cam 88</b>	'99-06	95	1546	3.875"/ STD	4.000"	<b>VT2764</b>	<b>4999PS</b>		<b>3875VM</b>	<b>W5752</b>
95 Big Bore Comp 9.5:1 ArmorGlide™ skirt coated			1550	3.880"/.005		<b>VT2766</b>	<b>4999P1</b>		<b>3885VM</b>	<b>S-594</b>
Gasket Kit, Big Bore (Included)						<b>W5786</b>				
<b>Twin Cam 88</b>	'99-06	95	1546	3.875"/ STD	4.000"	<b>VT2709</b>	<b>4993PS</b>		<b>3875VM</b>	<b>W5752</b>
95 Big Bore Comp 10.5:1 ArmorGlide™ skirt coated			1550	3.880"/.005		<b>VT2710</b>	<b>4993P005</b>		<b>3880VM</b>	<b>S-594</b>
NEW VM Ring technology Gasket Kit, Big Bore (Included)			1554	3.885"/.010		<b>VT2711</b>	<b>4993P1</b>		<b>3885VM</b>	
				3.895"/.020		<b>VT2712</b>	<b>4993P2</b>		<b>3895VM</b>	
						<b>W5786</b>				
<b>Twin Cam 88</b>	'99-17	100	1650	4.000"	4.000"	<b>VT1760</b>	<b>4925PS</b>		<b>4000GFX</b>	<b>W5752</b>
<b>Twin Cam 96 with 4.000" Stroke Crank</b>									<b>S-594</b>	
100 Big Bore Comp 10.5:1 Resleeving or Big Bore Cylinders required Crankcase Boring Required										
ArmorGlide™ skirt coated NEW VM Ring technology Gasket Kit, Big Bore (Included)						<b>W6274</b>				



Application	Year	Disp. ci	Disp. cc	Bore Size	Stroke	Piston Kits WPS #	Replacement			Circlips & Wrist Pin
							Piston	Rear Piston	Ring Set	
<b>HARLEY-DAVIDSON® (CONT'D...)</b>										
<b>Twin Cam 88 with 4.375" Stroke Crank</b>	'99-17	103	1691	3.875"/.125	4.375"	<b>K2751</b>	<b>4996PS</b>		<b>3875VM</b>	<b>W5752</b>
<b>Twin Cam 96, 103</b> 103 Big Bore Comp 9:1 Cylinder Boring Required for TC88 & TC96 ArmorGlide™ skirt coated NEW VM Ring technology Gasket Kit, Big Bore (Required)			1700	3.885"/.135		<b>K2753</b>	<b>4996P1</b>		<b>3885VM</b>	<b>S-594</b>
<b>Twin Cam 88 with 4.375" Stroke Crank</b>	'99-17	103	1691	3.875"/.125	4.375"	<b>W5786</b>				
<b>Twin Cam 96, 103</b> 103 Big Bore Comp 9.6:1 Cylinder Boring Required for TC88 & TC96 ArmorGlide™ skirt coated NEW VM Ring technology Gasket Kit, Big Bore (Included)			1700	3.885"/.135		<b>VT2761</b>	<b>4998PS</b>		<b>3875VM</b>	<b>W5752</b>
<b>Twin Cam 88 with 4.375" Stroke Crank</b>	'99-17	103	1691	3.875"/.125	4.375"	<b>VT2763</b>	<b>4998P1</b>		<b>3885VM</b>	<b>S-594</b>
<b>Twin Cam 96, 103</b> 103 Big Bore Comp 10.5:1 Cylinder Boring Required for TC88 & TC96 ArmorGlide™ skirt coated NEW VM Ring technology Gasket Kit, Big Bore (Included)			1695	3.880"/.130		<b>W5786</b>				
<b>Twin Cam 88 with 4.375" Stroke Crank</b>	'99-17	103	1691	3.875"/.125	4.375"	<b>VT2754</b>	<b>4997PS</b>		<b>3875VM</b>	<b>W5752</b>
<b>Twin Cam 96, 103</b> 103 Big Bore Comp 10.5:1 Cylinder Boring Required for TC88 & TC96 ArmorGlide™ skirt coated NEW VM Ring technology Gasket Kit, Big Bore (Included)			1700	3.885"/.135		<b>VT2755</b>	<b>4997P005</b>		<b>3885VM</b>	<b>S-594</b>
<b>Twin Cam 88</b>	'99-17	107	1752	4.125"	4.000"	<b>W5786</b>				
<b>Twin Cam 96, 103 with 4.000" Stroke Crank</b> 107 Big Bore Comp 10.5:1 Resleeving or Big Bore Cylinders required Crankcase Boring Required ArmorGlide™ skirt coated NEW VM Ring technology Gasket Kit, Big Bore (Included)						<b>VT1759</b>	<b>4923PS</b>		<b>4127GFX</b>	<b>W5752</b>
<b>Twin Cam 88 with 4.375" Stroke Crank</b>	'99-17	110	1802	4.000"	4.375"	<b>W6438</b>				
<b>Twin Cam 96, 103</b> 110 Big Bore Comp 10.5:1 Resleeving or Big Bore Cylinders required Crankcase Boring Required ArmorGlide™ skirt coated NEW VM Ring technology Gasket Kit, Big Bore (Included)						<b>VT1757</b>	<b>4918PS</b>		<b>4000GFX</b>	<b>W5752</b>
<b>Twin Cam 88 with 4.375" Stroke Crank</b>	'99-17	117	1917	4.125"	4.375"	<b>W6274</b>				
<b>Twin Cam 96, 103</b> 117 Big Bore Comp 10.5:1 Crankcase Boring Required Big Bore Cylinders required ArmorGlide™ skirt coated NEW VM Ring technology Gasket Kit, Big Bore (Included)						<b>VT2767</b>	<b>40018PS</b>		<b>4125VM</b>	<b>W5752</b>
<b>M8 Big Bore</b> M8 Compression 11:1 ArmorX piston coating ArmorFit skirt coated Gasket Kit, Sold Separately	'17-Up	124	2032	4.250"		<b>W6438</b>				
						<b>K2787</b>				

- WINDSHIELDS / FAIRINGS
- AUDIO / COMMUNICATION
- SEATS / LUGGAGE
- BARS / MIRRORS / CONTROLS
- EXHAUST
- AIR / FUEL SYSTEMS
- ENGINE
- TRANSMISSION / DRIVELINE
- GASKETS / SEALS
- ELECTRICAL
- LIGHTING
- CABLES
- BRAKES
- OIL FILTERS
- SUSPENSION
- BODY
- WHEELS
- TIRES / TIRE ACC.
- BIKE ACC.
- VICTORY / INDIAN
- COVERS / LOCKS / TIEDOWNS
- CHEMICALS
- TOOLS
- HELMETS
- HELMET ACC.
- EYEWEAR
- APPAREL / RIDER ACC.
- PROMOTIONAL
- REFERENCE
- INDEX



PISTON RINGS



	x	X
Description	Moly	Cast
<b>FOR TWIN CAM 88</b>		
STD Size	865-02000	-
.005" Oversize	865-02001	-
.010" Oversize	865-02002	-
<b>FOR 1340 EVO AND 1200 XL '86-04</b>		
STD Size	865-02003	865-02008
.005" Oversize	865-02004	865-02009
.010" Oversize	865-02005	865-02010
.020" Oversize	865-02006	865-02011
.030" Oversize	865-02007	865-02012
<b>FOR 883 XL '86-04</b>		
STD Size	865-02013	-
.005" Oversize	865-02014	-
.010" Oversize	865-02015	-
<b>FOR 1340 SHOVEL</b>		
STD Size	865-02016	865-02021
.010" Oversize	865-02017	865-02022
.020" Oversize	865-02018	865-02023
.030" Oversize	865-02019	865-02024
.040" Oversize	865-02020	865-02025
<b>FOR 1200 SHOVEL</b>		
STD Size	865-02026	865-02031
.010" Oversize	865-02027	865-02032
.020" Oversize	865-02028	865-02033
.030" Oversize	865-02029	865-02034
.040" Oversize	865-02030	865-02035



PISTONS

Description	WPS#
<b>1340CC EVOLUTION BIG TWIN</b>	
Stock Compression 8.5:1 Size STD	820-70100
Stock Compression 8.5:1 Size +.005	820-70101
Stock Compression 8.5:1 Size +.010	820-70102
Stock Compression 8.5:1 Size +.020	820-70103
Stock Compression 8.5:1 Size +.030	820-70104
<b>1200CC EVOLUTION SPORTSTER '86-04</b>	
High Compression 9:1 Size STD	820-70105
High Compression 9:1 Size +.005	820-70106
High Compression 9:1 Size +.010	820-70107
High Compression 9:1 Size +.020	820-70108
High Compression 9:1 Size +.030	820-70109

Description	WPS#
<b>1340CC SHOVELHEAD</b>	
High Compression 8:1 Size STD	820-70110
High Compression 8:1 Size +.010	820-70111
High Compression 8:1 Size +.020	820-70112
High Compression 8:1 Size +.030	820-70113
High Compression 8:1 Size +.040	820-70114
<b>1200CC SHOVELHEAD</b>	
High Compression 8.5:1 Size STD	820-70115
High Compression 8.5:1 Size +.010	820-70116
High Compression 8.5:1 Size +.020	820-70117
High Compression 8.5:1 Size +.030	820-70118
High Compression 8.5:1 Size +.040	820-70119

- WINDSHIELDS / FAIRINGS
- AUDIO / COMMUNICATION
- SEATS / LUGGAGE
- BAR / MIRRORS / CONTROLS
- EXHAUST
- AIR / FUEL SYSTEMS
- ENGINE
- TRANSMISSION / DRIVELINE
- GASKETS / SEALS
- ELECTRICAL
- LIGHTING
- CABLES
- BRAKES
- OIL FILTERS
- SUSPENSION
- BODY
- WHEELS
- TIRES / TIRE ACC.
- BIKE ACC.
- VICTORY / INDIAN
- COVERS / LOCKS / TIEDOWNS
- CHEMICALS
- TOOLS
- HELMETS
- HELMET ACC.
- EYEWEAR
- APPAREL / RIDER ACC.
- PROMOTIONAL
- REFERENCE
- INDEX



## WRIST PIN BUSHING

x

x

Description	Size	Application	WPS#
Engine Builders series wrist pin bushing (1pair)	1.0190"	'05-17 Twin Cam models	<b>191-57080</b> *
Engine Builders series wrist pin bushing (1)	STD. O.D.	'48-99 EVO Big Twin	<b>191-57081</b>
Engine Builders series wrist pin bushing (1)	+0.002" O.D.	'48-99 EVO Big Twin	<b>191-57082</b>
Engine Builders series wrist pin bushing (1)	STD. O.D.	'57-17 EVO Sportster	<b>191-57083</b>
Engine Builders series wrist pin bushing (1)	+0.002" O.D.	'57-17 EVO Sportster	<b>191-57084</b>



## PISTON RINGS



Description	Chrome	Cast
<b>FOR TWIN CAM 88</b>		
STD Size	<b>865-01300</b>	-
.005" Oversize	<b>865-01301</b>	-
.010" Oversize	<b>865-01302</b>	-
<b>FOR 1340 EVO AND 1200 XL '86-04</b>		
STD Size	<b>865-01320</b>	<b>865-01330</b>
.005" Oversize	<b>865-01321</b>	<b>865-01331</b>
.010" Oversize	<b>865-01322</b>	<b>865-01332</b>
.020" Oversize	<b>865-01323</b>	<b>865-01333</b>
.030" Oversize	<b>865-01324</b>	<b>865-01334</b>
<b>FOR 883 XL '86-04</b>		
STD Size	<b>865-01340</b>	-
.005" Oversize	<b>865-01341</b>	-
.010" Oversize	<b>865-01342</b>	-

Description	Chrome	Cast
<b>FOR 1340 SHOVEL</b>		
STD Size	<b>865-01350</b>	<b>865-01360</b>
.010" Oversize	<b>865-01351</b>	<b>865-01361</b>
.020" Oversize	<b>865-01352</b>	<b>865-01362</b>
.030" Oversize	<b>865-01353</b>	<b>865-01363</b>
.040" Oversize	<b>865-01354</b>	<b>865-01364</b>
<b>FOR 1200 SHOVEL</b>		
STD Size	<b>865-01370</b>	<b>865-01380</b>
.010" Oversize	<b>865-01371</b>	<b>865-01381</b>
.020" Oversize	<b>865-01372</b>	<b>865-01382</b>
.030" Oversize	<b>865-01373</b>	<b>865-01383</b>
.040" Oversize	<b>865-01374</b>	<b>865-01384</b>

- WINDSHIELDS / FAIRINGS
- AUDIO / COMMUNICATION
- SEATS / LUGGAGE
- BAR / MIRRORS / CONTROLS
- EXHAUST
- AIR / FUEL SYSTEMS
- ENGINE**
- TRANSMISSION / DRIVELINE
- GASKETS / SEALS
- ELECTRICAL
- LIGHTING
- CABLES
- BRAKES
- OIL FILTERS
- SUSPENSION
- BODY
- WHEELS
- TIRES / TIRE ACC.
- BIKE ACC.
- VICTORY / INDIAN
- COVERS / LOCKS / TIEDOWNS
- CHEMICALS
- TOOLS
- HELMETS
- HELMET ACC.
- EYEWEAR
- APPAREL / RIDER ACC.
- PROMOTIONAL
- REFERENCE
- INDEX



# CYLINDERS

- Aluminum cylinders with cast iron sleeves for Evo and Sportster applications
- Cast iron cylinders for Pan and Shovel applications
- All cylinders must be finish honed and matched to pistons (sold separately)
- Ideal for stock replacement or displacement increase on Sportsters or big bore Shovels
- Sold each



Front

A



Rear



Front

B



Rear



Front

C



Rear



Front

D



Rear



Front

E



Rear



Front

F



Rear

Description	Front	Rear
A 74" Panhead Cylinder	820-51550	820-51551
B 74" Shovelhead Cylinder	820-51552	820-51553
C 80" Shovelhead Cylinder	820-51554	820-51555
D 3-5/8 Bore Shovelhead Cylinder	820-51556	820-51557
E 80" Evolution Cylinder (natural finish)	820-51558	820-51558
F XL 1200 Cylinder (natural finish)	820-51559	820-51559

**NEW TWIN CAM / M8 CYLINDERS**



- Twin Cam cylinders come powder coated black with machined fins for that OEM look
- Twin Cam cylinders sold each
- M8 cylinders for Wiseco pistons (K2787)
- M8 big bore cylinders sold as pair
- Gaskets purchased separately

Description	Application	WPS#
A Big Bore Cylinder BLK/Machined	M8 124 CI	<b>820-51548</b>
B STD Bore Cylinder BLK/Machined	TC 88/96	<b>820-51549</b>
Wiseco Big Bore Piston Kit	M8 124 CI	<b>K2787</b>

**NEW CONNECTING ROD ASSY**



- Heavy Duty Replacement
- Meets or Exceeds OEM Specs
- Comes with Crank Pin and Nut

Description	Application	WPS#
ConRod Assy w/Crank pin & nut	41-73 Big Twin	<b>820-58004</b>
ConRod Assy w/Crank pin & nut	74-E81 Big Twin	<b>820-58005</b>
ConRod Assy	81-E83 Big Twin	<b>820-58006</b>
ConRod Assy	84 Big Twin	<b>820-58007</b>
ConRod Assy	81-E83 Big Twin	<b>820-58008</b>
ConRod Assy w/Crank pin & nut	57-80 XL	<b>820-58009</b>
ConRod Assy w/Crank pin & nut	81-85 XL	<b>820-58010</b>
ConRod Assy w/Crank pin & nut	86-99 XL	<b>820-58011</b>
CRANK PIN/ROLLERS		
Crank Pin Large Hole	41-E84 Big Twin	<b>820-58000</b>
Rod Roller & Retainer Assy	41-Up OHV 74&80	<b>820-58001</b>
Crank Pin Large Hole	54-E84 XL	<b>820-58002</b>
Rod Roller & Retainer Assy	54-86 XL	<b>820-58003</b>
ConRod Bearing Race Set		<b>820-58012</b>
Crank Pin	81-99 Big Twin	<b>820-58020</b>

WINDSHIELDS / FAIRINGS

AUDIO / COMMUNICATION

SEATS / LUGGAGE

BAR / MIRRORS / CONTROLS

EXHAUST

AIR / FUEL SYSTEMS

**ENGINE**

TRANSMISSION / DRIVELINE

GASKETS / SEALS

ELECTRICAL

LIGHTING

CABLES

BRAKES

OIL FILTERS

SUSPENSION

BODY

WHEELS

TIRES / TIRE ACC.

BIKE ACC.

VICTORY / INDIAN

COVERS / LOCKS / TIEDOWNS

CHEMICALS

TOOLS

HELMETS

HELMET ACC.

EYEWEAR

APPAREL / RIDER ACC.

PROMOTIONAL

REFERENCE

INDEX



# INTAKE AND EXHAUST VALVES

## Black Diamond® Valves:

All KPMI Black Diamond® stainless steel valves are impregnated by a special German process to a depth of .002", with a surface build up of .0002". This "Black Diamond®" process improves wear properties, reduces friction, and provides resistance to corrosion and wear that is superior to chrome and nickel electrolysis plating. Black Diamond® Valves are light, strong, one-piece forgings with profiles that provide excellent flow characteristics.



Application	Year	Valve	Head Dia.	Stem Dia	Tulip	Length	OEM#	WPS#
<b>HARLEY DAVIDSON</b>								
Milwaukee 8 107"-114"	'17-Up	Intake (standard)	1.571"	0.2347"	10°	4.015"	18000016	<b>191-17040</b>
		Exhaust (standard)	1.264"	0.2342"	24°	4.050"	18000034	<b>191-17043</b>
		Intake (oversized)	1.591"	0.2347"	10°	4.015"		<b>191-17041</b>
		Exhaust (oversized)	1.284"	0.2342"	24°	4.050"		<b>191-17044</b>
		Intake (X-large)	1.630"	0.2347"	10°	4.055"		<b>191-17042</b>
		Exhaust (standard) "Inconel"	1.264"	0.2342"	24°	4.050"		<b>191-17045</b>
Twin Cam 88"-103"	'05-17	Intake (standard)	1.805"	0.2760"	1.700"R	4.420"	18074-05	<b>191-17011</b>
		Exhaust (standard)	1.575"	0.2755"	22°	4.520"	18085-05	<b>191-17012</b>
		Intake (oversized)	1.900"	0.2760"	28°	4.520"		<b>191-17024</b>
		Exhaust (oversized)	1.630"	0.2755"	34°	4.520"		<b>191-17017</b>
		Intake (standard) "Fat Stems"	1.805"	0.281	1.700"R	4.415"		<b>191-17032</b>
		Exhaust (standard) "Fat Stems"	1.575"	0.2805	23°	4.510"		<b>191-17033</b>
Twin Cam 88"	'99-04	Intake (standard)	1.840"	0.3100"	23°	4.445"	18074-83A	<b>191-17009</b>
		Exhaust (standard)	1.615"	0.3100"	17°	4.505"	18085-99	<b>191-17010</b>
Evolution	'84-99	Intake (standard)	1.840"	0.3100"	23°	4.445"	18082-83	<b>191-17001</b>
		Exhaust (standard)	1.615"	0.3096"	29°	4.525"	18074-83B	<b>191-17002</b>
		Intake (oversized)	1.900"	0.3100"	28°	4.420"		<b>191-17018</b>
		Exhaust (oversized)	1.630"	0.3096"	40°	4.525"		<b>191-17014</b>
Shovelhead 80"	'66-83	Intake (standard)	1.950"	0.3765"	23°	3.885"	18078-80	<b>191-17003</b>
		Exhaust (standard)	1.750"	0.3760"	29°	3.810"	18082-57	<b>191-17004</b>
		Intake (oversized)	2.000"	0.3765"	23°	3.885"		<b>191-17019</b>
		Exhaust (oversized)	1.780"	0.3760"	29°	3.820"		<b>191-17027</b>
Panhead	'48-65	Intake (standard)	1.750"	0.3765"	23°	3.790"	18070-48	<b>191-17013</b>
		Exhaust (standard)	1.750"	0.3760"	29°	3.810"	18082-57	<b>191-17004</b>
Sportster	'57-69	Intake (standard)	1.825"	0.3095"	23°	3.512"	18071-58	<b>191-17023</b>
		Exhaust (standard)	1.570"	0.3884"	29°	3.512"	18080-58R	<b>191-17015</b>
		Exhaust (oversized)	1.630"	0.3884"	29°	3.512"		<b>191-17016</b>
	'70-83	Intake (standard)	1.950"	0.3090"	23°	3.690"	18069-65R	<b>191-17020</b>
		Intake (standard)	1.935"	0.390"	23°	3.620"	18070-70	<b>191-17021</b>
		Intake (oversized)	2.000"	0.3090"	23°	3.620"		<b>191-17022</b>
Sportster 883cc	'86-03	Exhaust (standard)	1.570"	0.3884"	29°	3.512"	18080-58R	<b>191-17015</b>
		Exhaust (oversized)	1.630"	0.3884"	29°	3.512"		<b>191-17016</b>
	'04-17	Intake (standard)	1.585"	0.3100"	23°	4.550"	18031-86	<b>191-17005</b>
		Exhaust (standard)	1.350"	0.3095"	17°	4.640"	18030-86	<b>191-17006</b>
Sportster 1200cc	'86-03	Intake (conversion)	1.715"	0.755"	23°	4.580"		<b>191-17026</b>
		Exhaust (conversion)	1.480"	0.2755"	40°	4.660"		<b>191-17025</b>
	'04-17	Intake (standard)	1.740"	0.3100"	23°	4.580"	18023-87	<b>191-17007</b>
		Exhaust (standard)	1.475"	0.3096"	44°	4.625"	18082-83	<b>191-17008</b>
Sportster 1200cc	'04-17	Intake (standard)	1.805"	0.2760"	23°	4.525"		<b>191-17028</b>
		Exhaust (standard)	1.575"	0.2755"	23°	4.610"		<b>191-17030</b>
		Intake (oversized)	1.900"	0.2760"	28°	4.500"		<b>191-17029</b>
		Exhaust (oversized)	1.630"	0.2755"	34°	4.590"		<b>191-17031</b>

## VALVE SEATS

Kibblewhite's proprietary seat material is compatible with leaded and unleaded fuels including methanol and ethanol fuel blends. This material offers excellent thermal characteristics and resists microwelding that leads to seat and valve face recession. Leading edge has generous radius to ease installation.



Application	Inside Diameter	Outside Diameter	Height	WPS#
'84-16 Big Twin models, '86-87 XL 1100cc and '04-17 Sporster	1.375"	1.757"	0.450"	<b>191-57092</b>
	1.535"	1.969"	0.453"	<b>191-57093</b>
	1.562"	2.007"	0.450"	<b>191-57094</b>
	1.690"	2.132"	0.450"	<b>191-57095</b>



# VALVE SPRINGS



## KPMI Valve Springs:

Wound from Premium Kobe Super-Clean Chrome Silicon Wire. KPMI valve springs are heat-treated, stress relieved and shot peened to insure maximum performance and life.

Springs are engineered for each specific application using proprietary advanced spring design simulation, and analysis software. Engineers pay special attention to cam and spring harmonics, stress, mass and operating rpm.

- Part numbers ending with (S) use steel retainers
- Part numbers ending with (T) use titanium retainers



Application	Year	Description	Valve Spring Kit
Milwaukee 8	'17-Up	Beehive Valve Spring kit .465 lift (titanium retainers)	<b>191-27020</b>
Milwaukee 8	'17-Up	Beehive Valve Spring kit .465 lift (steel retainers)	<b>191-27021</b>
Milwaukee 8	'17-Up	Beehive Valve Spring kit .550 lift	<b>191-27022</b>
Twin cam	'05-17	Beehive Valve Spring kit .600 lift	<b>191-27013S</b>
Twin Cam	'05-17	Racing Valve Spring kit .600 lift	<b>191-27004S</b>
Twin Cam	'99-04	Racing Valve Spring kit .600 lift	<b>191-27003S</b>
Twin Cam	'99-04	Beehive Valve Spring kit .600 lift	<b>191-27006S</b>
Twin Cam	'99-04	Beehive Valve Spring kit .630 lift	<b>191-27008S</b>
Twin Cam	'99-04	Beehive Valve Spring kit .655 lift	<b>191-27009T</b>
Twin Cam	'99-04	Racing Valve Spring kit .600 lift	<b>191-27007T</b>
Twin Cam	'99-04	Racing Valve Spring kit .655 lift	<b>191-27010S</b>
Evo Big Twin	'84-99	Racing Valve Spring kit .600 lift	<b>191-27007T</b>
Evo Big Twin	'84-99	Beehive Valve Spring kit .630 lift	<b>191-27008S</b>

Application	Year	Description	Valve Spring Kit
Evo Big Twin	'84-99	Beehive Valve Spring kit .600 lift	<b>191-27006S</b>
Evo Big Twin	'84-99	Beehive Valve Spring kit .655 lift	<b>191-27009T</b>
Evo Big Twin	'84-99	Racing Valve Spring kit .655 lift	<b>191-27010S</b>
Evo Sportster	'04-17	Racing Valve Spring kit .600 lift	<b>191-27004S</b>
Evo Sportster	'04-17	Racing Valve Spring kit .600 lift	<b>191-27014T</b>
Evo Sportster	'04-17	Beehive Valve Spring kit .600 lift	<b>191-27013S</b>
Evo Sportster	'04-17	Beehive Valve Spring kit .630 lift	<b>191-27015S</b>
Evo Sportster	'86-03	Beehive Valve Spring kit .600 lift	<b>191-27006S</b>
Evo Sportster	'86-03	Racing Valve Spring kit .600 lift	<b>191-27007T</b>
Evo Sportster	'86-03	Beehive Valve Spring kit .630 lift	<b>191-27008S</b>
Evo Sportster	'86-03	Beehive Valve Spring kit .655 lift	<b>191-27009T</b>
Evo Sportster	'86-03	Racing Valve Spring kit .655 lift	<b>191-27010S</b>
Shovelhead	'66-83	OEM replacement spring kit .415 lift	<b>191-27001S</b>
Shovelhead	'66-83	Racing Valve Spring kit .600 lift	<b>191-27012S</b>
Panhead	'48-65	OEM replacement spring kit .415 lift	<b>191-27011T</b>

## OEM REPLACEMENT SEALS AND INSTALLATION TOOL

Application	Seals	4 pack
Evolution	OEM replacement seals 0.420" 5/16" stem diameter	<b>191-37023</b>
Ironhead Sportster intake	OEM replacement seals 0.530" 5/16" stem diameter	<b>191-37025</b>
Ironhead Sportster exhaust	OEM replacement seals 0.530" 11/32" stem diameter	<b>191-37027</b>
Panhead & Shovelhead 74"	OEM replacement seals 0.562" 3/8" stem diameter	<b>191-37029</b>
Shovelhead 80"	OEM replacement seals 0.625" 3/8" stem diameter	<b>191-37031</b>
<b>APPLICATION</b>		
Panhead & Shovelhead 74"	fits: 191-37008	<b>191-37040</b>
<b>APPLICATION</b>		
Evolution and Ironhead Sportster intake	5/16" stem diameter	<b>191-37045</b> <b>191-37042</b>
Ironhead Sportster exhaust	11/32" stem diameter	<b>191-37046</b> <b>191-37043</b>
Panhead & Shovelhead 74" & 80"	3/8" stem diameter	<b>191-37047</b> <b>191-37044</b>
<b>APPLICATION</b>		
Evo/Twin Cam Big Twin '84-04, EVO Sportster '86-03	O.E.M style (4 pairs)	<b>191-27788</b>
Twin Cam '04-17	O.E.M for all 7mm (1 pair)	<b>191-57091</b>

## M8 VALVE KEEPERS



- OEM Style valve keepers for Milwaukee 8 engines, sold in a pack of eight.



Application	Year	WPS#
Milwaukee 8	'17-Up	<b>191-27030</b>

WINDSHIELDS / FAIRINGS  
 AUDIO / COMMUNICATION  
 SEATS / LUGGAGE  
 BARS / MIRRORS / CONTROLS  
 EXHAUST  
 AIR / FUEL SYSTEMS  
**ENGINE**  
 TRANSMISSION / DRIVELINE  
 GASKETS / SEALS  
 ELECTRICAL  
 LIGHTING  
 CABLES  
 BRAKES  
 OIL FILTERS  
 SUSPENSION  
 BODY  
 WHEELS  
 TIRES / TIRE ACC.  
 BIKE ACC.  
 VICTORY / INDIAN  
 COVERS / LOCKS / TIEDOWNS  
 CHEMICALS  
 TOOLS  
 HELMETS  
 HELMET ACC.  
 EYEWEAR  
 APPAREL / RIDER ACC.  
 PROMOTIONAL  
 REFERENCE  
 INDEX



# VALVE GUIDES AND VALVE STEM SEALS



## KPMI Bronze Valve Guides:

We choose to use C630 nickel bronze as a material to make valve guides because of its ideal characteristics for the application. The 4-5 percent nickel content provides superior resistance to wear, and the approximately 80 percent copper content delivers outstanding heat conductivity. Guide profiles are designed to have minimal effect on the airstream while maintaining critical cross sectional thickness in high temperature areas, promoting high performance and endurance. The top portion of the guides are shortened when cam lift information available at the time of design shows that additional retainer to seal clearance is required.



## KPMI Cast Iron Valve Guides:

KPMI R&D has produced a proprietary cast iron blend that thrives in the tough operating conditions of today's engines. KPMI's certified cast iron provides excellent wear resistance and a superior guide bore finish that is easy on valve stems.



## KPMI Valve Stem Seals "The Red Ones":

KPMI Red Viton® valve stem seals are designed to have optimum fitment, allow for maximum lift, and to give maximum life. KPMI Red valve stem seals are resistant to high temperatures, petroleum products and by-products of combustion. They retain their ability to seal in situations where other materials could allow oil to enter the combustion chamber causing detonation, carbon build up and a loss of power. The Red Ones are truly the racer's choice.

Application	Year	Type and Size	C630 Bronze Valve Guides	Cast Iron Valve Guides	Valve Stem Seals (Sold as Pks of 4)
<b>HARLEY DAVIDSON</b>					
Milwaukee 8 107"-114"	'17-Up	Intake Std. 0.475"	191-57070	191-57070C	191-37032
		Intake +0.001	191-57071	191-57071C	191-37032
		Intake +0.002	191-57072	191-57072C	191-37032
		Exhaust Std. 0.475"	191-57074	191-57074C	191-37032
		Exhaust +0.001	191-57075	191-57075C	191-37032
		Exhaust +0.002	191-57076	191-57076C	191-37032
		Intake +0.010	191-57073	191-57073C	
		Exhaust +0.010	191-57077	191-57077C	
Twin Cam 88"-103"	'05-17	Intake Std. 0.5620"	191-57009	191-57009C	191-37022
		Intake +0.001	191-57010	191-57010C	191-37022
		Intake +0.002	191-57050	191-57050C	191-37022
		Exhaust Std. 0.5620"	191-57011	191-57011C	191-37022
		Exhaust +0.001	191-57012	191-57012C	191-37022
		Exhaust +0.002	191-57027	191-57027C	191-37022
		Intake +0.010		191-57059C	
		Exhaust +0.010	191-57061	191-57062C	
Twin Cam 88" (One seal included with each guide)	'99-04	Intake Std. 0.5620"	191-57005		
		Intake +0.001	191-57006		
		Exhaust Std. 0.5620"	191-57007		
		Exhaust +0.001	191-57008		
Twin Cam 88"	'99-04	Exhaust Std. 0.5620"	191-57029	191-57029C	
		Exhaust +0.001	191-57030	191-57030C	
		Exhaust +0.002	191-57031	191-57031C	
		Exhaust +0.003	191-57032	191-57032C	
		Exhaust +0.004	191-57033	191-57033C	
		Intake Std. 0.5620"	191-57051	191-57051C	
		Intake +0.001	191-57052	191-57052C	
		Intake +0.002	191-57053	191-57053C	
		Intake +0.003	191-57054	191-57054C	
		Intake +0.004	191-57055	191-57055C	
		Evolution	'84-99	IN/EX Std. 0.5620"	191-57003
IN/EX +0.001	191-57004			191-57004C	191-37020
IN/EX +0.002	191-57039			191-57039C	191-37020
IN/EX +0.003	191-57040			191-57040C	191-37020
IN/EX +0.010	191-57063			191-57064C	
Exhaust Std. 0.5620"	191-57029			191-57029C	191-37020
Exhaust +0.001	191-57030			191-57030C	191-37020
Exhaust +0.002	191-57031			191-57031C	191-37020
Exhaust +0.003	191-57032			191-57032C	191-37020
Exhaust +0.004	191-57033			191-57033C	191-37020
Intake Std. 0.5620"	191-57051			191-57051C	191-37020
Intake +0.001	191-57052			191-57052C	191-37020
Intake +0.002	191-57053			191-57053C	191-37020
Intake +0.003	191-57054			191-57054C	191-37020
Intake +0.004	191-57055			191-57055C	191-37020

**VALVE GUIDES AND VALVE STEM SEALS**



Application	Year	Type and Size	C630 Bronze	Cast Iron	Valve Stem Seals		
			Valve Guides	Valve Guides	(Sold as Pks of 4)		
HARLEY DAVIDSON (cont'd...) Shovelhead 80"	'78-83	Intake Std. 0.625"	191-57001	191-57001C	191-37021		
		Intake +0.001	191-57002	191-57002C	191-37021		
		Intake +0.002	191-57047	191-57047C	191-37021		
		Intake +0.004	191-57048	191-57048C	191-37021		
		Intake +0.006	191-57049	191-57049C	191-37021		
		Exhaust Std. 0.625"	191-57013	191-57013C	191-37021		
		Exhaust +0.001	191-57014	191-57014C	191-37021		
		Exhaust +0.002	191-57023	191-57023C	191-37021		
		Exhaust +0.004	191-57025	191-57025C	191-37021		
		Exhaust +0.006	191-57026	191-57026C	191-37021		
		Exhaust +0.010		191-57060C			
		Shovelhead 74"	'66-77	Intake Std. 0.5650"	191-57041	191-57041C	191-37021
				Intake +0.001	191-57042	191-57042C	191-37021
Intake +0.002	191-57043			191-57043C	191-37021		
Intake +0.003	191-57044			191-57044C	191-37021		
Intake +0.004	191-57045			191-57045C	191-37021		
Intake +0.006	191-57046			191-57046C	191-37021		
Exhaust Std. 0.5650"	191-57017			191-57017C	191-37021		
Exhaust +0.001	191-57018			191-57018C	191-37021		
Exhaust +0.002	191-57019			191-57019C	191-37021		
Exhaust +0.003	191-57020			191-57020C	191-37021		
Exhaust +0.004	191-57021			191-57021C	191-37021		
Exhaust +0.006	191-57022			191-57022C	191-37021		
Panhead	'48-65			Intake Std. 0.5650"	191-57041	191-57041C	191-37021
		Intake +0.001	191-57042	191-57042C	191-37021		
		Intake +0.002	191-57043	191-57043C	191-37021		
		Intake +0.003	191-57044	191-57044C	191-37021		
		Intake +0.004	191-57045	191-57045C	191-37021		
		Intake +0.006	191-57046	191-57046C	191-37021		
		Exhaust Std. 0.5650"	191-57017	191-57017C			
		Exhaust +0.001	191-57018	191-57018C	191-37021		
		Exhaust +0.002	191-57019	191-57019C	191-37021		
		Exhaust +0.003	191-57020	191-57020C	191-37021		
		Exhaust +0.004	191-57021	191-57021C	191-37021		
		Exhaust +0.006	191-57022	191-57022C	191-37021		
		Sportster	'04-17	Intake Std. 0.5620"	191-57009	191-57009C	191-37022
Intake +0.001	191-57010			191-57010C	191-37022		
Intake +0.002	191-57050			191-57050C	191-37022		
Exhaust Std. 0.5620"	191-57011			191-57011C	191-37022		
Exhaust +0.001	191-57012			191-57012C	191-37022		
Exhaust +0.002	191-57027			191-57027C	191-37022		
Intake +0.010				191-57059C			
Exhaust +0.010	191-57061			191-57062C			
'86-03	IN/EX Std. 0.5620"			191-57003	191-57003C	191-37020	
	IN/EX +0.001			191-57004	191-57004C	191-37020	
	IN/EX +0.002		191-57039	191-57039C	191-37020		
	IN/EX +0.003		191-57040	191-57040C	191-37020		
	Intake Std. 0.5620"		191-57051	191-57051C	191-37020		
	Intake +0.001		191-57052	191-57052C	191-37020		
	Intake +0.002		191-57053	191-57053C	191-37020		
	Intake +0.003		191-57054	191-57054C	191-37020		
	Intake +0.004		191-57055	191-57055C	191-37020		
	Exhaust Std. 0.5620"		191-57029	191-57029C	191-37020		
Exhaust +0.001	191-57030		191-57030C	191-37020			
Exhaust +0.002	191-57031		191-57031C	191-37020			
Exhaust +0.003	191-57032	191-57032C	191-37020				
Exhaust +0.004	191-57033	191-57033C	191-37020				
Sportster	'57-83	Intake Std. 0.5650"	191-57056	191-57056C			
		Intake +0.001	191-57057	191-57057C			
		Intake +0.002	191-57058	191-57058C			
		Exhaust Std. 0.5650"	191-57034	191-57034C			
		Exhaust +0.001	191-57035	191-57035C			
Exhaust +0.002	191-57036	191-57036C					

- WINDSHIELDS / FAIRINGS
- AUDIO / COMMUNICATION
- SEATS / LUGGAGE
- BARS / MIRRORS / CONTROLS
- EXHAUST
- AIR / FUEL SYSTEMS
- ENGINE**
- TRANSMISSION / DRIVELINE
- GASKETS / SEALS
- ELECTRICAL
- LIGHTING
- CABLES
- BRAKES
- OIL FILTERS
- SUSPENSION
- BODY
- WHEELS
- TIRES / TIRE ACC.
- BIKE ACC.
- VICTORY / INDIAN
- COVERS / LOCKS / TIEDOWNS
- CHEMICALS
- TOOLS
- HELMETS
- HELMET ACC.
- EYEWEAR
- APPAREL / RIDER ACC.
- PROMOTIONAL
- REFERENCE
- INDEX



**FAST INSTALL PUSH RODS**



X

X

X

X

Application	Year	WPS#
Twin Cam	'99-17	811-04090
Evo Big Twin	'85-99	811-04091

**PUSH RODS**



X

X

X

X

X

X

X

Application	Year	WPS#
A Twin Cam	'99-17	811-04070
B EVO Big Twin	'85-99	811-04080



A



B

**ROLLPIN TOOL**

Description	WPS#
Complete Rollpin Remover/Installer Tool	811-09000



- WINDSHIELDS / FAIRINGS
- AUDIO / COMMUNICATION
- SEATS / LUGGAGE
- BARS / MIRRORS / CONTROLS
- EXHAUST
- AIR / FUEL SYSTEMS
- ENGINE**
- TRANSMISSION / DRIVELINE
- GASKETS / SEALS
- ELECTRICAL
- LIGHTING
- CABLES
- BRAKES
- OIL FILTERS
- SUSPENSION
- BODY
- WHEELS
- TIRES / TIRE ACC.
- BIKE ACC.
- VICTORY / INDIAN
- COVERS / LOCKS / TIEDOWNS
- CHEMICALS
- TOOLS
- HELMETS
- HELMET ACC.
- EYEWEAR
- APPAREL / RIDER ACC.
- PROMOTIONAL
- REFERENCE
- INDEX



**Colony**  
OEM and Custom Hardware



**ALUMINIUM PUSH RODS**



Application	WPS#
A For '48-52 Pan With Shovel Top End	<b>830-1174</b>
B For '53-65 Models W/ Hydro Lifters	<b>830-1175</b>
C For '66-84 Models W/ Hydro Lifters	<b>830-1176</b>
<b>HYDRAULIC LIFTER CONVERSION</b>	
D For '53-83 Big Twins Pushrods and Converters	<b>830-1173</b>
E For '53-83 Big Twins Converters ONLY	<b>830-1183</b>



**PUSH ROD TAPPET ADJUSTER LOCK NUTS**



Application	WPS#
<b>PUSH ROD TAPPET ADJUSTER LOCK NUTS</b>	
For '15-84 Replaces OEM# 18570-38	<b>830-1186</b>

- WINDSHIELDS / FAIRINGS
- AUDIO / COMMUNICATION
- SEATS / LUGGAGE
- BAR / MIRRORS / CONTROLS
- EXHAUST
- AIR / FUEL SYSTEMS
- ENGINE**
- TRANSMISSION / DRIVELINE
- GASKETS / SEALS
- ELECTRICAL
- LIGHTING
- CABLES
- BRAKES
- OIL FILTERS
- SUSPENSION
- BODY
- WHEELS
- TIRES / TIRE ACC.
- BIKE ACC.
- VICTORY / INDIAN
- COVERS / LOCKS / TIEDOWNS
- CHEMICALS
- TOOLS
- HELMETS
- HELMET ACC.
- EYEWEAR
- APPAREL / RIDER ACC.
- PROMOTIONAL
- REFERENCE
- INDEX

- WINDSHIELDS / FAIRINGS
- AUDIO / COMMUNICATION
- SEATS / LUGGAGE
- BAR / MIRRORS / CONTROLS
- EXHAUST
- AIR / FUEL SYSTEMS
- ENGINE**
- TRANSMISSION / DRIVELINE
- GASKETS / SEALS
- ELECTRICAL
- LIGHTING
- CABLES
- BRAKES
- OIL FILTERS
- SUSPENSION
- BODY
- WHEELS
- TIRES / TIRE ACC.
- BIKE ACC.
- VICTORY / INDIAN
- COVERS / LOCKS / TIEDOWNS
- CHEMICALS
- TOOLS
- HELMETS
- HELMET ACC.
- EYEWEAR
- APPAREL / RIDER ACC.
- PROMOTIONAL
- REFERENCE
- INDEX



## BRASS PUSHROD CLIPS

Description	Application	WPS#
Four Hole Pushrod Clips	Big Twins '66-99 and Knuckles '40-47	880-2100
Three Hole Pushrod Clips	Panheads '48-65 and XL '57-84	880-2101



**Colony**  
OEM and Custom Hardware



## PUSHROD COVER CONVERSION AND ADAPTOR KIT

Description	Application	WPS#
Pushrod Cover Conversion and Adapter Kit	'91-03 XL models	830-1103



**FEULING**

## PUSHROD TUBE HOLDER

Description	WPS#
Pushrod Tube Holder ea.	811-09012





A



B



C



D

## UPPER OUTER PUSHROD COVER KITS

X

Description	Application	WPS#
A Outer Push Rod Kits w/ 1 3/4" long clips	'99-17 Twin Cam	<b>830-1120</b>
B Outer Push Rod Kits w/ 3 5/16" long clips	All EVO, Shovelhead and '40-47 Knucklehead	<b>830-1109</b>
C Outer Push Rod Kits w/ 2 13/16" long clips	'86-90 XL	<b>830-1127</b>
D Outer Push Rod Kits w/ 2 3/8" long clips	'57-85 XL and '57-65 Panhead	<b>830-1108</b>



A



B



C

## UPPER INNER PUSHROD COVERS

Description	Application	WPS#
A Inner Push Rod Cover	'99-17 Twin Cam	<b>830-1119</b>
B Inner Push Rod Cover	'79-83 Shovelhead and '84-Up EVO Big Twin	<b>830-1128</b>
C Inner Push Rod Cover	'36-Earlier, '79 Big Twins and '57-85 XL models	<b>830-1111</b>



A



B



C

## LOWER PUSHROD COVER KITS

X

Description	Application	WPS#
A Lower Push Rod Cover Kit	'99-17 Twin Cam	<b>830-1118</b>
Lower Push Rod Cover Kit	84-99 Big Twin EVO and '86-90 XL models	<b>830-1126</b>
B Lower Push Rod Cover Kit	'57-85 XL	<b>830-1125</b>
C Lower Push Rod Cover Kit	'40-47 Knucklehead	<b>830-1124</b>

- WINDSHIELDS / FAIRINGS
- AUDIO / COMMUNICATION
- SEATS / LUGGAGE
- BAR / MIRRORS / CONTROLS
- EXHAUST
- AIR / FUEL SYSTEMS
- ENGINE**
- TRANSMISSION / DRIVELINE
- GASKETS / SEALS
- ELECTRICAL
- LIGHTING
- CABLES
- BRAKES
- OIL FILTERS
- SUSPENSION
- BODY
- WHEELS
- TIRES / TIRE ACC.
- BIKE ACC.
- VICTORY / INDIAN
- COVERS / LOCKS / TIEDOWNS
- CHEMICALS
- TOOLS
- HELMETS
- HELMET ACC.
- EYEWEAR
- APPAREL / RIDER ACC.
- PROMOTIONAL
- REFERENCE
- INDEX

# FEULING®

## CAM INSTALL KITS

FEULING® Quick Change Camshaft installation kits for Twin Cam® engines include Timken® camplate roller bearings, KOYO® Torrington® full roller needle inner cam bearings, 12 point ARP® camshaft and crankshaft bolts with hardened washers and camshaft retaining clip. Gaskets include cam cover, lifter blocks, exhaust, pushrod tube and camplate o-rings, ARP fastener moly paste, and Loctite thread compound.



FEULING® Quick Change + Top End kits also include rocker box cover and breather assembly gaskets, breather elements, breather umbrella valves and rocker support O-rings.

Application	Year	Description	Style	OE Reference #	WPS#
Twin Cam (exc. '06 Dyna)	'99-06	Camshaft Install Kit	Gear Drive		<b>811-02060</b>
Twin Cam (exc. '06 Dyna)	'99-06	Camshaft Install Kit + Rocker Box gaskets	Gear drive		<b>811-02061</b>
Twin Cam (exc. '06 Dyna)	'99-06	Camshaft Install Kit	For conversion cam kits		<b>811-02063</b>
Twin Cam (exc. '06 Dyna)	'99-06	Camshaft Install Kit + Rocker Box gaskets	For conversion cam kits		<b>811-02064</b>
Twin Cam (exc. '06 Dyna)	'07-17	Camshaft Install Kit	Gear Drive Systems		<b>811-02065</b>
Twin Cam (inc. '06 Dyna)	'07-17	Camshaft Install Kit + Rocker Box gaskets	Gear Drive Systems		<b>811-02066</b>
Twin Cam (inc. '06 Dyna)	'07-17	Camshaft Install Kit	Chain Drive Systems		<b>811-02070</b>
Twin Cam (inc. '06 Dyna)	'07-17	Camshaft Install Kit + Rocker Box gaskets	Chain Drive Systems		<b>811-02071</b>

### CAM BEARINGS

Application	Year	Description	OE Reference #	WPS#
Twin Cam (exc. '06 Dyna)	'99-06	TIMKEN Outer Cam Bearings	8990	<b>811-02075</b>
Twin Cam (exc. '06 Dyna)	'99-06	FEULING Inner Cam Bearings	9198	<b>811-02076</b>
Twin Cam (inc. '06 Dyna)	'07-17	FEULING Inner Cam Bearings	9215	<b>811-02077</b>



## ROLLER LIFTERS

- Performance hydraulic roller lifters
- Optimized oil flow to top end - valves, springs, rockers, shafts & valve guides
- Cooler oil and reduced wear
- Extends life of top end valve gear
- CNC machined and precision ground
- Drop in replacement for stock lifters
- Dyno developed and track tested
- Recommended for use with the Feuling® Oil Pump or comparable high volume oil pump
- Made in the U.S.A.



Application	Years	WPS #
Sportster	'86-90	<b>811-04061</b>
	'91-99	<b>811-04025</b>
	'00-17	<b>811-04000</b>
Buell	'91-99	<b>811-04025</b>
	'00-12	<b>811-04000</b>
EVO Big Twin	'85-99	<b>811-04061</b>
Twin Cam	'99-17	<b>811-04000</b>



## LIFTERS

- Feuling® Race Series® full travel hydraulic lifters are machined from a steel body and designed to exceed the needs of large lift camshafts and higher valve spring pressures with a slower bleed down rate. Race Series® lifters maintain proper oil flow to the top end, increase engine RPM, valve-train stability, decreasing valve float promoting maximum valve lift.
- Feuling® recommends Race Series® lifters for engines running higher than 185Lbs. valve spring seat pressure. FEULING recommends the use of a high volume oil pump which will result in quieter, better performing lifters. Race Series® lifters are compatible with either FEULING® HP+® or Race Series® oil pumps and are designed for use with both street and strip engines. Spin-Tron dyno developed and track proven, Made in the USA.
- Available in oversized diameters - Case Savers!
- Recommended for both strip and performance street engines
- Made in the U.S.A.



Application	Years	Type	WPS#
Sportster	'86-90	Hydraulic Lifters	<b>811-04062</b>
	'00-17	Hydraulic Lifters	<b>811-04050</b>
		Hydraulic Lifters +.001	<b>811-04051</b>
Buell	'00-13	Hydraulic Lifters +.0015	<b>811-04052</b>
		Solid Roller Lifters	<b>811-04055</b>
		Hydraulic Lifters	<b>811-04050</b>
EVO Big Twin	'85-99	Hydraulic Lifters +.001	<b>811-04051</b>
		Hydraulic Lifters +.0015	<b>811-04052</b>
		Solid Roller Lifters	<b>811-04055</b>
Twin Cam	'99-17	Hydraulic Lifters	<b>811-04050</b>
		Hydraulic Lifters +.001	<b>811-04051</b>
		Hydraulic Lifters +.0015	<b>811-04052</b>
		Solid Roller Lifters	<b>811-04055</b>





**LIFTER BLOCKS**



820-58013



820-58014



820-58015



820-58016

- Meets OEM Specs
- Made From Cast Aluminum Then Polished and Powder Coated Gloss Black or Chrome Plated to a Show Finish

Description	Application	WPS#
Lifter Blocks Front and Rear BLK	53-84 Pan/Shovel	<b>820-58013</b>
Lifter Blocks Front and Rear CHR	53-84 Pan/Shovel	<b>820-58014</b>
Lifter Blocks Front and Rear CHR	84-99 EVO Big Twin	<b>820-58015</b>
Hydro Tappet Push Rod	53-84 Pan/Shovel	<b>820-58016</b>



**CAMSHAFTS FOR H-D® V-TWIN**



- TTS Camshafts are designed to provide smooth power delivery throughout your engine's entire operating range. The various grinds allow you to select a cam that optimizes torque in the RPM range you require without compromising performance elsewhere.
- TTS-100: Designed to increase torque in the 1000-4000 RPM range with smooth power to 5500 RPM. Developed for 88-117 CID with stock heads and pistons. Not recommended for compression over: 10.2:1 Twin Cam or 10.5:1 Milwaukee-Eight®. Ideal for heavy bikes like baggers or trikes. Bolt-in design utilizes stock springs and pushrods.
- TTS-150: Designed to increase torque in the 2200-5200 RPM range. Developed for 88-117 CID with stock heads and pistons. Not recommended for compression over 10.5:1. Bolt-in design utilizes stock springs and pushrods.
- TTS-200: Designed to increase torque over a broad RPM range (1800-5500 RPM). Developed for Milwaukee-Eight® engines with modified heads and pistons. Ideal for Stage III or IV kits. Not recommended for compression over 11.0:1. Requires use of high lift valve springs and modified valve reliefs in pistons.
- TTS-250: Designed to increase torque in the 2500-6000 RPM range. Developed for Milwaukee-Eight® engines with modified heads and pistons. Ideal for Stage III or IV kits. Not recommended for compression over 12.0:1. Requires use of high lift valve springs and modified valve reliefs in pistons.



Application	WPS #
<b>TTS 100 CAMS</b>	
Milwaukee 8 '17-Up	<b>133-5020</b>
Twin Cams '07-17 and '06 Dynas	<b>133-5024</b>
Twin Cams '99-06	<b>133-5026</b>
<b>TTS 150 CAMS</b>	
Milwaukee 8 '17-Up	<b>133-5021</b>
Twin Cams '07-17 and '06 Dynas	<b>133-5025</b>
Twin Cams '99-06	<b>133-5027</b>
<b>TTS 200 CAMS</b>	
Milwaukee 8 '17-Up	<b>133-5022</b>
<b>TTS 250 CAMS</b>	
Milwaukee 8 '17-Up	<b>133-5023</b>

- WINDSHIELDS / FAIRINGS
- AUDIO / COMMUNICATION
- SEATS / LUGGAGE
- BAR / MIRRORS / CONTROLS
- EXHAUST
- AIR / FUEL SYSTEMS
- ENGINE
- TRANSMISSION / DRIVELINE
- GASKETS / SEALS
- ELECTRICAL
- LIGHTING
- CABLES
- BRAKES
- OIL FILTERS
- SUSPENSION
- BODY
- WHEELS
- TIRES / TIRE ACC.
- BIKE ACC.
- VICTORY / INDIAN
- COVERS / LOCKS / TIEDOWNS
- CHEMICALS
- TOOLS
- HELMETS
- HELMET ACC.
- EYEWEAR
- APPAREL / RIDER ACC.
- PROMOTIONAL
- REFERENCE
- INDEX



The first Rocket Cam was created in 1996 for a race bike that accomplished several titles and championships. In Chris Rivas' career he has not only raced at the highest level in drag racing and land speed racing but has been very successful at both, setting and holding multiple records along the way. He currently owns the world's only 200 MPH Bagger with a top speed of 204 MPH. He also owns the world's fastest Dyna with a top speed of 244 MPH. His Rocket Cams technology has gone into every one of these bikes making them perform at the highest level that no other racer or manufacturer has been able to top. This is the same technology that goes into the street cams offered through Rocket Cams for the local performance shops in your area.



**514 CHAIN DRIVE CAMS:**

Best power with free-flow air cleaner and performance exhaust. Cruising hi-torque bolt-in cams. Incredible low rpm pulling power recommended for heavier bikes with stock compression ratio or up to 9.5:1. Peak performance at 1500 to 5000 rpm. Use stock valve springs. Very easy on valve train parts

Application	WPS #
<b>514 ROCKET CAMS</b>	
Twin Cams '07-17 and '06 Dynas	<b>276-02004</b>
Twin Cams '99-06	<b>276-02010</b>

**554 CHAIN DRIVE CAMS:**

Peak performance at 1500 to 5800 rpm. Stock compression ratio or up to 10:1. Best power with free-flow air cleaner and performance exhaust. Powerful cruising bolt-in cam. Uses stock valve springs. Recommended engine sizes 88" to 107" above average mid-range passing power.

Application	WPS #
<b>554 ROCKET CAMS</b>	
Twin Cams '99-06	<b>276-02011</b>

**574 CHAIN DRIVE CAMS:**

Powerful Street and Cruising bolt-in cam with .574" lift. 96" to 107" above average mid range passing power. Stock compression ratio or up to 10:1. Best power with free-flow air cleaner and performance exhaust. Uses stock valve springs. Range: 1,500 to 5,800 rpm. Available with S&S Cycle patented Easy Start compression release system.

Application	WPS #
<b>574 ROCKET CAMS</b>	
Twin Cams '07-17 and '06 Dynas	<b>276-02002</b>
<b>574 ROCKET CAMS W/EASY START</b>	
Twin Cams '07-17 and '06 Dynas	<b>276-02000</b>

**584 CHAIN DRIVE CAMS:**

Hot .584" lift cam for upgraded engines 103" to 107" Cubic Inch. Ported heads with minimum 10:1 compression recommended. Delivers constant power while reducing detonation. Free-flowing air cleaner and performance exhaust recommended. Uses stock valve springs. Range: 2,000 to 6,000 rpm. Available with S&S Cycle patented Easy Start compression release system.

Application	WPS #
<b>584 ROCKET CAMS</b>	
Twin Cams '07-17 and '06 Dynas	<b>276-02003</b>
Twin Cams '99-06	<b>276-02012</b>
<b>584 ROCKET CAMS W/EASY START</b>	
Twin Cams '07-17 and '06 Dynas	<b>276-02001</b>
Twin Cams '99-06	<b>276-02013</b>

ROCKET CAM SPECIFICATION CHART

Cam	Valve Lift	Duration		Valve Timing				Lift @ TDC	
		Intake	Exhaust	Intake Opens	Intake Closes	Exhaust Opens	Exhaust Closes	Intake	Exhaust
<b>ROCKET CAM 514</b>	0.514	230	240	14	36	46	14	0.162	0.141
<b>ROCKET CAM 554</b>	0.554	240	250	22	38	54	16	0.182	0.172
<b>ROCKET CAM 574</b>	0.574	240	250	22	38	54	16	0.198	0.164
<b>ROCKET CAM 584</b>	0.584	252	252	26	46	50	22	0.243	0.218

## LUNATI VOODOO CAMS



Voodoo Camshafts for Harley Davidson applications deliver more area under the curve than any other series of cams for these engines. This means more throttle response, quicker acceleration, more vacuum and better efficiency. These factors, combined with maximum horsepower and torque, make Voodoo Camshafts the perfect choice for your Harley.

### CHAIN DRIVE CAMS FOR 07-17 TWIN CAMS

Cam and Lifter Kits include the camshaft of choice with the matching replacement lifters recommended by Lunati. High RPM or stock replacement type lifters also available separately. All cams with 0.510 lift will work with stock valve springs.



Not legal for use on pollution controlled vehicles, check local laws before installation. NOT legal for sale in California

Description	Lift	RPM Range	Cams only #	Cam & Lifters #
Maximum torque for heavy bikes and passenger riding with stock heads. Strong low end & mid range power.	0.510	Idle - 5100	<b>276-01040</b>	<b>276-01080</b>
Potent mid range power for both light and heavy bikes. Very effective for compression ratios up to 9.5:1.	0.510	1500 - 5500	<b>276-01041</b>	<b>276-01081</b>
Strong mid range power for 88-95 c.i. engines. Works well with compression ratios of up to 10:1.	0.510	1700 - 5900	<b>276-01042</b>	<b>276-01082</b>
Strong mid range power for 88-95 c.i. engines. Works well with compression ratios of up to 10:1.	0.569	1700 - 5700	<b>276-01043</b>	<b>276-01083</b>
Great power in mid to upper RPM range. Likes upgraded fuel and aftermarket exhausts and higher compression ratios.	0.585	2100 - 6100	<b>276-01044</b>	<b>276-01084</b>
Maximum upper RPM power. Great for large 95-107+ c.i. engines with increased compression and fuel/exhaust system upgrades.	0.601	2500 - 6500	<b>276-01045</b>	<b>276-01085</b>

### CHAIN DRIVE CAMS FOR 99-06 (EXCEPT 06 DYNA) TWIN CAMS

Cam and Lifter Kits include the camshaft of choice with the matching replacement lifters recommended by Lunati. High RPM or stock replacement type lifters also available separately. **Not legal for use on pollution controlled vehicles, check local laws before installation.**

Description	Lift	RPM Range	Cams only #	Cam & Lifters #
Maximum torque for heavy bikes and passenger riding with stock heads. Strong low end & mid range power.	0.510	Idle - 5100	<b>276-01020</b>	<b>276-01060</b>
Potent mid range power for both light and heavy bikes. Very effective for compression ratios up to 9.5:1.	0.510	1500 - 5500	<b>276-01021</b>	<b>276-01061</b>
Strong mid range power for 88-95 c.i. engines. Works well with compression ratios of up to 10:1.	0.510	1700 - 5900	<b>276-01022</b>	<b>276-01062</b>
Strong mid range power for 88-95 c.i. engines. Works well with compression ratios of up to 10:1.	0.569	1700 - 5700	<b>276-01023</b>	<b>276-01063</b>
Great power in mid to upper RPM range. Likes upgraded fuel, aftermarket exhausts and higher compression ratios.	0.585	2100 - 6100	<b>276-01024</b>	<b>276-01064</b>
Maximum upper RPM power. Great for large 95-107+ c.i. engines with increased compression and fuel/exhaust system upgrades.	0.601	2500 - 6500	<b>276-01025</b>	<b>276-01065</b>

### CAMS FOR 84-99 EVOLUTION MODELS

Spring kits and accessories sold separately. **Not legal for use on pollution controlled vehicles, check local laws before installation.**

Description	Lift	RPM Range	WPS #
Generates maximum torque for heavy bikes and passenger riding. Strong low end & mid range power	0.570	Idle-5500	<b>276-01001</b>
Good low end and mid range power. Works well with stock compression. Excellent highway performance.	0.577	900-5700	<b>276-01002</b>
Potent mid range power for both light and heavy bikes. Very effective for compression ratios up to 9.5:1.	0.583	1300-5900	<b>276-01003</b>
Strong mid range power for 88 c.i. engines. Works well with compression ratios of up to 10:1.	0.590	1500-6100	<b>276-01004</b>
Ideally suited for 88 c.i. motors. Performs well with higher compression ratios & aftermarket exhaust systems	0.596	1700-6300	<b>276-01005</b>
Great power in mid to upper RPM range. Likes upgraded fuel & aftermarket exhausts & higher compression ratios.	0.603	1900-6500	<b>276-01006</b>
Maximum upper RPM power. Great for large c.i. engines with increased compression and fuel/exhaust system upgrades.	0.603	2300-6900	<b>276-01007</b>

See next page for specifications

- WINDSHIELDS / FAIRINGS
- AUDIO / COMMUNICATION
- SEATS / LUGGAGE
- BARS / MIRRORS / CONTROLS
- EXHAUST
- AIR / FUEL SYSTEMS
- ENGINE**
- TRANSMISSION / DRIVELINE
- GASKETS / SEALS
- ELECTRICAL
- LIGHTING
- CABLES
- BRAKES
- OIL FILTERS
- SUSPENSION
- BODY
- WHEELS
- TIRES / TIRE ACC.
- BIKE ACC.
- VICTORY / INDIAN
- COVERS / LOCKS / TIEDOWNS
- CHEMICALS
- TOOLS
- HELMETS
- HELMET ACC.
- EYEWEAR
- APPAREL / RIDER ACC.
- PROMOTIONAL
- REFERENCE
- INDEX



## LUNATI VOODOO CAM SPECIFICATIONS

Cam Part#	Valve Lift	Valve Duration @.053			Grind Lobe Sep	Centerline		Valve Timing				Lift @ TDC	
		Intake	Exhaust			Intake	Exhaust	.053 Intake Opens BTDC	.053 Intake Closes ABDC	.053 Exhaust Opens BBDC	.053 Exhaust Closes ATDC	Intake	Exhaust
276-01001	0.570	227	227	103	100	106	14	34	40	8	0.153	0.124	
276-01002	0.577	231	231	103	100	106	16	36	42	10	0.164	0.133	
276-01003	0.583	235	235	103	100	106	18	38	44	12	0.177	0.145	
276-01004	0.590	239	239	103	100	106	20	40	46	14	0.189	0.156	
276-01005	0.596	243	243	107	103	111	19	45	53	11	0.177	0.133	
276-01006	0.603	247	247	107	103	111	21	47	55	13	0.189	0.145	
276-01007	0.603	251	251	107	103	111	23	49	57	15	0.202	0.156	
276-01020	0.510	227	231	103	100	106	14	34	42	10	0.153	0.133	
276-01021	0.510	235	239	105	101	109	17	39	49	11	0.176	0.143	
276-01022	0.510	239	247	107	103	111	17	43	55	13	0.164	0.143	
276-01023	0.569	239	243	105	101	109	19	41	51	13	0.189	0.154	
276-01024	0.585	247	251	106	102	110	22	46	56	16	0.2	0.166	
276-01025	0.601	255	259	107	103	111	25	51	61	19	0.213	0.177	
276-01040	0.510	227	231	103	100	106	14	34	42	10	0.153	0.133	
276-01041	0.510	235	239	105	101	109	17	39	49	11	0.176	0.143	
276-01042	0.510	239	247	107	103	111	17	43	55	13	0.164	0.143	
276-01043	0.569	239	243	105	101	109	19	41	51	13	0.189	0.154	
276-01044	0.585	247	251	106	102	110	22	46	56	16	0.2	0.166	
276-01045	0.601	255	259	107	103	111	25	51	61	19	0.213	0.177	

## LUNATI VALVE TRAIN ACCESSORIES

- Lunati valve spring kits were designed to get the most power out of Harley upgrades and are a perfect match for a Lunati Harley cam.
- Each kit contains (4) each of the following items: valve springs, retainers, locks and locators.
- Valve locks are manufactured from fatigue-proof steel and then heat treated for hardness and to reduce wear and distortion, while our locators are engineered from a high-strength steel alloy that holds the spring in place and requires no machining.
- Steel retainers are constructed from 4140 chrome moly steel, which is stronger and harder than standard 1020 steel. This increased strength to weight ratio results in a stronger yet lighter retainer. All steel retainers from Lunati are black oxide coated for corrosion resistance.
- Lunati offers two types of hydraulic roller lifters for Harleys: OEM Replacement and High RPM. OEM Replacement Lifters are designed to exceed the specifications of your OEM lifters while High RPM Lifters were specially designed to handle applications producing over 6500 RPM to avoid horsepower-robbing valve float and serious engine damage.



Description	WPS #
<b>LIFTERS</b>	
Twin Cam Lifter SET, High RPM	<b>276-01100</b>
Twin Cam Lifter SET, Stock Replacement	<b>276-01101</b>
<b>SPRING KITS</b>	
Beehive Kits up to 0.601 Lift Twin Cams	<b>276-01155</b>
Beehive Kits up to 0.603 Lift Evos	<b>276-01150</b>
Beehive Kits up to 0.603 Lift Evos w/Titanium Retainers	<b>276-01151</b>

## CAM CHAIN ACCESSORIES



- Replacement inner and outer cam chain tensioners for Twin Cam motors
- Cam chain tensioners wear differently depending on useage, oil change frequency and many other factors. We recommend inspection for wear frequently to avoid any engine damage.
- Cam chain guide also available
- Sold individually

Application	Description	WPS#
A '99-06 Twin Cams	Cam Chain Tensioner OUTER	820-51400
B	Cam Chain Tensioner INNER	820-51401
C	Cam Chain Guide	820-51402

## BALANCER CHAIN GUIDES

- Three piece set that includes front, lower and rear guides



Application	WPS#
Fit Twin Cam B Motors '00-17 (Repl. OEM 14761-00)	820-51403

## CAM LOCK WASHERS

- Sold in packs of 5



Application	WPS#
Fit Most Big Twin Motors '58-99 (Repl. OEM 25550-57) 5 pk	820-53220



## 12 POINT CAM & PINION BOLT KIT

- Quality 12-point heat treated 8740 chrome moly steel bolts with black oxide finish
- Tensile strength rated @ 170,000 psi - Superior & Stronger than OEM & stronger than grade 8 fasteners
- Kits include moly assembly lubricant for installation
- Made in the U.S.A.

Application	Year	Description	WPS#
Twin Cam	'99-17	12 Point Cam & Pinion Bolt Kit	811-03042

## CRANKSHAFT TOOL

- This tool simplifies and speeds the process of checking crankshaft run out on both Twin Cam® and EVO® model engines with the crankshaft installed. The tool mounts to the cam chest side of the engine case using the designated mounting holes of the tool combined with the handled thumb screws and the case cam cover bolt holes. The tool gives quick and accurate readings of the engines crank pinion shaft run out.
- Tool includes: tool plate, +/-0.001dial indicator, thumb screws & hardware.



Description	WPS#
Crankshaft Tool	811-09015

- WINDSHIELDS / FAIRINGS
- AUDIO / COMMUNICATION
- SEATS / LUGGAGE
- BAR / MIRRORS / CONTROLS
- EXHAUST
- AIR / FUEL SYSTEMS
- ENGINE**
- TRANSMISSION / DRIVELINE
- GASKETS / SEALS
- ELECTRICAL
- LIGHTING
- CABLES
- BRAKES
- OIL FILTERS
- SUSPENSION
- BODY
- WHEELS
- TIRES / TIRE ACC.
- BIKE ACC.
- VICTORY / INDIAN
- COVERS / LOCKS / TIEDOWNS
- CHEMICALS
- TOOLS
- HELMETS
- HELMET ACC.
- EYEWEAR
- APPAREL / RIDER ACC.
- PROMOTIONAL
- REFERENCE
- INDEX

**FEULING®**



**OILING SYSTEM KIT**

- FEULING® oiling system kits combine all the needed components to finish your T/C® engines oiling system under 1 Part #, available in HP+® or RACE SERIES® kits. FEULING® oiling system kits increase oil pressure, oil volume, engine oil flow and return oil scavenging, eliminating wet sumping and oily air cleaners. Test results show 25-35 degree cooler engine temperatures, 15-30 degree cooler oil temperatures, 15-30 more pounds of oil pressure and quieter smoother engine operation. Results also show a substantial increase of oil pressure and 3 H.P. and 4 Ft. Lbs of T.Q to the rear wheel.
- Both HP+® and RACE SERIES® kits include FEULINGS® HIGH FLOW billet camplate made from 7075 aluminum which is 50% harder and stronger than the factory, SE® and other aftermarket camplates. FEULING® increases oil flow and volume by enlarging the oil pump reservoirs and critical oil passages including matching the oil port holes throughout the camplate to the port holes in the engine case which increases engine oil flow to the lifters, piston cooling jets, crankshaft and rod bearings.
- HP+® SERIES Kits include a billet 6061 aluminum high volume oil pump, FEULING® HIGH FLOW camplate, HP+® Hydraulic roller lifters, gaskets and o-ring kit.
- RACE SERIES® Kits include a billet 7075 hard anodized oil pump which is 50% harder and stronger than the factory pump holding tighter tolerances under temperature. RACE SERIES® hydraulic lifters have a full .200 of total travel designed with a slower bleed down rate to handle heavy valve spring pressures, increase engine RPM before valve float and feature increased roller clearance for steep ramped camshafts. Kits include a RACE SERIES® oil pump, RACE SERIES® lifters, HIGH FLOW camplate, gaskets and o-rings.
- \*CONVERSION CAMPLATE Kits #811-07076 & #811-07077 utilize the early style 99-06 camshafts and upgrade the cam chain system to use the late style 07-16 hydraulic tensioner system. Factory sprockets, tensioners, chain and hardware must be purchased separately.

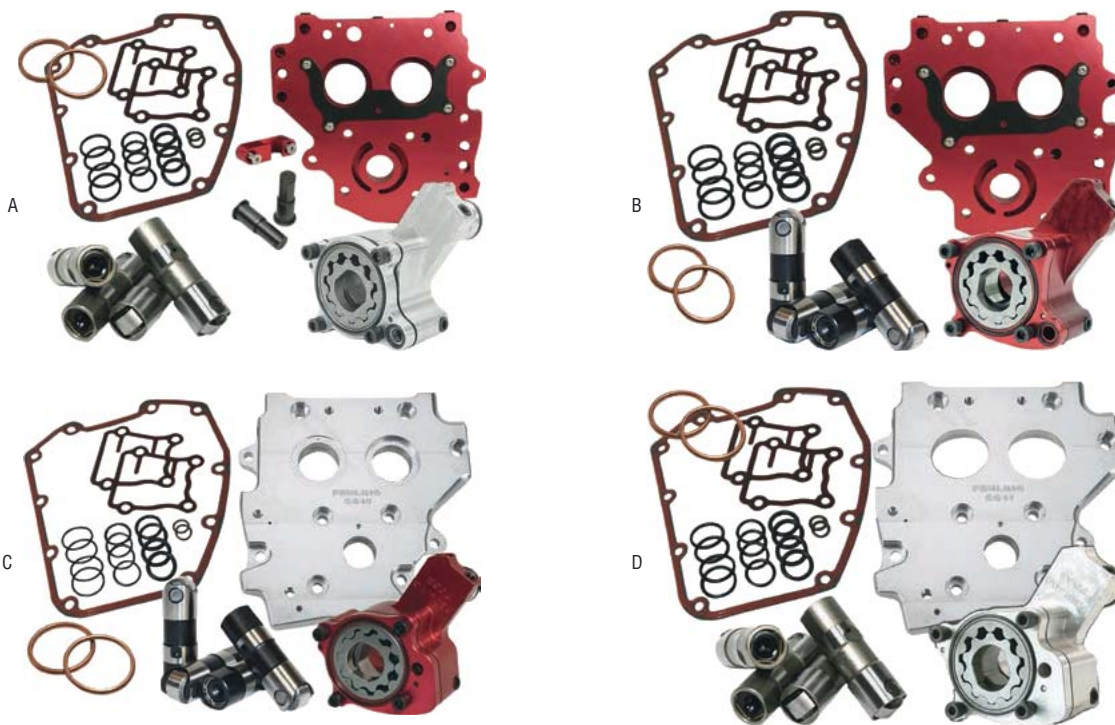

	Application	Style	Series	WPS#
	'99-06 Twin Cam (exc. '06 Dyna)	Gear Driven Cams	HP+®	<b>811-07070</b>
A	'99-06 Twin Cam (exc. '06 Dyna)	Chain Driven Cams	HP+®	<b>811-07071</b>
D	'99-06 Twin Cam (exc. '06 Dyna)	Chain Driven Conversion	HP+® *	<b>811-07076</b>
	'07-17 Twin Cam (inc. '06 Dyna)	Gear or Chain Driven Cams	HP+®	<b>811-07074</b>
B	'99-06 Twin Cam (exc. '06 Dyna)	Gear Driven Cams	Race Series®	<b>811-07072</b>
	'99-06 Twin Cam (exc. '06 Dyna)	Chain Driven Cams	Race Series®	<b>811-07073</b>
	'99-06 Twin Cam (exc. '06 Dyna)	Chain Driven Conversion	Race Series® *	<b>811-07077</b>
C	'07-17 Twin Cam (inc. '06 Dyna)	Gear or Chain Driven Cams	Race Series®	<b>811-07075</b>

\*CONVERSION CAMPLATE Kits #811-07076 & #811-07077 utilize the early style 99-06 camshafts and upgrade the cam chain system to use the late style 07-Up hydraulic tensioner system. Factory sprockets, tensioners, chain and hardware must be purchased separately.



**OIL PUMPS**



- Billet 6061 aluminum -high volume oil pump
- Increases oil pressure -cooler oil & engine temperatures
- No more oily air cleaners -40% more pressure volume than stock
- Eliminates blow-by & wet sumping -60% more scavenge (return) volume than stock
- More horsepower and torque to the rear wheel -stock replacement
- Fits both A and B Twin Cam engines -Feuling® design, tolerances & material
- High flow 2 chrome moly gerotor gears -Made in the U.S.A.

Application	Style	WPS #
A '99-06 Twin Cam (exc. '06 Dyna)	HP+® Oil Pump	<b>811-07000</b>
B '07-17 Twin Cam (inc. '06 Dyna)	HP+® Oil Pump	<b>811-07060</b>
'99-06 Twin Cam (exc. '06 Dyna)	Feuling Oil Pump Rebuild Kit	<b>811-07001</b>
C '07-17 Twin Cam (inc. '06 Dyna)	Feuling Oil Pump Rebuild Kit	<b>811-07061</b>



**OIL PUMPS**



- 7075 Billet aluminum with military spec hard anodized, blue printed and designed for the racer!
- The 7075 alloy is 50% harder and stronger than 6061 aluminum and holds tighter tolerance under temperature
- More pressure volume and more oil pressure
- More scavenge volume eliminating power robbing wet sumping, blow-by and oily air cleaners
- Cooler oil and engine temperatures
- More horsepower, more torque, more oil pressure, more return volume
- High Flow 4140 heat treated Chrome Moly gerotor gears
- Stock replacement for Twin Cam® engines
- When combined with the Feuling® Camplate test results show 3 Horsepower gain and 4 ft/lbs of Torque gain to the rear wheel, while lowering engine & oil temperature. Feuling® camplate NOT required.
- Stock replacement for Twin Cam® engines, recommended for both strip & performance street engines
- Made in the U.S.A.

Application	Style	WPS #
A '99-06 Twin Cam (exc. '06 Dyna)	Feuling Race Series® Oil Pump	<b>811-07050</b>
B '07-17 Twin Cam (inc. '06 Dyna)	Feuling Race Series® Oil Pump	<b>811-07062</b>
'99-06 Twin Cam (exc. '06 Dyna)	Feuling Oil Pump Rebuild kit	<b>811-07001</b>
C '07-17 Twin Cam (inc. '06 Dyna)	Feuling Oil Pump Rebuild kit	<b>811-07061</b>

WINDSHIELDS / FAIRINGS

AUDIO / COMMUNICATION

SEATS / LUGGAGE

BAR / MIRRORS / CONTROLS

EXHAUST

AIR / FUEL SYSTEMS

**ENGINE**

TRANSMISSION / DRIVELINE

GASKETS / SEALS

ELECTRICAL

LIGHTING

CABLES

BRAKES

OIL FILTERS

SUSPENSION

BODY

WHEELS

TIRES / TIRE ACC.

BIKE ACC.

VICTORY / INDIAN

COVERS / LOCKS / TIEDOWNS

CHEMICALS

TOOLS

HELMETS

HELMET ACC.

EYEWEAR

APPAREL / RIDER ACC.

PROMOTIONAL

REFERENCE

INDEX



## BILLET OIL PUMPS

Harddrive oil pumps are made from cast aluminum that is CNC machined to close tolerances and then polished to a high gloss finish. Great value for small dollars! Surplus oil is routed back to the main passage rather than the return to avoid unnecessary filtering and offer the opportunity to upgrade earlier engines to the 81-up oiling system. This oiling system splits bottom and top end oil supply which increases oil pressure to the hydraulic lifters and and top end. They come with gaskets, drive shaft with with keys and snap ring, mounting hardware, check ball and pressure relief valve assemblies.

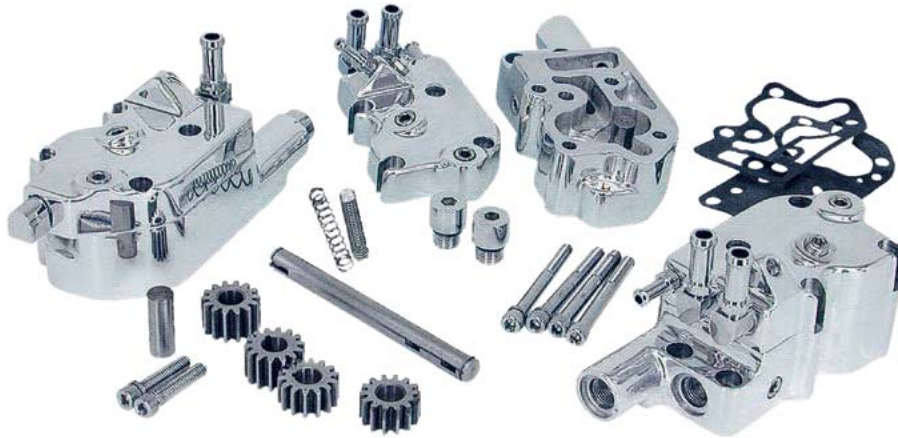

Description	Application	WPS#
Polished High Volume Oil Pump	Big Twin 36-72	820-50101
Polished High Volume Oil Pump	Big Twin 73-91	820-50102
Polished High Volume Oil Pump	Big Twin 92-99	820-50103

## HI VOLUME/ PRESSURE OIL PUMPS



• OEM replacement

Description	Application	WPS#
A High Vol/Press Oil Pump	17-Up M8 Models	820-50002
B	91-17 XL Models	820-50003
C	Twin Cam 88 Models	820-58017
D	Twin Cam 96 Models	820-58018

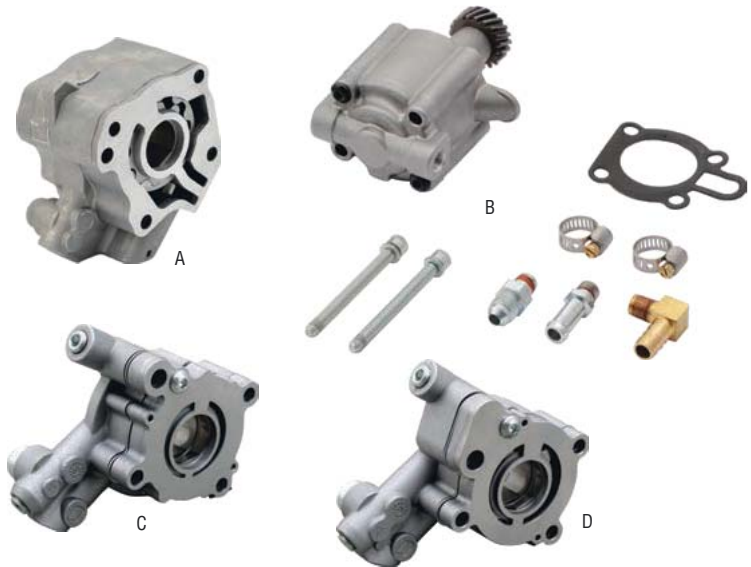

## OIL PUMP PLUGS



• Made in the USA!  
• Meets or exceeds OEM specifications

Description	Application	OEM#	WPS#
A Chrome plated polished Allen oil pump check valve/tappet oil screen,relief valve plug	'81-Up Big Twin	26263-80	830-1102
B Tappet oil screen and spring	'70-99 Big Twin	24981-70 and 24982-70	830-1104



A

B





**CRANK PIN NUT/LOCK PLATE**

- Reproduction of OEM 23971-54 lock plates and hardware
- Sold Each



A



B

	Application	WPS#
<b>CRANK PIN NUT SET</b>		
	For '41-53 Big Twins OEM# 23967-41	<b>830-1151</b>
A	For '54-E81 Big Twins OEM# 23966-54a	<b>830-1152</b>
	For '83-99 Big Twin OEM# 23967-54a	<b>830-1156</b>
	For 'L81-98 XL OEM#23901-81	<b>830-1157</b>
	For '83-99 Big Twin OEM# 23969-83	<b>830-1158</b>
	For '36-52 61"OHV '37-48 74&80" side valve	<b>830-1171</b>
<b>CRANK PIN LOCK PLATE</b>		
B	For '54-E80 Big Twins OEM# 23971-54	<b>830-1154</b>
	For '41-53 Big Twin '57-80 XL OEM# 23971-41	<b>830-1153</b>
	For '36-41 Big Twin	<b>830-1170</b>

**PINION/SPROCKET SHAFT NUTS**



- Designed for OEM replacement
- Made In the U.S.A



	Application	WPS#
<b>PINION SHAFT NUTS</b>		
	For Late '81-89 Big Twin OEM# 24016-80	<b>830-1145</b>
	Lock Plates For '36-71 Big Twin	<b>830-1147</b>
	For '54-E81 Sportster OEM# 8011	<b>830-1140</b>
	For '54-89 Big Twin OEM# 24023-54	<b>830-1150</b>
<b>SPROCKET SHAFT NUTS</b>		
	For '36-71 Big Twin OEM# 24023-36	<b>830-1139</b>
	For '37-73 Big Twin OEM# 8010	<b>830-1146</b>
	For XL 81-85 OEM# 23902-81	<b>830-1159</b>

**MOTOR SPROCKET NUT**



- Motor Sprocket Nuts
- OEM Replacements
- Made In The U.S.A
- Sold Each



A



B



C

	Application	WPS#
<b>MOTOR SPROCKET NUT</b>		
A	For '55-76 Big Twins OEM# 24003-55	<b>830-1182</b>
B	For '93-UP Sportster OEM# 7939	<b>830-1138</b>
C	For '91-92 Sportster OEM# 7652	<b>830-1142</b>
	For '72-E85 Big Twins OEM# 24017-72, 24017-80	<b>830-1141</b>

WINDSHIELDS / FAIRINGS  
AUDIO / COMMUNICATION  
SEATS / LUGGAGE  
BARS / MIRRORS / CONTROLS  
EXHAUST  
AIR / FUEL SYSTEMS  
**ENGINE**  
TRANSMISSION / DRIVELINE  
GASKETS / SEALS  
ELECTRICAL  
LIGHTING  
CABLES  
BRAKES  
OIL FILTERS  
SUSPENSION  
BODY  
WHEELS  
TIRES / TIRE ACC.  
BIKE ACC.  
VICTORY / INDIAN  
COVERS / LOCKS / TIEDOWNS  
CHEMICALS  
TOOLS  
HELMETS  
HELMET ACC.  
EYEWEAR  
APPAREL / RIDER ACC.  
PROMOTIONAL  
REFERENCE  
INDEX

# FEULING®

## PSI TESTER

- This pressure test tool is a must for any H-D® Twin Cam engine builder. Bench test each camplate before installation, cycle the pressure relief valve, testing operation and assuring the valve moves freely, seats and seals each time, any leakage at the relief valve will reduce oil pressure.
- This tool allows the engine builder to know what PSI the relief valve opens; the spring tension can be adjusted to achieve the desired pop off PSI. Tool includes: air regulator, 0 - 100 psi pressure gauge, gasket & needed hardware, fits all Twin Cam engine camplates. Feuling® recommends the camplate valve be seated 0-30 psi with full pop off at 55-60 psi. Made in the U.S.A.

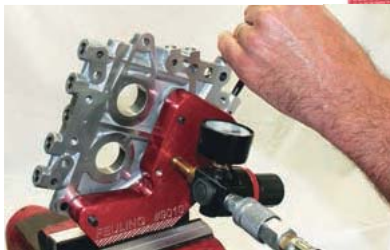

Description	WPS#
Camplate PSI tester for Twin Cam	811-09010



## CAM COVERS

- Chrome plated cast aluminum cam covers for single cam motors
- Come with bushings installed
- Hardware and seal included



Description	WPS#
Cam Cover with Hardware & Gasket '73-91	820-51581
Cam Cover with Hardware & Gasket '92-99	820-51582
Cam Cover with Hardware & Gasket '01-17 Chrome	820-50802
Cam Cover with Hardware & Gasket '01-17 Black	820-50803
Chrome Timing Cover 2 Hole Big Twin and '04-Up Sprotster	820-50813

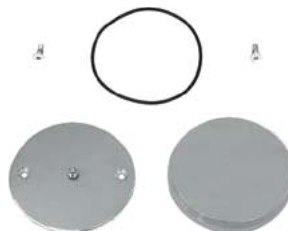

## CAM COVERS

Ribbed EMD covers are the real alternative to the cold, rigid and old fashioned "Billet" style...they will give your engine the soul and the charisma of yesteryear choppers.

- Manufactured in die cast aluminum, CNC milled gasket surface
  - OEM Mounting Hardware reusable
  - Gaskets not included, please order separately
- Available in raw cast or black powder coated finish, ribs can be accented or polished



Application	Description	WPS#
A Fits '01-17 Softail and Dyna models, '02-17 Touring models	Ribbed Cam Cover Raw	866-05300
B	Ribbed Cam Cover Black	866-05301



## SPORTSTER CAM COVERS

Featuring a raised rib design, this cast aluminum 'second skin' cam cover trim fits over your OEM cam cover. It is held in place with three supplied Allen bolts and spacers. The EMD cam cover trim can be notched at the upper front to make room for your OEM breather. You can also opt to relocate the breather to a lower position, especially if you're cutting the OEM cam cover up to visually 'split' the motor from the transmission. These covers are available in two styles, the classic ribster and the knuckle style with raised ribs and a smooth front section.



A



B



C



D

Application	Description	WPS#
A Fits '91-Up XL Models	Ribster Cam Cover Raw	<b>866-05005</b>
B	Ribster Cam Cover Black	<b>866-05006</b>
C	Knuckle Style Cam Cover Raw	<b>866-05055</b>
	Knuckle Style Cam Cover Black	<b>866-05056</b>
D Fits '77-90 XL Models	Ribster Cam Cover Raw	<b>866-05057</b>
	Ribster Cam Cover Black	<b>866-05058</b>

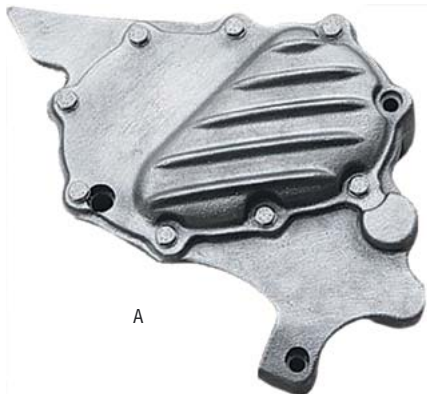

A



B

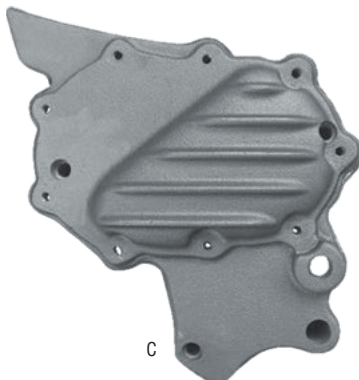

C



D

## SPORTSTER SPROCKET COVERS

Featuring a raised rib design to match the EMD Cam Cover Trim, the EMD Sprocket Cover provides a much-needed finishing touch to any custom Sportster for that 'split transmission' look. The Sprocket Cover is a direct bolt-on for Sportsters with forward controls and forward-mounted master cylinder. Mid-mount Sportsters will require custom modifications.

Application	Description	WPS#
A Fits '04-Up XL Models	Ribster Sprocket Cover Raw	<b>866-05080</b>
B	Ribster Sprocket Cover Black	<b>866-05081</b>
C Fits '91-03 XL Models	Ribster Sprocket Cover Raw	<b>866-05082</b>
D	Ribster Sprocket Cover Black	<b>866-05083</b>

- WINDSHIELDS / FAIRINGS
- AUDIO / COMMUNICATION
- SEATS / LUGGAGE
- BAR / MIRRORS / CONTROLS
- EXHAUST
- AIR / FUEL SYSTEMS
- ENGINE**
- TRANSMISSION / DRIVELINE
- GASKETS / SEALS
- ELECTRICAL
- LIGHTING
- CABLES
- BRAKES
- OIL FILTERS
- SUSPENSION
- BODY
- WHEELS
- TIRES / TIRE ACC.
- BIKE ACC.
- VICTORY / INDIAN
- COVERS / LOCKS / TIEDOWNS
- CHEMICALS
- TOOLS
- HELMETS
- HELMET ACC.
- EYEWEAR
- APPAREL / RIDER ACC.
- PROMOTIONAL
- REFERENCE
- INDEX

- WINDSHIELDS / FAIRINGS
- AUDIO / COMMUNICATION
- SEATS / LUGGAGE
- BARS / MIRRORS / CONTROLS
- EXHAUST
- AIR / FUEL SYSTEMS
- ENGINE**
- TRANSMISSION / DRIVELINE
- GASKETS / SEALS
- ELECTRICAL
- LIGHTING
- CABLES
- BRAKES
- OIL FILTERS
- SUSPENSION
- BODY
- WHEELS
- TIRES / TIRE ACC.
- BIKE ACC.
- VICTORY / INDIAN
- COVERS / LOCKS / TIEDOWNS
- CHEMICALS
- TOOLS
- HELMETS
- HELMET ACC.
- EYEWEAR
- APPAREL / RIDER ACC.
- PROMOTIONAL
- REFERENCE
- INDEX



## BILLET POINTS COVER

- A simple touch that makes a big difference without breaking the bank
- Harley Davidson points cover is CNC milled from 6061 aircraft billet aluminum
- Available in our hard black anodized contrast cut or our show chrome finish
- Wide variety of fitment for both 5 hole and 2 hole fitment
- Made in the USA

Application	Description	WPS#
<b>HARLEY DAVIDSON</b>		
Twin Cam Models	Bad Axe Chrome	<b>810-0358</b>
A Twin Cam Models	Bad Axe Black	<b>810-0357</b>
B Twin Cam Models	Dark Side Chrome	<b>810-0351</b>
Twin Cam Models	Dark Side Black	<b>810-0352</b>
Twin Cam Models	Ace's Wild Chrome	<b>810-0353</b>
C Twin Cam Models	Ace's Wild Black	<b>810-0354</b>
Evo Big Twin/Evo Sportster	Dark Side Chrome	<b>810-0371</b>
Evo Big Twin/Evo Sportster	Dark Side Black	<b>810-0372</b>



A



B



C



## BILLET POINTS COVER

Pro One Evo billet point covers are CNC machined from solid billet aluminum, carefully polished, then hit with a durable black anodize or chrome finish! Chrome hardware included. Fits '84-99 Evo motors. Will not fit Twin Cams.



Application	Description	Chrome	Black
Fit '84-99 Evos	Smooth	<b>812-02052</b>	<b>812-02053</b>



# PISTON HELMET POINTS COVERS



The Brass Balls Piston Helmet design ignition cover is a perfect compliment to your bike. Cast from Zinc then antiqued for that perfect patina. Give your bike that extra bit of coolness it deserves.

Application	WPS#
Fits '99-17 Twin Cams	<b>826-01150</b>
Fits Evo, Shovel and XL '04-Up	<b>826-01151</b>
Fits XL '96-03	<b>826-01152</b>
Fits M8 '17-Up	<b>826-01153</b>



## POINTS COVER SETS

Application	Year	WPS#
Twin Cam All models	'99-17	<b>830-1027</b>
EVO Big Twin All models	'79-99	<b>830-1026</b>



- WINDSHIELDS / FAIRINGS
- AUDIO / COMMUNICATION
- SEATS / LUGGAGE
- BARS / MIRRORS / CONTROLS
- EXHAUST
- AIR / FUEL SYSTEMS
- ENGINE**
- TRANSMISSION / DRIVELINE
- GASKETS / SEALS
- ELECTRICAL
- LIGHTING
- CABLES
- BRAKES
- OIL FILTERS
- SUSPENSION
- BODY
- WHEELS
- TIRES / TIRE ACC.
- BIKE ACC.
- VICTORY / INDIAN
- COVERS / LOCKS / TIEDOWNS
- CHEMICALS
- TOOLS
- HELMETS
- HELMET ACC.
- EYEWEAR
- APPAREL / RIDER ACC.
- PROMOTIONAL
- REFERENCE
- INDEX

WINDSHIELDS / FAIRINGS  
 AUDIO / COMMUNICATION  
 SEATS / LUGGAGE  
 BARS / MIRRORS / CONTROLS  
 EXHAUST  
 AIR / FUEL SYSTEMS  
**ENGINE**  
 TRANSMISSION / DRIVELINE  
 GASKETS / SEALS  
 ELECTRICAL  
 LIGHTING  
 CABLES  
 BRAKES  
 OIL FILTERS  
 SUSPENSION  
 BODY  
 WHEELS  
 TIRES / TIRE ACC.  
 BIKE ACC.  
 VICTORY / INDIAN  
 COVERS / LOCKS / TIEDOWNS  
 CHEMICALS  
 TOOLS  
 HELMETS  
 HELMET ACC.  
 EYEWEAR  
 APPAREL / RIDER ACC.  
 PROMOTIONAL  
 REFERENCE  
 INDEX



## IGNITION COVERS

- CNC Machined 6061 aluminum
- Six different anodized colored options
- Machined Rooke logo
- Replaces the OEM ignition cover
- Made in the USA



Application	Finish	WPS#
All Twin Cams	Raw	<b>825-02030</b>
	Black	<b>825-02031</b>
	Polished	<b>825-02032</b>
	Gold	<b>825-02033</b>
	Red	<b>825-02034</b>
	Blue	<b>825-02035</b>

## HEADBOLT COVERS

- CNC Machined 6061 Aluminum
- Six different anodized colored options
- Made in the USA

Application	Finish	WPS#
Evo and Twin Cam	Raw	<b>825-02090</b>
	Black	<b>825-02091</b>
	Polished	<b>825-02092</b>
	Gold	<b>825-02093</b>
	Red	<b>825-02094</b>
	Blue	<b>825-02095</b>





### CHROME HEADBOLT COVERS

- Smooth chrome head bolt covers
- Include mounting hardware
- Sold in pairs

Description	Application	WPS#
Chrome Headbolt Covers	Twin Cam Models '99-17	<b>820-55200</b>
	XL Models '04-Up	<b>820-55201</b>

### FINNED HEADBOLT COVERS



- Cast aluminum finned head bolt covers
- Available in silver or wrinkle black to match the engine finish
- Give a cleaned up look on the left side of the engine
- Mounting hardware included



Description	Application	Silver	Black
Finned Headbolt Covers	Fuel Injected Twin Cam Models	<b>820-55202</b>	<b>820-55204</b>
	Carbureted Twin Cam Models	<b>820-55203</b>	<b>820-55205</b>
	XL Models '04-Up	<b>820-55207</b>	<b>820-55206</b>



### HEADBOLT COVERS

- CNC machined from billet aluminum
- Fit all 1/2", 12 point head bolts on Evo, Twin Cam and Sportster engines
- Attached with a set screw, installation wrench included

Application	Chrome	Black
'86-17 Big Twin and Sportster Models	<b>820-52365</b>	<b>820-52366</b>

- WINDSHIELDS / FAIRINGS
- AUDIO / COMMUNICATION
- SEATS / LUGGAGE
- BAR / MIRRORS / CONTROLS
- EXHAUST
- AIR / FUEL SYSTEMS
- ENGINE**
- TRANSMISSION / DRIVELINE
- GASKETS / SEALS
- ELECTRICAL
- LIGHTING
- CABLES
- BRAKES
- OIL FILTERS
- SUSPENSION
- BODY
- WHEELS
- TIRES / TIRE ACC.
- BIKE ACC.
- VICTORY / INDIAN
- COVERS / LOCKS / TIEDOWNS
- CHEMICALS
- TOOLS
- HELMETS
- HELMET ACC.
- EYEWEAR
- APPAREL / RIDER ACC.
- PROMOTIONAL
- REFERENCE
- INDEX



## CYLINDER STUDS

- These High Performance Cylinder studs are made from 180,000 psi yield strength, fine grain, heat treated, premium grade 8740 material
- Threads are rolled after heat treating to insure maximum compressive stresses are retained, insuring maximum strength, and the longest fatigue life possible
- The case end threads are designed to have a slight interference fit to maintain good thread contact at high temperature
- Studs are center less ground to insure concentricity, and finished with a premium black oxide treatment , excellent appearance



Description	Year	WPS#
Twin Cam Cylinder Studs	'99-17	<b>191-57096</b>
EVO Big Twin Cylinder Studs	'84-99	<b>191-57086</b>
EVO Sportster Cylinder Studs	'86-17	<b>191-57085</b>

## CYLINDER DOWELS

- Cylinder alignment dowels are machined from steel and receive a black oxide surface treatment
- OEM Cylinder Alignment Dowels are often galled and distorted when removed during a top end job
- Quick, clean, easy, and accurate reassembly



Description	Application	WPS#
Cylinder Dowels 0.5575" O.D. (4pack)	All EVO Big Twin and XL models	<b>191-57087</b>
Cylinder Dowels 0.4365" O.D. (4pack)	All Twin Cam models	<b>191-57097</b>

# FEULING®

## CYL STUD KIT

- The strongest studs available!
- Feuling® studs are installed to a torque spec can be reused and carry a lifetime warranty
- Heat-treated 8740 chrome moly steel studs
- Stock replacement
- Kit includes 8 cylinder studs, moly assembly lubricant and thread sealant
- Made in the U.S.A.



Application	Year	Description	WPS#
Twin Cam	'99-17	Cylinder Stud Kit	<b>811-03001</b>
EVO Big Twin	'85-99	Cylinder Stud Kit	<b>811-03026</b>

WINDSHIELDS / FAIRINGS  
 AUDIO / COMMUNICATION  
 SEATS / LUGGAGE  
 BARS / MIRRORS / CONTROLS  
 EXHAUST  
 AIR / FUEL SYSTEMS  
**ENGINE**  
 TRANSMISSION / DRIVELINE  
 GASKETS / SEALS  
 ELECTRICAL  
 LIGHTING  
 CABLES  
 BRAKES  
 OIL FILTERS  
 SUSPENSION  
 BODY  
 WHEELS  
 TIRES / TIRE ACC.  
 BIKE ACC.  
 VICTORY / INDIAN  
 COVERS / LOCKS / TIEDOWNS  
 CHEMICALS  
 TOOLS  
 HELMETS  
 HELMET ACC.  
 EYEWEAR  
 APPAREL / RIDER ACC.  
 PROMOTIONAL  
 REFERENCE  
 INDEX





A



B



## HEADBOLT KITS

- Add a custom look to your bike
- Made in the USA!
- 830-1100 replaces OEM 16480-85A and 16478-85A
- 830-1101 replaces OEM 16480-92 and 16478-85A

	Description	Application	WPS#
A	Polished and chrome plated 12 point custom dome headbolts	'92-16 Big Twin and '93-Up XL models	<b>830-1101</b>
B		'85-91 Big Twin and '86-92 XL models	<b>830-1100</b>



## EXHAUST STUD KIT

- Quality 12-point heat treated 8740 chrome moly steel bolts with black oxide finish
- Tensile strength rated @ 170,000 psi - Superior & Stronger than OEM & stronger than grade 8 fasteners
- Kits include moly assembly lubricant for installation
- Made in the U.S.A

Application	Year	Description	WPS#
EVO Big Twin	'85-99	Exhaust Kit Stud	<b>811-03048</b>
Twin Cam	'99-17	Exhaust Stud Kit	<b>811-03048</b>



## EXHAUST STUDS

- Kit comes in a 4 pack
- Made in the USA

Description	WPS#
Exhaust Stud kit	<b>830-1086</b>
Exhaust Studs 10pk	<b>830-1084</b>
Chrome Flange nut 10pk	<b>830-1085</b>

- WINDSHIELDS / FAIRINGS
- AUDIO / COMMUNICATION
- SEATS / LUGGAGE
- BAR / MIRRORS / CONTROLS
- EXHAUST
- AIR / FUEL SYSTEMS
- ENGINE
- TRANSMISSION / DRIVELINE
- GASKETS / SEALS
- ELECTRICAL
- LIGHTING
- CABLES
- BRAKES
- OIL FILTERS
- SUSPENSION
- BODY
- WHEELS
- TIRES / TIRE ACC.
- BIKE ACC.
- VICTORY / INDIAN
- COVERS / LOCKS / TIEDOWNS
- CHEMICALS
- TOOLS
- HELMETS
- HELMET ACC.
- EYEWEAR
- APPAREL / RIDER ACC.
- PROMOTIONAL
- REFERENCE
- INDEX

# FEULING<sup>®</sup>

## CYL STUD & HEAD BOLT KIT

- The strongest studs & bolts available!
- Top engine builders demand quality fasteners! Secure your engine with complete confidence
- Superior in strength and performance to any other cylinder stud head bolt kit on the market, this kit is designed to exceed the needs of high performance engines.
- Dont Risk Head Gasket Failure!
- Stock Cylinder studs are designed as a stretch to torque stud with a one time use only lifespan
- Feuling<sup>®</sup> studs are installed to a torque spec can be reused and carry a lifetime warranty
- Heat-treated 8740 chrome moly steel studs
- Precision j-form threads for optimum engagement, to prevent galling and promote more consistent torque loading.
- Special alloyed stainless steel head bolts
- Manufactured by ARP<sup>®</sup> to Feulings<sup>®</sup> exact specifications
- Recommended for all V-Twin engines
- Stock replacement
- Kit includes 8 cylinder studs, 8 head bolts, moly assembly lubricant and thread sealant
- Made in the U.S.A.



Application	Year	Description	WPS#
Twin Cam	'99-17	Cyl Stud/Head Bolt Kit	811-03000

## HEAD BOLT KIT

- The strongest bolts available!
- Top engine builders demand quality fasteners! Secure your engine with complete confidence
- Superior in strength and performance to any other cylinder stud head bolt kit on the market, this kit is designed to exceed the needs of high performance engines.
- Dont Risk Head Gasket Failure!
- Precision j-form threads for optimum engagement, to prevent galling and promote more consistent torque loading.
- Special alloyed stainless steel head bolts
- Manufactured by ARP<sup>®</sup> to Feulings<sup>®</sup> exact specifications
- Recommended for all V-Twin engines
- Stock replacement
- Kit includes 8 head bolts, moly assembly lubricant and thread sealant
- Made in the U.S.A.



Application	Year	Description	WPS#
Sportster models	'92-10	Head Bolt Kit	811-03005
Big Twin models	'85-17	Head Bolt Kit	811-03005

WINDSHIELDS / FAIRINGS

AUDIO / COMMUNICATION

SEATS / LUGGAGE

BARS / MIRRORS / CONTROLS

EXHAUST

AIR / FUEL SYSTEMS

ENGINE

TRANSMISSION / DRIVELINE

GASKETS / SEALS

ELECTRICAL

LIGHTING

CABLES

BRAKES

OIL FILTERS

SUSPENSION

BODY

WHEELS

TIRES / TIRE ACC.

BIKE ACC.

VICTORY / INDIAN

COVERS / LOCKS / TIEDOWNS

CHEMICALS

TOOLS

HELMETS

HELMET ACC.

EYEWEAR

APPAREL / RIDER ACC.

PROMOTIONAL

REFERENCE

INDEX

## STABILIZER LINKS

- Replaces front and top mount on FLT, FXR applications
- Replaces top mount on Dynas
- Chrome finish
- Sold each



Description	Application	Chrome
Shock Type Engine Stabilizer Link	Fits Front and Top Mount on '84-08 FXR, FLT and Top Mount on Dynas	<b>820-52280</b>
Stock Replacement Stabilizer Link	Fits '84-08 FXR, FLT Models and '91-94 Dynas Fits '95-05 Dyna Models	<b>820-52281</b> <b>820-52282</b>
Heavy Duty Top Motor Mount	Rplaces OEM 69013-87T	<b>820-51449</b>

## MOTOR MOUNTS

- Quality replacement urethane rubber motor mounts
- For Touring, Dyna and FXR models
- Heavy duty polyurethane chrome front motor mount available for FLT, FXR models



Description	Application	WPS#
Rear Motor Mount	Fits '91-98 Dyna Models Fits '99-17 Dyna Models	<b>820-51450</b> <b>820-51451</b>
Front Motor Mount	Fits '91-17 Dyna Models Fits '82-94 FXR Models and '80-08 FLT, FLHT Models	<b>820-51452</b> <b>820-51453</b>
Front Motor Mount (Polyurethane)	Fits '82-94 FXR Models and '80-08 FLT, FLHT Models	<b>820-2633</b>

## ISOLATOR MOTOR MOUNTS

- The new precision made Solo isolator kits include all parts needed to replace front & rear isolator mounts on XL models
- Front kit includes Isolator mount, Isolators, Center bolt, Nut, Isolator mount screws
- Rear kits includes Isolator mount, Isolators, lock plate, pivot shaft, Isolator mount screws & lock plate screws
- Front & rear kits Sold separately



Description	WPS#
Front kit for '04-17 XL models	<b>820-52277</b>
Rear kit for '04-13 XL models	<b>820-52278</b>
Rear kit for '14-17 XL models	<b>820-52279</b>

WINDSHIELDS / FAIRINGS

AUDIO / COMMUNICATION

SEATS / LUGGAGE

BAR / MIRRORS / CONTROLS

EXHAUST

AIR / FUEL SYSTEMS

**ENGINE**

TRANSMISSION / DRIVELINE

GASKETS / SEALS

ELECTRICAL

LIGHTING

CABLES

BRAKES

OIL FILTERS

SUSPENSION

BODY

WHEELS

TIRES / TIRE ACC.

BIKE ACC.

VICTORY / INDIAN

COVERS / LOCKS / TIEDOWNS

CHEMICALS

TOOLS

HELMETS

HELMET ACC.

EYEWEAR

APPAREL / RIDER ACC.

PROMOTIONAL

REFERENCE

INDEX

- WINDSHIELDS / FAIRINGS
- AUDIO / COMMUNICATION
- SEATS / LUGGAGE
- BAR / MIRRORS / CONTROLS
- EXHAUST
- AIR / FUEL SYSTEMS
- ENGINE**
- TRANSMISSION / DRIVELINE
- GASKETS / SEALS
- ELECTRICAL
- LIGHTING
- CABLES
- BRAKES
- OIL FILTERS
- SUSPENSION
- BODY
- WHEELS
- TIRES / TIRE ACC.
- BIKE ACC.
- VICTORY / INDIAN
- COVERS / LOCKS / TIEDOWNS
- CHEMICALS
- TOOLS
- HELMETS
- HELMET ACC.
- EYEWEAR
- APPAREL / RIDER ACC.
- PROMOTIONAL
- REFERENCE
- INDEX



## SWINGARM RUBBER ISOLATOR MOUNT

- Meets or exceeds OEM specifications
- Sold each

Application	WPS#
'86-08 Touring and '86-94 FXR models (Repl. OEM 47564-86)	<b>820-5383</b>



## EARLY SPORTSTER FRONT MOTOR MOUNTS

Chrome lower front motor mounts.



Description	Application	WPS #
Front Motor Mounts	Fits '54-78 K Model and Sportsters	<b>830-3600</b>

## TWIN CAM MOTOR ADAPTER PLATE

Adapter Plate for Twin Cam 'A' motors to Evo style frames. Will NOT work with counterbalanced motors.

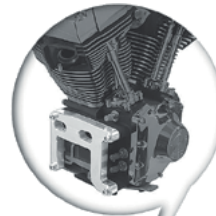

Description	WPS #
Twin Cam Engine Adapter	<b>830-3601</b>

## ENGINE SKID PLATES



Triple chrome plated skid plates, ideal for the protection of the crankcases on your 1941–1984 Big Twin (will not fit Evolutions).

Application	Description	WPS #
A Fits '41-84 Frames	Engine Skid Plate Smooth	<b>830-3900</b>
B	Engine Skid Plate Ribbed	<b>830-3901</b>





R O O K E



### OIL DIPSTICK CAPS

- CNC Machined 6061 aluminum
- Six different anodized colored options
- Clips on to OEM cap (remove OEM cover from dipstick with screwdriver)
- Distinct Rooke design
- Made in the USA

Application	Finish	WPS#
'07-16 FLH/FLT, '06-17 FXD	Raw	<b>825-02200</b>
	Black	<b>825-02201</b>
	Polished	<b>825-02202</b>
	Gold	<b>825-02203</b>
	Red	<b>825-02204</b>
	Blue	<b>825-02205</b>



### TRANSMISSION DIPSTICKS

- CNC Machined 6061 aluminum
- Six different anodized colored options
- Replaces OEM transmission dip stick #37065-06
- Made in the USA

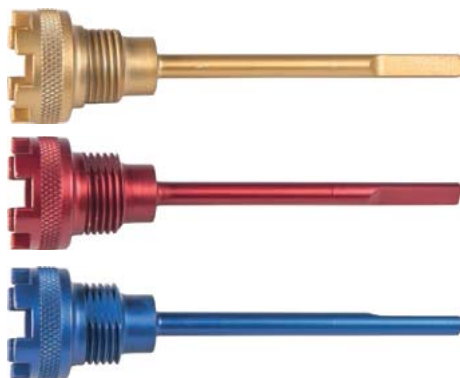

Application	Finish	WPS#
'07-17 FLH/FLT and Softails, '06-17 Dynas	Raw	<b>825-02213</b>
	Black	<b>825-02214</b>
	Polished	<b>825-02215</b>
	Gold	<b>825-02210</b>
	Red	<b>825-02211</b>
	Blue	<b>825-02212</b>

- WINDSHIELDS / FAIRINGS
- AUDIO / COMMUNICATION
- SEATS / LUGGAGE
- BAR / MIRRORS / CONTROLS
- EXHAUST
- AIR / FUEL SYSTEMS
- ENGINE**
- TRANSMISSION / DRIVELINE
- GASKETS / SEALS
- ELECTRICAL
- LIGHTING
- CABLES
- BRAKES
- OIL FILTERS
- SUSPENSION
- BODY
- WHEELS
- TIRES / TIRE ACC.
- BIKE ACC.
- VICTORY / INDIAN
- COVERS / LOCKS / TIEDOWNS
- CHEMICALS
- TOOLS
- HELMETS
- HELMET ACC.
- EYEWEAR
- APPAREL / RIDER ACC.
- PROMOTIONAL
- REFERENCE
- INDEX



## OIL DIPSTICK & FILLER CAPS

- Oil temp gauges are non liquid filled
- 50-350°F
- Chrome oil filler cap is a great way to customize any bike



	Description	Application	WPS#
A	Black Face oil dipstick 2 7/8" w/ temp gauge	'00-17 Softail	<b>820-2635</b>
B	Black Face oil dipstick 2 3/4" w/ temp gauge	'84-99 FXST and '82-03 XL	<b>820-2655</b>
	Chrome oil filler cap w/ short dipstick	'84-99 FXST and '82-03 XL	<b>820-2643</b>
C	Chrome circle lined oil filler cap w/ short dipstick	'84-99 FXST and '82-03 XL	<b>820-2646</b>
D	Chrome oil filler cap	'65-up H-D models	<b>820-2644</b>
E	Chrome circle lined oil filler cap	'65-up H-D models	<b>820-2645</b>



## BRASS OIL TANK CAP

Brass push-in rubber filler plug for side fill tanks, no dipstick. Sold each.



Description	WPS #
Brass Oil Tank Cap	<b>830-3380</b>



## LIQUID FILLED OIL PRESSURE GAUGES



- Premium quality 1½" diameter, 60 psi, 1/8" NPT rear mount oil pressure gauges
- Solid brass internals are bathed in vibration dampening glycerin
- Stainless steel bodies are available in polished and new Stealth Black



Finish	WPS#
Polished	274-0001
Black	274-0002



## OIL PRESSURE GAUGE



- Universal oil pressure gauge, can be used in many applications.
- Fittings and brackets not included.

Description	Application	WPS#
Oil Pressure Gauge 60 PSI		820-50906



## OIL FILTER HOUSING

- Meets OEM specifications
- Chrome finish
- Accepts all EVO style oil filters

Description	Application	OEM#	WPS#
Chrome oil filter housing w/ fitting	'92-99 Big Twin models	26381-92A	820-2680

- WINDSHIELDS / FAIRINGS
- AUDIO / COMMUNICATION
- SEATS / LUGGAGE
- BAR / MIRRORS / CONTROLS
- EXHAUST
- AIR / FUEL SYSTEMS
- ENGINE**
- TRANSMISSION / DRIVELINE
- GASKETS / SEALS
- ELECTRICAL
- LIGHTING
- CABLES
- BRAKES
- OIL FILTERS
- SUSPENSION
- BODY
- WHEELS
- TIRES / TIRE ACC.
- BIKE ACC.
- VICTORY / INDIAN
- COVERS / LOCKS / TIEDOWNS
- CHEMICALS
- TOOLS
- HELMETS
- HELMET ACC.
- EYEWEAR
- APPAREL / RIDER ACC.
- PROMOTIONAL
- REFERENCE
- INDEX



### OIL PRESSURE SWITCHES

- Protect your valuable engine with a reliable oil pressure switch
- Our stringent quality control standards assure accurate pressure every time
- Heavy duty contacts, brass ferrules and corrosion resistant plated steel shells are used for durability



	Model	Year	OEM#	WPS#
A	Sportster	'77-92	26554-77	<b>274-0211</b>
B	Big Twins	'84-99	25651-84	<b>274-0212</b>
C	Big Twins	'41-83	26552-72	<b>274-0210</b>



### OIL SPOUT & DIPSTICK

- Billet aluminum machined oil spout
- Thread in dipstick. No high rpm dipstick blow outs
- Compatible with all LSD gearsets/ bearing doors on the market for 1993-2006 FLH/ FLT Models
- Looks light-years cooler than the stock, cast, bat wing cover oil spout thing
- 2 Year Limited Warranty



Application	Description	Year	Black Anodized	Chrome	Polished
Touring Models	Oil Spout and Dipstick	'93-98	<b>821-1073</b>	<b>821-1072</b>	<b>821-1071</b>
		'99-01	<b>821-1076</b>	<b>821-1075</b>	<b>821-1074</b>
		'02-06	<b>821-1079</b>	<b>821-1078</b>	<b>821-1077</b>



## CRANKCASE VENT AIR FILTERS



### REMOTE MOUNT

Designed for racing engines where crankcase breathing is essential. Prevents dirt from entering engine on deceleration. Comes in two styles: Remote Mount with rubber top uses tubing to connect filter and vent. Remote Mount with chrome top has 1/4" stud and nut to mount in convenient place.



Vent Size	K&N	Remote Mount	WPS#
<b>2" DIA. X 1 1/2" METAL BASE</b>			
3/8"	62-1000	Rubber	<b>62-0100</b>
1/2"	62-1010	Rubber	<b>62-0101</b>
3/4"	62-1030	Rubber	<b>62-0103</b>
1/2"	62-1100	Chrome - w/stud	<b>62-0110</b>
5/8"	62-1110	Chrome - w/stud	<b>62-0111</b>
3/4"	62-1120	Chrome - w/stud	<b>62-0112</b>
1"	62-1130	Chrome - w/stud	<b>62-0113</b>
<b>3" TOP &amp; 2" LONG</b>			
1/2"	62-1050	Rubber	<b>62-0105</b>

*Legal in California ONLY for racing vehicles which may NEVER be used upon a highway*

### DIRECT MOUNT

#### UNIVERSAL CLAMP-ON STYLE CRANKCASE FILTERS

Filters clamp directly to vent tubes on valve cover or crankcase. Ideal for all engines, transmissions, oil and gas tanks.



Vent Size	K&N	Direct Mount	WPS#
<b>2" DIA. X 1 1/2"</b>			
1/2"	62-1330	Chrome Top	<b>62-0133</b>
5/8"	62-1340	Chrome Top	<b>62-0134</b>
3/4"	62-1360	Chrome Top	<b>62-0136</b>
1"	62-1370	Chrome Top	<b>62-0137</b>
<b>3" DIA. X 2 1/4"</b>			
1"	62-1420	Chrome Top	<b>62-0142</b>
1 1/4"	62-1380	Rubber Top	<b>62-0138</b>
1 1/4"	62-1390	Chrome Top	<b>62-0139</b>

#### UNIVERSAL ADAPTER

Universal 1/2 Valve cover vent adapter requires drilling 5/8" hole in valve cover **85-1050**



## CRANKCASE BREATHERS

- Crankcase vent filter with base
- For 3/8" hose
- Chrome finish
- Replacement filter available
- Sold each

Description	WPS#
A Crankcase Breather Assembly	<b>820-51578</b>
B Replacement filter (for 820-51578)	<b>820-51579</b>
C Dual Breather Filter	<b>820-51580</b>

## CRANKCASE VENTING SYSTEM

- Prevents blown or weeping gaskets
- Produces the proper amount of vacuum in the crankcase, at all RPM ranges
- Your engine gains quicker throttle response
- You'll gain 2-8% of usable rear wheel horsepower
- It snaps open for easy cleaning, and is light weight, compact and not restricted to position to fit all H-D models



Application	Year	WPS#
<b>HARLEY-DAVIDSON</b>		
Big Twins/Sportsters	All	<b>39-1206</b>

## THE 'OIL' FIX

- Fixes problem leaks associated with the base gasket
- With the oil control jet installed into the crankcase, the oil doesn't touch the gasket, thereby no leaking through the base gasket
- Oil Fix control jets control the oil coming from the head through the barrel and into the case



Application	Year	WPS#
<b>HARLEY-DAVIDSON</b>		
Big Twins	All	<b>39-1207</b>

- WINDSHIELDS / FAIRINGS
- AUDIO / COMMUNICATION
- SEATS / LUGGAGE
- BAR / MIRRORS / CONTROLS
- EXHAUST
- AIR / FUEL SYSTEMS
- ENGINE
- TRANSMISSION / DRIVELINE
- GASKETS / SEALS
- ELECTRICAL
- LIGHTING
- CABLES
- BRAKES
- OIL FILTERS
- SUSPENSION
- BODY
- WHEELS
- TIRES / TIRE ACC.
- BIKE ACC.
- VICTORY / INDIAN
- COVERS / LOCKS / TIEDOWNS
- CHEMICALS
- TOOLS
- HELMETS
- HELMET ACC.
- EYEWEAR
- APPAREL / RIDER ACC.
- PROMOTIONAL
- REFERENCE
- INDEX



# HORIZONTAL OIL COOLERS

X



A

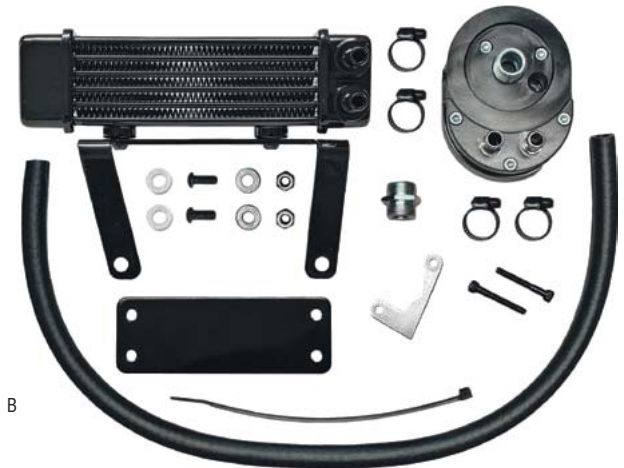

B



C



D

	Model	Year	Black	Chrome	Fan-Assisted
A	Dyna	'91-17	<b>821-2012</b>	<b>821-2013</b>	<b>821-2014</b>
B	Softail *	'00-17	<b>821-2011</b>		
C	Touring	'84-08	<b>821-2006</b>	<b>821-2007</b>	<b>821-2008</b>
D	Touring †	'09-16	<b>821-2009</b>		<b>821-2010</b>

\* Will not fit models equipped with ABS  
 † Will not fit models equipped with liquid cooled heads

- WINDSHIELDS / FAIRINGS
- AUDIO / COMMUNICATION
- SEATS / LUGGAGE
- BARS / MIRRORS / CONTROLS
- EXHAUST
- AIR / FUEL SYSTEMS
- ENGINE**
- TRANSMISSION / DRIVELINE
- GASKETS / SEALS
- ELECTRICAL
- LIGHTING
- CABLES
- BRAKES
- OIL FILTERS
- SUSPENSION
- BODY
- WHEELS
- TIRES / TIRE ACC.
- BIKE ACC.
- VICTORY / INDIAN
- COVERS / LOCKS / TIEDOWNS
- CHEMICALS
- TOOLS
- HELMETS
- HELMET ACC.
- EYEWEAR
- APPAREL / RIDER ACC.
- PROMOTIONAL
- REFERENCE
- INDEX



## VERTICAL FRAME MOUNT OIL COOLERS

x



Deluxe



Slimline

Model	Year	Deluxe	Chrome	Slimline
Sportster	'86-17	821-2000	821-2001	821-2002
FXR	'82-99	821-2000	821-2001	821-2002
Dyna	'91-17	821-2000	821-2001	821-2002
Softail	'84-17	821-2000	821-2001	821-2002
Touring *	'84-16	821-2000	821-2001	821-2002

## VERTICAL FRONT MOUNT WIDELINE OIL COOLERS



Wideline



Wideline Chrome



Fan Assisted

Model	Year	Wideline	Wideline Chrome	Fan-Assisted
Sportster	'86-17	821-2003	821-2004	821-2005
FXR	'82-99	821-2003	821-2004	821-2005
Dyna	'91-17	821-2003	821-2004	821-2005
Softail	'84-17	821-2003	821-2004	821-2005
Touring *	'84-16	821-2003	821-2004	821-2005

- WINDSHIELDS / FAIRINGS
- AUDIO / COMMUNICATION
- SEATS / LUGGAGE
- BAR / MIRRORS / CONTROLS
- EXHAUST
- AIR / FUEL SYSTEMS
- ENGINE**
- TRANSMISSION / DRIVELINE
- GASKETS / SEALS
- ELECTRICAL
- LIGHTING
- CABLES
- BRAKES
- OIL FILTERS
- SUSPENSION
- BODY
- WHEELS
- TIRES / TIRE ACC.
- BIKE ACC.
- VICTORY / INDIAN
- COVERS / LOCKS / TIEDOWNS
- CHEMICALS
- TOOLS
- HELMETS
- HELMET ACC.
- EYEWEAR
- APPAREL / RIDER ACC.
- PROMOTIONAL
- REFERENCE
- INDEX

- WINDSHIELDS / FAIRINGS
- AUDIO / COMMUNICATION
- SEATS / LUGGAGE
- BARS / MIRRORS / CONTROLS
- EXHAUST
- AIR / FUEL SYSTEMS
- ENGINE**
- TRANSMISSION / DRIVELINE
- GASKETS / SEALS
- ELECTRICAL
- LIGHTING
- CABLES
- BRAKES
- OIL FILTERS
- SUSPENSION
- BODY
- WHEELS
- TIRES / TIRE ACC.
- BIKE ACC.
- VICTORY / INDIAN
- COVERS / LOCKS / TIEDOWNS
- CHEMICALS
- TOOLS
- HELMETS
- HELMET ACC.
- EYEWEAR
- APPAREL / RIDER ACC.
- PROMOTIONAL
- REFERENCE
- INDEX



## GASKET SERVICE KIT



Description	WPS#
Gasket service kit	821-2020

## OIL HOSE UPGRADE



Description	WPS#
Lightweight fiber braided hose	821-2022
Stainless-steel braided hose	821-2023

## OIL COOLERS BLACK HOSE CLAMP



Description	WPS#
7/8" OD black hose clamps (10pk)	821-2021



## OIL FILTER OFFSET ADAPTER NEW



Description	Application	WPS #
Offset Oil Filter Adapter	TC 88/95 Models	820-0704
Offset Oil Filter Adapter	Evo Big Twin and Sportsters	820-0705



## RED EAGLE CLUTCH PACK

Application	Year	WPS #
Sportster	'57-70	<b>810-4116</b>
Sportster	'71-83	<b>810-4110</b>
Sportster	'84-90	<b>810-4111</b>
Sportster	'91-16	<b>810-4112</b>
Big Twin	'41-67	<b>810-4113</b>
Big Twin w/ backing plate	'41-67	<b>810-4128</b>
Big Twin Backing Plate w/ rivets	'41-83	<b>810-4001</b>

Application	Year	WPS #
Big Twin	'67-83	<b>810-4114</b>
Big Twin w/ backing plate	'67-83	<b>810-4127</b>
Big Twin	'84-89	<b>810-4115</b>
Big Twin	'90-97	<b>810-4112</b>
Big Twin	'98-16	<b>810-4129</b>
Rivera Brute w/ steels	'90-06	<b>810-4171</b>
Rivera Pro w/ steels	'36-84	<b>810-4173</b>
Rivera Pro w/ steels	L '84-89	<b>810-4174</b>

## KOLENE® STEEL PLATE PACK



Application	Year	WPS #
Sportster	'57-70	<b>810-4150</b>
Sportster	'71-83	<b>810-4140</b>
Sportster	'84-90	<b>810-4141</b>
Sportster	'91-16	<b>810-4144</b>
Big Twin	'41-67	<b>810-4145</b>
Big Twin w/ anti-rattlers	'41-67	<b>810-4142</b>
Big Twin w/ small 6 lug design	'41-67	<b>810-4146</b>
Big Twin	'68-83	<b>810-4147</b>
Big Twin w/ anti-rattlers	'68-83	<b>810-4143</b>
Big Twin	'84-89	<b>810-4148</b>
Big Twin	'90-97	<b>810-4144</b>
Big Twin (except '17 Touring)	'98-17	<b>810-4151</b>



## COMPONENT PARTS

Description	Application	Year	WPS #
Spring separator plate	Big Twin	'90-97	<b>810-4169</b>
Diaphragm Spring	Big Twin	'84-89	<b>810-4003</b>
Diaphragm Spring	Big Twin (except '17 Touring)	'98-17	<b>810-4004</b>
Diaphragm Spring HD	Big Twin (except '17 Touring)	'98-17	<b>810-4004H</b>
Countershaft retainer 4-SPD 10pk	Big Twin	'71-83	<b>810-4005</b>
Crankcase bearing right retainer 10pk	Big Twin	'91-On	<b>810-4006</b>
Trans gear retainer ring 10pk	Big Twin	'91-On	<b>810-4007</b>
Steel Clutch Plate (Ea)	Big Twin	'41-83	<b>810-4160</b>
Steel Clutch Plate (Ea) w/ anti-rattlers	Big Twin	'41-83	<b>810-4161</b>
Steel Clutch Plate (Ea) w/ small 6 lug design	Big Twin	'41-83	<b>810-4162</b>
Spring Separator Plate (Ea)	Sportster	'91-17	<b>810-4169</b>

- WINDSHIELDS / FAIRINGS
- AUDIO / COMMUNICATION
- SEATS / LUGGAGE
- BAR / MIRRORS / CONTROLS
- EXHAUST
- AIR / FUEL SYSTEMS
- ENGINE
- TRANSMISSION / DRIVELINE**
- GASKETS / SEALS
- ELECTRICAL
- LIGHTING
- CABLES
- BRAKES
- OIL FILTERS
- SUSPENSION
- BODY
- WHEELS
- TIRES / TIRE ACC.
- BIKE ACC.
- VICTORY / INDIAN
- COVERS / LOCKS / TIEDOWNS
- CHEMICALS
- TOOLS
- HELMETS
- HELMET ACC.
- EYEWEAR
- APPAREL / RIDER ACC.
- PROMOTIONAL
- REFERENCE
- INDEX



## CARBONITE® CLUTCH KITS

This is our high end, highest heat resistance, and most durable product we offer. It is recommended for high end use and has been used in world class racing. It is very popular with the Police Drill Teams around the USA, because of its ability to slip and still maintain durability. It is far and away the best material available and comes with a lifetime warranty.

Carbonite® High Performance Clutch Kits are designed and engineered for maximum performance and durability in the most demanding performance applications.

### Carbon Carbonite® based friction material:

- Carbon offers superior coefficient of friction
- Carbon provides higher temperature capacity
- Decreases wear while increasing durability

### Single side extra capacity clutches reduce heat:

- Additional friction element increases surface area
- Additional steel elements increase conductivity
- Balanced temperature and rapid heat dissipation

Application	Year	WPS #
Sportster	'91-17	<b>810-4100</b>
Buell	'05-10	<b>810-4101</b>
Big Twin	'41-83	<b>810-4102</b>
Big Twin	'84-89	<b>810-4103</b>
Big Twin	'90-97	<b>810-4100</b>
Big Twin	'98-17 (except '17 Touring)	<b>810-4104</b>
Rivera Brute	'90-06	<b>810-4172</b>



## K2® KEVLAR CLUTCH PACK

This grade is a premium grade that offers similar heat resistance but is more durable and recommended for more heavy duty and hi torque applications. It is an economical alternative to OE and premium replacement material while offering significantly superior performance.

Application	Year	WPS #
Sportster	'57-70	<b>810-4123</b>
Sportster	'71-83	<b>810-4117</b>
Sportster	'84-90	<b>810-4118</b>
Sportster	'91-17	<b>810-4119</b>
Big Twin	'41-67	<b>810-4120</b>
Big Twin w/ backing plate	'41-67	<b>810-4125</b>
Big Twin	'67-83	<b>810-4121</b>
Big Twin w/ backing plate	'67-83	<b>810-4124</b>
Big Twin	'84-89	<b>810-4122</b>
Big Twin	'90-97	<b>810-4119</b>
Big Twin	'98-17 (except '17 Touring)	<b>810-4126</b>

### AFTERMARKET CLUTCHES

BDL Belt Drive w/ round dogs w/ steels		<b>810-4170</b>
BDL Chain Drive Clutch CC100-2 w/ steels	'36-84	<b>810-4179</b>
BDL Chain Drive Clutch CC120E w/ steels	'99-06	<b>810-4180</b>
Rivera Pro w/ steels Sportster	'91-17	<b>810-4175</b>
Rivera Pro w/ steels Big Twin	'90-97	<b>810-4176</b>
Rivera Pro w/ steels Evo/Twin Cam*	'98-06	<b>810-4177</b>

\* except '06 Dyna





## PERFORMANCE CLUTCHES

All clutch plates are made of either 6061 T6 or high-tempered steel with our own race proven friction material. Each plate design was tested so that maximum performance is achieved. Different groove patterns were designed for maximum oil circulation and heat dissipation. The steady flow of lubricant will cool and determine the longevity of your clutch.



### A

- Kit Includes 5 friction plates with tempered steel cores
- Maximum groove pattern for excellent heat dissipation & oil circulation (run wet or dry)
- Steel plates not included
- Made in the USA



### B

- Includes five friction plates (6061 T6 aluminum core)
- With maximum depth groove pattern for efficient heat dissipation and oil circulation
- Included are four tempered steel drive plates
- Made in the USA



### C

- High performance extra plate kit
- Includes 6 friction plates with 6061 T6 aluminum cores, 5 tempered steel drive plates and 10 Zero crush coil type clutch springs
- Stack height is preset for easy, accurate installation (run wet or dry)



### D

- Includes six friction plates with tempered steel cores and seven tempered steel drive plates
- 25% wider than OEM clutch plates for a significant increase in clutch area
- Stack height is preset for easy installation (run wet or dry)



### E

- High Performance Extra Plate Kit
- Includes nine friction plates on tempered steel cores, eight tempered steel drive plates and 15% stronger diaphragm spring
- Starburst groove pattern for maximum heat dissipation and oil circulation
- Preset stack height for easy installation
- 15% more clutch area for high performance strokers
- Remove OEM rivet plate!

Description	WPS#
	<b>810-5001</b>
	<b>810-5002</b>
C '41-84 Big Twin	<b>810-5003</b>
D '84-89 Big Twin	<b>810-5004</b>
E '90-97 Big Twin & '91-16 XL	<b>810-5006</b>

- WINDSHIELDS / FAIRINGS
- AUDIO / COMMUNICATION
- SEATS / LUGGAGE
- BAR / MIRRORS / CONTROLS
- EXHAUST
- AIR / FUEL SYSTEMS
- ENGINE
- TRANSMISSION / DRIVELINE**
- GASKETS / SEALS
- ELECTRICAL
- LIGHTING
- CABLES
- BRAKES
- OIL FILTERS
- SUSPENSION
- BODY
- WHEELS
- TIRES / TIRE ACC.
- BIKE ACC.
- VICTORY / INDIAN
- COVERS / LOCKS / TIEDOWNS
- CHEMICALS
- TOOLS
- HELMETS
- HELMET ACC.
- EYEWEAR
- APPAREL / RIDER ACC.
- PROMOTIONAL
- REFERENCE
- INDEX

- WINDSHIELDS / FAIRINGS
- AUDIO / COMMUNICATION
- SEATS / LUGGAGE
- BAR / MIRRORS / CONTROLS
- EXHAUST
- AIR / FUEL SYSTEMS
- ENGINE
- TRANSMISSION / DRIVELINE**
- GASKETS / SEALS
- ELECTRICAL
- LIGHTING
- CABLES
- BRAKES
- OIL FILTERS
- SUSPENSION
- BODY
- WHEELS
- TIRES / TIRE ACC.
- BIKE ACC.
- VICTORY / INDIAN
- COVERS / LOCKS / TIEDOWNS
- CHEMICALS
- TOOLS
- HELMETS
- HELMET ACC.
- EYEWEAR
- APPAREL / RIDER ACC.
- PROMOTIONAL
- REFERENCE
- INDEX



## PERFORMANCE CLUTCHES

All clutch plates are made of either 6061 T6 or high-tempered steel with our own race proven friction material. Each plate design was tested so that maximum performance is achieved. Different groove patterns were designed for maximum oil circulation and heat dissipation. The steady flow of lubricant will cool and determine the longevity of your clutch.

### F

- Includes nine friction plates on 6061 T6 aluminum cores and eight tempered steel drive plates
- Preset stack height for installation
- Made in the USA



### G

- High Performance Extra Plate Kit
- Includes 10 friction plates on 6061 T6 aluminum cores, tempered steel drive plates and a 10% stronger than stock diaphragm clutch spring
- Pre-measured stack height for easy, accurate installation
- Perfect for Hot Street or Stokers!



### H

- Includes friction plates on 6061 T6 aluminum cores, tempered steel drive plates and 5 ferro collapse coil type clutch springs
- Pre-measured stack height for easy, accurate installation



### I

- High Performance Extra Plate Kit
- Includes 10 friction plates on 6061 T6 aluminum cores, tempered steel drive plates and 5 ferro collapse coil type clutch springs
- Pre-measured stack height for easy, accurate installation
- 11% more surface area than stock



### J

- Includes 5 friction plates on tempered steel cores
- Starburst groove pattern for maximum heat dissipation and oil circulation
- Included are 5 tempered steel drive plates and a 15% stronger than stock diaphragm clutch spring
- Clutch has 15% more surface area and a pre-measured stack height for easy, accurate installation



Description	WPS#
F '98-17 Big Twin (except '17 Touring)	810-5007
G '98-17 Big Twin (except '17 Touring)	810-5008
H '02-07 V-Rod	810-5009
I '02-07 V-Rod	810-5010
J Buell Blast all years	810-5011





## RIVERA BRUTE REPLACEMENT CLUTCHES



Description	WPS#
A Replaces Primo Rivera #1048-0001	<b>810-5050</b>
B Replaces Primo Rivera #2048-0009	<b>810-5051</b>
B Replaces Primo Rivera #2048-0011	<b>810-5052</b>
A Replaces Primo Rivera #2048-0050	<b>810-5053</b>
A Replaces Primo Rivera #2048-0052	<b>810-5054</b>
A Replaces Primo Rivera #2048-0053	<b>810-5055</b>

- 10-5050 Repl. clutch kit for rute III Extreme for 07-Up Touring. Steels with 41 tooth spline, fibers with 6 teeth.
- 10-505 Repl. clutch kit for rute III and I Extreme and Slimline with new style hub. Steels with 41 tooth spline, fibers with 6 teeth
- 10-5054 Repl. clutch kit for Slimline with new style hub. Steels with 41 tooth spline, fibers with 6 teeth
- 10-5055 Repl. clutch kit for rute I Extreme for 07-Up Touring. Steels with 41 tooth spline, fibers with 6 teeth
- 10-5051 Repl. clutch kit for rute III and I with new style hub. Steels with 41 tooth spline, fibers with 6 teeth
- 10-5052 Repl. clutch kit for rute with new style hub. Steels with 41 tooth spline, fibers with 6 teeth

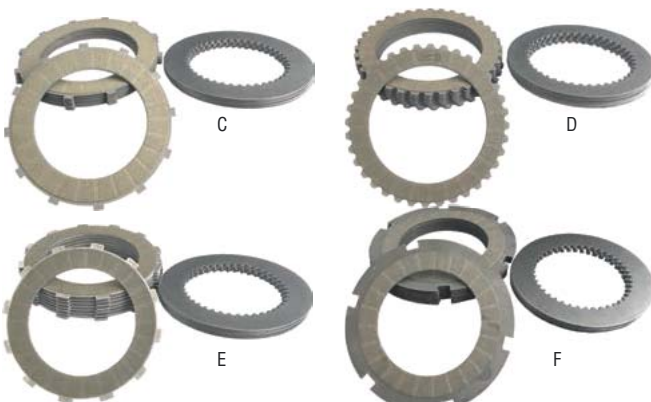

Description	WPS#
C Replaces Primo Rivera #1048-0005	<b>810-5056</b>
D Replaces Primo Rivera #1048-0007	<b>810-5057</b>
E Replaces Primo Rivera #1048-0012	<b>810-5058</b>
E Replaces Primo Rivera #1048-0013	<b>810-5059</b>
D Replaces Primo Rivera #1048-0029	<b>810-5060</b>
F Replaces Primo Rivera #1048-0041	<b>810-5061</b>
E Replaces Primo Rivera #1048-0200	<b>810-5062</b>

## PRO CLUTCH REPLACEMENT PLATES



- 10-5056 Repl. clutch kit for Pro Clutch for 6- Evo ig Twins. Steels with 41 tooth spline, fibers with 12 teeth
- 10-5057 Repl. clutch kit for Pro Clutch for 0- 7 Evo ig Twins. Steels with 41 tooth spline, fibers with 6 teeth
- 10-5060 Repl. clutch kit for Pro Clutch for 1-17 Sportster and 1-02 uell (except last). Steels with 41 tooth spline, fibers with 6 teeth
- 10-505 Repl. clutch kit for Pro Clutch for 06-10 Dynas and 07-10 ig Twins. Steels with 41 tooth spline, fibers with 12 teeth
- 10-505 Repl. clutch kit for Pro Clutch for -06 ig Twins (except 06 Dynas). Steels with 41 tooth spline, fibers with 12 teeth
- 10-5062 Repl. clutch kit for Pro Clutch for 11-17 Twin Cams. Steels with 41 tooth spline, fibers with 12 teeth
- 10-5061 Repl. clutch kit for Pro Clutch for 6- 4 ig Twins. Steels with 41 tooth spline, fibers with 6 teeth



## CLUTCH KIT FOR CVO MODELS



Replacement clutch kit for 201 - 2017 C O SE. Includes friction plates steel plates and ero collapse coil type clutch springs. Pre-measured stack height for easy installation and increased surface area over stock for maximum holding power

Description	WPS#
Fits most CVO Models '13-17	<b>810-5065</b>

## REPLACEMENT SPRINGS FOR PRO CLUTCH

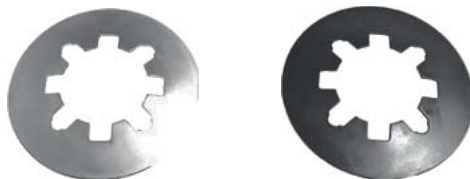

Direct replacement springs for River Primo diaphragm springs.

Description	WPS#
Replaces Rivera #2059-0003 (Silver)	<b>810-5070</b>
Replaces Rivera #2059-0001 (Black)	<b>810-5071</b>

- WINDSHIELDS / FAIRINGS
- AUDIO / COMMUNICATION
- SEATS / LUGGAGE
- BARS / MIRRORS / CONTROLS
- EXHAUST
- AIR / FUEL SYSTEMS
- ENGINE
- TRANSMISSION / DRIVELINE
- GASKETS / SEALS
- ELECTRICAL
- LIGHTING
- CABLES
- BRAKES
- OIL FILTERS
- SUSPENSION
- BODY
- WHEELS
- TIRES / TIRE ACC.
- BIKE ACC.
- VICTORY / INDIAN
- COVERS / LOCKS / TIEDOWNS
- CHEMICALS
- TOOLS
- HELMETS
- HELMET ACC.
- EYEWEAR
- APPAREL / RIDER ACC.
- PROMOTIONAL
- REFERENCE
- INDEX



## CLUTCH SHELLS & HUBS

- High quality replacement
- Meets or exceeds OE specs
- Available 4-Up for Big Twin models

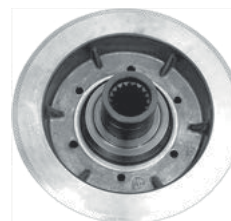
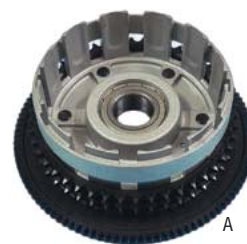

**Application**

**OEM#**

**WPS#**

**CLUTCH SHELLS**

A	'07-17 Big Twin models (except '17 Touring)	37813-06	<b>820-54681</b>
	'98-06 Twin Cam (except Dyna)	37707-98	<b>820-54687</b>
	'94-97 EVO Big Twin models	37707-94	<b>820-54686</b>
B	'90-93 Big Twin models	37707-90	<b>820-54685</b>
	w/ ring gear '85-89 Big Twin models (except '85 FXEF and FXST)	37707-84	<b>820-54683</b>
C	w/ ring gear '84-85 BigTwin models	37702-84A	<b>820-54684</b>

**CLUTCH HUBS**

D	'11-17 Big Twin models (except '17 Touring)	37554-11	<b>820-54680</b>
E	'07-10 Big Twin models (including '06 Dyna)	37554-06A	<b>820-54690</b>
	'98-06 Big Twin models (except '06 Dyna)	37550-98	<b>820-54689</b>
F	'90-97 Big Twin models	37550-90A	<b>820-54688</b>
G	'84-99 Big Twin	37550-84A	<b>820-54682</b>
H	'41-84 Big Twin	37550-41B	<b>820-54716</b>

**CLUTCH HUB NUT**

	'90-Up Big Twin	37496-90	<b>820-54717</b>
--	-----------------	----------	------------------

**PRESSURE PLATE**

	'41-84 Big Twin 10 Hole	38010-41	<b>820-54718</b>
--	-------------------------	----------	------------------



H



820-54718

## EASY START KITS

These kits improve starting on high compression engines through improved starter to clutch basket gear ratio. Complete kit includes a clutch basket with bearing, a 66T starter ring and a T starter pinion.

Description	Application	WPS#
A Easy Start Kit	94-97 Big Twins	<b>820-50950</b>
B Replacement 9T Pinion	98-06 Big Twins w/ 5spd	<b>820-50951</b>
		<b>820-50952</b>

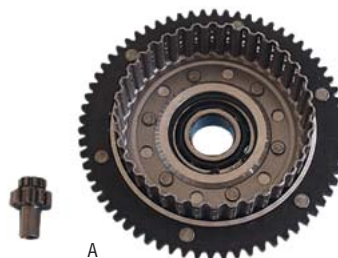

A

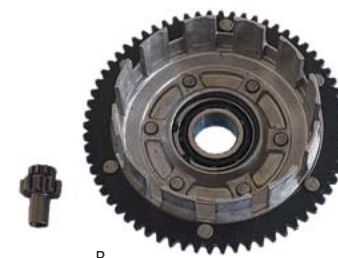

B

## CLUTCH PUSHRODS



Description	Replaces OEM #	Length	WPS#
A Fits FL Models '41-64	37285-41	13-1/4"	<b>820-53200</b>
B Fits FL Models '65-69	37285-65	13-1/2"	<b>820-53201</b>
C Fits FL/FX Models '70-74	37285-70	13-7/8"	<b>820-53202</b>
D Fits FL/FX Models '75-84	37285-75	14-1/8"	<b>820-53203</b>
E Fits 5-Speed Big Twins '84-89	37089-84	3-Piece Kit	<b>820-53204</b>

## CLUTCH PUSHROD ADJUSTERS

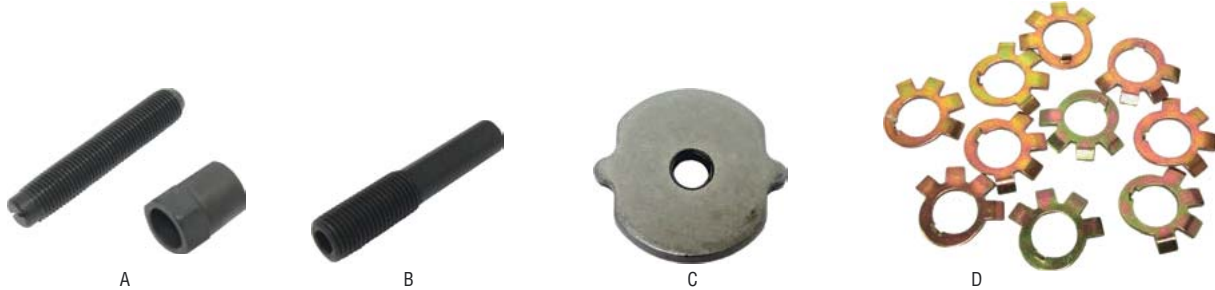

Description	Application	WPS#
A Clutch Adjuster Screw Kit (OEM 37361-41)	Fits '41-84 Big Twins	<b>820-53205</b>
B Clutch Pushrod Adjuster (OEM 37090-84A)	Fits '91-97 Big Twins	<b>820-53206</b>
C Clutch Release Plate (OEM 37903-90)	Fits '91-97 Big Twins	<b>820-53207</b>
D Clutch Nut Locktab (OEM 37503-41) 10 Pk		<b>820-53222</b>



## CLUTCH RELEASE KIT

Application	WPS#
Fits '87-99 Big Twins	<b>820-53209</b>

- WINDSHIELDS / FAIRINGS
- AUDIO / COMMUNICATION
- SEATS / LUGGAGE
- BARS / MIRRORS / CONTROLS
- EXHAUST
- AIR / FUEL SYSTEMS
- ENGINE
- TRANSMISSION / DRIVELINE**
- GASKETS / SEALS
- ELECTRICAL
- LIGHTING
- CABLES
- BRAKES
- OIL FILTERS
- SUSPENSION
- BODY
- WHEELS
- TIRES / TIRE ACC.
- BIKE ACC.
- VICTORY / INDIAN
- COVERS / LOCKS / TIEDOWNS
- CHEMICALS
- TOOLS
- HELMETS
- HELMET ACC.
- EYEWEAR
- APPAREL / RIDER ACC.
- PROMOTIONAL
- REFERENCE
- INDEX



## CLUTCH SPRINGS

OEM replacement

Application	WPS#	Quantity
Big Twin '68-83	<b>191-27790</b>	10pk
Big Twin '41-67	<b>191-27791</b>	10pk
Sportster '70-83	<b>191-27787</b>	1pk



## HIGH PERFORMANCE COMPENSATOR SPROCKET

- Engineered with heavier springs and increased travel to support the high torque output
- Designed to outperform the Original Equipment compensator
- Protects the engine and driveline components
- Compensator features improved oil passages, oil deflectors and a needle bearing thrust washer that improves the overall operation of the components



OEM#	Application	WPS#
42200064A	'12-13 Dyna models, '12-13 Softail models (except FXSB/SE), '11-13 Touring models, '09-13 Trike models	<b>820-54670</b>

## CLUTCH HUB KEYS

Application	WPS#
A Fits FL/FX Models '41-84 (Repl. OEM 37523-15) 10pk	<b>820-53211</b>
B Fits Big Twins '85-90 (Repl. OEM 37523-85D) 10pk	<b>820-53212</b>



## CLUTCH HUB BEARING

Description	Application	WPS#
Clutch Hub Bearing	'91-10 Big Twins	<b>22-53104</b>



WINDSHIELDS / FAIRINGS  
AUDIO / COMMUNICATION  
SEATS / LUGGAGE  
BARS / MIRRORS / CONTROLS  
EXHAUST  
AIR / FUEL SYSTEMS  
ENGINE  
TRANSMISSION / DRIVELINE  
GASKETS / SEALS  
ELECTRICAL  
LIGHTING  
CABLES  
BRAKES  
OIL FILTERS  
SUSPENSION  
BODY  
WHEELS  
TIRES / TIRE ACC.  
BIKE ACC.  
VICTORY / INDIAN  
COVERS / LOCKS / TIEDOWNS  
CHEMICALS  
TOOLS  
HELMETS  
HELMET ACC.  
EYEWEAR  
APPAREL / RIDER ACC.  
PROMOTIONAL  
REFERENCE  
INDEX



820-52600



820-52605

### MOTOR SPROCKETS

Big Twin motor sprockets for tapered or splined shafts available in various tooth counts.

Description	23 Tooth	24 Tooth	25 Tooth
'36-54	<b>820-52600</b>	<b>820-52601</b>	<b>820-52602</b>
'55-84	<b>820-52603</b>	<b>820-52604</b>	<b>820-52605</b>



### MOTOR SPROCKET KEYS

Application	WPS#
Fits FL '41-54, EL '36-40, UL '37-48 (Repl. OEM 23985-12) 10pk	<b>820-53213</b>



### COMPENSATOR ELIMINATOR SPROCKETS

- Much quieter than stock diaphragm spring style compensator
- Available in 32 and 34 tooth sprocket
- Improves starting and starter life

Description	Application	WPS#
34 tooth Sprocket	'07-17 Big Twin (except '17 Touring) and '06 Dyna models	<b>820-52650</b>
32 tooth sprocket	'07-17 Big Twin (except '17 Touring) and '06 Dyna models	<b>820-52651</b>

- WINDSHIELDS / FAIRINGS
- AUDIO / COMMUNICATION
- SEATS / LUGGAGE
- BAR / MIRRORS / CONTROLS
- EXHAUST
- AIR / FUEL SYSTEMS
- ENGINE
- TRANSMISSION / DRIVELINE**
- GASKETS / SEALS
- ELECTRICAL
- LIGHTING
- CABLES
- BRAKES
- OIL FILTERS
- SUSPENSION
- BODY
- WHEELS
- TIRES / TIRE ACC.
- BIKE ACC.
- VICTORY / INDIAN
- COVERS / LOCKS / TIEDOWNS
- CHEMICALS
- TOOLS
- HELMETS
- HELMET ACC.
- EYEWEAR
- APPAREL / RIDER ACC.
- PROMOTIONAL
- REFERENCE
- INDEX



## COMPENSATOR SPROCKETS

These compensator sprockets and components are direct OE replacements. Assemblies and components for offset primaries are also available.



820-52611 Assembled



820-52611



820-52612



820-52616



820-52618



820-52621



820-52629



820-52635

Description	OEM#	WPS#
<b>COMPLETE COMPENSATOR SPROCKET ASSEMBLIES</b>		
Fits '94-05 Big Twins 25T		<b>820-52606</b>
Fits '94-05 Big Twins 25T 1" Offset		<b>820-52607</b>
Fits '91-93 Big Twins 24T		<b>820-52608</b>
Fits '91-93 Big Twins 24T 1" Offset		<b>820-52609</b>
Fits '85-90 Softails 24T		<b>820-52610</b>
Fits '85-90 Rubber Mounted Big Twins 24T		<b>820-52611</b>
<b>COMPENSATOR W/ SPRINGS</b>		
Fits all Big Twins 91-05	40384-91	<b>820-52614</b>
Fits Softails '85-90	40384-83A	<b>820-52613</b>
Fits Rubber Mounted Big Twins '85-90	40267-85	<b>820-52612</b>
<b>SLIDING CAMS</b>		
Fits FXD Models '06-11 and FLT's '07-10	40333-06	<b>820-52617</b>
Fits Big Twins '85-05	40299-83A	<b>820-52616</b>
Fits Big Twins '70-83	40299-70	<b>820-52615</b>
<b>SPROCKET NUTS</b>		
Fits Big Twins '91-05 Stock Length	40392-91	<b>820-52621</b>
Fits Big Twins '91-05 1/2" Extended		<b>820-52622</b>
Fits Big Twins '91-05 1" Extended		<b>820-52623</b>
Fits Big Twins '91-05 1-1/2" Extended		<b>820-52624</b>
Fits Big Twins '91-05 1-3/4" Extended		<b>820-52625</b>
Fits Big Twins '70-90 Stock Length	40392-70	<b>820-52618</b>
Fits Big Twins '70-90 1/2" Extended		<b>820-52619</b>
Fits Big Twins '70-90 1" Extended		<b>820-52620</b>

Description	OEM#	WPS#
<b>SPROCKETS</b>		
Fits Big Twins '85-05 24T	40269-85A	<b>820-52629</b>
Fits Big Twins '85-05 25T	40308-94	<b>820-52630</b>
Fits Big Twins '06-11 34T	40320-06	<b>820-52631</b>
Fits Big Twins '70-86 22T	40280-70	<b>820-52626</b>
Fits Big Twins '70-86 23T	40282-70	<b>820-52627</b>
Fits Big Twins '70-86 24T	40275-70	<b>820-52628</b>
<b>SPROCKET SHAFTS</b>		
Fits FXD Models '06-11 and FLT's '07-10	40297-06	<b>820-52634</b>
Fits Softails '91-06 and 5 Speed BT '85-90 Stock Length	40266-85	<b>820-52635</b>
Fits Softails '91-06 and FXR and Touring '85-90 1/2" Extended		<b>820-52637</b>
Fits Softails '85-90 1/2" Extended		<b>820-52633</b>
Fits Big Twins '85-90 1/2" Extended		<b>820-52636</b>
Fits Big Twins '85-90 1" Extended		<b>820-52638</b>
Fits Big Twins '85-90 1-1/2" Extended		<b>820-52639</b>
Fits Big Twins '85-90 1-3/4" Extended		<b>820-52640</b>
Fits 4 Speed Big Twins '70-83 Stock	40375-70	<b>820-52632</b>



### PRIMARY CHAIN TENSIONERS

- Automatically adjust primary chain tension
- Assures proper chain tension during acceleration and deceleration
- Smoother shifting, transmission will “click” instead of “clunk”
- Provides a noticeably smoother ride

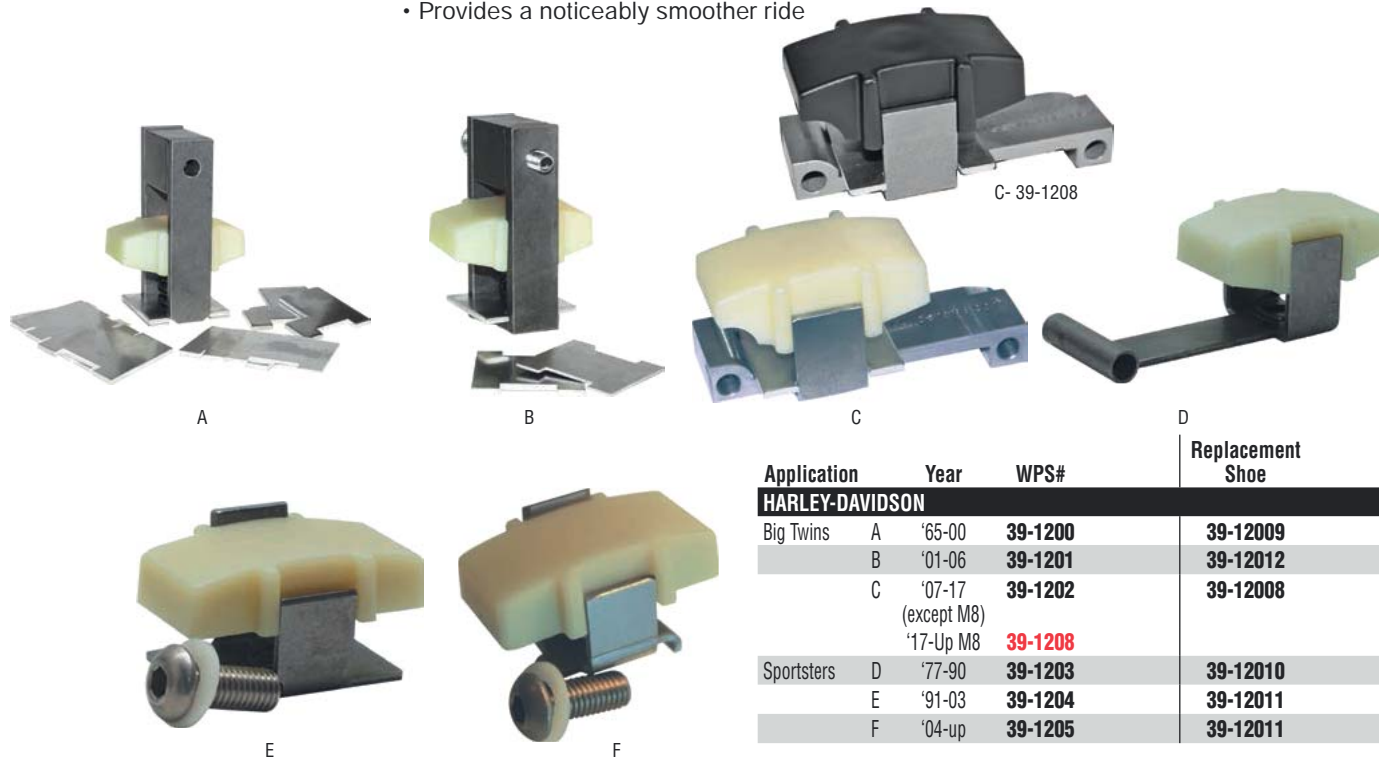

Application	Year	WPS#	Replacement Shoe
<b>HARLEY-DAVIDSON</b>			
Big Twins	A '65-00	39-1200	39-12009
	B '01-06	39-1201	39-12012
	C '07-17 (except M8) '17-Up M8	39-1202	39-12008
Sportsters	D '77-90	39-1203	39-12010
	E '91-03	39-1204	39-12011
	F '04-up	39-1205	39-12011

### MANUAL PRIMARY CHAIN ADJUSTER



- Ideal for bikes equipped with big displacement high performance engines
- Permits manual selection of primary chain tension and is a direct replacement for the original equipment automatic version
- The anodized billet aluminum adjuster allows you to fine tune & lock settings
- The manual adjustment locks the chain tension in place to prevent free play during severe shifting

Description	Application	WPS#
Manual Primary Chain Adjuster	Fits '06-16 Dynas, '07-16 Softails and Touring Models	820-52350
Replacement Shoe		820-51211



### FINE TOOTH ADJUSTMENT KIT



- The finer pitch teeth make it easier to dial in your primary chain slack
- The BAKER primary chain adjuster bracket looks like the stock 39990-01 style bracket but has 28% more adjuster teeth

Application	WPS #
'87-06 Big Twin Except 2006 Dyna	821-1064

- WINDSHIELDS / FAIRINGS
- AUDIO / COMMUNICATION
- SEATS / LUGGAGE
- BARS / MIRRORS / CONTROLS
- EXHAUST
- AIR / FUEL SYSTEMS
- ENGINE
- TRANSMISSION / DRIVELINE**
- GASKETS / SEALS
- ELECTRICAL
- LIGHTING
- CABLES
- BRAKES
- OIL FILTERS
- SUSPENSION
- BODY
- WHEELS
- TIRES / TIRE ACC.
- BIKE ACC.
- VICTORY / INDIAN
- COVERS / LOCKS / TIEDOWNS
- CHEMICALS
- TOOLS
- HELMETS
- HELMET ACC.
- EYEWEAR
- APPAREL / RIDER ACC.
- PROMOTIONAL
- REFERENCE
- INDEX



## PRIMARY CHAIN TENSIONER SHOES

- Direct replacement for the stock tensioner shoe
- Sold each

Description	Replaces OEM #	WPS#
A Fits XL Models '57-76	39978-58	<b>820-51205</b>
B Fits XL Models '57-76 w/Retainer	39978-58	<b>820-51206</b>
C Fits XL Models '80-90	39966-80	<b>820-51207</b>
D Fits XL Models '91-03 w/Adjuster	39975-90A	<b>820-51210</b>
E Fits Big Twins '65-00	39976-65B	<b>820-51208</b>
F Fits Big Twins '01-06	39976-01	<b>820-51209</b>



## PRIMARY CHAIN ADJUSTER LOCKTAB

- Sold on a card of 10

Description	Replaces OEM #	WPS#
Fits Big Twins '65-00	39996-55	<b>820-53208</b>

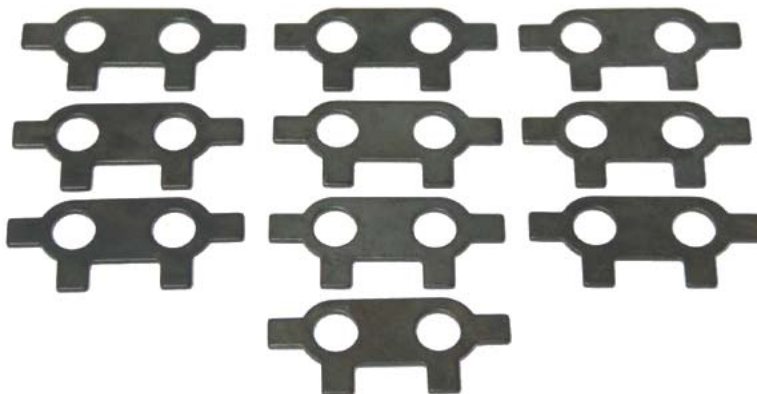

## PRIMARY CHAINS

- Double and triple row chains for most applications
- Endless chain design made from industrial strength materials

Description	Application	WPS #
Primary Chain 86 Link	'07-17 Touring repl. OEM 40037-07	<b>820-51203</b>
Primary Chain 92 Link	'07-17 Softail, '06-17 Dyna repl. OEM 40036-06	<b>820-51204</b>
Primary Chain 96 Link	'04-17 Sporty repl. OEM 40147-04	<b>820-51212</b>
Primary Chain 82 Link	84-06 FXST, FLST and '91-05 Dyna repl. OEM 40007-36A	<b>820-51200</b>
Primary Chain 76 Link	84-06 FLT and FXR repl. OEM 40037-79A	<b>820-51201</b>
Primary Chain 94 Link	84-03 XL and '04-14 XL883 repl. OEM 40005-57A	<b>820-51202</b>





## STARTER SHAFT BUSHINGS



- Suitable for stock and aftermarket primaries
- Sold each



A



B



C



D

Description	WPS#
A Starter Shaft Bushing INNER (Repl. OEM 33445-89)	<b>820-53300</b>
B Starter Shaft Bushing INNER (Repl. OEM 33445-94A)	<b>820-53301</b>
C Starter Shaft Bushing OUTER (Repl. OEM 33446-89)	<b>820-53302</b>
D Starter Shaft Bushing OUTER (Repl. OEM 33446-94A)	<b>820-53303</b>



A



B

## INSPECTION COVERS

- These new primary cover inspection covers are made from die-cast aluminum
- Available in chrome, black or polished aluminum
- Hardware kit included (gasket NOT included)
- Sold each

Description	OEM#	Polished	Chrome	Black
A Inspection cover for '85-06 FLH and '85-94 FXR w/ forward controls	60670-85A	<b>820-50804</b>	<b>820-50805</b>	<b>820-50806</b>
B * Inspection cover for '85-94 FXR w/ mid controls	60671-85A	<b>820-50807</b>	<b>820-50808</b>	<b>820-50809</b>

\*Has drilled hole for shifter shaft, bushing not included

## PRIMARY INSPECTION COVERS



Pro One billet inspection covers are CNC machined from solid billet aluminum, carefully polished, then show-chrome plated or anodized to perfection! Chrome hardware included. Fits 70-06 Harley-Davidson FX/FL, FXST/FLST, FXWG, 93-05 FXDWG Models.



Application	Description	Chrome	Black
Fit most '70-06 Models	Smooth	<b>812-02054</b>	<b>812-02055</b>

- WINDSHIELDS / FAIRINGS
- AUDIO / COMMUNICATION
- SEATS / LUGGAGE
- BAR / MIRRORS / CONTROLS
- EXHAUST
- AIR / FUEL SYSTEMS
- ENGINE
- TRANSMISSION / DRIVELINE**
- GASKETS / SEALS
- ELECTRICAL
- LIGHTING
- CABLES
- BRAKES
- OIL FILTERS
- SUSPENSION
- BODY
- WHEELS
- TIRES / TIRE ACC.
- BIKE ACC.
- VICTORY / INDIAN
- COVERS / LOCKS / TIEDOWNS
- CHEMICALS
- TOOLS
- HELMETS
- HELMET ACC.
- EYEWEAR
- APPAREL / RIDER ACC.
- PROMOTIONAL
- REFERENCE
- INDEX

- WINDSHIELDS / FAIRINGS
- AUDIO / COMMUNICATION
- SEATS / LUGGAGE
- BARS / MIRRORS / CONTROLS
- EXHAUST
- AIR / FUEL SYSTEMS
- ENGINE
- TRANSMISSION / DRIVELINE**
- GASKETS / SEALS
- ELECTRICAL
- LIGHTING
- CABLES
- BRAKES
- OIL FILTERS
- SUSPENSION
- BODY
- WHEELS
- TIRES / TIRE ACC.
- BIKE ACC.
- VICTORY / INDIAN
- COVERS / LOCKS / TIEDOWNS
- CHEMICALS
- TOOLS
- HELMETS
- HELMET ACC.
- EYEWEAR
- APPAREL / RIDER ACC.
- PROMOTIONAL
- REFERENCE
- INDEX



## INNER PRIMARY MOUNTING KITS



830-1143



830-1180



830-1181

Application	WPS#
Fits Dynas '99-05, Softails '00-06, Touring '01-06	<b>830-1143</b>
Fits Dynas '94-98, Softails '94-99	<b>830-1196</b>
Fits Dynas '91-93, Softails '86-93	<b>830-1195</b>
Fits Touring and FXR '86-00	<b>830-1197</b>

Application	WPS#
Fits '80-85 FL, FX	<b>830-1194</b>
Fits '70-79 FL, FX	<b>830-1193</b>
Fits '65-69 Big Twins	<b>830-1190</b>
Fits '55-64 Pan Heads	<b>830-1181</b>
Fits '36-54 Knuckles	<b>830-1180</b>



## INNER PRIMARY LOCK TABS

- Sold in packs of 10



Description	WPS#
Primary Locktabs 10 pk	<b>820-53223</b>

## INNER PRIMARY

- Made from durable die-cast aluminum
- Chrome or black finish available
- Hardware not included

Application	Finish	WPS#
'94-06 Softail	Chrome	<b>820-2672</b>
'89-93 Softail	Chrome	<b>820-2669</b>





## OUTER PRIMARY COVERS

- Made from rugged die-cast aluminum
- Chrome, Black and Satin black finished available
- No hardware included



Application	Finish	WPS#
'99-06 Touring models	Chrome	<b>820-54600</b>
'06-17 FXDWG, '12-16 FLD and '07-17 Softail	Chrome	<b>820-2629</b>
A '06-17 Dyna (except models with foward controls)	Chrome	<b>820-2631</b>
B '99-06 Softail and '99-05 Dyna	Chrome	<b>820-2670</b>
C '99-06 Softail and '99-05 Dyna	Satin Black	<b>820-2671</b>
'95-98 Softail and Dyna	Chrome	<b>820-2667</b>
'95-98 Softail and Dyna	Satin Black	<b>820-2668</b>
D '89-93 Softail and '91-93 Dyna	Chrome	<b>820-2665</b>
E '89-93 Softail and '91-93 Dyna	Satin Black	<b>820-2666</b>
F '94-03 Sportster	Chrome	<b>820-54601</b>
G '94-03 Sportster	Satin Black	<b>820-54602</b>



- WINDSHIELDS / FAIRINGS
- AUDIO / COMMUNICATION
- SEATS / LUGGAGE
- BARS / MIRRORS / CONTROLS
- EXHAUST
- AIR / FUEL SYSTEMS
- ENGINE
- TRANSMISSION / DRIVELINE**
- GASKETS / SEALS
- ELECTRICAL
- LIGHTING
- CABLES
- BRAKES
- OIL FILTERS
- SUSPENSION
- BODY
- WHEELS
- TIRES / TIRE ACC.
- BIKE ACC.
- VICTORY / INDIAN
- COVERS / LOCKS / TIEDOWNS
- CHEMICALS
- TOOLS
- HELMETS
- HELMET ACC.
- EYEWEAR
- APPAREL / RIDER ACC.
- PROMOTIONAL
- REFERENCE
- INDEX



## BIG TWIN PRIMARY COVERS

The EMD/Billy Boy primary cover is directly inspired by the design of the Panhead/ Knucklehead tin primary cover housings from the Forties. The Snatch primary cover design is inspired by the finned primary covers from the golden age of choppers. They install in place of your OEM primary cover and will bring the ultimate vintage, bobber and chopper look to your project!



Snatch



Snatch



Billy Boy



Snatch



JayDee

- Manufactured in die cast aluminum, CNC milled gasket surface
- OEM mounting hardware reusable
- Derby cover hardware included (chrome)
- Seal kit not included, please order separately
- Billy Boy cover available in "Raw" with chrome derby cover or "Black" with chrome derby cover

Description	Application	Raw	Black	Black Cut
Snatch Primary Cover	Fits '07-16 Touring Models	<b>866-05101</b>	<b>866-05102</b>	
	Fits '07-17 Softail Models	<b>866-05103</b>	<b>866-05104</b>	
	Fits '06-17 Dyna models	<b>866-05105</b>	<b>866-05106</b>	
Billy Boy Primary Cover	Fits '89-06 Softail Models	<b>866-05107</b>	<b>866-05111</b>	
	Fits '91-05 Dyna Models	<b>866-05109</b>	<b>866-05112</b>	
JayDee Primary Cover	Fits '07-16 Touring Models			<b>866-05100</b>

## SPORTSTER PRIMARY COVERS

Add a classic custom look to your ride with these EMD outer primary covers. They are made of cast aluminum and then CNC machined for precise, leak free fitment.

- Available in raw cast or black powder coat finish
- Add your personal touch by polishing or accenting the ribs or the entire piece
- Ribbed design is directly inspired by the finned primary covers from the golden age of Choppers!
- EMD/RIBSTER primary cover replaces your OEM primary cover and will radically change the look of your engine
- OEM mounting hardware reusable
- Gasket kit NOT SUPPLIED please order separately



Application	Description	WPS#
Fits '91-03 XL Models	Ribster Primary Cover Raw	<b>866-05001</b>
	Ribster Primary Cover Black	<b>866-05002</b>
Fits '04-17 XL Models	Ribster Primary Cover Raw	<b>866-05003</b>
	Ribster Primary Cover Black	<b>866-05004</b>

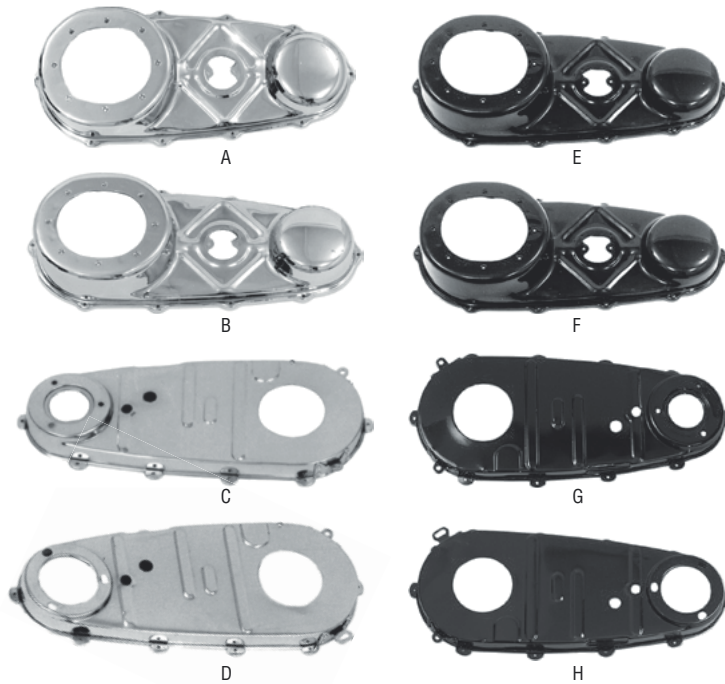

### TIN PRIMARIES



Stock replacement inner and outer primary covers for Knuckles and Pans. Available in chrome or gloss black.

Description	Chrome	Black
A Outer Primary '36-54	<b>830-3100</b>	E <b>830-3104</b>
B Outer Primary '55-64	<b>830-3101</b>	F <b>830-3105</b>
C Inner Primary '36-54	<b>830-3102</b>	G <b>830-3106</b>
D Inner Primary '55-64	<b>830-3103</b>	H <b>830-3107</b>

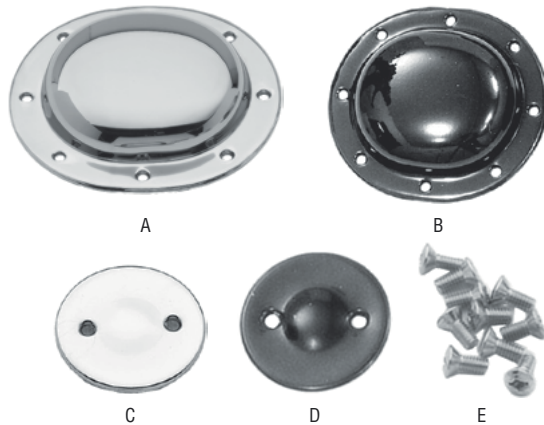

### TIN PRIMARY ACCESSORIES



Description	WPS #
A Derby Cover '36-64 Chrome	<b>830-3108</b>
B Derby Cover '36-64 Black	<b>830-3110</b>
C Inspection Cover '36-64 Chrome	<b>830-3109</b>
D Inspection Cover '36-64 Black	<b>830-3111</b>
Primary Cover Screws	<b>830-3112</b>
E Derby and Inspection Cover Screws	<b>830-3113</b>

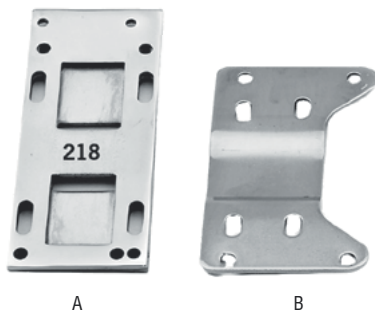

### TRANS MOUNTING PLATES



Mounting plates that will accommodate stock or aftermarket frames with four or five-speed transmissions from stock Knuckle-heads to modern customs.

Description	Application	WPS #
A 4-Spd Tranny Mounting Plate	Fits Paughco and Stock Rigid and Swingarm Frames	<b>830-3000</b>
B 5-Spd Tranny Mounting Plate	Fits Paughco Rigid Frames w/Softail Transmission	<b>830-3001</b>

- WINDSHIELDS / FAIRINGS
- AUDIO / COMMUNICATION
- SEATS / LUGGAGE
- BAR / MIRRORS / CONTROLS
- EXHAUST
- AIR / FUEL SYSTEMS
- ENGINE
- TRANSMISSION / DRIVELINE**
- GASKETS / SEALS
- ELECTRICAL
- LIGHTING
- CABLES
- BRAKES
- OIL FILTERS
- SUSPENSION
- BODY
- WHEELS
- TIRES / TIRE ACC.
- BIKE ACC.
- VICTORY / INDIAN
- COVERS / LOCKS / TIEDOWNS
- CHEMICALS
- TOOLS
- HELMETS
- HELMET ACC.
- EYEWEAR
- APPAREL / RIDER ACC.
- PROMOTIONAL
- REFERENCE
- INDEX

WINDSHIELDS / FAIRINGS  
 AUDIO / COMMUNICATION  
 SEATS / LUGGAGE  
 BARS / MIRRORS / CONTROLS  
 EXHAUST  
 AIR / FUEL SYSTEMS  
 ENGINE  
**TRANSMISSION / DRIVELINE**  
 GASKETS / SEALS  
 ELECTRICAL  
 LIGHTING  
 CABLES  
 BRAKES  
 OIL FILTERS  
 SUSPENSION  
 BODY  
 WHEELS  
 TIRES / TIRE ACC.  
 BIKE ACC.  
 VICTORY / INDIAN  
 COVERS / LOCKS / TIEDOWNS  
 CHEMICALS  
 TOOLS  
 HELMETS  
 HELMET ACC.  
 EYEWEAR  
 APPAREL / RIDER ACC.  
 PROMOTIONAL  
 REFERENCE  
 INDEX



**DERBY COVERS**



The Brass Balls Piston Helmet design derby cover is a perfect compliment to your bike. Give your bike that extra bit of coolness it deserves.

Description	Application	WPS#
Piston Helmet Derby Cover	Fits '16-Up Touring	<b>826-01157</b>
	Fits '99-17 Twin Cams (except '16-Up Touring)	<b>826-01154</b>
	Fits XL '04-Up	<b>826-01155</b>
	Fits XL '96-03	<b>826-01156</b>



**DERBY COVERS**

- CNC Machined 6061 aluminum
- Six different anodized colored options
- Machined Rooke logo
- Replaces the OEM five bolt derby cover
- Hardware Included, gasket sold separately
- Made in the USA



Raw



Black



Polished



Gold



Red



Blue

Description	Application	Finish	WPS#
Derby Cover	All Twin Cams '99-17 Except '16-Up Touring, '15-Up FLHTCUL and '15-Up FLHTKL	Raw	<b>825-02020</b>
		Black	<b>825-02021</b>
		Polished	<b>825-02022</b>
		Gold	<b>825-02023</b>
		Red	<b>825-02024</b>
		Blue	<b>825-02025</b>





### DERBY COVERS

- Die cast aluminum derby covers
- Ideal for replacing damaged, scratched or warped stock covers
- Chrome plated
- Mounting hardware included



Application	Chrome	Wrinkled Black	Satin Black
A 5-Hole for '99-16 Big Twins	<b>820-51830</b>	<b>820-50811</b>	<b>820-50812</b>
B 3-Hole for '84-98 Big Twins	<b>820-51831</b>		
C '04-16 XL Models	<b>820-51832</b>		
D '94-03 XL Models	<b>820-51833</b>		
E '16-Up Touring Models	<b>820-51834</b>		<b>820-51835</b>



A



B



C



### BILLET DERBY COVERS

- Derby Covers are not all created equal
- HD derby covers by Precision Billet have a look that pops
- The 3D design adds definition
- Precision CNC milled from 6061 T6 aircraft aluminum
- Available in our hard black anodized contrast cut or our show chrome finish
- Made in the USA!

Application	Year	Description	WPS#
<b>HARLEY DAVIDSON</b>			
A Twin Cam Models	'99-17	Bad Axe Chrome	<b>810-0308</b>
Twin Cam	'99-17	Bad Axe Black	<b>810-0307</b>
Twin Cam	'99-17	Dark Side Chrome	<b>810-0301</b>
B Twin Cam	'99-17	Dark Side Black	<b>810-0302</b>
Twin Cam	'99-17	Ace's Wild Chrome	<b>810-0303</b>
Twin Cam	'99-17	Ace's Wild Black	<b>810-0304</b>
Sportster	'04-17	Sportster Dark Side Chrome	<b>810-0321</b>
Sportster	'04-17	Sportster Dark Side Black	<b>810-0322</b>
Sportster	'04-17	Sportster "48" Chrome	<b>810-0324</b>
C Sportster	'04-17	Sportster "48" Black	<b>810-0323</b>

WINDSHIELDS / FAIRINGS  
 AUDIO / COMMUNICATION  
 SEATS / LUGGAGE  
 BARS / MIRRORS / CONTROLS  
 EXHAUST  
 AIR / FUEL SYSTEMS  
 ENGINE  
**TRANSMISSION / DRIVELINE**  
 GASKETS / SEALS  
 ELECTRICAL  
 LIGHTING  
 CABLES  
 BRAKES  
 OIL FILTERS  
 SUSPENSION  
 BODY  
 WHEELS  
 TIRES / TIRE ACC.  
 BIKE ACC.  
 VICTORY / INDIAN  
 COVERS / LOCKS / TIEDOWNS  
 CHEMICALS  
 TOOLS  
 HELMETS  
 HELMET ACC.  
 EYEWEAR  
 APPAREL / RIDER ACC.  
 PROMOTIONAL  
 REFERENCE  
 INDEX

- WINDSHIELDS / FAIRINGS
- AUDIO / COMMUNICATION
- SEATS / LUGGAGE
- BAR / MIRRORS / CONTROLS
- EXHAUST
- AIR / FUEL SYSTEMS
- ENGINE
- TRANSMISSION / DRIVELINE**
- GASKETS / SEALS
- ELECTRICAL
- LIGHTING
- CABLES
- BRAKES
- OIL FILTERS
- SUSPENSION
- BODY
- WHEELS
- TIRES / TIRE ACC.
- BIKE ACC.
- VICTORY / INDIAN
- COVERS / LOCKS / TIEDOWNS
- CHEMICALS
- TOOLS
- HELMETS
- HELMET ACC.
- EYEWEAR
- APPAREL / RIDER ACC.
- PROMOTIONAL
- REFERENCE
- INDEX



## TRANSMISSION SIDE COVERS

- Die-cast chrome plated covers, some applications available in black (gloss)
- Re-use stock mounting hardware and internal components
- 5-speed cover also available in finned design.

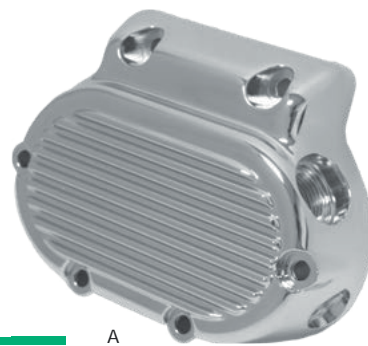

A

Description	Application	WPS#
A Transmission Side Cover Finned Chrome	5-Speed Big Twins '87-06 (except '06 Dynas and FXR Models)	<b>820-70200</b>
B Transmission Side Cover Smooth Chrome	5-Speed Big Twins '87-06 (except '06 Dynas and FXR Models)	<b>820-70201</b>
C Transmission Side Cover Smooth Chrome	6-Speed Twin Cams '07-17 (and '06 Dyna)	<b>820-50800</b>
D Transmission Side Cover Smooth Black	6-Speed Twin Cams '07-17 (and '06 Dyna)	<b>820-50801</b>



B



C



D

## TRANSMISSION TOP COVERS

- Die-cast chrome plated covers
- Great for replacing corroded stock covers
- Mount with stock hardware

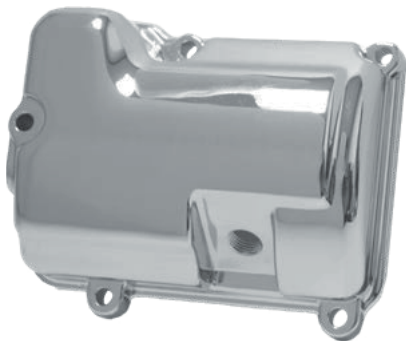

A



B



C

Application	WPS#
<b>TRANSMISSION TOP COVER CHROME</b>	
A '87-99 Big Twins (except Dyna)	<b>820-70202</b>
B '00-06 FXST, FLST '01-06 FLH/T	<b>820-70203</b>
C '07-08 FXST, '06-08 FXD, '07-08 FLH/T	<b>820-70204</b>





## TRANSMISSION COVERS



Designed to match the various other ribbed EMD primary and engine to covers to complete the chopper look for your ride!



- Manufactured in die cast aluminum, CNC milled gasket surface
- OEM Mounting Hardware reusable
- Gaskets not included, please order separately
- Available in raw cast or black powder coated finish, ribs can be accented or polished

Application	Description	WPS#
Fits '07-17 Twin Cams and '06-17 Dynas	Ribbed Transmission Side Cover Raw	<b>866-05200</b>
	Ribbed Transmission Side Cover Black	<b>866-05201</b>

## HYDRAULIC CLUTCH ACTUATOR COVERS



Pro One billet hydraulic clutch actuator is the easy way to add a hydraulic clutch to your 5-speed Big Twin. CNC machined from solid billet aluminum. Fits all 1987-2006 Harley-Davidson Big Twin models with 5-speed (Except 06 Dyna Glide). Includes instructions, all chrome mounting hardware, chrome banjo bolt with copper banjo washers, and bleeder screw. Compatible with OEM or 11/16" bore aftermarket master cylinders (not included). Hydraulic line from master cylinder to hydraulic clutch not included.

Application	Description	WPS#
5-Speed Big Twins	Hydraulic Clutch Cover Chrome	<b>812-02060</b>
	Hydraulic Clutch Cover Black	<b>812-02061</b>
	O-ring Kit	<b>812-02062</b>
	Rebuild Kit Including Piston	<b>812-02063</b>



## TRANSMISSION SIDE COVER SET

- Polished chrome plated
- Made in the USA



Application	Year	WPS#
<b>TRANSMISSION SIDE COVER SETS</b>		
Touring	'07-16 All models	<b>830-1038</b>
	'87-06 All models	<b>830-1040</b>
Softtail	'07-17 All models	<b>830-1037</b>
	'87-06 All models	<b>830-1040</b>
Dyna	'06-17 All models	<b>830-1039</b>
	'87-05 All models	<b>830-1040</b>

Application	Year	WPS#
<b>TRANSMISSION TOP COVER SETS</b>		
Touring	'07-16 All models	<b>830-1046</b>
	'98-06 All models	<b>830-1044</b>
Softtail	'88-97 All models	<b>830-1043</b>
	'07-17 All models	<b>830-1046</b>
Dyna	'98-06 All models	<b>830-1042</b>
	'88-97 All models	<b>830-1043</b>
	'06-17 All models	<b>830-1046</b>
	'99-05 All models	<b>830-1045</b>
	'91-98 All models	<b>830-1041</b>

- WINDSHIELDS / FAIRINGS
- AUDIO / COMMUNICATION
- SEATS / LUGGAGE
- BARS / MIRRORS / CONTROLS
- EXHAUST
- AIR / FUEL SYSTEMS
- ENGINE
- TRANSMISSION / DRIVELINE**
- GASKETS / SEALS
- ELECTRICAL
- LIGHTING
- CABLES
- BRAKES
- OIL FILTERS
- SUSPENSION
- BODY
- WHEELS
- TIRES / TIRE ACC.
- BIKE ACC.
- VICTORY / INDIAN
- COVERS / LOCKS / TIEDOWNS
- CHEMICALS
- TOOLS
- HELMETS
- HELMET ACC.
- EYEWEAR
- APPAREL / RIDER ACC.
- PROMOTIONAL
- REFERENCE
- INDEX



## ELECTRICAL KICKER COVERS

Designed to fit '91-Up Sportsters, the EMD Electric Kick and Sprocket cover combo allows the activation of your electric start with a traditional kicker. It must be wired to your wiring harness. The kit comes with a sprocket cover, 4-speed-style transmission case end, kicker arm and pedal and an integrated microswitch.



Application	Description	WPS#
Fits '04-17 XL Models	Electric Kicker Sprocket Cover Raw	<b>866-05086</b>
Fits '91-03 XL Models	Electric Kicker Sprocket Cover Raw	<b>866-05085</b>



- WINDSHIELDS / FAIRINGS
- AUDIO / COMMUNICATION
- SEATS / LUGGAGE
- BARS / MIRRORS / CONTROLS
- EXHAUST
- AIR / FUEL SYSTEMS
- ENGINE
- TRANSMISSION / DRIVELINE**
- GASKETS / SEALS
- ELECTRICAL
- LIGHTING
- CABLES
- BRAKES
- OIL FILTERS
- SUSPENSION
- BODY
- WHEELS
- TIRES / TIRE ACC.
- BIKE ACC.
- VICTORY / INDIAN
- COVERS / LOCKS / TIEDOWNS
- CHEMICALS
- TOOLS
- HELMETS
- HELMET ACC.
- EYEWEAR
- APPAREL / RIDER ACC.
- PROMOTIONAL
- REFERENCE
- INDEX



## KICKER ARMS

Early and late style kicker arms for most applications including versions with offset to clear most custom exhausts. Kicker pedals sold separately unless otherwise noted.



Description	WPS#
A Kickarm w/Offset (OE 33057-72)	820-53008
B Kickarm w/Offset (OE 33057-72) Heavy Duty	820-53009
C Kickarm w/Offset '36-Up Big Twin '57-Up XL	820-53010
D Kickarm w/Offset '54-Up Big Twins (OE 33068-54)	820-53011
Kickarm Foldable w/Flat Pedal	820-53012
Kickarm Foldable w/Round Pedal	820-53013

## KICKER PEDALS

Choose from stock replacement rubber pedals, to classic cast brass or custom bicycle style kicker pedals.



Description	WPS#
A Black w/Chrome Swivel	820-53000
B Black w/Black Swivel	820-53001
C Cast Chrome	820-53002
D Cast Brass	820-53003
O-ring Style	820-53004
E Rail Style	820-53005
F Bicycle Style	820-53006
G Pedal Bolt Kit	820-53007

## KICKER PARTS



Description	WPS#
A Kicker Spring Cover	820-53014
B Kicker Spring	820-53015
C Kicker Spring Stud	820-53016
D Kicker Shaft	820-53017
E Kicker Shaft Bushing Kit	820-53018
F Kicker Shaft Washer 10 pk	820-53019
G Crank Gear Lock Tab 10 pk	820-53221

- WINDSHIELDS / FAIRINGS
- AUDIO / COMMUNICATION
- SEATS / LUGGAGE
- BAR / MIRRORS / CONTROLS
- EXHAUST
- AIR / FUEL SYSTEMS
- ENGINE
- TRANSMISSION / DRIVELINE**
- GASKETS / SEALS
- ELECTRICAL
- LIGHTING
- CABLES
- BRAKES
- OIL FILTERS
- SUSPENSION
- BODY
- WHEELS
- TIRES / TIRE ACC.
- BIKE ACC.
- VICTORY / INDIAN
- COVERS / LOCKS / TIEDOWNS
- CHEMICALS
- TOOLS
- HELMETS
- HELMET ACC.
- EYEWEAR
- APPAREL / RIDER ACC.
- PROMOTIONAL
- REFERENCE
- INDEX

- WINDSHIELDS / FAIRINGS
- AUDIO / COMMUNICATION
- SEATS / LUGGAGE
- BAR / MIRRORS / CONTROLS
- EXHAUST
- AIR / FUEL SYSTEMS
- ENGINE
- TRANSMISSION / DRIVELINE**
- GASKETS / SEALS
- ELECTRICAL
- LIGHTING
- CABLES
- BRAKES
- OIL FILTERS
- SUSPENSION
- BODY
- WHEELS
- TIRES / TIRE ACC.
- BIKE ACC.
- VICTORY / INDIAN
- COVERS / LOCKS / TIEDOWNS
- CHEMICALS
- TOOLS
- HELMETS
- HELMET ACC.
- EYEWEAR
- APPAREL / RIDER ACC.
- PROMOTIONAL
- REFERENCE
- INDEX



## KICKER SHAFT BUSHING

- Includes 2 bushings and 1 seal
- Fits '66-83 Shovelhead models
- Made in the USA!



Description	WPS#
Standard O.D. 0.9355"	191-57089
Oversize O.D. +0.005"	191-57090



## SHIFT FORKS

Replace bent OEM shift forks with these quality reproduction parts. Sold each.

Application	Description	WPS#
Fits '80-06 5-Speeds	Shift Fork 3rd and 5th	820-51763
	Shift Fork 4th	820-51764
	Shift Fork 1st and 2nd	820-51765



820-51763



820-51764



820-51765

## CLUTCH RELEASE SHAFT

Replacement for OEM clutch release shaft on 5-speed big twins '82-86. Replaces OEM 37083-80A

Description	Application	WPS#
Clutch Release Shaft	Fits '82-86 5-Speeds	820-51766





## 7-SPEED DIRECT DRIVE BUILDERS KIT



- Shorter first gear ratio (numerically higher) to help with the off the light get up and go, as well as slow speed maneuvering around the bar parking lot
- Fully assembled gear set and shift system. No adjustments needed for installation
- The DD7 re-uses the stock shifter pawl and includes a new main drive gear bearing and seal, door, top and side cover gaskets
- Compatible will all types of aftermarket hydraulic side covers, as well as the stock Screaming Eagle versions
- Direct slide in installation. No case modifications needed. Clears all exhaust and works with all after market clutches
- Includes a new transmission top cover that holds the linear, roller bearing mounted, shift detent
- Easy to find neutral, every time. Smooth shifting without the the stock clunks or 'jerks' when engaging
- Upgraded ARP 12 pt stainless steel bolts included. For transmission top and side cover as well
- Included BAKER Direct Drive 7 Speed Stock Side Cover emblem
- Backed by a 5 year limited warranty

Application	Description	Year	WPS#
Touring	7-Speed direct drive builder's kit w/ chrome trap door	'07-16	<b>821-1000</b>
	7-Speed direct drive builder's kit w/ wrinkled black trap door	'07-16	<b>821-1001</b>
Softail	7-Speed direct drive builder's kit w/ chrome trap door	'07-17	<b>821-1000</b>
	7-Speed direct drive builder's kit w/ wrinkled black trap door	'07-17	<b>821-1001</b>
Dyna	7-Speed direct drive builder's kit w/ chrome trap door	'06-17	<b>821-1000</b>
	7-Speed direct drive builder's kit w/ wrinkled black trap door	'06-17	<b>821-1001</b>

## 6-SPEED DIRECT DRIVE BUILDERS KIT



- Pre-assembled gearset, ready to easily install, featuring helical cut 4th, 5th, and 6th gears for noise reduction, and straight cut gears in 1st - 3rd for strength in the torque ranges.
- 28 tooth compensating sprocket necessary for maintaining the stock 1st - 5th ratios included. Overdrive is obtained through the primary, reducing the overall rpm in 6th gear by 400-500rpm depending on the application.
- Roller detent shift drum with fixed spindle, eliminates shimming and misalignment. Finding neutral is very easy with a redundant neutral detent.
- Shifter pawl assembly with improved geometry for a perfect response. Includes a built in over-shift protection for smooth precise shifting.
- Gears are manufactured with 8620 hardened gear steel for long life and dependability.
- 120 ft-lb torque capacity, applications that exceed this rating should use the Overdrive 6-speed rated at 165 ft-lb torque capacity.
- Available with 3.24 1st gear, or 2.94 1st gear.
- Backed by a 5 year limited warranty.

Application	Description	Year	w/2.94:1 1st gear	w/3.24:1 1st gear
Touring	6-Speed direct drive builder's kit	'01-06	<b>821-1007</b>	<b>821-1002</b>
		'98-00	<b>821-1009</b>	<b>821-1004</b>
		'90-97	<b>821-1011</b>	<b>821-1006</b>
Softail	6-Speed direct drive builder's kit	'00-06	<b>821-1008</b>	<b>821-1003</b>
		'90-97	<b>821-1010</b>	<b>821-1005</b>
Dyna	6-Speed direct drive builder's kit	'01-05	<b>821-1008</b>	<b>821-1003</b>
		'90-97	<b>821-1010</b>	<b>821-1005</b>
FXR	6-Speed direct drive builder's kit	'99	<b>821-1009</b>	<b>821-1004</b>
		'90-94	<b>821-1011</b>	<b>821-1006</b>

- WINDSHIELDS / FAIRINGS
- AUDIO / COMMUNICATION
- SEATS / LUGGAGE
- BARS / MIRRORS / CONTROLS
- EXHAUST
- AIR / FUEL SYSTEMS
- ENGINE
- TRANSMISSION / DRIVELINE**
- GASKETS / SEALS
- ELECTRICAL
- LIGHTING
- CABLES
- BRAKES
- OIL FILTERS
- SUSPENSION
- BODY
- WHEELS
- TIRES / TIRE ACC.
- BIKE ACC.
- VICTORY / INDIAN
- COVERS / LOCKS / TIEDOWNS
- CHEMICALS
- TOOLS
- HELMETS
- HELMET ACC.
- EYEWEAR
- APPAREL / RIDER ACC.
- PROMOTIONAL
- REFERENCE
- INDEX



## OVERDRIVE 6-SPEED BUILDERS KIT

### THE ORIGINAL 6-SPEED TRANSMISSION

This is the ORIGINAL 6-speed design that revolutionized the American V-Twin industry. Yet, it's still the best overdrive 6-speed built to this day...hands down. Our OD6 is built to comfortably handle the power from today's big-inch motors. This transmission is rated for motors putting out up to 165ft/lbs of continuous use. It is available as a complete transmission with a wide variety of case options and configurations, or as a builder's kit for your stock case application, which requires little to no modification. The BAKER OD6 is available with many optional gear ratios to match your engine torque and riding style.

- Billet 6061-T6 bearing door
- 1/8" thick bearing retainer plate
- Redundant Neutral smooth shift system
- Hard chrome plated shift forks
- Diamond cut gearset made out of 8620 steel
- Optional Gear Ratios
- All transmission seals, gaskets and hardware
- 5 year limited warranty



Application	Year	w/2.94:1 1st gear	w/3.24:1 1st gear
All Big Twin Models w/tapered mainshaft	'87-89	<b>821-1037</b>	<b>821-1038</b>
Touring	'90-92	<b>821-1024</b>	<b>821-1035</b>
	'93-97	<b>821-1025</b>	<b>821-1036</b>
	'98	<b>821-1034</b>	<b>821-1033</b>
	'99-00	<b>821-1023</b>	<b>821-1028</b>
	'01	<b>821-1022</b>	<b>821-1026</b>
	'02-06	<b>821-1020</b>	<b>821-1027</b>
Softail	'90-97	<b>821-1024</b>	<b>821-1035</b>
	'98-99	<b>821-1032</b>	<b>821-1031</b>
	'00-06	<b>821-1021</b>	<b>821-1117</b>
Dyna	'91-97	<b>821-1024</b>	<b>821-1035</b>
	'98	<b>821-1032</b>	<b>821-1031</b>
	'99-00	<b>821-1030</b>	<b>821-1029</b>
FXR	'90-94	<b>821-1024</b>	<b>821-1035</b>
	'99	<b>821-1032</b>	<b>821-1031</b>

### ODR6 COMPLETE TRANSMISSION

- 6 Speed units only available as a complete build transmission
- Multiple gear ratio combinations available
- Full complement of straight cut gears for the ultimate in strength, with the tooth forms ground with diamond coated tooling
- Works with all primary and clutch configurations on the market
- Comes standard with zero offset pulleys and 530 chain sprockets, with many offset pulleys available at a nominal up-charge
- Pulley covers sold separately
- Keeps the motorcycle fully balanced by not needing any drivetrain offsets, strictly a bolt in design on all versions
- Backed by a 5yr limited warranty



Application	Description	WPS#
EVO Softail right side drive custom builds	Right side drive, complete 6 speed transmission, 2.94 1st gear .86 6th	<b>821-1054</b>
EVO Softail Models and left side drive custom builds	'90-99	<b>821-1050</b>



## 6 – INTO – 4 TRANSMISSION

Years ago we came out with the 6-into-4 for Shovelheads. Sales of these transmissions have been a complete shocker and the message is loud and clear: People love their Shovelheads and they ride the piss out of them. We often get asked “why not a 5-into-4?”. This is because 4-speeds have a 1:1 fourth gear and Evo 5-speeds do as well. This provides no RPM advantage to your old iron. 6-into-4’s have a 1:1 fifth gear and a .86:1 sixth gear; good for a 500 RPM reduction on the highway. Our original 6-into-4 transmission is a direct replacement for the 1970-Early 1984 4-speed. This year we have main shaft options that allow fitment into wet (diaphragm) clutch model Shovels and 4-speed Evo models that require a longer main shaft and shorter ones for Pan and Knuckle. Available with different kicker covers

- 6061-T6 extruded billet case with the nostalgic look of 4-Speed and precision machined for no leaks
- 5th mounting stud machined into the case, for pure strength and no weak points
- BAKER Klassic Kicker gears, stainless steel kick arm, and bronze pedal standard
- Case available with or without primary flange; raw, wrinkle black, or polished
- 23 tooth sprocket standard. Optional 24 tooth and 33 tooth pulley
- Forged top cover available with or without neutral switch
- Modern 5-speed style shift drum and shifter pawl for smooth quick shifts
- Electronic speed sensor provision on right rear of case
- N1 drum, no cost option, for N-1-2-3-4-5-6 shift pattern
- Comes standard with a BAKER 5 Year/50,000 mile warranty

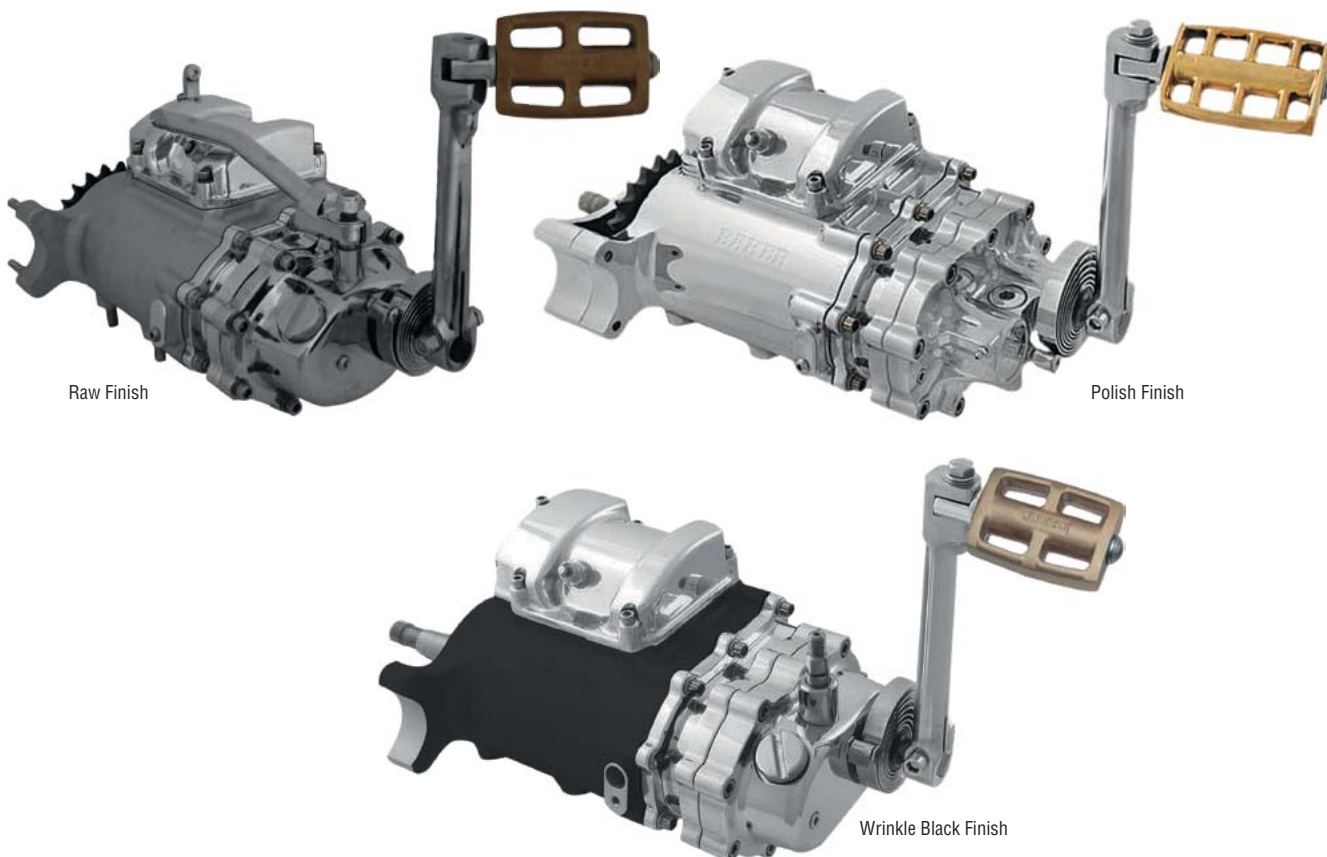

Raw Finish

Polish Finish

Wrinkle Black Finish

Application	Description	Year	WPS#
Shovelhead	6-speed overdrive transmission 2.94 1st gear, Raw Finish	'70-E84	<b>821-1051</b>
	6-speed overdrive transmission 2.94 1st gear, Polished Finish	'70-E84	<b>821-1052</b>
	6-speed overdrive transmission 2.94 1st gear, Wrinkle Black Finish	'70-E84	<b>821-1039</b>
Shovelhead/Panhead	6-speed overdrive transmission 2.94 1st gear, Raw Finish	'65-69	<b>821-1040</b>
Knucklehead/Panhead	6-speed overdrive transmission 2.94 1st gear, Raw Finish	'36-64	<b>821-1053</b>

- WINDSHIELDS / FAIRINGS
- AUDIO / COMMUNICATION
- SEATS / LUGGAGE
- BAR / MIRRORS / CONTROLS
- EXHAUST
- AIR / FUEL SYSTEMS
- ENGINE
- TRANSMISSION / DRIVELINE**
- GASKETS / SEALS
- ELECTRICAL
- LIGHTING
- CABLES
- BRAKES
- OIL FILTERS
- SUSPENSION
- BODY
- WHEELS
- TIRES / TIRE ACC.
- BIKE ACC.
- VICTORY / INDIAN
- COVERS / LOCKS / TIEDOWNS
- CHEMICALS
- TOOLS
- HELMETS
- HELMET ACC.
- EYEWEAR
- APPAREL / RIDER ACC.
- PROMOTIONAL
- REFERENCE
- INDEX



## ANTI-OVERSHIFT RATCHET PAWL ASSEMBLY

- Innovative ratchet pawl design utilizes a rectangular cross-section spring like the 21st century Big Twins
- Pawl shaft lever splines are hobbled on a gear cutter just like our gears for high strength
- Made in the U.S.A.

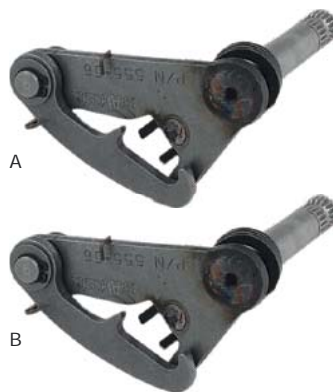

	Application	WPS #
A	'80-00 All Big Twin Except 2000 Softail	<b>821-1055</b>
B	'00-06 Softail, '01-06 Touring, '01-05 Dyna	<b>821-1056</b>

## HIGH TORQUE BEARING KIT

- High torque bearing kit is designed for bikes with over 100hp
- Replacement seal available separately
- Made in the U.S.A.



Description	Application	WPS #
High Torque Bearing Kit	'85-06 Big Twin All	<b>821-1111</b>
Oil Seal 25X52X7A	For use with BAKER High Torque Bearing	<b>821-1116</b>

## HEAVY DUTY THROWOUT BEARING KITS

- Heavy Duty Throwout bearing kit was developed to address the failures of the stock clutch throwout bearing
- The ball-and-ramp actuator and the larger thrust bearing features a 97% greater surface area and 77% greater static load capacity than the stock bearing
- Includes bearings, snap rings, gaskets, seals and retaining nuts
- Made in the U.S.A.



Application	WPS #
'87-Later All Evo and Twin Cam	<b>821-1114</b>

## KLASSIC KICKER GEARS

- Classic Kicker Gears roll smooth as glass
- The last set you will have to buy
- Made in the U.S.A.



Application	WPS #
'36-L86 stock 4-speeds, BAKER 4-speed and 6 in 4 transmissions	<b>821-1065</b>

WINDSHIELDS / FAIRINGS  
AUDIO / COMMUNICATION  
SEATS / LUGGAGE  
BARS / MIRRORS / CONTROLS  
EXHAUST  
AIR / FUEL SYSTEMS  
ENGINE  
TRANSMISSION / DRIVELINE  
GASKETS / SEALS  
ELECTRICAL  
LIGHTING  
CABLES  
BRAKES  
OIL FILTERS  
SUSPENSION  
BODY  
WHEELS  
TIRES / TIRE ACC.  
BIKE ACC.  
VICTORY / INDIAN  
COVERS / LOCKS / TIEDOWNS  
CHEMICALS  
TOOLS  
HELMETS  
HELMET ACC.  
EYEWEAR  
APPAREL / RIDER ACC.  
PROMOTIONAL  
REFERENCE  
INDEX





### 5-SPEED ROLLER SHIFT KIT

- Our 5-speed drum is a direct replacement for all existing stock H-D 5-speeds, but features improvements for smoother shifting
- The pillow blocks included with the kit are machined from our 6061-T6 extrusion stock for a significant increase in strength over stock
- Made in the U.S.A.

Application	WPS #
'88-97 Big Twin All	821-1060



### BILLET STEEL SHIFT FORKS

- Our Shift Fork Kits include all three forks and are a direct replacement for the standard O.E.
- Cross section is three times thicker than stock
- These billet steel forks are hard chrome plated like a fine American made tool

Application	WPS #
'87-06 5-speed Big Twin	821-1063



### 5-SPEED SMOOTH SHIFT KIT

- 5-Speed smooth shift kit greatly improves the shifting
- The shift detent plate is made out of billet and securely bolted to the shift drum
- Made in the U.S.A.

Application	WPS #
'91-03 Sportster	821-1061



### TRANSMISSION DIPSTICK

- Our dipstick is made of billet aluminum and is show-chrome plated
- Redesigned dipstick with the largest radius possible for added strength
- Made in the U.S.A.

Application	WPS #
'87-06 Big Twin Except '06 Dyna	821-1070

- WINDSHIELDS / FAIRINGS
- AUDIO / COMMUNICATION
- SEATS / LUGGAGE
- BAR / MIRRORS / CONTROLS
- EXHAUST
- AIR / FUEL SYSTEMS
- ENGINE
- TRANSMISSION / DRIVELINE**
- GASKETS / SEALS
- ELECTRICAL
- LIGHTING
- CABLES
- BRAKES
- OIL FILTERS
- SUSPENSION
- BODY
- WHEELS
- TIRES / TIRE ACC.
- BIKE ACC.
- VICTORY / INDIAN
- COVERS / LOCKS / TIEDOWNS
- CHEMICALS
- TOOLS
- HELMETS
- HELMET ACC.
- EYEWEAR
- APPAREL / RIDER ACC.
- PROMOTIONAL
- REFERENCE
- INDEX

- WINDSHIELDS / FAIRINGS
- AUDIO / COMMUNICATION
- SEATS / LUGGAGE
- BARS / MIRRORS / CONTROLS
- EXHAUST
- AIR / FUEL SYSTEMS
- ENGINE
- TRANSMISSION / DRIVELINE**
- GASKETS / SEALS
- ELECTRICAL
- LIGHTING
- CABLES
- BRAKES
- OIL FILTERS
- SUSPENSION
- BODY
- WHEELS
- TIRES / TIRE ACC.
- BIKE ACC.
- VICTORY / INDIAN
- COVERS / LOCKS / TIEDOWNS
- CHEMICALS
- TOOLS
- HELMETS
- HELMET ACC.
- EYEWEAR
- APPAREL / RIDER ACC.
- PROMOTIONAL
- REFERENCE
- INDEX



## TRANSMISSION DIPSTICK NEW

These Knurled dipsticks replace the OEM # 37065-06 item and really clean up the look of the transmission. Our Knurled transmission dipsticks are machined from 6061 T6 billet aluminum and are brilliantly chrome plated or anodized black with machined accents.



Application	Chrome	Black
'07-18 FLH/FLT and Softails, '06-17 Dynas	811-20190	811-20191



## MAIN SHAFT NUT NEW

- OEM Reproduction
- Sold Each
- Made In The U.S.A



A



B



C

Application	WPS#
MAIN SHAFT NUT	
A For '92-UP XL and Big Twins	830-1144
B For '71-84 Sportsters	830-1163
C For '36-85 Big Twins	830-1155
For '36-91 4 Speed Big Twins	830-1185



## TRANSMISSION REBUILD KIT



- Transmission rebuild kit is an all inclusive kit designed to freshen up those high mileage bikes
- Developed to work specifically with our OD6, DD6, DD5 and OEM5 left side drive transmissions



### Includes:

- Transmission Case Bearings
- Transmission Case Snap Rings
- Transmission Trap Door Bearings
- Gearset Bearings
- Gearset Snap Rings and Thrust Washers
- Transmission Assembly Gaskets
- Transmission Assembly Seals

Application	WPS #
'94-06 Softail, FXR, FLT-FLH	821-1062



## MAIN DRIVE GEAR SEAL

- Replaces the H-D part number 12067B
- It's a 5-speed transmission main seal

Application	WPS #
'94-06 Big Twin	821-1110



## INNER PRIMARY BEARING AND SEAL KIT

- Includes all parts needed for inner primary bearing replacement
- OE quality, fits stock and most aftermarket inner primaries

Application	WPS#
<b>HARLEY DAVIDSON</b>	
Twin Cam stock replacement	'08-17 <b>22-53103</b>
	'85-07 <b>22-53101</b>
Harley Davidson Big Twin HP Double row ball bearing designed for use on straight splined shafts only (exc. '06 Dyna)	'90-06 <b>22-53102</b>

## TRANSMISSION DIPSTICKS

- CNC Machined 6061 aluminum
- Six different anodized colored options
- Replaces OEM transmission dip stick #37065-06
- Made in the USA

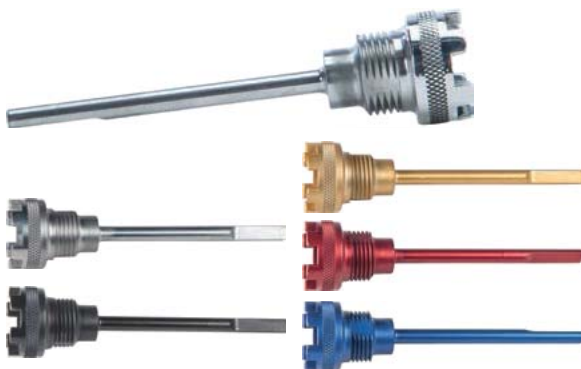

Application	Finish	WPS#
'07-17 FLH/FLT and Softails, '06-17 Dynas	Raw	<b>825-02213</b>
	Black	<b>825-02214</b>
	Polished	<b>825-02215</b>
	Gold	<b>825-02210</b>
	Red	<b>825-02211</b>
	Blue	<b>825-02212</b>

- WINDSHIELDS / FAIRINGS
- AUDIO / COMMUNICATION
- SEATS / LUGGAGE
- BAR / MIRRORS / CONTROLS
- EXHAUST
- AIR / FUEL SYSTEMS
- ENGINE
- TRANSMISSION / DRIVELINE**
- GASKETS / SEALS
- ELECTRICAL
- LIGHTING
- CABLES
- BRAKES
- OIL FILTERS
- SUSPENSION
- BODY
- WHEELS
- TIRES / TIRE ACC.
- BIKE ACC.
- VICTORY / INDIAN
- COVERS / LOCKS / TIEDOWNS
- CHEMICALS
- TOOLS
- HELMETS
- HELMET ACC.
- EYEWEAR
- APPAREL / RIDER ACC.
- PROMOTIONAL
- REFERENCE
- INDEX

WINDSHIELDS / FAIRINGS  
 AUDIO / COMMUNICATION  
 SEATS / LUGGAGE  
 BARS / MIRRORS / CONTROLS  
 EXHAUST  
 AIR / FUEL SYSTEMS  
 ENGINE  
**TRANSMISSION / DRIVELINE**  
 GASKETS / SEALS  
 ELECTRICAL  
 LIGHTING  
 CABLES  
 BRAKES  
 OIL FILTERS  
 SUSPENSION  
 BODY  
 WHEELS  
 TIRES / TIRE ACC.  
 BIKE ACC.  
 VICTORY / INDIAN  
 COVERS / LOCKS / TIEDOWNS  
 CHEMICALS  
 TOOLS  
 HELMETS  
 HELMET ACC.  
 EYEWEAR  
 APPAREL / RIDER ACC.  
 PROMOTIONAL  
 REFERENCE  
 INDEX



## SHIFT RODS

R O O K E

- Fits Touring models '99-16 and others with 11-1/4" shift rod
- Works with OEM shift rod ends
- CNC Machined 6061 aluminum
- Six different anodized colored options
- Made in the USA

Application	Finish	WPS#
'99-18 FLT	Raw	<b>825-02150</b>
	Black	<b>825-02151</b>
	Polished	<b>825-02152</b>
	Gold	<b>825-02153</b>
	Red	<b>825-02154</b>
	Blue	<b>825-02155</b>



## ROD END BALL JOINTS

- 5/16" Threaded ball joints
- Compatible with most OEM shift linkages
- Sold each

Description	WPS#
5/16"-24 Ball Joint Rod End	<b>563-01015</b>



## SHIFT ROD ENDS

- Chrome plated rod ends
- 5/16" thread
- Sold in sets of two

Description	WPS#
5/16" Thread	<b>820-52352</b>





**SHIFTARM SHAFT**



Exact OEM replacement shaft, ideal for fixing shifters with worn ratty splines on the shaft or shift arms.

Description	Application	WPS#
Shift Arm Shaft OEM 33709-82A	Fits '84-16 FLH/FLT Models	<b>820-51762</b>
Greasable Shift Arm Shaft	'82-10 FLH/FLT Models	<b>820-54215</b>

**TRANSMISSION SHIFT LEVERS**

- Replaces OEM shift levers with worn out splines
- Chrome finish for upgraded look
- Available for 5 and 6 speed transmissions

OEM#	Application	WPS#
<b>SHIFT LEVERS</b>		
34692-74TA *	'65-84 FL/FLHT models w/ heel-toe	
	'74-85 Heel Toe Shifter Chrome	<b>820-54213</b>
	'85-96 Big Twins	<b>820-51760</b>
	'97-14 Big Twins	<b>820-51761</b>
34564-90A	'90-05 Dyna, '86-06 FXST models	<b>820-54211</b>
34599-81T	'82-94 FXR models	<b>820-54210</b>
34606-74 *	'74-86 FL models, '80-86 FXWG	<b>820-54209</b>
34564-74TA	'74-85 FX, 80-86 FXST models	<b>820-54212</b>
34606-71	'71-74 XL models	<b>820-54208</b>
34606-75T	'77-85 XL models	<b>820-54204</b>
34605-86TB	'86-90 XL models	<b>820-54205</b>
34606-90	'91-03 XL models	<b>820-54206</b>
34660-04A	'04-Up XL models	<b>820-54207</b>

OEM#	Application	WPS#
<b>INNER SHIFT ARMS</b>		
33668-07	'08-17 FLST models	<b>820-54214</b>
33668-90B	'86-07 FLST models	<b>820-54202</b>
33789-03	'03-Up FXDWG, '08-Up FXDF and FXD models	<b>820-54203</b>
34660-74A *	'74-84 FL models	<b>820-54200</b>
34621-84	'84-94 FXR models w/ 5spd	<b>820-54201</b>

\*with splined shifter shaft



WINDSHIELDS / FAIRINGS

AUDIO / COMMUNICATION

SEATS / LUGGAGE

BAR / MIRRORS / CONTROLS

EXHAUST

AIR / FUEL SYSTEMS

ENGINE

**TRANSMISSION / DRIVELINE**

GASKETS / SEALS

ELECTRICAL

LIGHTING

CABLES

BRAKES

OIL FILTERS

SUSPENSION

BODY

WHEELS

TIRES / TIRE ACC.

BIKE ACC.

VICTORY / INDIAN

COVERS / LOCKS / TIEDOWNS

CHEMICALS

TOOLS

HELMETS

HELMET ACC.

EYEWEAR

APPAREL / RIDER ACC.

PROMOTIONAL

REFERENCE

INDEX



## PULLEYS

- CNC machined from 6061 Aluminum then chrome plated
- Fit most OEM wheels and HardDrive wheels



Application	Size	WPS#
'00-06 FLST/FXST (except '06 FXST)	65T x 1 1/8"	<b>576-01270</b>
'07-17 FLST/C/N, '07 FXSTD, '08-11 FXCW, '11 FXS, '07-17 FXD	66T x 1"	<b>576-01273</b>
'00-05 FXST, '00-06 FLST/C/N, '00-05 FXD, '04-06 FLHT, FLHX, FLHR, FLTR, '06 FXD	70T x 1 1/8"	<b>576-01271</b>
'86-99 FXST/FLST, '84-03 FLT, FLHT, FLHR, FLTR, '91-99 FXD, '85-94 FXR	70T x 1 1/2"	<b>576-01272</b>

## PULLEY SPACERS

Aluminum spacers that are ideal for lining up pulleys and sprockets. The spacers can easily be machined down to the next size under without having to worry about the spigot alignment when you machine the face of the spacer down to the desired thickness. They are drilled for up to 7/16" bolts. Can also be used as disc spacers.



Application	Width	WPS Part#	Application	Width	WPS Part#
'00-Up	1/2"	<b>820-60550</b>	'84-99	1/2"	<b>820-60500</b>
	3/4"	<b>820-60551</b>		3/4"	<b>820-60501</b>
	1"	<b>820-60552</b>		1 1/16"	<b>820-60502</b>
	1-1/4"	<b>820-60553</b>		1"	<b>820-60503</b>
	1-3/8"	<b>820-60554</b>		1-1/4"	<b>820-60504</b>
				1-1/2"	<b>820-60505</b>



## POLY CUSH DRIVE

- Manufactured with proprietary Hyer-Flex™ Polyurethane
- Out performs and outlast OEM rubber
- Resists Oils and Chemicals
- Smoother ride



Application	WPS#
A Fits Touring Models '09-Up	<b>770-4020</b>
B Fits V-Rod Models '01-17	<b>770-4021</b>



## BELT PULLEY BOLTS

- Polished Chrome
- Made in the USA



Application	Year	WPS#
Touring	2007	<b>830-1068</b>
	'04-06	<b>830-1069</b>
	'00-03	<b>830-1071</b>
Softail	'07-17	<b>830-1068</b>
	'00-06	<b>830-1069</b>
Dyna	'07-17	<b>830-1068</b>
	'00-06	<b>830-1069</b>





## REAR DRIVE BELTS



- High strength, high durability belts manufactured from state of the art materials to ensure quiet running and long life

\* Note: no warranty claims accepted for drive belts

Application	Width	Teeth	OEM#	WPS
Softail 93-99 with 61T Pulley	1 1/2"	128	40012-90	<b>811-11003</b>
Softail 95-99 with 65T Pulley	1 1/2"	130	40017-94	<b>811-11004</b>
Softail 87-94 with 70T Pulley	1 1/2"	132	40023-86	<b>811-11005</b>
Dyna 91-99 with 70T Pulley	1 1/2"	133	40015-90	<b>811-11006</b>
FXR, FLT 85-96	1 1/2"	136	40001-85	<b>811-11007</b>
FLT 97-03	1 1/2"	139	40024-97	<b>811-11008</b>
XL 91-03 with 55T	1 1/8"	125	40038-91	<b>811-11009</b>
XL 91-03 with 61T	1 1/8"	128	40022-91	<b>811-11010</b>
Dyna 00-06 with 70T pulley	1 1/8"	133	40015-00	<b>811-11011</b>
Softail 00-06 with 70T Pulley	1 1/8"	135	40307-00	<b>811-11012</b>
FLT 04-06	1 1/8"	139	40024-04	<b>811-11013</b>

## CUSTOM PULLEYS



- Designed to match our HardDrive billet wheel collection
- On some models the installation of a spacer is required for proper fitment ([see chart page 730](#))



Flow Black



Luck Black



Revolver Black



Flow Chrome



Luck Chrome



Revolver Chrome

Application	Size	Finish	Flow	Luck	Revolver
'07-17 FXST/B/C	66T x 20mm	Black	<b>576-01218</b>	<b>576-01220</b>	<b>576-01222</b>
		Chrome	<b>576-01219</b>	<b>576-01221</b>	<b>576-01223</b>
'07-17 FLST/C/N, '07 FXSTD, '08-11 FXCW, '11 FXS, '07-17 FXD	66T x 1"	Black	<b>576-01200</b>	<b>576-01202</b>	<b>576-01204</b>
		Chrome	<b>576-01201</b>	<b>576-01203</b>	<b>576-01205</b>
'00-05 FXST, '00-06 FLST/C/N, '00-05 FXD, '04-06 FLHT, FLHX, FLHR, FLTR, '06 FXD	70T x 1 1/8"	Black	<b>576-01206</b>	<b>576-01208</b>	<b>576-01210</b>
		Chrome	<b>576-01207</b>	<b>576-01209</b>	<b>576-01211</b>
'86-99 FXST/FLST, '84-03 FLT, FLHT, FLHR, FLTR, '91-99 FXD, '85-94 FXR	70T x 1 1/2"	Black	<b>576-01212</b>	<b>576-01214</b>	<b>576-01216</b>
		Chrome	<b>576-01213</b>	<b>576-01215</b>	<b>576-01217</b>

- WINDSHIELDS / FAIRINGS
- AUDIO / COMMUNICATION
- SEATS / LUGGAGE
- BARS / MIRRORS / CONTROLS
- EXHAUST
- AIR / FUEL SYSTEMS
- ENGINE
- TRANSMISSION / DRIVELINE**
- GASKETS / SEALS
- ELECTRICAL
- LIGHTING
- CABLES
- BRAKES
- OIL FILTERS
- SUSPENSION
- BODY
- WHEELS
- TIRES / TIRE ACC.
- BIKE ACC.
- VICTORY / INDIAN
- COVERS / LOCKS / TIEDOWNS
- CHEMICALS
- TOOLS
- HELMETS
- HELMET ACC.
- EYEWEAR
- APPAREL / RIDER ACC.
- PROMOTIONAL
- REFERENCE
- INDEX



## BAKER SPROCKETS

• .900" offset sprockets are the maximum offset that can be used without any modification to the stock inner primary. This makes it possible to run a 180 rear tire with no transmission offset or primary drive monkey-business required. Some rear fender modification may be required

• .500" offset sprockets series permits use of a wider tire than stock and great flexibility in dialing-in your secondary drive ratio.  
 • .200" offset sprockets are modeled after the factory 21 tooth sprocket, except this series is available with various tooth counts for flexibility in dialing-in your secondary drive ratio



821-1100



821-1101



821-1098

Sprockets	Application	WPS #
Sprocket, 25 tooth .200" offset	'06-17 Dyna and Softail, '07-Later Touring	<b>821-1094</b>
Sprocket, 24 tooth .500" offset	'79-06 5-Speed Era Transmissions	<b>821-1098</b>
Sprocket, 23 tooth .500" offset	'79-06 5-Speed Era Transmissions	<b>821-1099</b>
Sprocket, 24 tooth .900" offset	'79-06 5-Speed Era Transmissions	<b>821-1100</b>
Sprocket, 23 tooth .900" offset	'79-06 5-Speed Era Transmissions	<b>821-1101</b>

### PULLEY SPACERS

Pulley/Sprocket Spacer	'94-06 Big Twin/Sportster (exc. '06 Dyna)	<b>821-1102</b>
Pulley/Sprocket Spacer	'85-93 Big Twin/Sportster	<b>821-1103</b>



## TRANSMISSION SPROCKETS

- These new sprockets are a great OE replacement
- Sprockets are precision machined with hardened teeth for more mileage
- The off-set sprockets are an easy solution when installing a slightly wider tire without offsetting the primary or transmission
- Off-set sprockets are available in 1/2"

Application	Description	WPS #
'06-17 Big Twin 6speed	24 tooth sprocket w/ standard offset	<b>820-54693</b>
	25 tooth sprocket w/ standard offset	<b>820-54692</b>
	26 tooth sprocket w/ standard offset	<b>820-54691</b>
	24 tooth sprocket w/ 1/2" offset	<b>820-54696</b>
	25 tooth sprocket w/ 1/2" offset	<b>820-54695</b>
A '94-06 Big Twin 5speed	26 tooth sprocket w/ 1/2" offset	<b>820-54694</b>
	21 tooth sprocket w/ 1/2" offset	<b>820-54700</b>
	22 tooth sprocket w/ 1/2" offset	<b>820-54701</b>
	23 tooth sprocket w/ 1/2" offset	<b>820-54702</b>
B '80-85 Big Twin 5speed	24 tooth sprocket w/ 1/2" offset	<b>820-54703</b>
	21 tooth sprocket w/ standard offset	<b>820-54707</b>
	22 tooth sprocket w/ standard offset	<b>820-54708</b>
	23 tooth sprocket w/ standard offset	<b>820-54709</b>
C '91-Up Sportster	24 tooth sprocket w/ standard offset	<b>820-54710</b>
	21 tooth sprocket w/ standard offset	<b>820-54697</b>
	22 tooth sprocket w/ standard offset	<b>820-54698</b>
	23 tooth sprocket w/ standard offset	<b>820-54699</b>



## PULLEY LOCK PLATE

- Lockplate with bolts.

Application	WPS#
Fits Big Twins '93-06 except '06 Dynas (Repl. OEM 40251-92A)	<b>820-53210</b>



All sprockets are heat-treated one-piece construction, machined on computer controlled lathes to assure the highest quality and longest wear available. Remember, when you buy PBI sprockets, you are buying an unbeatable combination of guaranteed quality, experience, competitiveness and availability. Ask for PBI sprockets by name.



## REAR SPROCKETS

**MADE IN THE USA BY THE PROS FOR THE PROS!**

- Manufactured from 7075 T6-51 aluminum
- Stronger than steel sprockets in tensile, yield and shear strength
- Far lighter than steel for less unsprung weight
- Made from full thickness aluminum for maximum strength
- Available in a full range of tooth sizes

Material	Brinell Hardness	
Plain Aluminum	6061-T6	95
Mild Steel	1010	116
PBIs aircraft alloy aluminum	7075-T6-51	150



## COUNTERSHAFT SPROCKETS OEM REPLACEMENT

- CNC machined from solid high grade 8620 alloy steel
- Broached specially for maximum spline-to-shaft contact providing optimum load bearing
- Heat-treated for long life and extended wear resistance
- Finished with an electroless nickel plating for corrosion, wear resistance and lubricity
- Manufactured in USA
- ADD TOOTH COUNT TO END OF PART NUMBER WHEN ORDERING

Application	Year	Chain Pitch	OEM #	WPS #	Sizes Stocked
<b>HARLEY DAVIDSON</b>					
<b>OEM STYLE</b>					
Big Twin	'36-79	530	35203-36	<b>50-279</b>	22-26
Big Twin (4 speed)	'80-85	530	33338-83	<b>50-278</b>	22-25
Sportster	'54-E79	530	35205-52A	<b>50-272</b>	21-23
Sportster	late '79-E84	530	35205-79A	<b>50-273</b>	20-24
Sportster 4 speed	'L84-90	530	35208-84	<b>50-276</b>	21-23
Sportster 5 speed and	'91-92	530	37709-89	<b>50-277</b>	19-24
Sportster 520 Conversion	'91-92	520		<b>50-277X</b>	21-24
<b>OFFSET COUNTERSHAFT SPROCKETS</b>					
The Following Parts Use Late Style Lock Plates. (two 1/4" - 20 NC Bolts)					
Fits Big Twin 5-Speed Models 1986-2006 (except 2006 6-Speed DynaGlides) & Sportster					
Belt Drive Conversion Zero Off-Set		530		<b>50-284</b>	23-24
Belt Drive Conversion .500" Off-Set		530		<b>50-283</b>	22-24
Belt Drive Conversion .750" Off-Set		530		<b>50-281</b>	21-24
Belt Drive Conversion 1.06" Off-Set		530		<b>50-288</b>	23-24
Belt Drive Conversion 1.31" Off-Set		530		<b>50-289</b>	24
<b>OFFSET COUNTERSHAFT SPROCKETS</b>					
Models 2006 6-speed, 2007 & newer					
Belt Drive Conversion .500 Off-Set		530		<b>50-303</b>	24
Belt Drive Conversion .750 Off-Set		530		<b>50-302</b>	24
<b>REAR SPROCKETS</b>					
Big Twins 4 Speed	'73-85	530	41470-73	<b>50-2072A</b>	48-52
XL Models	'79-81	530	41470-73	<b>50-2072A</b>	48-52
Sportster	'86-92	530	41470-86	<b>50-2073A</b>	48-55
Also fits 2000 & newer large bearing hubs.				<b>50-2073A</b>	48-55

- WINDSHIELDS / FAIRINGS
- AUDIO / COMMUNICATION
- SEATS / LUGGAGE
- BAR / MIRRORS / CONTROLS
- EXHAUST
- AIR / FUEL SYSTEMS
- ENGINE
- TRANSMISSION / DRIVELINE**
- GASKETS / SEALS
- ELECTRICAL
- LIGHTING
- CABLES
- BRAKES
- OIL FILTERS
- SUSPENSION
- BODY
- WHEELS
- TIRES / TIRE ACC.
- BIKE ACC.
- VICTORY / INDIAN
- COVERS / LOCKS / TIEDOWNS
- CHEMICALS
- TOOLS
- HELMETS
- HELMET ACC.
- EYEWEAR
- APPAREL / RIDER ACC.
- PROMOTIONAL
- REFERENCE
- INDEX



# STEEL SPROCKETS

## TOP QUALITY AT ECONOMICAL PRICES

- Made exclusively from the finest Japanese 545C high carbon steel
- Heat treated and hand finished to meet or exceed O.E.M. standards
- Outlasts any mild steel or surface hardened sprocket as much as two or three times over
- To order, add tooth count to end of sprocket part number.
- Tooth count and chain length are for reference only, verify before ordering.



Application	Year	OEM Gearing			Rear Sprockets		Front Sprockets	
		Rear	CS	Chain/Links	WPS#	Sizes Stocked	WPS#	Sizes Stocked
<b>HARLEY DAVIDSON</b>								
XLH883 Sportster	'84-85	48	21	530-110	<b>55-7082</b>	48	<b>55-884</b>	21
	'86-90	48	21	530-110	<b>55-7086</b>	48	<b>55-884</b>	21
	'91-92	48	21	530-110	<b>55-7086</b>	48	<b>55-989</b>	21
XLH1200 Sportster	'84-85	48	21	530-110	<b>55-7082</b>	48	<b>55-884</b>	21
	'86-90	48	21	530-110	<b>55-7086</b>	48	<b>55-884</b>	21
	'91-92	48	21	530-110	<b>55-7086</b>	48	<b>55-989</b>	21

Tooth count and chain length for reference only-verify before ordering





**SPROCKETS / PULLEYS**



- Steel Sprockets Come Chrome Plated or Powder Coated in Gloss Black
- Convert From Belt Drive to 530 Chain Drive
- Available in Both Flat and With 6mm Offset
- Transmission Belt Pulleys OEM Replacements



Application	Description	WPS #
00-13 Big Twin	46 tooth rear sprocket CHR	<b>820-51175</b>
00-13 Big Twin	47 tooth rear sprocket CHR	<b>820-51176</b>
00-13 Big Twin	48 tooth rear sprocket CHR	<b>820-51177</b>
00-13 Big Twin	49 tooth rear sprocket CHR	<b>820-51178</b>
00-13 Big Twin	51 tooth rear sprocket CHR	<b>820-51179</b>
00-13 Big Twin	47 tooth rear sprocket CHR 6mm offset	<b>820-51180</b>
00-13 Big Twin	48 tooth rear sprocket CHR 6mm offset	<b>820-51181</b>
00-13 Big Twin	49 tooth rear sprocket CHR 6mm offset	<b>820-51182</b>
00-13 Big Twin	51 tooth rear sprocket CHR 6mm offset	<b>820-51183</b>
00-13 Big Twin	46 tooth rear sprocket BLK	<b>820-51184</b>
00-13 Big Twin	47 tooth rear sprocket BLK	<b>820-51185</b>
00-13 Big Twin	48 tooth rear sprocket BLK	<b>820-51186</b>
00-13 Big Twin	49 tooth rear sprocket BLK	<b>820-51187</b>
00-13 Big Twin	51 tooth rear sprocket BLK	<b>820-51188</b>
00-13 Big Twin	46 tooth rear sprocket BLK 6mm offset	<b>820-51189</b>
00-13 Big Twin	47 tooth rear sprocket BLK 6mm offset	<b>820-51190</b>
00-13 Big Twin	48 tooth rear sprocket BLK 6mm offset	<b>820-51191</b>
00-13 Big Twin	49 tooth rear sprocket BLK 6mm offset	<b>820-51192</b>
00-13 Big Twin	51 tooth rear sprocket BLK 6mm offset	<b>820-51193</b>
Replaces OEM 40250-94	32 tooth belt drive pulley	<b>820-51194</b>
94-Up Big Twin	29 tooth belt drive pulley	<b>820-51195</b>
85-93 Big Twin	34 tooth belt drive pulley	<b>820-51196</b>
85-93 Big Twin	29 tooth belt drive pulley	<b>820-51197</b>
85-93 Big Twin	32 tooth belt drive pulley	<b>820-51198</b>
85-93 Big Twin	30 tooth belt drive pulley	<b>820-51199</b>

WINDSHIELDS / FAIRINGS

AUDIO / COMMUNICATION

SEATS / LUGGAGE

BAR / MIRRORS / CONTROLS

EXHAUST

AIR / FUEL SYSTEMS

ENGINE

**TRANSMISSION / DRIVELINE**

GASKETS / SEALS

ELECTRICAL

LIGHTING

CABLES

BRAKES

OIL FILTERS

SUSPENSION

BODY

WHEELS

TIRES / TIRE ACC.

BIKE ACC.

VICTORY / INDIAN

COVERS / LOCKS / TIEDOWNS

CHEMICALS

TOOLS

HELMETS

HELMET ACC.

EYEWEAR

APPAREL / RIDER ACC.

PROMOTIONAL

REFERENCE

INDEX



## PRO STREET VX-RING

Chain Length WPS#

530VX X-RING	
530VX x 110	690-67110
530VX x 120	690-67120
530VX x 150	690-67150
530VX x 25FT	690-67005
530VX x 25FT G/B	690-68005
530VX Rivet Masterlink	690-67001
530VX X-RING GOLD	
530VX x 110	690-68110
530VX x 120	690-68120
530VX x 150	690-68150
530VX Rivet Masterlink	690-68001

- Greater Rigidity
- Greater rigidity brings smoother handling, reduced power loss, and quicker response
- Highest value in all D.I.D. series
- Superior longer life than previous VM series



Model No.	Pin Length		Roller Dia. mm	Plate Thickness		Weights		Tensile Strength		Seal Type	Wear Resistance Index: Std. Chain=100
	mm	In.		Inner mm	Outer mm	Kgs/100 links	Lbs./100 links	Average KN	Lbs.		
<b>X-RING VM SPECIFICATIONS</b>											
50(530)VX	23.3	0.917	10.32	2.2	2.2	1.94	4.27	41	9220	X	3800

## SUPER STREET X-RING ZVMX SERIES

Chain Length WPS#

530ZVMX X-RING GOLD	
530ZVMX x 120	690-64120
530ZVMX Rivet Masterlink	690-64001

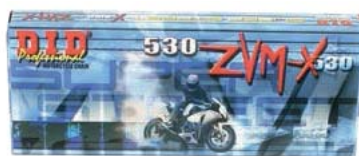

Model No.	Pin Length		Roller Dia. mm	Plate Thickness		Weights		Tensile Strength		Seal Type	Wear Resistance Index: Std. Chain=100
	mm	in.		Inner mm	Outer mm	Kgs/100 links	Lbs./100 links	Average KN	Lbs.		
<b>SUPER STREET X-RING ZVMX SERIES</b>											
530ZVMX	24.9	0.980	10.32	2.4	2.6	2.2	4.85	46.3	10408	X	4000



**STANDARD SERIES**

Chain Length	WPS#	Chain Length	WPS#
<b>530 STANDARD</b>		<b>630K STANDARD</b>	
530 x 110	<b>690-60110</b>	630K x 92	<b>690-80092</b>
530 x 120	<b>690-60120</b>	630K x 96	<b>690-80096</b>
530 x 25 FT	<b>690-60005</b>	630K x 98	<b>690-80098</b>
530 x 100 FT	<b>690-60006</b>	630K x 100	<b>690-80100</b>
530 Clip Masterlink	<b>690-60001</b>	630K x 110	<b>690-80110</b>
		630K x 118	<b>690-80118</b>
		630K Clip Masterlink	<b>690-80001</b>



**SUPER NON O-RING**

Chain Length	WPS#
<b>530 NZ</b>	
530NZ x 110	<b>690-61110</b>
530NZ x 112	<b>690-61120</b>
530NZ Rivet Masterlink	<b>690-61001</b>
530NZ Clip Masterlink	<b>690-61002</b>

Model No.	Pin Length		Roller Dia. mm	Plate Thickness		Weights		Tensile Strength		Seal Type	Wear Resistance
	mm	In.		Inner mm	Outer mm	Kgs/ 100 links	Lbs./ 100 links	Average KN	Lbs.		Index: Std. Chain=100
<b>SUPER NON O-RING NZ SPECIFICATIONS</b>											
50(530)NZ	22.55	.0917	10.2	2.4	2.4	1.85	4.07	38.3	8600	-	410



**CHAIN TOOL**

- Designed for 520,525,530 and 532 chain sizes
- Handy denim pouch included
- Use tool to push out pins, press plates and rivet links together

WPS#  
**690-9937**  
**REPLACEMENT PIN**  
**690-9936**

WINDSHIELDS / FAIRINGS

AUDIO / COMMUNICATION

SEATS / LUGGAGE

BAR / MIRRORS / CONTROLS

EXHAUST

AIR / FUEL SYSTEMS

ENGINE

**TRANSMISSION / DRIVELINE**

GASKETS / SEALS

ELECTRICAL

LIGHTING

CABLES

BRAKES

OIL FILTERS

SUSPENSION

BODY

WHEELS

TIRES / TIRE ACC.

BIKE ACC.

VICTORY / INDIAN

COVERS / LOCKS / TIEDOWNS

CHEMICALS

TOOLS

HELMETS

HELMET ACC.

EYEWEAR

APPAREL / RIDER ACC.

PROMOTIONAL

REFERENCE

INDEX



## SPECIFICATION CHART

Chain Model	Street	Dirt	Max HP	Pitch	Roller Dia	Roller Link Width	Pin Link Plate Thickness	Roller Link Plate Thickness	Pin Length	Avg. Tensil Strength	Wear Index (100 Std)
530DRZ2			300	5/8	10.20mm	0.375	2.40mm	2.40mm	23.00mm	11,500	200
530MVXZ	1000	750	145	5/8	10.30mm	0.375	2.20mm	2.20mm	24.60mm	9300	1500
530RXO	1100		150	5/8	10.20mm	0.375	2.20mm	2.20mm	24.60mm	9400	1000
530 Sport	350		30	5/8	10.16mm	0.375	2.00mm	2.00mm	20.50mm	7400	100
530SROZ	900	750	110	5/8	10.20mm	0.375	2.40mm	2.40mm	25.40mm	9100	800
530SRX	1000	750	120	5/8	10.20mm	0.375	2.40mm	2.40mm	25.40mm	9400	1200
530ZX2	1100		180	5/8	10.30mm	0.375	2.60mm	2.40mm	25.80mm	10560	1500
630MS	500			3/4	11.91mm	0.375	3.20mm	3.20mm	25.15mm	11,880	130

### 3D CHAIN

EK ThreeD (3D) Premium motorcycle chain is Elegant, Strong, Detailed and Magnificent. It offers the ultimate shape with flexibility and strength. EK Chain set out to produce a premium chain that was as beautiful as it is strong. An impressive outer plate shape that offers a curved form to reduce weight and increase appeal is connected together with inner plates and pins that feature lightening holes to further reduce mass. QX2 X-Rings have a better wear-resistance and performance than standard QX-Rings by 30% resulting in a chain that puts 1% more power to the rear tire.

#### 5 CONCEPTS TO MAKE OUR IDEAL "ThreeD" CHAIN A REALITY

##### IMPRESSIVE

- Ultimate plate shape
- 3D-designed with a beautiful curved form is an evolutionary shape

##### DYNAMIC

- Astonishing transmission efficiency
- Smooth and powerful acceleration

##### ELEGANT

- Bright Silver, Gold and Black premium chain
- Nothing but our 3D design makes it possible to have an elegant form and everlasting beautiful light reflection

##### ADVANCED

- Applying brand-new revolutionary process of manufacturing
- Far better than standard chains in every aspect such as fatigue strength, product quality and light weight
- Aiming for no initial stretch

##### LIGHT

- Slim design with minimum weight
- Produced by our exclusive technology to strengthen a chain without making it heavy.
- Weight per 100 links 530Z=4.81LB



Description	WPS#
<b>530 3D Z</b>	
530X120 Black/Gold	<b>693-1620BK</b>
	<b>693-1620C</b>
530X120 Gold	<b>693-1620G</b>
530X150 Black/Gold	<b>693-1650BK</b>
	<b>693-1650C</b>
530X150 Gold	<b>693-1650G</b>
530X160 Black/Gold	<b>693-1660BK</b>
	<b>693-1660C</b>
530X160 Gold	<b>693-1660G</b>
Rivet M/L Black	<b>693-0004BK</b>
Rivet M/L Chrome	<b>693-0004C</b>
Rivet M/L Gold	<b>693-0004G</b>



### MVXZ2 SERIES COLORED CHAIN

- For Offroad, ATV and 600-1000cc street applications
- Lightening holes on side plates
- Friction reducing QUADRA-X Rings
- X-Rings have greater sealing surface and less friction than O-ring chains
- Gives your bike the factory works look
- Larger pin diameter than standard chains make chains stronger and last longer

Links	WPS#
<b>530 MVXZ2</b>	
530X110	<b>693-9610</b>
530X110 Chrome	<b>693-9610C</b>
530X110 Gold	<b>693-9610G</b>
530X120	<b>693-9620</b>
530X120 Black/Gold	<b>693-9620BK</b>
530X120 Blue	<b>693-9620BU</b>
530X120 Chrome	<b>693-9620C</b>
530X120 Gold	<b>693-9620G</b>
530X120 Green	<b>693-9620GN</b>

Links	WPS#
<b>530 MVXZ2 (CONT'D...)</b>	
530X120 Orange	<b>693-9620OR</b>
530X120 Pink	<b>693-9620PK</b>
530X120 Red	<b>693-9620R</b>
530X120 Yellow	<b>693-9620Y</b>
530X130 Chrome	<b>693-9630C</b>
530X130 Gold	<b>693-9630G</b>
530X150 Black/Gold	<b>693-9650BK</b>
530X150 Chrome	<b>693-9650C</b>

Links	WPS#
<b>530 MVXZ2 (CONT'D...)</b>	
530X150 Gold	<b>693-9650G</b>
530 Rivet M/L	<b>693-9602</b>
530 Rivet M/L Chrome	<b>693-9602C</b>
530 Rivet M/L Gold	<b>693-9602G</b>
530 Screw M/L	<b>693-9603</b>
530 Screw M/L Chrome	<b>693-9603C</b>
530 Screw M/L Gold	<b>693-9603G</b>

### ZVX3 THE PINNACLE OF CHAIN TECHNOLOGY

- Ultra strong: ZVX3 series chains easily surpass every other brand with a tensile strength of 11,100lbs.
- New NX-ring lasts 15% longer than ZVX series
- Minimizing the clearance between the plates for improved stiffness and weight
- Available in metallic colors and natural finish

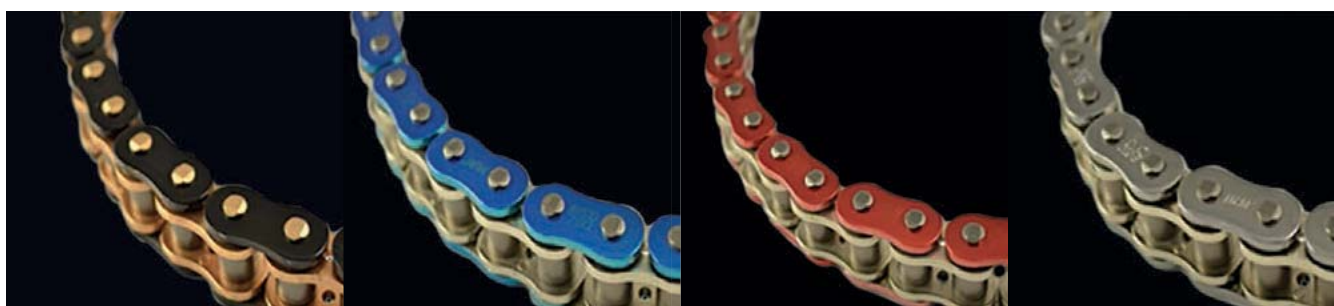

Black/Gold

Blue

Red

Chrome

Links	WPS#
<b>530ZVX3</b>	
530X120	<b>693-2220</b>
530X120 Black/Gold	<b>693-2220BK</b>
530X120 Chrome	<b>693-2220C</b>
530X120 Gold	<b>693-2220G</b>
530X120 Red	<b>693-2220RD</b>
530X120 Blue	<b>693-2220MB</b>
530X120 Green	<b>693-2220GN</b>
530X120 Orange	<b>693-2220OR</b>
530X120 Purple	<b>693-2220PP</b>
530X150	<b>693-2250</b>
530X150 Black/Gold	<b>693-2250BK</b>

Links	WPS#
<b>530ZVX3 (CONT'D...)</b>	
530X150 Chrome	<b>693-2250C</b>
530X150 Gold	<b>693-2250G</b>
530X150 Red	<b>693-2250RD</b>
530X150 Blue	<b>693-2250BU</b>
530X150 Green	<b>693-2250GN</b>
530X150 Orange	<b>693-2250OR</b>
530X150 Purple	<b>693-2250PP</b>
530X160	<b>693-2260</b>
530X160 Black/Gold	<b>693-2260BK</b>
530X160 Chrome	<b>693-2260C</b>
530X160 Gold	<b>693-2260G</b>

Links	WPS#
<b>530ZVX3 (CONT'D...)</b>	
530X160 Red	<b>693-2260RD</b>
530X160 Blue	<b>693-2260BU</b>
530X160 Green	<b>693-2260GN</b>
530X160 Orange	<b>693-2260OR</b>
530X160 Purple	<b>693-2260PP</b>
100' roll Chrome	<b>693-22100C</b>
Rivet M/L	<b>693-2200</b>
Rivet M/L Gold	<b>693-2200G</b>
Rivet M/L Chrome	<b>693-2200C</b>
Screw M/L	<b>693-2201</b>
Screw M/L Gold	<b>693-2201G</b>

- WINDSHIELDS / FAIRINGS
- AUDIO / COMMUNICATION
- SEATS / LUGGAGE
- BARS / MIRRORS / CONTROLS
- EXHAUST
- AIR / FUEL SYSTEMS
- ENGINE
- TRANSMISSION / DRIVELINE**
- GASKETS / SEALS
- ELECTRICAL
- LIGHTING
- CABLES
- BRAKES
- OIL FILTERS
- SUSPENSION
- BODY
- WHEELS
- TIRES / TIRE ACC.
- BIKE ACC.
- VICTORY / INDIAN
- COVERS / LOCKS / TIEDOWNS
- CHEMICALS
- TOOLS
- HELMETS
- HELMET ACC.
- EYEWEAR
- APPAREL / RIDER ACC.
- PROMOTIONAL
- REFERENCE
- INDEX

- WINDSHIELDS / FAIRINGS
- AUDIO / COMMUNICATION
- SEATS / LUGGAGE
- BARS / MIRRORS / CONTROLS
- EXHAUST
- AIR / FUEL SYSTEMS
- ENGINE
- TRANSMISSION / DRIVELINE**
- GASKETS / SEALS
- ELECTRICAL
- LIGHTING
- CABLES
- BRAKES
- OIL FILTERS
- SUSPENSION
- BODY
- WHEELS
- TIRES / TIRE ACC.
- BIKE ACC.
- VICTORY / INDIAN
- COVERS / LOCKS / TIEDOWNS
- CHEMICALS
- TOOLS
- HELMETS
- HELMET ACC.
- EYEWEAR
- APPAREL / RIDER ACC.
- PROMOTIONAL
- REFERENCE
- INDEX



### MS CHAIN

For Drag Race applications

- The most popular 630 drag racing chain in the U.S. market
- High strength and low drag
- Recommended for applications up to 500 hp
- Chrome finish

Links	WPS#
<b>630 MS</b>	
630x120	<b>69-5520C</b>
630x130	<b>69-5530C</b>
630x140	<b>69-5540C</b>
630x150	<b>69-5550C</b>
Clip M/L Chrome	<b>69-5501C</b>



### DRZ-2 CHAIN

For Drag race applications

- Crafted with drag racing in mind
- Strongest non-sealed chain today - 11,500lb. tensile strength
- Available in lengths for extended swingarms

Links	WPS#
<b>530 DRZ-2</b>	
530x120 Chrome	<b>69-6520</b>
530x130 Chrome	<b>69-6530</b>
530x140 Chrome	<b>69-6540</b>
530x150 Chrome	<b>69-6550</b>
530x160 Chrome	<b>69-6560</b>
530x170 Chrome	<b>69-6570</b>
Clip M/L Chrome	<b>69-6501C</b>
Rivet M/L Chrome	<b>69-6502C</b>



### SRO SERIES O-RING (SRO, SRO-Z, SRO-5)

For Dirt, ATV and Street applications

- High quality O-ring chain seals in lube and keeps water and mud out
- Solid rollers and entended anti-kink bushings increase chain longevity
- Japanese made chain with quad staked riveting of pins into side plates
- Available in gold and standard finish

Links	WPS#
<b>630 SRO O-RING</b>	
630x96	<b>69-9396</b>
630x98	<b>69-9398</b>
630x100	<b>69-9400</b>
630x110	<b>69-9410</b>
Clip M/L	<b>69-9301</b>
Rivet M/L	<b>69-9302</b>





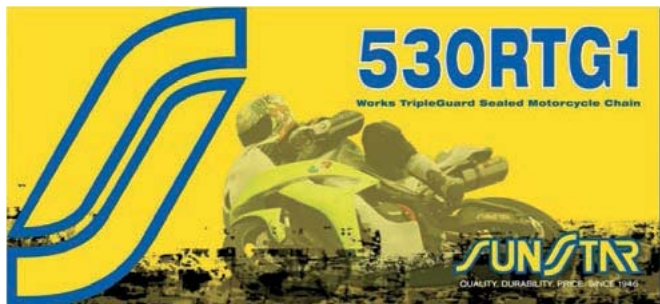

Description/Chain Length	WPS#
<b>530 RTG</b>	
530 X 116	<b>691-0916</b>
530 X 120	<b>691-0920</b>
Rivet Masterlink	<b>691-0901</b>



### RTG SEALED CHAIN

- Utilizes Sunstar's exclusive TG-ring (TripleGuard) where the ring seals with 3 lips per side for the ultimate in heat prevention and keeping the chain lubricated even in extremely harsh conditions
- The 520RTG1 is the perfect choice for racing / performance oriented applications with 520 chain size. With a tensile strength of 9900 lbs, the 530RTG1 is intended for the large displacement sport machines like Ninja 1400, GSX1300R Hayabusas and others
- Color option: Gold
- Uses rivet type connecting link



## CHAINS **VORTEX**

- Drilled links reduce rotating mass
- Tri Glide X rings reduce friction
- Quad peened pins, pre stretched to ensure proper fit
- RX3 Roadrace series chains are intended for road race/track use only
- All Vortex chains come with a rivet style master link, a clip style link is available for the SX3 series chains only (sold separately)

### SX3 TENSILE STRENGTH

- 520 - 8,500 lbs
- 525 - 9,000 lbs
- 530 - 9,000 lbs

### RX3 TENSILE STRENGTH

- 520 - 9,400 lbs
- 525 - 10,300 lbs
- 530 - 11,100 lbs

### RX3 ROADRACE TENSILE STRENGTH

- 520 - 8,500 lbs

Description	Black	Gold
<b>SX3 CHAIN</b>		
520 x 114 (750cc max.)	<b>3-520SX3114</b>	<b>3-G520SX3114</b>
520 x 120 (750cc max.)	<b>3-520SX3120</b>	<b>3-G520SX3120</b>
525 x 114 (1000cc max.)	<b>3-525SX3114</b>	<b>3-G525SX3114</b>
525 x 120 (1000cc max.)	<b>3-525SX3120</b>	<b>3-G525SX3120</b>
530 x 114 (1000cc max.)	<b>3-530SX3114</b>	<b>3-G530SX3114</b>
530 x 120 (1000cc max.)	<b>3-530SX3120</b>	<b>3-G530SX3120</b>
520 Clip m/link	<b>3-520SX3C</b>	<b>3-G520SX3C</b>
520 Rivet m/link	<b>3-520SX3R</b>	<b>3-G520SX3R</b>
525 Clip m/link	<b>3-525SX3C</b>	<b>3-G525SX3C</b>
525 Rivet m/link	<b>3-525SX3R</b>	<b>3-G525SX3R</b>
530 Clip m/link	<b>3-530SX3C</b>	<b>3-G530SX3C</b>
530 Rivet m/link	<b>3-530SX3R</b>	<b>3-G530SX3R</b>
<b>RX3 CHAIN</b>		
520 x 114 (1200cc max.)	<b>3-520RX3114</b>	<b>3-G520RX3114</b>
520 x 120 (1200cc max.)	<b>3-520RX3120</b>	<b>3-G520RX3120</b>
525 x 114 (1300cc max.)	<b>3-525RX3114</b>	<b>3-G525RX3114</b>
525 x 120 (1300cc max.)	<b>3-525RX3120</b>	<b>3-G525RX3120</b>
530 x 114 (1400cc max.)	<b>3-530RX3114</b>	<b>3-G530RX3114</b>
530 x 120 (1400cc max.)	<b>3-530RX3120</b>	<b>3-G530RX3120</b>
520 Rivet m/link	<b>3-520RX3R</b>	<b>3-G520RX3R</b>
525 Rivet m/link	<b>3-525RX3R</b>	<b>3-G525RX3R</b>
530 Rivet m/link	<b>3-530RX3R</b>	<b>3-G530RX3R</b>
<b>RX3 ROADRACE CHAIN</b>		
520 x 120 (1000cc max.)	<b>3-520RRX3120</b>	<b>3-G520RRX3120</b>
520 Rivet m/link	<b>3-520RRX3R</b>	<b>3-G520RRX3R</b>

- WINDSHIELDS / FAIRINGS
- AUDIO / COMMUNICATION
- SEATS / LUGGAGE
- BAR / MIRRORS / CONTROLS
- EXHAUST
- AIR / FUEL SYSTEMS
- ENGINE
- TRANSMISSION / DRIVELINE**
- GASKETS / SEALS
- ELECTRICAL
- LIGHTING
- CABLES
- BRAKES
- OIL FILTERS
- SUSPENSION
- BODY
- WHEELS
- TIRES / TIRE ACC.
- BIKE ACC.
- VICTORY / INDIAN
- COVERS / LOCKS / TIEDOWNS
- CHEMICALS
- TOOLS
- HELMETS
- HELMET ACC.
- EYEWEAR
- APPAREL / RIDER ACC.
- PROMOTIONAL
- REFERENCE
- INDEX



## STANDARD & HEAVY DUTY CHAINS



- Designed and manufactured in Japan
- Hardened and shot peened components
- Solid rollers, pre-stretched
- All chains are available in natural finish, gold finish available depending on chain pitch/length

- All chains supplied with clip style master links.
- All rolls of chain include 5 master links per 25' of chain.

[See page 451 for specification chart.](#)

### STANDARD FPS SERIES

530	WPS#
100 Link	692-6100
102 Link	692-6102
104 Link	692-6104
106 Link	692-6106
110 Link	692-6110
112 Link	692-6112
114 Link	692-6114
116 Link	692-6116
120 Link	692-6120
130 Link	692-6130
25' Roll	692-61025
Clip master link	692-6001



### HEAVY DUTY FPH SERIES

530H	WPS#
100 Link	692-8100
102 Link	692-8102
104 Link	692-8104
106 Link	692-8106
110 Link	692-8110
110 Link, gold	692-8110G
112 Link	692-8112
114 Link	692-8114
120 Link	692-8120
120 Link, gold	692-8120G
130 Link	692-8130
25' Roll	692-81025
Clip master link	692-8001
Clip master link, gold	692-8001G



### O-RING & X-RING SEALED CHAINS

- Designed and manufactured in Japan
- Hardened and shot peened components
- Quad stake riveted pins, pre-stretched
- Long lasting o-ring/x-ring seals
- All chains are available in natural finish, gold finish available depending on chain pitch/length
- All chains supplied with clip style master links, rivet style master links available separately.
- All rolls of chain include 5 master links per 25' of chain.



### O-RING FPO SERIES

530 O-RING	WPS#
100 Link	692-6200
110 Link	692-6210
112 Link	692-6212
114 Link	692-6214
120 Link	692-6220
120 Link, gold	692-6220G
130 Link	692-6230
130 Link, gold	692-6230G
150 Link	692-6250
150 Link, gold	692-6250G
25' Roll	692-62025
100' Roll	692-62100
Clip master link	692-6201
Clip master link, gold	692-6201G
Rivet master link	692-6203
Rivet master link, gold	692-6203G



### X-RING FPX SERIES

530 X-RING	WPS#
100 Link	692-5700
110 Link	692-5710
114 Link	692-5714
120 Link	692-5720
120 Link, gold	692-5720G
130 Link	692-5730
130 Link, gold	692-5730G
150 Link	692-5750
150 Link, gold	692-5750G
25' Roll	692-57025
100' Roll	692-57100
Clip master link	692-5701
Clip master link, gold	692-5701G
Rivet master link	692-5703
Rivet master link, gold	692-5703G



## SPECIFICATION CHART

FIRE POWER CHAIN SPECIFICATION CHART								
	Pin Diameter mm	Pin Length mm	Roller Diameter mm	Plate Thickness mm	Tensile Strength	Wear Index	Max. Displacement Street	Max. Displacement Dirt
<b>420FPS</b>	3.96	14.7	7.77	1.5	4,300	100	80	80
<b>428FPS</b>	4.44	16.3	8.51	1.5	4,400	100	100	80
<b>520FPS</b>	5.08	17.3	10.16	2	7,400	100	250	125
<b>530FPS</b>	5.08	20.5	10.16	2	7,400	100	350	N/A
<b>428FPH</b>	4.5	17.4	8.51	1.5	4,900	120	125	80
<b>520FPH</b>	5.08	18.5	10.16	2	8,000	200	350	250
<b>530FPH</b>	5.08	21.3	10.16	2	8,000	200	400	N/A
<b>520FPO</b>	5.38	20.8	10.16	2.2	9,000	1,000	1000	750
<b>525FPO</b>	5.38	22.35	10.2	2.2	9,000	1,000	1000	750
<b>530FPO</b>	5.38	24	10.2	2.2	9,000	1,000	1000	750
<b>520FPX</b>	5.38	19.95	10.16	2	8,500	1,500	800	700
<b>525FPX</b>	5.38	22.35	10.2	2.2	9,000	1,500	1,000	750
<b>530FPX</b>	5.38	24	10.2	2.2	9,000	1,500	1,000	750

## THE GRUNGE BRUSH

Description	WPS#
Grunge Brush	<b>57-00801</b>
Aluminum Grunge Brush	<b>57-00805</b>
Grunge Brush combo pack	<b>57-00802</b>
Alum. Grunge Brush combo pack	<b>57-00806</b>
Replacement brush set	<b>57-00803</b>
Replacement Grunge Brush solution	<b>57-00804</b>

- Innovative design that cleans chain from 3 angles at once
- Long handle keeps fingers and hands away from chain and sprockets
- Will not harm O-ring or X-ring chains
- Easily adjustable for all sizes of motorcycle, ATV and bicycle chains



- WINDSHIELDS / FAIRINGS
- AUDIO / COMMUNICATION
- SEATS / LUGGAGE
- BAR / MIRRORS / CONTROLS
- EXHAUST
- AIR / FUEL SYSTEMS
- ENGINE
- TRANSMISSION / DRIVELINE**
- GASKETS / SEALS
- ELECTRICAL
- LIGHTING
- CABLES
- BRAKES
- OIL FILTERS
- SUSPENSION
- BODY
- WHEELS
- TIRES / TIRE ACC.
- BIKE ACC.
- VICTORY / INDIAN
- COVERS / LOCKS / TIEDOWNS
- CHEMICALS
- TOOLS
- HELMETS
- HELMET ACC.
- EYEWEAR
- APPAREL / RIDER ACC.
- PROMOTIONAL
- REFERENCE
- INDEX



**MILWAUKEE 8 GASKETS AND SEALS** 

- At Cometic Gasket, our goal is to offer the latest in gasket technology
- Materials, manufacturing processes and gasket designs are constantly improving to match the higher level of performance for today's powerful V-Twin engines
- Cometic Gasket Kits for Harley Davidson models include every gasket, seal, washer, and o-ring needed for a complete overhaul

- When purchasing a Cometic gasket kit, you can rest assured that every component will be the best solution for your application
- EST "Extreme Sealing Technology" kits are available in Complete Motor Kits and Top End Kits
- Harley-Davidson® EST Gasket Kits contain MLS Head Gaskets, Steel Viton coated Base Gaskets, blue Viton Valve Stem Seals and AFM material

- WINDSHIELDS / FAIRINGS
- AUDIO / COMMUNICATION
- SEATS / LUGGAGE
- BAR / MIRRORS / CONTROLS
- EXHAUST
- AIR / FUEL SYSTEMS
- ENGINE
- TRANSMISSION / DRIVELINE
- GASKETS / SEALS**
- ELECTRICAL
- LIGHTING
- CABLES
- BRAKES
- OIL FILTERS
- SUSPENSION
- BODY
- WHEELS
- TIRES / TIRE ACC.
- BIKE ACC.
- VICTORY / INDIAN
- COVERS / LOCKS / TIEDOWNS
- CHEMICALS
- TOOLS
- HELMETS
- HELMET ACC.
- EYEWEAR
- APPAREL / RIDER ACC.
- PROMOTIONAL
- REFERENCE
- INDEX

OEM#	Application	Quantity	WPS#
<b>MILWAUKEE 8 GASKETS, SEALS, O-RINGS</b>			
<b>EST GASKET KITS</b>			
25700729	'17-Up 107" Milwaukee 8 Engine/Trans Gasket Kit w/.040" Headgaskets 3.937"	Kit	<b>68-10217</b>
	'17-Up 107" Milwaukee 8 Engine/Trans Gasket Kit w/.030" Headgaskets 3.937"	Kit	<b>68-10217-030</b>
	'17-Up 114" CVO Milwaukee 8 Engine/Trans Gasket Kit w/.040" Headgaskets 4.000"	Kit	<b>68-10218</b>
	'17-Up 114" CVO Milwaukee 8 Engine/Trans Gasket Kit w/.030" Headgaskets 4.000"	Kit	<b>68-10218-030</b>
	'17-Up 114" Milwaukee 8 Engine/Trans Gasket Kit w/.040" Headgaskets 4.075"	Kit	<b>68-10219</b>
	'17-Up 114" Milwaukee 8 Engine/Trans Gasket Kit w/.030" Headgaskets 4.075"	Kit	<b>68-10219-030</b>
	'17-Up 117" Milwaukee 8 Engine/Trans Gasket Kit w/.040" Headgaskets 4.125"	Kit	<b>68-10220</b>
	'17-Up 117" Milwaukee 8 Engine/Trans Gasket Kit w/.030" Headgaskets 4.125"	Kit	<b>68-10220-030</b>
	'17-Up 120" Milwaukee 8 Engine/Trans Gasket Kit w/.040" Headgaskets 4.185"	Kit	<b>68-10221</b>
	'17-Up 120" Milwaukee 8 Engine/Trans Gasket Kit w/.030" Headgaskets 4.185"	Kit	<b>68-10221-030</b>
	'17-Up 121" Milwaukee 8 Engine/Trans Gasket Kit w/.040" Headgaskets 4.200"	Kit	<b>68-10222</b>
	'17-Up 121" Milwaukee 8 Engine/Trans Gasket Kit w/.030" Headgaskets 4.200"	Kit	<b>68-10222-030</b>
	'17-Up 124" Milwaukee 8 Engine/Trans Gasket Kit w/.040" Headgaskets 4.250" Twin Cooled Only	Kit	<b>68-10223</b>
	'17-Up 124" Milwaukee 8 Engine/Trans Gasket Kit w/.030" Headgaskets 4.250" Twin Cooled Only	Kit	<b>68-10223-030</b>
	'17-Up Milwaukee 8 .030" Head & .014" Base Gasket Kit 3.937" Bore	Kit	<b>68-10164-HB</b>
	'17-Up Milwaukee 8 .030" Head & .014" Base Gasket Kit 4.075" Bore	Kit	<b>68-10166-HB</b>
	'17-Up Milwaukee 8 .030" Head & .014" Base Gasket Kit 4.125" Bore	Kit	<b>68-10167-HB</b>
	'17-Up Milwaukee 8 .040" Head & .014" Base Gasket Kit 4.250" Bore Twin Cooled Only	Kit	<b>68-10191-HB</b>
	'17-Up Milwaukee 8 .040" Head & .014" Base Gasket Kit 4.320" Bore Twin Cooled Only	Kit	<b>68-10192-HB</b>
	'17-Up Milwaukee 8 .040" Head & .014" Base Gasket Kit 4.500" Bore Twin Cooled Only	Kit	<b>68-10193-HB</b>
	'17-Up Milwaukee 8 .027" Head & .014" Base Gasket Kit 4.500" Bore Twin Cooled Only	Kit	<b>68-10193-H</b>
25700731	'17-Up Milwaukee 8 Cam Change Kit	Kit	<b>68-10178</b>
25700746	'17-Up Milwaukee 8 Touring Primary Gasket & Seal Kit	Kit	<b>68-10196</b>
91800058-X	'17-Up Milwaukee 8 Induction Module O-ring Kit	Kit	<b>68-10200</b>
	'17-Up Milwaukee 8 Touring Trans Rebuild Kit w/Oil Pan Gasket	Kit	<b>68-10197</b>
<b>ROCKER BOX ASSEMBLY GASKETS</b>			
11900116	'17-Up Milwaukee 8 Breather Assembly O-ring, Viton	10	<b>68-10189</b>
25700372	'17-Up Milwaukee 8 Upper Rocker Box Gasket	10	<b>68-10179</b>
25700372	'17-Up Milwaukee 8 Upper Rocker Box Gasket	2	<b>68-10179-2</b>
25700425	'17-Up Milwaukee 8 Lower Rocker Box Gasket	2	<b>68-10183</b>
<b>PUSHROD, TAPPET GASKETS AND VALVE STEM SEALS</b>			
18100044	'17-Up Milwaukee 8 Valve Stem Seals	8	<b>68-10202</b>
25700362	'17-Up Milwaukee 8 Tappet Cover Gaskets .032" AFM	10	<b>68-10172</b>
<b>HEAD AND BASE GASKETS</b>			
16500326	'17-Up 107" Milwaukee 8 .040" Head Gaskets 3.937" Bore	2	<b>68-10164</b>
	'17-Up 107" Milwaukee 8 .030" Head Gaskets 3.937" Bore	2	<b>68-10164-030</b>
16500305	'17-Up 114" Milwaukee 8 .040" Head Gaskets 4.000" Bore	2	<b>68-10165</b>
	'17-Up 114" Milwaukee 8 .030" Head Gaskets 4.000" Bore	2	<b>68-10165-030</b>
	'17-Up 114" Milwaukee 8 .040" Head Gaskets 4.075" Bore	2	<b>68-10166</b>
	'17-Up 114" Milwaukee 8 .030" Head Gaskets 4.075" Bore	2	<b>68-10166-030</b>
	'17-Up 117" Milwaukee 8 .040" Head Gaskets 4.125" Bore	2	<b>68-10167</b>
	'17-Up 117" Milwaukee 8 .030" Head Gaskets 4.125" Bore	2	<b>68-10167-030</b>
	'17-Up 117" Milwaukee 8 .036" Head Gaskets 4.125" Bore	2	<b>68-10167-036</b>
	'17-Up 117" Milwaukee 8 .045" Head Gaskets 4.125" Bore	2	<b>68-10167-045</b>
	'17-Up 120" Milwaukee 8 .040" Head Gaskets 4.185" Bore	2	<b>68-10168</b>
	'17-Up 120" Milwaukee 8 .030" Head Gaskets 4.185" Bore	2	<b>68-10168-030</b>
	'17-Up 121" Milwaukee 8 .040" Head Gaskets 4.200" Bore	2	<b>68-10169</b>
	'17-Up 121" Milwaukee 8 .030" Head Gaskets 4.200" Bore	2	<b>68-10169-030</b>
	'17-Up 124" Milwaukee 8 .040" Head Gaskets 4.250" Bore	2	<b>68-10181</b>
	'17-Up 124" Milwaukee 8 .030" Head Gaskets 4.250" Bore	2	<b>68-10181-030</b>
	'17-Up Milwaukee 8 .040" Head Gaskets 4.320" Bore	2	<b>68-10182</b>

**MILWAUKEE 8 GASKETS AND SEALS**

OEM#	Application	Quantity	WPS#
<b>MILWAUKEE 8 GASKETS, SEALS, O-RINGS</b>			
<b>HEAD AND BASE GASKETS (CONT'D...)</b>			
16500305	'17-Up Milwaukee 8 .030" Head Gaskets 4.320" Bore	2	<b>68-10182-030</b>
	'17-Up 124" Milwaukee 8 .040" Head Gaskets 4.250" Bore Twin Cooled Only	2	<b>68-10191</b>
	'17-Up Milwaukee 8 .040" Head Gaskets 4.320" Bore Twin Cooled Only	2	<b>68-10192</b>
	'17-Up Milwaukee 8 .040" Head Gaskets 4.500" Bore Twin Cooled Only	2	<b>68-10193</b>
16500332	'17-Up Milwaukee 8 Base Gaskets .014" Thick (Stock)	2	<b>68-10177</b>
	'17-Up Milwaukee 8 Base Gaskets .010" Thick	2	<b>68-10177-010</b>
	'17-Up Milwaukee 8 Base Gaskets .020" Thick	2	<b>68-10177-020</b>
	'17-Up Milwaukee 8 Base Gaskets .014" Thick for 4.320" Bore	2	<b>68-10194</b>
	'17-Up Milwaukee 8 Base Gaskets .014" Thick for 4.500" Bore	2	<b>68-10195</b>
<b>MOTOR CASE O-RINGS AND SEALS</b>			
11000134	'17-Up Milwaukee 8 Crank Seal	4	<b>68-10209</b>
11900010	'17-Up Milwaukee 8 Case Plug O-ring, Twin Cooled	10	<b>68-10208</b>
11900103	'17-Up Milwaukee 8 Cam Plate to Oil Pump O-ring	10	<b>68-10210</b>
24400215	'17-Up Milwaukee 8 Engine to Trans Gasket	1	<b>68-10214</b>
25700433	'17-Up Milwaukee 8 Piston Jet Cooler Gasket .032" AFM	2	<b>68-10174</b>
<b>CAM HOUSING</b>			
11900103	'17-Up Milwaukee 8 Cam Plate to Oil Pump O-ring	10	<b>68-10210</b>
25700370	'17-Up Milwaukee 8 Cam Cover Gasket .032" AFM	5	<b>68-10173</b>
<b>INTAKE AND EXHAUST GASKETS</b>			
27300082	'17-Up Milwaukee 8 Seal Manifold to Throttle Body	4	<b>68-10204</b>
27300087	'17-Up Milwaukee 8 Intake Seal Manifold to Head	4	<b>68-10203</b>
29000108	'17-Up Milwaukee 8 Seal Air Cleaner to Throttle Body	4	<b>68-10207</b>
29000149	'17-Up Milwaukee 8 Airbox to Throttle Body Gasket .031" CVO FLHX	1	<b>68-10176</b>
32700065	'17-Up Milwaukee 8 MAP Sensor O-ring Viton	10	<b>68-10190</b>
91800058-B	'17-Up Milwaukee 8 Black Injector O-ring	10	<b>68-10205</b>
91800058-O	'17-Up Milwaukee 8 Orange Injector O-ring	10	<b>68-10206</b>
<b>PRIMARY HOUSING GASKETS</b>			
25416-16	'16-Up Touring (Except CVO and Low) 5-Hole Derby Cover Gasket	1	<b>68-10140F1</b>
	'16-Up Touring (Except CVO and Low) 5-Hole Derby Cover Gasket	5	<b>68-10140F5</b>
25700378	'17-Up Milwaukee 8 Primary Gasket .060" AFM	1	<b>68-10198F1</b>
	'17-Up Milwaukee 8 Primary Gasket .060" AFM	5	<b>68-10198F5</b>
25700455	'17-Up Milwaukee 8 Primary to Engine Gasket	1	<b>68-10211</b>
<b>TRANSMISSION GASKETS</b>			
11000101	'17-Up Milwaukee 8 Trans Shift Shaft Seal	5	<b>68-10213</b>
11900092	'17-Up Milwaukee 8 Trans Plug O-ring	10	<b>68-10212</b>
25700452	'17-Up Milwaukee 8 Touring Trans Oil Pan Gasket .032" AFM	1	<b>68-10215</b>
25700453	'17-Up Milwaukee 8 Touring Trans Top Cover Gasket .060" AFM	1	<b>68-10216</b>
<b>MISCELLANEOUS GASKETS, SEALS, AND O-RINGS</b>			
11900090	'17-Up Milwaukee 8 Coolant Manifold O-ring	10	<b>68-10201</b>

WINDSHIELDS / FAIRINGS

AUDIO / COMMUNICATION

SEATS / LUGGAGE

BARS / MIRRORS / CONTROLS

EXHAUST

AIR / FUEL SYSTEMS

ENGINE

TRANSMISSION / DRIVELINE

GASKETS / SEALS

ELECTRICAL

LIGHTING

CABLES

BRAKES

OIL FILTERS

SUSPENSION

BODY

WHEELS

TIRES / TIRE ACC.

BIKE ACC.

VICTORY / INDIAN

COVERS / LOCKS / TIEDOWNS

CHEMICALS

TOOLS

HELMETS

HELMET ACC.

EYEWEAR

APPAREL / RIDER ACC.

PROMOTIONAL

REFERENCE

INDEX



**TWIN CAM GASKETS & SEALS**

- At Cometic Gasket, our goal is to offer the latest in gasket technology
- Materials, manufacturing processes and gasket designs are constantly improving to match the higher level of performance for today's powerful V-Twin engines
- Cometic Gasket Kits for Harley Davidson models include every gasket, seal, washer, and o-ring needed for a complete overhaul
- When purchasing a Cometic gasket kit, you can rest assured that every component will be the best solution for your application
- EST "Extreme Sealing Technology" kits are available in Complete Motor Kits and Top End Kits
- **Harley-Davidson® EST Gasket Kits** contain MLS Head Gaskets, Steel Viton coated Base Gaskets, blue Viton Valve Stem Seals and AFM material



OEM#	Application	Quantity	WPS#
<b>TWIN CAM GASKETS,SEALS, O-RINGS</b>			
<b>EST GASKET KITS</b>			
17052-99B	'02-11 Twin Cam standard 3.750" Bore Top End Gasket Kit w/ hat style valve stem seal	Kit	<b>68-9146</b>
17053-99B	'07-11 Softail Models standard Bore 3.750" .040" Head Gasket, Complete Gasket Kit	Kit	<b>68-9171</b>
17053-99C	'07-11 All FL Models, standard 3.750" Bore & .040" Head Gasket, Complete Kit	Kit	<b>68-9172</b>
	'94-06 FLT, FLH, FXR Primary Gasket Kit	Kit	<b>68-9888</b>
	'94-06 FXST, 94-05 FXD Primary Kit	Kit	<b>68-9885</b>
	'99-02 Twin Cam motor 3.875" Bore Top End Gasket Kit w/ .040" MLS Head Gaskets	Kit	<b>68-9780</b>
	'14-16 Twin Cam 103" Twin Cooled Top End Kit .040 Head Gaskets	Kit	<b>68-10170</b>
	'99-17 Twin Cam motor 3.875" Bore Top End Gasket Kit w/ .045" MLS Head Gaskets	Kit	<b>68-9951</b>
	'99-17 Twin Cam motor 3.875" Bore Top End Gasket Kit w/ .051" MLS Head Gaskets	Kit	<b>68-995151</b>
	'99-02 Twin Cam motor 4.00" Bore Top End Gasket Kit w/ .040" MLS Head Gaskets & .010" Base	Kit	<b>68-9949</b>
	99-02 Twin Cam Motors 4.125" EST Big Bore Top End Gasket Kit w/ .030" MLS Head Gaskets & .020" Base	Kit	<b>68-997630</b>
	'99-02 Twin Cam Motors 4.125" EST Big Bore Top End Gasket Kit w/ .040" MLS Head Gaskets & .020" Base	Kit	<b>68-9976</b>
	'99-02 Twin Cam motor 4.25" Bore Top End Gasket Kit w/ .040" MLS Head Gaskets & .010" Base	Kit	<b>68-9238</b>
	'99-02 Twin Cam motor Standard Bore w/ .030" MLS Head Gaskets, Top End Gasket Kit,	Kit	<b>68-9845</b>
	'99-02 Twin Cam motor Standard Bore w/ .040" MLS Head Gaskets, Top End Gasket Kit,	Kit	<b>68-9779</b>
	'99-05 Dyna and '99-06 Twin Cam Models 3.875 Bore w/ .030" MLS Head Gasket Complete Gasket Kit	Kit	<b>68-9161</b>
	'99-05 Dyna and '99-06 Twin Cam Models 4.125 Bore w/ .040" MLS Head Gasket & .010" Base, Complete Gasket Kit	Kit	<b>68-9221</b>
	'99-05 Dyna and '99-06 Twin Cam Models 4.125 Bore w/ .030" MLS Head Gasket & .010" Base, Complete Gasket Kit	Kit	<b>68-922130</b>
	'99-06 FXST, '99-05 Dyna 4" Big Bore Complete Gasket Kit w/ .030" Head Gaskets	Kit	<b>68-9807</b>
	'99-06 Softail, '99-05 Dyna Standard 3.750" Bore w/ .040" MLS Head Gasket, Complete Gasket Kit,	Kit	<b>68-9777</b>
	'99-06 Touring Models Standard 3.750" Bore & .040" Head Gasket Complete Gasket Kit,	Kit	<b>68-9778</b>
	'99-06 Touring models and FXR models 4.125" Bore w/ .040" Head Gasket & .010" Base, Complete Gasket Kit	Kit	<b>68-9222</b>
	'99-06 Touring models and FXR models 4.125" Bore w/ .030" Head Gasket & .010" Base, Complete Gasket Kit	Kit	<b>68-922230</b>
	'99-06 Touring/Softail and '99-05 Dyna Models 3.875" Bore w/ .040" MLS Head Gaskets complete Gasket Kit,	Kit	<b>68-9920</b>
	'99-06 All FL Models 4" Big Bore Complete Gasket Kit w/ .030" MLS Head Gaskets	Kit	<b>68-10005</b>
	'99-17 Twin Cam Models 3.937" Bore Top End Gasket Kit w/ .040" MLS Head Gaskets	Kit	<b>68-9182</b>
	'99-17 Twin Cam Models 4.060" Bore Top End Gasket Kit w/ .030" MLS Head Gaskets & .010" Steel Base Gaskets	Kit	<b>68-911430</b>
	'99-17 Twin Cam Models 4.060" Bore Top End Gasket Kit w/ .040" MLS Head Gaskets & .010" Steel Base Gaskets	Kit	<b>68-9114</b>
	'99-17 Twin Cam FATSO Top End Gasket Kit	Kit	<b>68-9789</b>
	'99-17 Twin Cam FATSO Rocker Box Rebuild Gasket Kit	Kit	<b>68-9840</b>
	'99-17 Twin Cam Rocker Box Rebuild Kit	Kit	<b>68-9588</b>
	'03-17 Twin Cam motor 95/103" Big Bore 3.875 Top End Gasket Kit	Kit	<b>68-9147</b>
	'03-17 Twin Cam motor 95/103" Big Bore 3.875 Top End Gasket Kit w/ .030" MLS Head Gasket	Kit	<b>68-9844</b>
	'06-17 Dyna 103" 3.875" Big Bore, 2012-17 Dyna Standard Bore Complete Gasket Kit	Kit	<b>68-9186</b>
	'06-17 Dyna Models 103" 3.875" Big Bore & .030" Head Gasket, '12-17 Dyna Standard Bore Complete Gasket Kit	Kit	<b>68-9149</b>
	'06-17 Dyna Models standard Bore 3.750" & .040" Head Gasket, Complete Gasket K	Kit	<b>68-9148</b>
	'07-11 All FL Models 103", Big Bore 3.875" & .040" Head, '12-17 Standard Bore Gasket Complete Kit	Kit	<b>68-9185</b>
	'07-11 Softail 103" Big Bore 3.875"; '12-17 Standard Bore Softail, Complete Gasket Kit	Kit	<b>68-9184</b>
	S&S Rocker Box Rebuild Gasket Kit (die cast boxes only)	Kit	<b>68-9155</b>

Continued on the next page



## TWIN CAM GASKETS & SEALS

OEM#	Application	Quantity	WPS#
<b>TWIN CAM GASKETS, SEALS, O-RINGS</b>			
<b>ROCKER BOX ASSEMBLY GASKETS</b>			
11270	'99-17 Twin Cam Rocker Arm Support O-ring	10	<b>68-9629</b>
26500002	'11-17 Twin Cam Breather Element Gasket	10	<b>68-10039</b>
16719-99	'99-17 Twin Cam Rocker Housing Gasket .020" Rubber Coated Steel	10	<b>68-9576</b>
17286-99	'99-17 Twin Cam Rocker Cover Gasket .020" Rubber Coated Steel	10	<b>68-9577</b>
26858-99	'99-17 Twin Cam Rocker Cover Umbrella Valve	10	<b>68-9633</b>
	'99-17 Twin Cam Screaming Eagle Heads Rocker Box Rebuild Gasket Kit w/seals for .530" O.D. Guides	1	<b>68-9167</b>
<b>PUSHROD, TAPPET GASKETS AND VALVE STEM SEALS</b>			
11132	'99-17 Twin Cam MIDDLE Pushrod Cover O-ring	25	<b>68-9459</b>
11145	'99-17 Twin Cam LOWER Pushrod Cover O-rings	25	<b>68-9293</b>
11293	'99-17 Twin Cam UPPER Pushrod Cover O-ring	10	<b>68-9294</b>
18001-83	'99-17 Twin Cam Valve Stem Oil Seal (Viton)	25	<b>68-9836</b>
18046-98	'99-17 Twin Cam Valve Seals (Viton) for Screamin Eagle Heads or .530" O.D. guides	10	<b>68-9166</b>
18094-02	'03-17 Twin Cam Valve Stem Oil Seal (Viton) Hat Style	25	<b>68-9153</b>
18635-99	'99-17 Twin Cam Lifter Cover Gasket .032"	10	<b>68-9578F</b>
	'99-17 Twin Cam Pushrod Seal Kit	Kit	<b>68-9586</b>
<b>HEAD AND BASE GASKETS</b>			
11256	'99-17 Twin Cam Cylinder Base O-ring	10	<b>68-9628</b>
11273	'99-17 Twin Cam Cylinder Base Locating Dowel O-ring	10	<b>68-9438</b>
16500066	'14-17 Twin Cam 3.875" Bore .040" MLS Head Gasket for Twin Cooled 103" Engines	2	<b>68-10081-040</b>
16775-99	'99-11 3.750" Bore .030" Spring Steel Head Gasket (STD bore)	2	<b>68-9790</b>
	'14-17 Twin Cam 3.875" Bore .027" MLS Head Gasket for Twin Cooled 103" Engines	2	<b>68-10081</b>
	'14-17 Twin Cam 3.875" Bore .036" MLS Head Gasket for Twin Cooled 103" Engines	2	<b>68-10081-036</b>
	'14-17 Twin Cam 3.875" Bore .045" MLS Head Gasket for Twin Cooled 103" Engines	2	<b>68-10081-045</b>
	'14-17 Twin Cam 3.937" Bore .040" MLS Head Gasket for Twin Cooled 103" Engines	2	<b>68-10083-040</b>
	'14-17 Twin Cam 4.000" Bore .030" MLS Head Gasket for Twin Cooled 103" Engines	2	<b>68-10084-030</b>
	'14-17 Twin Cam 4.000" Bore .040" MLS Head Gasket for Twin Cooled 103" Engines	2	<b>68-10084-040</b>
	'14-17 Twin Cam 4.060" Bore .036" MLS Head Gasket for Twin Cooled 103" Engines	2	<b>68-10085-036</b>
	'14-17 Twin Cam 4.060" Bore .040" MLS Head Gasket for Twin Cooled 103" Engines	2	<b>68-10085-040</b>
	'14-17 Twin Cam 4.125" Bore .030" MLS Head Gasket for Twin Cooled 103" Engines	2	<b>68-10086-030</b>
	'99-17 Twin Cam 3.875" Bore .030" MLS Head Gasket 95" & 103" motors	2	<b>68-9721F</b>
	'99-17 Twin Cam 3.875" Bore .040" Spring Steel Head Gasket 95" & 103" motors	2	<b>68-9722</b>
	'99-17 Twin Cam 3.937" Bore .030" MLS Head Gasket	2	<b>68-9894</b>
	'99-17 Twin Cam 3.937" Bore .040" MLS Head Gasket	2	<b>68-9894-040</b>
	'99-17 Twin Cam 3.937" Bore .051" MLS Head Gasket	2	<b>68-9894-051</b>
	'99-17 Twin Cam 4.00" Bore .030" Spring Steel Head Gasket	2	<b>68-9725</b>
	'99-17 Twin Cam 4.00" Bore .040" Spring Steel Head Gasket	2	<b>68-9726</b>
	'99-17 Twin Cam 4.125" Bore .030" MLS Head Gasket	2	<b>68-9910</b>
	'99-17 Twin Cam 4.125" Bore .040" MLS Head Gasket	2	<b>68-9743F</b>
	'99-17 Twin Cam 4.250" Bore .030" MLS Head Gasket	2	<b>68-9076-030</b>
	'99-17 Twin Cam 4.250" Bore .040" MLS Head Gasket	2	<b>68-9076-040</b>
	'99-17 Twin Cam 4.060" Bore .030" MLS Head Gasket	2	<b>68-9070-030</b>
	'99-17 Twin Cam 4.060" Bore .040" MLS Head Gasket	2	<b>68-9070-040</b>
	'99-17 Twin Cam 4.060" Bore .010" rubber coated steel Base Gasket	2	<b>68-9110-010</b>
	'99-17 Twin Cam 4.060" Bore .020" rubber coated steel Base Gasket	2	<b>68-9110-020</b>
<b>MOTOR CASE O-RINGS AND SEALS</b>			
11289	'99-17 Twin Cam Crankshaft Position Sensor O-ring	25	<b>68-9667</b>
12068	'99-17 Twin Cam Motor Sprocket Shaft Oil Seal	5	<b>68-9632</b>
26432-76A	'99-17 Twin Cam Cylinder Head Locating Dowel O-ring	10	<b>68-9287</b>
27444-00Y	'06-17 Dyna, '07-17 Touring/Softail Twin Cam Models Starter to Primary Case O-ring	5	<b>68-9201</b>

Continued on the next page

WINDSHIELDS / FAIRINGS

AUDIO / COMMUNICATION

SEATS / LUGGAGE

BARS / MIRRORS / CONTROLS

EXHAUST

AIR / FUEL SYSTEMS

ENGINE

TRANSMISSION / DRIVELINE

GASKETS / SEALS

ELECTRICAL

LIGHTING

CABLES

BRAKES

OIL FILTERS

SUSPENSION

BODY

WHEELS

TIRES / TIRE ACC.

BIKE ACC.

VICTORY / INDIAN

COVERS / LOCKS / TIEDOWNS

CHEMICALS

TOOLS

HELMETS

HELMET ACC.

EYEWEAR

APPAREL / RIDER ACC.

PROMOTIONAL

REFERENCE

INDEX



**TWIN CAM GASKETS & SEALS**



- WINDSHIELDS / FAIRINGS
- AUDIO / COMMUNICATION
- SEATS / LUGGAGE
- BAR / MIRRORS / CONTROLS
- EXHAUST
- AIR / FUEL SYSTEMS
- ENGINE
- TRANSMISSION / DRIVELINE
- GASKETS / SEALS
- ELECTRICAL
- LIGHTING
- CABLES
- BRAKES
- OIL FILTERS
- SUSPENSION
- BODY
- WHEELS
- TIRES / TIRE ACC.
- BIKE ACC.
- VICTORY / INDIAN
- COVERS / LOCKS / TIEDOWNS
- CHEMICALS
- TOOLS
- HELMETS
- HELMET ACC.
- EYEWEAR
- APPAREL / RIDER ACC.
- PROMOTIONAL
- REFERENCE
- INDEX

OEM#	Application	Quantity	WPS#
<b>TWIN CAM GASKETS,SEALS, O-RINGS</b>			
<b>OIL AND OIL PUMP GASKETS</b>			
11140	'99-17 Twin Cam Piston Cooling Jet O-ring	10	68-9667
11286	'99-06 Oil Pump Cover O-ring	10	68-9437
11293	'99-17 Twin Cam Oil Pump Inner Med O-ring	10	68-9294
11293	'99-17 Oil Filter Mounting Bracket O-ring	10	68-9294
26072-99	'99-17 Twin Cam Dyna models Oil Pan Gasket	10	68-9646F
26077-99	'99-17 Twin Cam Touring models Oil Pan Gasket	10	68-9647F
26433-77 or 11301	'99-17 Twin Cam Oil Pump Check Valve O-ring	10	68-9449
<b>CAM HOUSING</b>			
11288	99-00 Cam Position Sensor O-ring	10	68-9627
11298	'99-06 Touring/Softail and '99-05 Dyna models Cam Support Plate Plug O-ring	10	68-9631
17045-99	'99-17 Twin Cams Cam Service Kit	Kit	68-9664
25244-99	'99-17 Twin Cams Cam Cover Gasket	1	68-9575F1
25244-99	'99-17 Twin Cams Cam Cover Gasket	5	68-9575F5
<b>INTAKE AND EXHAUST GASKETS</b>			
17591-99	'99-17 Twin Cam Breather Cover Gasket	10	68-9579
17592-99	'99-10 Breather Baffle Gasket	10	68-9580
26995-86B	'99-17 Twin Cam Intake Manifold to Head for Carb & EFI Models	10	68-9290
27002-89	'99-17 Twin Cam Carb to Intake Manifold Seal	1	68-9088
29645-08	'08-16 Touring Models , Filter element gasket	10	68-10007
63815-99	'99-10 Breather Filter Element	10	68-9679
65324-83A	'99-Up Exhaust Gasket "TAPERED"	10	68-9288
	'99-Up (including M8) Exhaust Gasket "Race Style" .240" thick	10	68-9247
	'99-Up Exhaust Gasket "EXTREME PERFORMANCE"	10	68-9540
	'99-Up Exhaust Gasket "RACE STYLE"	10	68-9719
	'99-Up 50mm Carb to Manifold Seal	1	68-9227
	S&S big bore manifold to head seal	4	68-9223
	'99-Up Intake Manifold Seal Kit for Carbureted Models	Kit	68-9131
<b>CARB AND EFI GASKETS</b>			
11291	'99-17 Twin Cam EFI MAP Sensor Seal EFI Only	10	68-9630
29062-95	'99-Up Twin Cam Carb to Backing Plate Gasket for Carbureted Models	10	68-9626F
29313-95	'99-17 Twin Cam Air Filter Mnt. Gasket	10	68-9634F
29368-99	'99-01 EFI Induction Module to Backing Plate Gasket	10	68-9641F
29463-99	'99-01 EFI Filter Element Gasket EFI Only	10	68-9643F
29645-08	'08-Up Touring Models Air Filter Element Gasket	10	68-10007
	'11-14 Twin Cam Breather Filter Element Gasket	10	68-10114
<b>INSPECTION &amp; DERBY COVER GASKETS</b>			
17369-06	'07-Up Touring/Softail and '06-Up Dyna, '17 M8 Models Derby Cover O-Ring	1	68-9152F1
17369-06	'07-Up Touring/Softail and '06-Up Dyna, '17 M8 Models Derby Cover O-Ring	5	68-9152F5
25416-16	'16-Up Touring (except CVO and Low) 5 Hole Derby Cover Gasket	1	68-10140F1
25416-16	'16-Up Touring (except CVO and Low) 5 Hole Derby Cover Gasket	5	68-10140F5
25416-99	'99-06 Touring/Softail and '99-05 Dyna Models Derby Cover O-ring	5	68-9662
25416-99C	'99-17 Twin Cam (except '16-up Touring) 5 Hole Derby Cover Gasket, Replaces O-Ring	1	68-9997F1
25416-99C	'99-17 Twin Cam (except '16-up Touring) 5 Hole Derby Cover Gasket, Replaces O-Ring	5	68-9997F5
34906-85A	'85-06 FXR, FLT Inspection Cover Gasket	1	68-9305F1
34906-85A	'85-06 FXR, FLT Inspection Cover Gasket	5	68-9305F5
60567-65B	'65-06 Softail 4&5 Speed, '89-05 Dyna Inspection Cover Gasket	1	68-9331F1
60567-65B	'65-06 Softail 4&5 Speed, '89-05 Dyna Inspection Cover Gasket	5	68-9331F5

Continued on the next page





## TWIN CAM GASKETS & SEALS

OEM#	Application	Quantity	WPS#
<b>TWIN CAM GASKETS, SEALS, O-RINGS</b>			
<b>PRIMARY HOUSING GASKETS</b>			
11147	'99-06 Touring/Softail and '99-05 Dyna Models Inner Primary to Case O-ring	10	<b>68-9441</b>
12052	'99-Up Twin Cam Wet Clutch Oil Seal	5	<b>68-9260</b>
12066	'99-06 Touring/Softail and '99-05 Dyna Models Starter Motor Shaft Oil Seal	5	<b>68-9261</b>
27444-00Y	'07-Up Touring, '06-Up Dyna, '17 M8 Models Starter Motor Shaft Oil Seal	5	<b>68-9201</b>
34901-07	'07-16 Touring Models Primary Gasket .032" AFM	1	<b>68-9179F1</b>
34901-07	'07-16 Touring Models Primary Gasket .032" AFM	5	<b>68-9179F5</b>
34901-94A	'94-06 FLT, FXR Big Twin Primary	1	<b>68-9307F1</b>
34901-94A	'94-06 FLT, FXR Big Twin Primary	5	<b>68-9307F5</b>
34934-06	'07-16 Touring, '07-17 Softail and '06-17 Dyna Models Inner Primary Spacer/Seal	1	<b>68-9199F1</b>
34934-06	'07-16 Touring, '07-17 Softail and '06-17 Dyna Models Inner Primary Spacer/Seal	5	<b>68-9199F5</b>
60539-89	'89-06 Softail, 89-05 Dyna Primary Gasket	1	<b>68-9309F1</b>
60539-89	'89-06 Softail, 89-05 Dyna Primary Gasket	5	<b>68-9309F5</b>
60547-06	'07-17 Softail and '06-17 Dyna Models Primary Gasket .060" AFM	1	<b>68-9145F1</b>
60547-06	'07-17 Softail and '06-17 Dyna Models Primary Gasket .060" AFM	5	<b>68-9145F5</b>
63859-95A	'95-06 Softail Primary Spacer Gasket (pair)	1 (pair)	<b>68-9942F1</b>
63859-95A	'95-06 Softail Primary Spacer Gasket (pair)	5 (pair)	<b>68-9942F5</b>
	'07-17 Softail and '06-17 Dyna Models Primary Gasket Kit	Kit	<b>68-9150</b>
	'07-16 Touring Models Primary Gasket Kit	Kit	<b>68-9173</b>
	'07-Up Twin Cam Models Inner Primary and Trans Push Pin	10	<b>68-10122</b>
<b>TRANSMISSION GASKETS</b>			
26072-99	'99-05 Dyna Models Transmission Gasket Kit	Kit	<b>68-9640</b>
26072-99	'99-06 Touring and '00-06 Softail Models Transmission Gasket Kit, Fiber	Kit	<b>68-9639</b>
26072-99	'99-06 Touring and '00-06 Softail Models Transmission Gasket Kit, AFM	Kit	<b>68-9639F</b>
34904-86XC	'99-06 Softail/Touring, '99-05 Dyn Models Transmission top Cover Gasket "wide version" .031" Fiber	10	<b>68-9267</b>
34917-06	'07-Up Twin Cam Models Transmission top Cover Gasket .060" AFM	10	<b>68-9189</b>
34917-99	'99-05 Dyna Transmission Top Cover Gasket .060" AFM	10	<b>68-9645F</b>
35607-06	'07-16 Touring and '06-17 Dyna Models Transmission to Engine Case Gasket	5	<b>68-9190F5</b>
35653-98	'99-06 Touring/Softail and '99-05 Dyna Models Transmission Bearing Housing Gasket .032" AFM	10	<b>68-9644F</b>
35654-06	'07-Up Twin Cam Models, '17 M8, Transmission Bearing Housing Gasket .032" AFM	10	<b>68-9187</b>
	'06-Up Dyna Models 6 Speed Transmission Gasket Kit	Kit	<b>68-9151</b>
	'07-Up Softail Models 6 Speed Transmission Kit	Kit	<b>68-9174</b>
	'07-Up Touring Models 6 Speed Transmission Gasket kit	Kit	<b>68-9175</b>
<b>MISCELLANEOUS GASKETS, SEALS, AND O-RINGS</b>			
11290	'99-Up Twin Cam models Neutral Indicator Switch O-Ring	10	<b>68-9642</b>
12074	'07-Up Touring/Softail, '06-Up Dyna and '17 M8 Models Mainshaft Oil Seal,	1	<b>68-9215</b>
12077	'07-Up Touring/Softail, '06-Up Dyna and '17 M8 Models Oil Seal output Gear End Seal	10	<b>68-9200</b>
17592-99	'99-10 Twin Cam models Breather Baffle Gasket	10	<b>68-9580</b>
36801-87B	'87-06 Touring/Softail and '87-05 Dyna Models Clutch Release Gasket .032" AFM	10	<b>68-9483</b>
36805-06	'07-Up Touring/Softail '06-Up Dyna and '17 M8 Models Clutch Release Cover Gasket .060" AFM	10	<b>68-9188</b>
62432-93	'93-06 Touring/Softail and '93-05 Dyna Models Oil Filler Spout Gasket .032" AFM	10	<b>68-9266F</b>

WINDSHIELDS / FAIRINGS

AUDIO / COMMUNICATION

SEATS / LUGGAGE

BARS / MIRRORS / CONTROLS

EXHAUST

AIR / FUEL SYSTEMS

ENGINE

TRANSMISSION / DRIVELINE

GASKETS / SEALS

ELECTRICAL

LIGHTING

CABLES

BRAKES

OIL FILTERS

SUSPENSION

BODY

WHEELS

TIRES / TIRE ACC.

BIKE ACC.

VICTORY / INDIAN

COVERS / LOCKS / TIEDOWNS

CHEMICALS

TOOLS

HELMETS

HELMET ACC.

EYEWEAR

APPAREL / RIDER ACC.

PROMOTIONAL

REFERENCE

INDEX



## EVO BIG TWIN GASKETS & SEALS

- At Cometic Gasket, our goal is to offer the latest in gasket technology
- Materials, manufacturing processes and gasket designs are constantly improving to match the higher level of performance for today's powerful V-Twin engines
- Cometic Gasket Kits for Harley Davidson models include every gasket, seal, washer, and o-ring needed for a complete overhaul
- When purchasing a Cometic gasket kit, you can rest assured that every component will be the best solution for your application
- EST "Extreme Sealing Technology" kits are available in Complete Motor Kits and Top End Kits
- **Harley-Davidson® EST Gasket Kits** contain MLS Head Gaskets, Steel Viton coated Base Gaskets, blue Viton Valve Stem Seals and AFM material

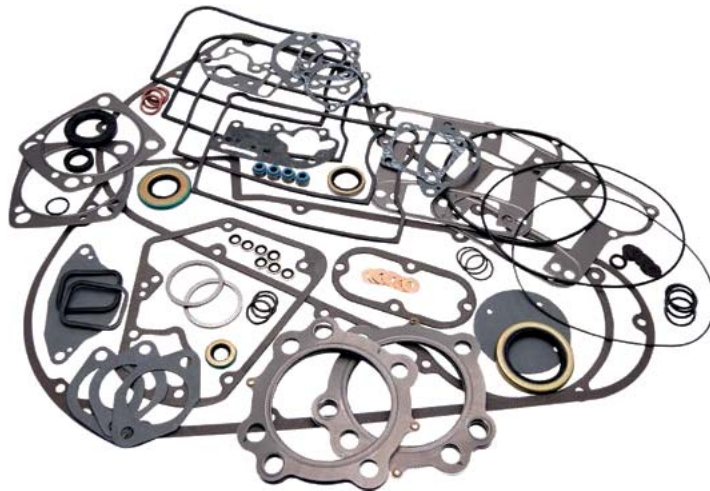

OEM#	Application	Quantity	WPS#
<b>1984-99 BIG TWIN EVO GASKETS, SEALS, O-RINGS</b>			
<b>EST GASKET KITS</b>			
17026-91A	'84-91 EVO big Twin 3 13/16" Big Bore Top End Gasket Kit, EST	Kit	<b>68-9769</b>
17026-91A	'84-91 EVO Big Twin 3 5/8" Big Bore Top End Gasket Kit, EST	Kit	<b>68-9767</b>
17026-91A	'92-99 EVO Big Twin 3 13/16" Big Bore Top End Gasket Kit, EST	Kit	<b>68-9768</b>
17026-91A	'92-99 EVO Big Twin 3 3/4" Big Bore Top end Gasket Kit, EST	Kit	<b>68-9770</b>
17026-91A	'92-99 EVO big Twin 3 5/8" Big Bore Top End Gasket Kit, EST	Kit	<b>68-9766</b>
17033-83-A	'84-91 EVO Big twin Top End Gasket Kit w/ .030" MLS Head Gaskets, EST	Kit	<b>68-9851</b>
17033-83-A	'84-91 EVO Big twin Top End Gasket Kit, EST	Kit	<b>68-9747</b>
17041-92-A	'92-99 Big Twin 3 13/16" Big Bore Complete Gasket Kit, EST	Kit	<b>68-9974</b>
17041-92-A	'92-99 EVO big Twin 3 5/8" Big Bore Complete Gasket Kit, EST	Kit	<b>68-99080E</b>
17041-92-A	'92-99 EVO Big Twin Complete Gasket Kit w/.030" MLS Gaskets	Kit	<b>68-9846F</b>
17041-92-A	'92-99 EVO Big Twin Complete Gasket Kit, EST	Kit	<b>68-9748F</b>
17042-92A	'84-91 EVO Big Twin Rocker Box Rebuild Kit, EST	Kit	<b>68-9753</b>
17042-92A	'92-99 EVO Big Twin Rocker Box Rebuild Gasket Kit, EST	Kit	<b>68-9752</b>
	'65-88 FXST, FX, FL 4 Speed Primary Gasket Kit, EST	Kit	<b>68-9887</b>
	'80-93 FLT, FLHT, FXR Primary Gasket Kit, EST	Kit	<b>68-9889</b>
	'84-88 EVO Big Twin 4 & 5 Speed Complete Gasket Kit w/ .030" MLS Head Gaskets, EST	Kit	<b>68-9847F</b>
	'84-88 EVO Big Twin 4 & 5 Speed Complete Gasket Kit, EST	Kit	<b>68-9749F</b>
	'84-91 EVO Big Twin 3 3/4" Big Bore Top End Gasket Kit, EST	Kit	<b>68-9771</b>
	'84-91 EVO Big Twin 3 5/8" Big Bore Complete Gasket Kit	Kit	<b>68-9164</b>
	'84-91 EVO Big Twin FLT, FXR 5 Speed Complete Gasket Kit w/ .030" MLS Head Gaskets, EST	Kit	<b>68-9848F</b>
	'84-91 EVO Big Twin FLT, FXR 5 Speed Complete Gasket Kit, EST	Kit	<b>68-9750F</b>
	'89-91 EVO Big Twin Softail & Dyna Complete Gasket Kit w/ .030" MLS Head Gaskets, EST	Kit	<b>68-9849F</b>
	'89-91 EVO Big Twin Softail & Dyna Complete Gasket Kit, EST	Kit	<b>68-9751F</b>
	'89-93 FXST, FXD Primary Gasket Kit, EST	Kit	<b>68-9886</b>
	'92-99 EVO Big Twin Top End Gasket Kit w/ .030" MLS Head Gaskets, EST	Kit	<b>68-9850</b>
	'92-99 EVO Big Twin Top End Gasket Kit, EST	Kit	<b>68-9635</b>
	'92-99 Top End Gasket Kit W/O rubber rocker gaskets	Kit	<b>68-9130</b>
	'92-Up 4.00" Bore Complete Motor Gasket Kit S&S Engines w/ S&S Rocker Box Gaskets, EST	Kit	<b>68-9940</b>
	'94-06 FLT, FLH, FXR Primary Gasket Kit, EST	Kit	<b>68-9888</b>
	'94-06 FXST, '94-05 FXD Primary Gasket Kit, EST	Kit	<b>68-9885</b>
	4.00" Bore S&S Big Twin, w/ OE Style Rocker Box Gaskets, EST	Kit	<b>68-9917S</b>
	4.00" Bore S&S Big Twin, w/ S&S Rocker Box Gaskets, EST	Kit	<b>68-9917</b>
<b>ROCKER BOX GASKETS</b>			
6114	'84-99 Rocker Box Washer copper	10	<b>68-9400</b>
16778-97X	'84-99 Lower Right Rocker Gasket .020" rubber coated steel	5	<b>68-9561</b>
16778-97X	'84-99 Right - All 883 thru 1340, .020"	5	<b>68-9561</b>
16779-84A	'84-99 Lower Left Rocker Gasket fiber	5	<b>68-9284</b>
16779-97X	'84-99 Lower Left Rocker Gasket .020" rubber coated steel	5	<b>68-9563</b>
16779-97X	'84-99 Left - All 883 thru 1340, 020"	5	<b>68-9563</b>
16800-84	'84-99 One Piece Rocker Base Gasket .020" Rubber Coated Steel (pair)		<b>68-9865</b>
17355-84A	'84-91 Lower Rocker Cover Gasket rubber	5	<b>68-9281</b>
17355-92	'92-99 Lower Rocker Cover Gasket rubber	5	<b>68-9282</b>
17356-84A	'84-91 Upper Rocker Cover Gasket rubber	5	<b>68-9277</b>

## EVO BIG TWIN GASKETS &amp; SEALS



OEM#	Application	Quantity	WPS#
<b>1984-99 BIG TWIN EVO GASKETS, SEALS, O-RINGS</b>			
<b>ROCKER BOX GASKETS (cont'd...)</b>			
17356-92	'92-99 Upper Rocker Cover Gasket rubber	5	<b>68-9278</b>
17358-84A	'84-99 Inner Rocker Cover Gasket rubber	10	<b>68-9283</b>
26856-89	'93-Up Umbrella Valve Seal	10	<b>68-9481</b>
63858-49	'84-99 Rocker Box Washer paper	10	<b>68-9286</b>
	'84-99 EVO Left Rocker .010" Rubber Coated Steel		<b>68-9558</b>
	'84-99 EVO Left Rocker .020" Rubber Coated Steel		<b>68-9559</b>
	'84-99 EVO Right Rocker .010" Rubber Coated Steel		<b>68-9556</b>
	'84-99 EVO Right Rocker .020" Rubber Coated Steel		<b>68-9557</b>
	'84-99 One piece Rocker Base all Evos .020" rubber coated steel	10	<b>68-9866</b>
	'84-99 Left - All 883 thru 1340, .010"	5	<b>68-9562</b>
	'84-99 Right - All 883 thru 1340, .010"	5	<b>68-9560</b>
	S&S Inner Rocker O-Ring Seal	8	<b>68-9225</b>
	S&S Outer Rocker Gasket w/ Breather Flapper	4	<b>68-9224</b>
<b>PUSHROD AND TAPPET GUIDE GASKETS</b>			
11132	'84-99 Middle Pushrod Tube O-ring	25	<b>68-9459</b>
11145	'84-99 Lower Pushrod Tube O-ring	25	<b>68-9293</b>
11157	'84-99 Upper Pushrod Tube O-ring	25	<b>68-9292</b>
11133-V2	'84-99 Evo Pushrod O-ring Set	Kit	<b>68-9586</b>
18001-83	'84-99 Valve Guide Seals "Viton"	25	<b>68-9836</b>
18633-48D	'84-99 Rear Tappet Block Gasket AFM	10	<b>68-9297F</b>
18634-48C	'84-99 Front Tappet Block Gasket AFM	10	<b>68-9298F</b>
<b>HEAD AND BASE GASKETS</b>			
16774-86	'84-99 Stock Sleeve Cylinder Base Gasket .020" Fiber	2	<b>68-9009</b>
16777-86S	'84-99 3 5/8" Base Gasket .020" Fiber	2	<b>68-9615</b>
16777-86S	'84-99 3 3/4" Base Gasket .020" Fiber	2	<b>68-9615</b>
17026-91A	'92-99 EVO Big Twin 3 13/16" Big Bore Top End Gasket Kit w/ .030" MLS Head Gaskets .020" Rubber Coated Steel	Kit	<b>68-9980</b>
26432-76A	'84-99 Cylinder Stud Insert O-ring	10	<b>68-9287</b>
93-1033	'84-99 3 5/8" Base Gasket .020" Fiber fits S&S cylinder only!	2	<b>68-10009</b>
	'84-99 3 13/16" Base Gasket .020" Fiber	2	<b>68-9617</b>
	'84-99 3 13/16" Head Gasket .043" Copper	2	<b>68-9082</b>
	'84-99 3 5/8" Base Gasket .020" Rubber Coated Metal	2	<b>68-9552</b>
	'84-99 4" Base Gasket w / S&S Cyl. .020" Fiber	2	<b>68-9621</b>
	'84-99 4" Head Gasket .043" copper w / Axtell Cyl.	2	<b>68-9609</b>
	'84-99 Stock Sleeve Cylinder Base Gasket	2	<b>68-9551</b>
	3 13/16" Big Bore EVOs .030" MLS Design	2	<b>68-9692</b>
	3 13/16" Big Bore EVOs .040" MLS Design	2	<b>68-9693</b>
	3 3/4" Big Bore EVOs .030" MLS Design	2	<b>68-9694</b>
	3 3/4" Big Bore EVOs .040" MLS Design	2	<b>68-9695</b>
	3 5/8" Big Bore EVOs .030" MLS Design	2	<b>68-9690</b>
	3 5/8" Big Bore EVOs .040" MLS Design	2	<b>68-9691</b>
	Stock Bore EVOs 3.500" through 3.570" .030" MLS Design	2	<b>68-9688</b>
	Stock Bore EVOs 3.500" through 3.570" .040" MLS Design	2	<b>68-9689</b>
<b>EVO CAM SERVICE KITS</b>			
25225-93	'93-98 Cam Cover Gasket .060" AFM	1	<b>68-9328F1</b>
25225-93	'93-98 Cam Cover Gasket .060" AFM	5	<b>68-9328F5</b>
32591-80	'84-99 Point Cover Gasket	10	<b>68-9306F</b>
83162-51DL	'84-99 Point Seal double lip	5	<b>68-9350</b>
	'70-92 All Big Twins	Kit	<b>68-9623F</b>
	'93-99 All Big Twins	Kit	<b>68-9624F</b>
	'70-92 big Twin Cam Cover Gasket .060" AFM	1	<b>68-9302F1</b>
	'70-92 big Twin Cam Cover Gasket .060" AFM	5	<b>68-9302F5</b>
<b>INTAKE AND EXHAUST</b>			
26995-86A	'90-99 Intake to Head Compliance Fitting Gasket	10	<b>68-9290</b>
27002-89	'89 to Present Carb to Manifold Sealing Ring	1	<b>68-9088</b>
27077-78	'78-89 big Twin Kiehin Monifold Gasket .031" Fiber	10	<b>68-9425</b>
29058-77	'76-89 Big Twin Keihin Air Cleaner Gasket .031" Fiber	10	<b>68-9300</b>
29242-83	'84-89 Intake to Head Compliance Fitting Gasket	10	<b>68-9299</b>
65324-83	'84-91 Exhaust Port Gasket RACE STYLE	10	<b>68-9719</b>
65324-83A	'92-99 Exhaust Port Gasket Taper Style	5	<b>68-9288</b>
65324-83X	Exhaust Gasket All Models '99-UP RACE STYLE .240" thick	10	<b>68-9247</b>



# EVO BIG TWIN GASKETS & SEALS

WINDSHIELDS / FAIRINGS  
AUDIO / COMMUNICATION  
SEATS / LUGGAGE  
BARS / MIRRORS / CONTROLS  
EXHAUST  
AIR / FUEL SYSTEMS  
ENGINE  
TRANSMISSION / DRIVELINE  
GASKETS / SEALS  
ELECTRICAL  
LIGHTING  
CABLES  
BRAKES  
OIL FILTERS  
SUSPENSION  
BODY  
WHEELS  
TIRES / TIRE ACC.  
BIKE ACC.  
VICTORY / INDIAN  
COVERS / LOCKS / TIEDOWNS  
CHEMICALS  
TOOLS  
HELMETS  
HELMET ACC.  
EYEWEAR  
APPAREL / RIDER ACC.  
PROMOTIONAL  
REFERENCE  
INDEX

OEM#	Application	Quantity	WPS#
<b>1984-99 BIG TWIN EVO GASKETS, SEALS, O-RINGS</b>			
<b>INTAKE AND EXHAUST (CONT'D...)</b>			
	EXTREME PERFORMANCE Exhaust Gasket	10	<b>68-9540</b>
	All EVO Intake Manifold Seal Kit, Head to Manifold and Carb Seal	Kit	<b>68-9131</b>
	S&S Big Bore Manifold to Head Seal	4	<b>68-9223</b>
<b>OIL PUMP GASKETS AND SEALS</b>			
11105	'84-99 Oil Pump Cap O-ring	10	<b>68-9435</b>
11241	'92-99 Oil Pump Cover O-ring	25	<b>68-9684</b>
26227-58	'84-99 Oil Pump Drive Gear Seal	5	<b>68-9349</b>
26273-80B	'84-91 Oil Pump Body Gasket paper	10	<b>68-9381</b>
26273-92	'92-99 Oil Pump Body Gasket paper	10	<b>68-9383</b>
26276-80A	'84-91 Oil Pump Cover Gasket paper	10	<b>68-9382</b>
26276-92	'92-99 Oil Pump Cover Gasket paper	10	<b>68-9384</b>
63528-92	'92-98 All HD Oil Line Ferrule	5	<b>68-10011</b>
	'92-99 Oil Pump Rebuild Kit	1	<b>68-9168</b>
<b>TRANSMISSION GASKETS, SEALS AND O-RINGS</b>			
26072-90	'90-98 Dyna Transmission Oil pan Gasket .032" AFM	10	<b>68-9490F</b>
26077-93	'93-98 FLT Transmission .060" AFM Oil Pan Gasket	5	<b>68-9265F</b>
33031-82	'80-E84 5 Speed Transmission Gasket Kit	Kit	<b>68-9466</b>
33031-85	L'84-92 Speed Transmission Gasket Kit (except Dyna)	Kit	<b>68-9467</b>
33031-91	'91-99 Dyna & FXDB-S Evolution Models Transmission Gasket Kit	Kit	<b>68-9468</b>
33031-93	'93-99 EVO Models Transmission Gasket Kit, AFM	Kit	<b>68-9469F</b>
33031-93	'93-99 EVO Models Transmission Gasket Kit, Fiber	Kit	<b>68-9469</b>
33295-36	'85-86 Transmission end Cover Gasket .032" AFM	10	<b>68-9515-032AFM</b>
34824-79	L'79-86 Transmission Top Cover Gasket .032" AFM	10	<b>68-9516-032AFM</b>
34904-79	'85-86 Transmission Top Cover Gasket .032" AFM	10	<b>68-9499F</b>
34904-79	'85-86 Transmission Top Cover Gasket .032" AFM	10	<b>68-9499F</b>
34904-86B	'87-99 Transmission Top Cover Gasket "Thin Version" .032" AFM	10	<b>68-9983F</b>
34917-90A	'90-98 Dyna Transmission Top Cover Gasket .032" AFM	10	<b>68-9488F</b>
35652-79A	'80-98 Transmission Bearing Housing Gasket .032" AFM,	10	<b>68-9264F</b>
36801-79	'80-86 Transmission End Cover Gasket .032" AFM	10	<b>68-9526F</b>
<b>PRIMARY GASKETS</b>			
34901-79A	'85-93 Big Twin Primary FLT/FXR	1	<b>68-9308F1</b>
34901-79A	'85-93 Big Twin Primary FLT/FXR	5	<b>68-9308F5</b>
34901-94A	'94-06 FLT, FXR Big Twin Primary	1	<b>68-9307F1</b>
34901-94A	'94-06 FLT, FXR Big Twin Primary	5	<b>68-9307F5</b>
60538-81C	'65-88 FXST, FX/FL 4 Speed Primary Gasket	1	<b>68-9607F1</b>
60538-81C	'65-88 FXST, FX/FL 4 Speed Primary Gasket	5	<b>68-9607F5</b>
60539-89	'89-06 Softtail, 89-05 Dyna Primary Gasket	1	<b>68-9309F1</b>
60539-89	'89-06 Softtail, 89-05 Dyna Primary Gasket	5	<b>68-9309F5</b>
63859-95A	'95-06 Softtail Primary Spacer Gasket (pair)		<b>68-9942F1</b>
<b>INSPECTION &amp; DERBY COVER GASKETS</b>			
25416-84	L'84-98 Derby Cover O-ring	10	<b>68-9442</b>
31433-84A	'84-98 Derby Cover Bolt Washer metal	5	<b>68-9363</b>
34906-79A	'80-84 FXR, FLT Inspection Cover Gasket	1	<b>68-9303F1</b>
34906-79A	'80-84 FXR, FLT Inspection Cover Gasket	5	<b>68-9303F5</b>
34906-85A	'85-06 FXR, FLT Inspection Cover Gasket	1	<b>68-9305F1</b>
34906-85A	'85-06 FXR, FLT Inspection Cover Gasket	5	<b>68-9305F5</b>
60567-65B	'65-06 Softtail 4&5 Speed, '89-05 Dyna Inspection Cover Gasket	1	<b>68-9331F1</b>
60567-65B	'65-06 Softtail 4&5 Speed, '89-05 Dyna Inspection Cover Gasket	5	<b>68-9331F5</b>
	'84-98 Derby Cover Gasket, Replaces O-Ring, 3 Hole	1	<b>68-9183F1</b>
	'84-98 Derby Cover Gasket, Replaces O-Ring, 3 Hole	5	<b>68-9183F5</b>
<b>INNER PRIMARY GASKETS, O-RINGS</b>			
11147	L'82-99 Inner Primary O-ring	10	<b>68-9441</b>
12052	L'84-99 Inner Primary Bearing Seal double lip	5	<b>68-9260</b>
<b>STARTER HOUSING GASKETS, O-RINGS</b>			
11116	'91-99 Starter Housing O-ring	25	<b>68-9433</b>
11171	'89-90 Starter Bolt O-ring	10	<b>68-9436</b>
12051	L'84-88 Starter Shaft Seal	5	<b>68-9491</b>
12053	'89-93 Starter Shaft Seal	5	<b>68-9379</b>
12066	'94-99 Starter Shaft Seal	5	<b>68-9261</b>
31320-80	'80-86 Starter Housing Gasket	10	<b>68-9507F</b>

**EVO BIG TWIN GASKETS & SEALS**



OEM#	Application	Quantity	WPS#
<b>1984-99 BIG TWIN EVO GASKETS, SEALS, O-RINGS</b>			
<b>STARTER HOUSING GASKETS, O-RINGS (CONT'D...)</b>			
31321-80	'80-86 Starter Cover Gasket	10	<b>68-9508F</b>
31341-80-DL	'80-86 Starter Shaft Seal	5	<b>68-9509</b>
60518-65	'65-88 Starter Hole Block Off Gasket	10	<b>68-9717F</b>
60559-80	'65-85 Starter Housing Gasket	10	<b>68-9330F</b>
<b>SEALS, O-RINGS AND WASHERS</b>			
6007	80-98 Drain Plug Washer	10	<b>68-9498</b>
11105	'90-99 Drain Plug O-ring	10	<b>68-9435</b>
11115	'65-86 Counter Shaft O-ring	10	<b>68-9529</b>
11117	L'84-99 FXR, DYNA Shifter Sleeve O-ring	25	<b>68-9484</b>
11132	'90-99 Dipstick Cover O-ring upper	25	<b>68-9459</b>
11140	'96-99 Speedometer Sensor O-ring	25	<b>68-9667</b>
11162	L'84-86 Mainshaft O-ring right end	25	<b>68-9495</b>
11165	L'84-99 Mainshaft Quad Seal	10	<b>68-9361</b>
11166	'84-86 Mainshaft Bearing O-ring	25	<b>68-9530</b>
11178	'87-98 Filler Plug O-ring	10	<b>68-9263</b>
11179	'87-99 Clutch Cable O-ring	25	<b>68-9447</b>
11191	'90-99 FXST, FLST Shift Lever O-ring	25	<b>68-9661</b>
12010	L'79-86 Shifter Shaft Seal	5	<b>68-9531</b>
12043	'80-86 Starter Shaft Seal	5	<b>68-9528</b>
12050	L'84-94 Main Shaft Seal	1	<b>68-9359</b>
12068	'99-Up Twin Cam, '04-Up Sportster Engine Main Shaft Seal	5	<b>68-9632</b>
12013A	L'81-86 Main Drive Gear Seal	5	<b>68-9493</b>
12026B	'70-98 Mainshaft Seal, Engine	5	<b>68-9351</b>
12035A	'91-99 Main Drive Gear Seal, Transmission	5	<b>68-9258</b>
12044DL	'80-E84 Main Drive Gear Seal	1	<b>68-9527</b>
12045DL	'80-06 Shifter Shaft Seal	5	<b>68-9259</b>
12052DL	L'84-99 Inner Primary Clutch Seal	5	<b>68-9260</b>
12067A	'95-99 Mainshaft Seal	1	<b>68-9262</b>
33043-80	'65-95 Neutral Indicator Washer	10	<b>68-9497</b>
33076-37	'37-86 Starter Crank Seal	10	<b>68-9374</b>
34036-80	'80-86 Shift Fork Shaft O-ring	10	<b>68-9510</b>
37091-80	'80-86 Filler Plug Washer	10	<b>68-9496</b>
37101-84	'84-86 Clutch Release Lever O-ring	1	<b>68-9354</b>
37741-82DL	'82-86 Main Drive Gear Seal Double Lip	5	<b>68-9514</b>
60641-74	'74-85 Shifter Shaft Seal	5	<b>68-9525</b>
62672-90	'91-98 Dipstick Cover O-ring	10	<b>68-9485</b>
62673-90	'91-98 Dipstick O-ring	10	<b>68-9460</b>
62702-52	'36-86 Drain Plug Washer	10	<b>68-9403</b>
11170	'95-99 Crankshaft Position Sensor O-ring	25	<b>68-9438</b>
12026B	'84-99 Sprocket Shaft Seal	5	<b>68-9351</b>
29059-88	'90-99 Big Twin Keihin CV Air Cleaner Gasket .039" Fiber	20	<b>68-9301</b>
33196-79	'85-86 Shifter Cover Gasket .032" AFM	10	<b>68-9517F</b>
36801-87B	'87-05 Dyna, '87-06 Big Twin models Clutch Release Gasket .032" AFM	10	<b>68-9483</b>
60518-65	'65-88 Starter Hole Block Off Gasket .032" AFM	10	<b>68-9717F</b>
62423-90	'91-98 Dyna Oil Filler Spout Gasket .032" AFM	10	<b>68-9489</b>
62432-93	'93-98 FLT Oil Filler Spout Gasket .032" AFM	10	<b>68-9266F</b>

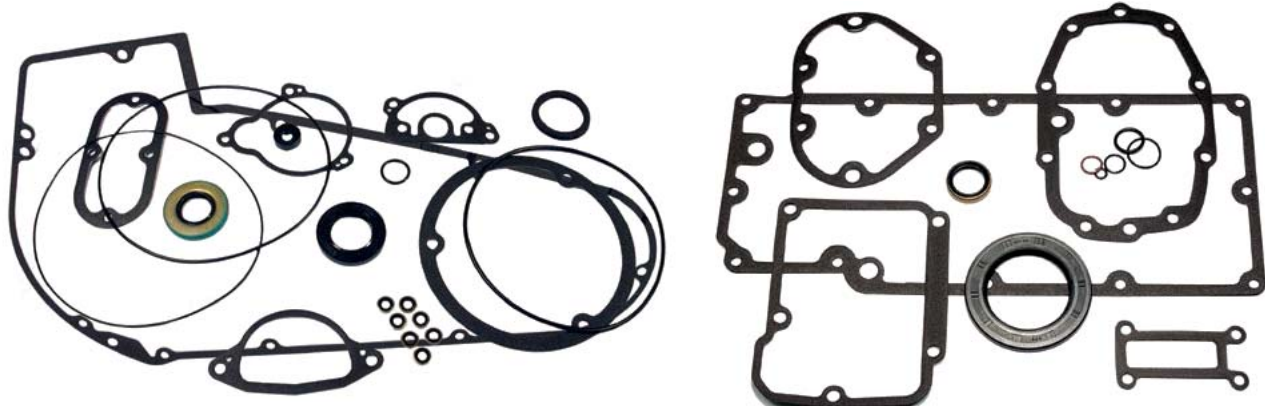

WINDSHIELDS / FAIRINGS  
 AUDIO / COMMUNICATION  
 SEATS / LUGGAGE  
 BARS / MIRRORS / CONTROLS  
 EXHAUST  
 AIR / FUEL SYSTEMS  
 ENGINE  
 TRANSMISSION / DRIVELINE  
**GASKETS / SEALS**  
 ELECTRICAL  
 LIGHTING  
 CABLES  
 BRAKES  
 OIL FILTERS  
 SUSPENSION  
 BODY  
 WHEELS  
 TIRES / TIRE ACC.  
 BIKE ACC.  
 VICTORY / INDIAN  
 COVERS / LOCKS / TIEDOWNS  
 CHEMICALS  
 TOOLS  
 HELMETS  
 HELMET ACC.  
 EYEWEAR  
 APPAREL / RIDER ACC.  
 PROMOTIONAL  
 REFERENCE  
 INDEX



# PANHEAD & SHOVELHEAD GASKETS & SEALS

- At Cometic Gasket, our goal is to offer the latest in gasket technology
- Materials, manufacturing processes and gasket designs are constantly improving to match the higher level of performance for today's powerful V-Twin engines
- Cometic Gasket Kits for Harley Davidson models include every gasket, seal, washer, and o-ring needed for a complete overhaul
- When purchasing a Cometic gasket kit, you can rest assured that every component will be the best solution for your application
- EST kits are available in Complete Motor Kits and Top End Kits
- **Harley-Davidson® EST Gasket Kits** contain MLS Head Gaskets, Steel Viton coated Base Gaskets, blue Viton Valve Stem Seals and AFM material



OEM#	Application	Quantity	WPS#
<b>1966-84 SHOVELHEAD GASKETS, SEALS</b>			
<b>EST GASKET KITS</b>			
17029-66X	'66-69 74" Shovelhead FL, FLH Complete Gasket Kit	Kit	<b>68-9900</b>
17029-70A	'70-84" Shovelhead 4 Speed 3 5/8" Complete Gasket Kit	Kit	<b>68-9154</b>
17029-70A	'70-84 Shovelhead 4 Speed 74" & 80" Complete Gasket Kit	Kit	<b>68-9964</b>
17029-80	'80-84 Shovelhead 5 Speed 80" FL, FLH Complete Gasket Kit	Kit	<b>68-9965</b>
17034-66X	'66-84 Shovelhead Top End Gasket Kit, .040" MLS H/G	Kit	<b>68-9967</b>
17034-66-X	'66-84 Shovelhead Models 3 5/8" Big Bore Top End Gasket Kit	Kit	<b>68-9918</b>
33031-70	E'70-79 Big Twin Transmission Gasket Kit	Kit	<b>68-9464F</b>
	'65-88 FXST, FX, FL 4 Speed Primary Gasket Kit	Kit	<b>68-9887</b>
	'66-84 Shovelhead Models 3 13/16" Big Bore Top End Gasket Kit	Kit	<b>68-9969</b>
<b>ROCKER HOUSING GASKETS AND O-RINGS</b>			
11101	'66-84 Rocker Shaft O-ring	25	<b>68-9451</b>
17540-69	'66-84 Rocker Cover Gasket .043" CFM20	2	<b>68-10008</b>
17540-69	'66-84 Rocker Cover Gasket .020" Viton Coated Emb. Steel	2	<b>68-9986</b>
17540-69	'66-84 Rocker Cover Gasket .031" Fiber	10	<b>68-9336</b>
18000-81	L'81-84 Valve Guide Seal Teflon	25	<b>68-9424</b>
18000-81	L'80-84 Shovelhead .625" O.D. Guides Viton Seal w/ garter	20	<b>68-9998</b>
18196-51	'51-78 Valve Guide Gasket	20	<b>68-9419</b>
<b>PUSH ROD O-RINGS AND TAPPET BLOCK GASKETS</b>			
11101	L'79-E81 Push Rod Cover O-ring Upper	10	<b>68-9451</b>
11118	L'81-84 Push Rod Cover O-ring Upper	25	<b>68-9711F</b>
11132	L'79-84 Push Rod Cover O-ring Middle	25	<b>68-9459</b>
11133	L'79-E81 Push Rod Cover O-ring Lower	5	<b>68-9460</b>
11133	L'79-E81 Push Rod Cover Quad Seal Lower	10	<b>68-9461</b>
11133-FL	L'79-E81 All Shovel Push Rod Tube Seal Set	Kit	<b>68-9584</b>
11133-FLH	L'81-84 All Shovel Push Rod Tube Seal Set	Kit	<b>68-9585</b>
17955-36	'36-E79 Push Rod Cover small cork	25	<b>68-9598</b>
17955-48	'48-E79 PushRod Cover Large cork	25	<b>68-9606</b>
18633-48D	'48-84 Rear Tappet Block Gasket .020" Fiber	10	<b>68-9297</b>
18634-48C	'48-84 Front Tappet Block Gasket .020" Fiber	10	<b>68-9298</b>
	'66-78 All Shovel Push Rod Tube Seal Set	Kit	<b>68-9216</b>
<b>HEAD AND BASE GASKETS</b>			
16770-66X	'66-84 Shovelheadhead MLS Stock Bore Head Gasket 74 & 80 .040	2	<b>68-9984</b>
16776-48	'66-84 Front Cylinder Standard Bore Fiber Base Gasket .031"	10	<b>68-9567</b>
16776-48	'66-84 Shovelhead Front Cyl. Std. Bore base Gasket; .031" Fiber	10	<b>68-9893</b>
16777-48	'66-84 Shovelhead Rear Cyl. Std. Bore base Gasket; .031" Fiber	10	<b>68-9568</b>
	'66-84 Shovelhead 3 13/16" Base Gasket: .020" RC Metal	2	<b>68-9893</b>
	'66-84 Shovelhead 3 5/8" Base Gasket: .031" Fiber	2	<b>68-9618</b>
	'66-84 Shovelhead 3 5/8" Copper Head Gasket: .032"	2	<b>68-9713</b>
	'66-84 Shovelhead MLS 3 5/8 BB Head Gasket .040"	2	<b>68-9985</b>
	'66-84 Shovelhead Stock Bore Head Gasket; .032" Copper	2	<b>68-9714</b>
	Shovelhead Only Base Gasket Std bore .020" Viton FR & RR Pair	2	<b>68-9206</b>
	3 5/8" Shovelhead Only Base Gasket Std bore .020" Viton 2 Fronts	2	<b>68-9207</b>
<b>OIL PUMP AND RELATED GASKETS / SEALS</b>			
11105/11102/11273	L'70-84 Oil Screen Pump Plug O-ring	10	<b>68-9435</b>
12026A	'70-84 Motor Main Shaft Seal	5	<b>68-9351</b>
26227-58	'68-84 Oil Pump Seal	5	<b>68-9349</b>
26231-78	'54-80 Oil Pump Relief Plug Gasket	10	<b>68-9715</b>
26244-37	'37-59 Oil Pump Body Gasket	10	<b>68-9397</b>
26245-41	'41-67 Oil Pump Gasket Fiber	10	<b>68-9393</b>
26246-68D	'68-E80 Oil Pump Body Fiber	10	<b>68-9391</b>
26257-50A	L'50-67 Oil Pump Cover Fiber	10	<b>68-9394</b>
26258-68D	'68-E80 Oil Pump Cover Gasket Fiber	10	<b>68-9392</b>
26276-80A	L'80-84 Oil Pump Cover Gasket Fiber	10	<b>68-9382</b>
30143-30	'36-57 Gen. Gasket	10	<b>68-9322</b>
30143-58	'58-69 Gen. Gasket	5	<b>68-9321F</b>
62702-52	'66-E70 Oil Screen Plug Gasket	10	<b>68-9403</b>
63529-57	'63-84 Oil Line Sleeve Seal	10	<b>68-9365</b>

## PANHEAD &amp; SHOVELHEAD GASKETS &amp; SEALS



OEM#	Application	Quantity	WPS#
<b>1966-84 SHOVELHEAD GASKETS, SEALS</b>			
<b>CAM / GEAR HOUSING GASKETS AND SEALS</b>			
25225-36C	'66-69 FL, FLH Cam Cover Gasket .06" AFM	1	<b>68-9334F1</b>
25225-36C	'66-69 FL, FLH Cam Cover Gasket .06" AFM	5	<b>68-9334F5</b>
32591-70	'70-79 FL, FLH, FX Points Cover Gasket	10	<b>68-9323</b>
32591-80	'80-84 Points Cover Gasket	10	<b>68-9306</b>
34036-36	'36-E79 Cam Shaft Seal rubber	10	<b>68-9519</b>
34036-36	'36-E79 Cam Shaft Seal rubber	10	<b>68-9519</b>
83162-51DL	'70-84 Cam Cover Seal / Double Lip	5	<b>68-9350</b>
	70-92 All Big Twins Cam Service Kit	Kit	<b>68-9623F</b>
	'70-92 Big Twin Cam Cover Gasket .060" AFM	1	<b>68-9302F1</b>
	'70-92 Big Twin Cam Cover Gasket .060" AFM	5	<b>68-9302F5</b>
<b>INTAKE AND EXHAUST GASKETS</b>			
27023-71	'71-75 Bendix Manifold Gasket .020" Fiber	10	<b>68-9417</b>
27060-55	'55-E78 Manifold to Head O-ring	10	<b>68-9453</b>
27062-78	L'78-84 Intake Seal Manifold to Head Rubber Band	10	<b>68-9608</b>
27077-78	'78-89 big Twin Kiehin Manifold Gasket .031" Fiber	10	<b>68-9425</b>
29058-77	'76-89 Big Twin Keihin Air Cleaner Gasket .031" Fiber	10	<b>68-9300</b>
65834-68X	'66-84 Shovel head models Exhaust Gasket with Fire Ring	10	<b>68-9587</b>
<b>PRIMARY GASKETS</b>			
60538-81C	'65-88 FXST, FX/FL 4 Speed Primary Gasket	1	<b>68-9607F1</b>
60538-81C	'65-88 FXST, FX/FL 4 Speed Primary Gasket	5	<b>68-9607F5</b>
34901-79A	'80-93 Big Twin Primary FLT/FXR	1	<b>68-9308F1</b>
34901-79A	'80-93 Big Twin Primary FLT/FXR	5	<b>68-9308F5</b>
<b>INNER PRIMARY GASKETS, O-RINGS</b>			
11125	Gaskets are '70-E82 Inner Primary O-ring	10	<b>68-9536</b>
12018	priced each '70-E84 Inner Primary Bearing Seal	5	<b>68-9518</b>
60629-55	'55-64 Chain Housing to Motor Gasket	10	<b>68-9343</b>
<b>TRANSMISSION GASKETS</b>			
33031-70	E'70-79 Big Twin Transmission Gasket Kit	Kit	<b>68-9464</b>
33031-80	L'79-82 4 Speed Transmission Gasket Kit	Kit	<b>68-9465</b>
33031-82	'80-E84 5 Speed Transmission Gasket Kit	Kit	<b>68-9466</b>
33295-36	'36-84 Transmission End Cover Gasket .032" AFM	10	<b>68-9515-032AFM</b>
34824-36	'36-E79 Transmission Top Cover Gasket .060" AFM	10	<b>68-9522F</b>
34824-79	L'79-86 Transmission Top Cover Gasket .032" AFM	10	<b>68-9516-032AFM</b>
34904-79	'80-84 Transmission Top Cover Gasket .032" AFM	10	<b>68-9499F</b>
<b>INSPECTION &amp; DERBY COVER GASKETS</b>			
25416-70	'70-83 FL, FXR Derby Cover Gasket	1	<b>68-9338F1</b>
25416-70	'70-83 FL, FXR Derby Cover Gasket	5	<b>68-9338F5</b>
60567-65B	'65-06 Big Twin 4&5 Speed, '89-05 Dyna Inspection Cover Gasket	1	<b>68-9331F1</b>
60567-65B	'65-06 Big Twin 4&5 Speed, '89-05 Dyna Inspection Cover Gasket	5	<b>68-9331F5</b>
60567-36	'36-64 FL Inspection Cover Gasket .060" AFM	1	<b>68-9326F1</b>
60567-36	'36-64 FL Inspection Cover Gasket .060" AFM	5	<b>68-9326F5</b>
<b>MISCELLANEOUS GASKETS, SEALS, AND O-RINGS</b>			
11101	L'66-82 Starter Oil Deflector O-ring	10	<b>68-9451</b>
11107	'67-70 Big Twin Tillotson O-Ring	10	<b>68-9452</b>
11115	'65-86 Counter Shaft O-ring	10	<b>68-9529</b>
11148	'82-E84 Shifter Shaft Quad Seal	10	<b>68-9357</b>
12010	L'79-86 Shifter Shaft Seal	5	<b>68-9531</b>
12014	'65-E84 Clutch Hub Nut Seal	5	<b>68-9494</b>
12018	'71-E84 Inner Primary Clutch Seal	5	<b>68-9518</b>
12022	L'66-E81 Main Drive Gear Seal	5	<b>68-9506</b>
12026B	'70-98 Mainshaft Seal, Engine	5	<b>68-9351</b>
31320-80	'80-86 Starter Housing Gasket	10	<b>68-9507F</b>
31321-80	'80-86 Starter Cover Gasket	10	<b>68-9508F</b>
31341-80-DL	'80-86 Starter Shaft Seal	5	<b>68-9509</b>
33043-80	'65-95 Neutral Indicator Washer	10	<b>68-9497</b>
33076-37	'37-86 Starter Crank Seal	10	<b>68-9374</b>
33196-79	L'79-84 Shifter Cover Gasket .032" AFM	10	<b>68-9517F</b>
34036-80	'80-86 Shift Fork Shaft O-ring	10	<b>68-9510</b>
34552-52	'52-E79 Ratchet Cover Gasket	10	<b>68-9520F</b>
34565-52	'52-E79 Shifter Adaptor Plate Gasket .032" AFM	10	<b>68-9521F</b>
35230-39DL	'36-79 Mainshaft Seal	5	<b>68-9523</b>
35231-36	'36-E77 Mainshaft Oil Seal cork washer	10	<b>68-9411</b>
37091-80	'80-86 Filler Plug Washer	10	<b>68-9496</b>
37741-67A	L'79-81 Mainshaft Seal Double Lip	5	<b>68-9513</b>
60518-65	'65-88 Starter Hole Block Off Gasket .032" AFM	10	<b>68-9717F</b>
60518-65	'65-88 Starter Hole Block Off Gasket	10	<b>68-9717F</b>
60559-80	'65-85 Starter Housing Gasket	10	<b>68-9330F</b>
60641-74	'74-85 Shifter Shaft Seal	5	<b>68-9525</b>
60645-65	'65-84 Solenoid Mount Gasket	10	<b>68-9702</b>
62702-52	'36-86 Drain Plug Washer	10	<b>68-9403</b>
67141-36	'36-83 Speedometer Drive Gasket .032" AFM	10	<b>68-9512F</b>

WINDSHIELDS / FAIRINGS

AUDIO / COMMUNICATION

SEATS / LUGGAGE

BARS / MIRRORS / CONTROLS

EXHAUST

AIR / FUEL SYSTEMS

ENGINE

TRANSMISSION / DRIVELINE

GASKETS / SEALS

ELECTRICAL

LIGHTING

CABLES

BRAKES

OIL FILTERS

SUSPENSION

BODY

WHEELS

TIRES / TIRE ACC.

BIKE ACC.

VICTORY / INDIAN

COVERS / LOCKS / TIEDOWNS

CHEMICALS

TOOLS

HELMETS

HELMET ACC.

EYEWEAR

APPAREL / RIDER ACC.

PROMOTIONAL

REFERENCE

INDEX



## PANHEAD GASKETS AND SEALS

- At Cometic Gasket, our goal is to offer the latest in gasket technology
- Materials, manufacturing processes and gasket designs are constantly improving to match the higher level of performance for today's powerful V-Twin engines
- Cometic Gasket Kits for Harley Davidson models include every gasket, seal, washer, and o-ring needed for a complete overhaul

- When purchasing a Cometic gasket kit, you can rest assured that every component will be the best solution for your application
- EST "Extreme Sealing Technology" kits are available in Complete Motor Kits and Top End Kits
- **Harley-Davidson® EST Gasket Kits** contain MLS Head Gaskets, Steel Viton coated Base Gaskets, blue Viton Valve Stem Seals and AFM material

OEM#	Application	Quantity	WPS#
<b>1936-65 PANHEAD GASKETS, SEALS</b>			
<b>EST GASKET KITS</b>			
17028-48	'48-65 Panhead FL, FLH Complete Gasket Kit, EST	Kit	<b>68-9966</b>
17034-48	'48-65 Panhead FL, FLH Top End Gasket Kit, EST	Kit	<b>68-9968</b>
<b>ROCKER HOUSING GASKETS AND O-RINGS</b>			
17507-48	'48-65 Rocker Cover Felt Pad	10	<b>68-9346</b>
17541-48A	'48-65 Rocker Cover Gasket .031" Fiber	10	<b>68-9342</b>
18196-51	'51-78 Valve Guide Gasket	20	<b>68-9419</b>
<b>PUSH ROD O-RINGS AND TAPPET BLOCK GASKETS</b>			
17955-36	'36-E79 Push Rod Cover small cork	25	<b>68-9598</b>
17955-48	'48-E79 PushRod Cover Large cork	25	<b>68-9606</b>
18633-48D	'48-84 Rear Tappet Block Gasket .020" Fiber	10	<b>68-9297</b>
18634-48C	'48-84 Front Tappet Block Gasket .020" Fiber	10	<b>68-9298</b>
<b>HEAD AND BASE GASKETS</b>			
16770-48MLS	'48-65 Panhead .040" MLS Head Gasket Pair	2	<b>68-9137</b>
16776-48	'48-84 Front Cylinder Standard Bore Fiber Base Gasket .031"	10	<b>68-9567</b>
16776-48	'48-84 Pan/Shovel Front Cyl. Std. Bore base Gasket; .031" Fiber	10	<b>68-9893</b>
16777-48	'48-84 Pan/Shovel Rear Cyl. Std. Bore base Gasket; .031" Fiber	10	<b>68-9568</b>
	'48-65 Panhead Base 3 5/8" 2 Fronts for S&S Cylinders Viton	2	<b>68-9989</b>
	'48-65 Panhead Base 3 5/8" Front & Rear .020" Viton	2	<b>68-9988</b>
	'48-65 Panhead Base Front & Rear .020" Viton	2	<b>68-9987</b>
<b>OIL PUMP AND RELATED GASKETS / SEALS</b>			
26231-78	'54-80 Oil Pump Relief Plug Gasket	10	<b>68-9715</b>
26244-37	'37-59 Oil Pump Body Gasket	10	<b>68-9397</b>
26245-41	'41-67 Oil Pump Gasket Fiber	10	<b>68-9393</b>
26257-50A	L'50-67 Oil Pump Cover Fiber	10	<b>68-9394</b>
30143-30	'36-57 Gen. Gasket	10	<b>68-9322</b>
<b>CAM / GEAR HOUSING GASKETS AND SEALS</b>			
25225-36C	'41-69 Cam Cover Gasket .06" AFM	1	<b>68-9334F1</b>
25225-36C	'41-69 Cam Cover Gasket .06" AFM	5	<b>68-9334F5</b>
32521-36	'36-64 Timer Base Gasket	10	<b>68-9337</b>
34036-36	'36-E79 Cam Shaft Seal rubber	10	<b>68-9519</b>
34036-36	'36-E79 Cam Shaft Seal rubber	10	<b>68-9519</b>
<b>INTAKE AND EXHAUST GASKETS</b>			
27060-55	'55-E78 Manifold to Head O-ring	10	<b>68-9453</b>
<b>TRANSMISSION GASKETS</b>			
33295-36	'36-84 Transmission End Cover Gasket .032" AFM	10	<b>68-9515-032AFM</b>
34824-36	'36-E79 Transmission Top Cover Gasket .060" AFM	10	<b>68-9522F</b>
<b>MISCELLANEOUS GASKETS, SEALS, AND O-RINGS</b>			
33076-37	'37-86 Starter Crank Seal	10	<b>68-9374</b>
34552-52	'52-E79 Ratchet Cover Gasket	10	<b>68-9520F</b>
34552-52	'52-E79 Ratchet Cover Gasket	10	<b>68-9520F</b>
34565-52	'52-E79 Shifter Adaptor Plate Gasket .032" AFM	10	<b>68-9521F</b>
34565-52	'52-E79 Shifter Adaptor Plate Gasket .032" AFM	10	<b>68-9521F</b>
35230-39DL	'36-79 Mainshaft Seal	5	<b>68-9523</b>
35230-39DL	'36-79 Mainshaft Seal	5	<b>68-9523</b>
35231-36	'36-E77 Mainshaft Oil Seal cork washer	10	<b>68-9411</b>
35231-36	'36-E77 Mainshaft Oil Seal cork washer	10	<b>68-9411</b>
60567-36	'36-64 FL Inspection Cover Gasket .060" AFM	1	<b>68-9326F1</b>
60567-36	'36-64 FL Inspection Cover Gasket .060" AFM	5	<b>68-9326F5</b>
60567-36	'36-64 FL Inspection Cover Gasket .060" AFM	1	<b>68-9326F1</b>
60567-36	'36-64 FL Inspection Cover Gasket .060" AFM	5	<b>68-9326F5</b>
60629-55	'55-64 Chain Housing to Motor Gasket	10	<b>68-9343</b>
67141-36	'36-83 Speedometer Drive Gasket .032" AFM	10	<b>68-9512F</b>



# EVO SPORTSTER GASKETS & SEALS



- At Cometic Gasket, our goal is to offer the latest in gasket technology
- Materials, manufacturing processes and gasket designs are constantly improving to match the higher level of performance for today's powerful V-Twin engines
- Cometic Gasket Kits for Harley Davidson models include every gasket, seal, washer, and o-ring needed for a complete overhaul
- When purchasing a Cometic gasket kit, you can rest assured that every component will be the best solution for your application
- EST "Extreme Sealing Technology" kits are available in Complete Motor Kits and Top End Kits
- **Harley-Davidson® EST Gasket Kits** contain MLS Head Gaskets, Steel Viton coated Base Gaskets, blue Viton Valve Stem Seals and AFM material

OEM#	Application	Quantity	WPS#
<b>EVO SPORTSTER GASKETS, SEALS, O-RINGS</b>			
<b>EST GASKET KITS</b>			
17026-86A	'88-90 Sportster 1200 Complete Gasket Kit, EST	Kit	<b>68-9757F</b>
17026-91A	'86-90 Sportster 883/1100/1200 Rocker Box Rebuild Kit, EST	Kit	<b>68-9764</b>
17032-86A	'88-90 Sportster 883/1200 Top End Gasket Kit w/ .030" MLS Head Gaskets, EST	Kit	<b>68-9907</b>
17032-86B	'91-03 EVO Sportster 883/1200 Top End Gasket Kit w/ .030" MLS Head Gaskets, EST	Kit	<b>68-9854F</b>
17026-91B	'91-03 Sportster 1200 3 13/16" Bore Complete EST Gasket Kit w/ .030" MLS Head Gasket	Kit	<b>68-9124</b>
17026-91B	'91-03 Sportster 883/1200 Complete Gasket Kit w/ .030" MLS Head Gaskets, EST	Kit	<b>68-9855F</b>
17026-91B	'91-03 Sportster 883/1200 Complete Gasket Kit, EST	Kit	<b>68-9758F</b>
17036-91	'91-03 Sportster 883/1200 Rocker Box Rebuild Kit, EST	Kit	<b>68-9765</b>
17032-86A	'86-87 Sportster 1100 Top End Gasket Kit, EST	Kit	<b>68-97610E</b>
17032-86A	'86-90 Sportster 883 Top End Gasket Kit, EST	Kit	<b>68-9759</b>
17032-91	'88-90 Sportster 1200 Top End Gasket Kit, EST	Kit	<b>68-97620E</b>
17032-91	'91-03 Sportster 1200 3 13/16" Bore Complete EST Gasket Kit w/ .040" MLS Head Gasket	Kit	<b>68-9133</b>
17032-91	'91-03 Sportster 1200 Top End Gasket Kit, EST	Kit	<b>68-9763</b>
17032-91	'91-03 Sportster 883 Top End Gasket Kit, EST	Kit	<b>68-9760</b>
17027-04	'04-06 Sportster 1200 Complete EST Gasket Kit	Kit	<b>68-9952</b>
17027-04	'04-06 Sportster 1200 Complete EST Gasket Kit w/ .030" MLS Head Gaskets	Kit	<b>68-9953</b>
17026-86A	'86-87 Sportster 1100 Complete Gasket Kit, EST	Kit	<b>68-9756F</b>
17026-86A	'86-90 Sportster 883 Complete Gasket Kit, EST	Kit	<b>68-9754F</b>
17026-91B	'91-03 Sportster 883 Complete Gasket Kit, EST	Kit	<b>68-9755F</b>
17049-04A	'04-06 Sportster 1200 3 13/16" Bore Top End EST Gasket Kit	Kit	<b>68-9219</b>
17027-04B	'04-06 Sportster 883 Complete EST Gasket Kit	Kit	<b>68-9193</b>
17049-04A	'04-06 Sportster 883 Top End EST Gasket Kit	Kit	<b>68-9194</b>
17027-04B	'07-Up Sportster 1200 Complete EST Gasket Kit	Kit	<b>68-9176</b>
17049-04A	'07-Up Sportster 1200 Top End EST Gasket Kit	Kit	<b>68-9177</b>
17027-04B	'07-Up Sportster 883 Complete EST Gasket Kit	Kit	<b>68-9191</b>
17049-04A	'07-Up Sportster 883 Top End EST Gasket Kit	Kit	<b>68-9192</b>
17036-91A	'07-Up Sportster 883/1200 Rocker Box Rebuild Gasket Kit	Kit	<b>68-9195</b>
	'86-87 Sportster 1100 3 3/4" bore Top end Gasket Kit, EST	Kit	<b>68-9774</b>
	'86-90 Sportster 883 3 3/4" Big Bore Top End Gasket Kit, EST	Kit	<b>68-9772</b>
	'88-90 Sportster 1200 3 3/4" Bore Top End Gasket Kit, EST	Kit	<b>68-9775</b>
	'91-03 Sportster 1200 3 13/16" Bore Top End EST Gasket Kit w/ .030" MLS Head Gasket	Kit	<b>68-9141</b>
	'91-03 Sportster 1200 3 13/16" Bore Top End EST Gasket Kit w/ .040" MLS Head Gasket	Kit	<b>68-9138</b>
	'91-03 Sportster 1200 3 3/4" Top End Gasket Kit, EST	Kit	<b>68-9776</b>
	'91-03 Sportster 883 3 3/4 Big Bore top End Gasket Kit, EST	Kit	<b>68-9773</b>
<b>ROCKER COVER GASKETS</b>			
16778-84A	'86-04 Lower Rckr Cover to Head / Right Gasket	5	<b>68-9285</b>
16778-97X	'86-04 Lower Rckr Cover to Head / Right, .020" Rubber Coated Steel	5	<b>68-9561</b>
16779-84B	'86-04 Lower Rckr Cover to Head / Left Gasket	5	<b>68-9284</b>
16779-97X	'86-04 Lower Rckr Cover to Head / Left, .020" Rubber Coated Steel	5	<b>68-9563</b>
16800-84B	'84-17 One Piece Rocker Base Gasket .020" Rubber Coated Steel (pair)		<b>68-9865</b>
17353-86	'86 Lower Rocker Cover cork	5	<b>68-9279</b>
17353-86A	'87-90 Lower Rocker Cover Gasket rubber	5	<b>68-9014</b>
17353-89	'91-03 Lower Rocker Cover Gasket rubber	5	<b>68-9280</b>
17353-89B	'04-06 Outer Rocker Gasket all Sportster Models	2	<b>68-9208</b>
17354-86	'86 Upper Rocker Cover cork	5	<b>68-9275</b>
17354-86A	'87-90 Upper Rocker Cover Gasket rubber	5	<b>68-9010</b>

- WINDSHIELDS / FAIRINGS
- AUDIO / COMMUNICATION
- SEATS / LUGGAGE
- BARS / MIRRORS / CONTROLS
- EXHAUST
- AIR / FUEL SYSTEMS
- ENGINE
- TRANSMISSION / DRIVELINE
- GASKETS / SEALS**
- ELECTRICAL
- LIGHTING
- CABLES
- BRAKES
- OIL FILTERS
- SUSPENSION
- BODY
- WHEELS
- TIRES / TIRE ACC.
- BIKE ACC.
- VICTORY / INDIAN
- COVERS / LOCKS / TIEDOWNS
- CHEMICALS
- TOOLS
- HELMETS
- HELMET ACC.
- EYEWEAR
- APPAREL / RIDER ACC.
- PROMOTIONAL
- REFERENCE
- INDEX



# EVO SPORTSTER GASKETS & SEALS

OEM#	Application	Quantity	WPS#
<b>EVO SPORTSTER GASKETS, SEALS, O-RINGS</b>			
<b>ROCKER COVER GASKETS (CONT'D...)</b>			
17354-89	'91-03 Upper Rocker Cover Gasket rubber	5	68-9276
17358-84	'86-04 Center Rocker Cover Cork	5	68-9707F
17358-84A	'86-06 Center Rocker Cover Gasket rubber	10	68-9283
17362-07	'07 XL Outer Rocker Gasket all Sportster Models	2	68-9196
17393-07	'07 XL Rocker Breather Seal	2	68-9198
17695-07	'07 XL Inner Rocker Gasket all Sportster Models	2	68-9197
26856-89	'91-03 Umbrella Valve Seal	10	68-9481
6114	Rocker Cover Washer copper	10	68-9400
63858-49	'87-05 Rocker Cover Washer Gasket	10	68-9286
	'84-99 Sportster Left Rocker .010" Rubber Coated Steel		68-9558
	'84-99 Sportster Left Rocker .020" Rubber Coated Steel		68-9559
	'84-99 Sportster Right Rocker .010" Rubber Coated Steel	1	68-9556
	'84-99 Sportster Right Rocker .020" Rubber Coated Steel	1	68-9557
	'04-06 Sportster 883/1200 Rocker box Rebuild Gasket Kit	Kit	68-9954
	S&S Inner Rocker O-Ring Seal	8	68-9225
	S&S Outer Rocker Gasket w/ Breather Flapper	4	68-9224
	S&S Rocker Cover Bolt Washer Seal	24	68-9226
<b>HEAD AND BASE GASKETS</b>			
16664-86B	Stock Bore 883 EVOs Head Gasket .040" MLS Design	2	68-9205
16771-08	XR1200 STD Bore MLS head gasket .040"	2	68-10003
16771-08XX	XR1200 3.812" Bore MLS head gasket .040"	2	68-10004
16774-86D	'86-05 Cylinder Base Gasket, .020" Fiber	2	68-9008
16774-86E	'06-Up Cylinder Base Gasket, All Buell & Sportster .020" Embossed Rubber Coated Steel	2	68-9214
16774-86D	'86-05 Cylinder Base Gasket, .020" Rubber Coated Steel	2	68-9553
17049-04	'04-06 Sportster 1200 Top End Gasket Kit	Kit	68-9970
17049-04	'04-06 Sportster 1200 Top End Gasket Kit w/ .030" MLS Head Gaskets	Kit	68-9971
18001-83B	'86-99 Valve Guide Seal "Viton"	25	68-9836
18094-02	'02-Up Valve Stem Oil Seal Hat Style All Models "Viton"	25	68-9153
26432-76A	'86-05 Cylinder to Head Dowel O-ring	10	68-9287
	3 13/16" Big Bore EVOs .030" MLS Design	2	68-9692
	3 13/16" Big Bore EVOs .040" MLS Design	2	68-9693
	3 3/4" Big Bore EVOs .030" MLS Design	2	68-9694
	3 3/4" Big Bore EVOs .040" MLS Design	2	68-9695
	3 5/8" Big Bore EVOs .030" MLS Design	2	68-9690
	3 5/8" Big Bore EVOs .040" MLS Design	2	68-9691
	Stock Bore EVOs 3.570" .030" MLS Design	2	68-9688
	Stock Bore EVOs 3.570" .040" MLS Design	2	68-9689
<b>PUSHROD O-RING KIT</b>			
11110	'86-90 Tappet Screw O-ring	10	68-9448
11132	'86-90 Pushrod Tube O-ring Middle	25	68-9459
11145	'86-90 Pushrod Tube O-ring Lower	25	68-9293
11167A	'86-90 Tappet Block O-ring Upper	25	68-9443
11168A	'86-90 Tappet Block O-ring Lower	10	68-9444
11176	'91-99 Tappet Pin Cover O-ring - Anti Rotation Pin	10	68-9296
11190	'91-Up Pushrod Tube O-ring Upper	10	68-9294
11377	'04-Up Lower pushrod tube O-ring	25	68-9956
17976-04	'04-Up Tappet block gasket	2	68-9955
111157	'86-90 Pushrod Tube O-ring Upper	25	68-9292
17944-89	'91-99 Pushrod Tube O-ring Lower	10	68-9295
	'91-03 Sportster Pushrod O-ring Kit	KIT	68-9143
<b>CAM COVER GASKETS</b>			
11124-DL	'86-99 Points Cover Seal Double Lip	5	68-9355
25263-86	'86-90 Sportster Cam Cover Gasket	1	68-9311F1
25263-86	'86-90 Sportster Cam Cover Gasket	5	68-9311F5
25263-90B	'91-03 Sportster Cam Cover Gasket	1	68-9313F1
25263-90B	'91-03 Sportster Cam Cover Gasket	5	68-9313F5
25263-90D	'04-Up Sportster Cam cover Gasket .032" AFM	1	68-9944F1
25263-90D	'04-Up Sportster Cam cover Gasket .032" AFM	5	68-9944F5
25279-08	'08-Up XR1200 Cam Cover Gasket	1	68-10029F1
25279-08	'08-UP XR1200 Cam Cover Gasket	5	68-10029F5
32591-80	'86-99 Points Cover Gasket	10	68-9306F

## EVO SPORTSTER GASKETS &amp; SEALS



OEM#	Application	Quantity	WPS#
<b>EVO SPORTSTER GASKETS, SEALS, O-RINGS</b>			
<b>INTAKE AND EXHAUST GASKETS</b>			
26995-86A	'86-Up Intake Manifold to Head / Seal	10	<b>68-9290</b>
27002-89	'84-04 Intake Seal to Carb	1	<b>68-9088</b>
29058-77	L'76-87 XL Keihin Air Cleaner Gasket .031" Fiber	10	<b>68-9300</b>
29059-88	'88-98 XL Keihin CV Air Cleaner Gasket .039" Fiber	20	<b>68-9301</b>
65324-83	'84-Up Exhaust Port Gasket "RACE STYLE"	10	<b>68-9719</b>
65324-83A	'84-Up Exhaust Port Gasket "TAPERED STYLE"	10	<b>68-9288</b>
	'84-Up All Models Exhaust "EXTREME PERFORMANCE"	10	<b>68-9540</b>
	S&S Big Bore Manifold to Head Seal	4	<b>68-9223</b>
<b>OIL PUMP AND RELATED GASKETS, SEALS, AND O-RINGS</b>			
11120	'04-Up Oil dipstick O-ring	5	<b>68-9961</b>
12036A	'86-90 Oil Pump Seal metal	5	<b>68-9376</b>
26433-77	'77-85 Oil Pump Check Valve O-ring	10	<b>68-9449</b>
26434-76A	'86-90 Oil Pump O-ring	10	<b>68-9439</b>
26434-91	'91-Up Oil Pump Cover O-ring	10	<b>68-9437</b>
26495-75	'86-90 Oil Pump Gasket	10	<b>68-9399F</b>
26495-89B	'91-Up Oil Pump Gasket	10	<b>68-9315F</b>
	'04-Up Oil jet assembly gasket	6	<b>68-9962</b>
<b>PRIMARY COVER GASKETS &amp; SEALS</b>			
11105	'04-Up Primary drain plug O-ring	10	<b>68-9435</b>
11171	'86-03 Primary Inspection Cover Screw O-ring	10	<b>68-9436</b>
11179	'88-Up Clutch Cable O-ring	25	<b>68-9447</b>
11187	'91-93 Clutch Inspection Cover O-ring	10	<b>68-9434</b>
11188	'91-99 Inspection Cover O-ring	10	<b>68-9439</b>
11289A	'04-Up Crank Position Sensor O-ring	25	<b>68-9667</b>
12068	'04-Up Motor Sprocket Shaft Seal	5	<b>68-9632</b>
25463-94A	'94-Up Clutch Cover O-ring	5	<b>68-9220</b>
34624-77	'77-90 Footpeg Stud Gasket	10	<b>68-9401</b>
34955-04	'04-Up Sportster Primary Gasket	1	<b>68-9943F1</b>
34955-04	'04-Up Sportster Primary Gasket	5	<b>68-9943F5</b>
34955-75X	'77-90 Ironhead/EVO Sportster Primary Cover Gasket .060" AFM	1	<b>68-9310F1</b>
34955-75X	'77-90 Ironhead/EVO Sportster Primary Cover Gasket .060" AFM	5	<b>68-9310F5</b>
34955-89A	'91-03 Sportster Primary Gasket	1	<b>68-9314F1</b>
34955-89A	'91-03 Sportster Primary Gasket	5	<b>68-9314F5</b>
34986-04	'04-Up Chain Inspection Cover Gasket .060 AFM	5	<b>68-9957</b>
35151-74	'86-99 Motor Sprocket Shaft Seal	5	<b>68-9353</b>
37101-84A	'86-05 Shifter Shaft Seal	1	<b>68-9354</b>
	'04-Up sportster Primary Rebuild Gasket Kit	Kit	<b>68-9125</b>
	'86-90 Sportster Primary Rebuild Gasket Kit		<b>68-9210</b>
	'91-03 Sportster Primary Rebuild Gasket Kit		<b>68-9211</b>
<b>STARTER AND TRANSMISSION GASKETS, SEALS, AND O-RINGS</b>			
11113	'06-Up Main Shaft O-ring 5th Gear	5	<b>68-9460</b>
11165	'91-04 Main Shaft Quad Seal 5th Gear	10	<b>68-9361</b>
12030	'91-Up Main Drive Gear Seal	5	<b>68-9362</b>
12050	'91-94 Transmission M/S Seal	1	<b>68-9359</b>
12074	'06-Up Main Shaft Seal	1	<b>68-9215</b>
12049-DL	'86-90 Transmission M/S Seal	5	<b>68-9356</b>
12067B	'95-05 Main Drive Gear Seal	1	<b>68-9262</b>
31488-81B	'86-Up Starter Gasket	10	<b>68-9312F</b>

WINDSHIELDS / FAIRINGS

AUDIO / COMMUNICATION

SEATS / LUGGAGE

BARS / MIRRORS / CONTROLS

EXHAUST

AIR / FUEL SYSTEMS

ENGINE

TRANSMISSION / DRIVELINE

GASKETS / SEALS

ELECTRICAL

LIGHTING

CABLES

BRAKES

OIL FILTERS

SUSPENSION

BODY

WHEELS

TIRES / TIRE ACC.

BIKE ACC.

VICTORY / INDIAN

COVERS / LOCKS / TIEDOWNS

CHEMICALS

TOOLS

HELMETS

HELMET ACC.

EYEWEAR

APPAREL / RIDER ACC.

PROMOTIONAL

REFERENCE

INDEX



# IRONHEAD SPORTSTER GASKETS & SEALS

- At Cometic Gasket, our goal is to offer the latest in gasket technology
- Materials, manufacturing processes and gasket designs are constantly improving to match the higher level of performance for today's powerful V-Twin engines
- When purchasing a Cometic gasket kit, you can rest assured that every component will be the best solution for your application
- Low Compression, .063" Head Gaskets
- Head Gaskets are .032" copper except where noted and Base Gaskets are .031"
- Kit contains all of the necessary gaskets, seals and o-rings to rebuild the motor from the cylinder base up



WINDSHIELDS / FAIRINGS  
AUDIO / COMMUNICATION  
SEATS / LUGGAGE  
BARS / MIRRORS / CONTROLS  
EXHAUST  
AIR / FUEL SYSTEMS  
ENGINE  
TRANSMISSION / DRIVELINE  
**GASKETS / SEALS**  
ELECTRICAL  
LIGHTING  
CABLES  
BRAKES  
OIL FILTERS  
SUSPENSION  
BODY  
WHEELS  
TIRES / TIRE ACC.  
BIKE ACC.  
VICTORY / INDIAN  
COVERS / LOCKS / TIEDOWNS  
CHEMICALS  
TOOLS  
HELMETS  
HELMET ACC.  
EYEWEAR  
APPAREL / RIDER ACC.  
PROMOTIONAL  
REFERENCE  
INDEX

OEM#	Application	Quantity	WPS#
<b>1957-85 XL IRONHEAD SPORTSTER GASKETS, SEALS, O-Rings</b>			
<b>STANDARD MOTOR KITS</b>			
17026-71	'57-71 900 Sportster XL, XLH, XLCH	Kit	<b>68-9045F</b>
17026-72	'72-E73 1000 Sportster XLH, XLCH	Kit	<b>68-9047F</b>
17026-73L	'73-76 1000 Sportster XLH, XLCH	Kit	<b>68-9049F</b>
17026-79	'77-85 1000 Sportster XLH, XLCH, XLS Hi-Compression	Kit	<b>68-9051F</b>
17026-82	'82-85 1000 Sportster XLH, XL, XLS	Kit	<b>68-9117F</b>
<b>TOP END GASKET KITS</b>			
17030-57	'57-71 900 Sportster XL, XLH, XLCH	Kit	<b>68-9102</b>
17030-72	'72-E73 1000 Sportster XLH, XLCH	Kit	<b>68-9103</b>
17030-72AL	'73-76 1000 Sportster XLH, XLCH	Kit	<b>68-9104</b>
17030-72B	'77-85 1000 Sportster XLH, XLCH, XLS Hi-Compression	Kit	<b>68-9052</b>
17030-82	'82-85 1000 Sportster XLH, XL, XLS	Kit	<b>68-9116</b>
<b>ROCKER COVER GASKETS, SEALS, AND O-RINGS</b>			
11101	'57-85 Rocker Arm Shaft O-ring	10	<b>68-9451</b>
17536-70	'57-85 Rocker Cover Gasket	10	<b>68-9602</b>
63529-57	'57-85 Rubber Sleeve, Oil Line	10	<b>68-9365</b>
11115	'83-85 XR1000 Rocker Arm Shaft O-ring	10	<b>68-9529</b>
11110	'83-85 XR1000 Rocker Shaft O-ring	10	<b>68-9448</b>
6114	'86 Rocker Cover Washer copper	10	<b>68-9400</b>
<b>HEAD AND BASE GASKETS</b>			
16774-57	'57-71 900cc Cylinder Base Gasket, .012" fiber	10	<b>68-9699</b>
16774-72	'72-85 1000cc Cylinder Base Gasket, .031" Fiber	10	<b>68-9603</b>
16769-72A	'72-E73 1000cc Head Gasket, .020" Copper	10	<b>68-9698</b>
16769-73	L'73-85 1000cc Head Gasket, .032" Copper	10	<b>68-9565</b>
16769-82	L'73-85 1000cc Head Gasket, .043" Copper	10	<b>68-9566</b>
<b>PUSHROD AND TAPPET BLOCK GASKETS, O-RINGS</b>			
17955-36	'57-E79 Pushrod Cover Seal / cork	25	<b>68-9598</b>
17955-36A	'57-E79 Pushrod Cover Seal / rubber	100	<b>68-9408</b>
11132	'79-85 Pushrod Cover O-ring (4) middle	25	<b>68-9459</b>
12023	'83-85 XR 1000 Pushrod Cover Seal	5	<b>68-9369</b>
11157	'84-85 Pushrod Cover O-ring (4) upper	25	<b>68-9292</b>
<b>INTAKE AND EXHAUST GASKETS</b>			
27023-71	'72-E76, '79-85 XL Bendix Manifold Gasket .020" Fiber	10	<b>68-9417</b>
27062-78	'79-85 Intake Manifold to Head O-ring	10	<b>68-9608</b>
<b>CAM AND TIMER COMPARTMENT GASKETS</b>			
32522-37	'57-64 XL, XLH Timer Base Gasket	10	<b>68-9325</b>
25224-52A	'57-81 Cam cover Gasket, XR750	5	<b>68-9316F5</b>
32591-70	'71-78 Point Cover Gasket	10	<b>68-9323</b>
11124DL	'71-85 Timer Compartment Seal / double lip	5	<b>68-9355</b>
32591-80	'80-85 Ignition Cover Gasket	10	<b>68-9306</b>
25263-81	'82-85 Cam Cover Gasket	10	<b>68-9332</b>

## IRONHEAD SPORTSTER GASKETS &amp; SEALS



OEM#	Application	Quantity	WPS#
<b>1957-85 XL IRONHEAD SPORTSTER GASKETS,SEALS, O-Rings</b>			
<b>CHARGING AND STARTING GASKETS</b>			
29550-55	'58-69 XLCH Magneto Cover Gasket	10	<b>68-9327</b>
29603-48	'58-E65 Magneto Seal	10	<b>68-9374</b>
30143-58	'58-E84 Generator Gasket	5	<b>68-9321</b>
60645-65	'67-80 Solenoid Gasket	10	<b>68-9702</b>
31471-67A	'67-80 Starter Housing Gasket	10	<b>68-9324</b>
31488-77	'67-80 Starter Housing Mount Gasket	10	<b>68-9333</b>
12023	'68-69 XLCH Magneto Seal	5	<b>68-9369</b>
31461-70	'70-E79 Starter hole cover plate Gasket	10	<b>68-9701F</b>
11116	'81-85 Starter Housing O-ring	25	<b>68-9433</b>
31488-81	'81-85 Starter Motor Gasket	10	<b>68-9312</b>
<b>OIL SYSTEM GASKETS, O-RINGS AND SEALS</b>			
26258-62	L'62-71 Oil Pump Outer Cover Gasket	10	<b>68-9389</b>
26256-52	'57-76 Oil Pump Gasket	10	<b>68-9390</b>
24978-57	'57-76 Oil Strainer Gasket	10	<b>68-9404</b>
26259-52	'57-E62, '72-76 Oil Pump Inner Cover Gasket	10	<b>68-9388</b>
26258-52	'57-E62, '72-76 Oil Pump Outer Cover Gasket	10	<b>68-9385</b>
26227-58	L'58-76 Oil Pump Oil Seal	5	<b>68-9349</b>
26259-62	L'62-71 Oil Pump Inner Cover Gasket	10	<b>68-9386</b>
63858-49	'71-85 Oil Level Screw Gasket	10	<b>68-9286</b>
12036A	'77-78 / 83-85 Oil Pump Outer Plate Seal	5	<b>68-9376</b>
26433-77	'77-85 Check Valve Oil Pump O-ring	10	<b>68-9449</b>
26432-76A	'77-85 Oil Pump Body O-ring	10	<b>68-9287</b>
26434-76A	'77-85 Oil Pump Cover O-ring	10	<b>68-9445</b>
26495-75	'77-85 Oil Pump Gasket	10	<b>68-9399</b>
<b>PRIMARY, CLUTCH, AND TRANSMISSION GASKETS,SEALS,AND O-RINGS</b>			
17955-48	'48-E79 Push Rod Cover Large Cork	25	<b>68-9606</b>
37531-56B	'57-66 XLH, '57-69 XLCH Clutch Gear Seal	5	<b>68-9368</b>
37762-52	'57-70 Clutch Cover Gasket	10	<b>68-9319</b>
37339-53	'57-70 Release Rod Oil Seal	10	<b>68-9364</b>
33076-37	'57-79 Kicker Shaft Seal	10	<b>68-9374</b>
34035-52	'57-85 Shifter Shaft Seal	5	<b>68-9370</b>
35151-52A	'57-E84 Trans Mainshaft Seal, '57-E74 Sprocket Shaft	5	<b>68-9366</b>
11103	L'57-66 XLH, '57-69 XLCH Clutch Gear O-ring	10	<b>68-9458</b>
37740-57	L'57-66 XLH, '57-69 XLCH Clutch Shell Seal	5	<b>68-9371</b>
34952-52	XR750, '58-69 XLCH Primary Cover Gasket AFM .060"	5	<b>68-9317F5</b>
60567-36	'58-69 XLCH Inspection Cover Gasket AFM .060"	5	<b>68-9326F</b>
12021	'67-70 XLH, '70 XLCH Clutch Gear Oil Seal	5	<b>68-9367</b>
11119	'67-70 XLH, '70 XLCH Clutch Gear O-ring	25	<b>68-9455</b>
37741-67	'67-70 XLH, '70 XLCH Clutch Shell Seal	5	<b>68-9513</b>
34955-67	'67-76 XLH, '70-76 XLCH Primary Cover Gasket AFM .060"	5	<b>68-9318F5</b>
34955-67A	'67-76 XLH, '70-76 XLCH Primary Cover Gasket .031"	5	<b>68-9703</b>
34624-77	'77-85 Left Footrest Stud Boss Gasket	10	<b>68-9401</b>
11139	L'78-85 Primary Filler Cap O-ring	10	<b>68-9446</b>
35151-74	L'84-85 Trans Mainshaft Seal, L'74-85 Motor Sprocket Shaft	5	<b>68-9353</b>
12049DL	L'84-85 Transmission Mainshaft Seal	5	<b>68-9356</b>
<b>MISCELLANEOUS GASKETS, SEALS, AND O-RINGS</b>			
60567-36	'58-69 XLCH Inspection Cover Gasket AFM .060"	1	<b>68-9326F1</b>
60567-36	'58-69 XLCH Inspection Cover Gasket AFM .060"	5	<b>68-9326F5</b>
11107	'66-71 XL Tillotson Spacer O-Ring	10	<b>68-9452</b>

WINDSHIELDS /  
FAIRINGSAUDIO /  
COMMUNICATIONSEATS /  
LUGGAGEBARS / MIRRORS /  
CONTROLS

EXHAUST

AIR /  
FUEL SYSTEMS

ENGINE

TRANSMISSION /  
DRIVELINEGASKETS /  
SEALS

ELECTRICAL

LIGHTING

CABLES

BRAKES

OIL FILTERS

SUSPENSION

BODY

WHEELS

TIRES /  
TIRE ACC.

BIKE ACC.

VICTORY /  
INDIANCOVERS / LOCKS /  
TIEDOWNS

CHEMICALS

TOOLS

HELMETS

HELMET ACC.

EYEWEAR

APPAREL /  
RIDER ACC.

PROMOTIONAL

REFERENCE

INDEX



## V-ROD GASKETS & SEALS

- Provide maximum sealing performance for today's high output engines and require no sealants
- Ideal for aluminum heads to aluminum blocks and aluminum heads to cast iron blocks withstanding the shearing force created by the two materials.
- No need to re-torque, the embossing design of the MLS gasket promotes an even clamp load across the sealing surface allowing for measurable reduced bore distortion



OEM#	Application	Quantity	WPS#
<b>V-ROD MLS HEAD GASKET</b>			
	4.017" Bore .027"	2	<b>68-9895</b>
	4.017" Bore .030"	2	<b>68-9896</b>
<b>V-ROD EXHAUST GASKET</b>			
65109-01	Extreme Performance Gasket	2	<b>68-9928</b>

## STREET 500/750 HEAD AND BASE GASKETS

OEM#	Application	Quantity	WPS#
16500085	'15-17 XGStreet 500 Head Gasket 69mm Stock Bore, .036" MLS	2	<b>68-10134</b>
16500085	'15-17 XGStreet 500 Head and Base Gasket 69mm Stock Bore, .036" MLS	Kit	<b>68-10134-HB</b>
16500123	'15-17 XGStreet 750 Head Gasket 69mm Stock Bore, .036" MLS	2	<b>68-10136</b>
16500123	'15-17 XGStreet 750 Head and Base Gasket 69mm Stock Bore, .036" MLS	Kit	<b>68-10136-HB</b>



- WINDSHIELDS / FAIRINGS
- AUDIO / COMMUNICATION
- SEATS / LUGGAGE
- BAR / MIRRORS / CONTROLS
- EXHAUST
- AIR / FUEL SYSTEMS
- ENGINE
- TRANSMISSION / DRIVELINE
- GASKETS / SEALS
- ELECTRICAL
- LIGHTING
- CABLES
- BRAKES
- OIL FILTERS
- SUSPENSION
- BODY
- WHEELS
- TIRES / TIRE ACC.
- BIKE ACC.
- VICTORY / INDIAN
- COVERS / LOCKS / TIEDOWNS
- CHEMICALS
- TOOLS
- HELMETS
- HELMET ACC.
- EYEWEAR
- APPAREL / RIDER ACC.
- PROMOTIONAL
- REFERENCE
- INDEX



# GASKET DISPLAY BOARDS

- 3 color design, boards measure 48"W x 32"H and are manufactured from 20 mil flexible vinyl and mount easily on 1/8" or 1/4" pegboard
- Help track inventory and keeps Gaskets out of harms way
- Includes display hooks for mounting

Description	Display Board	Gaskets for Display Board
Twin Cam 96" Gasket, Seal and O-Ring	<b>68-9234F</b>	<b>68-9234F-GAS</b>
Twin Cam 88" Gasket, Seal and O-Ring	<b>68-9228F</b>	<b>68-9228F-GAS</b>
Evo Big Twin '84-99 Gasket, Seal and O-Ring	<b>68-9229F</b>	<b>68-9229F-GAS</b>
Big Twin '36-84 Gasket, Seal and O-Ring	<b>68-9230F</b>	<b>68-9230F-GAS</b>
Big Twin Primary Gasket, Seal and O-Ring	<b>68-9231F</b>	<b>68-9231F-GAS</b>
Big Twin Transmission Gasket, Seal and O-Ring	<b>68-9232F</b>	<b>68-9232F-GAS</b>
Evo XL '86-00 Gasket, Seal and O-Ring	<b>68-9233F</b>	<b>68-9233F-GAS</b>
H-D High Performance Engines Gasket, Seal and O-Ring	<b>68-9235F</b>	<b>68-9235F-GAS</b>

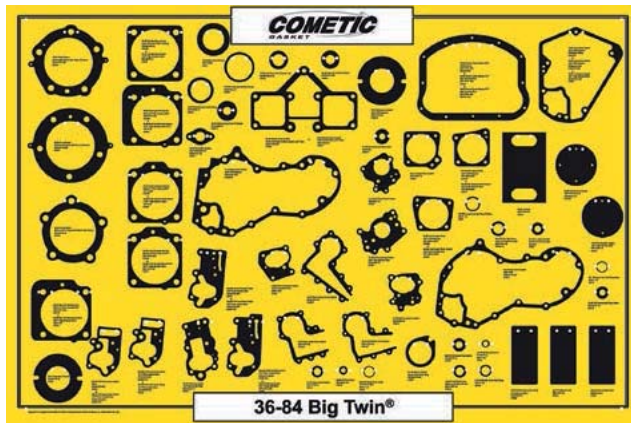
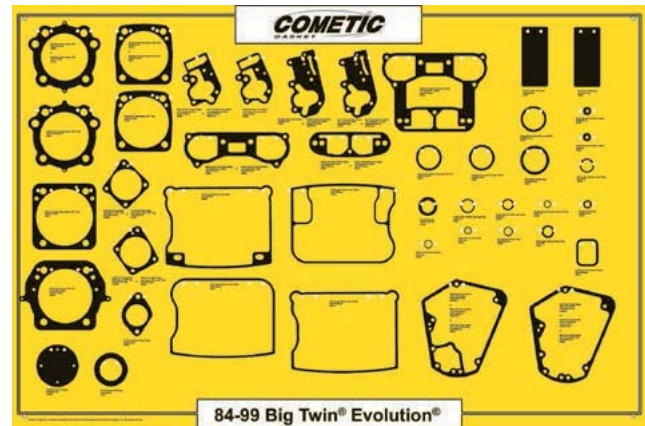
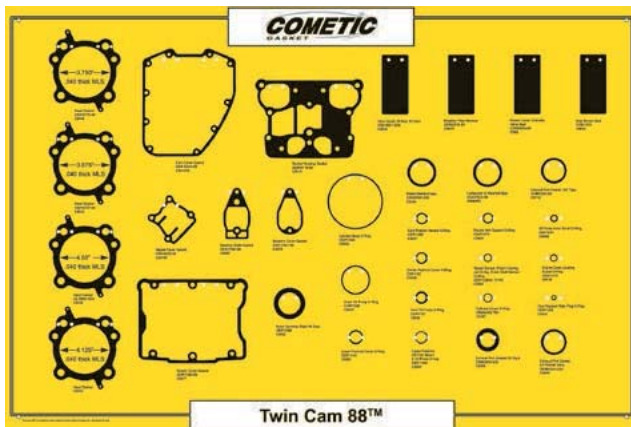

- WINDSHIELDS / FAIRINGS
- AUDIO / COMMUNICATION
- SEATS / LUGGAGE
- BARS / MIRRORS / CONTROLS
- EXHAUST
- AIR / FUEL SYSTEMS
- ENGINE
- TRANSMISSION / DRIVELINE
- GASKETS / SEALS**
- ELECTRICAL
- LIGHTING
- CABLES
- BRAKES
- OIL FILTERS
- SUSPENSION
- BODY
- WHEELS
- TIRES / TIRE ACC.
- BIKE ACC.
- VICTORY / INDIAN
- COVERS / LOCKS / TIEDOWNS
- CHEMICALS
- TOOLS
- HELMETS
- HELMET ACC.
- EYEWEAR
- APPAREL / RIDER ACC.
- PROMOTIONAL
- REFERENCE
- INDEX



**MILWAUKEE 8 GASKETS & SEALS**



- Genuine James Gaskets uses state of the art materials and production methods to make the best gaskets available
- Comprehensive gasket kits for many applications as well as individual gaskets are available
- Various material choices available depending on application
- FOAMET - foam covered metal
- MLS - multi layered steel
- RCM - rubber covered metal
- Micropore paper gaskets with or without elastomer bead (Nitrile or Silicone)
- Made in the U.S.A.

OEM#	JGI#	Application	Quantity	WPS#
<b>MILWAUKEE 8 GASKET KITS</b>				
17030-17	JGI-17030-17	Gasket Kit, Rocker Cover M8 '17-Up	Kit	<b>681-6125</b>
25700370-K	JGI-25700370-K	Gasket Kit, Cam Change Kit M8 '17-Up	Kit	<b>681-6124</b>
25700378-K	JGI-25700378-K	Gasket Kit, Primary Touring M8 '17-Up	Kit	<b>681-6126</b>
25700729	JGI-25700729	Gasket Kit, Top End M8 '17-Up	Kit	<b>681-6122</b>
25700730	JGI-25700730	Gasket Kit, Motor M8 '17-Up	Kit	<b>681-6123</b>
33031-17	JGI-33031-17	Gasket Kit, Transmission Touring M8 '17-Up	Kit	<b>681-6121</b>
<b>MILWAUKEE 8 INDIVIDUAL GASKETS, SEALS, O-RINGS 17-UP</b>				
<b>ROCKER BOX ASSEMBLY GASKETS</b>				
11900116	JGI-11900116	O-ring, Breather Assembly, M8 '17-Up	10	<b>681-6103</b>
25700372	JGI-25700372	Gasket, Rocker Covers Foamet, M8 '17-Up	2	<b>681-6105</b>
25700425	JGI-25700425	Seal, Rocker Box to Cylinder Head, M8 '17-Up	5	<b>681-6106</b>
<b>PUSHROD, TAPPET GASKETS AND VALVE STEM SEALS</b>				
18100044	JGI-18100044	Seal, Valve Stem Viton, M8 '17-Up	8	<b>681-6102</b>
25700362	JGI-25700362	Gasket, Lifter Cover Foamet, M8 '17-Up	2	<b>681-6104</b>
<b>HEAD AND BASE GASKETS</b>				
16500326	JGI-16500326	Gasket, Cylinder Head 107" Composite w/bead ".045, M8 '17-Up	5	<b>681-6100</b>
16500332	JGI-16500332	Gasket, Cylinder Base Foamet ".025, M8 '17-Up	2	<b>681-6101</b>
<b>MOTOR CASE O-RINGS AND SEALS</b>				
11000134	JGI-11000134	Seal, Motor Sprocket Shaft Double Lip, M8 '17-Up	5	<b>681-6127</b>
24400215	JGI-24400215	Seal, Engine to Transmission Interface, Molded Rubber on Metal Core, M8 '17-Up	1	<b>681-6116</b>
25600455	JGI-25600455	Seal, Primary to Engine Interface, Molded Rubber on Metal Core, M8 '17-Up	1	<b>681-6120</b>
25700433	JGI-25700433	Gasket, Piston Oil Squirter Foamet, M8 '17-Up	10	<b>681-6110</b>
<b>OIL AND OIL PUMP GASKETS</b>				
11900010	JGI-11900010	O-ring Oil Pump Plug Twin Cooled Only, M8 '17-Up	10	<b>681-6109</b>
11900103	JGI-19100103	O-ring, Oil Pump Front, M8 '17-Up	25	<b>681-6111</b>
<b>CAM HOUSING</b>				
25800370	JGI-25800370	Gasket, Cam Cover Foamet, M8 '17-Up	5	<b>681-6112</b>
<b>INTAKE AND EXHAUST GASKETS</b>				
27300087	JGI-27300087	Seal, Intake Manifold Viton, M8 '17-Up	10	<b>681-6113</b>
29000149	JGI-29000149	Gasket, Screamin Eagle Aircleaner Foamet, M8 '17-Up	5	<b>681-6114</b>
<b>PRIMARY HOUSING GASKETS</b>				
25600455	JGI-25600455	Seal, Primary to Engine Interface, Molded Rubber on Metal Core, M8 '17-Up	1	<b>681-6120</b>
25700378	JGI-25700378	Gasket, Primary Cover Foamet, M8 Touring '17-Up	1	<b>681-6119</b>
<b>TRANSMISSION GASKETS</b>				
11000101	JGI-11000101	Seal, Shifter Shaft Double Lip, M8 '17-Up	5	<b>681-6115</b>
11900092	JGI-11900092	O-ring, Transmission Oil Return Air Cooled Only, M8 '17-Up	25	<b>681-6108</b>
24400215	JGI-24400215	Seal, Engine to Transmission Interface, Molded Rubber on Metal Core, M8 '17-Up	1	<b>681-6116</b>
25700452	JGI-25700452	Gasket, Oil Pan Foamet, M8 Touring '17-Up	5	<b>681-6117</b>
25700453	JGI-25700453	Gasket, Transmission Top Cover Foamet, M8 '17-Up	5	<b>681-6118</b>
<b>MISCELLANEOUS GASKETS, SEALS, AND O-RINGS</b>				
11900090	JGI-11900090	O-ring, Coolant Manifold Twin and Air Cooled, M8 '17-Up	25	<b>681-6107</b>





## TWIN CAM GASKETS & SEALS

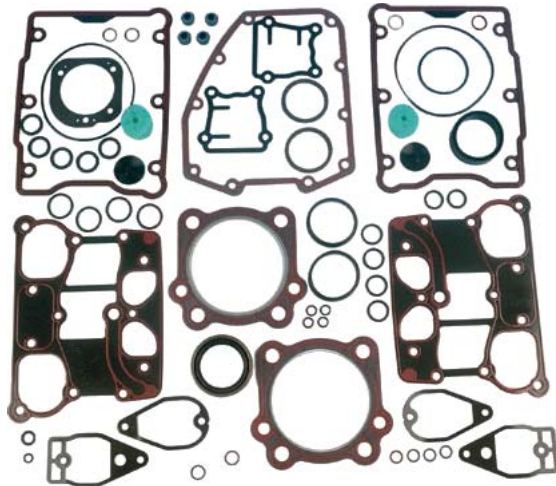

- Genuine James Gaskets uses state of the art materials and production methods to make the best gaskets available
- Comprehensive gasket kits for many applications as well as individual gaskets are available
- Various material choices available depending on application
- FOAMET - foam covered metal
- MLS - multi layered steel
- RCM - rubber covered metal
- Micropore paper gaskets with or without elastomer bead (Nitrile or Silicone)
- Made in the U.S.A.

OEM#	JGI#	Application	Quantity	WPS#
<b>TWIN CAM GASKET KITS</b>				
17043-95	JGI-17043-99	O-ring Kit, Induction Module, '99-01 Twin-Cams	Kit	<b>681-4046</b>
17048-98	JGI-17048-98	Gasket Kit, Exhaust, '99-up Twin Cam 88	Kit	<b>681-4049</b>
17052-99B	JGI-17052-99	Gasket Kit, Top End, w/0.045" Head Gaskets, '99-04 Twin-Cam 1450cc/88"	Kit	<b>681-4020</b>
17052-99B	JGI-17054-99	Gasket Kit, Top End, '99-Up Twin Cam 88 w/0.036" Head Gaskets	Kit	<b>681-4021</b>
17052-99B	JGI-17054-05-MLS	Gasket Kit, Top End, w/MLS Head Gaskets, '05-up, Twin-Cam '95-96	Kit	<b>681-4011</b>
17052-99B	JGI-17054-05-X	Gasket Kit, Top End, '05-Up, Twin-Cam 95"/103" w/0.036" Head Gaskets	Kit	<b>681-4013</b>
17052-99B	JGI-17052-05	Gasket Kit, Top End, '05-Up Twin Cam 88 w/0.046" Head Gaskets	Kit	<b>681-4014</b>
17052-99B	JGI-17054-05	Gasket Kit, Top End, '05-UpTwin Cam 88 w/0.036" Head Gaskets	Kit	<b>681-4015</b>
17053-99B	JGI-17053-05	Gasket Kit, Motor, '05-06 Twin Cam 88 w/0.046" Head Gaskets	Kit	<b>681-4004</b>
17053-99B	JGI-17053-05-X	Gasket Kit, Motor, '05-Up Twin Cam 88 w/0.036" Head Gaskets	Kit	<b>681-4005</b>
17053-99B	JGI-17053-99	Gasket Kit, Motor, '99-04, Twin Cam 88 w/0.046" Head Gaskets	Kit	<b>681-4009</b>
17053-99B	JGI-17053-99-X	Gasket Kit, Motor, '99-04, Twin Cam 88 w/0.036" Head Gaskets	Kit	<b>681-4010</b>
27002-02	JGI-27002-02	Seal Kit, Screamin' Eagle EFI, '01-up w/HTCC Heads	Kit	<b>681-4048</b>
	JGI-17055-05-MLS	Gasket Kit, Motor, w/MLS Head Gaskets, '05-up, Twin-Cam 95/96	Kit	<b>681-4001</b>
	JGI-17055-05	Gasket Kit, Motor, '05-up, Twin-Cam '95-96 w/0.046" Head Gaskets	Kit	<b>681-4002</b>
	JGI-17055-05-X	Gasket Kit, Motor, '05-up, Twin-Cam '95-96 w/0.036" Head Gaskets	Kit	<b>681-4003</b>
	JGI-17055-99-MLS	Gasket Kit, Motor, w/MLS Head Gaskets, '99-04, Twin Cam 95	Kit	<b>681-4006</b>
	JGI-17055-99	Gasket Kit, Motor, '99-04, Twin Cam 95 w/0.046" Head Gaskets	Kit	<b>681-4007</b>
	JGI-17055-99-X	Gasket Kit, Motor, '99-04, Twin Cam 95 w/0.036" Head Gaskets	Kit	<b>681-4008</b>
	JGI-17052-05-X	Gasket Kit, Top End, '05-up, Twin-Cam 95"-96" w/0.046" Head Gaskets	Kit	<b>681-4012</b>
	JGI-17052-99-MLS	Gasket Kit, Top End, w/0.045" MLS Head Gaskets, '99-04, Twin-Cam 1550cc/95"	Kit	<b>681-4016</b>
	JGI-17054-99-MLS	Gasket Kit, Top End, w/MLS Head Gaskets, '99-04, Twin Cam 95	Kit	<b>681-4017</b>
	JGI-17052-99-X	Gasket Kit, Top End, '99-04, Twin Cam 95 w/0.046" Head Gaskets	Kit	<b>681-4018</b>
	JGI-17054-99-X	Gasket Kit, Top End, '99-04, Twin Cam 95 w/0.036" Head Gaskets	Kit	<b>681-4019</b>
	JGI-17047-98	Gasket-O-ring Kit, Cylinder Head-Base, '99-up Twin Cam 88	Kit	<b>681-4022</b>
	JGI-17033-99	Gasket Kit, Rocker Cover, '99-up Twin Cam	Kit	<b>681-4023</b>
	JGI-11293-K	Gasket Kit, Tappet Cover-Pushrod Tube, Includes Mounting Hardware, '99-up Twin Cams	Kit	<b>681-4024</b>
	JGI-11293-TC	Gasket Kit, Tappet Cover-Pushrod Tube, '99-up Twin Cam	Kit	<b>681-4025</b>
	JGI-25244-99-K	Gasket-O-ring Kit, Cam Quick Change, '99-up Twin Cam	Kit	<b>681-4026</b>
	JGI-33031-07	Gasket-Seal Kit, Transmission, '07-16 Touring Models	Kit	<b>681-4027</b>
	JGI-33031-06	Gasket-Seal Kit, Transmission, '06-Up Dyna '07-Up Softail	Kit	<b>681-4028</b>
	JGI-33031-05	Gasket-Seal Kit, Transmission, '01-05 Dyna	Kit	<b>681-4029</b>
	JGI-33031-99	Gasket-Seal Kit, Transmission, '99-05 Twin Cam	Kit	<b>681-4030</b>
	JGI-12074-K	Oil Seal Kit, Transmission Main Drive, '06-Up	Kit	<b>681-4031</b>
	JGI-34901-07-KF	Gasket Kit, Primary Cover, Foamet w/Bead, '07-16 Touring Models	Kit	<b>681-4032</b>
	JGI-34901-07-K	Gasket Kit, Primary Cover, Paper w/Bead, '07-16 Touring Models	Kit	<b>681-4033</b>
	JGI-34901-05-K	Gasket Kit, Primary Cover, '05-06 Touring Models	Kit	<b>681-4034</b>
	JGI-34901-94-K	Gasket-Seal Kit, Primary Cover, '94-04 FLT, FXR	Kit	<b>681-4035</b>
	JGI-60547-06-KF	Gasket Kit, Primary Cover, Foamet w/Bead, '06-up Dyna, '07-up Softail	Kit	<b>681-4036</b>
	JGI-60547-06-K	Gasket Kit, Primary Cover, Paper w/Bead, '06-up Dyna, '07-up Softail	Kit	<b>681-4037</b>
	JGI-60539-89-KX	Gasket Kit, Primary Cover, .062" Paper with Bead, '89-05 Dyna	Kit	<b>681-4038</b>
	JGI-60539-94-K	Gasket Kit, Primary Cover, .062" Paper, '94-05 Dyna '94-06 Softail	Kit	<b>681-4039</b>

- WINDSHIELDS / FAIRINGS
- AUDIO / COMMUNICATION
- SEATS / LUGGAGE
- BAR / MIRRORS / CONTROLS
- EXHAUST
- AIR / FUEL SYSTEMS
- ENGINE
- TRANSMISSION / DRIVELINE
- GASKETS / SEALS**
- ELECTRICAL
- LIGHTING
- CABLES
- BRAKES
- OIL FILTERS
- SUSPENSION
- BODY
- WHEELS
- TIRES / TIRE ACC.
- BIKE ACC.
- VICTORY / INDIAN
- COVERS / LOCKS / TIEDOWNS
- CHEMICALS
- TOOLS
- HELMETS
- HELMET ACC.
- EYEWEAR
- APPAREL / RIDER ACC.
- PROMOTIONAL
- REFERENCE
- INDEX



**TWIN CAM GASKETS & SEALS**

- WINDSHIELDS / FAIRINGS
- AUDIO / COMMUNICATION
- SEATS / LUGGAGE
- BAR / MIRRORS / CONTROLS
- EXHAUST
- AIR / FUEL SYSTEMS
- ENGINE
- TRANSMISSION / DRIVELINE
- GASKETS / SEALS
- ELECTRICAL
- LIGHTING
- CABLES
- BRAKES
- OIL FILTERS
- SUSPENSION
- BODY
- WHEELS
- TIRES / TIRE ACC.
- BIKE ACC.
- VICTORY / INDIAN
- COVERS / LOCKS / TIEDOWNS
- CHEMICALS
- TOOLS
- HELMETS
- HELMET ACC.
- EYEWEAR
- APPAREL / RIDER ACC.
- PROMOTIONAL
- REFERENCE
- INDEX

OEM#	JGI#	Application	Quantity	WPS#
<b>TWIN CAM GASKET KITS (CONT'D...)</b>				
JGI-25416-99-KT		Gasket Kit, Inspection-Derby Cover, '99-06 Touring Models	Kit	681-4040
JGI-25416-99-K		Gasket Kit, Inspection-Derby Cover, '99-06 Softail, '99-05 Dyna	Kit	681-4041
JGI-29062-06-K		Gasket Kit, Air Cleaner Backplate, '06-08 Softail-Dyna, '06-07 Touring	Kit	681-4042
JGI-29368-99-K		Gasket Kit, Air Cleaner Backplate, '99-01 Touring w/EFI	Kit	681-4043
JGI-27002-00		Seal Kit, Intake Manifold, 44MM Carburetor, '99-up Twin-Cam	Kit	681-4044
JGI-27002-99-X		Seal Kit, Intake Manifold, '99-up Twin-Cam	Kit	681-4045
JGI-27202-95-K		Gasket-Seal Kit, Fuel Injector, '99-01 Twin Cam 88	Kit	681-4047
JGI-45849-06		Seal Kit, Front Fork, '06-up Dyna	Kit	681-4050
JGI-45849-00		Seal Kit, Front Fork, '00-07 Softail Deuce FXSTD	Kit	681-4051
JGI-45858-77-K		Screw Kit, Fork Drain, Chrome, '77-up Touring '87 Softail, '93-05 Softail except FXSTD	Kit	681-4052
<b>TWIN CAM INDIVIDUAL GASKETS, SEALS, O-RINGS 99-UP</b>				
<b>ROCKER BOX ASSEMBLY GASKETS</b>				
11270	JGI-11270	O-ring, Lower Rocker Cover to Cylinder Head, '99-17 Twin-Cam Models	10	681-4107
16719-99B	JGI-16719-99	Gasket, Rocker Cover Base, Metal with Bead, '99-17 Twin-Cam Models	2	681-4102
17386-99	JGI-17386-99	Gasket, Rocker Cover, '99-17 Twin-Cam Models	2	681-4101
17591-99	JGI-17591-99	Gasket, Breather, Cover, RCM, '99-up, Twin-Cam Models	5	681-4103
17592-99	JGI-17592-99	Gasket, Breather Baffle, RCM, '99-up, Twin-Cam Models	5	681-4105
26858-99	JGI-26858-99	Seal, Umbrella Valve, Rocker Cover Breather, '99-up Twin-Cam	6	681-4108
	JGI-17591-99-F	Gasket, Breather, Cover, Foamet '99-up, Twin-Cam Models	5	681-4104
	JGI-17592-99-F	Gasket, Breather Baffle, Foamet, '99-up, Twin-Cam Models	5	681-4106
<b>PUSHROD, TAPPET GASKETS AND VALVE STEM SEALS</b>				
11293	JGI-11293	O-ring, upper Pushrod/Oil Filter/Oil Pump, '99-up Twin-Cam Models	10	681-4121
11132A	JGI-11132-A	O-Ring, Pushrod Tube Cover, VITON, '99-up Twin-Cam Models	10	681-4122
11145A	JGI-11145-A	O-Ring, Tappet Guide to Pushrod Cover, '99-up Twin-Cam Models	10	681-4123
18001-83B	JGI-18001-83-A	Seal, Valve Stem, '99-04 Twin Cam Models	4	681-4125
18094-02	JGI-18094-02	Seal, Valve Stem, 05-17 Twin-Cam models	4	681-4124
18635-99	JGI-18635-99-F	Gasket, Tappet Cover, Front-Rear, Foamet w/Bead, '99-17 Twin-Cam Models	2	681-4120
<b>HEAD AND BASE GASKETS</b>				
11256	JGI-11256	O-ring, Cylinder Base, '99-up Twin-Cam	10	681-4149
11273	JGI-11273	O-ring, Cylinder Head Gasket Locating, '99-17 Twin-Cam Models	10	681-4146
16775-99	JGI-16775-99	Gasket, Cylinder Head, .045" with Armor, '99-up Twin-Cam	5	681-4141
16775-99	JGI-16775-99-X	Gasket, Cylinder Head, .036" with Armor, '99-up Twin-Cam	5	681-4142
16787-99	JGI-16787-99-MLS	Gasket Set, 0.045" MLS Head w/Base O-rings, 1550cc Twin-Cam	2	681-4140
16787-99	JGI-16787-99	Gasket, Cylinder Head, .045" w/Armor, TC95 (1550 Cylinders)	2	681-4143
16787-99	JGI-16787-99-X	Gasket, Cylinder Head, .036" w/Armor, TC95 (1550 Cylinders)	2	681-4144
26432-99	JGI-26432-99	O-ring, Cylinder Head Locating, Use w/.045" TC95 (1550cc) Head Gaskets	10	681-4147
26432-99	JGI-26432-99-X	O-ring, Cylinder Head Locating, Use w/.036" TC95 (1550cc) Head Gaskets	10	681-4148
	JGI-16105-07-X	Gasket, Cylinder Head, 0.045" with Armor, 4" Bore Twin-Cam	2	681-4145
<b>MOTOR CASE O-RINGS AND SEALS</b>				
11288	JGI-11288	O-ring, Cam Positioning Sensor, '99-04 Twin-Cam	10	681-4166
11289A	JGI-11289	O-ring, Crankshaft Positioning, '99-up Twin-Cam	10	681-4167
11298	JGI-11298	O-ring, Cam Support Plate Plug, Viton, '99-06 Twin-Cam	10	681-4168
12068	JGI-12068	Oil Seal, Motor Shaft, '99-17 Twin Cam Motor	5	681-4165
<b>OIL AND OIL PUMP GASKETS</b>				
11120	JGI-11120	O-Ring, Dip Stick, Engine Oil, '06-17 Dyna, '07-16 Touring	10	681-4185
11286	JGI-11286	O-ring, Oil Pump, Outer, '99-06 Twin-Cam	10	681-4180
11301	JGI-11301	O-ring, Oil Pump, Inner, '99-17 Twin-Cam	10	681-4181
11326	JGI-11326	O-Ring, Oil Line Connector to Motor, 00-17 Softail	10	681-4183
11345	JGI-11345	O-Ring, Dip Stick, Oil Tank, '00-06 Softail	10	681-4184
45359-00	JGI-45359-00	Seal, Oil Interconnect, Engine Balancer, Chain Guide Support, 00-17 Softail	10	681-4182
<b>CAM HOUSING</b>				
25244-99A	JGI-25244-99	Gasket, Cam Gear Cover, Paper with Bead, '99-17 Twin-Cam Models	5	681-4202
25244-99	JGI-25244-99-F	Gasket, Cam Gear Cover, Foamet, '99-17 Twin-Cam Models	5	681-4201
<b>INTAKE AND EXHAUST GASKETS</b>				
11291	JGI-11291	Seal, Map Sensor, '99-15 Softail/ Dyna, 99-07 Touring Twin-Cam	10	681-4218
11292	JGI-11292	O-ring, Back Plate Assembly to Cylinder Head, '99-07 Twin-Cam	10	681-4220
26995-86B	JGI-26992-99	Seal, Intake Manifold, Carburetor-E.F.I., '99-16 Touring, '99-17 Softail/ Dyna	2	681-4219
29241-08	JGI-29241-08	Gasket, Air Cleaner Backplate, 0.062" Paper, '08-16 Touring	10	681-4211
29313-95	JGI-29313-95	Gasket, Air Cleaner, Paper with Adhesive, '95-15 (except '08-16Touring)	10	681-4217

## TWIN CAM GASKETS &amp; SEALS



OEM#	JGI#	Application	Quantity	WPS#
<b>TWIN CAM INDIVIDUAL GASKETS, SEALS, O-RINGS 99-UP</b>				
<b>INTAKE AND EXHAUST GASKETS (CONT'D...)</b>				
29463-99	JGI-29463-99	Gasket, Air Cleaner Element, '99-01 Touring w/E.F.I.	10	<b>681-4216</b>
29583-01	JGI-29583-01	Gasket, Air Cleaner Back Plate carburetor '02-15 softail/ Dyna, '02-07 Touring Models	10	<b>681-4213</b>
29583-01A	JGI-29583-01-A	Gasket, Air Cleaner Back Plate 06-up Twin-Cam (except '08 Touring)	10	<b>681-4212</b>
29645-08	JGI-29645-08	Gasket, Air Cleaner Filter Element, 0.062" Paper, '08-16 Touring	10	<b>681-4214</b>
29645-08	JGI-29645-08-F	Gasket, Air Cleaner Filter Element, Foamet, '08-16 Touring	5	<b>681-4215</b>
45465-99	JGI-45465-99	Washer, Air Cleaner Induction Module, Small ID Breather to Cylinder Head	10	<b>681-4221</b>
65324-83B	JGI-65324-83	Gasket, Exhaust Pipe to Cylinder Head, '84-up, All Models (Square S.E style)	10	<b>681-4227</b>
65324-83A	JGI-65324-83-A	Gasket, Exhaust Pipe to Cylinder Head, '92-up, All Models (Tapered O.E.M style)	5	<b>681-4226</b>
65324-83A	JGI-65324-83-CG	Gasket, Exhaust, Copper Crush Ring, Evo, Twin-Cam, Sportster, Buell	10	<b>681-4228</b>
65325-83A	JGI-65325-83-A	Retaining Ring, Exhaust Pipe, All Evo/Twin-Cam Models	2	<b>681-4225</b>
	JGI-29718-08	Gasket, Air Cleaner Backplate, Foamet, '08-16 Touring Models	5	<b>681-4210</b>
	JGI-65000-83-CPW	Washer, Exhaust Mounting, Chrome, 5/16" x 11/16" x .090", Evo-T.C., Use w/JGI-65324-83-N1	4	<b>681-4222</b>
	JGI-65324-83-N1	Nut, Chrome Plated Acorn, Exhaust Mounting, 5/16-24, Evolution, Twin-Cam	4	<b>681-4223</b>
	JGI-65324-83-N2	Nut, Heavy-Duty Flange, Exhaust Mounting, 5/16-24, Evolution, Twin-Cam	4	<b>681-4224</b>
<b>CARB AND EFI GASKETS</b>				
11351	JGI-11351	O-ring, Fuel Pump Fuel Filter, EFI, '02-07 Softail, Touring	25	<b>681-4246</b>
27237-95	JGI-27237-95	O-ring, Fuel Injector, upper, '99-01 Twin-Cam	10	<b>681-4240</b>
27244-95	JGI-27244-95	O-ring, Fuel Injector, Center, '99-01 Twin-Cam	10	<b>681-4241</b>
27964-00	JGI-27964-00	Gasket, Carburetor Back Plate, '99-up Twin-Cam w/S.E. 43 EFI Ind. Mod.	10	<b>681-4243</b>
29062-95B	JGI-29062-95-B	Gasket, Carburetor Back Plate, '99-06 Twin-Cam (except 2006Dyna)	10	<b>681-4244</b>
29368-99	JGI-29368-99	Gasket, Induction Module to Back Plate, '99-01 Touring w/E.F.I.	10	<b>681-4242</b>
62172-02	JGI-62172-02	Gasket, Fuel Valve Assembly, Viton, '02-06	5	<b>681-4245</b>
<b>PRIMARY HOUSING GASKETS</b>				
11324	JGI-11324	O-Ring, Drain Plug, Primary Cover, Viton, '04-06	10	<b>681-4275</b>
12052B	JGI-12052-A	Oil Seal, Inner Chain Cover, '05-up	5	<b>681-4273</b>
25416-99C	JGI-25416-99-F	Gasket, Clutch Derby Cover, Foamet w/Bead, '99-05 Twin-Cam	5	<b>681-4266</b>
25416-99A	JGI-25416-99	O-Ring, Clutch Derby Cover, '99-up Twin-Cam	5	<b>681-4267</b>
25416-99B	JGI-25416-99-X	Gasket, Clutch Derby Cover, .030" Paper with Bead, '99-05 Twin-Cam	5	<b>681-4269</b>
25416-99C	JGI-25416-06-X	Gasket, Clutch Derby Cover, Paper w/Bead, '06-up Softail/Dyna Touring	5	<b>681-4268</b>
34901-07	JGI-34901-07-F	Gasket, Primary Cover, Foamet, '07-16 Touring Models	1	<b>681-4260</b>
34901-07	JGI-34901-07	Gasket, Primary Cover, '07-16 Touring Models	5	<b>681-4261</b>
34901-94	JGI-34901-94	Gasket, Primary Cover, .062" Paper with Bead, '94-06 FLT, FXR	5	<b>681-4264</b>
34934-06	JGI-34934-06	Gasket, Primary to Engine Interface, '06-17 Softail/Dyna '06-16 Touring	1	<b>681-4271</b>
60539-94B	JGI-60539-94	Gasket, Primary Cover, .062" Paper with Bead, '94-06 Softail, 94-05 Dyna	5	<b>681-4265</b>
60547-06	JGI-60547-06-F	Gasket, Primary Cover, Foamet, '06-up Dyna, '07-up Softail	1	<b>681-4262</b>
60547-06	JGI-60547-06	Gasket, Primary Cover, Paper w/Bead, '06-up Dyna, '07-up Softail	5	<b>681-4263</b>
63869-06	JGI-63869-06	Gasket, Inner to Outer Primary, Shift Boss, '06-up Dyna	5	<b>681-4272</b>
786A	JGI-31434-06	Seal, Inner Primary to Motor, Use w/Bolt 786A '06-up Dyna	10	<b>681-4274</b>
	JGI-25416-06-F	Gasket, Clutch Derby Cover, Foamet, '06-up Softail, Dyna, Touring	5	<b>681-4276</b>
	JGI-17369-06	Gasket, Derby Cover, '06-up	1	<b>681-4270</b>
<b>TRANSMISSION GASKETS</b>				
7078	JGI-7078	Spacer, Shifter Shaft, '06-17 Dyna	10	<b>681-4313</b>
11201	JGI-11201	O-Ring, Main Drive Gear, '06-up Dyna, '07-up Dyna-Touring	10	<b>681-4311</b>
11290	JGI-11290	O-ring, Neutral Gear Switch, '99-05 Dyna 99-06 Softail/ Touring Twin-Cam	10	<b>681-4315</b>
12074	JGI-12074	Oil Seal, Transmission Main Drive, 06-17	1	<b>681-4308</b>
12077	JGI-12077	Oil Seal, Main Drive Gear End, '06-up	5	<b>681-4309</b>
26072-99A	JGI-26072-99	Gasket, Transmission Oil Pan, Paper with Bead, '99-17Dyna	5	<b>681-4304</b>
26072-99	JGI-26072-99-X	Gasket, Transmission Oil Pan, RCM w/Bead, '99-17 Dyna	1	<b>681-4305</b>
26077-99A	JGI-26077-99	Gasket, Transmission/Engine Oil Pan, '99-16 Touring Models	5	<b>681-4306</b>
34904-86D	JGI-34904-00-X	Gasket, Transmission Top Cover, Paper with Bead, '99-06 FLT, FXR 5-Speed	5	<b>681-4292</b>
34917-06	JGI-34917-06-F	Gasket, Transmission Top Cover, Foamet, '06-17 Dyna, '07-17 Softail, '07-16 Touring	5	<b>681-4290</b>
34917-06	JGI-34917-06-X	Gasket, Transmission Top Cover, RCM w/Bead, '06-17 Dyna, '07-17 Softail, '07-16 Touring	1	<b>681-4291</b>
34917-90	JGI-34917-90	Gasket, Transmission Top Cover, '91-05 Dyna	10	<b>681-4294</b>
34917-90	JGI-34917-90-X	Gasket, Transmission Top Cover, Paper with Bead, '91-05 Dyna	5	<b>681-4295</b>
34917-99	JGI-34917-99	Gasket, Transmission Top Cover, '99-06 Twin-Cam except '06 Dyna	5	<b>681-4293</b>



**TWIN CAM GASKETS & SEALS**

- WINDSHIELDS / FAIRINGS
- AUDIO / COMMUNICATION
- SEATS / LUGGAGE
- BAR / MIRRORS / CONTROLS
- EXHAUST
- AIR / FUEL SYSTEMS
- ENGINE
- TRANSMISSION / DRIVELINE
- GASKETS / SEALS**
- ELECTRICAL
- LIGHTING
- CABLES
- BRAKES
- OIL FILTERS
- SUSPENSION
- BODY
- WHEELS
- TIRES / TIRE ACC.
- BIKE ACC.
- VICTORY / INDIAN
- COVERS / LOCKS / TIEDOWNS
- CHEMICALS
- TOOLS
- HELMETS
- HELMET ACC.
- EYEWEAR
- APPAREL / RIDER ACC.
- PROMOTIONAL
- REFERENCE
- INDEX

OEM#	JGI#	Application	Quantity	WPS#
<b>TWIN CAM INDIVIDUAL GASKETS, SEALS, O-RINGS 99-UP</b>				
<b>TRANSMISSION GASKETS (CONT'D...)</b>				
35147-03	JGI-35147-03-F	Gasket, Bearing Cover, Foamet, Screamin' Eagle 6-Speed Transmission	1	<b>681-4300</b>
35147-03	JGI-35147-03-X	Gasket, Bearing Cover, RCM w/Bead, Screamin' Eagle 6-Speed Transmission	1	<b>681-4301</b>
35148-03	JGI-35148-03-F	Gasket, Clutch Release Cover, Foamet, Screamin' Eagle 6-Speed Transmission	5	<b>681-4298</b>
35148-03	JGI-35148-03-X	Gasket, Clutch Release Cover, RCM w/Bead, Screamin' Eagle 6-Speed Transmission	1	<b>681-4299</b>
35607-06	JGI-35607-06	Seal, Trans. to Engine Interface, '06-up Dyna, '07-up Dyna-Touring	1	<b>681-4314</b>
35653-98	JGI-35653-98	Gasket, Transmission Bearing Cover with Bead, '99-up Twin-Cam	5	<b>681-4307</b>
35654-06	JGI-35654-06-F	Gasket, Transmission Bearing Cover, Foamet, '06-up Dyna '07-up all models	1	<b>681-4302</b>
35654-06	JGI-35654-06-X	Gasket, Transmission Bearing Cover, RCM w/Bead, '06-up Dyna, '07-up all models	1	<b>681-4303</b>
36805-06	JGI-36805-06-F	Gasket, Clutch Release Cover, Foamet, '06-up Dyna, '07-up all models	5	<b>681-4296</b>
36805-06	JGI-36805-06-X	Gasket, Clutch Release Cover, RCM w/Bead, '06-up Dyna '07-up all models	1	<b>681-4297</b>
37101-84	JGI-37101-84-B	Oil Seal, Clutch Release Lever, '06-08 Dyna, '07-08 Softail-Touring	5	<b>681-4312</b>
	JGI-34917-99-F	Gasket, Transmission Top Cover Foamet, '99-06 Twin-Cam except '06 Dyna	1	<b>681-4317</b>
	JGI-34917-90-F	Gasket, Transmission Top Cover, Foamet, '91-05 Dyna	5	<b>681-4316</b>
	JGI-12077-1	Oil Seal, Main Drive Gear End, '06-up Dyna	1	<b>681-4310</b>
<b>MISCELLANEOUS GASKETS, SEALS, AND O-RINGS</b>				
11297	JGI-11297	O-ring, Rear Shock Air Control, '99-up Twin Cam	10	<b>681-4333</b>
27444-00Y	JGI-27444-00-Y	O-Ring, Starter Motor to Crankcase, Viton, '06-up Dyna	5	<b>681-4330</b>
31695-90	JGI-31695-90	O-Ring, Starter Motor Yoke Assy., '90-08 Softail, Dyna, Touring	2	<b>681-4331</b>
46175-00	JGI-46175-00	Oil Seal, Front Fork, '00-up Softail Deuce FXSTD	2	<b>681-4339</b>
46508-01	JGI-46508-01	O-ring, Fork Tube Cap, 01-up V-Rod, '06-up Dyna	10	<b>681-4334</b>
46512-01	JGI-46512-01	Oil Seal, Dust Seal, Front Fork, '01-up V-Rod, '06-up Dyna	2	<b>681-4337</b>
46514-01	JGI-46514-01	Oil Seal, Front Fork, '01-up V-Rod, '06-up Dyna '14-Up Touring	2	<b>681-4338</b>
46515-01	JGI-46515-01	Spacer, Oil Seal, Front Fork 01-up VRSCA/D, '06-up Dyna '14-Up Touring	2	<b>681-4335</b>
46516-01	JGI-46513-01	Retaining Ring, Fork Seal '01-up 49mm	6	<b>681-4340</b>
46615-06	JGI-46615-06	Washer, Fork Leg, Copper, '06-up Dyna 14-Up Touring	6	<b>681-4336</b>
	JGI-11246	O-ring, Fuel Tank Check Valve, '99-up Twin Cam 88 with E.F.I.	10	<b>681-4332</b>



# EVOLUTION BIG TWIN GASKETS & SEALS

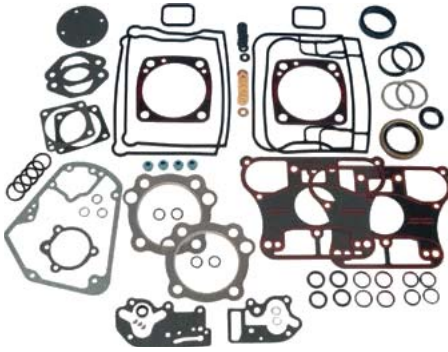

- Genuine James Gaskets uses state of the art materials and production methods to make the best gaskets available
- Comprehensive gasket kits for many applications as well as individual gaskets are available
- Various material choices available depending on application
- FOAMET - foam covered metal
- MLS - multi layered steel
- RCM - rubber covered metal
- Micropore paper gaskets with or without elastomer bead (Nitrile or Silicone)
- Made in the U.S.A.

OEM#	JGI#	Application	Quantity	WPS#
<b>EVOLUTION BIG TWIN GASKET KITS</b>				
17033-83A	JGI-17033-83-MLS	Gasket Kit, Top End, w/MLS Head Gaskets, '84-91 Evo	Kit	<b>681-4386</b>
17033-83A	JGI-17033-83-A	Gasket Kit, Top End, w/Rubber Rocker Cover Gaskets, '84-91 1340cc Evo	Kit	<b>681-4387</b>
17033-83A	JGI-17033-83	Gasket Kit, Top End, w/Cork Rocker Cover Gaskets, '84-91 1340cc Evo	Kit	<b>681-4388</b>
17033-83A	JGI-17033-83-R	Gasket Kit, Cork Rocker Cover, Paper Base-Rocker, '84-91 1340cc Evo	Kit	<b>681-4397</b>
17035-83	JGI-17035-83-MLS	Gasket Kit, Motor, w/MLS Head Gaskets, '84-91 1340cc Evo '84-91 1340cc Evo	Kit	<b>681-4382</b>
17035-83	JGI-17035-83-B	Gasket Kit, Motor, w/Metal Base-Rocker, '84-91 1340cc Evo	Kit	<b>681-4383</b>
17040-92	JGI-17040-92-MLS	Gasket Kit, Top End, w/0.045" MLS Head Gaskets, '92-99 '80" Evo	Kit	<b>681-4384</b>
17040-92	JGI-17040-92	Gasket Kit, Top End, '92-99 '80" Evo	Kit	<b>681-4385</b>
17041-92	JGI-17041-92-MLS	Gasket Kit, Motor, w/MLS Head Gaskets, '92-99 Evolution	Kit	<b>681-4380</b>
17041-92	JGI-17041-92-A	Gasket Kit, Motor, w/Metal Base-Rocker Cover Gaskets, '92-99 Evolution	Kit	<b>681-4381</b>
	JGI-17033-92	Gasket Kit, Top End, w/Metal Base-Rocker, '92-up 3-5/8" Bore Evo	Kit	<b>681-4389</b>
	JGI-17033-83-S	Gasket Kit, Top End, w/Metal Base-Rocker, '84-91 3-5/8" Bore Evo	Kit	<b>681-4390</b>
	JGI-16770-84-A	Gasket Set, Cylinder Head .045"-Base .030", '84-99 1200cc-1340cc	Kit	<b>681-4391</b>
	JGI-16770-86-S	Gasket Set, Cylinder Head-Base, .062" w/Armor, 3-5/8" Bore Cylinders	Kit	<b>681-4392</b>
	JGI-17042-92-X	Gasket Kit, Rocker Cover, w/Metal Rocker Base Gaskets, '92-99 Evolution	Kit	<b>681-4393</b>
	JGI-17042-92	Gasket Kit, Rocker Cover, w/Paper Rocker Base Gaskets, '92-99 Evolution	Kit	<b>681-4394</b>
	JGI-17038-90-X	Gasket Kit, Rocker Cover, w/Metal Rocker Base Gaskets, '84-91 1340cc Evo	Kit	<b>681-4395</b>
	JGI-17038-90	Gasket Kit, Rocker Cover, w/Paper Rocker Base Gaskets, '84-91 1340cc Evo	Kit	<b>681-4396</b>
	JGI-11133-V2	O-ring Kit, Pushrod Tube, '84-99, FLT, FXR, Softail	Kit	<b>681-4398</b>
	JGI-25225-93-KX	Gasket-Seal Kit, Cam Quick Change, Metal Core w/Bead, '93-99 Evo	Kit	<b>681-4399</b>
	JGI-25225-93-K	Gasket-Seal Kit, Cam Quick Change, '93-99 Evo	Kit	<b>681-4400</b>
	JGI-25225-70-KX	Gasket-Seal Kit, Quick Change, Metal w/Bead, 70-92 FLT, FXR, Softail	Kit	<b>681-4401</b>
	JGI-25225-70-K	Gasket-Seal Kit Cam Cover, 70-92 FL, FLH, FLT, FXR, SOFTAIL	Kit	<b>681-4402</b>
	JGI-92-FLHR	Gasket-Seal Kit, Oil Pump w/Metal Gaskets, '92-99 Evolution	Kit	<b>681-4403</b>
	JGI-92-FLH	Gasket-Seal Kit, Oil Pump, '92-99 Evolution	Kit	<b>681-4404</b>
	JGI-81-FL	Gasket-Seal Kit, Oil Pump, Mylar, '81-91 FLH, FLT, FXR, Softail	Kit	<b>681-4405</b>
	JGI-81-FLH	Gasket-Seal Kit, Oil Pump, Paper, '81-91 FLH, FXB, FXEF	Kit	<b>681-4406</b>
	JGI-60539-89-KX	Gasket Kit, Primary Cover, .062" Paperw/Bead, '89-93 Softail, Dyna	Kit	<b>681-4038</b>
	JGI-60539-94-K	Gasket Kit, Primary Cover, .062" Paper, '94-06 Softail '94-05 Dyna	Kit	<b>681-4039</b>
	JGI-34901-94-K	Gasket-Seal Kit, Primary Cover, '94-99 FLT, FXR	Kit	<b>681-4035</b>
	JGI-34901-85-K	Gasket-Seal Kit, Primary Cover, '80-93 FLT, FXR	Kit	<b>681-4407</b>
	JGI-25416-85-K	Gasket Kit, Inspection-Clutch Derby Cover, '85-98 Big Twin	Kit	<b>681-4408</b>
	JGI-25416-70-K	Gasket Kit, Inspection-Clutch Derby Cover, 70-98 Big Twin	Kit	<b>681-4409</b>
	JGI-33031-85	Gasket-Seal Kit, Transmission, '80-99 5-Speed (w/o Oil Pan)	Kit	<b>681-4410</b>
	JGI-33031-91	Gasket-Seal Kit, Transmission, '91-99 5-Speed Dyna	Kit	<b>681-4411</b>
	JGI-33031-70	Gasket-Seal Kit, Transmission, '84-86 4-Speed	Kit	<b>681-4412</b>
	JGI-33031-93	Gasket-Seal Kit, Transmission, '93-98 5 Speed FLT	Kit	<b>681-4413</b>
	JGI-12067-AK	Oil Seal Kit, Transmission Sprocket, '94-99 FLT, FXR, Softail	Kit	<b>681-4414</b>
	JGI-12050-K	Oil Seal Kit, Transmission Sprocket, '84-92 FLT, FXR, Softail	Kit	<b>681-4415</b>
	JGI-37741-82-K	Oil Seal Kit, Transmission Main Seal, 4-Speed, '82-85 FLH-80, FLH Classic	Kit	<b>681-4416</b>
	JGI-12014-K	Seal Kit, Clutch Hub Nut, '84-90 FL, FX	Kit	<b>681-4417</b>
	JGI-45849-84	Oil Seal Kit, Front Fork, '84-99 FLT, FLTC, FXST, FLHT, FLST, FXSTC, FLHS	Kit	<b>681-4418</b>
	JGI-45849-87	Oil Seal Kit, Front Fork, '87-up FXR and Dynaw/39mm Forks	Kit	<b>681-4419</b>
	JGI-45849-84-A	Oil Seal Kit, Front Fork, '84-92 FXR	Kit	<b>681-4420</b>
	JGI-45790-80-CS	Screw Kit, Fork Drain, Chrome Cap Screws-Seal Washers, '94-99 Dyna, '99-00 FXR	Kit	<b>681-4421</b>
	JGI-45849-84-K	Gasket-Seal Kit, Fork Air Control, '83-92 FL, FXR	Kit	<b>681-4422</b>
	JGI-27006-88	Gasket-Seal Kit, Carburetor Overhaul, '88-up Evo	Kit	<b>681-4423</b>
	JGI-27002-89-K	Seal Kit, Intake Manifold, '89-99 FLT, FXR, Softail	Kit	<b>681-4424</b>
	JGI-29062-95-K	Gasket Kit, Air Cleaner Backplate, '95-99 Softail, Dyna	Kit	<b>681-4425</b>

- WINDSHIELDS / FAIRINGS
- AUDIO / COMMUNICATION
- SEATS / LUGGAGE
- BARS / MIRRORS / CONTROLS
- EXHAUST
- AIR / FUEL SYSTEMS
- ENGINE
- TRANSMISSION / DRIVELINE
- GASKETS / SEALS**
- ELECTRICAL
- LIGHTING
- CABLES
- BRAKES
- OIL FILTERS
- SUSPENSION
- BODY
- WHEELS
- TIRES / TIRE ACC.
- BIKE ACC.
- VICTORY / INDIAN
- COVERS / LOCKS / TIEDOWNS
- CHEMICALS
- TOOLS
- HELMETS
- HELMET ACC.
- EYEWEAR
- APPAREL / RIDER ACC.
- PROMOTIONAL
- REFERENCE
- INDEX



# EVOLUTION BIG TWIN GASKETS & SEALS

WINDSHIELDS / FAIRINGS  
AUDIO / COMMUNICATION  
SEATS / LUGGAGE  
BARS / MIRRORS / CONTROLS  
EXHAUST  
AIR / FUEL SYSTEMS  
ENGINE  
TRANSMISSION / DRIVELINE  
GASKETS / SEALS  
ELECTRICAL  
LIGHTING  
CABLES  
BRAKES  
OIL FILTERS  
SUSPENSION  
BODY  
WHEELS  
TIRES / TIRE ACC.  
BIKE ACC.  
VICTORY / INDIAN  
COVERS / LOCKS / TIEDOWNS  
CHEMICALS  
TOOLS  
HELMETS  
HELMET ACC.  
EYEWEAR  
APPAREL / RIDER ACC.  
PROMOTIONAL  
REFERENCE  
INDEX

OEM#	JGI#	Application	Quantity	WPS#
<b>EVOLUTION INDIVIDUAL GASKETS, SEALS, O-RINGS '84-UP</b>				
<b>ROCKER BOX ASSEMBLY GASKETS</b>				
16779-84B	JGI-16779-84-X	Gasket, Rocker Cover Base, One Piece, Paper w/Bead, '84-99 Evo	2	681-4449
16779-99	JGI-16779-99-X	Gasket, Rocker Cover Base, One Piece, RCM w/Bead, '84-99 Evo	2	681-4448
17355-84	JGI-17355-84	Gasket, Rocker Cover, Lower, Cork, '84-91 Evo	5	681-4446
17355-84A	JGI-17355-84-A	Gasket, Rocker Cover, Lower, Rubber, '84-91 Evo	5	681-4444
17355-92	JGI-17355-92	Gasket, Rocker Cover, Lower, Rubber, '92-99 Evo	5	681-4441
17356-84	JGI-17356-84	Gasket, Rocker Cover, upper, Cork, '84-91 Evo	5	681-4445
17356-84A	JGI-17356-84-A	Gasket, Rocker Cover, upper, Rubber, '84-91 Evo	5	681-4443
17356-92	JGI-17356-92	Gasket, Rocker Cover, upper, Rubber, '92-99 Evo	5	681-4440
17358-84	JGI-17358-84	Gasket, Rocker Cover, Center, Cork, '84-91 Evo	10	681-4447
17358-84A	JGI-17358-84-A	Gasket, Rocker Cover, Center, Rubber, '84-99 Evo	10	681-4442
63858-49	JGI-63858-49	Washer, Rocker Cover Screws, Fibre, '84-99 All Models	25	681-4450
	JGI-6114	Washer, Top Rocker Cover, Copper, '883, 1100, 1200, 1340cc	10	681-4451
<b>PUSHROD, TAPPET GASKETS AND VALVE STEM SEALS</b>				
6737	JGI-6737	Washer, Pushrod Tube, '84-99 Evo	20	681-4472
11132	JGI-11132	O-Ring, Pushrod Tube Covers-Multi Use	25	681-4468
11145	JGI-11145	O-ring, Tappet Guide to Pushrod Cover, '84-99 Evo	25	681-4470
11145	JGI-11145-X	Quad Seal, Tappet Guide to Pushrod Cover, '84-99 Evo	25	681-4471
11157	JGI-11157	O-ring, Pushrod Cover to Rocker Cover, '84-99, FLT, FXR, Softail	25	681-4469
18633-48C	JGI-18633-48-A/C	Gasket, Tappet Block, Rear, .031" Paper, '84-90 Evo	10	681-4467
18633-48D	JGI-18633-48-X	Gasket, Tappet Block, Rear, .020" RCM w/Bead '91-99 Evo	5	681-4461
18633-48D	JGI-18633-48-D	Gasket, Tappet Block, Rear, .020" Paper '91-99 Evo	10	681-4463
18634-48C	JGI-18634-48-X	Gasket, Tappet Block, Front, .020" RCM w/Bead '91-99 Evo	5	681-4460
18634-48C	JGI-18634-48-C	Gasket, Tappet Block, Front, .020" Paper '91-99 Evo	10	681-4462
18634-48C	JGI-18634-48-A/B	Gasket, Tappet Block, Front, .031" Paper, '84-90 Evo	10	681-4466
6762B	JGI-6762-B	Washer Pushrod Tube Spring Backup, '84-99 Evo	20	681-4473
	JGI-18634-48-F	Gasket, Tappet Block, Front, Foamet® '84-90 Evo	5	681-4464
	JGI-18633-48-F	Gasket, Tappet Block, Rear, .Foamet®, '84-90 Evo	5	681-4465
<b>HEAD AND BASE GASKETS</b>				
16770-84B	JGI-16770-84-MLS	Gasket, Cylinder Head, .045" MLS Head w/RCM Base, Evo 1340cc	2	681-4480
16770-84B	JGI-16770-84-B	Gasket, Cylinder Head, .045" Graphite w/Firering, '84-99 1200cc-1340cc	5	681-4483
16770-84B	JGI-16770-84-X	Gasket, Cylinder Head, .032" Graphite w/Firering, '84-99 1200cc-1340cc	2	681-4484
16773-85	JGI-16773-85	Gasket, Cylinder Head, .062"w/Armor, Evo	5	681-4481
16773-85	JGI-16773-85-T	Gasket, Cylinder Head, .045"w/Armor, Evo	5	681-4482
16773-85	JGI-16773-85-TS	Gasket, Cylinder Head, .045"w/Armor, 3-5/8" Bore Cylinders	5	681-4485
16777-83A	JGI-16777-94	Gasket, Cylinder Base, Front-Rear, .020" Metalw/Bead 1340cc Evo	2	681-4488
16777-83A	JGI-16777-83-A	Gasket, Cylinder Base, Front-Rear, .020" Paper 1340cc Evo	10	681-4489
26432-76A	JGI-26432-76-A	O-ring, Cylinder Head Locating, Usew/.032"-.045" Evo Head Gaskets	10	681-4486
26432-76A	JGI-26432-76-X	O-ring, Cylinder Head Locating, Usew/.045"-.062" Evo Head Gaskets	10	681-4487
	JGI-16777-94-S	Gasket, Cylinder Base, Front-Rear, .020" Metalw/Bead 3-5/8" Bore Evo	2	681-4490
	JGI-16777-86-S	Gasket, Cylinder Base, Front-Rear, .020" Paper 3-5/8" Bore Evo	5	681-4491
<b>MOTOR CASE O-RINGS AND SEALS</b>				
12026A	JGI-12026-A	Oil Seal, Motor Sprocket Shaft, '84-99 FLT, FXR, Softail, Dyna	5	681-4501
<b>OIL AND OIL PUMP GASKETS</b>				
8866	JGI-8866	Ball Bearing, Oil Pump, 3/8" Dia. (a.k.a. 8873), '84-99 FLT, FXR, Softail	10	681-4523
11002	JGI-11002	Snap Ring, Oil Pump Shaft, '84-99 Evo	10	681-4520
11105	JGI-11105	O-Ring, Oil Drain Plug	25	681-4126
11159	JGI-11159	O-ring, Oil Tank Fittings, '84-86 Softail	25	681-4517
11241	JGI-11241	O-ring, Oil Pump Lower Cover, '92-99 Evo	25	681-4516
26273-80B	JGI-26273-80-AM	Gasket, Oil Pump, Body, Mylar, Late '80-91 FLH, FLH-80, FLT, FX, FXR	10	681-4512
26273-80B	JGI-26273-80-B	Gasket, Oil Pump, Body, Black Paper, Late '80-91 FLH, FLH-80, FLT, FX, FXR	10	681-4514
26273-92	JGI-26273-92	Gasket, Oil Pump, Body, Black Paper, '92-99 Evo	10	681-4510
26276-80A	JGI-26276-80-M	Gasket, Oil Pump, Cover, Mylar, '80-91 FLH, FLH-80, FLT, FX, FXR	10	681-4513
26276-80A	JGI-26276-80-A	Gasket, Oil Pump, Cover, Black Paper, Late '80-91 FLH, FLH-80, FLT, FX, FXR	10	681-4515
26276-92	JGI-26276-92	Gasket, Oil Pump, Cover, Black Paper, '92-99 Evo	10	681-4511
26348-15	JGI-26348-15	Key, Oil Pump Shaft, Long, '84-99 FLH, FLT, FXR, Softail	10	681-4521
26348-36	JGI-26348-36	C-Clip, Oil Pump Shaft, '84-99 FLH, FLT, FXR, Softail	10	681-4522
37091-80	JGI-37091-80	Washer, Oil Dip Stick, '84-86 5-Speed Transmissions	10	681-4524

## EVOLUTION BIG TWIN GASKETS &amp; SEALS



OEM#	JGI#	Application	Quantity	WPS#
<b>EVOLUTION INDIVIDUAL GASKETS, SEALS, O-RINGS '84-UP</b>				
<b>OIL AND OIL PUMP GASKETS (CONT'D...)</b>				
62672-90	JGI-62672-90	O-ring, Oil Pan Dipstick, '91-99 Dyna	10	<b>681-4518</b>
62673-90	JGI-62673-90	O-ring, Oil Tank Cap, '91-99 Dyna	10	<b>681-4519</b>
63525-92	JGI-63525-92	Seal, Oil Line Feed Tube, '92-99 Evo	10	<b>681-4525</b>
63528-92	JGI-63528-92	Seal-Ferrule, Oil Line Feed Tube, '92-99 Evo	5	<b>681-4526</b>
<b>CAM HOUSING</b>				
25225-70A	JGI-25225-70-XM	Gasket, Cam Gear Cover, Metal Core/ Bead, '84-92 FLH, FLT, FXR, Softail	1	<b>681-4545</b>
25225-70A	JGI-25225-70-X	Gasket, Cam Gear Cover, Paperw/Bead, '84-92 FLH, FLT, FXR, Softail	5	<b>681-4546</b>
25225-70A	JGI-25225-70-B	Gasket, Cam Gear Cover, Black Paper, '84-92 FLH, FLT, FXR, Softail	10	<b>681-4547</b>
25225-93B	JGI-25225-93-XM	Gasket, Cam Gear Cover, Metal Corew/Beading, '93-99 1340cc Evo	1	<b>681-4541</b>
25225-93B	JGI-25225-93-X	Gasket, Cam Gear Cover, Paperw/Bead, '93-99 1340cc Evo	5	<b>681-4542</b>
25225-93B	JGI-25225-93	Gasket, Cam Gear Cover, Black Paper, '93-99 1340cc Evo	10	<b>681-4543</b>
83162-51	JGI-83162-51	Oil Seal, Cam Gear Shaft, Metal O.D., '84-99 FLH, FLT, FXR, Softail	5	<b>681-4548</b>
83162-51	JGI-83162-51-DL	Oil Seal, Cam Gear Shaft, Rubber O.D., '84-99 FLH, FLT, FXR, Softail	5	<b>681-4549</b>
	JGI-25225-93-XF	Gasket, Cam Gear Cover, Foamet®, '93-99 1340cc Evo	5	<b>681-4540</b>
	JGI-25225-70-XF	Gasket, Cam Gear Cover, Foamet, '84-92 FLH, FLT, FXR, Softail	5	<b>681-4544</b>
<b>INTAKE AND EXHAUST GASKETS</b>				
738	JGI-738	Plug, Air Cleaner Cover, '86-99 Evo	10	<b>681-4572</b>
26995-86A	JGI-26995-86-A	Seal, Intake Manifold, '86-99 Evo	10	<b>681-4562</b>
26995-86A	JGI-26995-97-X	Seal, Intake Manifold, w/Rubber Lip, '86-99 Evo	10	<b>681-4563</b>
26995-86A	JGI-26995-98	Seal, Intake Manifold, w/Rubber/Metal Lip, '86-99 Evo	10	<b>681-4564</b>
27002-89	JGI-27002-89	Seal, Carburetor to Manifold, '89-99 FLT, FXR, Softail	1	<b>681-4565</b>
27077-78	JGI-27077-78	Gasket, Intake Manifold to Carburetor, '84-89 FLH, FLT, FXR	10	<b>681-4560</b>
27077-78	JGI-27077-78-X	Gasket, Intake Manifold to Carb., Metalw/Bead, '84-89 FLH, FLT, FXR	10	<b>681-4561</b>
29058-77	JGI-29058-77	Gasket, Air Cleaner, .030" Paper, '84-87 FX, FXR, FLT, Softail	10	<b>681-4570</b>
29059-88	JGI-29059-88-X	Gasket, Air Cleaner, Steel Core, '88-99 FLT, FXR, Softail	5	<b>681-4567</b>
29059-88	JGI-29059-88	Gasket, Air Cleaner, .030" Paper, '88-99 FLT, FXR, Softail	10	<b>681-4568</b>
29059-88	JGI-29059-88-A	Gasket, Air Cleaner, .030" Paper w/Adhesive, '88-99 FLT, FXR, Softail	10	<b>681-4569</b>
29095-95	JGI-29095-95	Gasket, Air Cleaner, '95-98 Models/w.E.F.I.	10	<b>681-4571</b>
29242-83	JGI-29242-83	Gasket, Compliance Fitting, '84-89 FLH, FLT, FXR	10	<b>681-4566</b>
65234-83A	JGI-65234-83-A	Gasket, Exhaust Pipe to Cylinder Head, '92-up, All Models Tapered	5	<b>681-4226</b>
65324-83	JGI-65324-83	Gasket, Exhaust Pipe to Cylinder Head, '84-up, All Models Square	10	<b>681-4227</b>
65721-85	JGI-65721-85	Gasket, Muffler Clamp, Copper, '85-99 FLT	10	<b>681-4575</b>
65781-82	JGI-65781-82	Gasket, Exhaust Inter-Connect, '84-99 FXR, Softail	2	<b>681-4574</b>
65826-90	JGI-65826-90	Gasket, Exhaust Inter-Connect, '91-99 Dyna	2	<b>681-4573</b>
<b>CARB AND EFI GASKETS</b>				
11447	JGI-11447	Grommet, Fuel Tank Mounting, '84-99 Softail	12	<b>681-4602</b>
27121-89	JGI-27121-89	O-ring, Carb Float Bowl, Viton, '88-99 FXR, Softail	10	<b>681-4597</b>
27157-89	JGI-27157-89	O-ring, Carburetor Drain Screw, CV Carburetor, '89-91 Evo	10	<b>681-4600</b>
27311-76A	JGI-27311-76-A	Boot, Carburetor, Accelerator Pump, '84-99 Big Twin	10	<b>681-4592</b>
27360-76	JGI-27360-76	U-Rings, Accelerator Pump Housing, '84-89 Keihin Carb	20	<b>681-4591</b>
27361-76	JGI-27361-76	Diaphragm, Accelerator Pump, '84-89 Keihin Carb	1	<b>681-4590</b>
27385-76	JGI-27385-76	Plug, Low Speed Jet, '84-89 Keihin Carb	5	<b>681-4594</b>
27577-88	JGI-27577-88	O-ring, Float Bowl to Carburetor Body, '88-91 FLT, FXR, Softail	5	<b>681-4599</b>
27577-92	JGI-27577-92	O-ring, Float Bowl to Carburetor Body, '92-99 FLT, FXR, Softail	5	<b>681-4598</b>
61109-85C	JGI-61109-85-C	O-ring, Fuel Cap, '85-99 FXR Models, Softail	10	<b>681-4595</b>
61192-88	JGI-61192-88	O-ring, Fuel Cap/Gauge, '88-99 FXR, '91-99 Dyna	10	<b>681-4596</b>
61326-95	JGI-61326-95	Gasket, Fuel Tank Canopy, Cork, '95-99 E.F.I. Models	5	<b>681-4601</b>
62172-75	JGI-62172-75	Gasket, Fuel Valve Assembly, '84-99 FLH, FXR, Softail	20	<b>681-4593</b>
<b>PRIMARY HOUSING GASKETS</b>				
6057	JGI-6057	Washer, Black Nylon, Shifter Lever, '90-99 Softail	10	<b>681-4638</b>
11147	JGI-11147	O-ring, Inner Chain Cover to Motor, '84-99 FLT, FXR, Softail	10	<b>681-4625</b>
12052	JGI-12052-F	Oil Seal, Inner Chain Cover, Single Lip, '84-96 FLT, FXR, Softail	5	<b>681-4629</b>
12052	JGI-12052	Oil Seal, Inner Chain Cover, Double Lip, '84-99 FLT, FXR, Softail	5	<b>681-4630</b>
12053	JGI-12053	Oil Seal, Starter Motor Shaft, '89-94 FLT, FXR, Softail	5	<b>681-4634</b>
12053	JGI-12053-A	Oil Seal, Starter Motor Shaft, '89-94 FLT, FXR, Softail	5	<b>681-4635</b>
12066	JGI-12066-A	Oil Seal, Starter Shaft, Double Lip, '94-99 FLT, FXR, Softail, Dyna	5	<b>681-4633</b>
25416-70	JGI-25416-70-DL	Gasket, Clutch Derby Cover, Molded Rubber on Steel, '84-98 FL, FX	1	<b>681-4622</b>



# EVOLUTION BIG TWIN GASKETS & SEALS

OEM#	JGI#	Application	Quantity	WPS#
<b>EVOLUTION INDIVIDUAL GASKETS, SEALS, O-RINGS '84-UP</b>				
<b>PRIMARY HOUSING GASKETS (CONT'D...)</b>				
25416-84	JGI-25416-84-X	Quad Seal, Clutch Derby Cover, '84-99 Softail, Dyna	10	681-4620
25416-84	JGI-25416-84	O-ring, Clutch Derby Cover, '84-92 Softail, Dyna	10	681-4621
31341-80	JGI-31341-80-DL	Oil Seal, Starter Shaft, '84-86 FLH-80, Sturgis	5	681-4636
31433-84	JGI-31433-84	Washer, Clutch Cover, Nylon, '84-99 FLT, FXR	20	681-4626
31433-84A	JGI-31433-84-A	Washer, Clutch Cover, w/Rubber I.D., '84-99 FLT, FXR	20	681-4627
33318-85	JGI-33318-85	Lock Tab, Inner Primary Cover, '85-99 Softail, Dyna	10	681-4631
33340-90	JGI-33340-90	O-ring, Starter Motor Shaft Bolt, '90-99 FLT, FXR, Softail	25	681-4637
33345-89	JGI-33345-89	O-ring, Starter Motor Shaft Bolt, '89 ONLY FLT, FXR, Softail	10	681-4632
34901-79	JGI-34901-79-B	Gasket, Primary Cover, .062" Paperw/Bead, '84-93 FLT, FXR	5	681-4611
34901-79	JGI-34901-79-A	Gasket, Primary Cover, .062" Paper, Late '84-93 FLT, FXR	5	681-4612
34901-94	JGI-34901-94	Gasket, Primary Cover, .062" Paperw/Bead, '94-99 FLT, FXR	5	681-4264
34902-79A	JGI-34902-79-A	Gasket, Inner Primary to Transmission, Large, .030" Paper, '84-85 FLT, FXR	10	681-4623
34903-79	JGI-34903-79	Gasket, Inner Primary to Transmission, Small, .030" Paper, '84-85 FLT, FXR	10	681-4624
34906-79	JGI-34906-79-A	Gasket, Primary Inspection Cover, .062" Paperw/Bead, Late '84-99 FLT, FXR	5	681-4618
34906-85	JGI-34906-85-X	Gasket, Primary Inspection Cover, Steel Corew/Bead, '85-99 FLT, FXR	5	681-4616
34906-85	JGI-34906-85	Gasket, Primary Inspection Cover, .062" Paperw/Bead, '85-99 FLT, FXR	5	681-4617
34906-85	JGI-34906-85-DL	Seal, Primary Inspection Cover, Molded Rubber/Steel, '85-99 FLT, FXR	1	681-4619
50100-70	JGI-50100-70	Bumper Pad, Primary/Kickstand, Rubber w/Adhesive, '84-92 FLH, FX, Softail	10	681-4639
60539-89	JGI-60539-89-X	Gasket, Primary Cover, .062" Paperw/Bead, '89-99 Softail, Dyna	5	681-4610
60539-94	JGI-60539-94	Gasket, Primary Cover, .062" Paperw/Bead, '94-99 Softail, Dyna	5	681-4265
60567-65	JGI-60567-65-B	Gasket, Inspection Cover, .062" Paper, Bead 2 Sides, '84-99 FLH, FX, FXE	5	681-4614
60567-90	JGI-60567-90-F	Gasket, Inspection Cover, Foamert w/Bead, '84-99 FLH, FX, FXE	5	681-4613
60567-90	JGI-60567-90	Gasket, Inspection Cover, .062" Paper, Bead 1 Side, '84-99 FLH, FX, FXE	5	681-4615
63859-95	JGI-63859-95	Washer, Inner Chain Cover, w/Adhesive Backing, '95-99 Softail	32	681-4628
	JGI-34906-85-F	Gasket, Primary Inspection Cover, Foamert, '85-99 FLT, FXR	5	681-4641
<b>TRANSMISSION GASKETS</b>				
6007	JGI-6007	Washer, Transmission Drain Plug, '84-99 FLT, FXR, Softail	10	681-4691
11117	JGI-11117	O-ring, Shifter Lever Sleeve, Late '84-99 5-Speed	25	681-4687
11148	JGI-11148	Quad Seal, Shifter Lever Sleeve, '84-86 FXR	25	681-4688
11162	JGI-11162	O-ring, Transmission Main Shaft Right End, Late '84-86 FXRs, FXRT	25	681-4680
11165	JGI-11165	Quad Seal, Left Side Transmission Spacer, '84-99 FLT, FXR, Softail	25	681-4681
11166	JGI-11166	O-ring, Main Drive Gear, '85 FXST, '85-86 FXWG	25	681-4677
11178	JGI-11178	O-ring, Filler Plug, Transmission End Cover, '87-99 5-Speed	25	681-4684
11179	JGI-11179	O-ring, Clutch Cable at Transmission Cover, '87-99 FLT, FXR, Softail	25	681-4685
11191	JGI-11191	O-ring, Gear Shift Lever, '90-99 Softail	25	681-4686
12035	JGI-12035-B	Oil Seal, Fifth Gear, Blue, '91-99 5-Speed	5	681-4678
12043	JGI-12043	Oil Seal, Rubber O.D., Double Lip, Starter Shaft, '84-86 FLT, FXR, FXRS	5	681-4669
12043	JGI-12043-A	Oil Seal, Metal O.D., Single Lip, '84-86 FLT, FXR, FXRS	5	681-4670
12045	JGI-12045-M	Oil Seal, Metal O.D., 5-Speed Shifter Shaft, '84-99 FLT, FXR, Softail	5	681-4668
12045	JGI-12045-DL	Oil Seal, Rubber O.D., 5-Speed Shifter Shaft, '84-99 Softail, Touring, Dyna	5	681-4671
12050	JGI-12050	Oil Seal, Trans. Main Drive, '84-94 FLT, FXR, Softail	1	681-4672
12051	JGI-12051	Oil Seal, Transmission to Starter, '84-89 FLT, FXR, Softail	5	681-4683
12067	JGI-12067-A	Oil Seal, Transmission Sprocket, '94-99 Softail, Touring	1	681-4679
12013A	JGI-12013	Oil Seal, Main Drive Gear End, Rubber O.D., '85-90 5-Speed	5	681-4673
12013A	JGI-12013-A	Oil Seal, Main Drive Gear End, Metal O.D., '85-90 5-Speed	5	681-4674
26072-90A	JGI-26072-90-X	Gasket, Transmission Oil Pan, Paperw/Bead, '91-98 Dyna	5	681-4664
26072-90A	JGI-26072-90	Gasket, Transmission Oil Pan, '91-98 Dyna	10	681-4665
26077-93	JGI-26077-93	Gasket, Transmission Oil Pan, '93-98 Evo FLT	5	681-4663
33043-80	JGI-33043-80	Washer, Transmission Neutral Switch Mounting, Nylon, '84-99 FLT, FXR, Softail	10	681-4690
33196-79	JGI-33196-79	Gasket, Shift Cover, '84-86 4-Speed	10	681-4662
33295-36	JGI-33295-36-X	Gasket, Transmission End Cover, Paperw/Bead, '84-86 4-Speed	5	681-4656
33295-36	JGI-33295-36	Gasket, Transmission End Cover, Paper, '84-85 4-Speed	10	681-4657
34036-80	JGI-34036-80	O-ring, Transmission Shifter Fork Shaft, 4-Speed, Late '84-85 FLH, FX, FXST	10	681-4689
34824-79	JGI-34824-79	Gasket, Transmission Top Cover, 4-Speed, Late '84-86 FLH, FX, FXST	10	681-4653
34904-79	JGI-34904-79	Gasket, Trans. Top Cover, Paper, '84-85 FLT, FXR 5-Speed	10	681-4652
34904-86	JGI-34904-86-X	Gasket, Trans. Top Cover, Paperw/Bead, '86-99 FLT, FXR 5-Speed	5	681-4650
34904-86	JGI-34904-86	Gasket, Trans. Top Cover, Paper, '86-99 FLT, FXR 5-Speed	10	681-4651



## EVOLUTION BIG TWIN GASKETS &amp; SEALS



OEM#	JGI#	Application	Quantity	WPS#
<b>EVOLUTION INDIVIDUAL GASKETS, SEALS, O-RINGS '84-UP</b>				
<b>TRANSMISSION GASKETS (CONT'D...)</b>				
35652-79	JGI-35652-79-X	Gasket, Trans. Bearing Cover w/Bead, 5-Spd, '84-99 FLT, FXR, Softail	5	681-4654
35652-79	JGI-35652-79-A	Gasket, Transmission Bearing Cover, 5-Speed, '84-99 FLT, FXR, Softail	10	681-4655
36801-79	JGI-36801-79-X	Gasket, Clutch Release Cover, Paperw/Bead, '84-86 FLT, FXR, FXRS	5	681-4660
36801-79	JGI-36801-79	Gasket, Clutch Release Cover, '84-86 FLT, FXR, FXRS	10	681-4661
36801-87	JGI-36801-87-X	Gasket, Clutch Release Cover, Paper w/Bead, '92-99 FLT, FXR, Softail	5	681-4658
36801-87	JGI-36801-87-A	Gasket, Clutch Release Cover, '87-92 FLT, FXR, Softail	10	681-4659
37101-84	JGI-37101-84	Oil Seal, Clutch Release Lever, Late '84-86 5 Speed	1	681-4682
37741-82	JGI-37741-82-A	Oil Seal, Main Drive Gear, Metal O.D., 4-Speed, '84-85 FLH-80, FLH Classic, FX	1	681-4675
37741-82	JGI-37741-82-DL	Oil Seal, Main Drive Gear, Rubber O.D., 4-Speed, '84-85 FLH-80, FLH Classic, FX	1	681-4676
62423-90A	JGI-62423-90	Gasket, Oil Tank Spout, '91-98 Dyna	10	681-4667
62432-93	JGI-62432-93	Gasket, Transmission Oil Spout, '93-99 FLT	10	681-4666
	JGI-34904-86-F	Gasket, Trans. Top Cover, Foamet, '86-99 FLT, FXR 5-Speed	5	681-4696
	JGI-35652-79-F	Gasket, Trans. Bearing Cover Foamet, 5-Spd, '84-99 FLT, FXR, Softail	5	681-4697
	JGI-36801-87-F	Gasket, Clutch Release Cover, Foamet, '92-99 FLT, FXR, Softail	5	681-4699
	JGI-36801-87-AF	Gasket, Clutch Release Cover, Foamet, '87-92 FLT, FXR, Softail	5	681-4698
	JGI-26072-90-F	Gasket, Transmission Oil Pan, Foamet, '91-98 Dyna	1	681-4693
	JGI-62432-93-F	Gasket, Transmission Oil Spout, Foamet, '93-99 FLT	5	681-4700
	JGI-35211-36-DL	Super Nut®, Transmission Sprocket Seal, '84-86 4-Speed	1	681-4692
<b>MISCELLANEOUS GASKETS, SEALS, AND O-RINGS</b>				
6007	JGI-6007-X	Washer Bonded Sealing Metal w/Rubber '80-94 FLT FXR FXRT	6	681-4728
11140	JGI-11140	O-ring, Front Fork Air Control Cap, '84-99 All FLT Models	25	681-4731
11170	JGI-11170	O-ring, Solenoid Mounting Air Control, '85-99 FLT, '91-up FXRT	25	681-4732
11173	JGI-11173	O-ring, Front Wheel Hub Cap, '87-99 FLST/C	25	681-4714
31320-80	JGI-31320-80	Gasket, Starter Cover, '84-86 FXB, FLH-80, Sturgis	10	681-4708
31321-80	JGI-31321-80	Gasket, Starter Housing, '84-86 FXB, FLH-80, Sturgis	10	681-4709
32591-80	JGI-32591-80	Gasket, Ignition Cover, 4 Hole, Paper, '84-99 FLH, FX, FXR, FLT, Softail	10	681-4710
32591-80	JGI-32591-80-F	Gasket, Ignition Cover, 4 Hole, Foamet, '84-99 FLH, FX, FXR, FLT, Softail	5	681-4711
45378-87	JGI-45378-87	Oil Seal, Front Fork, 39mm	1	681-4720
45401-87	JGI-45401-87	Oil Seal, Fork Tube Dust Cover, '88-up 39mm	1	681-4727
45443-86	JGI-45443-86	O-ring, Fork Cap Bracket, '87-99 FLT	10	681-4726
45583-83	JGI-45583-83	Washer, Front Fork Air Control, '87-99 FLT, FXRT, FXRS-SP, FXRS-CON	10	681-4730
45733-48	JGI-45733-48	Seal, Front Tube Plug, '84-99 FLH, FXST, FXST/C, FLST	10	681-4723
45842-77A	JGI-45842-77-A	Retaining Ring, Use w/ Fork Seal	6	681-4722
45845-77	JGI-45845-77	O-ring, Fork Slider Tube, Late '84-up FLH, FLH-80, FXST, FLT, FXWG 41mm	10	681-4724
45846-84	JGI-45846-84	Oil Seal, Fork Tube, '84-99 FLT, FLT Classic, FLHTP (Police)	1	681-4718
45865-84	JGI-45865-84	Washer, Fork Seal Backup '84-99 FL FLH FLT FLT-80	2	681-4729
45875-84	JGI-45875-84	Oil Seal, Front Fork, '84-99 FXST, FXWG	1	681-4719
45905-87	JGI-45905-87	Retaining Ring, Fork Seal, '87-up	6	681-4721
45984-87	JGI-45984-87	O-ring, Fork Tube Cap, '87-91 FXLR, FXRS/SP, XL	10	681-4725
47519-83A	JGI-47519-83-A	Oil Seal, Wheel Bearing, '84-99 Evo	5	681-4712
47519-83A	JGI-47519-83-A2	Oil Seal, Wheel Bearing, '84-99 Evo	2	681-4713
59181-80	JGI-59181-80	Gasket, Lamp Lens, Front Fender, '80-99 FLT, FLSTC, Side Cars, TLE, RLE	10	681-4706
60559-80	JGI-60559-80	Gasket, Starter Motor Mounting, '84-85 FL, FLH, FX, FXST, FXWG	10	681-4707
67096-87	JGI-67096-87	Seal, Speedometer Drive Gear, '87-97 FLT	10	681-4715
67098-87	JGI-67098-87	Seal, Speedometer Drive Gear, '87-up FXRS/SP, FXRT, FXLR, FLHT	10	681-4716
67118-87	JGI-67118-87	Seal, Speedometer Drive Gear, '87-95 up FXST/C, FLST/C/F	10	681-4717
68027-90	JGI-68027-90	Gasket, Tail Lamp Lens, '84-93 FLT, FXR, Softail	5	681-4702
68123-73	JGI-68123-73	Gasket, Tail Lamp Mounting, '84-98 All Models	10	681-4701
68425-86	JGI-68425-86	O-ring, Turn Signal Lens Screw, '87-99 FXR, Softail	10	681-4703
68451-86	JGI-68451-86	O-ring, Turn Signal Lens, '86-99 FLT, FXR, Softail	10	681-4704
68455-86	JGI-68455-86	O-ring, Turn Signal Lens, '86-99 FXR, Softail	10	681-4705

WINDSHIELDS / FAIRINGS

AUDIO / COMMUNICATION

SEATS / LUGGAGE

BARS / MIRRORS / CONTROLS

EXHAUST

AIR / FUEL SYSTEMS

ENGINE

TRANSMISSION / DRIVELINE

GASKETS / SEALS

ELECTRICAL

LIGHTING

CABLES

BRAKES

OIL FILTERS

SUSPENSION

BODY

WHEELS

TIRES / TIRE ACC.

BIKE ACC.

VICTORY / INDIAN

COVERS / LOCKS / TIEDOWNS

CHEMICALS

TOOLS

HELMETS

HELMET ACC.

EYEWEAR

APPAREL / RIDER ACC.

PROMOTIONAL

REFERENCE

INDEX



# SHOVELHEAD GASKETS & SEALS

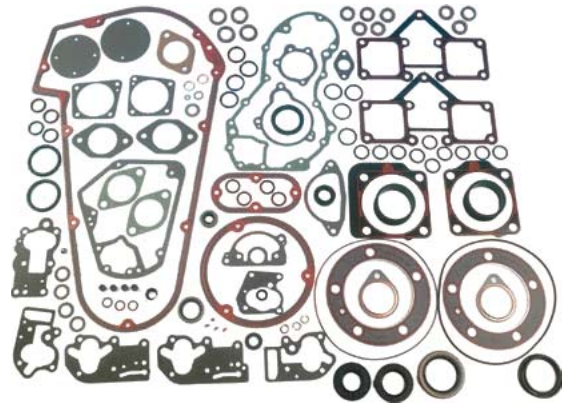

- Genuine James Gaskets uses state of the art materials and production methods to make the best gaskets available
- Comprehensive gasket kits for many applications as well as individual gaskets are available
- Various material choices available depending on application
- FOAMET - foam covered metal
- MLS - multi layered steel
- RCM - rubber covered metal
- Micropore paper gaskets with or without elastomer bead (Nitrile or Silicone)
- Made in the U.S.A.

GASKETS / SEALS

	OEM#	JGI#	Application	Quantity	WPS#
<b>SHOVELHEAD GASKET KITS</b>					
ELECTRICAL	17029-70	JGI-17029-70-A	Gasket Kit, Motor, (w/Beaded Chain Cover), '66-84 Shovelhead	Kit	681-4740
	17029-70	JGI-17029-70	Gasket Kit, Motor, '66-84 Shovelhead	Kit	681-4741
LIGHTING	17034-66	JGI-17034-66-X	Gasket Kit, Top End, w/Firing Head Gaskets, '66-84 Shovelhead	Kit	681-4743
	17034-66	JGI-17034-66	Gasket Kit, Top End, '66-84 Shovelhead	Kit	681-4744
CABLES	27006-76T	JGI-27006-76	Gasket/Seal Kit, Keihin Carburetor Overhaul, '76-84 FL, FLH, FX, FXR	Kit	681-4777
		JGI-17034-66-MLS	Gasket Kit, Top End, w/MLS Head Gaskets, '66-84 Shovelhead	Kit	681-4742
		JGI-17034-78-S	Gasket Kit, Top End, '66-78 3-5/8" BoreShovelhead	Kit	681-4745
BRAKES		JGI-16770-66-S	Gasket Set, Cylinder Head .045"/Base .030", 3-5/8" BoreShovelhead	Kit	681-4746
		JGI-17955-48-FLR	Seal Kit, Pushrod Cover, Rubber, '66-E79 FL, FLH, FLT	Kit	681-4747
OIL FILTERS		JGI-17955-48-FL	Seal Kit, Pushrod Cover, Cork, '66-E79 FL, FLH, FLT	Kit	681-4748
		JGI-11101-XL	O-ring Kit, Pushrod Tube, '79-83 FL, FLH	Kit	681-4749
SUSPENSION		JGI-11133-FL	O-ring Kit, Pushrod Tube, Late '79-Early '81 FL, FLH, FX, FXR	Kit	681-4750
		JGI-11133-FLH	O-ring/Quad Seal Kit, Pushrod Tube, Late '81-83 FL, FLH, FLH-80, FX, FXR	Kit	681-4751
		JGI-25225-70-KX	Gasket/Seal Kit, Quick Change, Metal w/Bead, '70-84 FLT, FXR	Kit	681-4401
BODY		JGI-25225-70-K	Gasket/Seal Kit Cam Cover, '70-84 FL, FLT, FLH, FXR	Kit	681-4402
		JGI-81-FL	Gasket/Seal Kit, Oil Pump, Mylar, '81-83 FLH, FLT, FXR	Kit	681-4405
WHEELS		JGI-81-FLH	Gasket/Seal Kit, Oil Pump, Paper, '81-83 FLH, FXB, FXEF	Kit	681-4406
		JGI-68-FL	Gasket/Seal Kit, Oil Pump, Mylar, '68-80 FL, FLH, FXB, FXEF, FXS, FSXG	Kit	681-4752
TIRES / TIRE ACC.		JGI-79-FLH	Gasket/Seal Kit, Oil Pump, Paper, '68-80 FL, FLH, FXB, FXEF, FXS, FSXG	Kit	681-4753
		JGI-48-FL	Gasket Kit, Oil Pump, '66-67 Shovelhead	Kit	681-4754
BIKE ACC.		JGI-33031-85	Gasket/Seal Kit, Transmission, '80-83 5-Speed w/o Oil Pan	Kit	681-4410
		JGI-33031-70	Gasket/Seal Kit, Transmission, '66-83 All 4-Speeds	Kit	681-4412
VICTORY / INDIAN		JGI-12044-AK	Oil Seal Kit, Transmission Main Seal, '80-Early '84 5-Speed FLT, FXR, FXRT	Kit	681-4755
		JGI-37741-82-K	Oil Seal Kit, Transmission Main Seal, 4-Speed, '82-85 FLH, FLH Classic	Kit	681-4416
		JGI-37741-67-K	Oil Seal Kit, Transmission Main Seal, 4-Speed, '80-81 FL, FLH, FLH-80	Kit	681-4756
COVERS / LOCKS / TIEDOWNS		JGI-35230-39-K	Oil Seal Kit, Trans. Main Drive 4-Speed, '66-79	Kit	681-4757
		JGI-36025-36-X	Oil Seal, Transmission Countershaft, w/Screws/Lockwashers, 4-Speed Trans.	Kit	681-4758
CHEMICALS		JGI-60540-70-K	Gasket Kit, Primary Cover, 8-Hole, '70-early '82 All Big-Twin Models	Kit	681-4759
		JGI-60540-65-K	Gasket Kit, Primary Cover, 8-Hole, '66-69 Big Twins	Kit	681-4760
TOOLS		JGI-60538-81-K	Gasket Kit, Primary Cover/Inspection Cover Only, '66-83 FL, FLH, FX, FXS	Kit	681-4761
		JGI-34901-85-K	Gasket/Seal Kit, Primary Cover, '80-83 FLT, FXR	Kit	681-4407
HELMETS		JGI-34901-79-K	Gasket/Seal Kit, Primary Cover, '79-83 5-Speeds	Kit	681-4762
		JGI-60538-85-K	Gasket/Seal Kit, Primary Cover, '65-86 FL, FLH, FXS	Kit	681-4763
		JGI-25416-79-K	Gasket Kit, Primary Inspection/Clutch Derby Cover, '79-83	Kit	681-4764
HELMET ACC.		JGI-25416-70-K	Gasket Kit, Primary Inspection/Clutch Derby Cover, '70-83 All Models	Kit	681-4409
		JGI-60567-90-DLK	Kit, Inspection Cover, w/Shifter Sleeve, '74-86 FX, FXE, FXE-80, FXEF, FXEF-80, FXSB	Kit	681-4765
EYEWEAR		JGI-12014-K	Seal Kit, Clutch Hub Nut, '65-84 FL & FX Models	Kit	681-4417
		JGI-45849-77	Oil Seal Kit, Front Fork, '77-83 FL, FLH, FLH-80, FLT-80, FLT Classic	Kit	681-4766
APPAREL / RIDER ACC.		JGI-45849-75	Oil Seal Kit, Front Fork, '75-83 FX, FXE, FXSB, FXR	Kit	681-4767
		JGI-45849-49-A	Gasket/Seal Kit, Front Fork w/Metal Spacer, '66-Early '77 FL, FLH	Kit	681-4768
		JGI-45849-49	Gasket/Seal Kit, Front Fork, w/Felt Washer, '66-Early '77 FL, FLH	Kit	681-4769
PROMOTIONAL		JGI-45858-77-K	Screw Kit, Fork Drain, Chrome, '77-Up Touring '87 Softail '93-'05 except FXSTD	Kit	681-4052
		JGI-45790-80-BH	Screw Kit, Fork Drain, Chrome Button Screws/Seal Washers '73-Up FX	Kit	681-4770
REFERENCE		JGI-45790-80	Screw Kit, Fork Drain, Zinc Screws/Seal Washers '73-Up FX	Kit	681-4771
		JGI-45849-84-K	Gasket/Seal Kit, Fork Air Control, '83 FL, FXR	Kit	681-4422
INDEX		JGI-65834-68-KSC2	Gasket Kit, Exhaust Mounting, '66-83 Shovelhead	Kit	681-4772

## SHOVELHEAD GASKETS &amp; SEALS



OEM#	JGI#	Application	Quantity	WPS#
<b>SHOVELHEAD GASKET KITS (cont'd...)</b>				
	JGI-65834-68-KSC1	Gasket Kit, Exhaust Mounting, '66-83 Shovelhead	Kit	<b>681-4773</b>
	JGI-27002-78	Gasket Kit, Intake to Carb., '66-83 Bendix@/Zenith	Kit	<b>681-4774</b>
	JGI-27062-78-2	Gasket Kit, Manifold Mounting, Panhead, Shovelhead, Ironhead XL	Kit	<b>681-4775</b>
	JGI-27002-57	Gasket Kit, Intake Manifold, Bendix/Keihin, 57-85 XL, '66-84 Shovel, 48-65 Pan	Kit	<b>681-4776</b>
	JGI-27002-66-SS	Gasket Kit, S&S Carburetor, Panhead Shovelhead Sportster	Kit	<b>681-4778</b>
	JGI-27002-66-SU	Gasket Kit, SU Carburetor to Manifold, Sportster Panhead Shovelhead	Kit	<b>681-4779</b>
	JGI-68123-55-K	Gasket Kit, Tail Lamp Mounting, '66-72 FL, FLH	Kit	<b>681-4780</b>
	JGI-60518-65-DLK	Seal Kit, Starter Housing/Shift Lever, '66-81 Shovelhead	Kit	<b>681-4781</b>
<b>SHOVELHEAD INDIVIDUAL GASKETS, SEALS, O-RINGS 66-UP</b>				
<b>ROCKER BOX ASSEMBLY GASKETS</b>				
17540-69	JGI-17540-99-X	Gasket, Rocker Cover, .020" Metal w/Bead, '66-83 Shovelhead	2	<b>681-4801</b>
17540-69	JGI-17540-69-X	Gasket, Rocker Cover, .020" Paper w/Bead, '66-83 Shovelhead	10	<b>681-4802</b>
17540-69	JGI-17540-69	Gasket, Rocker Cover, .020" Paper, '66-83 Shovelhead	10	<b>681-4803</b>
17540-69	JGI-17540-69-A	Gasket, Rocker Cover, .031" Paper, '66-83 Shovelhead	10	<b>681-4804</b>
<b>PUSHROD, TAPPET GASKETS AND VALVE STEM SEALS</b>				
11101	JGI-11101	O-ring, Rocker Cover to Pushrod Tube, '66-83 FLH, FLT, FX	25	<b>681-4810</b>
11133	JGI-11133	O-ring, Pushrod Cover to Tappet Guide, Late '79-81 FL, FX, FLT, FXR	25	<b>681-4812</b>
11133A	JGI-11133-A	Quad Seal, Pushrod Cover to Tappet Guide, Late '81-83 FL, FX, FLT, FXR	25	<b>681-4821</b>
17955-36	JGI-17955-36	Seal, Pushrod Cover, Small, Cork, '66-80 All Models	100	<b>681-4815</b>
17955-36A	JGI-17955-36-A	Seal, Pushrod Cover, Small, Rubber, '66-80 All Models	100	<b>681-4813</b>
17955-48	JGI-17955-48	Seal, Pushrod Cover, Large, Cork, '66-79 FL, FLH, FLT, FX	100	<b>681-4819</b>
17955-48A	JGI-17955-48-A	Seal, Pushrod Cover, Large, Rubber, '66-79 FL, FLH, FLT, FX	100	<b>681-4817</b>
18000-81	JGI-18000-81	Seal, Valve Stem, Intake/Exhaust, '81-83 Shovelhead	4	<b>681-4822</b>
18196-51	JGI-18196-51	Gasket, Valve Guide, '66-78 Shovelhead	20	<b>681-4826</b>
18633-48C	JGI-18633-48-A/C	Gasket, Tappet Block, Rear, .031" Paper, '48-99 All Models	10	<b>681-4467</b>
18634-48C	JGI-18634-48-A/B	Gasket, Tappet Block, Front, .031" Paper, '48-99 All Models	10	<b>681-4466</b>
	JGI-11101-X	O-ring, Rocker Cover to Pushrod Tube, Oversized 11101, '66-83 FLH, FLT, FX	25	<b>681-4811</b>
	JGI-17955-36-A-25	Seal, Pushrod Cover, Small, Rubber, '66-80 All Models	25	<b>681-4814</b>
	JGI-17955-36-25	Seal, Pushrod Cover, Small, Cork, '66-80 All Models	25	<b>681-4816</b>
	JGI-17955-48-A-25	Seal, Pushrod Cover, Large, Rubber, '66-79 FL, FLH, FLT, FX	25	<b>681-4818</b>
	JGI-17955-48-25	Seal, Pushrod Cover, Large, Cork, '66-79 FL, FLH, FLT, FX	25	<b>681-4820</b>
	JGI-18634-48-F	Gasket, Tappet Block, Front, Foamet, '48-99 All Models	5	<b>681-4464</b>
	JGI-18633-48-F	Gasket, Tappet Block, Rear, Foamet, '48-99 All Models	5	<b>681-4465</b>
	JGI-18000-81-10	Seal, Valve Stem, Intake/Exhaust, '81-83 Shovelhead	10	<b>681-4823</b>
	JGI-18000-48	Seal, Valve Stem, Intake/Exhaust, '66-80 Big Twin Models	4	<b>681-4824</b>
	JGI-18000-48-10	Seal, Valve Stem, Intake/Exhaust, '66-80 Big Twin Models	10	<b>681-4825</b>
<b>HEAD AND BASE GASKETS</b>				
16770-66A	JGI-16770-66-X	Gasket, Cylinder Head, .045" w/Firering, '66-84 Shovelhead	2	<b>681-4841</b>
16770-66A	JGI-16770-66-B	Gasket, Cylinder Head, .045" Graphite, '66-84 Shovelhead	5	<b>681-4842</b>
16770-66A	JGI-16770-66-A	Gasket, Cylinder Head, .045" Teflon Coated Paper, '66-84 FL, FLH, FLT	5	<b>681-4843</b>
16776-63	JGI-16776-63	Gasket, Cylinder Base, Front, .032" Paper, '66-84 Shovelhead	10	<b>681-4847</b>
16777-63	JGI-16777-63	Gasket, Cylinder Base, Rear, .032" Paper, '66-84 Shovelhead	10	<b>681-4848</b>
	JGI-16770-66-MLS	Gasket, Cylinder Head, .050 Multi-Layered Steel, '66-83 Shovelhead	2	<b>681-4840</b>
	JGI-16776-63-XF	Gasket, Cylinder Base, Front/Rear, .030" Foamet w/Bead, '66-83 Shovelhead	2	<b>681-4844</b>
	JGI-16776-63-X	Gasket, Cylinder Base, Front/Rear, .036" Metal w/Bead, '66-83 Shovelhead	2	<b>681-4845</b>
	JGI-16776-63-X1	Gasket, Cylinder Base, Front/Rear, .020" Metal w/Bead '63-83 Shovelhead	2	<b>681-4846</b>
	JGI-16777-66-SX	Gasket, Cylinder Base, Front/Rear, .020" Metal w/Bead 3-5/8" Bore Shovelhead	2	<b>681-4849</b>
	JGI-16777-66-X	Gasket, Cylinder Base, Front/Rear, .036" Metal w/Bead, 3-5/8" Bore Shovelhead	2	<b>681-4850</b>
	JGI-16777-66-S	Gasket, Cylinder Base, Front/Rear, .032" Paper, 3-5/8" Bore Shovelhead	10	<b>681-4851</b>
<b>MOTOR CASE O-RINGS AND SEALS</b>				
12026A	JGI-12026-A	Oil Seal, Motor Sprocket Shaft, '70-83 1200cc/1340cc	5	<b>681-4501</b>
<b>OIL AND OIL PUMP GASKETS</b>				
6156	JGI-6156	Washer, Oil Pump Adjusting Screw, Brass, '66-69 FLH	10	<b>681-4867</b>
6377	JGI-6377	Washer, Oil Pump Body Plug, Brass, Late '66-80 FL, FLH, FLH-80, FX, FXR	10	<b>681-4868</b>
6581	JGI-6581	Washer, Oil Pump Body Plug, Brass, '66-78 FL, FLH, FLH-80	10	<b>681-4869</b>
8866	JGI-8866	Ball Bearing, Oil Pump, 3/8" Dia. (a.k.a. 8873), '66-83 FLT, FXR	10	<b>681-4523</b>
11002	JGI-11002	Snap Ring, Oil Pump Shaft, Shovelhead	10	<b>681-4520</b>
11105	JGI-11105	O-Ring, Oil Screen Pump	25	<b>681-4126</b>
25414-79A	JGI-25414-79-A	Oil Seal, Chain Oil Bath Housing, '80-81 FLT w/Chain Bath	2	<b>681-4873</b>



# SHOVELHEAD GASKETS & SEALS

WINDSHIELDS / FAIRINGS  
AUDIO / COMMUNICATION  
SEATS / LUGGAGE  
BARS / MIRRORS / CONTROLS  
EXHAUST  
AIR / FUEL SYSTEMS  
ENGINE  
TRANSMISSION / DRIVELINE  
GASKETS / SEALS  
ELECTRICAL  
LIGHTING  
CABLES  
BRAKES  
OIL FILTERS  
SUSPENSION  
BODY  
WHEELS  
TIRES / TIRE ACC.  
BIKE ACC.  
VICTORY / INDIAN  
COVERS / LOCKS / TIEDOWNS  
CHEMICALS  
TOOLS  
HELMETS  
HELMET ACC.  
EYEWEAR  
APPAREL / RIDER ACC.  
PROMOTIONAL  
REFERENCE  
INDEX

OEM#	JGI#	Application	Quantity	WPS#
<b>EVOLUTION INDIVIDUAL GASKETS, SEALS, O-RINGS '84-UP</b>				
<b>OIL AND OIL PUMP GASKETS (cont'd...)</b>				
26227-58	JGI-26227-58	Oil Seal, Oil Pump, '66-76 FLH, FLT, FXR	5	681-4872
26231-78	JGI-26231-78	Washer, Oil Pump Cap, '78-80 FL, FLH, FX, FXS	10	681-4870
26245-41	JGI-26245-41	Gasket, Oil Pump, Body, Paper, '66-67 FL, FLH	10	681-4865
26246-68A	JGI-26246-68-A	Gasket, Oil Pump, Body, Mylar, '68-80 FL, FLH, FLT, FX	10	681-4861
26246-68A	JGI-26246-68-D	Gasket, Oil Pump, Body, Black Paper, '68-80 FL, FLH, FLT, FX	10	681-4863
26257-50A	JGI-26257-50-A	Gasket, Oil Pump, Cover, Paper, '66-67 FL, FLH	10	681-4864
26258-68B	JGI-26258-68-B	Gasket, Oil Pump, Cover, Mylar, '68-80 FL, FLH, FLH-80, FX	10	681-4860
26258-68B	JGI-26258-68-D	Gasket, Oil Pump, Cover, Black Paper, '68-80 FL, FLH, FLH-80, FX	10	681-4862
26273-80B	JGI-26273-80-AM	Gasket, Oil Pump, Body, Mylar, Late '80-83 FL, FLH, FLH-80, FLT, FX, FXR	10	681-4512
26273-80B	JGI-26273-80-B	Gasket, Oil Pump, Body, Black Paper, Late '80-83 FL, FLH, FLH-80, FLT, FX, FXR	10	681-4514
26276-80A	JGI-26276-80-M	Gasket, Oil Pump, Cover, Mylar, '80-83 FL, FLH, FLH-80, FLT, FX, FXR	10	681-4513
26276-80A	JGI-26276-80-A	Gasket, Oil Pump, Cover, Black Paper, Late '80-83 FL, FLH, FLH-80, FLT, FX, FXR	10	681-4515
26340-36	JGI-26340-36	Key, Oil Pump Shaft, Short, '66-67 FL, FLH	10	681-4866
26348-15	JGI-26348-15	Key, Oil Pump Shaft, Long, '66-83 FL, FLH, FXR, FLT	10	681-4521
26348-36	JGI-26348-36	C-Clip, Oil Pump Shaft, '66-83 FLH, FLT, FXR	10	681-4522
37091-80	JGI-37091-80	Washer, Oil Dip Stick, '80-83 134Occ 5-Speed Transmissions	10	681-4524
62628-66	JGI-62628-66	Gasket, Oil Tank Cap, Cork, '66-Early '82 FL, FLH, FLH-80, FX	10	681-4874
63529-57	JGI-63529-57	Seal, Oil Line, '66-83 FL, FLH, FX	25	681-4871
63879-53	JGI-63879-53	O-ring, Oil Filter Cup, '66-Early '82 FL, FLH, FLH-80	10	681-4875
<b>CAM HOUSING</b>				
25225-36C	JGI-25225-36-CX	Gasket, Cam Gear Cover '66-69 w/Silicone Beading 0.020" thick	5	681-4880
25225-36C	JGI-25225-36-C	Gasket, Cam Gear Cover, '66-69 FL, FLH	10	681-4881
25225-70A	JGI-25225-70-XM	Gasket, Cam Gear Cover, Metal Core w/Bead, '70-83 FLH, FLT, FXR	1	681-4545
25225-70A	JGI-25225-70-X	Gasket, Cam Gear Cover, Paper w/Bead, '70-83 FLH, FLT, FXR	5	681-4546
25225-70A	JGI-25225-70-B	Gasket, Cam Gear Cover, Black Paper, '70-83 FLH, FLT, FXR	10	681-4547
83162-51	JGI-83162-51	Oil Seal, Cam Gear Shaft, Metal O.D., '70-83 FL, FLH, FLT, FXR	5	681-4548
83162-51	JGI-83162-51-DL	Oil Seal, Cam Gear Shaft, Rubber O.D., '70-83 FL, FLH, FLT, FXR	5	681-4549
	JGI-25225-70-XF	Gasket, Cam Gear Cover, Foamet, '70-83 FLH, FLT, FXR	5	681-4544
<b>INTAKE AND EXHAUST GASKETS</b>				
11107	JGI-11107	O-ring, Spacer Block Mounting, '66-71 FL, FLH	25	681-4895
27023-71	JGI-27023-71	Gasket, Intake Manifold, '71-Early '78 Bendix Carburetors	10	681-4891
27060-55	JGI-27060-55	O-ring, Intake Manifold, '66-77 FL, FLH, FLT, FXR	10	681-4893
27060-55	JGI-27060-55-V	O-ring, Intake Manifold, Viton, '66-77 Big Twin	2	681-4894
27062-78	JGI-27062-78	Seal, Intake Manifold to Cylinder Head, Late '78-83 FL, FLH, FXR, FXRT	10	681-4890
27077-78	JGI-27077-78-X	Gasket, Intake Manifold to Carb., Metal w/Bead, '78-83 FLH, FLT, FXR	10	681-4561
27077-78	JGI-27077-78	Gasket, Intake Manifold to Carburetor, '78-83 FLH, FLT, FXR	10	681-4560
27336-76	JGI-27336-76	O-ring, Carburetor to Manifold, '76-Early '78 Keihin Carburetors	10	681-4892
29058-77	JGI-29058-77	Gasket, Air Cleaner, .030" Paper, '77-83 FX, FXR, FLT	10	681-4570
29058-77	JGI-29058-77-A	Gasket, Air Cleaner, .062" Paper, '77-83 FX, FXR, FLT	10	681-4896
29242-83	JGI-29242-83	Gasket, Compliance Fitting, '83-84 FLT, FXR	10	681-4566
65834-68A	JGI-65834-68-SC	Gasket, Exhaust Pipe to Cylinder Head, Steelcore w/Firering, '66-83 1200cc, 1340cc	10	681-4900
	JGI-313-18-100	Stud, Exhaust Mounting to Cylinder Head, 5/16-18 x 1.00", Shovelhead	6	681-4897
	JGI-313-18-125	Stud, Exhaust Mounting to Cylinder Head, 5/16-18 x 1.25", Shovelhead	6	681-4898
	JGI-65834-68-N3	Nut, Chrome Plated Acorn, Exhaust Mounting, 5/16-18, Shovelhead	2	681-4899
<b>CARB GASKETS</b>				
27311-76A	JGI-27311-76-A	Boot, Carburetor, Accelerator Pump, L '76-83 FLT, FLH, FX	10	681-4592
27312-76	JGI-27312-76	O-ring, Float Bowl, '76-Early '78 Keihin Carburetors	10	681-4915
27324-83	JGI-27324-83	O-ring, Float Bowl to Carburetor Body, '83-84 FLT, FXR	5	681-4913
27358-76	JGI-27358-76	O-ring, Float Bowl to Carburetor Body, '76-Early '78 Keihin Carburetors	5	681-4916
27360-76	JGI-27360-76	U-Rings, Accelerator Pump Housing, '76-83 Keihin Carburetors	20	681-4591
27361-76	JGI-27361-76	Diaphragm, Accelerator Pump, '76-83 Keihin Carburetors	1	681-4590
27374-57	JGI-27374-57	Washer, Fibre, '66-70 Tillitson Carburetors	10	681-4912
27385-76	JGI-27385-76	Plug, Low Speed Jet, '76-83 Keihin Carburetors	5	681-4594
27403-71	JGI-27403-71	Washer, Main Jet, Fibre, '71-76 Bendix Carburetors	20	681-4910
27404-71	JGI-27404-71	Washer, Idle Jet, Fibre, '71-76 Bendix Carburetors	20	681-4911
27889-78	JGI-27889-78	O-ring, Float Bowl to Carburetor, '78-83 FLT, FLH, FX	5	681-4914
27892-78	JGI-27892-78	O-ring, Adjust. Screw, Low Speed Mixture, '78-84 FLH, FLT, FX	10	681-4917
62172-75	JGI-62172-75	Gasket, Fuel Valve Assembly, '75-83 FLH, FXR, FLT	20	681-4593
	JGI-27186-04-SU	Gasket, SU Carb. to Manifold, 1.86" Bore, Sportster, Panhead, Shovelhead	5	681-4918
	JGI-27200-04-SU	Gasket, SU Carb. to Manifold, 2.00" Bore, Sportster, Panhead, Shovelhead	5	681-4919
	JGI-29059-04-SU	Gasket, SU Carb. to Manifold, Sportster, Panhead, Shovelhead	5	681-4920

## SHOVELHEAD GASKETS &amp; SEALS



OEM#	JGI#	Application	Quantity	WPS#
<b>EVOLUTION INDIVIDUAL GASKETS, SEALS, O-RINGS '84-UP</b>				
<b>PRIMARY HOUSING GASKETS</b>				
7402	JGI-7402	Lock Tab, Inner Primary Cover, '80-84 FLT, FXR	10	<b>681-4948</b>
11125	JGI-11125	O-ring, Inner Chain Cover to Motor, '70-81 FL, FLH, FLH-80	10	<b>681-4947</b>
11148	JGI-11148	Quad Seal, Shifter Lever Sleeve, '82-86 FXR	25	<b>681-4688</b>
11428	JGI-11428	Grommet, Chain Housing Oil Fill, '80-85 FLT w/Chain Bath	5	<b>681-4957</b>
12014	JGI-12014	Oil Seal, Clutch Hub Nut, '65-84 FL, FX Models	5	<b>681-4944</b>
12018	JGI-12018	Oil Seal, Inner Primary Cover, Double Lip, '70-Early '84 FL, FLH, FLH-80	5	<b>681-4945</b>
25414-79A	JGI-25414-79-A	Oil Seal, Chain Oil Bath Housing, '80-81 FLT w/Chain Bath	2	<b>681-4873</b>
25416-70	JGI-25416-70-DL	Gasket, Clutch Derby Cover, Molded Rubber on Steel, '70-84 FL, FX	1	<b>681-4622</b>
25416-70	JGI-25416-70-X	Gasket, Clutch Derby Cover, .062" w/Bead, '70-83 FL, FLH, FX, FXR	10	<b>681-4940</b>
25416-70	JGI-25416-70	Gasket, Clutch Derby Cover, 0.030" Paper, '70-83 FL, FLH, FX, FXR	10	<b>681-4941</b>
25416-70	JGI-25416-70-C	Gasket, Clutch Derby Cover, 0.030" Cork, '70-83 FL, FLH, FX, FXR	5	<b>681-4942</b>
31478-65	JGI-31478-65-X	Screw, Solenoid Pivot Arm, w/O-ring, '65-84 FL FLH	1	<b>681-4956</b>
31497-65	JGI-31497-65	Lock Plate, Primary Cover, '65-69 Shovelhead	1	<b>681-4950</b>
34901-79	JGI-34901-79-A	Gasket, Primary Cover, .062" Paper, Late '83-93 FLT, FXR	5	<b>681-4612</b>
34901-79	JGI-34901-79	Gasket, Primary Cover, .030" Paper, '79-82 FLT	10	<b>681-4932</b>
34902-79A	JGI-34902-79-A	Gasket, Inner Primary to Transmission, Large, .030" Paper, '79-85 FLT, FXR	10	<b>681-4623</b>
34903-79	JGI-34903-79	Gasket, Inner Primary to Transmission, Small, .030" Paper, '79-85 FLT, FXR	10	<b>681-4624</b>
34906-79	JGI-34906-79	Gasket, Inspection Cover, .030" Paper, '79-83 FLT, FXR	10	<b>681-4935</b>
34906-79	JGI-34906-79-DL	Seal, Inspection Cover, Molded Rubber/Steel, '79-84 FLT, FXR	1	<b>681-4938</b>
37503-41	JGI-37503-41	Lock Tab, Clutch Hub Nut, '41-84 4-Speed Transmissions	5	<b>681-4951</b>
50100-70	JGI-50100-70	Bumper Pad, Primary/Kickstand, Rubber w/Adhesive, '70-84 FL, FLH, FX	10	<b>681-4639</b>
60518-65	JGI-60518-65-DL	Seal, Oil Deflector Plate, w/Dual Sealing Lips, '65-84 Shovelhead	1	<b>681-4954</b>
60538-81	JGI-60538-81-C	Gasket, Primary Cover, .062" Paper w/Bead, '81-Up FL, FLH, FX, FXS	5	<b>681-4930</b>
60538-81	JGI-60538-81-A	Gasket, Primary Cover, .062" Paper, Late '81-Up FL, FLH, FX, FXS	5	<b>681-4931</b>
60540-65	JGI-60540-65-A	Gasket, Primary Cover, '8 Hole, .062" Paper w/Bead, '65-80 FL, FLH, FX, FXS	5	<b>681-4933</b>
60540-65	JGI-60540-65	Gasket, Primary Cover, '8 Hole, .032" Paper, '65-80 FL, FLH, FX, FXS	10	<b>681-4934</b>
60567-65	JGI-60567-65-B	Gasket, Inspection Cover, .062" Paper, Bead 2 Sides, '65-Up FL, FLH, FLH-80, FX, FXE	5	<b>681-4614</b>
60567-65	JGI-60567-65-C	Gasket, Inspection Cover, .062" Paper, '65-Up FL, FLH, FLH-80, FX, FXE	10	<b>681-4936</b>
60567-65	JGI-60567-65	Gasket, Inspection Cover, .032" Paper, '65-Up FL, FLH, FLH-80, FX, FXE	10	<b>681-4937</b>
60567-90	JGI-60567-90-F	Gasket, Inspection Cover, Foamet w/Bead, '65-Up FL, FLH, FLH-80, FX, FXE	5	<b>681-4613</b>
60567-90	JGI-60567-90	Gasket, Inspection Cover, .062" Paper, Bead 1 Side, '65-Up FL, FLH, FLH-80, FX, FXE	5	<b>681-4615</b>
60567-90	JGI-60567-90-DL	Seal, Inspection Cover, Molded Rubber/Steel, '65-Up FL, FLH, FLH-80, FX, FXE	1	<b>681-4939</b>
60629-65	JGI-60629-65	Gasket, Chain Housing to Engine, RCM w/Bead, w/Lock Plate, '65-69 FL, FLH	1	<b>681-4943</b>
60641-74	JGI-60641-74	Oil Seal, Shifter Shaft, '70-Up FX, FXS, FXE	5	<b>681-4946</b>
60645-65	JGI-60645-65-X	Quad Seal, Solenoid Mounting to Inner Primary, '65-84 FL FLH	10	<b>681-4955</b>
	JGI-25416-70-F	Gasket, Clutch Derby Cover, Foamet, '70-83 FL, FLH, FX, FXR	5	<b>681-4640</b>
	JGI-33196-79	Gasket, Shift Cover, '79-86 4-Speeds	10	<b>681-4662</b>
	JGI-11125-BL	Lock Tab, Inner Primary Cover, '70-84 FL, FX	5	<b>681-4949</b>
	JGI-60518-65-X	Block-Off Plate, Starter Motor, Molded Rubber/Steel, '65-84 FL, FLH	1	<b>681-4952</b>
	JGI-60644-65-DL	Plug, Starter Solenoid Blockoff Plate, '65-84 Shovelhead	1	<b>681-4953</b>
<b>TRANSMISSION GASKETS</b>				
6007	JGI-6007	Washer, Transmission Drain Plug, '80-Up FLT, FXR	10	<b>681-4691</b>
11114	JGI-11114	O-ring, Main Drive Gear, '82-84 4-Speed Models	25	<b>681-4982</b>
11115	JGI-11115	O-ring, Transmission Countershaft, '65-84 FL, FLH, FLH-80, FX	25	<b>681-4983</b>
11148	JGI-11148	Quad Seal, Shifter Lever Sleeve, '82-86 FXR	25	<b>681-4688</b>
11428	JGI-11428	Grommet, Chain Housing Oil Fill, '80-85 FLT w/Chain Bath	5	<b>681-4957</b>
12010	JGI-12010	Oil Seal, Transmission Shift Plate, Late '79-83 FL, FLH, FX, FXS	5	<b>681-4987</b>
12022	JGI-12022	Oil Seal, Main Drive Gear End, Late '66-84 FL, FLH, FLT, FX, FXR	5	<b>681-4981</b>
12045	JGI-12045-M	Oil Seal, Metal O.D., 5-Speed Shifter Shaft, '80-Up FLT, FXR	5	<b>681-4668</b>
12044A	JGI-12044-A	Oil Seal, Rubber O.D., Trans. Main Drive Gear, '80-84 FLT, FXR, FXRT, FXRS	1	<b>681-4978</b>
12044A	JGI-12044-DL	Oil Seal, Metal O.D., Main Drive Gear, '80-84 FLT, FXR, FXRT, FXRS	1	<b>681-4979</b>
33043-80	JGI-33043-80	Washer, Transmission Neutral Switch Mounting, Nylon, '80-Up FLT, FXR	10	<b>681-4690</b>
33076-37	JGI-33076-37	Seal, Starter Crankshaft (Kick Start), 4-Speed, '66-84 FL, FLH	10	<b>681-4988</b>
33196-79	JGI-33196-79	Gasket, Shift Cover, '79-86 4-Speeds	10	<b>681-4662</b>
33295-36	JGI-33295-36-X	Gasket, Transmission End Cover, Paper w/Bead, '66-85 4-Speed Transmissions	5	<b>681-4656</b>
33295-36	JGI-33295-36	Gasket, Transmission End Cover, Paper, '66-85 4-Speed Transmissions	10	<b>681-4657</b>
34036-36	JGI-34036-36	Seal, Transmission Shifter Fork Shaft, '66-79 FL, FLH	10	<b>681-4971</b>
34036-80	JGI-34036-80	O-ring, Transmission Shifter Fork Shaft, 4-Speed, Late '80-85 FL, FLH, FX	10	<b>681-4689</b>



# SHOVELHEAD GASKETS & SEALS

OEM#	JGI#	Application	Quantity	WPS#
<b>EVOLUTION INDIVIDUAL GASKETS, SEALS, O-RINGS '84-UP</b>				
<b>TRANSMISSION GASKETS (CONT'D...)</b>				
34552-52	JGI-34552-52	Gasket, Transmission Shifter Assembly, '66-79 FL, FLH, FLH-80, FX	10	681-4976
34565-52	JGI-34565-52	Gasket, Transmission Shifter Plate, 4-Speed, '66-79 FL, FLH, FLH-80, FX	10	681-4977
34824-36	JGI-34824-36	Gasket, Transmission Top Cover, '66-Early, '79 All 4-Speed Transmissions	10	681-4970
34824-79	JGI-34824-79	Gasket, Transmission Top Cover, 4-Speed, Late '79-86 FL, FLH, FX	10	681-4653
34904-79	JGI-34904-79	Gasket, Trans. Top Cover, Paper, '79-85 FLT, FXR 5-Speed	10	681-4652
35175-38	JGI-35175-38	Key, Main Drive Gear, '66-77 4-Speed Transmissions	5	681-4975
35216-36	JGI-35216-36	Lock Tab, Sprocket to Main Drive Gear, '66-84 4-Speed Transmissions	5	681-4972
35230-39	JGI-35230-39-DL	Oil Seal, Transmission Main Drive Gear, '66-79 FL, FLH	1	681-4980
35231-36	JGI-35231-36	Washer, Main Drive Oil Seal, Cork, '66-79 FL, FLH	10	681-4974
35607-73	JGI-35607-73	Gasket, Speedometer Hole Cover, '73-79 FX, FXE	10	681-4985
35652-79	JGI-35652-79-X	Gasket, Trans. Bearing Cover w/Bead, 5-Spd, '79-Up FLT, FXR	5	681-4654
35652-79	JGI-35652-79-A	Gasket, Transmission Bearing Cover, 5-Speed, '79-Up FLT, FXR	10	681-4655
36801-79	JGI-36801-79-X	Gasket, Clutch Release Cover, Paper w/Bead, '79-86 FLT, FXR, FXRS	5	681-4660
36801-79	JGI-36801-79	Gasket, Clutch Release Cover, '79-86 FLT, FXR, FXRS	10	681-4661
36821-68	JGI-36821-68	Gasket, Transmission Cover Plug, '68/'69 FL, FLH	10	681-4986
37741-82	JGI-37741-82-DL	Oil Seal, Main Drive Gear, Rubber O.D., 4-Speed, '82-85 FLH, FLH Classic, FX	1	681-4676
37741-82	JGI-37741-82-A	Oil Seal, Main Drive Gear, Metal O.D., 4-Speed, '82-85 FLH, FLH Classic, FX	1	681-4675
60641-74	JGI-60641-74	Oil Seal, Shifter Shaft, '74-Up FX, FXS, FXE	5	681-4946
67141-36	JGI-67141-36	Gasket, Speedometer Drive Gear, '66-84 FL, FLH, FLH-80, FX, FXWG	10	681-4973
	JGI-34824-36-F	Gasket, Transmission Top Cover, Foam, '66-Early, '79 All 4-Speed Transmissions	5	681-4695
	JGI-33295-36-F	Gasket, Transmission End Cover, Foam, '66-85 4-Speed Transmissions	5	681-4694
	JGI-35607-73-X	Plug, Speedometer Drive Hole, Molded Rubber/Steel, 4-Speed Transmissions	1	681-4984
	JGI-35211-85-DL	Super Nut® Replacement Oil Seal, Fits JGI-35211-36-DL Super Nut® for 4-Speed Transmissions	5	681-4989
	JGI-35211-36-DL	Super Nut®, Transmission Sprocket Seal, '70-86 4-Speed Transmissions	1	681-4692
<b>MISCELLANEOUS GASKETS, SEALS, AND O-RINGS</b>				
11156	JGI-11156	O-ring, Front Fork Air Control, '83 Only FXR	25	681-5014
12002	JGI-12002	Oil Seal, Generator Small End, '66-73 FL, FLHG	5	681-5006
12047	JGI-12047-DL	Oil Seal, Wheel Bearing, '80-81 FLT	5	681-5024
25414-82	JGI-25414-82-DL	Oil Seal, Rear Wheel Sprocket '82-84 FLT chain drive	1	681-5033
25811-11	JGI-25811-11	Washer, Generator Gear Stud, Red Fibre, '66-73 FL, FLH	20	681-5001
30145-46A	JGI-30145-46-A	Oil Seal, Generator Gear End, '66-81 FL, FLH	5	681-5007
32521-36	JGI-32521-36	Gasket, Circuit Breaker Stem, '66-69 Shovelhead	10	681-5002
41210-55	JGI-41210-55	Oil Seal, Wheel Bearing, '66-72 FL, FLH	5	681-5026
45387-83	JGI-45387-83	Oil Seal, Front Fork, '83-86, FXR, FXRS, FXRT, FXSB, FXEF, FXRP	1	681-5008
45400-75	JGI-45400-75	Oil Seal, Front Fork, '75-83 FX, FXS	1	681-5010
45403-75	JGI-45403-75	Washer, Fork Leg Drain Screw, Copper, '75-77 FX, FXS	10	681-5019
45406-75	JGI-45406-75	Washer, Fork Air Control/Damper Screw, Copper, '84-85 FXRT	10	681-5020
45843-77	JGI-45843-77	Oil Seal, Front Fork, Late '77-84 FL, FLH, FLT, FLT-80, FLT Classic	1	681-5009
45844-77	JGI-45844-77	Washer, Fork Seal Backup, Late '77-83 FL FLH FLT FLT-80	2	681-5021
45850-48	JGI-45850-48	Washer, Front Fork, Felt, '49-77 FL, FLH	10	681-5017
45852-48	JGI-45852-48	Oil Seal, Front Fork, '49-77 FL, FLH	5	681-5012
45908-80	JGI-45908-80	Retaining Ring, Fork Seal	6	681-5013
45927-73	JGI-45927-73	Oil Seal, Front Fork, '73-77 FX	5	681-5011
45982-73	JGI-45982-73	O-ring, Fork Slider Tube, '73-77 FX	10	681-5015
45986-73	JGI-45986-73	Washer, Fork Drain Screw, Fibre, '73-77 FXR	10	681-5018
45992-73	JGI-45992-73	Washer, Fork Damper Screw, '73-75 FX	10	681-5016
46111-48	JGI-46111-48	Gasket, Fork Damper Tube, 49-77 FL, FLH	10	681-5022
46125-48	JGI-46125-48	Gasket, Fork Damper Tube, 49-77 FL, FLH	10	681-5023
47519-58	JGI-47519-58	Oil Seal, Wheel Bearing, '66-83 FL, FLH, FX	5	681-5025
60518-65	JGI-60518-65	Gasket, Starter Cover Plate, '65-69 FL, FLH	10	681-5031
60645-65	JGI-60645-65	Gasket, Sponge w/Adhesive Backing Starter Solenoid, '65-84 FLH, FLH	10	681-5032
61111-77	JGI-61111-77	Gasket, Fuel Cap, Thick, '77-84 FX, FXE, FL, FLH, FLH-80	10	681-5004
61114-48	JGI-61114-48	Gasket, Fuel Cap, Thin, '66-Up FL, FLH	10	681-5005
61116-65	JGI-61116-65	Gasket, Fuel Cap, Left, '65-82 FL, FLH, FLH-80	10	681-5003
68121-55	JGI-68121-55	Gasket, Tail Lamp Lens, '66-72 FL, FLH	10	681-5027
68122-55	JGI-68122-55	Gasket, Tail Lamp Lens, '66-72 FL, FLH	10	681-5028
68123-55	JGI-68123-55	Gasket, Tail Lamp Mounting, '66-72 FL, FLH	10	681-5029
68520-63	JGI-68520-63	O-ring, Turn Signal Mounting, '65-85 FL, FLH, FLHT, FX	10	681-5030



## PANHEAD GASKETS & SEALS

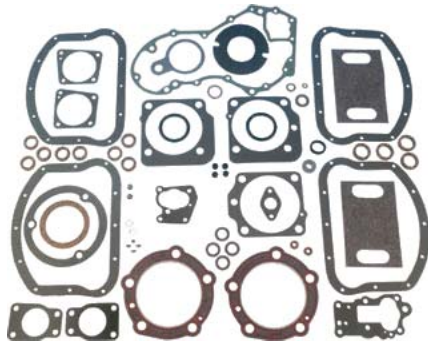

- Genuine James Gaskets uses state of the art materials and production methods to make the best gaskets available
- Comprehensive gasket kits for many applications as well as individual gaskets are available
- Various material choices available depending on application
- FOAMET - foam covered metal
- MLS - multi layered steel
- RCM - rubber covered metal
- Micropore paper gaskets with or without elastomer bead (Nitrile or Silicone)
- Made in the U.S.A.

OEM#	JGI#	Application	Quantity	WPS#
<b>PANHEAD GASKET KITS</b>				
17028-48	JGI-17028-48	Gasket Kit, Motor, '48-65 Panhead	Kit	<b>681-5051</b>
17034-48	JGI-17034-48	Gasket Kit, Top End, '48-65 Panhead	Kit	<b>681-5053</b>
	JGI-17028-48-F	Gasket Kit, Motor, Includes Foamet Base Gaskets, '48-65 Panhead	Kit	<b>681-5050</b>
	JGI-17034-48-XF	Gasket Kit, Top End, with Firing Head/Foamet Base Gaskets, '48-65 Panhead	Kit	<b>681-5052</b>
	JGI-17955-48-FLR	Seal Kit, Pushrod Cover, Rubber, '48-Early '79 FL, FLH, FLT	Kit	<b>681-4747</b>
	JGI-17955-48-FL	Seal Kit, Pushrod Cover, Cork, '48-Early '79 FL, FLH, FLT	Kit	<b>681-4748</b>
	JGI-48-FL	Gasket Kit, Oil Pump, '48-65 Panhead	Kit	<b>681-4754</b>
	JGI-63800-48-K	Rebuild Kit, Side Mount Oil Filter, '48-64 FL, FLH	Kit	<b>681-5054</b>
	JGI-33031-70	Gasket/Seal Kit, Transmission, 36-86 All 4-Speed Transmissions	Kit	<b>681-4412</b>
	JGI-35230-39-K	Oil Seal Kit, Trans. Main Drive 4-Speed, '48-65 FL, FLH	Kit	<b>681-4757</b>
	JGI-36025-36-X	Oil Seal, Transmission Countershaft, w/ Screws/Lockwashers, 4-Speed Trans.	Kit	<b>681-4758</b>
	JGI-60540-36-K	Gasket/Seal Kit, Primary Cover, '48-64 FL, FLH	Kit	<b>681-5055</b>
	JGI-27002-57	Gasket Kit, Intake Manifold, Bendix/Keihin, '57-85 XL, 66-84 Shovel, '48-65 Pan	Kit	<b>681-4776</b>
	JGI-27411-40-A	Gasket Kit, Intake Manifold, Linkert to Bendix/Keihin Conversion	Kit	<b>681-5056</b>
	JGI-27002-78-2	Gasket Kit, Manifold Mounting, Panhead, Shovelhead, Ironhead XL	Kit	<b>681-4775</b>
	JGI-27002-66-SS	Gasket Kit, S&S Carburetor, Panhead Shovelhead Sportster	Kit	<b>681-4778</b>
	JGI-27002-66-SU	Gasket Kit, SU Carburetor to Manifold, Sportster Panhead Shovelhead	Kit	<b>681-4779</b>
	JGI-45849-49-A	Gasket/Seal Kit, Front Fork with Metal Spacer, 49-65 FL, FLH	Kit	<b>681-4768</b>
	JGI-45849-49	Gasket/Seal Kit, Front Fork, with Felt Washer, 49-65 FL, FLH	Kit	<b>681-4769</b>
	JGI-WHEEL-KIT	Gasket/Seal Kit, Wheel Bearing, '48-66 FL, FLH	Kit	<b>681-5057</b>
	JGI-68123-55-K	Gasket Kit, Tail Lamp Mounting, '55-65 FL, FLH	Kit	<b>681-4780</b>
<b>PANHEAD INDIVIDUAL GASKETS, SEALS, O-RINGS 48-UP</b>				
<b>ROCKER BOX ASSEMBLY GASKETS</b>				
17507-48	JGI-17507-48	Felt, Rocker Cover, '48-65 Panhead	10	<b>681-5064</b>
17541-48B	JGI-17541-48-DL	Gasket, Rocker Cover, 1/8" Thick Rubber/Steel, '48-65 Panhead	2	<b>681-5060</b>
17541-48B	JGI-17541-48-A	Gasket, Rocker Cover, .062" Paper, '48-65 Panhead	10	<b>681-5061</b>
17541-48B	JGI-17541-48-B	Gasket, Rocker Cover, .031" Paper, '48-65 Panhead	10	<b>681-5062</b>
17541-48B	JGI-17541-48-C	Gasket, Rocker Cover, .125" Cork, '48-65 Panhead	5	<b>681-5063</b>
<b>PUSHROD, TAPPET GASKETS AND VALVE STEM SEALS</b>				
11101	JGI-11101	O-ring, Rocker Cover to Pushrod Tube, '57-65 FL, FLH	25	<b>681-4810</b>
17955-36	JGI-17955-36	Seal, Pushrod Cover, Small, Cork, '48-65 All Models	100	<b>681-4815</b>
17955-36A	JGI-17955-36-A	Seal, Pushrod Cover, Small, Rubber, '48-65 All Models	100	<b>681-4813</b>
17955-48	JGI-17955-48	Seal, Pushrod Cover, Large, Cork, '48-65 FL, FLH, FLT, FX	100	<b>681-4819</b>
17955-48A	JGI-17955-48-A	Seal, Pushrod Cover, Large, Rubber, '48-65 FL, FLH, FLT, FX	100	<b>681-4817</b>
18196-51	JGI-18196-51	Gasket, Valve Guide, '51-65 Panhead	20	<b>681-4826</b>
18633-48C	JGI-18633-48-A/C	Gasket, Tappet Block, Rear, .031" Paper, '48-65 Big-Twin	10	<b>681-4467</b>
18634-48C	JGI-18634-48-A/B	Gasket, Tappet Block, Front, .031" Paper, '48-65 Big-Twin	10	<b>681-4466</b>
6762B	JGI-6762-B	Washer Pushrod Tube Spring Backup '48-65 Big-Twin	20	<b>681-4473</b>
	JGI-17955-36-A-25	Seal, Pushrod Cover, Small, Rubber, '48-65 All Models	25	<b>681-4814</b>
	JGI-17955-36-25	Seal, Pushrod Cover, Small, Cork, '48-65 All Models	25	<b>681-4816</b>
	JGI-17955-48-A-25	Seal, Pushrod Cover, Large, Rubber, '48-65 FL, FLH, FLT, FX	25	<b>681-4818</b>
	JGI-17955-48-25	Seal, Pushrod Cover, Large, Cork, '48-65 FL, FLH, FLT, FX	25	<b>681-4820</b>
	JGI-11101-X	O-ring, Rocker Cover to Pushrod Tube, Oversized 11101, '57-65 FL, FLH	25	<b>681-4811</b>
	JGI-18634-48-F	Gasket, Tappet Block, Front, Foamet, '48-65 Big-Twin	5	<b>681-4464</b>
	JGI-18633-48-F	Gasket, Tappet Block, Rear, .Foamet, '48-65 Big-Twin	5	<b>681-4465</b>
	JGI-18000-48	Seal, Valve Stem, Intake/Exhaust, '48-65 Big-Twin	4	<b>681-4824</b>
	JGI-18000-48-10	Seal, Valve Stem, Intake/Exhaust, '48-65 Big-Twin	10	<b>681-4825</b>

- WINDSHIELDS / FAIRINGS
- AUDIO / COMMUNICATION
- SEATS / LUGGAGE
- BARS / MIRRORS / CONTROLS
- EXHAUST
- AIR / FUEL SYSTEMS
- ENGINE
- TRANSMISSION / DRIVELINE
- GASKETS / SEALS**
- ELECTRICAL
- LIGHTING
- CABLES
- BRAKES
- OIL FILTERS
- SUSPENSION
- BODY
- WHEELS
- TIRES / TIRE ACC.
- BIKE ACC.
- VICTORY / INDIAN
- COVERS / LOCKS / TIEDOWNS
- CHEMICALS
- TOOLS
- HELMETS
- HELMET ACC.
- EYEWEAR
- APPAREL / RIDER ACC.
- PROMOTIONAL
- REFERENCE
- INDEX



## PANHEAD GASKETS & SEALS

OEM#	JGI#	Application	Quantity	WPS#
<b>PANHEAD INDIVIDUAL GASKETS, SEALS, O-RINGS 48-UP</b>				
<b>HEAD AND BASE GASKETS</b>				
16770-48	JGI-16770-48-X	Gasket, Cylinder Head, .045" with Firing '48-65 Panhead	2	<b>681-5080</b>
16770-48	JGI-16770-48	Gasket, Cylinder Head, .045" Blue Teflon '48-65 Panhead	5	<b>681-5081</b>
16776-48	JGI-16776-48	Gasket, Cylinder Base, Front, .032" Paper, '48-62 Panhead	10	<b>681-5083</b>
16777-48	JGI-16777-48	Gasket, Cylinder Base, Rear, .032" Paper, '48-62 Panhead	10	<b>681-5084</b>
	JGI-16776-48-XF	Gasket Set, Cylinder Base, Front/Rear, .030" Foamit with Bead, '48-62 Panhead	2	<b>681-5082</b>
<b>MOTOR CASE O-RINGS AND SEALS</b>				
12002	JGI-12002	Oil Seal, Generator Small End, '58-65 FL, FLHG	5	<b>681-5006</b>
25811-11	JGI-25811-11	Washer, Generator Gear Stud, Red Fibre, '48-65 FL, FLH	20	<b>681-5001</b>
30143-30	JGI-30143-30	Gasket, Generator Mounting, Early Style, '48-57 FL, FLH	10	<b>681-5102</b>
30143-58	JGI-30143-58	Gasket, Generator Mounting, Late Style, '58-65 FL, FLH	10	<b>681-5101</b>
30145-46A	JGI-30145-46-A	Oil Seal, Generator Gear End, '48-65 FL, FLH	5	<b>681-5007</b>
31015-30	JGI-31015-30	Gasket, Generator Bearing End, '48-64 FL, FLH	10	<b>681-5103</b>
32521-36	JGI-32521-36	Gasket, Circuit Breaker Stem, '48-65 Panhead	10	<b>681-5002</b>
	JGI-24776-40-X	Oil Seal/Retainer Kit, Motor Shaft, Heavy Duty, '48-54 Big-Twin	Kit	<b>681-5100</b>
<b>OIL AND OIL PUMP GASKETS</b>				
6156	JGI-6156	Washer, Oil Pump Adjusting Screw, Brass, '48-65 FLH	10	<b>681-4867</b>
6377	JGI-6377	Washer, Oil Pump Body Plug, Brass, Late '50-65 FL, FLH	10	<b>681-4868</b>
6581	JGI-6581	Washer, Oil Pump Body Plug, Brass, '54-65 FL, FLH	10	<b>681-4869</b>
8866	JGI-8866	Ball Bearing, Oil Pump, 3/8" Dia. (a.k.a. 8873), '48-65 FLT	10	<b>681-4523</b>
26227-58	JGI-26227-58	Oil Seal, Oil Pump, '58-65 FL, FLH	5	<b>681-4872</b>
26245-41	JGI-26245-41	Gasket, Oil Pump, Body, Paper, '48-65 FL, FLH	10	<b>681-4865</b>
26255-41	JGI-26255-41	Gasket, Oil Pump, Cover, Paper, '48-49 FL, FLH	10	<b>681-5121</b>
26257-41	JGI-26257-41	Gasket, Oil Pump, Cover, Paper, '48-50 FL, FLH	10	<b>681-5120</b>
26257-50A	JGI-26257-50-A	Gasket, Oil Pump, Cover, Paper, '50-65 FL, FLH	10	<b>681-4864</b>
26340-36	JGI-26340-36	Key, Oil Pump Shaft, Short, '48-65 FL, FLH	10	<b>681-4866</b>
26348-15	JGI-26348-15	Key, Oil Pump Shaft, Long, '48-65 FL, FLH	10	<b>681-4521</b>
26348-36	JGI-26348-36	C-Clip, Oil Pump Shaft, '48-65 FL, FLT	10	<b>681-4522</b>
62628-36	JGI-62628-36	Gasket, Oil Tank Cap, Copper, '53-65 FL, FLH	10	<b>681-5123</b>
63529-50	JGI-63529-50	Seal, Oil Tank Line, 49-65 FL, FLH	10	<b>681-5126</b>
63529-57	JGI-63529-57	Seal, Oil Line, '57-65 FL, FLH	25	<b>681-4871</b>
63809-48	JGI-63809-48-DL	Seal, Oil Filler Cap, Molded Rubber, '48-64 FL, FLH	5	<b>681-5125</b>
63848-48	JGI-63848-48	Gasket, Oil Filter Retainer, '48-65 FL, FLH	10	<b>681-5124</b>
63879-53	JGI-63879-53	O-ring, Oil Filter Cup, '50-65 FL, FLH	10	<b>681-4875</b>
<b>CAM HOUSING</b>				
25225-36C	JGI-25225-36-CX	Gasket, Cam Gear Cover, '48-65 FL, FLH with Silicone Beading 0.020" thick	5	<b>681-4880</b>
25225-36C	JGI-25225-36-C	Gasket, Cam Gear Cover, '48-65 FL, FLH	10	<b>681-4881</b>
<b>INTAKE AND EXHAUST GASKETS</b>				
27060-55	JGI-27060-55-V	O-ring, Intake Manifold, Viton,	2	<b>681-4894</b>
27060-55	JGI-27060-55	O-ring, Intake Manifold,	10	<b>681-4893</b>
27410-57	JGI-27410-57	Gasket, Intake Manifold,	10	<b>681-5140</b>
	JGI-27186-04-SU	Gasket, SU Carb. to Manifold, 1.86" Bore, Sportster, Panhead, Shovelhead	5	<b>681-4918</b>
	JGI-27200-04-SU	Gasket, SU Carb. to Manifold, 2.00" Bore, Sportster, Panhead, Shovelhead	5	<b>681-4919</b>
	JGI-29059-04-SU	Gasket, SU Carb. to Manifold, Sportster, Panhead, Shovelhead	5	<b>681-4920</b>
<b>CARB GASKETS</b>				
24990-52	JGI-24990-52	Seal, Check Valve, Cork, '52-65 FL, FLH	10	<b>681-5163</b>
27374-57	JGI-27374-57	Washer, Fibre, '57-65 Tillitson Carburetors	10	<b>681-4912</b>
27378-57	JGI-27378-57	Washer, Drain Plug, Fibre, '56-65 FL	20	<b>681-5166</b>
27402-33	JGI-27402-33	Washer, Needle Valve Cap, Fibre, '48-65 Linkert Carburetors	20	<b>681-5164</b>
62085-40	JGI-62085-40	Washer, Shut Off Rod Seat, Brass, '48-58 FL, FLH	10	<b>681-5165</b>
62270-32	JGI-62270-32	Gasket, Strainer Assembly, Cork, '48-65 FL, LFH	10	<b>681-5161</b>
62360-50	JGI-62360-50	Seal, Gas Line, '50-65 FL, FLH	10	<b>681-5162</b>
<b>PRIMARY HOUSING GASKETS</b>				
24931-39	JGI-24931-39	Seal, Front Chain Inner Cover, tin primary	10	<b>681-5178</b>
60540-36	JGI-60540-36	Gasket, Primary Cover, Cork Strip, tin primary	10	<b>681-5175</b>
60565-36	JGI-60565-36	Gasket, Clutch Derby Cover, Cork, tin primary	10	<b>681-5176</b>
60567-36	JGI-60567-36	Gasket, Inspection Cover, Cork, tin primary	10	<b>681-5177</b>
60629-55	JGI-60629-55	Gasket, Inner Primary to Engine, tin primary	10	<b>681-5179</b>



## PANHEAD GASKETS &amp; SEALS



OEM#	JGI#	Application	Quantity	WPS#
<b>PANHEAD INDIVIDUAL GASKETS, SEALS, O-RINGS 48-UP</b>				
<b>TRANSMISSION GASKETS</b>				
33076-37	JGI-33076-37	Seal, Starter Crankshaft (Kick Start), 4-Speed, '48-65 FL, FLH	10	<b>681-4988</b>
33295-36	JGI-33295-36-X	Gasket, Transmission End Cover, Paper with Bead, '48-65 4-Speed Transmissions	5	<b>681-4656</b>
33295-36	JGI-33295-36	Gasket, Transmission End Cover, Paper, '48-65 4-Speed Transmissions	10	<b>681-4657</b>
34036-36	JGI-34036-36	Seal, Transmission Shifter Fork Shaft, '48-65 FL, FLH	10	<b>681-4971</b>
34552-52	JGI-34552-52	Gasket, Transmission Shifter Assembly, '52-65 FL, FLH	10	<b>681-4976</b>
34565-52	JGI-34565-52	Gasket, Transmission Shifter Plate, 4-Speed, '52-65 FL, FLH	10	<b>681-4977</b>
34824-36	JGI-34824-36	Gasket, Transmission Top Cover, '48-65 All 4-Speed Transmissions	10	<b>681-4970</b>
35175-38	JGI-35175-38	Key, Main Drive Gear, '48-65 4-Speed Transmissions	5	<b>681-4975</b>
35216-36	JGI-35216-36	Lock Tab, Sprocket to Main Drive Gear, '48-65 4-Speed Transmissions	5	<b>681-4972</b>
35230-39	JGI-35230-39-DL	Oil Seal, Transmission Main Drive Gear, '48-65 FL, FLH	1	<b>681-4980</b>
35231-36	JGI-35231-36	Washer, Main Drive Oil Seal, Cork, '48-65 FL, FLH	10	<b>681-4974</b>
36025-36	JGI-36025-36	Gasket, Transmission Countershaft Cover, '48-64 4-Speed Transmissions	10	<b>681-5190</b>
37337-36	JGI-37337-36	Seal, Clutch Pushrod, Cork/Rubber, '48-64 FL, FLH	10	<b>681-5191</b>
37503-41	JGI-37503-41	Lock Tab, Clutch Hub Nut, '48-65 4-Speed Transmissions	5	<b>681-4952</b>
	JGI-35211-85-DL	Super Nut Replacement Oil Seal, Fits JGI-35211-36-DL Super Nut for 4-Speed Transmissions	5	<b>681-4989</b>
	JGI-35607-73-X	Plug, Speedometer Drive Hole, Molded Rubber/Steel, 4-Speed Transmissions	1	<b>681-4984</b>
<b>MISCELLANEOUS GASKETS, SEALS, AND O-RINGS</b>				
41210-55	JGI-41210-55	Oil Seal, Wheel Bearing, '55-65 FL, FLH	5	<b>681-5026</b>
43570-35	JGI-43570-35	Seal, Wheel, Small Cork Washer, '48-65 FL, FLH	10	<b>681-5200</b>
43571-35	JGI-43571-35	Seal, Wheel, Large Cork Washer, '48-65 FL, FLH	10	<b>681-5201</b>
43576-35	JGI-43576-35	Gasket, Wheel Bearing Cover, '48-65 FL, FLH	10	<b>681-5202</b>
45733-48	JGI-45733-48	Seal, Front Tube Plug, '48-65 FL, FLH	10	<b>681-4723</b>
45850-48	JGI-45850-48	Washer, Front Fork, Felt, '49-65 FLT, FLH	10	<b>681-5017</b>
45852-48	JGI-45852-48	Oil Seal, Front Fork, '49-65 FL, FLH	5	<b>681-5012</b>
46111-48	JGI-46111-48	Gasket, Fork Damper Tube, '49-65 FL, FLH	10	<b>681-5022</b>
46125-48	JGI-46125-48	Gasket, Fork Damper Tube, '49-65 FL, FLH	10	<b>681-5023</b>
47519-58	JGI-47519-58	Oil Seal, Wheel Bearing, '58-65 FL, FLH	5	<b>681-5025</b>
61114-48	JGI-61114-48	Gasket, Fuel Cap, Thin, '48-65 FL, FLH	10	<b>681-5005</b>
67141-36	JGI-67141-36	Gasket, Speedometer Drive Gear, '48-65 FL, FLH	10	<b>681-4973</b>
68121-55	JGI-68121-55	Gasket, Tail Lamp Lens, '55-65 FL, FLH	10	<b>681-5027</b>
68122-55	JGI-68122-55	Gasket, Tail Lamp Lens, '55-65 FL, FLH	10	<b>681-5028</b>
68123-55	JGI-68123-55	Gasket, Tail Lamp Mounting, '55-65 FL, FLH	10	<b>681-5029</b>



WINDSHIELDS / FAIRINGS

AUDIO / COMMUNICATION

SEATS / LUGGAGE

BARS / MIRRORS / CONTROLS

EXHAUST

AIR / FUEL SYSTEMS

ENGINE

TRANSMISSION / DRIVELINE

GASKETS / SEALS

ELECTRICAL

LIGHTING

CABLES

BRAKES

OIL FILTERS

SUSPENSION

BODY

WHEELS

TIRES / TIRE ACC.

BIKE ACC.

VICTORY / INDIAN

COVERS / LOCKS / TIEDOWNS

CHEMICALS

TOOLS

HELMETS

HELMET ACC.

EYEWEAR

APPAREL / RIDER ACC.

PROMOTIONAL

REFERENCE

INDEX



# EVOLUTION SPORTSTER GASKETS & SEALS

- Genuine James Gaskets uses state of the art materials and production methods to make the best gaskets available
- Comprehensive gasket kits for many applications as well as individual gaskets are available
- Various material choices available depending on application
- FOAMET - foam covered metal
- MLS - multi layered steel
- RCM - rubber covered metal
- Micropore paper gaskets with or without elastomer bead (Nitrile or Silicone)
- Made in the U.S.A.

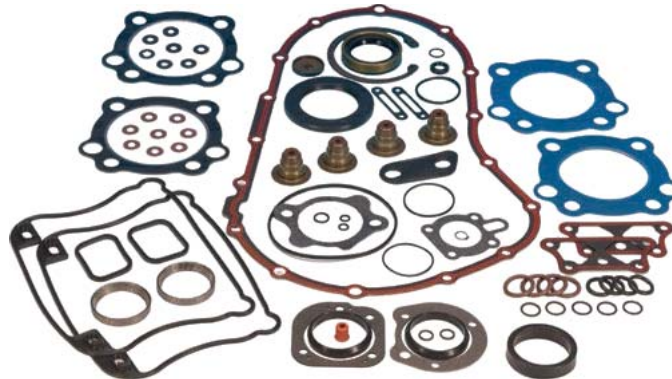

OEM#	JGI#	Application	Quantity	WPS#
<b>EVOLUTION SPORTSTER GASKET KITS</b>				
17027-04B	JGI-17047-07-X	Gasket Kit, Motor, '07-Up XL Sportster w/Metal Cylinder Base/Rocker Cover Base Gaskets	Kit	<b>681-5210</b>
17027-04	JGI-17047-04-X	Gasket Kit, Motor, '04-06 Sportster w/Metal Cylinder Base/Rocker Cover Base Gaskets	Kit	<b>681-5211</b>
17026-91	JGI-17026-91-MLS	Gasket Kit, Motor, w/MLS Head Gaskets, '91-03 Sportster	Kit	<b>681-5212</b>
17026-91	JGI-17026-91	Gasket Kit, Motor, Rubber Rocker Cover/.045" Head Gaskets, '91-Up 883cc Sportster	Kit	<b>681-5213</b>
17026-86A	JGI-17026-86-MLS	Gasket Kit, Motor, w/MLS Head Gaskets, '86-90 Sportster	Kit	<b>681-5214</b>
17026-86A	JGI-17026-86	Gasket Kit, Motor, w/Metal Base/Rocker Cover Gaskets, '86-90 Sportster	Kit	<b>681-5215</b>
17049-04A	JGI-17049-07-X	Gasket Kit, Top End, '07-Up XL Sportster w/Metal Cylinder Base/Rocker Cover Base Gaskets	Kit	<b>681-5216</b>
17049-04	JGI-17049-04-X	Gasket Kit, Top End, '04-06 Sportster w/Metal Cylinder Base/Rocker Cover Base Gaskets	Kit	<b>681-5217</b>
17032-91A	JGI-17032-91-MLS	Gasket Kit, Top End, w/MLS Head Gaskets, '91-03 Sportster	Kit	<b>681-5218</b>
17032-91A	JGI-17032-91	Gasket Kit, Top End, w/Metal Rocker Base Gaskets, '91-03 Sportster	Kit	<b>681-5219</b>
17032-86A	JGI-17032-86-MLS	Gasket Kit, Top End, w/MLS Head Gaskets, '86-90 Sportster	Kit	<b>681-5220</b>
17032-86A	JGI-17032-86-B	Gasket Kit, Top End, w/Metal Rocker Base Gaskets, '86-90 Sportster	Kit	<b>681-5221</b>
	JGI-17030-07-X	Gasket Kit, Rocker Cover, '07-Up XL Sportster w/Metal Rocker Base Gaskets	Kit	<b>681-5222</b>
	JGI-17030-07	Gasket Kit, Rocker Cover, '07-Up XL Sportster WITHOUT Metal Rocker Base Gaskets	Kit	<b>681-5223</b>
	JGI-17030-04-X	Gasket Kit, Rocker Cover, '04-06 Sportster w/Metal Rocker Base Gaskets	Kit	<b>681-5224</b>
	JGI-17030-91-X	Gasket Kit, Rocker Cover, w/Metal Rocker Base Gaskets, '91-03 Sportster	Kit	<b>681-5225</b>
	JGI-17030-91	Gasket Kit, Rocker Cover, w/Paper Rocker Base Gaskets, '91-03 Sportster	Kit	<b>681-5226</b>
	JGI-17030-89-X	Gasket Kit, Rocker Cover, w/Metal Rocker Base Gaskets, '86-90 Sportster	Kit	<b>681-5227</b>
	JGI-17030-89	Gasket Kit, Rocker Cover, w/Paper Rocker Base Gaskets, '86-90 Sportster	Kit	<b>681-5228</b>
	JGI-11377-K	Gasket Kit, Tappet/Pushrod Tube, RCM Gaskets, '04-Up Sportster	Kit	<b>681-5229</b>
	JGI-11190-V2	Seal Kit, Pushrod Cover, '91-Up Sportster	Kit	<b>681-5230</b>
	JGI-25263-04-KX	Gasket Kit, Cam Gear Cover, '04-Up Sportster	Kit	<b>681-5231</b>
	JGI-25263-00-KX	Gasket Kit, Cam Gear Cover, '00-03 Sportster	Kit	<b>681-5232</b>
	JGI-77-XL	Gasket/Seal Kit, Oil Pump, '77-90 XL, XLH, XLCH, XLGR, XLX, XLS	Kit	<b>681-5233</b>
	JGI-04-XL	Gasket Kit, Oil Pump Mounting, w/DL-Style Gasket, '91-Up Sportster	Kit	<b>681-5234</b>
	JGI-91-XL	Gasket/Seal Kit, Oil Pump Mounting, w/Paper Gasket, '91-Up Sportster	Kit	<b>681-5235</b>
	JGI-34955-04-K	Gasket/Seal Kit, Primary Cover, Paper w/Bead, '04-Up Sportsters	Kit	<b>681-5236</b>
	JGI-34955-04-KF	Gasket/Seal Kit, Primary Cover, Foamet w/Bead, '04-Up Sportsters	Kit	<b>681-5237</b>
	JGI-34955-89-KF	Gasket/Seal Kit, Primary Cover, Foamet w/Bead, '91-03 Sportster	Kit	<b>681-5238</b>
	JGI-34955-89-K	Gasket/Seal Kit, Primary Cover, Paper w/Bead, '91-03 Sportster	Kit	<b>681-5239</b>
	JGI-34955-75-KF	Gasket/Seal Kit, Primary Cover, Foamet w/Bead, '77-90 Sportster	Kit	<b>681-5240</b>
	JGI-34955-75-K	Gasket/Seal Kit, Primary Cover, Paper w/Bead, '77-90 Sportster	Kit	<b>681-5241</b>
	JGI-12074-XL	Oil Seal Kit, Sprocket, '08-Up Sportster	Kit	<b>681-5242</b>
27006-76T	JGI-27006-76	Gasket/Seal Kit, Keihin Carburetor Overhaul, '76-86 XL	Kit	<b>681-4777</b>
	JGI-27002-89-K	Seal Kit, Intake Manifold, '89-Up XL	Kit	<b>681-4424</b>
	JGI-45849-96	Seal Kit, Front Fork, 1996-Up Sportster Sport, All '08 Sportster	Kit	<b>681-5243</b>
	JGI-45849-84-A	Oil Seal Kit, Front Fork, '84-87 Sportster	Kit	<b>681-4420</b>

## EVOLUTION SPORTSTER GASKETS &amp; SEALS



OEM#	JGI#	Application	Quantity	WPS#
<b>EVOLUTION SPORTSTER INDIVIDUAL GASKETS, SEALS, O-RINGS 86-UP</b>				
<b>ROCKER BOX ASSEMBLY GASKETS</b>				
17362-07	JGI-17362-07	Gasket, Rocker Cover, Outer, '07-Up Sportster	5	681-5270
17695-07	JGI-17695-07	Gasket, Rocker Cover, Inner, '07-Up Sportster	10	681-5271
17393-07	JGI-17393-07	Seal, Rocker Cover, Breather, '07-Up Sportster	10	681-5272
17353-89A	JGI-17353-04	Gasket, Rocker Cover, Outer, '04-06 Sportster	5	681-5273
17354-89A	JGI-17354-89	Gasket, Rocker Cover, Upper, Rubber, '91-Up 883, 1100cc Sportster	5	681-5274
17353-89	JGI-17353-89	Gasket, Rocker Cover, Lower, Rubber, '91-Up 883, 1100cc Sportster	5	681-5275
26856-89	JGI-26856-89	Seal, Umbrella Valve, Rocker Cover Breather, '91-99 Sportster	10	681-5276
17354-86A	JGI-17354-86-A	Gasket, Rocker Cover, Upper, Rubber, '86-90 883, 1100cc Sportster	5	681-5277
17353-86A	JGI-17353-86-A	Gasket, Rocker Cover, Lower, Rubber, '86-90 883, 1100cc Sportster	5	681-5278
17354-86	JGI-17354-86	Gasket, Rocker Cover, Upper, Cork, '86-90 883, 1100cc Sportster	5	681-5279
17353-86	JGI-17353-86	Gasket, Rocker Cover, Lower, Cork, '86-90 883, 1100cc Sportster	5	681-5280
16779-99	JGI-16779-99-X	Gasket, Rocker Cover Base, One Piece, RCM w/Bead, '84-99 Sportster	2	681-4448
16779-84B	JGI-16779-84-X	Gasket, Rocker Cover Base, One Piece, Paper w/Bead, '84-99 Sportster	2	681-4449
<b>PUSHROD, TAPPET GASKETS AND VALVE STEM SEALS</b>				
11377	JGI-11377	O-Ring, Pushrod Tube Cover, '04-Up Sportster	10	681-5301
11190	JGI-11190	O-ring, Viton Pushrod Cover to Cylinder Head, '91-Up Sportster	25	681-5302
17944-89	JGI-17944-89	Seal, Pushrod Cover, Rubber, '91-Up 883, 1100cc Sportster	10	681-5303
11176	JGI-11176	O-ring, Tappet Pin Cover, '91-Up Sportster	25	681-5304
11110	JGI-11110	O-ring, Tappet Block, '86-91 Sportster	25	681-5305
11167A	JGI-11167-A	O-ring, Upper Tappet Guide, '86-90 Sportster	25	681-5306
11168A	JGI-11168-A	O-ring, Lower Tappet Guide, '86-90 Sportster	25	681-5307
11145	JGI-11145	O-ring, Tappet Guide to Pushrod Cover, '86-90 Sportster	25	681-4470
11145	JGI-11145-X	Quad Seal, Tappet Guide to Pushrod Cover, '86-90 Sportster	25	681-4471
17976-04	JGI-17976-04-F	Gasket, Tappet Cover, Foamet w/Bead, '04-Up Sportster	2	681-5308
17976-04	JGI-17976-04	Gasket, Tappet Cover, RCM w/Bead, '04-Up Sportster	2	681-5309
18001-83B	JGI-18001-83-A	Seal, Valve Stem, '84-99 Sportster	4	681-4125
<b>HEAD AND BASE GASKETS</b>				
16773-85	JGI-16773-85	Gasket, Cylinder Head, .062" w/Armor, 1100cc Sportster	5	681-4481
16773-85	JGI-16773-85-T	Gasket, Cylinder Head, .045" w/Armor, 1100cc Sportster	5	681-4482
16665-86	JGI-16665-86	Gasket, Cylinder Head, .045" w/Armor, '86-Up 1100cc Sportster	5	681-5330
16664-86	JGI-16664-86	Gasket, Cylinder Head, .045" w/Armor, '86-Up 883cc Sportster	5	681-5331
16774-86A	JGI-16774-86	Gasket, Cylinder Base, '86-Up 883, 1100, 1100cc Sportster	10	681-5332
16774-86A	JGI-16774-96-XT2	Gasket, Cylinder Base, .010" RCM w/Bead, '86-Up Sportster	2	681-5333
16774-86A	JGI-16774-96-XT1	Gasket, Cylinder Base, .016" RCM w/Bead, '86-Up Sportster	2	681-5334
16774-86A	JGI-16774-96	Gasket, Cylinder Base, .0" RCM w/Bead, '86-Up Sportster	2	681-5335
<b>MOTOR CASE O-RINGS AND SEALS</b>				
35151-74	JGI-35151-74	Oil Seal, Engine Sprocket, '86-Up Sportster	5	681-5350
22265-00Y	JGI-26638-00-Y	Gasket, Piston Oiling Jet, '04-Up Sportster	10	681-5351
<b>OIL AND OIL PUMP GASKETS</b>				
26495-89	JGI-26495-89-F	Gasket, Oil Pump Mounting, Foamet, '91-Up 883, 1100cc, Sportster	5	681-5360
26495-89	JGI-26495-89-DL	Gasket, Oil Pump Mounting, Rubber on Steel, '91-Up 883, 1100cc, Sportster	5	681-5361
26495-89	JGI-26495-89	Gasket, Oil Pump Mounting, Paper, '91-Up 883, 1100cc, Sportster	10	681-5362
26495-75	JGI-26495-75-F	Gasket, Oil Pump, Mounting, Foamet, '86-90 XL, XLH	5	681-5363
26495-75	JGI-26495-75	Gasket, Oil Pump, Mounting, Paper, '86-90 XL, XLH	10	681-5364
12036A	JGI-12036-A	Oil Seal, Metal O.D., Oil Pump, '83-90 Sportster	5	681-5365
26434-76A	JGI-26434-76-A	Seal, Oil Pump, Cover, Lathe Cut Ring, '86-90 XL, XLH	10	681-5366
26434-91	JGI-26434-91	O-ring, Oil Pump, Cover, '91-Up 883, 1100cc, Sportster	10	681-5367
<b>CAM HOUSING</b>				
25263-90C	JGI-25263-00-X	Gasket, Cam Gear Cover, Paper w/Bead, '00-Up Sportster	5	681-5380
	JGI-25263-90-F	Gasket, Cam Gear Cover, Foamet®, '90-99 Sportster	5	681-5381
25263-90	JGI-25263-90-X	Gasket, Cam Gear Cover, Paper w/Bead, '90-99 Sportster	5	681-5382
25263-90	JGI-25263-90	Gasket, Cam Gear Cover, Paper, '90-99 Sportster	10	681-5383
	JGI-25263-86-F	Gasket, Cam Gear Cover, Foamet, '86-89 883, 1100, 1100cc Sportster	5	681-5384
25263-86	JGI-25263-86-X	Gasket, Cam Gear Cover, Paper w/Bead, '86-89 Sportster	5	681-5385
25263-86	JGI-25263-86	Gasket, Cam Gear Cover, Paper, '86-89 883, 1100, 1100cc Sportster	10	681-5386
11124	JGI-11124	Oil Seal, Metal O.D., Cam Gear Cover, '71-03 All Sportsters	5	681-5387
11124	JGI-11124-DL	Oil Seal, Rubber O.D. Cam Gear Cover, '71-03 All Sportsters	5	681-5388



**EVOLUTION SPORTSTER GASKETS & SEALS**

WINDSHIELDS / FAIRINGS  
AUDIO / COMMUNICATION  
SEATS / LUGGAGE  
BARS / MIRRORS / CONTROLS  
EXHAUST  
AIR / FUEL SYSTEMS  
ENGINE  
TRANSMISSION / DRIVELINE  
GASKETS / SEALS  
ELECTRICAL  
LIGHTING  
CABLES  
BRAKES  
OIL FILTERS  
SUSPENSION  
BODY  
WHEELS  
TIRES / TIRE ACC.  
BIKE ACC.  
VICTORY / INDIAN  
COVERS / LOCKS / TIEDOWNS  
CHEMICALS  
TOOLS  
HELMETS  
HELMET ACC.  
EYEWEAR  
APPAREL / RIDER ACC.  
PROMOTIONAL  
REFERENCE  
INDEX

OEM#	JGI#	Application	Quantity	WPS#
<b>EVOLUTION SPORTSTER INDIVIDUAL GASKETS, SEALS, O-RINGS 86-UP</b>				
<b>INTAKE AND EXHAUST GASKETS</b>				
29058-77	JGI-29058-77	Gasket, Air Cleaner, .030" Paper, '77-87 XLH, XLS, XLX	10	681-4570
29058-77	JGI-29058-77-A	Gasket, Air Cleaner, .062" Paper, '77-87 XLH, XLS, XLX	10	681-4896
27002-89	JGI-27002-89	Seal, Carburetor to Manifold, '89-Up XL	1	681-4565
27077-78	JGI-27077-78	Gasket, Intake Manifold to Carburetor, '78-89 XL	10	681-4560
27077-78	JGI-27077-78-X	Gasket, Intake Manifold to Carb., Metal w/Bead, '78-89 XL	10	681-4561
11202	JGI-11202	O-ring, Breather Bolt, Air Cleaner, '04-09 Sportster	10	681-5401
	JGI-65927-00	Gasket, Exhaust Interconnect, '04-Up Sportster	2	681-5402
65781-82	JGI-65781-82	Gasket, Exhaust Inter-Connect, '82-03 Sportster	2	681-4574
65324-83A	JGI-65324-83-CG	Gasket, Exhaust, Copper Crush Ring, Evo, Twin-Cam, Sportster, Buell	10	681-4228
65324-83A	JGI-65324-83	Gasket, Exhaust Pipe to Cylinder Head, 1984/Up, All Models Square	10	681-4227
65324-83A	JGI-65324-83-A	Gasket, Exhaust Pipe to Cylinder Head, 1992/Up, All Models Tapered	5	681-4226
<b>CARB AND EFI GASKETS</b>				
27577-92	JGI-27577-92	O-ring, Float Bowl to Carburetor Body, '92-Up Sportster	5	681-4598
27577-88	JGI-27577-88	O-ring, Float Bowl to Carburetor Body, '88-91 Sportster	5	681-4599
27324-83	JGI-27324-83	O-ring, Float Bowl to Carburetor Body, '83-87 XL, XLS, XLX	5	681-4913
27121-89	JGI-27121-89	O-ring, Carb Float Bowl, Viton, '88-Up XL	10	681-4597
27157-89	JGI-27157-89	O-ring, Carburetor Drain Screw, CV Carburetor, '89-91, 883, 1100	10	681-4600
27311-76A	JGI-27311-76-A	Boot, Carburetor, Accelerator Pump, L76-06 Sportster	10	681-4592
27360-76	JGI-27360-76	U-Rings, Accelerator Pump Housing, '76-06, Keihin Carburetors	20	681-4591
27361-76	JGI-27361-76	Diaphragm, Accelerator Pump, '76-06, Keihin Carburetors	1	681-4590
61109-85C	JGI-61109-85-C	O-ring, Fuel Cap, '85-Up Sportster	10	681-4595
<b>PRIMARY HOUSING GASKETS</b>				
34990-08	JGI-34990-08	Gasket, Inspection Cover, FOAMET, '08-Up Sportster	5	681-5420
34955-04	JGI-34955-04-F	Gasket, Primary Cover, Foamet, '04-17 Sportster	1	681-5421
34955-89	JGI-34955-89-F	Gasket, Primary Cover, Foamet w/Bead, '91-03 Sportster	1	681-5422
34955-89	JGI-34955-89-F5	Gasket, Primary Cover, Foamet w/Bead, '91-03 Sportster	5	681-5423
34955-89	JGI-34955-89-X	Gasket, Primary Cover, .030" Paper w/Bead, '91-03 Sportster	5	681-5424
34955-89	JGI-34955-89	Gasket, Primary Cover, .030" Paper, '91-03 Sportster	10	681-5425
34955-75	JGI-34955-75	Gasket, Primary Cover, .030" Paper, '77-90 Sportster	10	681-5426
34955-75	JGI-34955-75-F	Gasket, Primary Cover, Foamet w/Bead, '77-90 Sportster	1	681-5427
34955-75	JGI-34955-75-F5	Gasket, Primary Cover, Foamet w/Bead, '77-90 Sportster	5	681-5428
34955-75	JGI-34955-75-X	Gasket, Primary Cover, .030" Paper w/Bead, '77-90 Sportster	5	681-5429
25437-86	JGI-25437-86	Washer, Clutch Cable, Copper, '86-Up Sportster	10	681-5430
25463-94	JGI-25463-94	Quad Seal, Clutch Cover, '94-Up Sportster	10	681-5431
7019	JGI-7019	Seal, Shifter Shaft to Chain Cover, '91-Up 883, 1100cc Sportster	10	681-5432
11187	JGI-11187	O-ring, Clutch Inspection Cover, '91-03 Sportster	25	681-5433
11188	JGI-11188	O-ring, Primary Inspection Cover, '91-03 Sportster	25	681-5434
11105	JGI-11105	O-ring, Primary Drain Plug	25	681-4126
<b>TRANSMISSION GASKETS</b>				
12050	JGI-12050	Oil Seal, Trans. Main Drive, '91-94 Sportster	1	681-4672
12049	JGI-12049-DL	Oil Seal, Transmission Sprocket Shaft, '84-90 4-Speed Sportster	5	681-5450
11113	JGI-11113	O-ring, Main Shaft, 5th Gear, '06-Up Sportster	10	681-5451
11161	JGI-11161	Retaining Ring, 5th Gear, '08-Up Sportster	1	681-5452
12030	JGI-12030	Bore Seal, Main Drive Gear End, '91-Up, 5-Speed Sportster	5	681-5453
34624-77	JGI-34624-77	Gasket, Shifter Stud Boss, '77-90 Sportster	10	681-5454
37107-06	JGI-37107-06	Oil Seal, Shifter Lever, '06-Up Sportster	5	681-5455
<b>MISCELLANEOUS GASKETS, SEALS, AND O-RINGS</b>				
11139	JGI-11139	O-ring, Filler/Inspection Caps, Late '78-90 Sportster	25	681-5470
31695-90	JGI-31695-90	O-Ring, Starter Motor Yoke Assy., '91-10 Sportster	2	681-4331
31488-81	JGI-31488-81-F	Gasket, Starter Motor, Foamet, '81-Up Sportster	5	681-5471
31488-81	JGI-31488-81	Gasket, Starter Motor, '81-Up Sportster	10	681-5472
11116	JGI-11116	O-ring, Starter Housing Assembly, '81-06 Sportster	25	681-5473
68455-86	JGI-68455-86	O-ring, Turn Signal Lens, '86-Up Sportster	10	681-4705
45401-87	JGI-45401-87	Oil Seal, Fork Tube Dust Cover, '88-09 Sportster	1	681-4727
45387-83	JGI-45387-83	Oil Seal, Front Fork, '83-86, FXR, FXRS, FXRT, FXSB, FXEF, FXRP/84-87 Sportster	1	681-5008
6033	JGI-6033	Washer, Chain Cover, Copper, Sportster	10	681-5474

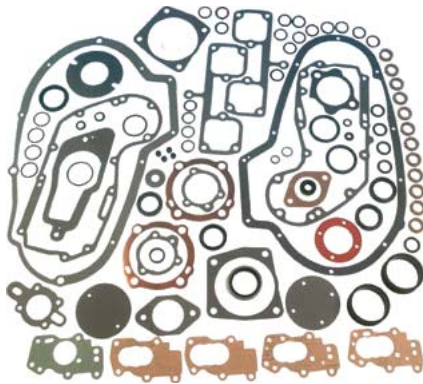

## '57-85 SPORTSTER GASKETS & SEALS

- Genuine James Gaskets uses state of the art materials and production methods to make the best gaskets available
- Comprehensive gasket kits for many applications as well as individual gaskets are available
- Various material choices available depending on application
- FOAMET - foam covered metal
- MLS - multi layered steel
- RCM - rubber covered metal
- Micropore paper gaskets with or without elastomer bead (Nitrile or Silicone)
- Made in the U.S.A.

OEM	JGI#	Application	Quantity	WPS#
<b>'57-85 SPORTSTER GASKET KITS</b>				
17026-71	JGI-17026-71	Gasket Kit, Motor, with Coated Head Gaskets, '57-71 900cc Sportster	Kit	<b>681-5502</b>
17026-73	JGI-17026-73	Gasket Kit, Motor, Copper Head Gaskets, '72-85 1000cc Sportster (except '72-E73)	Kit	<b>681-5501</b>
17030-57	JGI-17030-57	Gasket Kit, Top End, '57-71 900cc Sportster	Kit	<b>681-5504</b>
17030-72A	JGI-17030-72-A	Gasket Kit, Top End, Late '73-85 1000cc Sportster	Kit	<b>681-5503</b>
27006-76T	JGI-27006-76	Gasket/Seal Kit, Keihin Carburetor Overhaul, '76-86 XL	Kit	<b>681-5243</b>
	JGI-11101-XL	O-ring Kit, Pushrod Tube, '79-85 XLH, XLCH	Kit	<b>681-4749</b>
	JGI-17955-36-XLR	Seal Kit, Pushrod Cover, Rubber, '57-79 Sportster	Kit	<b>681-5505</b>
	JGI-17955-36-XL	Seal Kit, Pushrod Cover, Cork, '57-79 Sportster	Kit	<b>681-5506</b>
	JGI-77-XL	Gasket/Seal Kit, Oil Pump, '77-85 XL, XLH, XLCH, XLCR, XLX, XLS	Kit	<b>681-5233</b>
	JGI-54-XL	Gasket/Seal Kit, Oil Pump, '52-76 XL, XLH, XLCH	Kit	<b>681-5507</b>
	JGI-18000-57-K	Seal Kit, Valve Stem, Intake/Exhaust, '57-85 Sportster	Kit	<b>681-5508</b>
	JGI-27002-78	Gasket Kit, Intake to Carb., '66-84 Bendix/Zenith	Kit	<b>681-4774</b>
	JGI-BENDIX	Gasket Kit, Bendix Carburetor, '72-76 XL, XLCH	Kit	<b>681-5509</b>
	JGI-34955-75-KF	Gasket/Seal Kit, Primary Cover, Foamet w/Bead, '77-85 Sportster	Kit	<b>681-5240</b>
	JGI-34955-75-K	Gasket/Seal Kit, Primary Cover, Paper w/Bead, '77-85 Sportster	Kit	<b>681-5241</b>
	JGI-34955-67-K	Gasket Kit, Primary Cover, '67-76 Sportster	Kit	<b>681-5510</b>
	JGI-35150-52	Oil Seal Retainer Kit, Sprocket Shaft Transmission, '52-83 Sportster	Kit	<b>681-5511</b>
	JGI-45849-71	Oil Seal Kit, Front Fork, '71/'72 Only, XLH, XLCH	Kit	<b>681-5512</b>
	JGI-45849-73	Oil Seal Kit, Kayaba Fork, '73/'74 XLH, XLCH	Kit	<b>681-5513</b>
	JGI-45849-75	Oil Seal Kit, Front Fork, '75-83 Sportster	Kit	<b>681-4767</b>
	JGI-45849-84-A	Oil Seal Kit, Front Fork, '84-87 Sportster	Kit	<b>681-4420</b>
	JGI-68123-55-K	Gasket Kit, Tail Lamp Mounting, '55-72 XL, XL, XLH, XLCH	Kit	<b>681-4780</b>
<b>57-85 SPORTSTER INDIVIDUAL GASKETS, SEALS, O-RINGS</b>				
<b>ROCKER BOX GASKETS</b>				
17536-70	JGI-17536-70	Gasket, Rocker Cover, '57-85 900, 1000cc Sportster	10	<b>681-5520</b>
<b>PUSHROD, TAPPET GASKETS AND VALVE STEM SEALS</b>				
11100	JGI-11100	O-ring, Tappet Guide, '57-85 Sportster	25	<b>681-5525</b>
11101	JGI-11101	O-ring, Rocker Cover to Pushrod Tube, '57-85 Sportster	25	<b>681-4810</b>
11132	JGI-11132	O-Ring, Pushrod Tube Covers/Multi Use	25	<b>681-4468</b>
18001-83A	JGI-18001-83-A	Seal, Valve Stem, '84-Up Sportster	4	<b>681-4125</b>
	JGI-11101-X	O-ring, Rocker Cover to Pushrod Tube, Oversized 11101, '57-85 Sportster	25	<b>681-4811</b>
	JGI-18000-57-XLE	Seal Kit, Valve Stem, Exhaust, '57-85 Sportster	10	<b>681-5526</b>
	JGI-18000-57-XLI	Seal Kit, Valve Stem, Intake, '57-85 Sportster	10	<b>681-5527</b>
<b>HEAD AND BASE GASKETS</b>				
16769-57	JGI-16769-57	Gasket, Cylinder Head, .045" Coated Paper, '57-71 Sportster	10	<b>681-5544</b>
16769-72A	JGI-16769-72-A	Gasket, Cylinder Head, .016" Copper, '72-Early '73 1000cc Sportster	10	<b>681-5543</b>
16769-73	JGI-16769-73-T	Gasket, Cylinder Head, .045" Coated Paper, '73-85 1000cc Sportster	10	<b>681-5541</b>
16769-73	JGI-16769-73	Gasket, Cylinder Head, .016" Copper, Late '73-85 1000cc Sportster	10	<b>681-5542</b>
16769-82	JGI-16769-82	Gasket, Cylinder Head, .045" Copper, 82-85 1000cc Sportster	10	<b>681-5540</b>
16774-57	JGI-16774-57	Gasket, Cylinder Base, Front/Rear, '57-71 900cc Sportster	10	<b>681-5546</b>
16774-72	JGI-16774-72	Gasket, Cylinder Base, Front/Rear, '72-85 1000cc Sportster	10	<b>681-5545</b>
<b>MOTOR CASE O-RINGS AND SEALS</b>				
12002	JGI-12002	Oil Seal, Generator Small End, '58-73 XL, XLH, XLXH	5	<b>681-5006</b>
29550-55	JGI-29550-55	Gasket, Magneto Cover, '55-69 XLCH	10	<b>681-5561</b>
29603-48	JGI-29603-48	Oil Seal, Magneto/Circuit Breaker, '58-65 XL, XLCH	10	<b>681-5562</b>
29911-82	JGI-29911-82	Oil Seal, Generator Drive Gear, 82-85 XL, XLH, XLS, XLX	5	<b>681-5563</b>
30143-58	JGI-30143-58	Gasket, Generator Mounting, Late Style, '58-83 XL, XLH, XLCH, XLS	10	<b>681-5101</b>
35151-52A	JGI-35151-52-A	Oil Seal, Engine/Transmission, '52-83 Sportster	5	<b>681-5560</b>
35151-74	JGI-35151-74	Oil Seal, Engine Sprocket, '74-Up Sportster	5	<b>681-5350</b>

- WINDSHIELDS / FAIRINGS
- AUDIO / COMMUNICATION
- SEATS / LUGGAGE
- BARS / MIRRORS / CONTROLS
- EXHAUST
- AIR / FUEL SYSTEMS
- ENGINE
- TRANSMISSION / DRIVELINE
- GASKETS / SEALS**
- ELECTRICAL
- LIGHTING
- CABLES
- BRAKES
- OIL FILTERS
- SUSPENSION
- BODY
- WHEELS
- TIRES / TIRE ACC.
- BIKE ACC.
- VICTORY / INDIAN
- COVERS / LOCKS / TIEDOWNS
- CHEMICALS
- TOOLS
- HELMETS
- HELMET ACC.
- EYEWEAR
- APPAREL / RIDER ACC.
- PROMOTIONAL
- REFERENCE
- INDEX



'57-85 SPORTSTER GASKETS & SEALS

- WINDSHIELDS / FAIRINGS
- AUDIO / COMMUNICATION
- SEATS / LUGGAGE
- BAR / MIRRORS / CONTROLS
- EXHAUST
- AIR / FUEL SYSTEMS
- ENGINE
- TRANSMISSION / DRIVELINE
- GASKETS / SEALS**
- ELECTRICAL
- LIGHTING
- CABLES
- BRAKES
- OIL FILTERS
- SUSPENSION
- BODY
- WHEELS
- TIRES / TIRE ACC.
- BIKE ACC.
- VICTORY / INDIAN
- COVERS / LOCKS / TIEDOWNS
- CHEMICALS
- TOOLS
- HELMETS
- HELMET ACC.
- EYEWEAR
- APPAREL / RIDER ACC.
- PROMOTIONAL
- REFERENCE
- INDEX

OEM	JGI#	Application	Quantity	WPS#
<b>57-85 SPORTSTER INDIVIDUAL GASKETS, SEALS, O-RINGS</b>				
<b>OIL AND OIL PUMP GASKETS</b>				
12036	JGI-12036	Oil Seal, Rubber O.D., Oil Pump, '77-82 Sportster	5	681-5580
12036A	JGI-12036-A	Oil Seal, Metal O.D., Oil Pump, 83-90 Sportster	5	681-5365
26227-58	JGI-26227-58	Oil Seal, Oil Pump, '58-76 XL	5	681-4872
26256-52	JGI-26256-52	Gasket, Oil Pump, Body, Paper, '52-76 K, KH, KHK, XL, XLH, XLCH	10	681-5579
26258-52	JGI-26258-52	Gasket, Oil Pump, Cover, Paper, '52-Early '62/72-76 K, KH, KHK, XL, XLH, XLCH	10	681-5577
26258-62	JGI-26258-62	Gasket, Oil Pump, Cover, Paper, Late '62-Early '71 Only XLH, XLCH	10	681-5575
26259-52	JGI-26259-62	Gasket, Oil Pump, Cover, Paper, Late '62-Early '71 Only XLH, XLCH	10	681-5576
26259-52	JGI-26259-52	Gasket, Oil Pump, Cover, Paper, '52-Early '62/72-76 K, KH, KHK, XL, XLH, XLCH	10	681-5578
26340-36	JGI-26340-36	Key, Oil Pump Shaft, Short, '60-71 Sportster	10	681-4866
26433-77	JGI-26433-77	O-ring, Oil Pump, Check Valve, '77-85 XL, XLH, XLCH, XLCR	10	681-5581
26434-76A	JGI-26434-76-A	Seal, Oil Pump, Cover, Lathe Cut Ring, '77-90 XL, XLH, XLCH, XLCR, XLS, XLX	10	681-5366
26495-75	JGI-26495-75-F	Gasket, Oil Pump, Mounting, Foamet, '77-90 XL, XLH, XLCH, XLCR, XLS, XLX	5	681-5363
26495-75	JGI-26495-75	Gasket, Oil Pump, Mounting, Paper, '77-90 XL, XLH, XLCH, XLCR, XLS, XLX	10	681-5364
62617-52	JGI-62617-52	Gasket, Oil Tank Cap, '52-65 Sportster	10	681-5583
62628-36	JGI-62628-36	Gasket, Oil Tank Cap, Copper, '53-69 XLCH	10	681-5123
62628-66	JGI-62628-66	Gasket, Oil Tank Cap, Cork, '66-Early 82 XLH	10	681-4874
63529-57	JGI-63529-57	Seal, Oil Line, '57-85 XL, XLH, XLCH	25	681-4871
	JGI-35169-52	Gasket, Paper w/Silicone Oil Seal Retainer, '52-83 Sportster	10	681-5582
<b>CAM HOUSING</b>				
11124	JGI-11124-DL	Oil Seal, Rubber O.D. Cam Gear Cover, '71-Up All Sportsters	5	681-5388
11124	JGI-11124	Oil Seal, Metal O.D., Cam Gear Cover, '71-Up All Sportsters	5	681-5387
25224-52A	JGI-25224-52-X	Gasket, Cam Gear Cover, Paper w/Bead, '52-81 Sportster	5	681-5603
25224-52A	JGI-25224-52-A	Gasket, Cam Gear Cover, '52-81 XL, XLCH, XLH, XLCR	10	681-5604
25263-81	JGI-25263-81	Gasket, Cam Gear Cover, Paper, 82-85 XL, XLS, XLX	10	681-5602
	JGI-25263-81-F	Gasket, Cam Gear Cover, Foamet, 82-85 XL, XLS, XLX	5	681-5601
<b>INTAKE AND EXHAUST GASKETS</b>				
27060-55	JGI-27060-55	O-ring, Intake Manifold, '55-77 XL	10	681-4893
27060-55	JGI-27060-55-V	O-ring, Intake Manifold, Viton, '55-77 XL	2	681-4894
27062-78	JGI-27062-78	Seal, Intake Manifold to Cylinder Head, Late '78-84 XL	10	681-4890
27077-78	JGI-27077-78	Gasket, Intake Manifold to Carburetor, '78-89 XL	10	681-4560
27077-78	JGI-27077-78-X	Gasket, Intake Manifold to Carb., Metal with Bead, '78-89 XL	10	681-4561
29058-77	JGI-29058-77	Gasket, Air Cleaner, .030" Paper, '77-87 XLH, XLS, XLX	10	681-4570
29058-77	JGI-29058-77-A	Gasket, Air Cleaner, .062" Paper, '77-87 XLH, XLS, XLX	10	681-4896
65781-82	JGI-65781-82	Gasket, Exhaust Inter-Connect, 82-Up Sportsters	2	681-4574
<b>CARB GASKETS</b>				
24978-57	JGI-24978-57	Gasket, Wire Strainer, Cork, '57-76 Sportster	10	681-5626
27324-83	JGI-27324-83	O-ring, Float Bowl to Carburetor Body, 83-89 XL, XLS, XLX	5	681-4913
27326-71	JGI-27326-71	O-ring, Carburetor Main Jet, Bendix, '71-76 XLH, XLCH	10	681-5627
27646-71	JGI-27646-71	Gasket, Float Bowl to Carburetor, '71-76 XLH, XLCH	10	681-5625
27889-78	JGI-27889-78	O-ring, Float Bowl to Carburetor, '78-83 XL, XLCH	5	681-4914
<b>PRIMARY HOUSING GASKETS</b>				
11106	JGI-11106	O-ring, Filler Cap/Primary Cover, '71-Early '78 XL, XLH, XLCH, XLCR	25	681-5641
34035-52	JGI-34035-52	Oil Seal, Shifter Shaft, '52-Early '84 Sportster	5	681-5640
34624-77	JGI-34624-77	Gasket, Shifter Stud Boss, '77-90 Sportster	10	681-5454
34952-52	JGI-34952-52-A	Gasket, Primary Cover, .062" Paper, '52-69 XL, XLCH	10	681-5638
34952-52	JGI-34952-52	Gasket, Primary Cover, .030" Paper, '52-69 XL, XLCH	10	681-5639
34955-67	JGI-34955-67-F	Gasket, Primary cover, Foamet w/Bead, '67-76 Sportster	1	681-5635
34955-67	JGI-34955-67-F5	Gasket, Primary cover, Foamet w/Bead, '67-76 Sportster	5	681-5636
34955-67	JGI-34955-67-A	Gasket, Primary Cover, .030" Paper, '67-76 Sportster	10	681-5637
34955-75	JGI-34955-75-F	Gasket, Primary Cover, Foamet w/Bead, '77-90 Sportster	1	681-5427
34955-75	JGI-34955-75-F5	Gasket, Primary Cover, Foamet w/Bead, '77-90 Sportster	5	681-5428
34955-75	JGI-34955-75-X	Gasket, Primary Cover, .030" Paper with Bead, '77-90 Sportster	5	681-5429
34955-75	JGI-34955-75	Gasket, Primary Cover, .030" Paper, '77-90 Sportster	10	681-5426

## '57-85 SPORTSTER GASKETS &amp; SEALS



OEM	JGI#	Application	Quantity	WPS#
<b>57-85 SPORTSTER INDIVIDUAL GASKETS, SEALS, O-RINGS</b>				
<b>TRANSMISSION GASKETS</b>				
11103	JGI-11103	O-ring, Clutch Gear, '57-69 XL, XLH, XLCH	25	<b>681-5655</b>
11119	JGI-11119	O-ring, Clutch Gear, '67-70 XLH/'70 XLCH Only	25	<b>681-5654</b>
12021	JGI-12021	Oil Seal, Clutch Gear, Double Lip, '67-70 XLH, '70 XLCH	5	<b>681-5653</b>
12049	JGI-12049-DL	Oil Seal, Transmission Sprocket Shaft, '84-90 4-Speed Sportster	5	<b>681-5450</b>
33076-37	JGI-33076-37	Seal, Starter Crankshaft (Kick Start), 4-Speed, '57-84 XL, XLH	10	<b>681-4989</b>
37339-53	JGI-37339-53	Oil Seal, Clutch Release Gear, '53-70 XLH, XLCH	10	<b>681-5651</b>
37531-56	JGI-37531-56-B	Oil Seal, Clutch Gear, '56-69 Sportster	5	<b>681-5652</b>
37740-57	JGI-37740-57	Oil Seal, Clutch Hub, '57-69 XL, XLH, XLCH	5	<b>681-5656</b>
37741-67	JGI-37741-67	Oil Seal, Main Drive Gear, Rubber O.D., '67-70 XLH, XLCH	5	<b>681-5657</b>
37741-67	JGI-37741-67-A	Oil Seal, Main Drive Gear, Metal O.D., '67-70 XLH, XLCH	1	<b>681-5658</b>
37762-52	JGI-37762-52	Gasket, Clutch Hub Cover, '52-70 Sportster	10	<b>681-5650</b>
<b>MISCELLANEOUS GASKETS, SEALS, AND O-RINGS</b>				
11102	JGI-11102	O-ring, Circuit Base Mounting, '66-69 XLH	25	<b>681-5684</b>
11116	JGI-11116	O-ring, Starter Housing Assembly, '81-92 Sportster	25	<b>681-5474</b>
11139	JGI-11139	O-ring, Filler/Inspection Caps, Late '78-90 Sportster	25	<b>681-5470</b>
27378-57	JGI-27378-57	Washer, Drain Plug, Fibre, '56-65 XL, XLCH	20	<b>681-5166</b>
31461-70	JGI-31461-70	Gasket, Starter Cover Plate, '70-80 XLCH	10	<b>681-5674</b>
31471-67	JGI-31471-67-A	Gasket, Starter Housing, '67-80 XLH, XLS	10	<b>681-5675</b>
31488-77	JGI-31488-77-F	Gasket, Starter Motor, Foamet, '77-80 XLH, XLCR, XLS	5	<b>681-5672</b>
31488-77	JGI-31488-77	Gasket, Starter Motor, '77-80 XLH, XLCR, XLS	10	<b>681-5673</b>
31488-81	JGI-31488-81-F	Gasket, Starter Motor, Foamet, '81-Up Sportster	5	<b>681-5472</b>
31488-81	JGI-31488-81	Gasket, Starter Motor, '81-Up Sportster	10	<b>681-5473</b>
32591-70	JGI-32591-70-F	Gasket, Circuit Breaker Cover, 2 Hole, Foamet, '70-79 XL, XLH, XLCH	5	<b>681-5670</b>
32591-70	JGI-32591-70	Gasket, Circuit Breaker Cover, 2 Hole, Paper, '70-79 XL, XLH, XLCH	10	<b>681-5671</b>
35154-52	JGI-35154-52	Retainer, Use with engine/transmission oil seal '52-83 Sportster	1	<b>681-5686</b>
41210-55	JGI-41210-55	Oil Seal, Wheel Bearing, '55-72 XL, XLH, XLCH	5	<b>681-5026</b>
45125-52	JGI-45125-52	Gasket, Fork Damper Tube, '52-67 XL, XLH, XLCH	10	<b>681-5677</b>
45400-75	JGI-45400-75	Oil Seal, Front Fork, '75-83 XLH, XLCH, XLCR	1	<b>681-5010</b>
45406-75	JGI-45406-75	Washer, Fork Air Control/Damper Screw, Copper, '75-85 XLH, XLCH	10	<b>681-5020</b>
45780-52	JGI-45780-52	O-ring, Fork Tube Cap, '52-70 XL, XLH, XLCH	10	<b>681-5683</b>
45927-73	JGI-45927-73	Oil Seal, Front Fork, '73-77 XLH, XLCH	5	<b>681-5011</b>
45968-59	JGI-45968-59	Washer, Front Fork, Rubber, '59-70 XLH, XLCH	10	<b>681-5682</b>
45975-71	JGI-45975-71	Oil Seal, Front Fork, '71-72 XLH, XLCH	5	<b>681-5681</b>
45982-73	JGI-45982-73	O-ring, Fork Slider Tube, '73-77 XLH, XLCH	10	<b>681-5015</b>
45986-73	JGI-45986-73	Washer, Fork Drain Screw, Fibre, '73-77 XLH, XLCH	10	<b>681-5018</b>
45992-73	JGI-45992-73	Washer, Fork Damper Screw, '73-75 XLH, XLCH	10	<b>681-5016</b>
47519-72	JGI-47519-72-2	Oil Seal, Wheel Bearing, '72-83 XL, XLCH	2	<b>681-5679</b>
47519-72	JGI-47519-72	Oil Seal, Wheel Bearing, '72-83 XLH, XLCH	5	<b>681-5680</b>
47519-83A	JGI-47519-83-DL	Oil Seal, Wheel Bearing, '84-Early 85 XL, XLH, XLS	5	<b>681-5685</b>
62628-52	JGI-62628-52	Gasket, Fuel/Oil Tank Cap, '52-66 XL, XLH, XLCH	10	<b>681-5676</b>
68121-55	JGI-68121-55	Gasket, Tail Lamp Lens, '55-72 XL, XLH, XLCH	10	<b>681-5027</b>
68122-55	JGI-68122-55	Gasket, Tail Lamp Lens, '55-72 XL, XLH, XLCH	10	<b>681-5028</b>
68123-55	JGI-68123-55	Gasket, Tail Lamp Mounting, '55-72 XL, XLH, XLCH	10	<b>681-5029</b>
68123-73	JGI-68123-73	Gasket, Tail Lamp Mounting, '73-Up All Models	10	<b>681-4701</b>
68481-73	JGI-68481-73	Gasket, Turn Signal Lens, '73-85 XL, XLCH	10	<b>681-5678</b>

WINDSHIELDS / FAIRINGS

AUDIO / COMMUNICATION

SEATS / LUGGAGE

BARS / MIRRORS / CONTROLS

EXHAUST

AIR / FUEL SYSTEMS

ENGINE

TRANSMISSION / DRIVELINE

GASKETS / SEALS

ELECTRICAL

LIGHTING

CABLES

BRAKES

OIL FILTERS

SUSPENSION

BODY

WHEELS

TIRES / TIRE ACC.

BIKE ACC.

VICTORY / INDIAN

COVERS / LOCKS / TIEDOWNS

CHEMICALS

TOOLS

HELMETS

HELMET ACC.

EYEWEAR

APPAREL / RIDER ACC.

PROMOTIONAL

REFERENCE

INDEX



## GASKET BOARDS

- Sturdy four-color gasket display boards
- 32" tall x 48" wide
- Come ready to mount 1/8" or 1/4" peg board
- Peg board hooks included
- Made from durable 20-mil stay flat vinyl
- Water and oil proof
- Large Stocking Kits include 1 package of each gasket seal and O-ring

### SHOVELHEAD

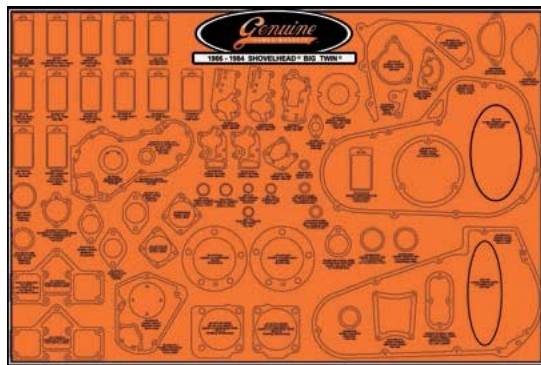

- Small Stocking kit includes 1 package of each
- 681-4740 (motor kit w/ beaded chain cover)
  - 681-4407 (primary cover gasket kit FXR/FLT)
  - 681-4763 (primary cover gasket kit FL/FLH/FXS)

### KNUCKLEHEAD/ PANHEAD

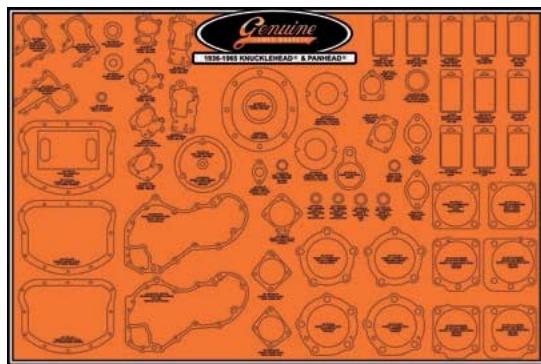

- Small Stocking kit includes 1 package of each
- JG# 17028-36 (motor gasket kit '36-47)
  - 681-5051 (copper embossed head gaskets, Knucklehead)
  - 681-5055 (primary cover seal kit)

### TWIN CAM



- Small Stocking kit includes 1 package of each
- 681-4002 (motor kit w/ .046 head gasket)
  - 681-4306 (5pk trans oil pan gaskets for Touring models)
  - 681-4028 (trans gasket kit Dyna 6speed)
  - 681-4033 (primary cover kit Touring 6speed)
  - 681-4037 (primary cover kit Dyna/Softail 6speed)

### EVO BIG TWIN

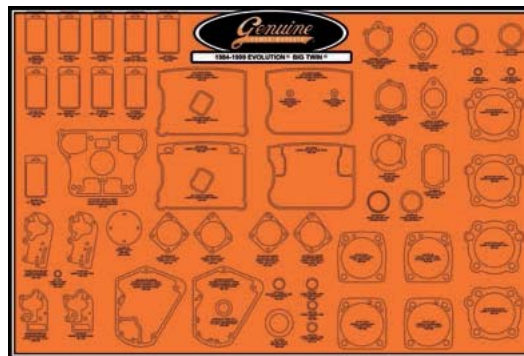

- Small Stocking kit includes 1 package of each
- 681-4383 (motor kit w/ metal base gaskets '84-91)
  - 681-4381 (motor kit w/ metal base gaskets '92-99)

### EVO SPORTSTER

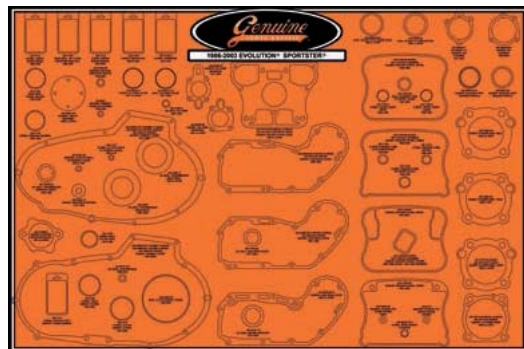

- Small Stocking kit includes 1 package of each
- 681-5215 (motor kit w/ metal base gaskets)
  - 681-5213 (motor kit w/ rubber rocker cover gasket)

Description	Display Board	Large Stocking Kit	Small Stocking Kit
Twin Cam 96" Gasket, Seal and O-Ring	<b>681-6012</b>	<b>681-6014</b>	<b>681-6013</b>
Evo Big Twin '84-99 Gasket, Seal and O-Ring	<b>681-6000</b>	<b>681-6002</b>	<b>681-6001</b>
Evo XL '04-Up Sportster	<b>681-6018</b>	<b>681-6020</b>	<b>681-6019</b>
Evo XL '86-03 Gasket, Seal and O-Ring	<b>681-6003</b>	<b>681-6005</b>	<b>681-6004</b>
Shovelhead '66-84 Gasket, Seal, O-Ring	<b>681-6009</b>	<b>681-6011</b>	<b>681-6010</b>
Knucklehead/Panhead '36-47 Gasket, Seal and O-Ring	<b>681-6006</b>	<b>681-6008</b>	<b>681-6007</b>
Transmission '36-Up Big Twin	<b>681-6015</b>	<b>681-6017</b>	<b>681-6016</b>



# FUEL PUMP DOOR GASKETS



- Meets or exceeds OE specs
- Available for Big Twin and Sportster models



A



B



C

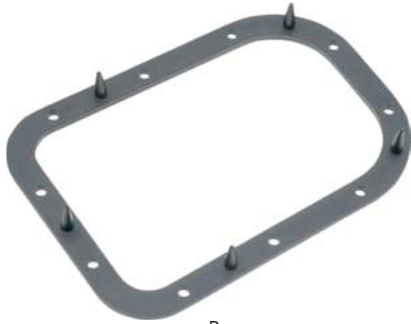

D

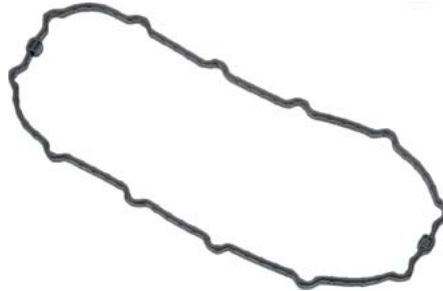

E



F



G



H

	Description	OEM#	WPS#
A	Fuel pump door gasket cork '91-01 Touring Models	61326-95	<b>820-52269</b>
B	Fuel pump door gasket viton '02-07 Touring Models	61402-02	<b>820-52271</b>
C	Fuel pump door gasket cork '08-16 Touring Models	61402-08	<b>820-52272</b>
D	Fuel pump door gasket viton '02-16 Softail Models	61381-02	<b>820-52270</b>
E	Fuel pump door gasket '04-10 FXD, '05-06 FXDC, '04-05 FXDX	75245-04A	<b>820-52274</b>
F	Fuel pump door gasket '04-09 FXDL, '10-16 FXDWG, '06-16 FXDB, '12-16 FLD	75248-04	<b>820-52275</b>
G	Fuel pump door gasket '07-16 FXDC, '08-16 FXDF, 04-08 FXDWG	75249-04A	<b>820-52276</b>
H	Fuel pump door gasket '07-16 XL Models	75301-07	<b>820-52273</b>

- WINDSHIELDS / FAIRINGS
- AUDIO / COMMUNICATION
- SEATS / LUGGAGE
- BAR / MIRRORS / CONTROLS
- EXHAUST
- AIR / FUEL SYSTEMS
- ENGINE
- TRANSMISSION / DRIVELINE
- GASKETS / SEALS**
- ELECTRICAL
- LIGHTING
- CABLES
- BRAKES
- OIL FILTERS
- SUSPENSION
- BODY
- WHEELS
- TIRES / TIRE ACC.
- BIKE ACC.
- VICTORY / INDIAN
- COVERS / LOCKS / TIEDOWNS
- CHEMICALS
- TOOLS
- HELMETS
- HELMET ACC.
- EYEWEAR
- APPAREL / RIDER ACC.
- PROMOTIONAL
- REFERENCE
- INDEX

**KOSO**  
NORTH AMERICA

## DIGITAL ONE PIECE GAUGE CLUSTER



This plug & play kit from Koso is now available to replace stock meters without any hassle! The gauges will plug directly into the OEM dash and connectors. The kit features a dual color changeable LCD display (red and blue) for a custom look to fit your motorcycle. The HD03 kit includes a multifunction speedometer, tachometer, oil temperature meter, and a fuel level meter. If you're looking to enhance the look of your Harley, Koso has the plug & play solution for you!

Application	WPS#
'14-Up FLTR, FLHX, and FLHT models	28-61040



ELECTRICAL

LIGHTING

CABLES

BRAKES

OIL FILTERS

SUSPENSION

BODY

WHEELS

TIRES /

TIRE ACC.

BIKE ACC.

VICTORY /

INDIAN

COVERS / LOCKS /

TIEDOWNS

CHEMICALS

TOOLS

HELMETS

HELMET ACC.

EYEWEAR

APPAREL /

RIDER ACC.

PROMOTIONAL

REFERENCE

INDEX

# DIGITAL HARLEY GAUGE CLUSTER **KOSO** NORTH AMERICA

- Plug & play
- Available with silver or black bezel
- Features a 2 color changeable LCD display (red or blue)



**6 piece Kit includes:**

- 4" Speedometer w/ indicator lights and clock
- 4" Tachometer w/ indicator lights and gear positioning
- 2" Ambient temperature: 0-120F°
- 2" Fuel level: 0-100%
- 2" Oil pressure: 0-60 psi
- 2" Volt meter: 8-16V

Application	Ambient or Oil Temp	Polished Bezel	Black Bezel
'04-13 FLTR, FLHX, and FLHT models	Kit with Ambient Temp Gauge	<b>27-5794</b>	<b>27-5795</b>
	Kit with Oil Temp Gauge	<b>28-61012</b>	<b>28-61013</b>



## OIL TEMP GAUGE **NEW**

This plug & play oil temperature gauge is equipped with a 2 color changeable LCD display. It will provide you with the oil temperature from 0 to 400°F and is easy to connect and install. This meter is a great addition to all HarleyDavidson Touring models 2004 to 2013. Can also be used to replace the ambient temp gauge in Koso HD-02 kits.

Application	Silver Bezel	Black Bezel
'04-13 FLTR, FLHX, and FLHT models	<b>28-61010</b>	<b>28-61011</b>



- WINDSHIELDS / FAIRINGS
- AUDIO / COMMUNICATION
- SEATS / LUGGAGE
- BAR / MIRRORS / CONTROLS
- EXHAUST
- AIR / FUEL SYSTEMS
- ENGINE
- TRANSMISSION / DRIVELINE
- GASKETS / SEALS
- ELECTRICAL**
- LIGHTING
- CABLES
- BRAKES
- OIL FILTERS
- SUSPENSION
- BODY
- WHEELS
- TIRES / TIRE ACC.
- BIKE ACC.
- VICTORY / INDIAN
- COVERS / LOCKS / TIEDOWNS
- CHEMICALS
- TOOLS
- HELMETS
- HELMET ACC.
- EYEWEAR
- APPAREL / RIDER ACC.
- PROMOTIONAL
- REFERENCE
- INDEX



## LCD COLOR CHANGE SPEEDO & TACHOMETER

- Customize your Sportster, Dyna and Softail with our high quality plug & play meter
- Equipped with a 7 color changeable LCD display
- Its stepper motor provides a precise and fast response
- Speed, RPM, indicator lights, fuel level, and gear position indicator
- Available in silver or black bezel
- Tachometer display range: 0-8000 RPM
- Speedometer display range: 0-225 mph

Application	Silver Bezel	Black Bezel
'04-13 Sportster and '04-11 Dyna models	<b>27-5797S</b>	<b>27-5797BK</b>
'14-Up Sportster, '12-17 Dyna and '11-17 Softail models	<b>27-5798S</b>	<b>27-5798BK</b>



Blue



Green



Purple



Red



Turquoise



White



Yellow





**TNT-01 COMBO GAUGE** **NEW**

The TNT01 multifunction tachometer/speedometer uses a stepper motor for a fast and smooth response. The instrument features an analog tach and digital speedometer. Plus many functions such as odometer, trip meter, fuel meter, clock, voltage, shift light, indicator lights and more... This gauge is available in black or white face and functions with the HarleyDavidson speed sensor on the transmission.

Application	White Face	Black Face
Universal Tach/Speedo Combo	28-61002	28-61003

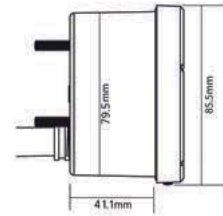

**TNT-01S COMBO GAUGE** **NEW**

The TNT01S multifunction speedometer/tachometer uses a stepper motor for a fast and smooth response. The instrument features an analog speedometer and digital tach, plus many functions such as odometer, trip meter, fuel meter, clock, voltage, shift light, indicator lights and more... This gauge is available in black or white face and functions with the HarleyDavidson speed sensor on the transmission.

Application	White Face	Black Face
Universal Speedo/Tach Combo	28-61000	28-61001

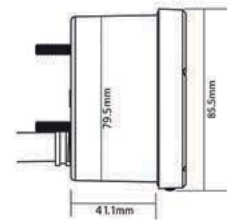

**TNT-02 COMBO GAUGE** **NEW**

This version of the TNT02 tach/speedo is made especially for HarleyDavidsons, it uses the factory transmission speed sensor. It has many functions such as speed, odometer, trip meter, RPM, fuel level, indicator lights and more. Its adjustable backlight brightness makes it very easy to read!

Application	Black Face
Universal Tach/Speedo Combo	28-61035

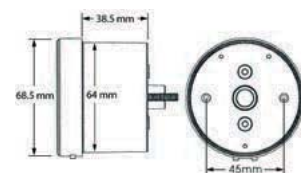

WINDSHIELDS / FAIRINGS  
AUDIO / COMMUNICATION  
SEATS / LUGGAGE  
BARS / MIRRORS / CONTROLS  
EXHAUST  
AIR / FUEL SYSTEMS  
ENGINE  
TRANSMISSION / DRIVELINE  
GASKETS / SEALS  
**ELECTRICAL**  
LIGHTING  
CABLES  
BRAKES  
OIL FILTERS  
SUSPENSION  
BODY  
WHEELS  
TIRES / TIRE ACC.  
BIKE ACC.  
VICTORY / INDIAN  
COVERS / LOCKS / TIEDOWNS  
CHEMICALS  
TOOLS  
HELMETS  
HELMET ACC.  
EYEWEAR  
APPAREL / RIDER ACC.  
PROMOTIONAL  
REFERENCE  
INDEX



## TNT TACHOMETER

Built with the best components and strongest stepper motor on the market, this TNT tachometer is the perfect addition for all Harley Davidson® Motorcycles. Its large dial face and backlight makes it easy to read all day long.

- Tachometer Display range: 0-8,000 RPM
- Display internal <0.5 second
- RPM input signal number setting range 0.5, 1-6
- RPM input pulse setting range: HI (Positive wave pulse)
- Lo (Negative wave pulse)
- Backlight brightness setting range: 5 different levels available
- Setting unit: Each level represents 20%
- Effective voltage DC 12V
- Effective temperature range 14°F - 140°F
- Meter standard JIS D 0203 S2
- Measure 3" diameter (without bezel), 3.4" with bezel x 1.75" deep (without bezel)
- Meter weight Around 6 oz.

Description	WPS#
Black casing Black face Tach 8,000 RPM	27-5782
Chrome casing White face Tach 8,000 RPM	27-5783



## GEAR INDICATOR

- Plug-n-play gear indicator for Harley Davidson®
- Lightweight, compact, easy to use and to install
- Its big digits and blue back light makes it easy to read during day or night riding
- Made to fit most of the Harley Davidson® models
- Gear Display range: N, 1, 2, 3, 4, 5, 6
- Effective voltage DC 12V
- Effective temperature range 14° - 140°F
- Meter standard JIS D0203
- Meter size 1.5 x 2 x 0.5 inches
- Meter weight Around 2oz

Description	WPS#
Digital Gear indicator for '07-'13 Harley-Davidson models*	27-5781



**DL UNIVERSAL SPEEDO AND TACH**



A

B

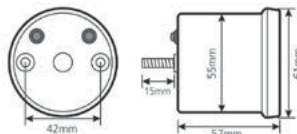

C



D

E



F



G



H

BLUE BACK LIGHT • BLACK PANEL  
RANGE: 0 ~ 360 km/h or 0 ~ 223 mph

This digital instrument gives the basic functions such as speed, trip meter, odometer and fuel level. Its round shape makes it perfect for motorcycles. Matching tachometer available. Both gauges fit in an optional bullet housing that clamps to 1" or 1.25" bars. The face of the instrument becomes totally dark when the ignition is off.

Description	WPS#
A DL Speedometer	<b>28-61045</b>
B DL Tachometer	<b>27-5762</b>
C Optional bracket for 55mm gauge	<b>27-5773</b>
D Optional Bullet housing for 1" bracket	<b>27-5769</b>
Optional Bullet housing for 1 1/4" bracket	<b>27-5770</b>
E Optional Bullet housing bracket for 1" bar	<b>27-5771</b>
Optional Bullet housing bracket for 1 1/4" bar	<b>27-5772</b>
F Replacement V-type gauge bracket	<b>27-5775</b>
G Optional H-D speed sensor	<b>27-5952</b>
H Replacement M8 S-Type bracket	<b>27-5776</b>
Replacement M10 S-Type bracket	<b>27-5777</b>

**DL-2 UNIVERSAL SPEEDO AND TACH**



The DL-02S speedometer has been developed with the latest technology. Its unique casing allows the adjust buttons to be right in the front. This makes the DL-02S a very convenient instrument to adjust. The big digits and blue back light make the DL-02S a very easy gauge to read even at night. Matching tachometer available. Both gauges will fit into the optional bullet housing that clamps to 1" or 1 1/4" bars or the optional one bolt mounting bracket (27-5773)

Description	WPS#
DL-02S Speedometer	<b>27-5763</b>
DL-02R Tachometer	<b>27-5764</b>
Optional bracket for 55mm gauge	<b>27-5773</b>
Optional Bullet housing for 1" bracket	<b>27-5769</b>
Optional Bullet housing for 1 1/4" bracket	<b>27-5770</b>
Optional Bullet housing bracket for 1" bar	<b>27-5771</b>
Optional Bullet housing bracket for 1 1/4" bar	<b>27-5772</b>
Replacement V-type gauge bracket	<b>27-5775</b>
Replacement M8 S-Type bracket	<b>27-5776</b>
Replacement M10 S-Type bracket	<b>27-5777</b>

- Speedometer Display range: 0~260 km/h or 0~160 MPH
- Display unit: KMH & MPH
- Display internal < 0.5 Second RPM
- Odometer Display range: 0~99999 km or mile,
- Display unit: 1 km or mile
- Trip meter Display range: 0~999.9 km or mile,
- Display unit: 1 km or mile
- The circumference setting Setting range: 300~2,500 mm
- Setting unit: 1 mm • Pulse setting: 1~60
- Top speed record Display range: 0~260 km/h or 0~160 MPH
- AVE speed Display range: 0~260 km/h or 0~160 MPH
- Riding time Setting range: 0~99'59"99 second.
- Fuel meter Display range: 0%~100%
- Setting range: 100 Ω , 510 Ω , no display
- Supply voltage DC 12V
- Effective temperature range: -10°C ~ +60°C
- Meter standard JIS D 0203 S2
- Sensor type Passive speed sensor



## D64 UNIVERSAL SPEEDOMETER

The new D64 speedometer was especially made to save room on your dashboard. The people at Koso were able to combine all basic functions in a 64mm classic needle gauge. This instrument can be installed on any type of vehicle that requires speed and indicator lights.

Want something different? This is the right gauge! Optional one bolt style mounting bracket available separately (27-5774).

- Speedometer Display range: 0-160 mph
- Display unit: 1 mph
- Display internal < 0.5 Second
- Odometer Display range: 0-99999 mile
- Display unit: 1 mile
- Trip meter Display range: 0-999.9 mile
- Display unit: 1 mile
- The circumference setting Setting range: 300-2,500 mm
- Setting unit: 1 mm • Pulse setting: 1-60
- Fuel level Display range: 6 segment bar graph
- Display unit: 16.6% for each segment
- Setting range: 100 Ω , 510 Ω , no display
- Supply voltage DC 12V
- Effective temperature range -10~+60°C
- Indicator lights: Repeater (Green), High Beam (Blue), Oil (Red) and Neutral (Green)
- Sensor type Passive speed sensor : BF019005

Description	WPS#
D64 Speedometer	27-5736
Optional bracket for 64mm gauge	27-5774
Replacement V-type gauge bracket	27-5775
Replacement passive speed sensor 200cm	27-5720
Replacement M8 S-Type bracket	27-5776
Replacement M10 S-Type bracket	27-5777

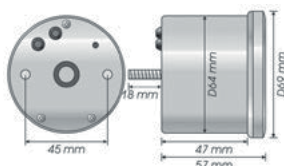

Optional Bracket



## SPEEDO TUNER®

Everyone deserves an accurate speedometer to prevent breaking the law and hurting the value of their motorcycles. Until now the only solution was limited to a few products that require complicated mathematical formulas to calculate an adjustment to offset a gearing or tire/wheel change, but it still carried the original factory offset along with it.

- Works on most any bike with an electronic speedometer
- No math required, no guessing
- Simple 3-step procedure to regain accurate speedometer and odometer readings within 1%
- Fixes calibration once and for all
- 6th gear indicator light function may be lost
- May interfere with cruise control functionality depending on severity of gear ratio change

Speedo Tuner® fixes the following problems:

- Any sprocket or gearing change (up or down)
- Tire profile change or using any of the new oversized tires
- Harley's changing to 6-speed and/or overdrive transmissions
- Anyone who's tired of poor OE speedometer inaccuracies



Application	Year	WPS#
<b>HARLEY DAVIDSON</b>		
Big Twin	'98-06	58-7900
Big Twin (w/ fact. 6 spd)	'07-up	58-7901
Sportster	'98-04	58-7900
	'05-up	58-7901
V-Rod	All	58-7901
<b>UNIVERSAL</b>		
Requires cutting 1 wire		58-7950

Available in "plug and play" bike specific and universal models.





A

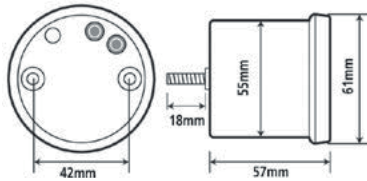

**H-D TACH**

To make the needle stable for the high vibrations, a stepper motor is used. With the auto-scan function, the meter will scan when the engine is turned on. This Speedometer with illuminated needle is very easy to read at night. The odometer and trip meter on the digital screen give the precise mileage. This instrument will work with the OEM speed sensor. A matching tachometer (with integrated oil pressure indicator) is available and both gauges will fit the optional bullet housing or the optional one bolt mounting bracket (27-5773).

- Speedometer 0 -120 MPH
- Trip Meter Display Range 0-999.9 Miles
- Tachometer 0 -9000 RPM
- Oil Pressure 0-75 PSI



B



C



D



E



F



G

Description	WPS#
A Tachometer for Harley	<b>27-5768</b>
B Optional bracket for 55mm gauges	<b>27-5773</b>
C Optional Bullet housing for 1" bracket	<b>27-5769</b>
Optional Bullet housing for 1 1/4" bracket	<b>27-5770</b>
D Optional Bullet housing bracket for 1" bar	<b>27-5771</b>
Optional Bullet housing bracket for 1 1/4" bar	<b>27-5772</b>
E Optional H-D speed sensor	<b>27-5952</b>
F Replacement V-type gauge bracket	<b>27-5775</b>
G Replacement thumb switch	<b>27-5953</b>



**SPEEDO BEZEL**

- Bezel cover for all 4.5" dash mounted speedos
- Ideal for dressing up the unattractive stock bezel

Application	WPS Part#
Fits all 4.5" dash mounted speedometers	<b>830-0520</b>



WINDSHIELDS / FAIRINGS  
AUDIO / COMMUNICATION  
SEATS / LUGGAGE  
BARS / MIRRORS / CONTROLS  
EXHAUST  
AIR / FUEL SYSTEMS  
ENGINE  
TRANSMISSION / DRIVELINE  
GASKETS / SEALS  
**ELECTRICAL**  
LIGHTING  
CABLES  
BRAKES  
OIL FILTERS  
SUSPENSION  
BODY  
WHEELS  
TIRES / TIRE ACC.  
BIKE ACC.  
VICTORY / INDIAN  
COVERS / LOCKS / TIEDOWNS  
CHEMICALS  
TOOLS  
HELMETS  
HELMET ACC.  
EYEWEAR  
APPAREL / RIDER ACC.  
PROMOTIONAL  
REFERENCE  
INDEX

- WINDSHIELDS / FAIRINGS
- AUDIO / COMMUNICATION
- SEATS / LUGGAGE
- BARS / MIRRORS / CONTROLS
- EXHAUST
- AIR / FUEL SYSTEMS
- ENGINE
- TRANSMISSION / DRIVELINE
- GASKETS / SEALS
- ELECTRICAL**
- LIGHTING
- CABLES
- BRAKES
- OIL FILTERS
- SUSPENSION
- BODY
- WHEELS
- TIRES / TIRE ACC.
- BIKE ACC.
- VICTORY / INDIAN
- COVERS / LOCKS / TIEDOWNS
- CHEMICALS
- TOOLS
- HELMETS
- HELMET ACC.
- EYEWEAR
- APPAREL / RIDER ACC.
- PROMOTIONAL
- REFERENCE
- INDEX



## SPEEDOMETER

- OEM replacement
- Black face 120mph
- Sub-wire harness required for '96-98 applications
- '99-03 plug-in installation

OEM#	Application	WPS#
67027-96A	'99-03 Softail and Road King models w/5 Speed	<b>820-2639</b>
67033-99A	* '99-03 Softail and Road King models w/6 Speed	<b>820-2640</b>

\*Models w/ aftermarket 6 Speed trans will not need to be recalibrated



## MINI SPEEDO & TACH

- Water proof
- Vibration resistant
- 2 1/2" dia. and 2 1/4" high
- Fits all 12v models
- Stainless steel housing

	Description	WPS#
A	Black face 140mph speedometer w/ handlebar clamp	<b>820-2702</b>
B	White face 140mph speedometer w/ handlebar clamp	<b>820-2703</b>
C	Black face 8000rpm tachometer	<b>820-2706</b>
D	White face 8000rpm tachometer	<b>820-2707</b>

### REPLACEMENT PARTS

E	Chrome "Y" type bracket for Mini gauges	<b>820-2698</b>
F	Black "Y" type bracket for Mini gauges	<b>820-2699</b>
G	Chrome handlebar clamp	<b>820-2700</b>
	Black handlebar clamp	<b>820-2701</b>



A



B



C



D



E



F



G

### 48MM MINI SPEEDO & TACH

- Easy push button recalibration
- LED illuminated face
- 140mph and 8000rpm
- Stainless steel housing w/ polished bezel trim ring
- LCD odometer with resettable trip meter



Application	WPS#
A '95-06 H-D models, black face speedo	<b>820-2704</b>
B '95-06 H-D models, white face speedo	<b>820-2705</b>
C '95-06 H-D models, black face tach	<b>820-2708</b>
D '95-06 H-D models, white face tach	<b>820-2709</b>
<b>MINI GAUGE FORK MOUNTS</b>	
E 39mm chrome fork clamp	<b>820-2714</b>
F 41mm chrome fork clamp	<b>820-2715</b>

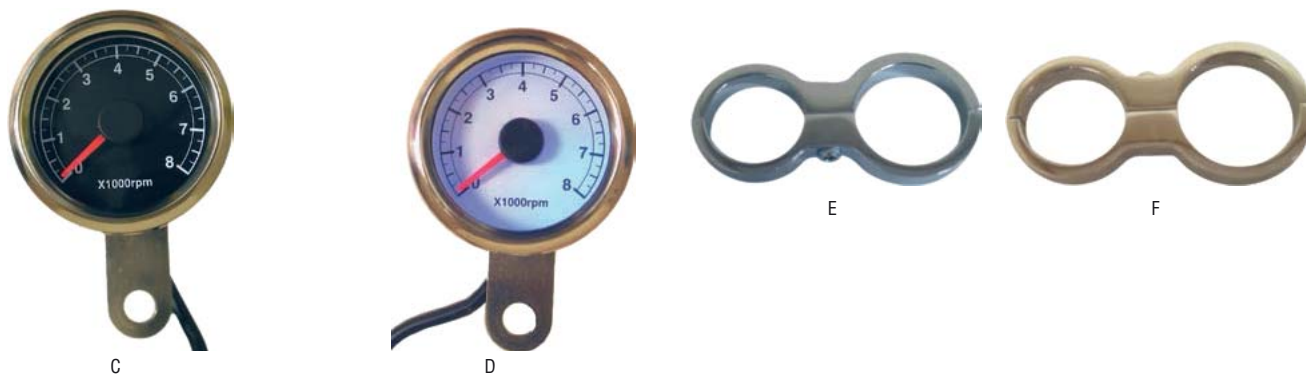

### SPEED SENSORS

Transmission mounted OEM equipment speed sensor. Available for Sportster and Big Twin models. Speed sensors will also fit most aftermarket 5 and 6 speed transmissions, including Right Side Drive transmissions.

OEM#	Application	Year	WPS#
B 74429-97	Touring models	'94-03	<b>820-52359</b>
C 74430-00D		'04-06	<b>820-52360</b>
A 74437-96	Softail models	'96-99	<b>820-52358</b>
C 74430-00		'00-06	<b>820-52360</b>
B 74420-94	Dyna models	'94-06	<b>820-52359</b>

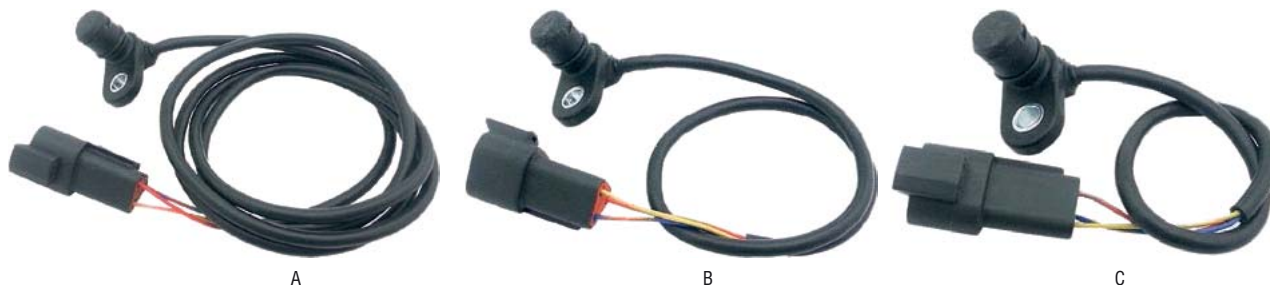

- WINDSHIELDS / FAIRINGS
- AUDIO / COMMUNICATION
- SEATS / LUGGAGE
- BARS / MIRRORS / CONTROLS
- EXHAUST
- AIR / FUEL SYSTEMS
- ENGINE
- TRANSMISSION / DRIVELINE
- GASKETS / SEALS
- ELECTRICAL**
- LIGHTING
- CABLES
- BRAKES
- OIL FILTERS
- SUSPENSION
- BODY
- WHEELS
- TIRES / TIRE ACC.
- BIKE ACC.
- VICTORY / INDIAN
- COVERS / LOCKS / TIEDOWNS
- CHEMICALS
- TOOLS
- HELMETS
- HELMET ACC.
- EYEWEAR
- APPAREL / RIDER ACC.
- PROMOTIONAL
- REFERENCE
- INDEX



## GAUGE MOUNT FOR T-BARS

Accutronix Gauge mount adapters give you a place to mount your gauge bracket after you switch to T-Bar handle bars. These Gauge mount adapters are machined from 6061 T-6 Billet Aluminum and brilliantly Chrome plated or Black Anodized. Our Gauge Mount Adapters are designed to adapt FXD & XL OEM gauge mounts that normally bolt to your top riser clamp to a 1", 1-1/4", or a 1-1/2" T-Bar handle bar.

Description	Bar Diameter	Chrome	Black
T-Bar Gauge Mount	1"	811-20040	811-20043
	1-1/4"	811-20041	811-20044
	1-1/2"	811-20042	811-20045

Note: The late model DYNA and SPORTSTER Gauge Mount is also the top riser clamp. You will need an early H-D Gauge mount as well as our gauge mount adapter.



ELECTRICAL



## DUAL GAUGE MOUNT BRACKET KIT

- These new dual gauge mount kits have a steel construction
- Available in chrome or black
- Allows mounting of the Speedo & Tachometer easily
- Comes with backing plates and hardware as shown
- Sold as a kit



Application	Chrome	Black
'95-05 FXD and XL models	820-52380	820-52381

## GAUGE VISOR RING

Description	Application	WPS#
A Chrome 3-3/4" gauge	'99-Up XL, Dyna models (except FXDWG) and '98-Up Road Glide	820-2637
B Chrome 4-5/8" gauge	'99-Up FXDWG, Road King models (except '08), Softail models (except FXSTD, FLSTFSE or models equipped w/ chrome console	820-2638



A



B

## SPEEDO RELOCATION BRACKET



Relocates the OEM speedo to the left side of the motor for a clean and uncluttered look. Works well with our coil relocation brackets. A must for every custom Sportster.

Year	WPS#
<b>SIDE MOUNT SPEEDO BRACKET (FOR OE SPEEDO)</b>	
A '04-Up XL Models (except C, X and Superlow)	<b>750-01252</b>
B Choke Mounting Bracket for '04-06 Models	<b>750-01253</b>

- Will not fit XL883/1200C models with large tank
- '04-06 carburetor models require choke relocation bracket (750-01253)



## SPORTSTER COIL RELOCATION KITS

Combine this sidemount coil relocation kit with our speedo bracket and tank lift kit to give your Sporty that ultimate custom look or use it on its own.

Year	WPS#
<b>COIL RELOCATION BRACKET</b>	
A '04-Up XL Models (except C, R and L)	<b>750-01250</b>
B '95-03 XL Models (except 1200C/S)	<b>750-01251</b>

- EFI models require purchase of aftermarket plug wires
- Includes ignition switch bracket, choke bracket and coil bracket
- Requires some wiring to be extended

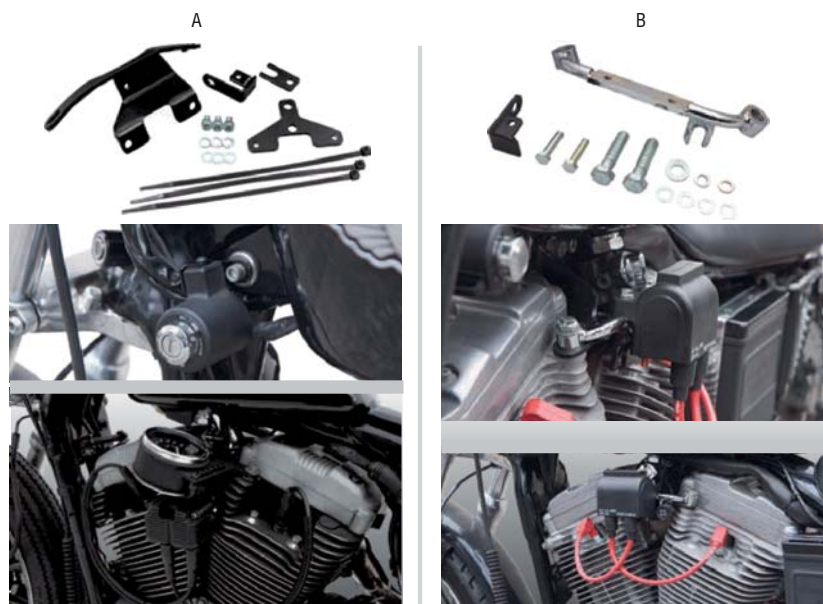

WINDSHIELDS / FAIRINGS

AUDIO / COMMUNICATION

SEATS / LUGGAGE

BARS / MIRRORS / CONTROLS

EXHAUST

AIR / FUEL SYSTEMS

ENGINE

TRANSMISSION / DRIVELINE

GASKETS / SEALS

ELECTRICAL

LIGHTING

CABLES

BRAKES

OIL FILTERS

SUSPENSION

BODY

WHEELS

TIRES / TIRE ACC.

BIKE ACC.

VICTORY / INDIAN

COVERS / LOCKS / TIEDOWNS

CHEMICALS

TOOLS

HELMETS

HELMET ACC.

EYEWEAR

APPAREL / RIDER ACC.

PROMOTIONAL

REFERENCE

INDEX

- WINDSHIELDS / FAIRINGS
- AUDIO / COMMUNICATION
- SEATS / LUGGAGE
- BARS / MIRRORS / CONTROLS
- EXHAUST
- AIR / FUEL SYSTEMS
- ENGINE
- TRANSMISSION / DRIVELINE
- GASKETS / SEALS
- ELECTRICAL**
- LIGHTING
- CABLES
- BRAKES
- OIL FILTERS
- SUSPENSION
- BODY
- WHEELS
- TIRES / TIRE ACC.
- BIKE ACC.
- VICTORY / INDIAN
- COVERS / LOCKS / TIEDOWNS
- CHEMICALS
- TOOLS
- HELMETS
- HELMET ACC.
- EYEWEAR
- APPAREL / RIDER ACC.
- PROMOTIONAL
- REFERENCE
- INDEX



## DYNA LOWRIDER INDICATOR RELOCATION BRACKET

- Used to relocate indicator lights to the steering stem on Dyna Lowrider models
- Includes chrome bracket and hardware

**Application**      **WPS #**  
 Fits FXDL Models '06-17      **750-02020**



## INDICATOR LIGHTS



820-52850      820-52851      820-52852      820-52853      820-52854

Description	WPS#
Neutral Green (OE 68024-92A)	<b>820-52850</b>
Pursuit Red (OE 68022-92A)	<b>820-52851</b>
High Beam Blue (OE 68023-92A)	<b>820-52852</b>
Turn Green Arrow (OE 68021-92A)	<b>820-52853</b>
Oil Red (OE 68020-92A)	<b>820-52854</b>





### UNIVERSAL 12 VOLT HORNS

- Easily attaches to any motorcycle or ATV
- Works great with any 12 volt system



A - 56-4256

B - 56-4256C

C - 56-4255

D - 60-1411

Description	WPS#
A 2 3/4" Horn, black	<b>56-4256</b>
B 2 3/4" Horn, chrome	<b>56-4256C</b>
C 4" Horn, black	<b>56-4255</b>
D 4" Horn, chrome	<b>60-1411</b>



### SPORTS HORN

- Powerful 115db attention getting sound
- Weather resistant cover
- Super-light weight



602-76501

602-76500

Description	WPS#
Sports Horn	<b>602-76500</b>
Slimline Sports Horn	<b>602-76501</b>



### HORN COVER AND BRACKET

- Chrome plated
- Easy install

Application	Description	WPS#
'93-16 H-D models (except FXCW, FLSTSB, and FXSB)	Chrome horn cover	<b>820-2683</b>
'91-16 H-D models	Chrome horn mounting bracket	<b>820-2684</b>



### HORN COVER AND BRACKET

Application	Description	Black	Chrome
'90-Up models with Cowbell style horn cover	Darkside	<b>810-0810</b>	<b>810-0811</b>

- WINDSHIELDS / FAIRINGS
- AUDIO / COMMUNICATION
- SEATS / LUGGAGE
- BAR / MIRRORS / CONTROLS
- EXHAUST
- AIR / FUEL SYSTEMS
- ENGINE
- TRANSMISSION / DRIVELINE
- GASKETS / SEALS
- ELECTRICAL**
- LIGHTING
- CABLES
- BRAKES
- OIL FILTERS
- SUSPENSION
- BODY
- WHEELS
- TIRES / TIRE ACC.
- BIKE ACC.
- VICTORY / INDIAN
- COVERS / LOCKS / TIEDOWNS
- CHEMICALS
- TOOLS
- HELMETS
- HELMET ACC.
- EYEWEAR
- APPAREL / RIDER ACC.
- PROMOTIONAL
- REFERENCE
- INDEX



**WIRING CONNECTOR KITS**

Description/Brand WPS#

**AMP TYPE**

B	2 Pin	131-9901
C	3 Pin	131-9902
D	4 Pin	131-9903
E	6 Pin	131-9904
	Combo Kit	131-9922

**DELPHI TYPE**

	2 Pin	131-9912
	3 Pin	131-9913
	4 Pin	131-9914
F	8 Pin	131-9905
	Combo Kit	131-9923

**SUMITOMO TYPE**

A	1 Pin	131-9900
	2 Pin	131-9909
	4 Pin	131-9910
	6 Pin	131-9911
G	10 Pin	131-9906
H	12 Pin	131-9907
I	16 Pin	131-9908
	Combo Kit "A"	131-9920
	Combo Kit "B"	131-9921

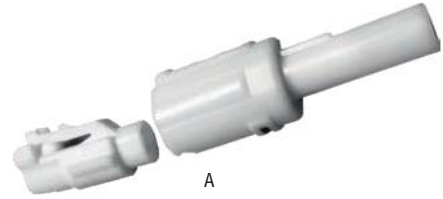

A



B

C



D



E



F



G



H



I



Amp Combo Kit



Delphi Combo Kit



Sumitomo Combo Kit "A"



Sumitomo Combo Kit "B"

- WINDSHIELDS / FAIRINGS
- AUDIO / COMMUNICATION
- SEATS / LUGGAGE
- BARS / MIRRORS / CONTROLS
- EXHAUST
- AIR / FUEL SYSTEMS
- ENGINE
- TRANSMISSION / DRIVELINE
- GASKETS / SEALS
- ELECTRICAL**
- LIGHTING
- CABLES
- BRAKES
- OIL FILTERS
- SUSPENSION
- BODY
- WHEELS
- TIRES / TIRE ACC.
- BIKE ACC.
- VICTORY / INDIAN
- COVERS / LOCKS / TIEDOWNS
- CHEMICALS
- TOOLS
- HELMETS
- HELMET ACC.
- EYEWEAR
- APPAREL / RIDER ACC.
- PROMOTIONAL
- REFERENCE
- INDEX



# DEUTSCH CONNECTORS

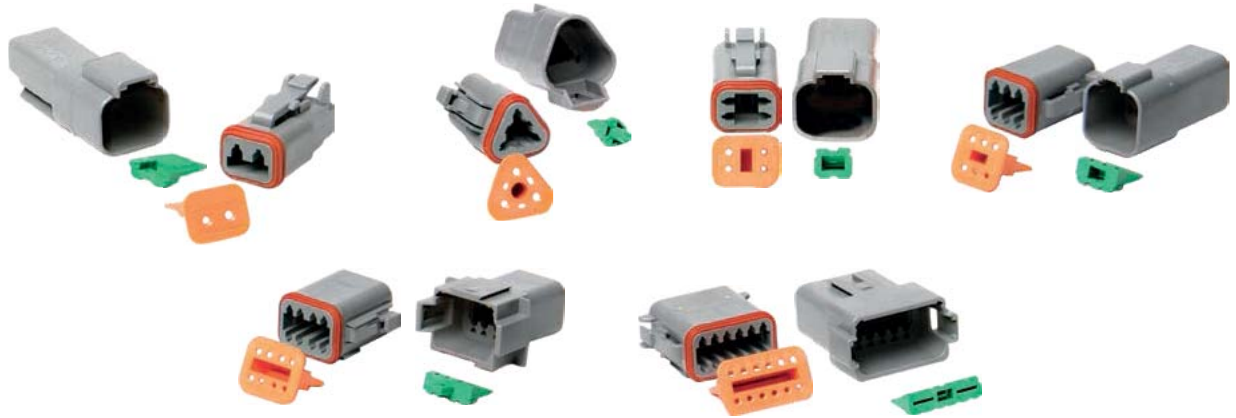

Description	Male	Female
<b>2-PIN CONNECTORS</b>		
Gray	<b>850-05500</b>	<b>850-05501</b>
Black	<b>850-05502</b>	<b>850-05503</b>
<b>3-PIN CONNECTORS</b>		
Gray	<b>850-05504</b>	<b>850-05505</b>
Black	<b>850-05506</b>	<b>850-05507</b>
<b>4-PIN CONNECTORS</b>		
Gray	<b>850-05508</b>	<b>850-05509</b>
Black	<b>850-05510</b>	<b>850-05511</b>

Description	Male	Female
<b>6-PIN CONNECTORS</b>		
Gray	<b>850-05512</b>	<b>850-05513</b>
Black	<b>850-05514</b>	<b>850-05515</b>
<b>8-PIN CONNECTORS</b>		
Gray	<b>850-05516</b>	<b>850-05517</b>
Black	<b>850-05518</b>	<b>850-05519</b>
<b>12-PIN CONNECTORS</b>		
Gray	<b>850-05520</b>	<b>850-05521</b>
Black	<b>850-05522</b>	<b>850-05523</b>

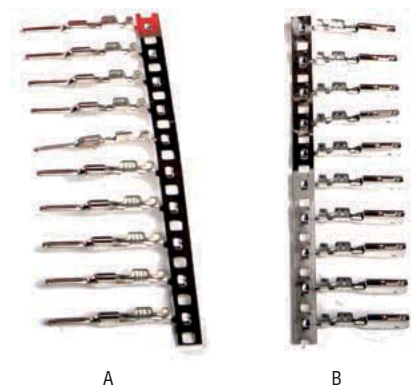

## DEUTSCH CONNECTOR PINS

Description	WPS#
A Male Connector Pins (10 pk)	<b>850-05300</b>
B Female Connector Pins (10 pk)	<b>850-05301</b>



## MOLEX PIN REMOVAL TOOL

x X

**WPS#**  
**850-05302**

- WINDSHIELDS / FAIRINGS
- AUDIO / COMMUNICATION
- SEATS / LUGGAGE
- BARS / MIRRORS / CONTROLS
- EXHAUST
- AIR / FUEL SYSTEMS
- ENGINE
- TRANSMISSION / DRIVELINE
- GASKETS / SEALS
- ELECTRICAL**
- LIGHTING
- CABLES
- BRAKES
- OIL FILTERS
- SUSPENSION
- BODY
- WHEELS
- TIRES / TIRE ACC.
- BIKE ACC.
- VICTORY / INDIAN
- COVERS / LOCKS / TIEDOWNS
- CHEMICALS
- TOOLS
- HELMETS
- HELMET ACC.
- EYEWEAR
- APPAREL / RIDER ACC.
- PROMOTIONAL
- REFERENCE
- INDEX

- WINDSHIELDS / FAIRINGS
- AUDIO / COMMUNICATION
- SEATS / LUGGAGE
- BARS / MIRRORS / CONTROLS
- EXHAUST
- AIR / FUEL SYSTEMS
- ENGINE
- TRANSMISSION / DRIVELINE
- GASKETS / SEALS
- ELECTRICAL**
- LIGHTING
- CABLES
- BRAKES
- OIL FILTERS
- SUSPENSION
- BODY
- WHEELS
- TIRES / TIRE ACC.
- BIKE ACC.
- VICTORY / INDIAN
- COVERS / LOCKS / TIEDOWNS
- CHEMICALS
- TOOLS
- HELMETS
- HELMET ACC.
- EYEWEAR
- APPAREL / RIDER ACC.
- PROMOTIONAL
- REFERENCE
- INDEX



## DEUTSCH BUILDER KITS

Description	WPS#
A Builder Kit w/Black Plugs	850-05555
B Builder Kit w/Grey Plugs	850-05556



A



B



## WIRING HARNESS FOR SPLIT TANKS



Application	WPS#
Models with Split Tanks and Cast Dash '84-95	812-02080

# THROTTLE BY WIRE EXTENSIONS



x

Description	Application	WPS#
TBW Extension	'08-13 Touring	<b>70-10100</b>
	'14-Up Touring	<b>70-10101</b>



- WINDSHIELDS / FAIRINGS
- AUDIO / COMMUNICATION
- SEATS / LUGGAGE
- BAR / MIRRORS / CONTROLS
- EXHAUST
- AIR / FUEL SYSTEMS
- ENGINE
- TRANSMISSION / DRIVELINE
- GASKETS / SEALS
- ELECTRICAL**
- LIGHTING
- CABLES
- BRAKES
- OIL FILTERS
- SUSPENSION
- BODY
- WHEELS
- TIRES / TIRE ACC.
- BIKE ACC.
- VICTORY / INDIAN
- COVERS / LOCKS / TIEDOWNS
- CHEMICALS
- TOOLS
- HELMETS
- HELMET ACC.
- EYEWEAR
- APPAREL / RIDER ACC.
- PROMOTIONAL
- REFERENCE
- INDEX

## WIRING EXTENSIONS



- Factory color coded wire with OE style pins
- Instructions and heat shrink tubing included
- Made in USA

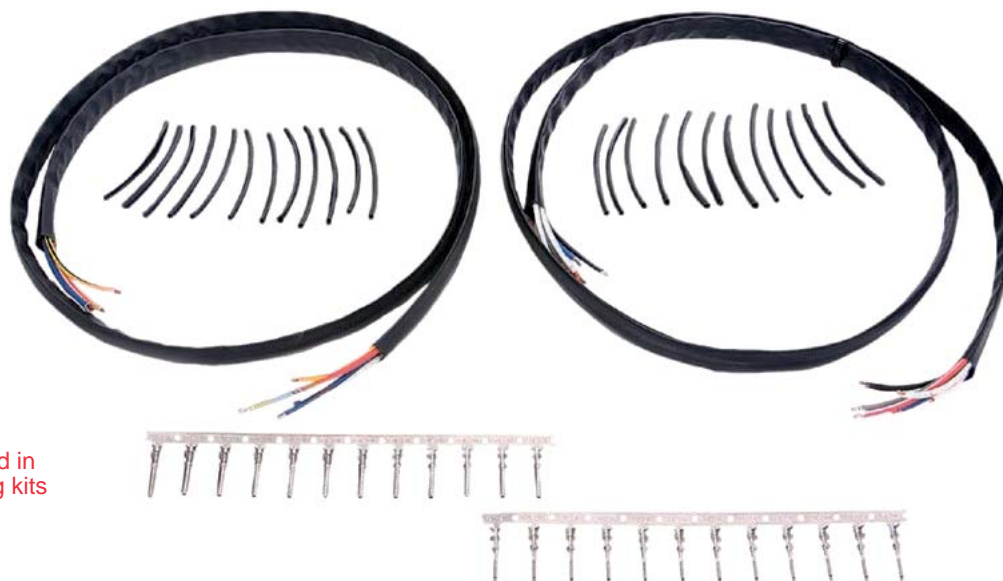

**NOTE:** Radio, CB and TBW extension kits must be ordered in addition to the standard wiring kits

**Description WPS#**

**ALL MODELS '96-06 W/O CRUISE CONTROL**

4" Extension Kit	<b>850-05200</b>
8" Extension Kit	<b>850-05201</b>
12" Extension Kit	<b>850-05202</b>
15" Extension Kit	<b>850-05203</b>
18" Extension Kit	<b>850-05204</b>
20" Extension Kit	<b>850-05205</b>
24" Extension Kit	<b>850-05206</b>

**ALL MODELS '96-06 WITH CRUISE CONTROL**

4" Extension Kit	<b>850-05207</b>
8" Extension Kit	<b>850-05208</b>
12" Extension Kit	<b>850-05209</b>
15" Extension Kit	<b>850-05210</b>
18" Extension Kit	<b>850-05211</b>
20" Extension Kit	<b>850-05212</b>
24" Extension Kit	<b>850-05213</b>

**ALL MODELS '07-13 W/O CRUISE CONTROL**

4" Extension Kit	<b>850-05214</b>
8" Extension Kit	<b>850-05215</b>
12" Extension Kit	<b>850-05216</b>
15" Extension Kit	<b>850-05217</b>
18" Extension Kit	<b>850-05218</b>
20" Extension Kit	<b>850-05219</b>
24" Extension Kit	<b>850-05220</b>

**ALL MODELS '07-13 WITH CRUISE CONTROL**

4" Extension Kit	<b>850-05256</b>
8" Extension Kit	<b>850-05257</b>
12" Extension Kit	<b>850-05258</b>
15" Extension Kit	<b>850-05259</b>
18" Extension Kit	<b>850-05260</b>
20" Extension Kit	<b>850-05261</b>
24" Extension Kit	<b>850-05262</b>

**RADIO EXTENSION KIT FOR FLH/FLT MODELS '96-06**

4" Extension Kit	<b>850-05221</b>
8" Extension Kit	<b>850-05222</b>
12" Extension Kit	<b>850-05223</b>
15" Extension Kit	<b>850-05224</b>
18" Extension Kit	<b>850-05225</b>
20" Extension Kit	<b>850-05226</b>
24" Extension Kit	<b>850-05227</b>

**Description WPS#**

**RADIO/CB EXTENSION KIT FOR FLH/FLT MODELS '96-06**

4" Extension Kit	<b>850-05228</b>
8" Extension Kit	<b>850-05229</b>
12" Extension Kit	<b>850-05230</b>
15" Extension Kit	<b>850-05231</b>
18" Extension Kit	<b>850-05232</b>
20" Extension Kit	<b>850-05233</b>
24" Extension Kit	<b>850-05234</b>

**RADIO/CB EXTENSION KIT FOR FLH/FLT MODELS '07-13**

4" Extension Kit	<b>850-05235</b>
8" Extension Kit	<b>850-05236</b>
12" Extension Kit	<b>850-05237</b>
15" Extension Kit	<b>850-05238</b>
18" Extension Kit	<b>850-05239</b>
20" Extension Kit	<b>850-05240</b>
24" Extension Kit	<b>850-05241</b>

**MODELS W/HANDLEBAR MOUNTED TURN SIGNALS '97-13**

4" Extension Kit	<b>850-05242</b>
8" Extension Kit	<b>850-05243</b>
12" Extension Kit	<b>850-05244</b>
15" Extension Kit	<b>850-05245</b>
18" Extension Kit	<b>850-05246</b>
20" Extension Kit	<b>850-05247</b>
24" Extension Kit	<b>850-05248</b>

**THROTTLE BY WIRE MODELS '08-16**

4" Extension Kit	<b>850-05249</b>
8" Extension Kit	<b>850-05250</b>
12" Extension Kit	<b>850-05251</b>
15" Extension Kit	<b>850-05252</b>
18" Extension Kit	<b>850-05253</b>
20" Extension Kit	<b>850-05254</b>
24" Extension Kit	<b>850-05255</b>

**CAN BUS MODELS '12-17 DYNA AND '11-17 SOFTAIL, TOURING '14-17**

4" Extension Kit	<b>850-05263</b>
8" Extension Kit	<b>850-05264</b>
12" Extension Kit	<b>850-05265</b>
15" Extension Kit	<b>850-05266</b>
18" Extension Kit	<b>850-05267</b>
20" Extension Kit	<b>850-05268</b>
24" Extension Kit	<b>850-05269</b>

ELECTRICAL

LIGHTING

CABLES

BRAKES

OIL FILTERS

SUSPENSION

BODY

WHEELS

TIRES / TIRE ACC.

BIKE ACC.

VICTORY / INDIAN

COVERS / LOCKS / TIEDOWNS

CHEMICALS

TOOLS

HELMETS

HELMET ACC.

EYEWEAR

APPAREL / RIDER ACC.

PROMOTIONAL

REFERENCE

INDEX

## FACTORY COLOR CODED WIRE SPOOLS

- OE Factory colors
- Sold on 25' spools
- 16 gauge wire



Description	WPS#
<b>25' SPOOL</b>	
White	850-05400
Blue	850-05401
Gray	850-05402
Yellow	850-05403
Purple	850-05404
Black	850-05405
Orange/White	850-05406
White/Purple	850-05407
Yellow/Black	850-05408
White/Black	850-05409

Description	WPS#
<b>25' SPOOL (CONT'D...)</b>	
Black/Red	850-05410
Red/Yellow	850-05411
Brown/White	850-05412
Pink/White	850-05413
Gray/White	850-05414
Violet/Black	850-05415
Brown/Black	850-05416
Orange/Black	850-05417
Green/Dark Blue	850-05418

Description	WPS#
<b>25' SPOOL (CONT'D...)</b>	
Gray/Dark Green	850-05419
Blue/Black	850-05420
Red	850-05421
Brown	850-05422
White/Brown	850-05423
Red/Green	850-05424
Red/Blue	850-05425
White/Blue	850-05426
Black/White	850-05427

## CIRCUIT BREAKERS



- Top quality
- Self resetting
- American-made
- Designed to fit most '70-Present FL, FX, and XL models
- Direct OEM replacement

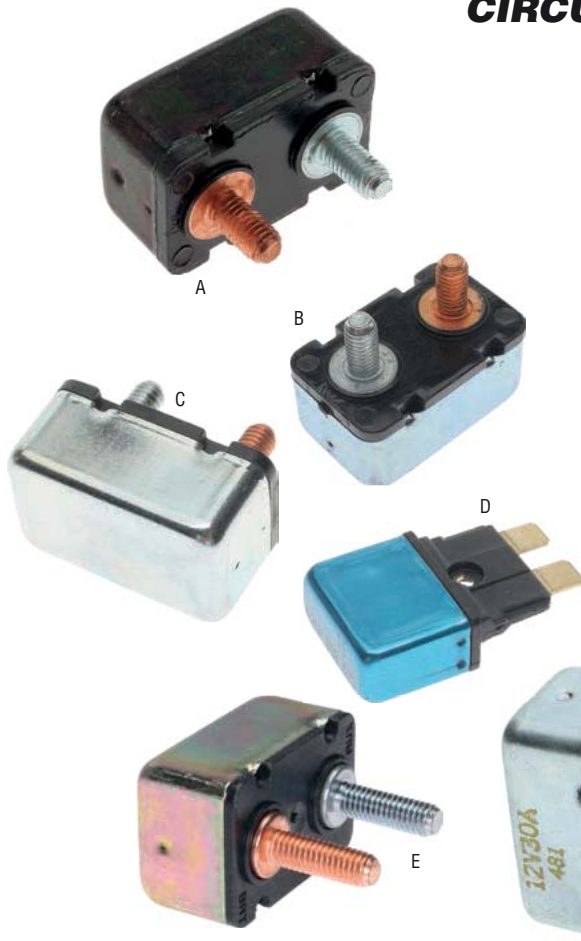

Description	Application	OEM#	WPS#
A Circuit breaker 50amp	Most '70-Up Big Twin and XL models	74600-94	<b>275-01010</b>
B Circuit breaker 30amp	Most '70-Up Big Twin and XL models	74599-77B	<b>275-01011</b>
C Circuit breaker 15amp	Most '70-Up Big Twin and XL models	74589-73A	<b>275-01012</b>
D Circuit breaker 15amp	Most '70-Up Big Twin and XL models	74587-94	<b>275-01013</b>
E Circuit breaker 40amp	Most '70-Up Big Twin and XL models	74600-97A	<b>275-01016</b>
F Circuit breaker 30amp w/ 10-32 stud and two 1/4" blade terminal spades	Universal		<b>275-01014</b>
G Circuit breaker 40amp w/ 10-32 stud and two 1/4" blade terminal spades	Universal		<b>275-01015</b>

- WINDSHIELDS / FAIRINGS
- AUDIO / COMMUNICATION
- SEATS / LUGGAGE
- BARS / MIRRORS / CONTROLS
- EXHAUST
- AIR / FUEL SYSTEMS
- ENGINE
- TRANSMISSION / DRIVELINE
- GASKETS / SEALS
- ELECTRICAL**
- LIGHTING
- CABLES
- BRAKES
- OIL FILTERS
- SUSPENSION
- BODY
- WHEELS
- TIRES / TIRE ACC.
- BIKE ACC.
- VICTORY / INDIAN
- COVERS / LOCKS / TIEDOWNS
- CHEMICALS
- TOOLS
- HELMETS
- HELMET ACC.
- EYEWEAR
- APPAREL / RIDER ACC.
- PROMOTIONAL
- REFERENCE
- INDEX



# FUSES

- The leading manufacturer of fuses since 1917
- All fuses have carded packaging designed for retail sale

**Description WPS#**

**ATC BLADE TYPE**

Assortment 1 ea. 5, 10, 15, 20, 25, 30		<b>56-3200</b>
5 amp	5/pk	<b>56-3201</b>
7.5 amp	5/pk	<b>56-3202</b>
10 amp	5/pk	<b>56-3203</b>
15 amp	5/pk	<b>56-3204</b>
20 amp	5/pk	<b>56-3205</b>
25 amp	5/pk	<b>56-3206</b>
30 amp	5/pk	<b>56-3207</b>
40 amp	5/pk	<b>56-3208</b>



**Description WPS#**

**ATM BLADE TYPE**

Assortment 1 ea. 2, 5, 7.5, 10, 15, 20, 25, 30		<b>56-3210</b>
2 amp	5/pk	<b>56-3211</b>
5 amp	5/pk	<b>56-3212</b>
7.5 amp	5/pk	<b>56-3213</b>
10 amp	5/pk	<b>56-3214</b>
15 amp	5/pk	<b>56-3215</b>
20 amp	5/pk	<b>56-3216</b>
25 amp	5/pk	<b>56-3217</b>
30 amp	5/pk	<b>56-3218</b>



**Description WPS#**

**MAX BLADE TYPE**

30 amp	each	<b>56-3240</b>
40 amp	each	<b>56-3241</b>
50 amp	each	<b>56-3242</b>
60 amp	each	<b>56-3243</b>
70 amp	each	<b>56-3244</b>
80 amp	each	<b>56-3245</b>



**Description WPS#**

**AGC GLASS TYPE**

Assortment 1 ea. 5, 10, 15, 20, 30		<b>56-3230</b>
5 amp	5/pk	<b>56-3231</b>
7.5 amp	5/pk	<b>56-3232</b>
10 amp	5/pk	<b>56-3233</b>
15 amp	5/pk	<b>56-3234</b>
20 amp	5/pk	<b>56-3235</b>
25 amp	5/pk	<b>56-3236</b>
30 amp	5/pk	<b>56-3237</b>

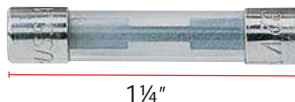

**Description WPS#**

**AGX GLASS TYPE**

Assortment 2 ea. 20, 25, 30	<b>56-3220</b>
-----------------------------	----------------

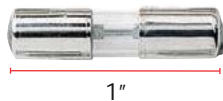

## 1 AMP REPLACEMENT FUSE

- (3) 5x20mm 1 Amp fuses
- Replacement for all StreetFX light kits

**WPS#**  
**12-6782**



## FUSE HOLDERS



	Description	WPS#
A	Crimp type connectors for #12 to #18 leads, use with AGX or ACG style fuses up to 30 amp (not included)	56-3271
B	#12 leadwires with protective cap, use with ATC style fuses up to 30 amp (not included)	56-3272
C	#16 leadwires (32volt) 2-20amp holder with cover	56-3273

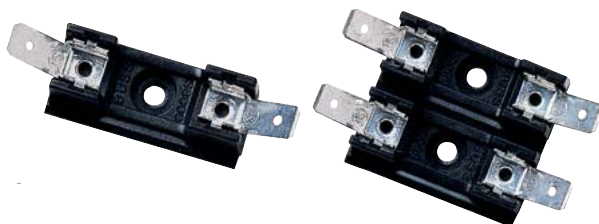

## FUSE PANELS

• 1/4" blade terminals, for use with AGC /AGX style fuses (20 amp maximum - not included)

Description	WPS#
1 position panel	56-3280
2 position panel	56-3281
4 position panel	56-3282



## FUSE BLOCKS

• 1/4" blade terminals, for use with ATC style fuses (30 amp maximum - not included)

Description	WPS#
4 position block	56-3283
6 position block	56-3284
8 position block	56-3285
10 position block	56-3286

## TOGGLE SWITCHES



	Description	WPS#
A	20 amp on-off	56-3260
B	20 amp on-off-on	56-3262
C	15 amp on-off	56-3261
D	15 amp on-off-on	56-3263
E	20 amp w/red LED on-off	56-3264

• Top quality switches from the #1 name in fuses  
 • All switches have carded packaging designed for retail sale



## FUSE HOLDER



• In-line fuse holder with 9 amp fuse and 18" of 16 gauge wire. Made of Nylon material. Spring loaded.

WPS#
56-3321

- WINDSHIELDS / FAIRINGS
- AUDIO / COMMUNICATION
- SEATS / LUGGAGE
- BARS / MIRRORS / CONTROLS
- EXHAUST
- AIR / FUEL SYSTEMS
- ENGINE
- TRANSMISSION / DRIVELINE
- GASKETS / SEALS
- ELECTRICAL**
- LIGHTING
- CABLES
- BRAKES
- OIL FILTERS
- SUSPENSION
- BODY
- WHEELS
- TIRES / TIRE ACC.
- BIKE ACC.
- VICTORY / INDIAN
- COVERS / LOCKS / TIEDOWNS
- CHEMICALS
- TOOLS
- HELMETS
- HELMET ACC.
- EYEWEAR
- APPAREL / RIDER ACC.
- PROMOTIONAL
- REFERENCE
- INDEX



## STOPLIGHT SWITCHES

- Heavy duty contacts and high conductivity brass terminals
- Bright plated housing with rugged molded insulators
- Reliable performance for all conditions

Description	WPS#
A Stoplight switch w/screw terminals	274-0200
B Stoplight switch w/spade terminals	274-0201

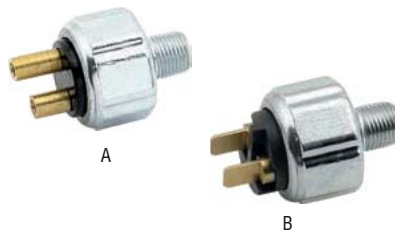

## OIL PRESSURE SWITCHES

- Protect your valuable engine with a reliable oil pressure switch
- Our stringent quality control standards assure accurate pressure every time
- Heavy duty contacts, brass ferrules and corrosion resistant plated steel shells are used for durability

Model	Year	OEM#	WPS#
A Sportster	'77-92	26554-77	274-0211
B Big Twins	'84-99	25651-84	274-0212
C Big Twins	'41-83	26552-72	274-0210

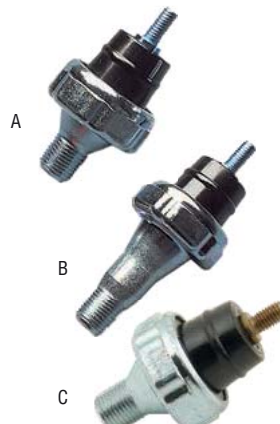

## UNIVERSAL SWITCH BRACKETS

- Chrome finish
- Works great for OEM replacement and custom builds
- Mounts almost anywhere with 5/16" mounting holes

Description	WPS#
A Dual hole mount for '36-84 Big twin trans	820-2677
B Single hole mount w/ 7/8" hole	820-2678
C Single hole mount w/ 3/4" hole	820-2679

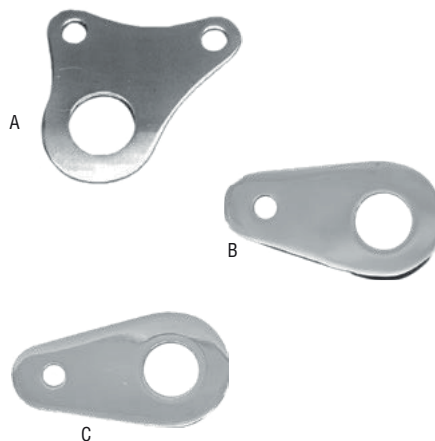

## 12 VOLT RELAY

- 12 Volt, 4 terminal, 40 amp electrical relay
- Terminal size: 1/4" (6.35 mm)
- Ideal for lighting, horns and many other accessories

Wiring pinout:

- 30: 12 Volt (+) fused power in from battery or main power source
- 85: Ground (-)
- 86: 12 Volt (+) power from accessory switch
- 87: 12 Volt (+) power out to accessory



WPS#  
60-1450

- WINDSHIELDS / FAIRINGS
- AUDIO / COMMUNICATION
- SEATS / LUGGAGE
- BAR / MIRRORS / CONTROLS
- EXHAUST
- AIR / FUEL SYSTEMS
- ENGINE
- TRANSMISSION / DRIVELINE
- GASKETS / SEALS
- ELECTRICAL
- LIGHTING
- CABLES
- BRAKES
- OIL FILTERS
- SUSPENSION
- BODY
- WHEELS
- TIRES / TIRE ACC.
- BIKE ACC.
- VICTORY / INDIAN
- COVERS / LOCKS / TIEDOWNS
- CHEMICALS
- TOOLS
- HELMETS
- HELMET ACC.
- EYEWEAR
- APPAREL / RIDER ACC.
- PROMOTIONAL
- REFERENCE
- INDEX



## SIDE HINGE IGNITION SWITCHES



- Late style switches are available with or without matching fork lock. Chrome or gloss black versions available.



Description	Chrome	Black
<b>FITS '11-17 FLS/FLST MODELS</b>		
Ignition Switch only	820-50854	820-50855
Ignition Switch w/Fork Lock	820-50856	820-50857
<b>FITS '93-08 FXDWG, '96-11 FXST/FLST, '94-UP FLHR</b>		
Ignition Switch only	820-50850	820-50851

## IGNITION SWITCHES

- Late model side hinge ignition switches
- Round key type
- Three position ignition: Off, Ignition only or Ignition w/ lights
- Two position ignition: Off and Ignition w/ lights



Description	Application	Finish	WPS#
A Round key ignition 2 position	'91-93 Dyna (except FXDWG)	Chrome	820-50852
B Round key ignition 3 position	'85 FX/FXS(except FXDWG) '84-93 FXR and '86-93 XL	Chrome	820-50853



- WINDSHIELDS / FAIRINGS
- AUDIO / COMMUNICATION
- SEATS / LUGGAGE
- BARS / MIRRORS / CONTROLS
- EXHAUST
- AIR / FUEL SYSTEMS
- ENGINE
- TRANSMISSION / DRIVELINE
- GASKETS / SEALS
- ELECTRICAL**
- LIGHTING
- CABLES
- BRAKES
- OIL FILTERS
- SUSPENSION
- BODY
- WHEELS
- TIRES / TIRE ACC.
- BIKE ACC.
- VICTORY / INDIAN
- COVERS / LOCKS / TIEDOWNS
- CHEMICALS
- TOOLS
- HELMETS
- HELMET ACC.
- EYEWEAR
- APPAREL / RIDER ACC.
- PROMOTIONAL
- REFERENCE
- INDEX



## ELECTRONIC FUEL INJECTION

- High quality EFI components
- Available for Delphi and Magneti Marelli

Description	Application	Year	OEM#	WPS#
A Fuel injector	Touring	'01-05, '08-16	27609-01A, 27609-01B	<b>275-01038</b>
	Softtail	'01-05, '16-17	27609-01	<b>275-01038</b>
	Dyna	'04-05	27609-04	<b>275-01038</b>
B	High flow fuel injector for Delphi® EFI equipped Harleys . 47 lbs/hr flow rate @ 3 bar	'01-05	27609-01	<b>275-01039</b> *
C Fuel pressure regulator	This Fuel Pressure Regulator was used on all Harleys with EFI up to 2001. Direct replacement for all FLT with EFI from 1995-2001	'95-01	27219-95	<b>275-01034</b>
	Upgrade from the Stock Marelli 3 bar regulator to this 3.5 bar regular	'95-01	27219-95	<b>275-01035</b> *
D Air temperature sensor	Touring	'95-05	27270-95	<b>275-01040</b>
	Softtail	'01-05	27270-95	<b>275-01040</b>
	Dyna	'04-05	27270-95	<b>275-01040</b>
E Barometric Sensor	Touring	'95-98	32424-95	<b>275-01041</b>
F MAP Sensor	Touring	'95-07	32316-99	<b>275-01043</b>
	Softtail	'99-09	32316-99	<b>275-01043</b>
	Dyna	'99-09	32316-99	<b>275-01043</b>
	Sportster	'03-06	32316-99	<b>275-01043</b>
	V-Rod	'04-09	32316-99	<b>275-01043</b>
G Throttle Position Sensor	Touring	'07-08	27659-06	<b>275-01031</b>
H	Touring	'02-05	27629-01	<b>275-01030</b>
	Softtail	'06-13	27659-06	<b>275-01031</b>
	Softtail	'01-05	27629-01	<b>275-01030</b>
	Dyna	'06-13	27659-06	<b>275-01031</b>
	Dyna	'04-05	27629-01	<b>275-01030</b>
	Sportster	'07-13	27629-01	<b>275-01030</b>
I Engine Temperature Sensor	Touring	'99-13	32466-99	<b>275-01032</b>
	Softtail	'01-13	32466-99	<b>275-01032</b>
	Dyna	'04-13	32466-99	<b>275-01032</b>
	Sportster	'07-08	32466-99	<b>275-01032</b>
	Idle Air Control Valve	Touring	'02-05	27628-01A
J Idle Air Control Motor	Softtail	'02-05	27628-01A	<b>275-01037</b>
	Dyna	2005	27628-01A	<b>275-01037</b>
	Sportster	'07-15	27628-01A	<b>275-01037</b>
Coolant Temperature Sensor	Touring	'06-07	27658-06	<b>275-01036</b>
	Softtail	'06-15	27658-06	<b>275-01036</b>
	Dyna	'06-16	27658-06	<b>275-01036</b>
V-Rod	'03-13	32315-01	<b>275-01033</b>	

\*Not legal in California



A



B



C



D



E



F



G



H



I



J

## NEUTRAL SAFETY SWITCHES

- American-made
- Manufactured to very stringent specifications to ensure proper function and long life
- Featuring high carbon steel stems hardened to 48 Rockwell C for maximum wear resistance and durability
- Direct OEM replacement

	Application	Year	OEM#	WPS#
A	FL 4speed	'65-E78	71507-65	<b>275-01080</b>
B	FL	'59-64	33900-59	<b>275-01081</b>
	FX,FL	'73-79	33900-59	<b>275-01081</b>
	FXST	'86	33900-59	<b>275-01081</b>
	FLT,FXR,FXST,FLST	'87-97	33900-59	<b>275-01081</b>
	XL	'86-98	33900-59	<b>275-01081</b>
C	FX 4speed	'71-E73	71507-71	<b>275-01082</b>
D	FX,FL	'L71-84	33901-79	<b>275-01083</b>
	FXST	'84-85	33901-79	<b>275-01083</b>
	FX,FXDWG,FXB,FXSB	'85-86	33901-79	<b>275-01083</b>
E	Big Twin	'98-00	33902-98	<b>275-01084</b>
	V-Rod	'08	33902-98	<b>275-01084</b>
F	Touring,Softail	'01-06	33904-00	<b>275-01085</b>
	Dyna	'01-05	33904-00B	<b>275-01085</b>



## OIL PRESSURE SWITCH

- American-made Oil Pressure Switches
- Designed to tight QC standards to assure maximum protection of your Harley's engine
- Precision calibrated, bright finished parts
- Heavy-duty contacts and mica-filled thermoplastic insulators to withstand extreme temperatures
- Diaphragms are designed to provide extra assurance against leaks and bursting
- Direct OEM replacement

Application	Year	OEM#	WPS#
Touring,Dyna	'99-13	26561-99	<b>275-01001</b>
Softail	'00-13	26561-99	<b>275-01001</b>
V-Rod	'03-13	26561-99	<b>275-01001</b>



## STOPLIGHT SWITCHES

- Top quality hydraulic rear stoplight switches
- Heavy duty contacts and top quality brass terminals ensure reliable performance in the most severe environments
- Direct OEM replacement

Application	Year	OEM#	WPS#
Big Twin (except '73-77 FX)	'71-14	72023-51C	<b>275-01050</b>
Sportster	'79-03	72023-51C	<b>275-01050</b>
Touring	'03-17	72023-51E	<b>275-01051</b>
Softail	'04-17	72023-51E	<b>275-01051</b>
FXD, FXDWG	'05-07	72023-51E	<b>275-01051</b>
Sportster	'03-17	72023-51E	<b>275-01051</b>
V-Rod	'07-17	72023-51E	<b>275-01051</b>



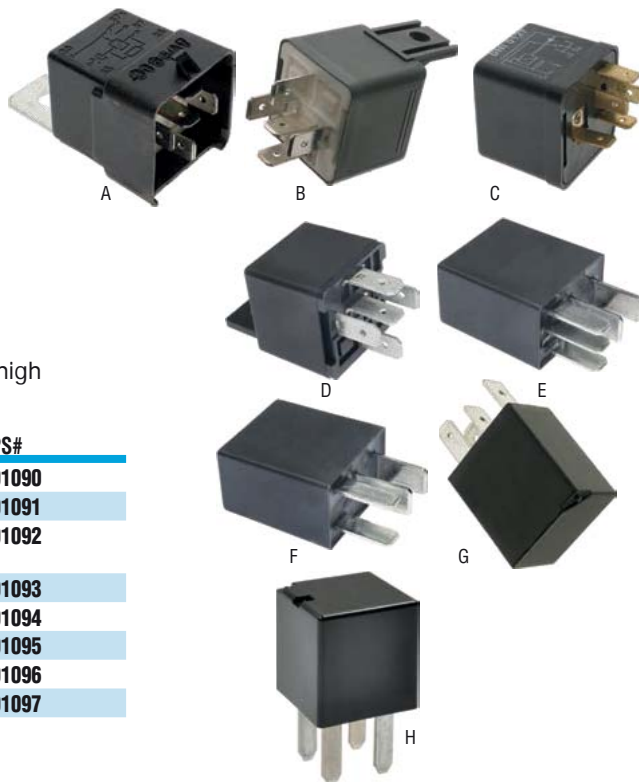

## RELAY SWITCHES

- Direct OE style replacement Relay switches
- Consistent and reliable starting performance and long-life
- Includes a heavy-duty brightly finished case and many of the high performance model features

	Description	Year	OEM#	WPS#
A	Most HD models with "plug" style Starter Relay	'80-99	31506-79B	<b>275-01090</b>
B	Same as above, but w/ no protective skirt	'80-99	31506-79B	<b>275-01091</b>
C	This headlight relay allows control of hi-low beam from one wire using a button type switch			<b>275-01092</b>
D	Starter and brake relay w/ diode works with most models	'91-07	31504-91B	<b>275-01093</b>
E	Big Twins	'00-13	31522-00C	<b>275-01094</b>
F	Big Twins	'00-11	31511-01A	<b>275-01095</b>
G	XL models	'05-09	31601-04	<b>275-01096</b>
H	Touring models	'04-17	31586-07	<b>275-01097</b>

## PUSH BUTTON SWITCHES

This extra heavy-duty momentary starter switch features 60 Amps at 12V, 40 Amps at 24V, silver contacts, flush terminals in molded insulator, a housing that is rolled over the insulator to seal out dust and moisture, hex back nut, bright polished face nut and a black molded plunger. Part also features a chrome plated protection collar for preventing accidental starts. Mounting stem 5/8" long, 5/8" diameter thread, overall length 1 13/16", housing diameter 15/16"

This heavy-duty two position, "Off-On" (normally "Off"), momentary switch features heavy duty contacts, two screw terminals and a 5/8" mounting stem. Rating: 12 Volts, 15 Amps. 24 Volts, 52 Amps.

WPS#  
**275-01120**



WPS#  
**275-01121**



## ILLUMINATED SWITCH

- Illuminated rocker switches can be used for many applications
- Snap in panel type switch with blade terminals

Description	WPS#
Green: 2 position ON/OFF blade terminals 12 Volts, 20 Amps	<b>275-01110</b>



# VACUUM OPERATED ELECTRIC SWITCHES



Standard Motor Products® Vacuum Operated Electrical Switches (VOES) are produced from high tech engineered thermoplastics and are 100% calibrated and vacuum tested to assure the accuracy and reliability of each part. Our self assembly kits allow the user to select a part from various preset levels of calibration for their specific tuning needs. Kits come complete with bracket, crimp terminals and instructions for easy installation.

Description	OEM#	WPS#
FXST '84-90, FLT '86-89, XL '86-93	26558-84	<b>275-01150</b>
FXR '84-90, XL '83-85	26557-83	<b>275-01151</b>
Softail, Dyna, FXR '91-95	26566-91	<b>275-01152</b>
Self Assembly Kit @ 3 of Mercury		<b>275-01153</b>
Self Assembly Kit @ 4 of Mercury		<b>275-01154</b>
Self Assembly Kit @ 5 of Mercury		<b>275-01155</b>
Self Assembly Kit @ 6 of Mercury		<b>275-01156</b>



## IGNITION SENSORS

- Direct OEM replacement
- Highly sensitive hall effect sensor to assure accurate timing position
- Built in voltage regulation, reverse battery protection and superior temperature stability

Description	OEM#	WPS#
FLT '80-93, FXR, XL '80-94, FXST '84-85	32400-80A	<b>275-01070</b>
Dyna '91-95	32404-90	<b>275-01071</b>
FLT '94-95, XL '95-97, XL1200S '98-03	32400-94	<b>275-01072</b>



## HEADLIGHT CONNECTORS

- Replacement and retrofit headlight connectors for H4 bulbs in both male and female versions
- Female version is a complete replacement for the OE socket, terminals and wires
- Temperature thermoplastic withstands temperatures in the confined space of the headlight housing for long term use and reliability
- Male version is for off-road applications and can be used when converting to an LED headlight without the need to alter your factory wiring

Description	WPS#
Complete replacement for OE socket, female version	<b>275-01140</b>
LED headlight conversion connector, male version	<b>275-01141</b> *

\*Not DOT approved. For aftermarket LED headlight assemblies

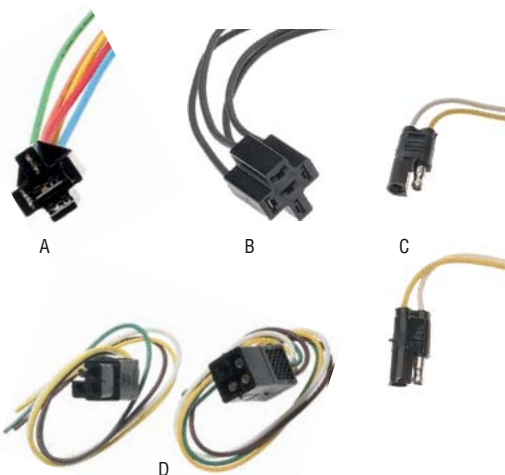

## CONNECTOR ASSEMBLIES

These relay connector assemblies come pre-wired and are ready to install, making the life of the custom bike builder and the mechanic much easier

Description	WPS#
A 5 Wire starter relay socket assembly	<b>275-01100</b>
B 4 wire starter relay socket assembly	<b>275-01101</b>
C Flat type 2 pole neoprene molded w/ 12" 18 gauge wire	<b>275-01130</b>
D Square type 4 pole neoprene molded w/ 12" 18 gauge wire	<b>275-01131</b>

- WINDSHIELDS / FAIRINGS
- AUDIO / COMMUNICATION
- SEATS / LUGGAGE
- BAR / MIRRORS / CONTROLS
- EXHAUST
- AIR / FUEL SYSTEMS
- ENGINE
- TRANSMISSION / DRIVELINE
- GASKETS / SEALS
- ELECTRICAL**
- LIGHTING
- CABLES
- BRAKES
- OIL FILTERS
- SUSPENSION
- BODY
- WHEELS
- TIRES / TIRE ACC.
- BIKE ACC.
- VICTORY / INDIAN
- COVERS / LOCKS / TIEDOWNS
- CHEMICALS
- TOOLS
- HELMETS
- HELMET ACC.
- EYEWEAR
- APPAREL / RIDER ACC.
- PROMOTIONAL
- REFERENCE
- INDEX



## ELECTRIC CHARGING SYSTEM KITS

- High quality ACCEL stator, rotor, and regulator in one complete kit
- Perfect for OE replacement or to upgrade earlier systems
- Features ACCEL's famous lifetime replacement warranty



Application	Year	Notes	WPS#
A Twin Cam Softails	'01-06	38 Amp 3 phase	<b>274-0073</b>
A Evolution Softail and Dynas	'91-99	32 Amp (not for Twin Cams)	<b>274-0072</b>
B Shovelhead and Evo Big Twin	'70-84	32 Amp upgrade	<b>274-0072</b>

## ELECTRIC ROTORS

- Heavy duty replacement rotors
- High quality magnets enclosed by stainless steel
- Reinforced housing and splines for the ultimate in durability
- Perfect compliment to our Lectric Stators



A



B

Application	Year	OEM#	WPS#
A Touring	'00-05	29981-95	<b>274-0071</b>
A Softails	'01-06	29981-95	<b>274-0071</b>
B Softails	'91-00	29957-81	<b>274-0070</b>
A Dynas	'04-05	29981-95	<b>274-0071</b>
B Dynas	'00-03	29957-81	<b>274-0070</b>
B Dynas	'91-99	29957-81	<b>274-0070</b>



## STATORS

- Precision machine wound using only the finest components
- Pure copper windings are coated with a high temperature insulation to protect from grounding
- Designed for maximum output and reliability
- All applications feature factory style connectors for plug and play installation
- Covered by ACCEL's famous Limited Lifetime Replacement Warranty



274-0256



274-0255



274-0264

Application	Year	OEM#	WPS#	Rated Amps
<b>TOURING</b>				
All models	'06-16	29987-06A	<b>274-0264</b>	50
	'02-05	29987-02	<b>274-0263</b>	45
	'99-01	29987-99	<b>274-0262</b>	38
	'97-98	29987-97	<b>274-0259</b>	38
All Models Ex EFI	'89-99	29970-88A	<b>274-0256</b>	32
Unmolded	'81-88	28865-81A	<b>274-0253</b>	22
Molded	'81-88	28865-81	<b>274-0252</b>	22
Molded	'76-80	29965-75	<b>274-0251</b>	17.8
Unmolded	'70-75	29965-70	<b>274-0250</b>	15
<b>SOFTAIL</b>				
All Models	'07	30017-07	<b>274-0261</b>	40
	'01-06	30017-01	<b>274-0260</b>	38
	'00	29951-99	<b>274-0258</b>	32
	'89-99	29970-88A	<b>274-0256</b>	32
Unmolded	'85-88	28865-81A	<b>274-0253</b>	22
Molded	'85-88	28865-81	<b>274-0252</b>	22
<b>DYNA</b>				
All Models	'07	30017-07	<b>274-0261</b>	40
	'04-06	30017-01	<b>274-0260</b>	38
	'99-03	29951-99	<b>274-0258</b>	32
	'91-98	29970-88A	<b>274-0256</b>	32
<b>SPORTSTER</b>				
All Models	'91-06	29967-89	<b>274-0257</b>	22
	'90-95	29967-84A	<b>274-0255</b>	19
Molded	'85-90	29967-84	<b>274-0254</b>	19

## ALTERNATOR WIRE RETAINER



- Nylon retainer (repl. OEM 29954-71)
- Includes mounting screws

Description	WPS#
Fits Evo Big Twins from '70-88 sold each	<b>820-50860</b>

- WINDSHIELDS / FAIRINGS
- AUDIO / COMMUNICATION
- SEATS / LUGGAGE
- BAR / MIRRORS / CONTROLS
- EXHAUST
- AIR / FUEL SYSTEMS
- ENGINE
- TRANSMISSION / DRIVELINE
- GASKETS / SEALS
- ELECTRICAL**
- LIGHTING
- CABLES
- BRAKES
- OIL FILTERS
- SUSPENSION
- BODY
- WHEELS
- TIRES / TIRE ACC.
- BIKE ACC.
- VICTORY / INDIAN
- COVERS / LOCKS / TIEDOWNS
- CHEMICALS
- TOOLS
- HELMETS
- HELMET ACC.
- EYEWEAR
- APPAREL / RIDER ACC.
- PROMOTIONAL
- REFERENCE
- INDEX



# ALTERNATOR KITS

- Cycle Electric alternator kits combine our state of the art stator with our legendary bullet proof rectifying regulator and a stock Harley rotor
- Better low speed output
- Smoother charge to the battery for crisper starting and longer battery life
- Durable and longer lasting system
- Full two year guarantee and are 100% American made



Application	Year	Notes	Alternator Kit	Usable DC Amps	
				1000 rpm	2500 rpm
<b>BIG TWINS 1970-1998 SHOVEL HEAD AND EVO</b>					
FLH-FLT (Note 2)	'97-98	80ser/50amp	<b>273-1124</b>	35	54
Big Twins	'89-98		<b>273-1105</b>	14	29
FLH-FLT-FXR (Note 2)	'89-98	80ser/50amp	<b>273-1123</b>	35	54
Softail (L), (P)	'89-99		<b>273-1107</b>	14	29
Rigid mount 4 speed big twins	'84-88	70ser/45amp	<b>273-1120</b>	25	50
FXS Softail 91-98 FXD Dyna	'84-99	60ser/38amp	<b>273-1112</b>	17	38
Rubber mount 5 speed FLH-FLT-FXR (Note 2)	'79-96	60ser/38amp	<b>273-1111</b>	17	38
All Big Twins	'70-98		<b>273-1103</b>	14	20
All Big Twins (P)	'70-98		<b>273-1104</b>	14	20
Rigid mount 4 speed big twins	'70-84	60ser/38amp	<b>273-1110</b>	17	38
<b>FLH-FLT TWIN CAM TOURING MODELS</b>					
FLH-FLT (OE replacement)	'11-13		<b>273-1139</b>	35	54
FLH-FLT w/ Oil Cooler	'09-10		<b>273-1140</b>		
FLH-FLT (Note 3) (OE replacement)	'09-10		<b>273-1130</b>	35	54
FLH-FLT (Note 2) (OE replacement)	'07-08		<b>273-1129</b>	35	54
FLH-FLT (Note 2) (OE replacement)	'06		<b>273-1128</b>	35	54
FLH-FLT (Note 2)	'04-05	80ser/50amp	<b>273-1127</b>	35	54
FLH-FLT (Note 2)	'99-03	80ser/50amp	<b>273-1132</b>	35	54
<b>SOFTAIL TWIN CAM 2000-UP</b>					
Softail (OE replacement)	'12-17		<b>273-1136</b>	33	50
Softail (OE replacement)	'08-11		<b>273-1134</b>	33	50
Softail (OE replacement)	'07		<b>273-1126</b>	33	50
All FXS Softail (OE replacement)	'01-06		<b>273-1113</b>	20	38
Softail (upgrade)	'01-06	70ser/45amp	<b>273-1121</b>	25	50
<b>DYNA TWIN CAM 1999-UP</b>					
Dyna (OE replacement)	'12-17		<b>273-1135</b>	33	50
Dyna (OE replacement)	'08-11		<b>273-1133</b>	33	50
Dyna ('07 OE replacement)	'06-07		<b>273-1125</b>	33	50
Dyna (OE replacement)	'04-05		<b>273-1114</b>	20	38
Dyna	'99-03	32amp	<b>273-1108</b>	14	29
Dyna upgrade to 3 phase	'99-03		<b>273-1115</b>	17	38
Dyna upgrade to 3 phase	'99-03		<b>273-1122</b>	25	50
<b>SPORTSTER</b>					
XL1200	'09-17		<b>273-1144</b>	15	27
XL883	'09-17		<b>273-1143</b>	15	27
XL1200	'07-08		<b>273-1142</b>	15	27
XL883	'07-08		<b>273-1141</b>	15	27
1200 Sportster	'04-06	60ser/38amp	<b>273-1118</b>	17	38
Sportster	'94-03		<b>273-1102</b>	14	20
Sportster	'91-93		<b>273-1101</b>	14	20
Sportster	'91-03	60ser/38amp	<b>273-1117</b>	17	38
<b>INDIAN</b>					
Indian Chief With Gilroy Powerplus 100			<b>273-1137</b>	14	29
			<b>273-1138</b>	17	38
			<b>273-1138</b>	17	38

**Note 1:** These kits include the Screamin Eagle® Big Twin Compensator upgrade. Starting on the 2006 & later Dyna®, 2007-2010 Touring and 2007 & later Softail® models (except FXCW, FXCWC and FXSTSEE3) the compensator spring cup is built in to the alternator rotor.

**Note 2:** Not recommended for use with oil coolers that mount in front of the regulator. Cycle Electric Inc. does not recommend installing an oil cooler in front of any regulator.

**Note 3:** Will not fit with low mount oil cooler.

**(L)** = Low volt for use with battery in a horse shoe oil tank  
**(P)** = Pass through Wiring  
**(NB)** = No battery, requires a magneto for the ignition



# STATORS



- Insulation able to withstand temperatures of 600° F to eliminate stator burn out
- Better low speed output to reduce battery discharge at an idle
- Lower operating temperature for longer service life
- Improved plugs that will not swell or separate



273-1402



273-1407



273-1415

Application	Year	OEM#	WPS#	Rated Amps	Amps 1000 RPM	Amps 2500 R.P.M.
<b>BIG TWIN</b>						
Big Twin w/ Evo	'89-99	29970-88	<b>273-1426</b>	32	14	29
All Big Twin models	'81-88	29965-81A	<b>273-1421</b>	22	14	20
All Big Twin models	'76-80	29965-75	<b>273-1412</b>	18	11.5	19
Misc. (for use on 38Amp and 45Amp kits)			<b>273-1432</b>	38/48	32	48
<b>TOURING</b>						
All models	'06-16	29987-06A	<b>273-1418</b>	50	35	54
	'02-05	29987-02	<b>273-1402</b>	38/48	18/32	38/48
	'99-01	29987-99	<b>273-1404</b>	38/48	18/32	38/48
	'97-98	29987-97	<b>273-1403</b>	38/48	18/32	38/48
<b>SOFTAIL</b>						
All models	'08-17	30017-08	<b>273-1415</b>	47	33	50
	'07	30017-07	<b>273-1413</b>	47	33	50
	'01-06	30017-01	<b>273-1405</b>	38	20	38
	'00	29951-99	<b>273-1431</b>	32	14	29
<b>DYNA</b>						
All models	'08-17	30017-08	<b>273-1415</b>	47	33	50
	'07	30017-07	<b>273-1413</b>	47	33	50
	'04-06	30017-01	<b>273-1405</b>	38	20	38
	'99-03	29951-99	<b>273-1431</b>	32	14	29
<b>SPORTSTER</b>						
All models	'07-17	29997-07	<b>273-1401</b>	32	14	29
	'91-06	29967-89	<b>273-1429</b>	22	12	20
	'84-90	29967-84A	<b>273-1424</b>	18		18



273-1212



273-1277



273-1222

## REGULATORS

- All Cycle Electric Regulators are built to last
- Rugged design capable of handling overloads and continuous operation
- Top quality materials and military spec. assembly processes to ensure a low failure rate and the longest service life

Application	Year	OEM#	WPS#
<b>BIG TWIN</b>			
All models	'81-88	74516-86	<b>273-1202</b>
	'76-80	74512-79A	<b>273-1201</b>
<b>TOURING</b>			
All models (Will not fit with low mount oil cooler)	'09-16		<b>273-1231</b>
All models with oil cooler	'09-19		<b>273-1240</b>
All models	* '06-08	74505-06	<b>273-1230</b>
	* '04-05	74505-04	<b>273-1219</b>
	* '02-03	74505-02	<b>273-1218</b>
	* '97-01	74505-97	<b>273-1220</b>
FLHTCUI, FLHTCI, FLCUI	'95-96	74505-95	<b>273-1217</b>
FL (Except fuel injected)	'89-96	74519-88	<b>273-1212</b>
<b>SOFTAIL</b>			
All models	'08-17	74540-08	<b>273-1223</b>
	'07	74540-07	<b>273-1222</b>
	'01-06	74540-01	<b>273-1221</b>
	'00	74512-00	<b>273-1216</b>
	'89-99		<b>273-1213</b>
	'84-88		<b>273-1203</b>
<b>DYNA</b>			
All models	'08-17	74631-08	<b>273-1226</b>
	'06-07	74631-06	<b>273-1225</b>
	'04-05	74631-04	<b>273-1224</b>
	'99-03	74518-99A	<b>273-1215</b>
FXR & FXD	'89-98	74519-88	<b>273-1212</b>

Application	Year	OEM#	WPS#
<b>SPORTSTER</b>			
All models	'09-17	74711-08	<b>273-1241</b>
XR1200	'08	74711-08	<b>273-1241</b>
All Models except XR1200	'07-08	74564-07	<b>273-1211</b>
	'04-06	74523-04	<b>273-1210</b>
	'94-03	74523-94A	<b>273-1209</b>
	'92-93	74523-92A	<b>273-1208</b>
	'91	74523-91	<b>273-1207</b>
	Late '84-90	74523-84A	<b>273-1206</b>
<b>INDIAN</b>			
Gilroy Power Plus Indian Chiefs	'02-UP		<b>273-1233</b>
<b>MISC</b>			
For use with NO BATTERY and 22 amp Stator (battery eliminator kit needed)			<b>273-1204</b>
<b>All Models w/ Generators</b>		<b>Generator #</b>	<b>WPS#</b>
Replacement		273-1452	<b>273-1235</b>
Replacement		273-1453	<b>273-1236</b>
End bell regulator		273-1451	<b>273-1237</b>
End bell 12V regulator for 6V conversions with 12V battery in oil Tank		273-1451	<b>273-1238</b>
End bell 6V regulator		273-1457	<b>273-1239</b>

\* Not recommended with low mount oil cooler

- WINDSHIELDS / FAIRINGS
- AUDIO / COMMUNICATION
- SEATS / LUGGAGE
- BARS / MIRRORS / CONTROLS
- EXHAUST
- AIR / FUEL SYSTEMS
- ENGINE
- TRANSMISSION / DRIVELINE
- GASKETS / SEALS
- ELECTRICAL**
- LIGHTING
- CABLES
- BRAKES
- OIL FILTERS
- SUSPENSION
- BODY
- WHEELS
- TIRES / TIRE ACC.
- BIKE ACC.
- VICTORY / INDIAN
- COVERS / LOCKS / TIEDOWNS
- CHEMICALS
- TOOLS
- HELMETS
- HELMET ACC.
- EYEWEAR
- APPAREL / RIDER ACC.
- PROMOTIONAL
- REFERENCE
- INDEX



## REGULATORS

- Meet / Exceed Original Equipment specifications
- High Power and quality SCR (Silicon Controlled Rectifier) utilized to allow a cooler operation
- High temperature and environmentally protected (sealed) encapsulation
- High temperature – Late technology circuit board utilized on higher watt-density surface mount applications where heat issues are a major concern. This approach minimizes thermal impedance and conducts heat more effectively and efficiently than standard printed wiring boards that are used on products available through OEM or other manufacturers.
- High temperate and voltage OEM grade wiring harness

820-60148



820-60100



820-60110



820-60149



820-60101



820-60111

Application	Year	OEM #	Black	Chrome
<b>TOURING</b>				
All models	'09-16	* 74505-09	<b>820-60155</b>	<b>820-60156</b>
	'06-08	74505-06	<b>820-60100</b>	<b>820-60101</b>
	'04-05	74505-04	<b>820-60102</b>	<b>820-60103</b>
	'02-03	74505-02	<b>820-60104</b>	<b>820-60105</b>
	'97-01	74505-97	<b>820-60106</b>	<b>820-60107</b>
<b>SOFTAIL</b>				
All models	'08-10	74540-08	<b>820-60108</b>	<b>820-60109</b>
	'07	74540-07	<b>820-60110</b>	<b>820-60111</b>
	'01-06	74610-01	<b>820-60112</b>	<b>820-60113</b>
	'00	74512-00	<b>820-60114</b>	<b>820-60115</b>
<b>DYNA</b>				
All models	'08-16	74631-08	<b>820-60116</b>	<b>820-60117</b>
	'06-07	74631-06	<b>820-60118</b>	<b>820-60119</b>
	'04-05	74631-04	<b>820-60120</b>	<b>820-60121</b>
	'99-03	74518-99A	<b>820-60122</b>	<b>820-60123</b>
<b>BIG TWIN</b>				
All Evo Big Twin (except fuel injected)	'89-99	74519-88	<b>820-60124</b>	<b>820-60125</b>
All models	'81-88	74516-86	<b>820-60126</b>	<b>820-60127</b>
FL, FLH	'76-80	74510-75A	<b>820-60128</b>	<b>820-60129</b>
FL, FX	'70-75	74510-70A	<b>820-60130</b>	<b>820-60131</b>
<b>SPORTSTER</b>				
All models	'09-13	74711-08	<b>820-60132</b>	<b>820-60133</b>
	'07-08	74546-07	<b>820-60134</b>	<b>820-60135</b>
	'04-06	74523-04	<b>820-60136</b>	<b>820-60137</b>
	'94-03	74523-94	<b>820-60138</b>	<b>820-60139</b>
	'92-93	74523-92	<b>820-60140</b>	<b>820-60141</b>
	'91	74523-91	<b>820-60142</b>	<b>820-60143</b>
	Late '84-90	74523-84A	<b>820-60144</b>	<b>820-60145</b>
	'82-Early 84	74504-82	<b>820-60146</b>	<b>820-60147</b>
	'78-81	74504-78	<b>820-60148</b>	<b>820-60149</b>
<b>MISC</b>				
XL, FLH 12V	'65-69	74507-85	<b>820-60150</b>	<b>820-60151</b>
XL, FLH 6V	'58-64	74508-85	<b>820-60152</b>	<b>820-60153</b>
12V mounts to Generator			<b>820-60154</b>	

\*Will not work with low mounted oil cooler



### GENERATOR BRUSHES

- Engineered for peak charging system output on demand
- Brush sets utilize precision ground carbon graphite and premium grade springs

Model	Year	OEM#	Generator Model	WPS#
FL, FLH	'58-69	30426-58	58, 61	<b>274-0220</b>
XL, XLH, XLCH, XLS	'58-81	30426-58	58, 61	<b>274-0220</b>



### GENERATOR OVERHAUL KITS

- Engineered for peak charging system output on demand
- Overhaul kits contain brushes, quality oil seal and cover gasket

Model	Year	Generator Model	WPS#
FL, FLH	'58, '64-69	58, 64, 65, 65A	<b>274-0222</b>
XL, XLH, XLCH, XLS	'58-64	58, 61	<b>274-0222</b>



274-0230



274-0231



274-0232

### ELECTRO-MECHANICAL VOLTAGE REGULATORS

- Provides precise control of charging system voltage for maximum performance and reliability
- Built with high quality components set to OEM factory specifications
- Available in show chrome or black enamel finishes



274-0234

Model	Year	Charging System	OEM#	Black	Chrome
FL, FLH	'58-64	6V Generator	74510-47A		<b>274-0232</b>
K, XL	'52-64	6V Generator	74510-47A		<b>274-0232</b>
FL, FLH	'65-69	12V Generator	74510-64	<b>274-0230</b>	<b>274-0231</b>
XLH 1200cc	'65-77	12V Generator	74510-64	<b>274-0230</b>	<b>274-0231</b>
XLH 900cc	'65-66	12V Generator	74511-65	<b>274-0233</b>	<b>274-0234</b>
XLCH 900cc/1000cc	'65-77	12V Generator	74511-65	<b>274-0233</b>	<b>274-0234</b>

- WINDSHIELDS / FAIRINGS
- AUDIO / COMMUNICATION
- SEATS / LUGGAGE
- BARS / MIRRORS / CONTROLS
- EXHAUST
- AIR / FUEL SYSTEMS
- ENGINE
- TRANSMISSION / DRIVELINE
- GASKETS / SEALS
- ELECTRICAL**
- LIGHTING
- CABLES
- BRAKES
- OIL FILTERS
- SUSPENSION
- BODY
- WHEELS
- TIRES / TIRE ACC.
- BIKE ACC.
- VICTORY / INDIAN
- COVERS / LOCKS / TIEDOWNS
- CHEMICALS
- TOOLS
- HELMETS
- HELMET ACC.
- EYEWEAR
- APPAREL / RIDER ACC.
- PROMOTIONAL
- REFERENCE
- INDEX

- WINDSHIELDS / FAIRINGS
- AUDIO / COMMUNICATION
- SEATS / LUGGAGE
- BARS / MIRRORS / CONTROLS
- EXHAUST
- AIR / FUEL SYSTEMS
- ENGINE
- TRANSMISSION / DRIVELINE
- GASKETS / SEALS
- ELECTRICAL**
- LIGHTING
- CABLES
- BRAKES
- OIL FILTERS
- SUSPENSION
- BODY
- WHEELS
- TIRES / TIRE ACC.
- BIKE ACC.
- VICTORY / INDIAN
- COVERS / LOCKS / TIEDOWNS
- CHEMICALS
- TOOLS
- HELMETS
- HELMET ACC.
- EYEWEAR
- APPAREL / RIDER ACC.
- PROMOTIONAL
- REFERENCE
- INDEX



## GENERATOR

- New replacement generator matches OEM specifications
- Double sealed bearing for longer life
- Needle bearings with high temperature lubricant for longer life
- High temperature epoxy armature provides strength to secure wires
- Includes self locking nylon nut



Application	Year	Description	OEM#	WPS#
<b>HARLEY DAVIDSON</b>				
Big Twin	'58-69	12V 10A black prestolite	29975-65/29978-77A	<b>280-2001</b>
XL	'54-84	12V 10A black prestolite	29975-65/29978-77A	<b>280-2001</b>



## GENERATOR

- Cycle Electric Inc. manufactures the model 65A 12V and model 61 6V generators to Harley-Davidson specifications for restoration purposes
- The model 65A is rated at 10 amps and the model 61 at 15 amps They are both capable of producing 20-30 amps. For this reason it is very important to have a properly working current limiting regulator to restrict amperage draw on the generator to (10 amps on the 65A, 15 amps on the 61 model). Improper regulation may cause generator damage not covered under warranty
- Complete charging system for generator bikes
- It features simplified wiring, higher output, longer service life
- This is the last generator you will have to buy for your bike.

Harley Davidson	OEM#	WPS#	Rep. Regulator
(model 65A) 12V OEM replacement for '65-81 models with Generators	29975-65A	<b>273-1451</b>	<b>273-1237</b>
12V high output Generator w/ built in Regulator for '65-84 models with Generators		<b>273-1452</b>	<b>273-1235</b>
12V low output Generator w/ built in Regulator use for upgrading from a 6V Generator		<b>273-1453</b>	<b>273-1236</b>
(model 61) 6V OEM stock replacement for '58-64 also fits '36-57 models	29975-61	<b>273-1456</b>	<b>273-1239</b>
6V charging system use on '36-64 models		<b>273-1457</b>	
Replacement end plate w/ bearing	30095-61	<b>273-1471</b>	



## 12V GENERATOR

- Replacement 12V generator for Pan and Shovel (early) motors
- Can be used to upgrade early bikes to 12V with addition of a compatible regulator



Model	Year	Description	OEM#	Black
Big Twin	'65-69	Generator 12V	29975-65A	<b>26-20003</b>



### SOLENOID END COVERS/ STARTER BUTTONS

- Can be used for primary or auxiliary starter button
- Easy to install
- Available in chrome and wrinkle black

Description	Chrome	Wrinkle Black
Direct starter button for '90-Up Big Twin and Sportster models	<b>820-2696</b>	<b>820-2697</b>



### STARTER MOTORS



- New (not rebuilt) starter motors
- Direct O.E.M. replacement
- 1 year limited warranty against manufacturer defects (warranty does NOT cover water damage due to submersion)

Model	Year	Description	OEM#	Black	OEM#	Chrome	Drive
<b>HARLEY DAVIDSON</b>							
	'66-88	Prestolite 0.8kw starter	31463-88T	<b>26-20001</b>		<b>26-20001C</b>	
	'66-88	Hitachi 0.8kw starter	31570-73	<b>26-30011</b>	31570-73	<b>26-30011C</b>	
		1.4kw 10-32 threaded starter	31553-90	<b>26-20006</b>	31553-94	<b>26-20006C</b>	<b>26-25001</b>
	'07-16**	1.4kw 10-32 threaded starter	31618-06	<b>26-20013</b>	31618-06A	<b>26-20013C</b>	
Sportster	'81-14	1.4kw 10-32 threaded starter	31390-86	<b>26-20004</b>		<b>26-20004C</b>	
V-Rod	'02-16	Starter	31717-01K	<b>26-20020</b>		<b>26-20010</b> †	

\*Except 2006 Dyna Models  
 \*\*Including 2006 Dyna Models  
 †Silver finish



### STARTER BUTTON

Tired of committing the reach around? The guys at NMC have come up with a stylish solution. Their new starter plunger is the perfect aftermarket alternative, with a 1 1/4" black knob and an overall length of 4 1/4". The plunger comes with a black powder coated steel body, steel shaft and bronze bushing. Just reach down and give it a push and start your bike.



Description	WPS #
Starter Button	<b>811-30120</b>

- WINDSHIELDS / FAIRINGS
- AUDIO / COMMUNICATION
- SEATS / LUGGAGE
- BAR / MIRRORS / CONTROLS
- EXHAUST
- AIR / FUEL SYSTEMS
- ENGINE
- TRANSMISSION / DRIVELINE
- GASKETS / SEALS
- ELECTRICAL**
- LIGHTING
- CABLES
- BRAKES
- OIL FILTERS
- SUSPENSION
- BODY
- WHEELS
- TIRES / TIRE ACC.
- BIKE ACC.
- VICTORY / INDIAN
- COVERS / LOCKS / TIEDOWNS
- CHEMICALS
- TOOLS
- HELMETS
- HELMET ACC.
- EYEWEAR
- APPAREL / RIDER ACC.
- PROMOTIONAL
- REFERENCE
- INDEX



## HIGH TORQUE STARTERS

- ALL BALLS starter motors are manufactured with all new components that have been fine-tuned for starting the H-D V-Twin engine
- All starters are supplied with a 10/32 threaded output shaft, and a conversion bolt for the earlier 1/4-20 threaded output shafts to cover all Big Twins from 1989 thru 2005
- Idler gears are manufactured from cold-heated steel
- End frames are cold-chamber die cast and machined on precision fixtures
- Armature hairpins are resistance-fused to the commutator
- Our clutches utilize 20% oversize rollers



280-1001/1002



280-1003/1004



280-1005/1006



280-1009/1010



280-1013/1014

Application	Year	Description	OEM#	Black	OEM#	Chrome
<b>HARLEY DAVIDSON</b>						
Big Twins	'66-88	1.4KW Hitachi	31570-73	<b>280-1005</b>		<b>280-1006</b>
	'66-88	1.4KW Prestolite	31463-88T	<b>280-1007</b>		<b>280-1008</b>
Dyna	'89-05	1.4KW	31553-90	<b>280-1001</b>	31553-94	<b>280-1002</b>
	'89-05	1.7KW	31553-90	<b>280-1003</b>	31553-94	<b>280-1004</b>
	'06-16	1.4KW 6 speed	31618-06	<b>280-1013</b>	31618-06A	<b>280-1014</b>
Softail	'89-06	1.4KW	31553-90	<b>280-1001</b>	31553-94	<b>280-1002</b>
	'89-06	1.7KW	31553-90	<b>280-1003</b>	31553-94	<b>280-1004</b>
	'07-16	1.4KW 6 speed	31618-06	<b>280-1013</b>	31618-06A	<b>280-1014</b>
Sportster	'81-16	1.4KW	31390-86	<b>280-1009</b>	31390-91B	<b>280-1010</b>
Touring	'89-06	1.4KW	31553-90	<b>280-1001</b>	31553-94	<b>280-1002</b>
	'89-06	1.7KW	31553-90	<b>280-1003</b>	31553-94	<b>280-1004</b>
	'07-16	1.4KW 6 speed	31618-06	<b>280-1013</b>	31618-06A	<b>280-1014</b>

## STARTER CLUTCHES

- Lifetime warranty
- Clutches come with heavy duty bearings and hardened intermediate gear
- These newly developed clutches are by far the most durable high quality clutches in today's marketplace
- They were developed by MES using special metals, high temperature springs, and special hardness coated cam and rollers
- Economy starter clutches are delivered without bearing, slipper mechanism only



Application	Year	Description	OEM#	Black
A Big Twins	** '07-16	Lifetime warranty starter clutch	31681-07	<b>820-60304</b>
B Big Twins	* '91-06	Lifetime warranty starter clutch	31663-90	<b>820-60302</b>
C Big Twins	* '91-06	Economy starter drive clutch	31663-90	<b>820-60303</b>
Big Twins	'65-88	Heavy Duty starter drive clutch	31443-65	<b>820-60300</b>

\*except 06 Dyna  
 \*\*includes 2006 Dyna models

## EASY START KITS

These kits improve starting on high compression engines through improved starter to clutch basket gear ratio. Complete kit includes a clutch basket with bearing, a 66T starter ring and a 9T starter pinion.



Description	Application	WPS#
A Easy Start Kit	94-97 Big Twins	<b>820-50950</b>
B Replacement 9T Pinion	98-06 Big Twins w/ 5spd	<b>820-50951</b>
		<b>820-50952</b>

- WINDSHIELDS / FAIRINGS
- AUDIO / COMMUNICATION
- SEATS / LUGGAGE
- BARS / MIRRORS / CONTROLS
- EXHAUST
- AIR / FUEL SYSTEMS
- ENGINE
- TRANSMISSION / DRIVELINE
- GASKETS / SEALS
- ELECTRICAL**
- LIGHTING
- CABLES
- BRAKES
- OIL FILTERS
- SUSPENSION
- BODY
- WHEELS
- TIRES / TIRE ACC.
- BIKE ACC.
- VICTORY / INDIAN
- COVERS / LOCKS / TIEDOWNS
- CHEMICALS
- TOOLS
- HELMETS
- HELMET ACC.
- EYEWEAR
- APPAREL / RIDER ACC.
- PROMOTIONAL
- REFERENCE
- INDEX



## STARTER COMPONENTS

### 6-Speed Replacement Starter Clutch

- Completely assembled including new pinion gear
- Solves the kick out problem associated with worn OEM clutches
- Strengthened shaft insure reliable starting

### Replacement Starter Clutch Assembly

- An all-new replacement clutch utilizing 20% oversize rollers to improve clutch life under hard starting conditions



Component	Application	Year	OEM #	Clutch
<b>HARLEY DAVIDSON</b>				
Starter Clutch	Big Twin	'65-88	31443-65A	<b>279-2109</b>
Starter Clutch	Sportster	'67-80	31443-65A	<b>279-2109</b>
Starter Clutch and Bearings	Big Twin	'89-90	31544-90	<b>279-2103</b>
Starter Clutch and Bearings	Big Twin*	'91-06	31663-90	<b>279-2101</b>
Starter Clutch, Bearings and Pinion Gear	Big Twin**	'07-16	31681-07	<b>279-2104</b>
Starter Clutch, Bearings and Pinion Gear	Sportster	'81-17	31556-91B	<b>279-2110</b>

\*Except 2006 Dyna  
\*\*Including 06 Dyna

ELECTRICAL

## JACKSHAFT KITS

- Improves performance at a lower cost
- Delivers more torque to the primary while reducing the occurrence of shaft binding
- Cushioning spring is moved to the back, eliminating the need for the inner primary support bearing making the jackshaft easier to install

Application	Year	Description	OEM#	WPS#
<b>HARLEY DAVIDSON</b>				
Big Twin	'89-93	9-tooth (large gear)	33126-90,93	<b>279-2105</b>
	'94-06*	9-tooth conversion †		<b>279-2107</b>
	'94-06*	10-tooth (small gear)	33126-94	<b>279-2106</b>

\*Except 2006 Dyna models †Conversion requires 66 tooth ring gear







**STARTER JACKSHAFTS**



Replacement for OEM starter jackshafts. All bolts, snap rings, lock tabs etc. included.



A



B



C

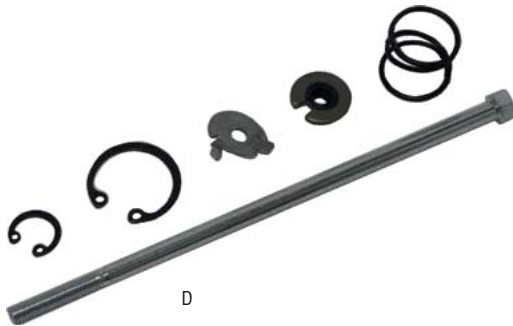

D



E

Description	Application	WPS#
A Starter Jackshaft 10-Tooth	'94-06	<b>820-50970</b>
B Starter Jackshaft 9-Tooth	'89-93	<b>820-50971</b>
C Jackshaft Repair Kit	'94-06	<b>820-50972</b>
D Jackshaft Repair Kit	for 820-50970	<b>820-50973</b>
E Jackshaft Repair Kit	for 820-50971	<b>820-50974</b>
	for 820-50972	<b>820-50975</b>

- WINDSHIELDS / FAIRINGS
- AUDIO / COMMUNICATION
- SEATS / LUGGAGE
- BAR / MIRRORS / CONTROLS
- EXHAUST
- AIR / FUEL SYSTEMS
- ENGINE
- TRANSMISSION / DRIVELINE
- GASKETS / SEALS
- ELECTRICAL**
- LIGHTING
- CABLES
- BRAKES
- OIL FILTERS
- SUSPENSION
- BODY
- WHEELS
- TIRES / TIRE ACC.
- BIKE ACC.
- VICTORY / INDIAN
- COVERS / LOCKS / TIEDOWNS
- CHEMICALS
- TOOLS
- HELMETS
- HELMET ACC.
- EYEWEAR
- APPAREL / RIDER ACC.
- PROMOTIONAL
- REFERENCE
- INDEX



## STARTER RING GEAR

- Replacement bolt on ring gear 102 tooth
- Hardware included
- For stock clutch baskets



Description	WPS#
Fits Big Twins from '98-06	<b>820-50955</b>

## STARTER LEVERS



Description	WPS#
Fits Big Twins from '80-84 w/Hitachi Starter (repl. OEM 31300-80A)	<b>820-50954</b>
Fits XLH '67-80 (repl. OEM 31424-67)	<b>820-50953</b>

## STARTER OIL DEFLECTOR

- Used on various FX and FL models with electric start and chain drive
- Sold each



Description	WPS#
Fits Electric Start Chain Drive Big Twins from '65-84 (OEM 60516-65A)	<b>820-50960</b>



## 4-SPEED SOLENOID

- Heavy duty copper contacts insure full current flow
- A must have for our high performance starters



## SOLENOID REPAIR KITS

- Each kit contains the movable and stationary contacts, gaskets, insulators, and hardware to replace all of the wear items

Application	Year	Description	OEM#	WPS#
<b>HARLEY DAVIDSON</b>				
Big Twin	'65-88	4 speed solenoid	71469-69	<b>279-2108</b>
	'89-06*	solenoid repair kit		<b>279-1101</b>
	'07-16**	solenoid repair kit		<b>279-1102</b>
Sportster	'67-80	4 speed solenoid	71469-69	<b>279-2108</b>
	'81-16	solenoid repair kit		<b>279-1101</b>

\*except 2006 Dyna      \*\*including 2006 Dyna



# STARTER SOLENOIDS & RELAYS



## STARTER SOLENOIDS

- Heavy duty replacement quality
- Designed to deliver positive starter engagement every time
- Hardened steel plungers and moisture proof cases are used for maximum durability
- Available in show quality chrome, stealth black and zinc plate



Application	OEM#	Zinc	Chrome	Black
Single Bracket for 4 Speed Models	71469-65B	<b>274-0011</b>	<b>274-0013</b>	<b>274-0012</b>
Dual Bracket for 5 Speed Models	31489-79B	<b>274-0015</b>	<b>274-0017</b>	<b>274-0016</b>

## SOLENOID REPAIR KIT

- Complete kit contains all the parts necessary to rebuild an OE or ACCEL solenoid
- Includes plunger, lugs, spring assembly, bakelite cap and hardware
- Rebuild for a fraction of the cost of new



Description	WPS#
Solenoid repair kit	<b>274-0014</b>

## STARTER RELAY EARLY

- Durable heavy duty contacts in a rugged molded case
- Totally sealed from moisture and road grime
- Reliable starting



Model	Year	OEM#	WPS#
Most Big Twins	'73-85	71463-73C	<b>274-0010</b>
Sportster Models	'75-79	71463-73C	<b>274-0010</b>

## STARTER RELAY (BOSCH® STYLE)

- Injection molded case eliminates corrosion for increased durability
- Relays designed to work in high performance applications
- Works great in stock bikes too



Model	Year	WPS#
Most Big Twins	'80-94	<b>274-0030</b>
Sportster models	'80-92	<b>274-0030</b>

- WINDSHIELDS / FAIRINGS
- AUDIO / COMMUNICATION
- SEATS / LUGGAGE
- BARS / MIRRORS / CONTROLS
- EXHAUST
- AIR / FUEL SYSTEMS
- ENGINE
- TRANSMISSION / DRIVELINE
- GASKETS / SEALS
- ELECTRICAL**
- LIGHTING
- CABLES
- BRAKES
- OIL FILTERS
- SUSPENSION
- BODY
- WHEELS
- TIRES / TIRE ACC.
- BIKE ACC.
- VICTORY / INDIAN
- COVERS / LOCKS / TIEDOWNS
- CHEMICALS
- TOOLS
- HELMETS
- HELMET ACC.
- EYEWEAR
- APPAREL / RIDER ACC.
- PROMOTIONAL
- REFERENCE
- INDEX



## DIAGNOSTIC SCAN TOOLS

### A. TWIN SCAN II ABS PLUS KIT

- Includes Twin Scan II ABS
- WEGO IIID Interface
- Two Bosch LSU 4.2 wide-band oxygen sensors
- Two 18 x 1.5 mm weld nuts, two 18 x 1.5 mm hex socket plugs
- USB cable and software on CDROM



### B. TWIN SCAN 3 ABS PLUS KIT

- Includes Twin Scan 3 ABS
- WEGO IIID Interface
- Two Bosch LSU 4.2 wide-band oxygen sensors
- Two 18 x 1.5 mm weld nuts, two 18 x 1.5 mm hex socket plugs
- USB cable and software on CDROM



### C. TWIN SCAN COMPLETE KIT

- Includes both Twin Scan II ABS and Twin Scan 3 ABS units
- WEGO IIID Interface
- Two Bosch LSU 4.2 wide-band oxygen sensors
- Two 18 x 1.5 mm weld nuts, two 18 x 1.5 mm hex socket plugs
- USB cable, probe kit, and software on CDROM



ELECTRICAL

LIGHTING

CABLES

BRAKES

OIL FILTERS

SUSPENSION

BODY

WHEELS

TIRES / TIRE ACC.

BIKE ACC.

VICTORY / INDIAN

COVERS / LOCKS / TIEDOWNS

CHEMICALS

TOOLS

HELMETS

HELMET ACC.

EYEWEAR

APPAREL / RIDER ACC.

PROMOTIONAL

REFERENCE

INDEX

## DIAGNOSTIC SCAN TOOLS

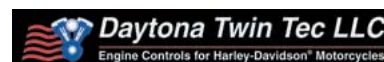
**D. TWIN SCAN II ABS**

- Compatible with 2003-2006 carbureted models with new 12 pin ignition module
- Anti-Skid Brake System (ABS) brake bleeding functions for 2008-2013 Touring models
- Support for 2006-2013 closed loop fuel injection systems
- Real time display of engine data on instrument panel type display
- Uses laptop PC for display, includes Windows software

**E. TWIN SCAN 3 ABS**

- Anti-Skid Brake System (ABS) brake bleeding functions for 2008-2013 Touring models
- Real time display of engine data on instrument panel type display
- Includes two analog inputs with 0-20V or +200V range
- Features two channel scopemeter capability for waveform display
- Analog inputs can also be used for air/fuel ratio
- Uses laptop PC for display, includes Windows software

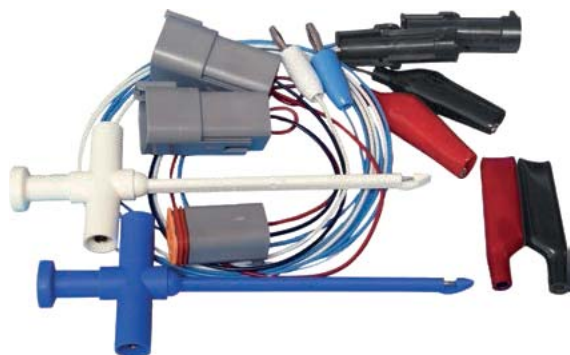
**F. TWIN SCAN 3 PROBE KIT**

- For scopemeter feature
- Two insulation piercing probes
- 12 volt power adapter

**G. TWIN SCAN WEGO UPGRADE KIT**

- For customers with any Twin Scan II or 3 version
- Includes WEGO IID Interface
- Two Bosch LSU 4.2 wide-band oxygen sensors, two 18 x 1.5 mm weld nuts, and two 18 x 1.5 mm hex socket plugs
- \*Compatible with 2001-2014 HD fuel injected models using the Delphi system (including V-Rod) with J1850 data bus.
- Not compatible with 2011-2014 Softail and 2012-2014 Dyna models with CAN data bus



	Application	WPS#
A	'01-15 fuel injected models and '03-06 Carbureted models	<b>132-7024</b> *
B	'11-15 Softail, '12-15 Dyna, '14-15 XL and Touring models with CAN data bus	<b>132-7026</b>
C	Twin Scan Complete Kit	<b>132-7031</b>
D	'01-15 fuel injected models and '03-06 Carbureted models	<b>132-7022</b> *
E	'11-15 Softail and '12-15 Dyna models with CAN data bus	<b>132-7023</b>
F	Twin Scan 3 ABS Probe Kit	<b>132-7027</b>
G	Twin Scan Wego Upgrade Kit	<b>132-7028</b>
	Single channel Wego 3 system wide band w/ harness and software	<b>132-7058</b>
REPLACEMENT PARTS		
H	O2 sensor for Wego3 and Twin Scan 3	<b>132-7059</b>
I	Weld nut for O2 sensor	<b>132-7061</b>
J	Hex plug for O2 sensor weld nut	<b>132-7063</b>

\*Compatible with 2001-2013 HD fuel injected models using the Delphi system (including V-Rod) with J1850 data bus.  
Not compatible with 2011-2014 Softail and 2012-2014 Dyna models with CAN data bus

WINDSHIELDS / FAIRINGS

AUDIO / COMMUNICATION

SEATS / LUGGAGE

BARS / MIRRORS / CONTROLS

EXHAUST

AIR / FUEL SYSTEMS

ENGINE

TRANSMISSION / DRIVELINE

GASKETS / SEALS

ELECTRICAL

LIGHTING

CABLES

BRAKES

OIL FILTERS

SUSPENSION

BODY

WHEELS

TIRES / TIRE ACC.

BIKE ACC.

VICTORY / INDIAN

COVERS / LOCKS / TIEDOWNS

CHEMICALS

TOOLS

HELMETS

HELMET ACC.

EYEWEAR

APPAREL / RIDER ACC.

PROMOTIONAL

REFERENCE

INDEX

- WINDSHIELDS / FAIRINGS
- AUDIO / COMMUNICATION
- SEATS / LUGGAGE
- BAR / MIRRORS / CONTROLS
- EXHAUST
- AIR / FUEL SYSTEMS
- ENGINE
- TRANSMISSION / DRIVE SHAFT
- GASKETS / SEALS
- ELECTRICAL**
- LIGHTING
- CABLES
- BRAKES
- OIL FILTERS
- SUSPENSION
- BODY
- WHEELS
- TIRES / TIRE ACC.
- BIKE ACC.
- VICTORY / INDIAN
- COVERS / LOCKS / TIEDOWNS
- CHEMICALS
- TOOLS
- HELMETS
- HELMET ACC.
- EYEWEAR
- APPAREL / RIDER ACC.
- PROMOTIONAL
- REFERENCE
- INDEX



# DIAG4<sup>®</sup> SERIAL DIAGNOSTIC SYSTEM

Professional diagnostic tool for Harley Davidson & Buell workshops and tuning centers. Diagnoses electronic fuel injection module (EFI) and others (Security modules, ABS, etc.) through the diagnostic connector. The system consists of a communication interface with Harley-Davidson adapter, USB cable for connection to your Laptop (PC) and software (SOLD SEPARATELY) compatible with Windows XP, Vista, 7, 8 and 10. A wireless Bluetooth version of the interface is also available. An adapter for CAN-BUS models is included. The system performs the following functions and more. Software for Indian and Victory is also available.

## OVERVIEW OF CONTROL UNITS THAT CAN BE DIAGNOSED ON HARLEY DAVIDSONS

- Ignition Module All models temperature, oxygen sensors, turn signals etc.)
- EFI (Electronic Fuel Injection Module) - All models
- TSSM (Turn Signal Security Module)..... Key FOB with button
- HFSM (Hands Free Security Module)..... Key FOB without button
- BCM (Body Control Module)..... Key FOB without button
- Gauges (Speedo, Tach and Instrument Module) -
- ABS Module (Delphi + CAN models) - All models
- Radio and Audio all models
- Thunder MAX EFI
- Read and Clear Diagnostic Trouble Codes..... All models
- Read Identification data (part numbers, VIN number)..... All models
- Monitoring real-time data (throttle position,
- Test actuators (injectors, coils, main relay, fuel pump, idle, turn signals, tachometer, lamps etc.)
- Buell diagnostics are incorporated in Harley-Davidson diagnostics
- Unit of measure selection metric/standard
- Communication interface is CAN ready (models with 6-pin connector)



## MOTORCYCLE REPORT

Search for and identify all embedded control units. Read fault code memory + generate and print a diagnostic report with odometer reading

## TOOLBOX

(Special functions that can be performed)

- Module replacement -TSM, TSSM, HFSM, BCM,
- ABS Service (Bleeding and configuration, Delphi + CAN models) - All models
- ACR (Automatic compression release during starting)
- Cruise Control, Exhaust actuator, EITMS..... enable/disable
- Side Stand Switch Configuration - All Models
- Intake Solenoid Valve Configuration on CAN Models
- Radio customization- region code and speaker configuration, radio
- J&M Audio Configuration
- ABS Telltale Configuration on CAN Models
- Idle speed adjustment 800 - 1200 rpm (models with Delphi Electronic Fuel Injection Module)
- TSSM Customization..... PIN read/change, Auto arming disable/enable etc.
- HFSM Customization..... Key FOB assignment/ replacement, Auto arming disable/enable, PIN read/change, Side car and Service Mode (disable/enable)
- BCM Customization..... Key FOB assignment/ replacement, Auto arming disable/enable, PIN read/change, Lights configuration, keyless ignition
- Disarming (HFSM/ BCM module)..... PIN read/FOB assignment on armed bike (for BCM modules a CAN disarming cable is needed)
- Buell TPS adjustment
- Dataloging
- ABS Module (embedded/ not embedded)
- Speedo module pairing
- Wheel size adjustment (Speedo calibration)
- Odometer unit setting



## OVERVIEW OF CONTROL UNITS THAT CAN BE DIAGNOSED ON INDIAN AND VICTORY

- Indian – 2014 - 2017
- Victory – 2008 - 2017
- Engine control module
- ABS control module
- Gauge (Speedo, Tacho ...) module
- Vehicle control module
- Radio control module
- Read Vehicle information
- Read and Clear
- Diagnostic Trouble Codes
- Monitoring Real-Time data

## MOTORCYCLE REPORT

Search for and identify all embedded control units. Read fault code memory + generate and print a diagnostic report

Description	WPS#
A USB Serial Interface (w/Case)	867-02000
B USB Serial Interface (w/Case) Bluetooth	867-02001
C Diagnostic Software for Harley Davidson	867-02002
Diagnostic Software for Indian/Victory	867-02004
D Voltmeter Module	867-02020
E CAN Disarming Cable	867-02021
Replacement Interface to Bike Cable 4-Pin	867-02010
Replacement Interface to Bike Cable 6-Pin	867-02011
Replacement Computer to Interface Cable	867-02012

## PARALLEL DIAGNOSTIC SYSTEM



Parallel diagnostics are designed for measuring input and output signals from the electronic fuel injection module (EFI) and other modules. Measurements can be made on running engines. The system consists of a wiring harness adapter and breakout box. The breakout box is inserted between EFI module and motorcycle's wiring harness so that the system continues to function as normal. Monitoring points for all connector pins of the EFI module are clearly arranged on the breakout box. It is possible to measure signals and waveforms from all systems and actuators. Disconnecting the ECU from the breakout box allows quick and reliable check of the integrity of the wiring harness in respect to continuity, and leakage currents. Universal connector kit includes common adapters (73 connectors) for non-destructive diagnostic operations on the wiring harness.



A

Description	WPS#
A Breakout Box	867-02022
B 36 Pin Delphi EFI Adapter	867-02023
C 73 Pin Delphi EFI Adapter	867-02024
D 35 Pin Magnetti and Bosch EFI Adapter	867-02025
E 12/4 Pin Security Module Adapter	867-02026
F 18/18 Pin CAN BUS Delphi EFI Adapter	867-02027
G 36/48 Pin BCM Module Adapter	867-02028
H Universal Connector Kit	867-02040



B



C



D



E



F



G



H

WINDSHIELDS /  
FAIRINGSAUDIO /  
COMMUNICATIONSEATS /  
LUGGAGEBARS / MIRRORS /  
CONTROLS

EXHAUST

AIR /  
FUEL SYSTEMS

ENGINE

TRANSMISSION /  
DRIVELINEGASKETS /  
SEALS

ELECTRICAL

LIGHTING

CABLES

BRAKES

OIL FILTERS

SUSPENSION

BODY

WHEELS

TIRES /  
TIRE ACC.

BIKE ACC.

VICTORY /  
INDIANCOVERS / LOCKS /  
TIEDOWNS

CHEMICALS

TOOLS

HELMETS

HELMET ACC.

EYEWEAR

APPAREL /  
RIDER ACC.

PROMOTIONAL

REFERENCE

INDEX



## EFI TUNING SYSTEM

- The tuning system is intended for Harley-Davidson engines equipped with DELPHI EFI (diagnostic communication J1850 or CAN BUS)
- The tuning system is integrated into the software of the diagnostic system DIAG4BIKE, the basic tuning software DIAG4TUNE is included as a FREE option in the diagnostic software versions 12 and later. To tune an individual motorcycle a TUNING DONGLE must be purchased that can be used for that specific motorcycle.

- The tuning process does not require the installation of additional component(s) or any motorcycle harness modification. Tuning is achieved through modification of the EFI Calibrations (software modification/reflash) exclusively via the diagnostic connector.
- The first step in TUNING is saving of the original EFI calibration. The tuning operator can restore the original EFI Calibration at any time during tuning process (stock calibration)
- The tuning process is used to optimize FUEL MAPS to accommodate any changes to the configuration of engine components or accessories (exhaust or/and intake system etc.)

### A) BASIC TUNING DONGLE

The Basic Tuning Dongle enables EASY MODE in the tuning software. EASY MODE provides the ability to adjust fuel trim tables, acceleration enrichment and spark advance tables manually in a limited range of +/- 20%. Closed loop mode can be switched on or off and Throttle By Wire speed up function can be activated (crisper response). Other functions are restricted.

	Description	WPS#
A	Tuning Dongle Basic	867-02050
B	Tuning Dongle Advanced Dongle Pack 3+1	867-02051 867-02052
C	AFR Tuning Monitor	867-02070
D	Lambda Installation Kit	867-02071
E	Lambda Install Kit Mini	867-02072
F	Open Exhaust Adapter	867-02073



### B) ADVANCED TUNING DONGLE

The key function of the Tuning Dongle is to save the original EFI calibration. With this function the original calibration can be restored at any time, the tuning dongle also incorporates the tuning licence exclusively for one motorcycle and must be purchased for tuning of each individual motorcycle and will be mated to the ECM of that motorcycle. It enables ADVANCED MODE in the tuning software. Custom fuel maps and timing tables can be created as desired with the help of the AFR tuning monitor or downloaded from a database of preset maps.



### C) AFR TUNING MONITOR

The AFR Tuning Monitor is used for the advanced tuning mode and consists of two wideband Air/Fuel ratio sensors and a compact electronic unit. It is an option for the DIAG4BIKE communication interface and can be used with a roller station or on road tests to develop custom fuel maps.



### D) LAMBDA INSTALLATION KIT

This set is an option to the AFR Tuning Monitor. It allows you to install a pair of wide band sensors on all exhausts where it is not possible to simply replace the installed O2 sensors (M18 thread). The set contains a powerful double pump, which ensures high accuracy and measurement speed of the actual AFR in each cylinder. The pump is powered by a 12V supply and can therefore also be used for road testing.



### E) INSTALLATION SET LAMBDA MINI

This set is an option to AFR Tuning Monitor. It allows you to install a pair of wide band lambda sensors on all exhausts where it is not possible to simply replace the installed lambda sensors (M18 thread).



### F) OPEN EXHAUST ADAPTER







## 2000i 2KI PROGRAMMABLE IN CONE IGNITION

The Dyna 2Ki Programmable Ignition is the newest addition to the successful line of Dyna 2000 ignition systems. The 2Ki not only adds to, but extends many features of the best selling Dyna 2000 module out of sight in a completely new design that fits in the cone of Shovelhead and Evolution engines. **Not legal for use in California on pollution controlled vehicles - Check local laws before installing.**



- Single Fire operation down to zero rpm for easier cranking
- 8 advance curves to cover a broad range of engine builds and riding styles.
- Engine over rev protection adjustable from 6000 to 7500 rpm.
- Adjustable timing retard for nitrous and turbo applications.
- Active Dwell Control.

Description	Year	WPS#
Carbureted Models Module Only '98-03 Sportster (except XL1200S) Big Twins	'70-98	<b>133-3014</b>
Carbureted Models sgl plug/sgl fire kit Module & DC3-1 Coils	'70-98	<b>133-3015</b>
Carbureted Models dual plug/sgl fire kit Module & DC1-1 Coils	'70-98	<b>133-3016</b>
Carbureted Models dual plug/dual fire kit Module & DC2-1 Coils	'70-98	<b>133-3017</b>
Carbureted Models sgl plug/single fire Module & DC6-5 Coil	'70-98	<b>133-3018</b>

## DYNA 2000 PROGRAMMABLE IGNITION MODULE



The Dyna 2000 Digital Ignition System for Harley-Davidson Motorcycles, which has become the standard for performance and versatility in the Harley aftermarket, has been enhanced to include even more features. Including expanded advance curve functionality, vacuum advance compensation, and a special Retard Mode for use with turbocharged and nitrous bikes.

The Dyna 2000 allows selection between four different advance curves and four independent rev limiter settings from 6000 to 7500 rpm.

Dyna 2000 ignition modules use the stock factory pick-up and simply plug into the existing factory wiring harness on 1991-1998 model bikes.

**Not legal for use in California on pollution controlled vehicles - Check local laws before installing.**

Application	WPS#
Digital HD single/dual fire	<b>133-3008</b>
Digital HD single/dual 8 pin	<b>133-3009</b>
Digital HD dual fire	<b>133-3010</b>
Digital HD dual fire 8 pin	<b>133-3011</b>
7 to 8 pin adapter	<b>133-3012</b>
Extension harness	<b>133-3013</b>

## DYNA 2000 PROGRAMMABLE IGNITION KITS



The Dyna 2000 Digital Ignition System for Harley-Davidson Motorcycles, which has become the standard for performance and versatility in the Harley aftermarket, has been enhanced to include even more features. Including expanded advance curve functionality, vacuum advance compensation, and a special Retard Mode for use with turbocharged and nitrous bikes.

The Dyna 2000 allows selection between four different advance curves and four independent rev limiter settings from 6000 to 7500 rpm.

Dyna 2000 ignition modules use the stock factory pick-up and simply plug into the existing factory wiring harness on 1991-1998 model bikes. This kit also includes the appropriate performance ignition coil.

**Not legal for use in California on pollution controlled vehicles - Check local laws before installing.**

Application	WPS#
Sportsters, FLH to 93, FXR to 95 7 pin connector	<b>133-3019</b>
Sportsters 1994-97, FLH, 95-later FXR 8 pin connector	<b>133-3020</b>

- WINDSHIELDS / FAIRINGS
- AUDIO / COMMUNICATION
- SEATS / LUGGAGE
- BAR / MIRRORS / CONTROLS
- EXHAUST
- AIR / FUEL SYSTEMS
- ENGINE
- TRANSMISSION / DRIVELINE
- GASKETS / SEALS
- ELECTRICAL**
- LIGHTING
- CABLES
- BRAKES
- OIL FILTERS
- SUSPENSION
- BODY
- WHEELS
- TIRES / TIRE ACC.
- BIKE ACC.
- VICTORY / INDIAN
- COVERS / LOCKS / TIEDOWNS
- CHEMICALS
- TOOLS
- HELMETS
- HELMET ACC.
- EYEWEAR
- APPAREL / RIDER ACC.
- PROMOTIONAL
- REFERENCE
- INDEX



## DYNA S IGNITION SYSTEM

The Dyna S High Performance Ignition System, designed for Harleys, is a complete self-contained electronic ignition system built with the latest state-of-the-art engineering. This is the same ignition used by top racers over the past 2 decades. The Dyna S is completely housed behind the ignition cover and uses a magnetic rotor with the original spark advancer, so the factory advance curve is maintained. **Not legal for use in California on pollution controlled vehicles - Check local laws before installing.**

Note: Must be used with 5 ohm coils for street operation

Description	WPS#
1970 & later (dual fire)	133-3001
1970 & later (single fire)	133-3002



## DYNA S IGNITION KIT

The Dyna S High Performance Ignition System, designed for Harleys, is a complete self-contained electronic ignition system built with the latest state-of-the-art engineering. This is the same ignition used by top racers over the past 2 decades. The Dyna S is completely housed behind the ignition cover and uses a magnetic rotor with the original spark advancer, so the factory advance curve is maintained.

Dyna high tech coils for Harley-Davidson Big Twins and Sportsters are American made, top quality performance coils. Tested and proven on street, racing, and touring motorcycles for over fourteen years. Dyna coils produce spark voltages in excess of 30,000 volts and spark energies second to none. All Dyna Coils are guaranteed against defects in materials and workmanship. **Not legal for use in California on pollution controlled vehicles - Check local laws before installing.**

- The 133-3003 Dyna S and coil system includes a 133-1086 high energy coil
- The 133-3004 Dyna S and coil system is designed for single-fire applications; includes two Dyna coils

Application	WPS#
1970 & later (dual fire)	133-3003
1970 & later (single fire)	133-3004



## DYNA 2000 TC IGNITION

Dynatek's TC88 Digital Performance Ignition signals a new era in Twin Cam ignition power and capability. The TC88 enhances the power of the Single Fire ignition by allowing selection between 16 programmable advance curves, covering the entire range of engine modifications. From stock to insanelly modified engines, the TC88 provides the widest range and highest level of advance curve functionality for Twin Cam available in today's market. There are also eight different rev limiter settings from 5750-7250 rpm. All TC88 functions have full digital accuracy to insure maximum performance with unparalleled quality. **Not legal for use in California on pollution controlled vehicles - Check local laws before installing.**

Application	Year	WPS#
Twin Cam (Carbureted)	'99-03	133-3005
Twin Cam (Carbureted)	'04-06	133-3006
Sportster	'04-06	133-3007



## DYNA COILS



Dyna Performance Replacement Coils are high tech, top quality coils, designed for maximum performance. They produce spark voltages in excess of 30,000 volts and spark energies second to none. Dynatek coils are available in a wide variety of resistances and output configurations to allow easy replacement of stock coils. Dynatek coils work with factory electronic ignitions, points, and aftermarket ignitions. Choose from four body styles and five different primary resistance ranges to match your ignition needs. Advanced magnetic core technology of the Dynatek Mini Series Coils delivers high output in one of the smallest packages available. Great for customs where coils need to be hidden.

Before selecting a coil, check the coil primary resistance requirements as specified by the manufacturer of the ignition being used.

The Dyna Twin Fire coil is the new standard for performance and packaging efficiency for single fire ignition installations on Harley-Davidson Motorcycles. The Twin Fire coil incorporates two individual performance ignition coils into one easy to mount package. This solves the problem of trying to mount two ignition coils on Harleys when installing single fire ignition systems. The Twin Fire coil is only slightly larger than the stock Harley coil and uses the stock mounting bracket. The Twin Fire coil will fit under the tank on XL AND FLH models as well as in the stock location on the side of the motor for FXR models or rear of the motor for Dyna and Softail models. The DC6-4 is used for all dual spark plug head applications. The Dyna Twin Fire coil can be used with any electronic advance ignition system that incorporates dwell control, but cannot be used with the DS6-2 Dyna S or similar ignitions. **Not legal for use in California on pollution controlled vehicles - Check local laws before installing.**

Ohm	Application	Year	Ignition	Color	Dyna #	WPS #
0.4	EFI Big Twins	'01-06	Stock	Black	DC6-7	<b>133-1084</b>
	EFI Big Twins (except M8)	'07-17	Stock	Black	DC6-9	<b>133-1087</b>
0.4	EFI Sportster	'07-17	Stock	Black	DC6-8	<b>133-1085</b>
0.5	Carbureted TwinCam		Stock	Black	DC6-6	<b>133-1083</b>
3	Single Plug-Dual Fire		Dyna HD/2000I/D2KI	Green	DC6-1	<b>133-1080</b>
3	Single Plug-Single Fire		Dyna HD/2000I/D2KI	Green	DC3-1	<b>133-1089</b>
3	Dual Plug-Single Fire		Dyna HD/2000I/D2KI	Black	DC6-4	<b>133-1081</b>
3	Single Plug-Single Fire		Dyna HD/2000I/D2KI	Black	DC6-5	<b>133-1082</b>
3	Dual Plug-Single Fire		Mini series/Stock	Black	DC1-3	<b>133-1090</b>
5	Single Plug-Dual Fire		Dyna S / OE Points	Black	DC7-1	<b>133-1086</b>
5	Single Plug-Single Fire		Dyna S / OE Points	Black	DC-10	<b>133-1088</b>

## PROGRAMMING KITS

Take your Dyna Ignition to the next level with the Dyna HD Programming Kit that works with the Dyna 2000 and Dyna 2KI ignitio systems. Now riders, performance tuning shops and engine builders can find all that they need to properly tune their bikes.



PROGRAMMING KITS/HARNESS	WPS#
Programming Kit D2Ki-P	And ALL D2Ki Kits w/Coils <b>133-3031</b>
Programming Harness (Bike Side Stub )	D2Ki Applications Only <b>133-3032</b>
Programming Kit 2000HD1EP,	2000HD2EP and SFK-1 <b>133-3033</b>
Programming Kit 2000HD1E8,	2000HD2E8 and SFK-3 <b>133-3034</b>
Programming Kit TC88-2P	<b>133-3035</b>
USB Programming Kit DFS & 2000i Apps	<b>133-3036</b>



## 1005 INTERNAL IGNITION

- Wide timing advance adjustment range accommodates stock to highly modified engines
- Digitally set RPM limit (100 RPM steps)
- Selectable single or dual fire mode
- Coil outputs protected against short circuits
- Billet aluminum housing
- The Model 1005 ignition replaces all the HD OE ignition components
- **Not legal for use in California on pollution controlled vehicles - Check local laws before installing**



Model#	Application	WPS#
1005	'70-99 Big Twin and '71-03 Sportster	<b>132-7014</b> *
1005-EX	'84-99 Big Twin models, '86-93 XL	<b>132-7077</b>
1005S-EX	'98-03 Sportster (except 1200S)	<b>132-7035</b>
1005	Internal Ignition Kit	<b>132-7054</b> * †
1005-EX	Internal Ignition Kit	<b>132-7039</b> ‡

†Includes 132-7014 ignition, 132-7019 coil, and 132-7053 wire set  
 ‡Includes 132-7077 ignition, 132-7019 coil, and 132-7053 wire set

ELECTRICAL

## TC88 & TC88A IGNITION MODULES

- Wide timing advance adjustment range accommodates stock to highly modified engines
- Selectable multi-spark mode for quick starting and smooth cruise
- Billet aluminum housing with black anodized finish
- Easy plug-in installation
- Supports all sensors including theft/security module
- Coil outputs support against short circuits
- TC88 EX and TC88A EX are California Legal



Model #	Application	WPS#
TC88	'99-03 Carbureted Twin Cam 88 Engines	<b>132-7015</b> *
TC88 EX	'99-03 Carbureted Twin Cam 88 Engines	<b>132-7078</b>
TC88	Ignition Kit	<b>132-7041</b> * †
TC88 EX	Ignition Kit	<b>132-7080</b> ‡
TC88A	'04-06 Carbureted Twin Cam 88 Engines and XL models with single 12 pin connector	<b>132-7016</b> *
TC88A EX	'04-06 Carbureted Twin Cam 88 models and XL models with single 12 pin connector	<b>132-7079</b>
TC88A	Ignition Kit	<b>132-7042</b> * †
TC88A EX	Ignition Kit	<b>132-7081</b> ‡

†Kits include ignition, USB-INTF USB interface, 132-7020 coil, and universal wire set  
 ‡Kits include ignition, 132-7020 coil, and universal wire set  
 \*Not legal for use in California on pollution controlled vehicles - Check local laws before installing

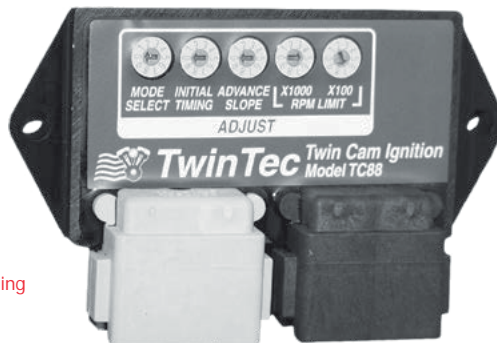



### V-TWIN IGNITION SYSTEM

- Wide timing advance adjustment range accommodates stock to highly modified engines
- Digitally set RPM limit (100 RPM steps)
- Selectable single or dual fire mode
- Selectable multi-spark mode for quick starting and smooth cruise
- Coil outputs protected against short circuits
- Optional USB interface and software for programming custom advance curve
- Billet aluminum housing with black anodized finish
- Easy plug-in installation



Application	WPS#
'90-94 Big Twin and '90-93 883 XLH with 7 pin Cannon plug	<b>132-7036</b>
'95-98 Big Twin with 8 pin Deutsch plug	<b>132-7037</b>
1006 EX Ignition Kit	<b>132-7033</b> †
1007 EX Ignition Kit	<b>132-7034</b> ‡
External Ignition Conversion for '90-Up Evo	<b>132-7043</b>
External Ignition Conversion for '90-Up Evo KIT	<b>132-7044</b> †

† Includes 132-7036 ignition, 132-7019 coil, and 132-7053 universal wire set  
 ‡ Includes 132-7037 ignition, 132-7019 coil, and 132-7053 wire set

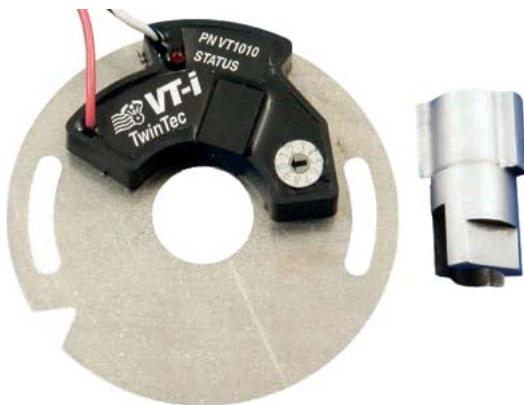

### V-TWIN IGNITION SYSTEM

- Precise digitally set RPM limiter (200 RPM steps from 5200 to 7200 RPM)
- Status LED for easy static timing
- Electronic dwell control for maximum ignition energy at high RPM and reduced current draw at low RPM
- Simple two wire hookup to coil for easy installation
- Operates down to below 6 volts for reliable starting under all conditions, including kick start
- Fully encapsulated construction using surface mount electronics
- Waterproof and highly resistant to vibration and shock

Application	WPS#
'70-99 Big Twin models, '71-97 XL models	<b>132-7017</b> *

\*Not legal for use in California on pollution controlled vehicles - Check local laws before installing



### IGNITION ROTOR CUP

- Includes mounting bolt and washer

Application	WPS#
Ignition Rotor Cup OE#32402-83	<b>132-7064</b>

- WINDSHIELDS / FAIRINGS
- AUDIO / COMMUNICATION
- SEATS / LUGGAGE
- BARS / MIRRORS / CONTROLS
- EXHAUST
- AIR / FUEL SYSTEMS
- ENGINE
- TRANSMISSION / DRIVELINE
- GASKETS / SEALS
- ELECTRICAL**
- LIGHTING
- CABLES
- BRAKES
- OIL FILTERS
- SUSPENSION
- BODY
- WHEELS
- TIRES / TIRE ACC.
- BIKE ACC.
- VICTORY / INDIAN
- COVERS / LOCKS / TIEDOWNS
- CHEMICALS
- TOOLS
- HELMETS
- HELMET ACC.
- EYEWEAR
- APPAREL / RIDER ACC.
- PROMOTIONAL
- REFERENCE
- INDEX

WINDSHIELDS / FAIRINGS  
 AUDIO / COMMUNICATION  
 SEATS / LUGGAGE  
 BARS / MIRRORS / CONTROLS  
 EXHAUST  
 AIR / FUEL SYSTEMS  
 ENGINE  
 TRANSMISSION / DRIVELINE  
 GASKETS / SEALS  
**ELECTRICAL**  
 LIGHTING  
 CABLES  
 BRAKES  
 OIL FILTERS  
 SUSPENSION  
 BODY  
 WHEELS  
 TIRES / TIRE ACC.  
 BIKE ACC.  
 VICTORY / INDIAN  
 COVERS / LOCKS / TIEDOWNS  
 CHEMICALS  
 TOOLS  
 HELMETS  
 HELMET ACC.  
 EYEWEAR  
 APPAREL / RIDER ACC.  
 PROMOTIONAL  
 REFERENCE  
 INDEX



## IGNITION POWER RELAY KIT

- Recommended when converting high compression and large displacement engines to single fire
- Hard start assist
- Improves or eliminates the voltage drop



Description	WPS#
Ignition Power Relay Kit	<b>132-7018</b>

## HIGH OUTPUT IGNITION COILS

- Designed for aftermarket and OE ignitions
- Fuel injected and Carbureted applications
- Daytona Twin Tec ignition coils exceed OE specifications
- **Not legal for use in California on pollution controlled vehicles - Check local laws before installing**



	Application	WPS#
A	'70-99 Carbureted Evo and '71-97 Carbureted Sportster models ARB E.O. No. D-641-2	<b>132-7019</b>
B	'99-06 Carbureted Big Twin and '04-06 Carbureted Sportster models	<b>132-7020</b>
C	'01-07 Twin Cam models with Delphi system (except 2006 Dyna)	<b>132-7021</b>



## MINI IGNITION COIL

- 3 ohm mini coils are 50 states street legal
- Do not use the 3 ohm mini coils for any breaker points, Dyna-S series, Harley-Davidson Twin Cam applications or for any Japanese/European motorcycles with CDI type ignition requiring low resistance coils.



	Application	WPS#
	'84-99 Evo Big Twin models, '86-93 XLH 883 and '86-87 XLH 1100	<b>132-7040</b>
	Coil Kit (includes two coils and universal spark plug wire set)	<b>132-7038</b>

## ACCEL SUPER COILS



- The standard by which other coils are measured
- Faster rise times, higher voltage, and maximum spark energy to the plug
- Delivers up to 45% more voltage than OE coils
- Available for both electronic and points triggered ignitions
- Designed to fit in stock locations and under most coil covers
- Covered by ACCEL's famous limited Lifetime Replacement Warranty
- **Not legal for use in California on pollution controlled vehicles - Check local laws before installing**



A



B



C



D



E



F

Model	Year	Ignition Type	Primary Resistance	Color	WPS#	
<b>SINGLE FIRE SUPER COILS</b>						
A	All except Twin Cam	'36-06	Single Fire	3.0 Ohms	Yellow	<b>274-0057</b>
B					Black	<b>274-0058</b>
<b>DUAL FIRE SUPER COILS</b>						
	All	'65-79	Points Type	4.7 Ohms	Yellow	<b>274-0053</b>
C					Black	<b>274-0054</b>
D	All	'80-98	Electronic	2.3 Ohms	Yellow	<b>274-0055</b>
					Black	<b>274-0056</b>
<b>POWER PULSE COILS</b>						
E	All 12 Volt	'65-79	Points	4.2 Ohms	Yellow	<b>274-0051</b>
					Black	<b>274-0052</b>
F	All Big Twin	'84-99	Electronic	3.0 Ohms	Black	<b>274-0050</b>
	Sportster	'85-03	Electronic	3.0 Ohms	Black	<b>274-0050</b>

WINDSHIELDS / FAIRINGS

AUDIO / COMMUNICATION

SEATS / LUGGAGE

BARS / MIRRORS / CONTROLS

EXHAUST

AIR / FUEL SYSTEMS

ENGINE

TRANSMISSION / DRIVELINE

GASKETS / SEALS

ELECTRICAL

LIGHTING

CABLES

BRAKES

OIL FILTERS

SUSPENSION

BODY

WHEELS

TIRES / TIRE ACC.

BIKE ACC.

VICTORY / INDIAN

COVERS / LOCKS / TIEDOWNS

CHEMICALS

TOOLS

HELMETS

HELMET ACC.

EYEWEAR

APPAREL / RIDER ACC.

PROMOTIONAL

REFERENCE

INDEX



## STEALTH SUPERCOILS

The all new ACCEL Stealth SuperCoil is the hottest looking and best performing ignition coil on the market. The ACCEL Stealth SuperCoil eliminates the need for ignition wires forever by mounting the coil directly to the spark plug. A beautiful cast aluminum cover holds the coil in place and acts as a functional heat sink to pull heat away from the cylinder head. All wiring is hidden in the fins of the head for a clean and custom look. Like all of our SuperCoils, the Stealth SuperCoils are covered by ACCEL's famous limited lifetime warranty.

### Features

- Mounts the coil directly to the spark plug
- Custom, clean, wireless appearance
- Proven automotive technology for your air cooled Twin Cam
- Maximum spark energy to the plugs
- Limited Lifetime Warranty



274-0061

Application	Black	Natural
All fuel injected Touring models '02-08	<b>274-0061</b>	<b>274-0062</b>
All Touring models '09-16	<b>274-0063</b>	<b>274-0064</b>
All fuel injected Softail models '01-17	<b>274-0063</b>	<b>274-0064</b>
All Dyna models '06-17	<b>274-0063</b>	<b>274-0064</b>



274-0062



274-0063



274-0064



- WINDSHIELDS / FAIRINGS
- AUDIO / COMMUNICATION
- SEATS / LUGGAGE
- BAR / MIRRORS / CONTROLS
- EXHAUST
- AIR / FUEL SYSTEMS
- ENGINE
- TRANSMISSION / DRIVELINE
- GASKETS / SEALS
- ELECTRICAL**
- LIGHTING
- CABLES
- BRAKES
- OIL FILTERS
- SUSPENSION
- BODY
- WHEELS
- TIRES / TIRE ACC.
- BIKE ACC.
- VICTORY / INDIAN
- COVERS / LOCKS / TIEDOWNS
- CHEMICALS
- TOOLS
- HELMETS
- HELMET ACC.
- EYEWEAR
- APPAREL / RIDER ACC.
- PROMOTIONAL
- REFERENCE
- INDEX





## PERFORMANCE POINTS AND CONDENSERS



A



B



C

- Built using premium quality materials for long life
- 23 oz points are suitable for OE replacement in stock applications
- 32 oz high performance points eliminate points bounce and float
- High capacitance condensers are designed to provide extended point life

Year	Model	OEM#	WPS#
<b>POINT SETS</b>			
A '70-E78	FL, FLH, FL, XL, XLCH	23 oz	32661-70 <b>274-0040</b>
B '70-E78	FL, FLH, FL, XL, XLCH	32 oz	32661-70 <b>274-0041</b>
<b>CONDENSERS</b>			
C '41-E78	All		32726-30A <b>274-0042</b>



A



B

## PERFORMANCE TUNE-UP KITS

- Performance 32 oz points and premium quality condenser in one kit
- Designed for peak ignition performance and reliable service

Year	Model	WPS#
'70-E78	FLH, FX	<b>274-0043</b>
A '48-69	FL, FLH	<b>274-0044</b>
'71-E78	XL	<b>274-0043</b>
B '58-69	XLCH W/MAG	<b>274-0045</b>



## POINTS & CONDENSERS



- Blue Streak® Ignition Performance Points are built from only the highest quality materials
- Each point set features an extra heavy duty construction that includes the exclusive LubriWick® for continuous lubricant application, which virtually eliminates wear on the rubbing block
- Ventilated contacts
- Copper shunts for point bounce elimination
- Positive screw type terminal

Description	Year	Model	OEM#	WPS#
Kit	'70-E78	Big Twin		<b>275-01021</b>
	'71-E78	XL		<b>275-01021</b>
Points Sets	'70-E78	Big Twin	32661-70	<b>275-01020</b>
	'71-E78	XL	32661-70	<b>275-01020</b>
Condensor	'70-E78	Big Twin	30801-47	<b>275-01023</b>
	'71-E78	XL	32726-30A	<b>275-01023</b>
	'70-E78	Big Twin	30801-47	<b>275-01022</b>
	'71-E78	XL	32726-30A	<b>275-01022</b>

WINDSHIELDS / FAIRINGS  
 AUDIO / COMMUNICATION  
 SEATS / LUGGAGE  
 BARS / MIRRORS / CONTROLS  
 EXHAUST  
 AIR / FUEL SYSTEMS  
 ENGINE  
 TRANSMISSION / DRIVELINE  
 GASKETS / SEALS  
**ELECTRICAL**  
 LIGHTING  
 CABLES  
 BRAKES  
 OIL FILTERS  
 SUSPENSION  
 BODY  
 WHEELS  
 TIRES / TIRE ACC.  
 BIKE ACC.  
 VICTORY / INDIAN  
 COVERS / LOCKS / TIEDOWNS  
 CHEMICALS  
 TOOLS  
 HELMETS  
 HELMET ACC.  
 EYEWEAR  
 APPAREL / RIDER ACC.  
 PROMOTIONAL  
 REFERENCE  
 INDEX



## CUSTOM FIT WIRE SETS READY TO INSTALL



### 300+ RACE WIRE

- 8.8mm, 150 ohms per foot
- Designed specifically for race-winning or maximum street performance
- Compatible with both factory and aftermarket electronic ignitions and points
- Delivers peak performance even at temperatures over 550 degrees
- 8mm sets available for carbureted Twin Cam applications, not recommended for EFI systems
- Available in both ready to install custom fit sets and universal kits
- Gloss black

Model	Year	300+ Black
<b>BUELL</b>		
All Models w/Carb	'99-08	<b>274-0140</b> **
<b>SOFTAIL</b>		
Softail Models w/ carb	'00-08	<b>274-0142</b> **
<b>DYNA</b>		
FXD Carb only	'99-05	<b>274-0140</b> **
<b>TOURING</b>		
FLHR	'94-98	<b>274-0141</b> **
All w/carb	'99-08	<b>274-0143</b> **

\*\*All Twin Cam kits use 8mm wire

### 8MM S/S SPIRAL CORE WIRE

- 8mm, 500 ohms per foot
- Designed specifically for Harley Twin Cam applications
- Compatible with both carbureted and fuel injected systems
- Maximum RFI protection shields sensitive electronics
- Up to 5 times more peak energy than other "performance" wires
- Available in black and yellow
- Custom fit sets are ready to install, no cutting or splicing required

Model	Year	8.0 S/S Yellow	8.0 S/S Black	8.0 S/S Blue	8.0 S/S Red
<b>BUELL</b>					
All Models	'99-08	<b>274-0130</b>	<b>274-0131</b>	<b>274-0144</b>	<b>274-0145</b>
<b>SPORTSTER</b>					
XL Models	'04-06	<b>274-0132</b>	<b>274-0133</b>	<b>274-0146</b>	<b>274-0147</b>
XL Models	'07-18	<b>274-0134</b>	<b>274-0135</b>	<b>274-0152</b>	<b>274-0153</b>
<b>SOFTAIL</b>					
Softail Models w/ carb or FI	'00-17	<b>274-0138</b>	<b>274-0139</b>	<b>274-0148</b>	<b>274-0149</b>
<b>DYNA</b>					
FXD, FLD Carb or FI	'99-17	<b>274-0130</b>	<b>274-0131</b>	<b>274-0144</b>	<b>274-0145</b>
<b>TOURING</b>					
All w/carb or FI	'99-08	<b>274-0132</b>	<b>274-0133</b>	<b>274-0146</b>	<b>274-0147</b>
All Models	'09-16	<b>274-0136</b>	<b>274-0137</b>	<b>274-0150</b>	<b>274-0151</b>

### 8.8MM SUPPRESSION CORE AND STAINLESS CORE WIRE

- 8.8mm, Yellow or Black
- Designed for high performance street or racetrack use
- Stainless steel terminals with premium quality silicone boots
- Suppression core features maximum RFI protection for electronic ignitions
- Use stainless core wire with points or magneto ignitions only
- Available in both ready to install custom fit sets and universal kits

Model	Year	8.8 Yellow	8.8 Black
<b>SPORTSTER</b>			
XL, XLCH (with Magneto)	'58-69	<b>274-0111</b> *	<b>274-0112</b> *
XLH, XLCH	'71-E78	<b>274-0109</b> *	<b>274-0110</b> *
XL, XLCH, XLX	'79-85	<b>274-0105</b> *	<b>274-0106</b> *
XLS	'79-82	<b>274-0105</b> *	<b>274-0106</b> *
XL Models	'86-06	<b>274-0117</b>	<b>274-0118</b>
<b>SOFTAIL</b>			
Softail Models	'84-90	<b>274-0105</b> *	<b>274-0106</b> *
Softail Models	'91-99	<b>274-0119</b>	<b>274-0120</b>
<b>DYNA</b>			
FX, FXE	'71-E78	<b>274-0107</b> *	<b>274-0108</b> *
FX, FXE-80, FXS	'78-84	<b>274-0103</b>	<b>274-0104</b>
FXR, FXRS, FXRT	'82-94	<b>274-0113</b>	<b>274-0114</b>
FXWG	'83-84	<b>274-0103</b>	<b>274-0104</b>
FXEF, FXSB	'85	<b>274-0105</b>	<b>274-0106</b>
FXWG	'85-86	<b>274-0105</b>	<b>274-0106</b>
<b>TOURING</b>			
FL, FLH	'65-E78	<b>274-0107</b> *	<b>274-0108</b> *
FLH	'78-84	<b>274-0103</b>	<b>274-0104</b>
FLT, FLHT, FLHTC, FLTC	'80-84	<b>274-0115</b>	<b>274-0116</b>
FLT, FLHT Models	'85-98	<b>274-0121</b>	<b>274-0122</b>

\* Stainless Steel Core-Not for Electronic Ignition Use



### 8.8MM UNIVERSAL WIRE SETS

- Premium quality ACCEL 8.8mm ignition wire in universal kits
- Available for 2 and 4 plug applications for electronic and points type ignitions
- Pre terminated with either a 90 deg or variangle heavy duty spark plug boots
- 2 plug kits contain one 42" wire, brass terminals, coil boots and instructions
- 4 plug kits contain two 42" wires, brass terminals, coil boots and instructions
- The ultimate in performance and reliability for street and racing use



Number of Spark Plugs	Plug Boot	8.8mm Yellow	8.8mm Black	8.8mm Yellow
2	Variangle	274-0128	274-0129	274-0101 *
2	90 deg	274-0125	274-0126	274-0102 *
4	Variangle		274-0127	274-0100 *
4	90 deg	274-0123	274-0124	

\* Copper core for points/magneto ignitions only

- WINDSHIELDS / FAIRINGS
- AUDIO / COMMUNICATION
- SEATS / LUGGAGE
- BAR / MIRRORS / CONTROLS
- EXHAUST
- AIR / FUEL SYSTEMS
- ENGINE
- TRANSMISSION / DRIVELINE
- GASKETS / SEALS
- ELECTRICAL**
- LIGHTING
- CABLES
- BRAKES
- OIL FILTERS
- SUSPENSION
- BODY
- WHEELS
- TIRES / TIRE ACC.
- BIKE ACC.
- VICTORY / INDIAN
- COVERS / LOCKS / TIEDOWNS
- CHEMICALS
- TOOLS
- HELMETS
- HELMET ACC.
- EYEWEAR
- APPAREL / RIDER ACC.
- PROMOTIONAL
- REFERENCE
- INDEX



## HIGH PERFORMANCE IGNITION WIRE

All Moroso spark plug wires feature silicone plug boots that withstand high temperatures (up to 600°), and have a silicone jacket to reduce heat and chafing. Locking stainless steel terminals that stay connected under high vibration and are fully compatible with the Harley-Davidson® ION sensing coils used on virtually all late model bikes. Moroso High Performance Ignition wire combines state of the art engineering with the Finest "Made In the USA" workmanship and the very highest standards of quality control available.

### Suppression

- Nylon Pull Tape provides unbeatable pull strength and terminal retention.
- Glass center Core offers high tensile strength
- 8mm Silicone Jacket
- Extra Thick EPDM Layer of Insulation provides greater dielectric strength
- Locking Stainless Steel Plug Terminals
- High-temperature silicone boots that can withstand heat up to 600 degrees



### Spiral Core

- Nylon Pull Tape provides unbeatable pull strength and terminal retention.
- Stainless steel alloy conductor greatly improves spark energy
- 8mm Silicone Jacket
- Extra Thick EPDM Layer of Insulation provides greater dielectric strength
- KEVLAR® core that's four times stronger than Aramid cores
- Locking Stainless Steel Plug Terminals
- High-temperature silicone boots that can withstand heat up to 600 degrees
- Ferrite Impregnated Core tunes EMI Suppression characteristics



### Ultra 40

- 8.65mm diameter, 40 ohms per foot resistance
- Features of these 8.65mm wires include:
- 100% Compatible with HD's ION Sense Ignition Coils
- KEVLAR® core that's four times stronger than Aramid cores
- Class-leading 40 ohms of resistance per foot
- Nickel copper alloy conductors for superior spark energy transfer
- Extra-thick EPDM layer for greater dielectric strength
- High-temperature silicone boots that can withstand heat up to 600 degrees
- Locking stainless steel plug terminals



Application	Year	Suppression	Spiral	Ultra 40	Ultra 40 RED
<b>TOURING</b>					
All models	'17-Up		<b>82-8288</b>	<b>82-8303</b>	<b>82-8302</b>
	'09-16		<b>82-7221</b>	<b>82-8287</b>	<b>82-8291</b>
	'99-08	<b>82-7165</b>	<b>82-7216</b>	<b>82-8286</b>	<b>82-8290</b>
	'97-98	<b>82-7164</b>	<b>82-7215</b>	<b>82-8326</b>	<b>82-8296</b>
	'85-96	<b>82-7161</b>	<b>82-7212</b>	<b>82-8323</b>	
FL	'80-84	<b>82-7160</b>	<b>82-7211</b>	<b>82-8322</b>	<b>82-8293</b>
<b>SOFTAIL</b>					
All models	'00-17	<b>82-7168</b>	<b>82-7219</b>	<b>82-8329</b>	<b>82-8299</b>
	'84-99	<b>82-7160</b>	<b>82-7211</b>	<b>82-8322</b>	
<b>DYNA/FXR</b>					
All models	'99-17	<b>82-7166</b>	<b>82-7217</b>	<b>82-8327</b>	<b>82-8297</b>
	'91-98	<b>82-7160</b>	<b>82-7211</b>	<b>82-8322</b>	
FXR	'82-99	<b>82-7162</b>	<b>82-7213</b>	<b>82-8324</b>	<b>82-8294</b>
<b>SPORTSTER</b>					
All models	'07-17	<b>82-7282</b>	<b>82-7287</b>	<b>82-8331</b>	<b>82-8301</b>
	'04-06	<b>82-7169</b>	<b>82-7220</b>	<b>82-8330</b>	<b>82-8300</b>
	'86-03	<b>82-7163</b>	<b>82-7214</b>	<b>82-8325</b>	<b>82-8295</b>
XL1200S	'98-03	<b>82-7167</b>	<b>82-7218</b>	<b>82-8328</b>	<b>82-8298</b>
	'71-78	<b>82-7284</b>			
XLCH	'58-69	<b>82-7285</b>			
<b>SHOVELHEAD</b>					
All models	'65-78	<b>82-7283</b>			
Universal Kit	'78-17	<b>82-7286</b>	<b>82-7288</b>	<b>82-8332</b>	<b>82-8292</b>



## RACING CABLE

Designed to deliver maximum spark energy for today's extreme performance applications.



- High performance RED SILICONE outer shell for maximum heat resistance and durability
- High quality ceramic resistor (5k ohm) enhances protection against RFI (radio frequency interference) which can disrupt electronic ignition performance and lead to misfire
- Molded cap design keeps water out, giving you the confidence needed to win races
- Solid copper wire strand inner core
- Resistor covers in either straight or 90 (degree) configurations
- Fits most applications for watercraft, snowmobiles, motorcycles and karts
- In-line wire connector provides a hassle free watertight connection – sold separately

Description	WPS#
90 (degree) solid post terminal, 50 cm wire	14-1130
90 (degree) solid post terminal, 100 cm wire	2-CR6
90 (degree) threaded terminal, 50 cm wire	14-1131
90 (degree) threaded terminal, 100 cm wire	2-CR5
Straight solid post terminal, 50 cm wire	14-1132
Straight threaded terminal, 50 cm wire	14-1133
Wire connector	14-1135



## INDEXING WASHER KITS

Indexed spark plugs align the open end of the electrode toward the intake port. The hottest flame meets the new fuel charge for a performance gain, increases fuel mileage and plug life. This is a speed secret car racers have used for years. You simply

mark the electrode side of the plug with a magic marker on the porcelain. You then shim the plugs with the washers to align the electrodes toward the intake ports. **Fits 14mm threaded spark plugs.**

Application	Includes	WPS#
2 Cylinder	8 washers	14-1106
3 Cylinder	12 washers	14-1107



## LIGHTED SPARK PLUG CAPS

- Lights up to show electrical current
- Easily threads into spark plug wire

Description	Color	WPS#
See through tube spark plug cover set	Red	820-0170R
See through tube spark plug cover set	Blue	820-0170B
See through tube spark plug cover set	Clear	820-0170C



## SWIVEL PLUG WRENCH

- Swivel T-handle makes pulling plugs a breeze
- Fits both 5/8" and 13/16" plugs

Description	WPS#
180° Swivel Spark Plug Wrench	820-2570

## WRENCHES



### THREE WAY

Fits all 10mm, 12mm and 14mm spark plugs.

WPS#  
57-6023



### DOUBLE END

Fits spark plugs with 14mm or 18mm threads.

WPS#  
11-1082

- WINDSHIELDS / FAIRINGS
- AUDIO / COMMUNICATION
- SEATS / LUGGAGE
- BARS / MIRRORS / CONTROLS
- EXHAUST
- AIR / FUEL SYSTEMS
- ENGINE
- TRANSMISSION / DRIVELINE
- GASKETS / SEALS
- ELECTRICAL
- LIGHTING
- CABLES
- BRAKES
- OIL FILTERS
- SUSPENSION
- BODY
- WHEELS
- TIRES / TIRE ACC.
- BIKE ACC.
- VICTORY / INDIAN
- COVERS / LOCKS / TIEDOWNS
- CHEMICALS
- TOOLS
- HELMETS
- HELMET ACC.
- EYEWEAR
- APPAREL / RIDER ACC.
- PROMOTIONAL
- REFERENCE
- INDEX



**Sold each**

Application	Year	OEM #	Standard	Iridium	Box Qty	Gap
<b>HARLEY DAVIDSON</b>						
Evo Big Twin	'84-99	5R6A	<b>2-BPR5ES-11</b>	<b>2-BPR5EIX-11</b>	10	.040
Twin cam	'99-17	6R12	<b>2-DCPR7E</b>		10	.040
	'99-17	6R12		<b>2-DCPR7EIX</b>	4	.040
Shovel Head	'75-84		<b>2-BPR5ES-11</b>		4	.040
Shovel Head/Pan Head	'48-74		<b>2-R5670-5</b>		4	.030
KH/XL	'54-71		<b>2-B6L</b>		10	.040
XL	'71-78		<b>2-B6L</b>		10	.040
	'79-85		<b>2-BPR6HS-10</b>		10	.040
Sportster	'86-17	6R12	<b>2-DCPR7E</b>		10	.040
	'86-17	6R12		<b>2-DCPR7EIX</b>	4	.040
V-Rod	'02-17	10R12A	<b>2-DCPR8E</b>		10	.040
	'02-17	10R12A		<b>2-DCPR8EIX</b>	4	.040



**HIGH PERFORMANCE PLATINUM SPARK PLUGS**

- Made from the finest materials available to ensure long trouble free operation
- Premium quality platinum tip is more durable than other plug material
- Maintains proper gap much longer than standard plugs
- Pure copper center electrode for reduced fouling
- Enjoy easier starting, smooth idling and increased performance
- Sold in packs of 2

**HIGH PERFORMANCE U-GROOVE SPARK PLUGS**

- Patented U shaped ground electrode produces a wider, hotter spark
- Heavy duty 5 rib insulators prevent flashover
- High quality copper/nickel alloy electrode
- Highly foul resistant and dissipates heat better than any other material
- Improves engine efficiency and reduces emissions
- Increases throttle response



Application	Year	OEM #	U-Groove	Platinum	Box Qty
<b>HARLEY DAVIDSON</b>					
Evo Big Twin	'84-99	5R6A	<b>274-0162</b>	<b>274-0164</b>	2
Twin cam	'99-17	6R12	<b>274-0163</b>	<b>274-0165</b>	2
Shovel Head/Pan Head	'48-74	3	<b>274-0160</b>		2
KH/XL	'54-70	3	<b>274-0160</b>		2
Sportster	'86-17	6R12	<b>274-0163</b>	<b>274-0165</b>	2



**COPPER CORE**

- Copper-glass seal bonds insulator, terminal post center electrode together; assures full required voltage at spark gap; gas-tight seal (100% leak proof)
- Multi-rib insulator reduces danger of “flash-over”
- One-piece terminal post adds strength
- Resistor reduces radio frequency interference (RFI) and electrode erosion
- Cold-formed steel shell precision rolled threads
- Full copper core electrode provides better performance in all conditions

*All Autolite Spark Plugs sold in BOX quantities of 4*

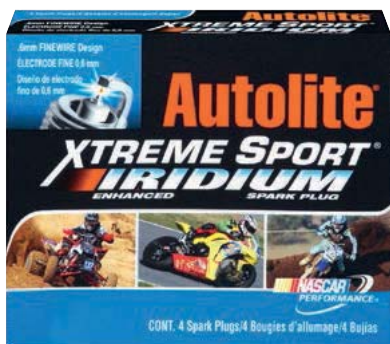

**XTREME SPORT**

- Engineered to meet or exceed OE designs and withstand the extreme operating temperatures experienced during a powersports engine's combustion
- Iridium-enhanced 0.6mm finewire design for improved ignitability, faster fuel combustion and a more focused ignition versus standard plugs
- Up to 26 percent quicker starts compared to that of standard plugs and as much as 21 percent less hydrocarbon emissions than standard plugs, which promotes better fuel efficiency and horsepower

Application	Year	OEM#	Copper Core	Xtreme Sport	NGK Cross Ref.	WPS#
<b>HARLEY DAVIDSON</b>						
Evo Big Twin	'84-99	5R6A	4265	XS65	2-BPR4ES-11	<b>4-4265</b> <b>4-XS65</b>
Twin Cam	'99-17	6R12	4164	XS4164	2-DCPR7E	<b>4-4164</b> <b>4-XS4164</b>
Shovel Head/Pan Head	'48-74		4275	XS85	2-R5670-5	<b>4-4275</b> <b>4-XS85</b>
Shovel Head	'75-81		4265	XS65	2-BPR5ES-11	<b>4-4265</b> <b>4-XS65</b>
Shovel Head	'82-83		4345	XS985	2-BPR5ES-11	<b>4-4345</b> <b>4-XS985</b>
FXE, FXSB, FXWG	'84		4345	XS985	2-BPR5ES-11	<b>4-4345</b> <b>4-XS985</b>
Sportster	'86-17	6R12	4164	XS4164	2-DCPR7E	<b>4-4164</b> <b>4-XS4164</b>
XR	'83-85			XS62		<b>4-XS62</b>
XL	'54-78		4316	XS85		<b>4-4316</b> <b>4-XS85</b>
XL	'79-85		4123			<b>4-4123</b>
V-Rod	'02-17	10R12A	4162	XS4162	2-DCPR8E	<b>4-4162</b> <b>4-XS4162</b>

Order Autolite / Fram Powersports Application Catalog free of charge – WPS# 4-4444

- WINDSHIELDS / FAIRINGS
- AUDIO / COMMUNICATION
- SEATS / LUGGAGE
- BAR / MIRRORS / CONTROLS
- EXHAUST
- AIR / FUEL SYSTEMS
- ENGINE
- TRANSMISSION / DRIVELINE
- GASKETS / SEALS
- ELECTRICAL**
- LIGHTING
- CABLES
- BRAKES
- OIL FILTERS
- SUSPENSION
- BODY
- WHEELS
- TIRES / TIRE ACC.
- BIKE ACC.
- VICTORY / INDIAN
- COVERS / LOCKS / TIEDOWNS
- CHEMICALS
- TOOLS
- HELMETS
- HELMET ACC.
- EYEWEAR
- APPAREL / RIDER ACC.
- PROMOTIONAL
- REFERENCE
- INDEX

**HardDrive**  
AMERICAN V-TWIN PRODUCTS

## WMD LITHIUM BATTERIES

- Lithium Ion Polymer technology
- All components are designed, manufactured, assembled and packed in one location assuring high quality and consistency
- Fitments for most Harley Davidson® and other V-Twin motorcycles
- Extremely lightweight, 50% to 70% lighter than standard batteries
- Heavy duty case and terminals
- Increased cranking amps over lead acid batteries
- Fast recharge, can be brought up to 90% charge in within 6 minutes
- Easily 6 to 12 times more cycle life compared to lead acid batteries
- Long shelf life, up to 1 year before requiring recharging
- Can be mounted in any position
- No hazardous acid or heavy metals, non-explosive and non-combustible
- No shipping restrictions!
- More precise fitments, foam spacers are not required!
- 2 Year warranty



**Battery Model  
Number      WPS #**

YTX20HL-BS	<b>490-2610</b>
YTX20L-BS	<b>490-2610</b>
YB30L-B	<b>490-2611</b>
Y1X30L	<b>490-2611</b>





# 12 V LITHIUM IRON BATTERIES

## SUPER SMART LITHIUM TECHNOLOGY



- 60% Lighter than Flooded or AGM lead-acid batteries
- 5 times the battery life
- 2 Year shelf life
- 2000+ cycles
- Quad Terminal Configuration can be mounted in any direction
- 3 year limited warranty

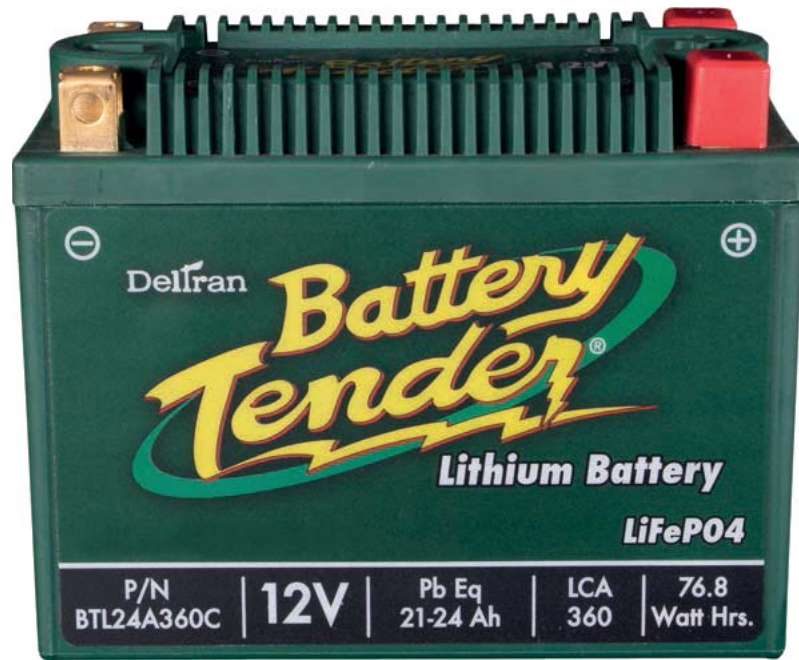

Dimensions L x W x H	Lead acid amp hour equiv.	Weight	CCA	WPS#
4.2" x 2.2" x 3.35"	7-9 Ah	1.2 lbs	120	<b>56-1173</b>
5.27" x 2.55" x 3.62"	10-14 Ah	1.76 lbs	240	<b>56-1174</b>
6.5" x 3.38" x 5.11"	21-24 Ah	2.6 lbs	360	<b>56-1176</b>
6.5" x 3.38" x 5.11"	26-36 Ah	3.75 lbs	480	<b>56-1177</b>

- WINDSHIELDS / FAIRINGS
- AUDIO / COMMUNICATION
- SEATS / LUGGAGE
- BARS / MIRRORS / CONTROLS
- EXHAUST
- AIR / FUEL SYSTEMS
- ENGINE
- TRANSMISSION / DRIVELINE
- GASKETS / SEALS
- ELECTRICAL**
- LIGHTING
- CABLES
- BRAKES
- OIL FILTERS
- SUSPENSION
- BODY
- WHEELS
- TIRES / TIRE ACC.
- BIKE ACC.
- VICTORY / INDIAN
- COVERS / LOCKS / TIEDOWNS
- CHEMICALS
- TOOLS
- HELMETS
- HELMET ACC.
- EYEWEAR
- APPAREL / RIDER ACC.
- PROMOTIONAL
- REFERENCE
- INDEX



## FEATHERWEIGHT LITHIUM BATTERIES

- Lithium Ion Polymer technology
- All components are designed, manufactured, assembled and packed in one location assuring high quality and consistency
- Extremely lightweight, 50% to 70% lighter than standard batteries
- Built-in LED test gauge
- Increased cranking amps over lead acid batteries
- Fast recharge, can be brought up to a 90% charge within 6 minutes
- Easily 6 to 12 times more cycle life compared to lead acid batteries
- Long shelf life, up to 1 year before requiring recharging
- Can be mounted in any position
- No hazardous acid or heavy metals, non-explosive and non-combustible
- More precise fitments compared to other brands of lithium batteries
- 2 Year warranty
- No ground shipping restrictions to the lower 48 states.
- Carrier shipping restrictions to AK, HI and PR.



Battery Model Number	WPS #
12N4-3B	490-2503
12N5-3B	490-2503
12N5-4B	490-2502
12N5.5-3B	490-2503
12N5.5-4A	490-2502
12N7-3B	490-2527
12N7-4A	490-2527
12N7-4B	490-2527
12N7A-3A	490-2503
12N7A-4B	490-2502
12N7CZ-3D	490-2503
12N7D-3B	490-2527
12N9-3A	490-2527
12N9-3B	490-2527
12N9-4B-1	490-2527
12N10-3A-2	490-2524
12N11-3A-1	490-2524
12N12A-4A-1	490-2524
12N14-3A	490-2524
GYZ16H	490-2518
GYZ20H	490-2525
GYZ20HL	490-2525
GYZ20L	490-2525
HG-18-12	490-2522
HVT-1	490-2525
HVT-2	490-2523
HVT-3	490-2524

Battery Model Number	WPS #
HVT-4	490-2525
HVT-5	490-2525
HVT-6	490-2525
HVT-7	490-2523
HVT-8	490-2516
HYB16A-AB	490-2518
KMX14-BS	490-2516
SY50-N18L-AT	490-2525
SYB14L-A2	490-2524
SYB14L-B2	490-2524
SYB16L-B	490-2525
Y50-N18A-A	490-2525
Y50-N18L-A	490-2525
Y50-N18L-A2	490-2525
Y50-N18L-A3	490-2525
Y50-N18L-A-CX	490-2525
Y60-N24-A	490-2523
Y60-N24AL-B	490-2523
YB4L-A	490-2503
YB4L-B	490-2503
YB5L-B	490-2503
YB7-A	490-2527
YB7B-B	490-2502
YB7C-A	490-2503
YB7L-B	490-2528
YB9A-A	490-2527
YB9-B	490-2527

Battery Model Number	WPS #
YB9L-A2	490-2528
YB9L-B	490-2528
YB10A-A2	490-2524
YB10L-A2	490-2524
YB10L-B	490-2524
YB10L-B2	490-2524
YB10L-BP	490-2524
YB12A-A	490-2524
YB12A-B	490-2524
YB12AL-A	490-2524
YB12AL-A2	490-2524
YB12B-B2	490-2516
YB12C-A	490-2524
YB14-A2	490-2524
YB14A-A1	490-2524
YB14A-A2	490-2524
YB14-B2	490-2524
YB14L-A1	490-2524
YB14L-A2	490-2524
YB14L-B2	490-2524
YB16-B	490-2525
YB16B-A	490-2518
YB16B-A1	490-2518
YB16-B-CX	490-2525
YB16C-B	490-2525
YB16CL-B	490-2525
YB16HL-A-CX	490-2525



## FEATHERWEIGHT LITHIUM BATTERIES



Battery Model Number	WPS #	Battery Model Number	WPS #
YB16L-A2	490-2525	YTX14-BS	490-2516
YB16L-B	490-2525	YTX14H-BS	490-2516
YB18-A	490-2525	YTX14L-BS	490-2524
YB18L-A	490-2525	YTX15L-BS	490-2525
YB18L-A2	490-2525	YTX16-BS	490-2518
YB30CL-B ‡	490-2523	YTX16-BS-1	490-2518
YB30L-B ‡	490-2523	YTX18L-BS	490-2525
YHD-12H ‡	490-2523	YTX20-BS	490-2525
YIX30L ‡	490-2523	YTX20CH-BS	490-2518
YIX30L-BS ‡	490-2523	YTX20H-BS	490-2525
YT4L-BS	490-2500	YTX20HL-BS †	490-2525
YT4L-BS *	490-2501	YTX20L-BS †	490-2525
YT7B-BS	490-2507	YTX24HL-BS	490-2525
YT9B-BS	490-2507	YTZ5S	490-2500
YT12A-BS	490-2516	YTZ5S *	490-2528
YT12B-BS	490-2530	YTZ7S	490-2528
YTR9-BS	490-2508	YTZ7S *	490-2529
YTX4L-BS	490-2500	YTZ8V	490-2528
YTX4L-BS *	490-2501	YTZ8V *	490-2529
YTX5L-BS	490-2500	YTZ10S	490-2509
YTX5L-BS *	490-2501	YTZ12S	490-2517
YTX7A-BS	490-2504	YTZ14S	490-2517
YTX7L-BS	490-2501	51814	490-2522
YTX7L-BS *	490-2528	51913	490-2522
YTX9-BS	490-2508	52015	490-2522
YTX12-BS	490-2516	52515	490-2523
YTX12A-BS	490-2516	53030	490-2523
YTX14AH-BS	490-2524	53034	490-2523
YTX14AHL-BS	490-2524	KTM # 79011053000	490-2526

Higher CCA rating

For Harley models use 490-2610 HardDrive battery, [EE PA E 560](#)

For Harley models use 490-2611 HardDrive battery, [EE PA E 560](#)

## FEATHERWEIGHT LITHIUM BATTERIES SPECIFICATION CHART

WPS#	Dimensions L x W x H	C.C.A.	Post Position	Approx. weight lbs.	Waterproof
490-2500	4 7/16" x 2 3/4" x 3 3/8"	120	+ Right	0.9	Yes
490-2501	4 7/16" x 2 3/4" x 3 3/8"	150	+ Right	1.3	Yes
490-2502	4 3/4" x 2 3/8" x 3 5/8"	120	+ Left	1.1	Yes
490-2503	4 3/4" x 2 3/8" x 3 5/8"	120	+ Right	1.1	Yes
490-2504	6" x 3 7/16" x 3 11/16"	130	+ Left	1.3	Yes
490-2507	6" x 2 9/16" x 3 5/8"	190	+ Left	1.5	Yes
490-2508	6" x 3 7/16" x 4 3/8"	180	+ Left	1.5	Yes
490-2509	6" x 3 7/16" x 3 11/16"	230	+ Left	2.0	Yes
490-2516	6" x 3 7/16" x 4 1/8"	240	+ Left	2.0	Yes
490-2517	6" x 3 7/16" x 3 11/16"	310	+ Left	2.4	Yes
490-2518	6" x 3 7/16" x 4 1/8"	360	+ Left	3.1	Yes
490-2522	7 3/16" x 3 1/16" x 6 11/16"	450	+ Right	3.7	Yes
490-2523	6 9/16" x 4 7/8" x 6 7/16"	500	+ Left/Right Quad Terminal	4.4	Yes
490-2524	5 5/16" x 3" x 5 1/4"	250	+ Left/Right Quad Terminal	2.0	Yes
490-2525	6 7/8" x 3 7/16" x 5 1/8"	380	+ Left/Right Quad Terminal	3.7	Yes
490-2526	3 9/16" x 2" x 3 1/2"	130	+ Right	.95	Yes
490-2527	5 5/16" x 3" x 5 1/4"	150	+ Left/Right Quad Terminal	1.5	Yes
490-2528	4 7/16" x 2 3/4" x 3 3/8"	180	+ Right	1.5	Yes
490-2529	4 7/16" x 2 3/4" x 4 1/8"	240	+ Right	2.2	Yes
490-2530	5 15/16" x 2 9/16" x 5 1/8"	310	+ Left	2.5	Yes

WINDSHIELDS / FAIRINGS

AUDIO / COMMUNICATION

SEATS / LUGGAGE

BARS / MIRRORS / CONTROLS

EXHAUST

AIR / FUEL SYSTEMS

ENGINE

TRANSMISSION / DRIVELINE

GASKETS / SEALS

ELECTRICAL

LIGHTING

CABLES

BRAKES

OIL FILTERS

SUSPENSION

BODY

WHEELS

TIRES / TIRE ACC.

BIKE ACC.

VICTORY / INDIAN

COVERS / LOCKS / TIEDOWNS

CHEMICALS

TOOLS

HELMETS

HELMET ACC.

EYEWEAR

APPAREL / RIDER ACC.

PROMOTIONAL

REFERENCE

INDEX



**1 yr Warranty  
On All Fire  
Power Brand  
Batteries!**

## CONVENTIONAL 6 AND 12 VOLT BATTERY KITS

- Meets or exceeds EM specifications
- Extremely strong polypropylene cases to withstand impacts and vibration
- 1 year warranty on all batteries if properly pre-serviced and charged
- Anti-sulfate treated for longer life
- Shelf-life almost infinite due to dry-charged plates
- Designed for higher cold cranking AMP capacity
- Comes with pre-measured acid pack



## MAINTENANCE FREE 12 VOLT BATTERIES

- Absorbed Glass Mat (AGM) technology
- Sealed impact resistant polypropylene case
- A must for motorcycles and ATVs that require a sealed battery
- Must be mounted in upright position
- Comes with pre-measured acid pack



## SEALED FACTORY ACTIVATED BATTERIES

- Advanced Absorbed Glass Mat (AGM) technology
- Sealed maintenance free design
- 1 Year free replacement warranty
- Battery comes filled and pre-charged from the manufacturer - freshening charge recommended before installation





# PREMIUM FACTORY ACTIVATED BATTERIES



Freshening charge is recommended prior to installation.

- Higher CCA rating compared to same series standard factory activated batteries
- Non- spillable design
- A M separators
- Heavy duty terminals
- Made in the A
- 1 Year warranty

Battery Model Number	WPS#
YTX16L/YTX16HL	490-2658
YTX20/YTX20H	490-2656
YTX20L/YTX20HL	490-2657
YIX30L	490-2655

## FACTORY ACTIVATED SEALED BATTERIES

- Designed for American - win motorcycles
- Heavy duty brass terminals
- Activated and sealed at the factory freshening charge is recommended prior to installation
- Calcium alloy technology Improves cranking power and helps give the battery longer life
- alve regulated lead acid design ealed Non- spillable design eliminates leakage
- afety valve ame arrestor afely regulates internal pressure
- ight-pack absorbed glass mat separators Absorbs acid reduces damage due to vibration
- pill-proof sealed battery onically sealed cover allows for angled battery mounting if needed for more mounting options

Battery Model Number	WPS#
YTX14L	490-2653
YB16L-B/YB16CL-B	490-2654
YTX20L/YTX20HL	490-2651
YIX30L/YB30L-B	490-2652



- WINDSHIELDS / FAIRINGS
- AUDIO / COMMUNICATION
- SEATS / LUGGAGE
- BARS / MIRRORS / CONTROLS
- EXHAUST
- AIR / FUEL SYSTEMS
- ENGINE
- TRANSMISSION / DRIVELINE
- GASKETS / SEALS
- ELECTRICAL**
- LIGHTING
- CABLES
- BRAKES
- OIL FILTERS
- SUSPENSION
- BODY
- WHEELS
- TIRES / TIRE ACC.
- BIKE ACC.
- VICTORY / INDIAN
- COVERS / LOCKS / TIEDOWNS
- CHEMICALS
- TOOLS
- HELMETS
- HELMET ACC.
- EYEWEAR
- APPAREL / RIDER ACC.
- PROMOTIONAL
- REFERENCE
- INDEX

# YUASA BATTERY

## GYZ SEALED

- Highest CCA rating compared to the same series lead acid batteries
- AGM separators, Non-Spillable design
- Heavy duty flush terminals
- 1 year warranty
- **Factory filled and sealed**

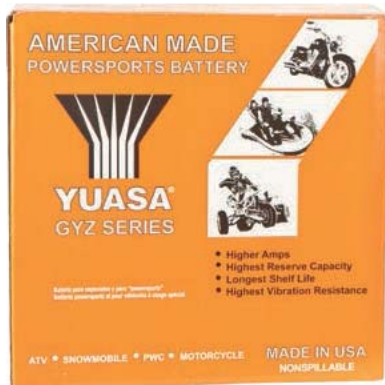

## GRT SEALED

- Once filled and permanently sealed "Install it and forget it"
- Easily meets or exceeds all OEM requirements
- Will hold a specific gravity 3 times longer than a conventional battery
- Contains sulfate stop to retard sulfation on plates
- 1 year warranty
- **Comes with pre-measured acid pack**



## YTZ MAINTENANCE FREE

- 12 Month Warranty
- Longer life than conventional batteries
- Spill-proof design
- No additional hazardous shipping fees
- Discharges less in storage for longer life
- 1 year warranty
- **Factory filled and sealed**



## YUMICRON

- 30% more cranking power than conventional batteries
- Heavy duty polypropylene case and cover heat sealed together
- Patented sealed posts
- Contains sulfate stop to retard sulfation on plates
- 1 year warranty
- **Must purchase acid pack separately**



ELECTRICAL

LIGHTING

CABLES

BRAKES

OIL FILTERS

SUSPENSION

BODY

WHEELS

TIRES / TIRE ACC.

BIKE ACC.

VICTORY / INDIAN

COVERS / LOCKS / TIEDOWNS

CHEMICALS

TOOLS

HELMETS

HELMET ACC.

EYEWEAR

APPAREL / RIDER ACC.

PROMOTIONAL

REFERENCE

INDEX



**BATTERY CROSS REFERENCE CHART** YUASA BATTERY

Battery	Dimensions L" x W" x H"	Fire Power			YUASA	
		Standard w/acid pack	Maintenance Free AGM @	Factory Activated Sealed AGM	Standard no acid pack	GRT/GYZ AGM Sealed & *CX non-sealed Heavy Duty
<b>6 VOLT</b>						
6N11A-1B	4 13/16 x 2 7/16 x 5 1/8	<b>490-2062</b>				
<b>12 VOLT</b>						
12N7-3B	5 5/16 x 3 x 5 1/4				<b>49-1718</b>	
12N7-4A	5 5/16 x 3 x 5 1/4				<b>49-1720</b>	
Y50-N18L-A	8 1/8 x 3 9/16 x 6 3/8	<b>490-2250</b>		<b>49-2240</b>	<b>49-1905</b>	<b>49-1906 *</b>
YB14L-A2	5 5/16 x 3 1/2 x 6 9/16	<b>490-2216</b>		<b>49-2241</b>	<b>49-1868</b>	<b>49-1963</b>
YB16-B	6 7/8 x 4 x 6 1/8	<b>490-2228</b>	<b>49-2297</b>		<b>49-1880</b>	<b>49-1881 *</b>
YB16CLB-B	6 7/8 x 4 x 6 7/8			<b>49-2253</b> <b>490-2654 ‡</b>		
YB16HL-A-CX	6 7/8 x 4 x 6 1/8		<b>49-2296</b>			<b>49-1891 *</b>
YTX16CLB-BS	6 7/8 x 4 x 6 7/8		<b>49-2289</b>	<b>49-2253</b> <b>490-2654 ‡</b>		
YB30L-B	6 5/8 x 5 3/16 x 6 15/16			<b>49-2275</b> <b>490-2652 ‡</b>	<b>49-1899</b>	<b>49-1976</b>
YHD-12	8 1/8 x 5 1/4 x 6 1/2	<b>490-2128</b>				
YIX30L	6 9/16 x 5 x 6 7/8		<b>49-1211</b>	<b>49-2275</b> <b>490-2652 ‡</b>		<b>49-1976</b>
YIX30L-BS	6 9/16 x 5 x 6 7/8					<b>49-1984</b>
GYZ32HL (Heavy Duty YIX30L)				<b>490-2655 ‡</b>		<b>49-1938</b>
YTX14-BS	6 x 3 7/16 x 5 3/4		<b>49-2271</b>	<b>49-2248</b>		<b>49-1964</b>
YTX14L-BS	6 x 3 7/16 x 5 3/4		<b>49-2272</b>	<b>49-2254</b> <b>490-2653 ‡</b> <b>490-2658 ‡</b>		<b>49-1979</b>
GYZ16H (Heavy Duty YTX14)	6 x 3 7/16 x 5 3/4					<b>49-1935</b>
GYZ16HL (Heavy Duty YTX14L)	6 x 3 7/16 x 5 3/4					<b>49-1936</b>
YTX19-BS	6 7/8 x 3 15/16 x 6 3/16		<b>49-2297</b>			
YTX19L-BS	6 7/8 x 3 15/16 x 6 3/16		<b>49-2296</b>			
YTX20-BS	6 7/8 x 3 7/16 x 6 1/8		<b>49-2279</b>			<b>49-1969</b>
YTX20H-BS	6 7/8 x 3 7/16 x 6 1/8		<b>49-2300</b>			<b>49-1973</b>
YTX20HL-BS	6 7/8 x 3 7/16 x 6 1/8		<b>49-2301</b>	<b>49-2252</b> <b>490-2651 ‡</b>		<b>49-1972</b>
YTX20L-BS	6 7/8 x 3 7/16 x 6 1/8		<b>49-2273</b>	<b>49-2252</b> <b>490-2651 ‡</b>		<b>49-1968</b>
GYZ20H (Heavy Duty YTX20H)	6 7/8 x 3 7/16 x 6 1/8			<b>490-2656 ‡</b>		<b>49-1937</b>
GYZ20HL (Heavy Duty YTX20HL)	6 7/8 x 3 7/16 x 6 1/8			<b>490-2657 ‡</b>		<b>49-1958</b>
YTX24HL-BS	8 1/8 x 3 7/16 x 6 3/8		<b>49-2291</b>			<b>49-1989</b>
HardDrive brand battery						
@ Must be mounted in upright position						

\* Calcium Plate (CX) Technology - not sealed type

WINDSHIELDS / FAIRINGS  
AUDIO / COMMUNICATION  
SEATS / LUGGAGE  
BARS / MIRRORS / CONTROLS  
EXHAUST  
AIR / FUEL SYSTEMS  
ENGINE  
TRANSMISSION / DRIVELINE  
GASKETS / SEALS  
**ELECTRICAL**  
LIGHTING  
CABLES  
BRAKES  
OIL FILTERS  
SUSPENSION  
BODY  
WHEELS  
TIRES / TIRE ACC.  
BIKE ACC.  
VICTORY / INDIAN  
COVERS / LOCKS / TIEDOWNS  
CHEMICALS  
TOOLS  
HELMETS  
HELMET ACC.  
EYEWEAR  
APPAREL / RIDER ACC.  
PROMOTIONAL  
REFERENCE  
INDEX



# BATTERY APPLICATION CHART



CC	Application	Year	Battery	HardDrive		Fire Power			YUASA		
				Premium Factory Activated Sealed AGM	Factory Activated Sealed AGM	Standard w/ acid pack	Maintenance Free AGM @	Factory Activated Sealed AGM	Standard no acid pack	GRT Sealed AGM & *CX non-sealed Heavy Duty	GYZ Sealed AGM
<b>TOURING</b>											
	All models	'07-18	Y1X30L	490-2655	490-2652		49-1211	49-2275		49-1976	49-1938
		'97-06	YB30L-B	490-2655	490-2652	490-2245	49-1211	49-2275	49-1899	49-1976	49-1938
		'80-96	Y50-N18L-A			490-2250		49-2240	49-1905	49-1906 *	
		'65-84	YHD-12			490-2128			49-1774		
<b>SOFTAIL</b>											
	All models	'97-17	YTX20L-BS	490-2657	490-2651		49-2273	49-2252		49-1968	
		'91-96	YB16HL-A-CX	490-2657	490-2651		49-2296	490-2654		49-1891 *	
		'84-90	YB16-B	490-2656		490-2228	49-2297		49-1880	49-1881 *	
<b>DYNA, FXR &amp; FX</b>											
	All models	'97-17	YTX20L-BS	490-2657	490-2651		49-2273	49-2252		49-1968	
	FXD Dyna-Glide	'91-96	YB16HL-A-CX	490-2657	490-2654		49-2296			49-1891 *	
	FXR Series	'84-94	YB16-B	490-2656		490-2228	49-2297		49-1880	49-1881 *	
	FX Models	'71-95	YB16-B			490-2228	49-2297		49-1880	49-1881 *	
<b>SPORTSTER</b>											
	FX (Kick Start)	'71-72	12N7-4A			490-2098				49-1718	
	XLCH (Kick Start)	'70-78	12N7-4A			490-2098				49-1718	
	All models	'04-18	YTX14L-BS	490-2658	490-2653		49-2272	49-2254		49-1979	49-1936
		'97-03	YTX20L-BS	490-2657	490-2651		49-2273	49-2252		49-1968	
	All models	'79-96	YB16-B	490-2656		490-2228	49-2297		49-1880	49-1881 *	
	XLCH	'70-78	12N7-4A							49-1720	
	XLH	'67-78	YHD-12			490-2128				49-1774	
<b>V-ROD</b>											
	All models	'08-17	YTX20L-BS	490-2657	490-2651		49-2273	49-2252		49-1968	
		'02-07	YTX14-BS				49-2271	49-2248		49-1964	49-1935
<b>MISC.</b>											
500	MT500 (Military)	All	YB14L-A2			490-2216		49-2241	49-1868	49-1963	
350	SS350	All	6N11A-1B			490-2062					
90/125/175/150	All models	'73-78	12N7-3B			490-2098			49-1718		

\* Calcium Plate (CX) Technology - not sealed type







## BATTERY CABLE KITS



- All Balls battery cables are manufactured with pure electrolytic grade, 36 gauge copper wire strands
- Increase starter performance by reducing voltage losses from undersized battery cables
- The 7 over 7 bundling of the copper strands maximizes current flow and flexibility of the cable
- The outer jacket material is rated for 257°F and is oil and gas resistant
- Cables are available in individual lengths, application specific cable kits, and 25ft custom cable kit allowing for custom build lengths

Application	Year	Cable Length	Black	Clear
<b>HARLEY DAVIDSON</b>				
Dyna	'91-03	8", 8", 15"	<b>279-3005-1</b>	<b>279-3005</b>
	'04-09	9", 14", 15"	<b>279-3013-1</b>	<b>279-3013</b>
FXR	'82-88	12", 16", 16"	<b>279-3003-1</b>	<b>279-3003</b>
	'89-94	12", 16"	<b>279-3004-1</b>	<b>279-3004</b>
Touring	'65-79	9", 16", 16"	<b>279-3006-1</b>	<b>279-3006</b>
	'80-88	9", 30", 30"	<b>279-3007-1</b>	<b>279-3007</b>
	'89-92	33", 33"	<b>279-3008-1</b>	<b>279-3008</b>
	'93-08	8", 13", 13"	<b>279-3009-1</b>	<b>279-3009</b>
Softail	'84-88	"8, 15", 17"	<b>279-3001-1</b>	<b>279-3001</b>
	'89-08	10", 12"	<b>279-3002-1</b>	<b>279-3002</b>
Sportster	'81-03	11", 16"	<b>279-3010-1</b>	<b>279-3010</b>
	'04-09	13", 13"	<b>279-3011-1</b>	<b>279-3011</b>

## INDIVIDUAL BATTERY CABLES



Cable Length	Black	Clear
<b>HARLEY DAVIDSON</b>		
7"	<b>278-107-1</b>	<b>278-107</b>
8"	<b>278-108-1</b>	<b>278-108</b>
9"	<b>278-109-1</b>	<b>278-109</b>
10"	<b>278-110-1</b>	<b>278-110</b>
11"	<b>278-111-1</b>	<b>278-111</b>
12"	<b>278-112-1</b>	<b>278-112</b>
13"	<b>278-113-1</b>	<b>278-113</b>
14"	<b>278-114-1</b>	<b>278-114</b>
15"	<b>278-115-1</b>	<b>278-115</b>
16"	<b>278-116-1</b>	<b>278-116</b>
17"	<b>278-117-1</b>	<b>278-117</b>
19"	<b>278-119-1</b>	<b>278-119</b>
21"	<b>278-121-1</b>	<b>278-121</b>

Cable Length	Black	Clear
<b>HARLEY DAVIDSON (CONT'D...)</b>		
23"	<b>278-123-1</b>	<b>278-123</b>
25"	<b>278-125-1</b>	<b>278-125</b>
27"	<b>278-127-1</b>	<b>278-127</b>
29"	<b>278-129-1</b>	<b>278-129</b>
30"	<b>278-130-1</b>	<b>278-130</b>
32"	<b>278-132-1</b>	<b>278-132</b>
33"	<b>278-133-1</b>	<b>278-133</b>
25' bulk	<b>299-2002</b>	<b>299-2001</b>



## BATTERY CABLE COMPONENTS

Description	WPS#
<b>HARLEY DAVIDSON</b>	
1/4" terminal	<b>299-1007</b>
5/16" terminal	<b>299-1008</b>
3/8" terminal	<b>299-1009</b>
Black heat shrink wrap kit	<b>299-1024</b>
Red heat shrink wrap kit	<b>299-1034</b>
Crimping tool	<b>299-1012</b>

- WINDSHIELDS / FAIRINGS
- AUDIO / COMMUNICATION
- SEATS / LUGGAGE
- BAR / MIRRORS / CONTROLS
- EXHAUST
- AIR / FUEL SYSTEMS
- ENGINE
- TRANSMISSION / DRIVELINE
- GASKETS / SEALS
- ELECTRICAL**
- LIGHTING
- CABLES
- BRAKES
- OIL FILTERS
- SUSPENSION
- BODY
- WHEELS
- TIRES / TIRE ACC.
- BIKE ACC.
- VICTORY / INDIAN
- COVERS / LOCKS / TIEDOWNS
- CHEMICALS
- TOOLS
- HELMETS
- HELMET ACC.
- EYEWEAR
- APPAREL / RIDER ACC.
- PROMOTIONAL
- REFERENCE
- INDEX



## RUBBER BATTERY CUSHION

Heat, acid and oil resistant

Description	WPS#
A '85-96 Softtail battery cushion	<b>820-2720</b>
B '97-99 Softtail battery cushion	<b>820-2721</b>

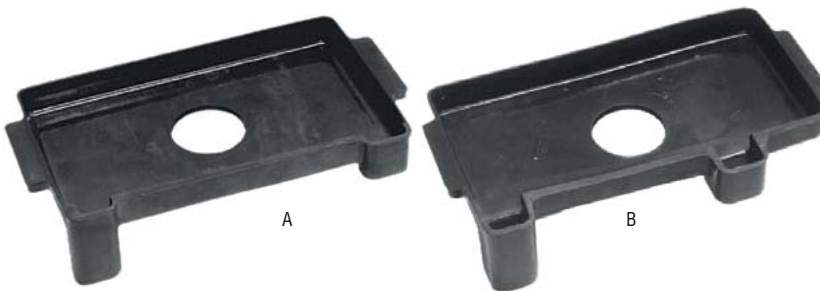

## BATTERY TERMINAL SCREW KIT

- Add a look of authenticity to any restoration
- Made in the USA!

Description	Application	WPS#
Battery terminal fasteners and felt washers	'23-65 All 6v H-D	<b>830-1110</b>



## BATTERY HARDWARE KIT



- 177 Piece battery hardware assortment
- Includes convenient 14 compartment case
- All items in kit are available separately

Description	WPS#
Battery Hardware Kit - 177 pc (includes 1 pack of each part listed below)	<b>490-9900</b>
<b>REPLACEMENT HARDWARE</b>	
Vent Cap, screw in	6/pk <b>490-9901</b>
Vent Cap, push in	50/pk <b>490-9911</b>
Bolt, 5mm x 10 mm	10/pk <b>490-9902</b>
Bolt, 6mm x 10 mm	10/pk <b>490-9903</b>
Bolt, 6mm x 13 mm	10/pk <b>490-9904</b>

Description	WPS#
Bolt, 6mm x 16 mm	10/pk <b>490-9905</b>
Bolt, 6mm x 24 mm	10/pk <b>490-9906</b>
Flat Washer, 6mm	20/pk <b>490-9907</b>
Hex Nut, 5mm	10/pk <b>490-9909</b>
Hex Nut, 6mm	10/pk <b>490-9913</b>
Square Nut, 5mm	10/pk <b>490-9910</b>
Square Nut, 6mm	10/pk <b>490-9914</b>
Spacer, 8mm	10/pk <b>490-9908</b>
Water Sensor	1/pk <b>490-9912</b>

**DIGITAL BATTERY TESTER**

**FIREPOWER**  
 By WPS

- Tests cold cranking amps (CCA) on all 12 volt lead acid, lead gel and lithium batteries
- Works with powersport and automotive batteries
- 2000 CCA test capacity
- Shows, voltage, state of charge and state of health of the battery
- Adjustable backlight display, can be used in varying light conditions
- Also capable of testing most automotive and some powersport vehicle charging systems\*
- Includes storage case

CCA capacity of the battery will need to be known for proper testing, CCA list is included with the instructions. Contact WPS if your powersport battery is not listed.

\*The primary intention for this tester is to analyze a batteries condition, if it does not analyze a charging systems condition properly, it does not mean that the tester is at fault.

Description	WPS#
Digital battery tester	490-9951

**12 VOLT/2 AMP BATTERY CHARGER**

Charges and maintains all 12 volt lead acid, gel and lithium iron phosphate (LiFePO4)/lithium ion polymer powersport batteries.



- CONSTANT CURRENT CHARGE - If the battery voltage is over 10 volts, the charger will deliver a 2 amp charge until the battery reaches 14.2 volts
- MAINTENANCE CHARGE - When the battery reaches 14.2 volts, the charger will automatically convert to maintenance mode. The charger will revert to charge mode when the voltage drops below a specified voltage
- LOW VOLTAGE RECOVERY - If battery voltage is below 8 volts, the charger will apply a .2 amp charge to recover the battery, once the battery reaches 8 volts, the charger will apply a .5 amp charge, at 10 volts a full 2 amp charge is applied until the battery is fully charged
- AUTOMATIC VERIFICATION STAGE - Charger automatically stops charging if the battery does not reach at least 10 volts after 2 hours of charging
- SAFETY - Power is not passed thru the charging leads unless they are connected to a battery
- LED indicator light shows charging status
- Includes heavy duty clamps and fused ring terminal SAE adapter

WPS#
490-9950

**6 AND 12 VOLT BATTERY CHARGER**

- Converts from 6 to 12 volts at the flick of a switch
- Snap-cord style leads

Description	WPS#
Charger	56-1111
Replacement Battery Leads	56-1110

WINDSHIELDS / FAIRINGS

AUDIO / COMMUNICATION

SEATS / LUGGAGE

BARS / MIRRORS / CONTROLS

EXHAUST

AIR / FUEL SYSTEMS

ENGINE

TRANSMISSION / DRIVELINE

GASKETS / SEALS

ELECTRICAL

LIGHTING

CABLES

BRAKES

OIL FILTERS

SUSPENSION

BODY

WHEELS

TIRES / TIRE ACC.

BIKE ACC.

VICTORY / INDIAN

COVERS / LOCKS / TIEDOWNS

CHEMICALS

TOOLS

HELMETS

HELMET ACC.

EYEWEAR

APPAREL / RIDER ACC.

PROMOTIONAL

REFERENCE

INDEX



### 4 AMP SELECTABLE

The Battery Tender® 4 Amp Selectable is an automatic and easy to use battery charger that will keep your battery fully charged and ready to go when you are. Whether it is 6 or 12 volt AGM, Lead Acid or Lithium, the Battery Tender 4 Amp Selectable has the proper charge algorithm for charge and maintenance to ensure long term battery health.

- Selectable Battery Chemistry- has battery chemistry selection with proper charge algorithm for lead-acid, flooded or sealed maintenance free (AGM and gel cell), and Lithium batteries.
- 6/12 volt selectable
- Complete 4-step charging program (Initialization, Bulk Charge, Absorption Mode, Float Mode)
- Automatically switches to float/maintenance voltage after fully charging the battery
- If the battery voltage drops too far under load, full charger output power resumes
- Solid state two color LED indicates stage of charger
- Spark proof reverse polarity protected
- Meets California and Oregon appliance energy efficiency standards for battery charging systems
- 5 year warranty

Description	WPS#
6/12 Volt, 4 amp	56-1120



### 1.25 AMP SELECTABLE

The Battery Tender® 1.25 Amp Selectable is a fully automatic battery charger that will keep your battery fully charged and ready to go when you are. With a 6 and 12 volt option, this charger has the proper charge algorithm for charge and maintenance to ensure long term battery health.

- 6 and 12 volt selectable
- Complete 4-step charging program (Initialization, Bulk Charge, Absorption Mode, Float Mode)
- Automatically switches to float/maintenance voltage after fully charging the battery
- If the battery voltage drops too far under load, full charger output power resumes
- Solid state two color LED indicates stage of charger
- Spark proof, reverse polarity protected
- Meets California and Oregon appliance energy efficiency standards for battery charging systems
- 5 year warranty

Description	WPS#
6/12 Volt, 1.25 amp	56-1115



### JUNIOR SELECTABLE

The Battery Tender® Junior Selectable is much more than a trickle charger. It has a brain. It's lightweight, compact, and fully automatic; very easy to use, especially in small spaces. It will keep your Lead Acid, AGM or Lithium battery fully charged so that it is ready to go when you are!

- Output: 12v @ 800mA
- Selectable Battery Chemistry- has battery chemistry selection with proper charge algorithm for lead-acid, flooded or sealed maintenance free (AGM and gel cell), and Lithium batteries
- Complete 4-step charging program (Initialization, Bulk Charge, Absorption Mode, Float Mode)
- Automatically switches to float/maintenance voltage after fully charging the battery
- If the battery voltage drops too far under load, full charger output power resumes
- Solid state two color LED indicates stage of charger
- Spark proof, reverse polarity protected
- Meets California and Oregon appliance energy efficiency standards for battery charging systems
- 12' output cord
- 5 year warranty

Description	WPS#
Junior 12 volt, .8 amp	56-1119



### JUNIOR™

- Lightweight, compact in size ideal for those hard to fit spots
- Trickle charger with a brain will assure batteries are maintained after charging and always ready to go!
- Fully automatic two-stage lead-acid battery charger is perfect for all lead-acid, sealed maintenance free and gel cell batteries
- After reaching peak 14.4 VDC, charger automatically switches to 13.2 VDC float voltage
- When voltage drops below 12.6 VDC, charger resumes charging back to 14.4 VDC
- Solid state two color LED indicates state of charger

Description	WPS#
12 volt waterproof	56-1131

These chargers do NOT meet California/Oregon appliance efficiency standards.



**PLUS**

**SAFE, RELIABLE, TROUBLE FREE BATTERY CARE!**

Developed to maintain batteries in vehicles not in constant use and stored over lengthy periods of time.



**FULLY AUTOMATIC CHARGER**

- Automatically switches after fully charging to storage charge; constantly monitors the battery without the damaging effects of trickle charging
- After a full charge is reached, the Battery Tender automatically converts to a float charger and monitors the battery at 13.6 volts
- Improved circuit design provides better absorption for sealed batteries
- 5 year warranty



**ALUMINUM CONSTRUCTION**  
Equipped with 6' power cord, 6" output cord with clamps, and 6" quick disconnect output cord.

Description	WPS#
Standard Type	56-1130
<b>QUICK DISCONNECT LEADS</b>	
Leads with Clamps black connector	56-1137
Quick Disconnect Leads black connectors	56-1138
12.5' Extension Lead	56-1142
25' Extension Lead	56-1139
Cigarette lighter adaptor	56-1141

These chargers do NOT meet California/Oregon appliance efficiency standards.



**MULTIPLE BANK PLUS**

The multiple bank Battery Tender Charging Stations have two or four encased 1.25 amp battery chargers designed to fully charge a battery and maintain it at proper storage voltage without the damaging effects caused by trickle chargers. This charger will operate anywhere in the world!

- 2 or 4 independent charging stations
- 12 volts @ 1.25 amps per station
- Operates anywhere in the world, 100-240 VAC 50/60 Hz
- Microprocessor controlled constant current charging
- Reverse polarity protected, spark proof
- Perfect for all AGM (absorbed glass mat), sealed maintenance free and flooded batteries
- Complies with US and international safety standards (UL/CE)
- 2 year warranty



Description	WPS
2 Station	56-1116
4 Station	56-1134
<b>REPLACEMENT LEADS</b>	
Leads with ring connector	56-1138
Lead with clamps	56-1137
12.5' Extension Lead	56-1142
25' extension lead	56-1139

These chargers do NOT meet California/Oregon appliance efficiency standards.



**BATTERY MANAGEMENT SYSTEMS**

- Charges and maintains up to five or ten batteries simultaneously
- Absolutely no chance of overcharging or overheating a battery
- Charger will not operate if battery is connected incorrectly, causing no damage
- State of charge lights for each battery
- International battery tender system has a true universal electrical input that allows it to be used anywhere in the world

Description	WPS#
12 volt, 5 output, 2 amp	56-1135
12 volt, 10 output, 2 amp	56-1136
<b>REPLACEMENT LEADS</b>	
Connector leads	56-1124

Description	WPS#
<b>REPLACEMENT LEADS</b>	
Battery Tender/JR Leads with Clamps 2-pin black connector	56-1137
Battery Management System connector leads	56-1124

- WINDSHIELDS / FAIRINGS
- AUDIO / COMMUNICATION
- SEATS / LUGGAGE
- BARS / MIRRORS / CONTROLS
- EXHAUST
- AIR / FUEL SYSTEMS
- ENGINE
- TRANSMISSION / DRIVELINE
- GASKETS / SEALS
- ELECTRICAL**
- LIGHTING
- CABLES
- BRAKES
- OIL FILTERS
- SUSPENSION
- BODY
- WHEELS
- TIRES / TIRE ACC.
- BIKE ACC.
- VICTORY / INDIAN
- COVERS / LOCKS / TIEDOWNS
- CHEMICALS
- TOOLS
- HELMETS
- HELMET ACC.
- EYEWEAR
- APPAREL / RIDER ACC.
- PROMOTIONAL
- REFERENCE
- INDEX



# SOLAR

- The only solar line with a built-in charge controller mounted on the frame
- Exclusive solar panel design with built-in 3-step automatic microprocessor controlled charge controller
- 12V application voltage
- Reverse polarity protected
- Spark proof
- Temperature compensation sensor
- Waterproof

Description	WPS#
Solar 5W (Powersport)	56-1145
Solar 10W (Auto & Powersport)	56-1146
Solar 15W (Deep Cycle/Auto)	56-1147
REPLACEMENT LEADS	
Leads with ring connector (2-pin)	56-1138
56-1138 (25pk) counter top display	56-1127
12.5' Extension Lead	56-1142
25 extension lead	56-1139
Cigarette lighter adaptor	56-1141



56-1145



56-1146



56-1147



## HIGH EFFICIENCY BATTERY CHARGERS

- Meets California and Oregon appliance energy efficiency standards for battery charging systems
- 4 Step charging (qualification, bulk, absorption, float)
- Spark proof, short circuit and reverse polarity protected
- 72 hour safety timer to prevent damage to marginal batteries
- 5 year warranty

Description	WPS#
6 VOLT	
A Battery Tender Jr. 1.25 amp	56-1122
12 VOLT	
A Battery Tender Jr. .75 amp	56-1129
B Battery Tender Plus 1.25 amp	56-1133
C Battery Tender 5 amp	56-1150



A



B



C



# WIRELESS BATTERY MONITOR



Tired of failing batteries? Start tracking your batteries health! With the wireless battery monitor from Battery Tender®, you can be alerted to battery issues before they become a problem with messages sent straight to your phone!

- WiFi connectivity
- Monitor battery remotely
- Avoid battery failure with mobile alerts
- Compatible with standard SAE connectors
- For use with Battery Tender® APP, Android and Apple compatible
- 3 Year warranty

Description	WPS#
Wireless battery monitor	56-1123

## REPLACEMENT CORDS & ACCESSORIES



56-1141

56-1124

56-1137

56-1138

56-1139

56-1143

56-1144

56-1148

56-1149



### THE RING JAR

Contains 25 replacement leads with ring connector (56-1138) in a jar counter top display.

Desc.	WPS#
Ring Jar	56-1127

Description	WPS#
Battery Tender/JR Leads with Clamps 2-pin black connector	56-1137
Battery Tender Quick Disconnect Leads 2-pin black connectors	56-1138
Battery Management System connector leads	56-1124
Multiple Bank/Battery Tender 12.5' extension lead	56-1142
Multiple Bank/Battery Tender 25' extension lead	56-1139
Cigarette Lighter Adapter, Male	56-1141
Cigarette Lighter Adapter, Female	56-1143
Dual Port USB Charger	56-1144
QDC Plug USB Charger 2.1 amp	56-1148
LCD/LED Voltage Display	56-1149

- WINDSHIELDS / FAIRINGS
- AUDIO / COMMUNICATION
- SEATS / LUGGAGE
- BARS / MIRRORS / CONTROLS
- EXHAUST
- AIR / FUEL SYSTEMS
- ENGINE
- TRANSMISSION / DRIVELINE
- GASKETS / SEALS
- ELECTRICAL**
- LIGHTING
- CABLES
- BRAKES
- OIL FILTERS
- SUSPENSION
- BODY
- WHEELS
- TIRES / TIRE ACC.
- BIKE ACC.
- VICTORY / INDIAN
- COVERS / LOCKS / TIEDOWNS
- CHEMICALS
- TOOLS
- HELMETS
- HELMET ACC.
- EYEWEAR
- APPAREL / RIDER ACC.
- PROMOTIONAL
- REFERENCE
- INDEX

# NOCO genius<sup>®</sup>

wicked smart chargers<sup>™</sup>

## BATTERY CHARGERS

- Smart, multi-step, fully automatic switch-mode battery charger/maintainer
- Automatically diagnosis, recovers, charges and maintains acid, gel, and AGM batteries
- Perfect for Motorcycle, ATV, Jet Ski, and Snowmobiles
- Designed for safety: Reverse polarity, short circuit, open circuit, spark proof, overheat, overcurrent and overcharge

- Powered by NOCO's VosFX processor: The revolutionary smart processor utilizing sophisticated levels of intelligence to alter the charging process
- Charges up to 2X faster than traditional linear chargers
- Uses 1/2 the power of standard chargers

### A. G750

- 5 step / .75 amp charging
- Charges all 6 and 12 volt lead acid (1.2 - 30 amp hour) batteries

### B. G1100

- 7 step / 1.1 amp charging
- Charges all 6 and 12 volt lead acid (2.2 - 40 amp hour) and 12 volt lithium batteries

### C. G3500

- 8 step / 3.5 amp charging
- Charges all 6 and 12 volt lead acid (1.2 - 120 amp hour) and 12 volt lithium batteries

### D. G4

- 4 bank shop charger
- 7 step / 1.1 amp per bank charging
- Charges all 6 and 12 volt lead acid (2.2 - 40 amp hour) and 12 volt lithium batteries



A



B



C



D

Description	WPS#
A G750	56-1158
B G1100	56-1159
C G3500	56-1160
D G4	56-1161

## SOLAR BATTERY CHARGERS

- Available in 2.5 and 5 watt versions
- Charges all types of 12 volt lead acid batteries
- Waterproof and weather resistant, works well in low light, cloudy and overcast conditions
- Dimensions: 2.5 watt - 9.45" x 9.45" x .67", 5 watt - 13.7" x 13.7" x .67"

Description	WPS#
2.5 watt	56-1171
5 watt	56-1172





**NOCO**  
**X GRID** **SOLAR BATTERY CHARGERS**

**NOCO**   
**genius**  
wicked smart chargers™



**XGS AUTO SERIES CHARGERS**

The ultra-portable, folding, smart solar charging solution for cars, trucks, boats, motorcycles, ATV's, snowmobiles and more! Link multiple XGrid® panels together with the optional 2' XGC in/out cable (WPS# 56-1309) to add power and speed up charging times.

**A. XGS4 AUTO**

- XGS4 4 watt folding solar panel
- 8' XGC cable
- 12 volt FLEX regulator
- 12 volt plug connector
- Battery clamp connector

Description	WPS#
4 watt auto kit	56-1101



Expansion panel

**XGS USB SERIES CHARGERS**

The ultra-portable, folding, smart solar charging for most any USB powered device. Link multiple XGrid® panels together with the optional 2' XGC in/out cable (WPS# 56-1309) to add power and speed up charging times.

**A. XGS4 USB**

- XGS4 4 watt folding solar panel
- 40" USB cable
- 5 volt FLEX USB regulator
- XGB3 battery pack

**B. XGS9 USB**

- XGS9 9 watt folding solar panel
- 40" USB cable
- 5 volt FLEX USB regulator
- XGB3L battery pack w/flashlight

Description	WPS#
A 4 watt USB kit w/XG3B	56-1103
B 9 watt USB kit w/XGB3L	56-1104

WINDSHIELDS / FAIRINGS  
AUDIO / COMMUNICATION  
SEATS / LUGGAGE  
BARS / MIRRORS / CONTROLS  
EXHAUST  
AIR / FUEL SYSTEMS  
ENGINE  
TRANSMISSION / DRIVELINE  
GASKETS / SEALS  
ELECTRICAL  
LIGHTING  
CABLES  
BRAKES  
OIL FILTERS  
SUSPENSION  
BODY  
WHEELS  
TIRES / TIRE ACC.  
BIKE ACC.  
VICTORY / INDIAN  
COVERS / LOCKS / TIEDOWNS  
CHEMICALS  
TOOLS  
HELMETS  
HELMET ACC.  
EYEWEAR  
APPAREL / RIDER ACC.  
PROMOTIONAL  
REFERENCE  
INDEX



**BATTERY CHARGER ACCESSORIES**

	ACCESSORIES	Noco #	WPS#
A	Battery clamp connector	GC001	56-1162
B	Terminal connector 6mm eyelet	GC002	56-1163
C	Terminal connector 8mm eyelet	GC008	56-1312
	Terminal connector 8mm eyelet w/ Indicator	GC015	56-1313
D	12 volt plug connector	GC003	56-1164
E	12 volt male cigarette conn.	GC011	56-1307
F	12 volt female cigarette conn.	GC010	56-1306
G	10' extension cable	GC004	56-1165
H	SAE adaptor	GC009	56-1166
I	12 volt battery indicator, dash mount	GC016	56-1308

X-GRID ACCESSORIES			
J	FLEX regulator 6 volt	FLEX6V	56-1301
K	FLEX regulator 12 volt	FLEX12V	56-1300
L	FLEX regulator 5 volt USB	FLEXUSB	56-1302
M	XCG 2' in/out cable	GC028	56-1309
	XCG 8' in/out cable	GC029	56-1314
	XCG 25' in/out cable	GC030	56-1315

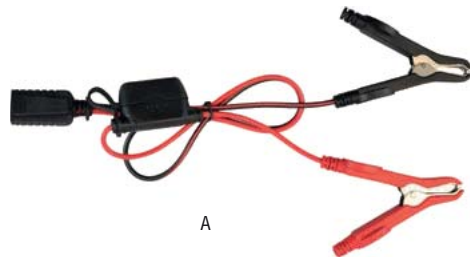

A

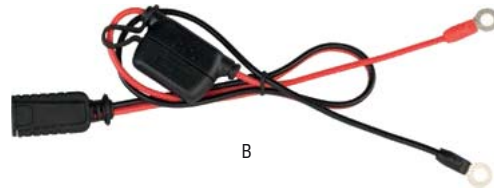

B



C



D



E



F



G



H



I



J



K



L



M

- WINDSHIELDS / FAIRINGS
- AUDIO / COMMUNICATION
- SEATS / LUGGAGE
- BAR / MIRRORS / CONTROLS
- EXHAUST
- AIR / FUEL SYSTEMS
- ENGINE
- TRANSMISSION / DRIVELINE
- GASKETS / SEALS
- ELECTRICAL**
- LIGHTING
- CABLES
- BRAKES
- OIL FILTERS
- SUSPENSION
- BODY
- WHEELS
- TIRES / TIRE ACC.
- BIKE ACC.
- VICTORY / INDIAN
- COVERS / LOCKS / TIEDOWNS
- CHEMICALS
- TOOLS
- HELMETS
- HELMET ACC.
- EYEWEAR
- APPAREL / RIDER ACC.
- PROMOTIONAL
- REFERENCE
- INDEX



## BATTERY TESTER WITH PRINTER

- Developed exclusively for lead acid powersports batteries
- Designed to test batteries with amp hour ratings between 2.3 and 32
- Determines battery health and charge status in seconds
- Single load, dynamic resistance technology minimizes battery drain during test
- Tests both charged and discharged batteries accurately
- Tester prints recommended actions
- Charging system check
- 1 year limited warranty

Includes battery tester, storage case, 2 rolls of printer paper and 4 AA batteries.

Description	WPS#
Battery tester w/printer	49-9995
Repl. paper (2 rolls)	49-9996



## BATTERY TESTER

- Developed exclusively for powersports batteries
- Determines battery status in seconds without charging first
- Determines if the battery is good or bad and percent left

**WPS#**  
49-1607



## JUMPER CABLES

- Heavy-duty 8', 8 gauge cable won't freeze or stiffen in the cold
- Tangle resistant
- Comes with storage bag

**WPS#**  
49-1606

WINDSHIELDS / FAIRINGS

AUDIO / COMMUNICATION

SEATS / LUGGAGE

BARS / MIRRORS / CONTROLS

EXHAUST

AIR / FUEL SYSTEMS

ENGINE

TRANSMISSION / DRIVELINE

GASKETS / SEALS

ELECTRICAL

LIGHTING

CABLES

BRAKES

OIL FILTERS

SUSPENSION

BODY

WHEELS

TIRES / TIRE ACC.

BIKE ACC.

VICTORY / INDIAN

COVERS / LOCKS / TIEDOWNS

CHEMICALS

TOOLS

HELMETS

HELMET ACC.

EYEWEAR

APPAREL / RIDER ACC.

PROMOTIONAL

REFERENCE

INDEX

**JUMP START PACK** 

- 4000 mAh battery provides 400 amps of peak power (200 amp starting), capable of starting most powersport vehicles
- Compact size - 6 1/16" x 3 1/16" x 5/8", weighs just over 7 ounces (without cables)
- Smart jumper cables and built in jump pack protection guards against over-voltage and accidental reverse polarity hook-up
- 5 Volt/2.4 amp USB output port for charging cell phones and other personal electronic devices
- Built in LED flashlight
- Includes smart jumper cables and 3-in-one cable (micro USB/USB C and later iPhone) which allows for re-charging the jump pack and charging other devices
- 1 Year warranty. Read and follow all instructions prior to use

Description	WPS#
GET Jump start pack	<b>68-6980</b>
Replacement jumper cables	<b>68-6990</b>



**JUMPER CABLES**

Perfect for motorcycles, ATVs and electric start snowmobiles. This handy compact 10 gauge jumper cable set is a must for shop, traveling and home use.

Size	WPS#
6' long 10 gauge	<b>56-9630</b>
8' long 10 gauge	<b>56-9631</b>



- WINDSHIELDS / FAIRINGS
- AUDIO / COMMUNICATION
- SEATS / LUGGAGE
- BAR / MIRRORS / CONTROLS
- EXHAUST
- AIR / FUEL SYSTEMS
- ENGINE
- TRANSMISSION / DRIVELINE
- GASKETS / SEALS
- ELECTRICAL**
- LIGHTING
- CABLES
- BRAKES
- OIL FILTERS
- SUSPENSION
- BODY
- WHEELS
- TIRES / TIRE ACC.
- BIKE ACC.
- VICTORY / INDIAN
- COVERS / LOCKS / TIEDOWNS
- CHEMICALS
- TOOLS
- HELMETS
- HELMET ACC.
- EYEWEAR
- APPAREL / RIDER ACC.
- PROMOTIONAL
- REFERENCE
- INDEX

**BATTERY PACKS**
  
**genius**
  
 wicked smart chargers™

## XGB SERIES BATTERY PACKS

Water, dust and impact resistant portable charging.

### A/B. XGB3 SERIES

- Ultra-portable, 3000 mAh/11.1 Wh, 1 amp in/out
- Charges smartphones, HD cameras, GPS units and more
- Recharge from any USB port (charging cord included)
- XGB3L includes 250 lumen LED tactical flashlight w/3 brightness options and strobe

### C. XGB6 SERIES

- Ultra-portable, 6000 mAh/22.2 Wh, 2.1 amp in/out
- Built-in glow light
- Charges smartphones, tablets, eReaders, HD cameras, GPS units and more
- Recharge from any USB port (charging cord included)

### D. XGB12 SERIES

- Ultra-portable, 12000 mAh/44.4 Wh, 2.1 amp in/out
- Built-in glow light
- Charges smartphones, tablets, eReaders HD cameras, GPS units and more
- Recharge directly from a Noco XGrid® solar panel or any USB port (charging cord included)

Description	WPS#
A XGB3	56-1106
B XGB3L	56-1107
C XGB6	56-1108
D XGB12	56-1109



## GB20/GB40 BOOST LITHIUM JUMP START PACKS

**Safely jump start a dead battery in seconds!**

- UltraSafe™ reverse polarity protection, spark proof
- Capable of starting gasoline engines up to 4.0 liters (GB20) and 6.0 liters (GB40)
- Dual ultra-bright LED's, 7 light modes including flashlight and emergency strobe

**Included in box:**

- GB Boost jump starter
- 40" USB to micro USB cable
- 12V/2.1A USB charger
- Battery clamps
- Drawstring storage bag
- User guide and warranty

Description	WPS#
GB20	56-11000
GB40	56-11001
GB70	56-11002
GB150	56-11003

Technical Specifications:

Internal Battery: Lithium Ion

Peak Current Rating: GB20 400 amps peak/200 amps starting current, GB40 1000 amps peak/500 amps starting current

Operating Temperature: -22°F to +122°F

Micro USB (Input): 5V/2.1 amps

USB (Output): 5V/2.1 amps

WINDSHIELDS / FAIRINGS

AUDIO / COMMUNICATION

SEATS / LUGGAGE

BARS / MIRRORS / CONTROLS

EXHAUST

AIR / FUEL SYSTEMS

ENGINE

TRANSMISSION / DRIVELINE

GASKETS / SEALS

ELECTRICAL

LIGHTING

CABLES

BRAKES

OIL FILTERS

SUSPENSION

BODY

WHEELS

TIRES / TIRE ACC.

BIKE ACC.

VICTORY / INDIAN

COVERS / LOCKS / TIEDOWNS

CHEMICALS

TOOLS

HELMETS

HELMET ACC.

EYEWEAR

APPAREL / RIDER ACC.

PROMOTIONAL

REFERENCE

INDEX



## BATTERY HARNESS AND JUMP START KIT

### BIKE-2-BIKE JUMP START KIT

- Includes the Battery Harness (listed above) along with a 5' long jump start extension cable (capable of handling 2000 amps!) with 2 BMW style plugs which allows you to jump start vehicles by just plugging them together
- Also includes 2' 3" long alligator clip leads with female BMW style ends, waterproof caps included

### BATTERY HARNESS

- State of the art 2' 3" long harness includes waterproof caps, 15 amp fuse, conventional SAE plug and a female BMW connector for easy access jump starting between two power sport vehicles
- Works with the Eklipes Bike-2-Bike Jumper Pack (WPS # 71-9127) and is compatible with the Eklipes Charger Adapter (WPS # 71-9125)

Description	WPS #
Battery Harness	71-9126
Jump Start Kit	71-9127



### BIKE 2 BIKE JR . PLUG-IN JUMP START ACCESSORY KIT FOR COBRA

- Plugs directly into the Battery Harnes Kit (WPS # 71-9126) in the EKLIPES Cobra Charging Stations (WPS # 71-9133, 71-9133BK, 71-9133BC)
- Includes a 5' long jump start extension cable with 2 male BMW style plugs which allows you to jump start vehicles by just plugging them together
- Also includes 2' 3" long alligator clip leads with a female BMW style plug for easy jump starting your motorcycle from a car or any other available vehicle



Description	WPS#
Bike 2 Bike Jumpstart for Cobra	71-9134

### BATTERY AND CHARGING SYSTEM TESTER

- The most convenient 12 volt tester on the market today, plugs directly into any cigarette lighter/power socket
- Immediately indicates battery state of charge and how your charging system is functioning in seconds

Description	WPS #
Battery Tester	71-9130



- WINDSHIELDS / FAIRINGS
- AUDIO / COMMUNICATION
- SEATS / LUGGAGE
- BAR / MIRRORS / CONTROLS
- EXHAUST
- AIR / FUEL SYSTEMS
- ENGINE
- TRANSMISSION / DRIVELINE
- GASKETS / SEALS
- ELECTRICAL**
- LIGHTING
- CABLES
- BRAKES
- OIL FILTERS
- SUSPENSION
- BODY
- WHEELS
- TIRES / TIRE ACC.
- BIKE ACC.
- VICTORY / INDIAN
- COVERS / LOCKS / TIEDOWNS
- CHEMICALS
- TOOLS
- HELMETS
- HELMET ACC.
- EYEWEAR
- APPAREL / RIDER ACC.
- PROMOTIONAL
- REFERENCE
- INDEX



## HIGH DEFINITION 7" LED HEADLIGHTS



Projector Design: The light source behind a projector is much more intense and the projector lens helps project the light source further and wider down the road. This is why higher end vehicles use projectors and not reflectors in their headlight system.

- Better visibility day or night
- Impact resistant Polycarbonate Lens
- Dia-Cast aluminum
- Color Temp: 6000k
- 2400LM low beam and 3200LM high beam
- '14-Up Touring models require LED adapter 226-0036 sold separately (not required for '16 Freewheeler)
- Adapter ring required for Touring models with Batwing faring or Nacelle 226-0033 (sold separately)

Description	Black	Chrome
7" LED Headlight	<b>226-0031</b>	<b>226-0032</b>
7" LED Headlight with full Halo	<b>226-0028</b>	<b>226-0029</b>
7" LED Headlight with partial Halo	<b>226-0046</b>	



A) Chrome



A) Black



B) Chrome w/halo



B) Black w/halo

## ADAPTER RING & WIRING HARNESS

- Our Plug converts an LED headlamp with an H4 connector to your Harley
- This H4 Wiring Harness is required for installation on '14-Up Touring models, or if you are changing over from a dual bulb halogen
- 7" Mounting Ring Bracket is required for Touring models with the Bat Wing faring and models with headlight Nacelle
- Chrome or Black



Description	WPS#
Mounting bracket with chrome ring for 7" headlight	<b>226-0030</b>
Mounting bracket with black ring for 7" headlight	<b>226-0033</b>
H4 LED Headlamp wiring harness	<b>226-0036</b>



- WINDSHIELDS / FAIRINGS
- AUDIO / COMMUNICATION
- SEATS / LUGGAGE
- BARS / MIRRORS / CONTROLS
- EXHAUST
- AIR / FUEL SYSTEMS
- ENGINE
- TRANSMISSION / DRIVELINE
- GASKETS / SEALS
- ELECTRICAL
- LIGHTING**
- CABLES
- BRAKES
- OIL FILTERS
- SUSPENSION
- BODY
- WHEELS
- TIRES / TIRE ACC.
- BIKE ACC.
- VICTORY / INDIAN
- COVERS / LOCKS / TIEDOWNS
- CHEMICALS
- TOOLS
- HELMETS
- HELMET ACC.
- EYEWEAR
- APPAREL / RIDER ACC.
- PROMOTIONAL
- REFERENCE
- INDEX

- WINDSHIELDS / FAIRINGS
- AUDIO / COMMUNICATION
- SEATS / LUGGAGE
- BARS / MIRRORS / CONTROLS
- EXHAUST
- AIR / FUEL SYSTEMS
- ENGINE
- TRANSMISSION / DRIVELINE
- GASKETS / SEALS
- ELECTRICAL
- LIGHTING**
- CABLES
- BRAKES
- OIL FILTERS
- SUSPENSION
- BODY
- WHEELS
- TIRES / TIRE ACC.
- BIKE ACC.
- VICTORY / INDIAN
- COVERS / LOCKS / TIEDOWNS
- CHEMICALS
- TOOLS
- HELMETS
- HELMET ACC.
- EYEWEAR
- APPAREL / RIDER ACC.
- PROMOTIONAL
- REFERENCE
- INDEX



## 5 3/4" LED HEADLIGHT

- Plug n play
- LED's draw 1/3 the power compared to your stock lights
- Output is brighter and a much cleaner light source
- Impact resistant polycarbonate lens
- 1400LM low Beam and 1800LM high beam
- SEE THE DIFFERENCE!



	Description	Chrome	Black
A	5 3/4" LED headlight	<b>226-0017</b>	<b>226-0016</b>
B	5 3/4" LED headlight with full Halo	<b>226-0035</b>	<b>226-0034</b>



A) Chrome



A) Black



B) Chrome w/halo



B) Black w/halo

## VROD LED HEADLIGHT

Upgrade your visibility and see what's ahead. Easy plug & play installation for V-Rod VRSCAW, Muscle and VRSCDX models only. 6000K color temperature. 2800 Lumens low beam and 3450 Lumens high beam. One year warranty.



Description	WPS#
LED Headlight for V-Rod Models	<b>226-0047</b>





## ROAD GLIDE LED HEADLIGHT

- Over 3000lm per bulb (HIGH/LOW BEAM)
- These are the best LED light upgrade for your Road Glide
- There is no ballast or extra wiring to tuck away
- Further and wider beam pattern
- Fanless Heatsink Design
- Plug and play for an easy install
- Fits 2004-2013 Road Glide

Black	Chrome
226-0026	226-0027



### 4 1/2" LED PASSING LAMPS

- Sold in pairs
- Beam Pattern: - 25 Degree coverage
- Aluminum die cast heat sink design
- Weatherproof
- Power: 18W @950 Lumens per spot light/over 1900 Lumens combined.

Description	WPS#
Fits most bikes equipped with 4 1/2" passing lamps	226-0015

NOTE: Some wire crimping may be required.



### 4 1/2" PASSING LAMPS

- Sold in pairs
- Plug-n-Play
- Beam Pattern: - Horizontal Flat
- Powered by Cree
- Power: 30W
- 1260 Lumens
- Color temp: 6000K
- Die-cast aluminum heat sink design
- Polycarbonate lens
- 30,000 hour life span

Description	Chrome	Black
Fits most models with 4 1/2" passing lamps	226-0018	226-0019

\*Some wire crimping may be required on 2005 or older models.

- WINDSHIELDS / FAIRINGS
- AUDIO / COMMUNICATION
- SEATS / LUGGAGE
- BARS / MIRRORS / CONTROLS
- EXHAUST
- AIR / FUEL SYSTEMS
- ENGINE
- TRANSMISSION / DRIVELINE
- GASKETS / SEALS
- ELECTRICAL
- LIGHTING**
- CABLES
- BRAKES
- OIL FILTERS
- SUSPENSION
- BODY
- WHEELS
- TIRES / TIRE ACC.
- BIKE ACC.
- VICTORY / INDIAN
- COVERS / LOCKS / TIEDOWNS
- CHEMICALS
- TOOLS
- HELMETS
- HELMET ACC.
- EYEWEAR
- APPAREL / RIDER ACC.
- PROMOTIONAL
- REFERENCE
- INDEX

# **RIGID 7" LED HEADLIGHT**

- DOT Compliant
- Hard-coated polycarbonate lens
- E-coat aluminum housing
- Metalized reflectors
- 16 gauge wiring, encapsulated circuitry
- 2 LED arrays
- 23 watt low beam, 46 watt high beam
- 3 year limited lifetime warranty



**WPS#**

**652-55002**



## **SPOT LAMPS**



10 Watt high intensity (800 Lumen) spot lamps with mounting bracket for 1-1/4" engine guards. Wiring harness, if applicable and switch must be purchased separately. Sold each.

Description	WPS#
10W Spot Lamps	<b>226-0045</b>





## SUSPENDED HEADLIGHT BRACKET



- Black steel construction
- Ideal for mounting bottom mount headlights on triple trees with no mount hole



Application	WPS#
Forks w/3.5" Riser Bolt Spacing	750-01330

## HEADLIGHT MOUNTS



- Chrome plated custom headlight mounting brackets
- Slotted holes allow fitment on various triple trees
- Mounting block is designed for 5 3/4" bottom mount headlights

Description	WPS#
A Bottom Mount Headlight Bracket	820-51700
B Single Mount Headlight Bracket	820-51701
C Headlight Mounting Block	820-51702



A



B



C

- WINDSHIELDS / FAIRINGS
- AUDIO / COMMUNICATION
- SEATS / LUGGAGE
- BARS / MIRRORS / CONTROLS
- EXHAUST
- AIR / FUEL SYSTEMS
- ENGINE
- TRANSMISSION / DRIVELINE
- GASKETS / SEALS
- ELECTRICAL
- LIGHTING**
- CABLES
- BRAKES
- OIL FILTERS
- SUSPENSION
- BODY
- WHEELS
- TIRES / TIRE ACC.
- BIKE ACC.
- VICTORY / INDIAN
- COVERS / LOCKS / TIEDOWNS
- CHEMICALS
- TOOLS
- HELMETS
- HELMET ACC.
- EYEWEAR
- APPAREL / RIDER ACC.
- PROMOTIONAL
- REFERENCE
- INDEX

- WINDSHIELDS / FAIRINGS
- AUDIO / COMMUNICATION
- SEATS / LUGGAGE
- BAR / MIRRORS / CONTROLS
- EXHAUST
- AIR / FUEL SYSTEMS
- ENGINE
- TRANSMISSION / DRIVELINE
- GASKETS / SEALS
- ELECTRICAL
- LIGHTING**
- CABLES
- BRAKES
- OIL FILTERS
- SUSPENSION
- BODY
- WHEELS
- TIRES / TIRE ACC.
- BIKE ACC.
- VICTORY / INDIAN
- COVERS / LOCKS / TIEDOWNS
- CHEMICALS
- TOOLS
- HELMETS
- HELMET ACC.
- EYEWEAR
- APPAREL / RIDER ACC.
- PROMOTIONAL
- REFERENCE
- INDEX



## TRIANGLE HEADLIGHTS

West Eagle's interpretation of the classic triangle chopper headlight, available with a black or chrome shell.



A

B

	Description	WPS#
A	Triangle Headlight Chrome	750-01904
B	Triangle Headlight Black	750-01905



## SOLID BRASS 5-3/4" HEADLIGHTS

5-3/4" Solid brass headlights, deep drawn and formed from solid brass sheet, not cheaply plated like others... so they can be polished as often as you like, or allowed to age and acquire a nice patina. They have high beam indicator light, a 12-volt sealed beam, and include a bottom stud mount.



A

B

	Description	WPS #
A	Brass Headlight Black Ring	830-3250
B	Brass Headlight Chrome Ring	830-3251



### HEADLIGHT SHELLS

- Transforms the look of your headlight without the expense of a complete custom headlamp
- Reuses the stock headlight trim ring and insert from your 5 3/4" Sportster or Dyna
- Made from cast aluminum and then CNC machined
- Available in two styles and finishes

Application	Description	WPS#
5 3/4" Bottom Mount Headlights	Vitamin A Headlight Shell Raw	<b>866-05600</b>
	Vitamin A Headlight Shell Black	<b>866-05601</b>
	Vitamin C Headlight Shell Raw	<b>866-05602</b>
	Vitamin C Headlight Shell Black	<b>866-05603</b>



Vitamin A



Vitamin C



Trim ring shown for reference only

### CAST HEADLIGHT



Add timeless vintage style to your motorcycle with this TC Bros. Streamliner headlight in raw cast or black powder coat finish. Inspired by the Streamliner luxury passenger trains of the 1930s, this light is beautifully hand cast from 356-T6 aluminum right here in the USA. DOT approved, 5-3/4" diameter, sealed beam H4467 halogen bulb combines period correct appearance with modern 12 volt lighting performance. Universal bottom-mount hardware is included.



563-02200



563-02201



Description	Raw	Black
Streamliner 5-3/4" Cast Headlight	<b>563-02200</b>	<b>563-02201</b>

- WINDSHIELDS / FAIRINGS
- AUDIO / COMMUNICATION
- SEATS / LUGGAGE
- BARS / MIRRORS / CONTROLS
- EXHAUST
- AIR / FUEL SYSTEMS
- ENGINE
- TRANSMISSION / DRIVELINE
- GASKETS / SEALS
- ELECTRICAL
- LIGHTING**
- CABLES
- BRAKES
- OIL FILTERS
- SUSPENSION
- BODY
- WHEELS
- TIRES / TIRE ACC.
- BIKE ACC.
- VICTORY / INDIAN
- COVERS / LOCKS / TIEDOWNS
- CHEMICALS
- TOOLS
- HELMETS
- HELMET ACC.
- EYEWEAR
- APPAREL / RIDER ACC.
- PROMOTIONAL
- REFERENCE
- INDEX



## 7" HEADLIGHTS



Description	Application	Mounting Style	WPS#
A Grooved Chrome headlight assembly 12v 60/55w H4 (DOT approved)	'86-04 FL models	Bottom	<b>820-0310C</b>
B Grooved Black headlight assembly 12v 60/55w H4 (DOT approved)	'86-04 FL models	Bottom	<b>820-0310B</b>
C Chrome headlight Assembly 12v 60/55w H4 (DOT approved)	Universal	Side	<b>820-0312</b>

## 6-1/2" HEADLIGHT



Description	Application	Mounting Style	WPS#
Chrome Grooved shell w/visored bezel headlight assembly 12v 60/55w H4	Springer	Bottom	<b>820-0308</b>

## 5-3/4" HEADLIGHTS



Description	Application	WPS#
A Black Headlight assembly 12v 60/55w H4 Composite beam (SAE & DOT approved), satin black smooth	Universal	<b>820-0304B</b>
Chrome Headlight assembly w/built-in visor 12v 60/55w H4 Composite beam (SAE & DOT approved)	Universal	<b>820-0304C</b>
B Chrome Grooved Shell & Visored Bezel Headlight assembly w/heavy duty riveted, bolt through mounting bracket 12v 60/55w H4 (DOT approved)	Universal	<b>820-0305C</b>
C Chrome Billet Bullet style headlight assembly 12v 60/55w H4 bulb	Universal	<b>820-0306C</b>
D Black Billet Bullet style headlight assembly 12v 60/55w H4 bulb, satin black textured	Universal	<b>820-0306B</b>

## 4-1/2" SPOTLIGHTS



Description	WPS#
A 12v 55w H3 bulb (D.O.T. and E.C.E. approved)	<b>820-0300</b>
B 12v 35/35w T19 bulb	<b>820-0301</b>
C 12v 35w H3 (DOT approved)	<b>820-0314</b>



### REPLICA TAIL LIGHTS

- 12V Ford reproduction tail lights with red glass lens
- Lights feature both a brake/running light as well as a license plate light to illuminate your plate at night
- Great old school style for your bobber or chopper!



A



B



C



D

	Description	WPS#
A	33 Ford Replica Tail Light Polished Stainless Steel	563-01400
B	Black 33 Tail Light	563-01401
C	STOP Model A Tail light	563-01402
D	Model A Tail Light	563-01403

### LED REPLICA TAIL LIGHTS



A



B



C

	Description	WPS#
A	LED Ford Dulamop model a stainless steel tail light	563-01450
B	LED 33 Ford tail light	563-01451
C	LED Black 33 Ford tail light	563-01452

### REPLACEMENT TAIL LIGHT LENSES

- Replacement glass lenses for TC Bros. replica taillights (except LED versions)
- Sold each



A



B

	Description	WPS#
A	Repl. Lens Model A Taillight	563-01503
B	Repl. Lens 33 Ford Taillight	563-01504

- WINDSHIELDS / FAIRINGS
- AUDIO / COMMUNICATION
- SEATS / LUGGAGE
- BAR / MIRRORS / CONTROLS
- EXHAUST
- AIR / FUEL SYSTEMS
- ENGINE
- TRANSMISSION / DRIVELINE
- GASKETS / SEALS
- ELECTRICAL
- LIGHTING**
- CABLES
- BRAKES
- OIL FILTERS
- SUSPENSION
- BODY
- WHEELS
- TIRES / TIRE ACC.
- BIKE ACC.
- VICTORY / INDIAN
- COVERS / LOCKS / TIEDOWNS
- CHEMICALS
- TOOLS
- HELMETS
- HELMET ACC.
- EYEWEAR
- APPAREL / RIDER ACC.
- PROMOTIONAL
- REFERENCE
- INDEX

- WINDSHIELDS / FAIRINGS
- AUDIO / COMMUNICATION
- SEATS / LUGGAGE
- BARS / MIRRORS / CONTROLS
- EXHAUST
- AIR / FUEL SYSTEMS
- ENGINE
- TRANSMISSION / DRIVELINE
- GASKETS / SEALS
- ELECTRICAL
- LIGHTING**
- CABLES
- BRAKES
- OIL FILTERS
- SUSPENSION
- BODY
- WHEELS
- TIRES / TIRE ACC.
- BIKE ACC.
- VICTORY / INDIAN
- COVERS / LOCKS / TIEDOWNS
- CHEMICALS
- TOOLS
- HELMETS
- HELMET ACC.
- EYEWEAR
- APPAREL / RIDER ACC.
- PROMOTIONAL
- REFERENCE
- INDEX



## TAIL LIGHTS

- These are used on TC Bros. side mount license plate kits
- Use as replacements for kits
- Use for custom lighting applications

Description	WPS#
A Cate Eye (Die Cast)	<b>563-01405</b>
B Maltese Cross	<b>563-01406</b>
C Star	<b>563-01407</b>
D Stop	<b>563-01408</b>



A



B

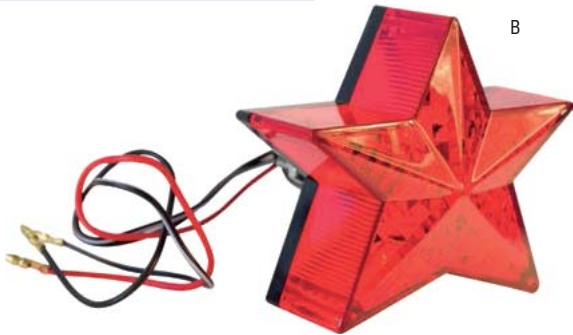

C



D

## GRILL TAIL LIGHTS



A new twist on West Eagle's classic drilled tail lights, these lights come with a removable grill. They come in a variety of finishes and match West Eagle's grill turn signals.

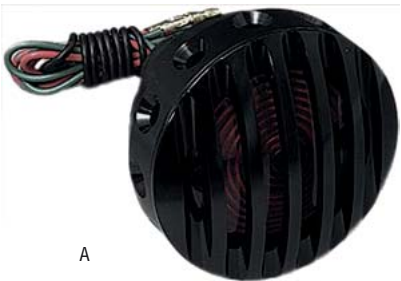

A

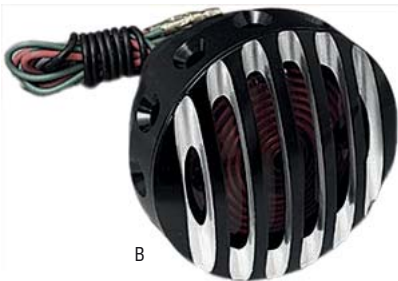

B

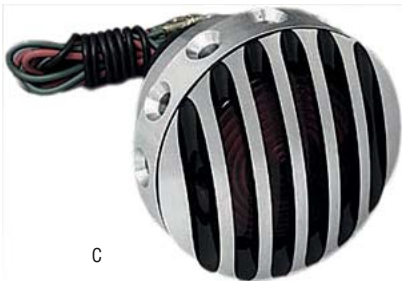

C

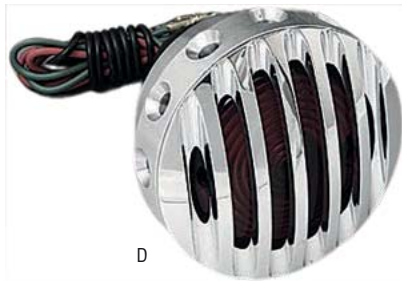

D

Description	WPS#
A Grill Tail light Black	<b>750-01900</b>
B Grill Tail light Black with Aluminum Accents	<b>750-01901</b>
C Grill Tail light Aluminum with Black Accents	<b>750-01902</b>
D Grill Tail light Aluminum	<b>750-01903</b>
Replacement Bulb	<b>60-1374</b>





## HYBRID TAIL LIGHTS



LED tail light with integrated turn signal function, highly visible. Clean up the back of most Harleys from '03-17.



Description	Smoked	Clear
Hybrid Tail Light for most '03-17 Harleys	<b>226-0070</b>	<b>226-0071</b>

- WINDSHIELDS / FAIRINGS
- AUDIO / COMMUNICATION
- SEATS / LUGGAGE
- BAR / MIRRORS / CONTROLS
- EXHAUST
- AIR / FUEL SYSTEMS
- ENGINE
- TRANSMISSION / DRIVELINE
- GASKETS / SEALS
- ELECTRICAL
- LIGHTING**
- CABLES
- BRAKES
- OIL FILTERS
- SUSPENSION
- BODY
- WHEELS
- TIRES / TIRE ACC.
- BIKE ACC.
- VICTORY / INDIAN
- COVERS / LOCKS / TIEDOWNS
- CHEMICALS
- TOOLS
- HELMETS
- HELMET ACC.
- EYEWEAR
- APPAREL / RIDER ACC.
- PROMOTIONAL
- REFERENCE
- INDEX



**LED LAYDOWN TAIL LIGHTS**

- Low profile lens with super bright LEDs
- Available in three colors
- Plugs into existing 3157 socket



Application	Color	WPS#
Fit Most Models '03-16 w/Top Tag Window	Clear	<b>820-0355</b>
	Red	<b>820-0356</b>
	Smoke	<b>820-0357</b>



**TAIL LIGHT ASSEMBLIES**

- High quality replica tail light assemblies
- Manufactured with D.O.T. compliant materials (not D.O.T. approved)



Description	WPS#
A H-D Style '47-54	<b>225-5069</b>
B H-D Style '55-72	<b>225-5109</b>
C H-D Style '73-up	<b>225-5049</b>
D Beehive	<b>225-5059</b>
E Cat Eye	<b>225-5079</b>
F Lucas Style	<b>225-5119</b>

WINDSHIELDS / FAIRINGS  
 AUDIO / COMMUNICATION  
 SEATS / LUGGAGE  
 BARS / MIRRORS / CONTROLS  
 EXHAUST  
 AIR / FUEL SYSTEMS  
 ENGINE  
 TRANSMISSION / DRIVELINE  
 GASKETS / SEALS  
 ELECTRICAL  
**LIGHTING**  
 CABLES  
 BRAKES  
 OIL FILTERS  
 SUSPENSION  
 BODY  
 WHEELS  
 TIRES / TIRE ACC.  
 BIKE ACC.  
 VICTORY / INDIAN  
 COVERS / LOCKS / TIEDOWNS  
 CHEMICALS  
 TOOLS  
 HELMETS  
 HELMET ACC.  
 EYEWEAR  
 APPAREL / RIDER ACC.  
 PROMOTIONAL  
 REFERENCE  
 INDEX

**TAIL LIGHTS**



Description	WPS#
<b>FITS '40-54 BIG TWIN AND SOME CUSTOM FENDERS, INCLUDES LICENSE MOUNT AND GASKET, 12V 23/8W BULB</b>	
A* Chrome Tombstone tail light w/ lic. plate bracket	<b>820-0340C</b>
B* Black Tombstone tail light w/ lic. plate bracket	<b>820-0340B</b>
C* Large Black Tombstone tail light w/ lic. plate bracket	<b>820-0345</b>
Tombstone tail light bracket	<b>820-0353</b>
<b>FITS ALL HD (ECE APPROVED)</b>	
D Mini (2 1/2" X 4 7/8") Tombstone LED tail light w/out lic. plate bracket	<b>820-0350</b>
<b>LOW PROFILE LED TAIL LIGHTS</b>	
E Red Lens	<b>820-0351</b>
F Smoked Lens	<b>820-0352</b>
<b>LAYDOWN LED TAIL LIGHT</b>	
G** Smoked lens w/ license plate lens facing down	<b>820-0403</b>
H** Smoked lens w/ license plate lens facing up	<b>820-0405</b>
I Red lens w/ license plate lens facing down	<b>820-0404</b>
J Red lens w/ license plate lens facing up	<b>820-0406</b>
<b>RETRO STYLE TAIL LIGHT W/ LICENSE PLATE BRACKET</b>	
K 2.3" O.D. red lens	<b>820-0407</b>
L 1.5" O.D. red lens	<b>820-0408</b>
M 1.2" O.D red lens	<b>820-0409</b>
<b>REPLACEMENT PARTS</b>	
Tombstone tail light license plate lens-clear	<b>820-0341</b>
N Tombstone tail light gasket 10pk	<b>820-0342</b>
O Tombstone tail light chrome trim	<b>820-0343</b>
P Red OE style tail light lens	<b>820-0380</b>
Q Tail light lens gasket	<b>820-0381</b>
R Tail light lens gasket for late tail light lens	<b>820-0383</b>
S Tail light replacement screws	<b>820-0382</b>
T Squareback chrome taillight base w/ circuit board	<b>820-52409</b>
Squareback black taillight base w/ circuit board	<b>820-52410</b>

\* Models '73-Up require 820-0353 to mount tombstone tail lights

\*\* Letters G and H come with both plug styles for 99 and up fitments



WINDSHIELDS / FAIRINGS

AUDIO / COMMUNICATION

SEATS / LUGGAGE

BARS / MIRRORS / CONTROLS

EXHAUST

AIR / FUEL SYSTEMS

ENGINE

TRANSMISSION / DRIVELINE

GASKETS / SEALS

ELECTRICAL

**LIGHTING**

CABLES

BRAKES

OIL FILTERS

SUSPENSION

BODY

WHEELS

TIRES / TIRE ACC.

BIKE ACC.

VICTORY / INDIAN

COVERS / LOCKS / TIEDOWNS

CHEMICALS

TOOLS

HELMETS

HELMET ACC.

EYEWEAR

APPAREL / RIDER ACC.

PROMOTIONAL

REFERENCE

INDEX

WINDSHIELDS / FAIRINGS  
 AUDIO / COMMUNICATION  
 SEATS / LUGGAGE  
 BARS / MIRRORS / CONTROLS  
 EXHAUST  
 AIR / FUEL SYSTEMS  
 ENGINE  
 TRANSMISSION / DRIVELINE  
 GASKETS / SEALS  
 ELECTRICAL  
**LIGHTING**  
 CABLES  
 BRAKES  
 OIL FILTERS  
 SUSPENSION  
 BODY  
 WHEELS  
 TIRES / TIRE ACC.  
 BIKE ACC.  
 VICTORY / INDIAN  
 COVERS / LOCKS / TIEDOWNS  
 CHEMICALS  
 TOOLS  
 HELMETS  
 HELMET ACC.  
 EYEWEAR  
 APPAREL / RIDER ACC.  
 PROMOTIONAL  
 REFERENCE  
 INDEX



**SPARTO TAIL LIGHTS**

- Classic sparto taillight for custom applications
- Available in three finishes



Description	WPS#
Sparto Tail Light Polished	820-51703
Sparto Tail Light Chrome	820-51704
Sparto Tail Light Black	820-51705

**FENDER LIGHTS**

- Stylish fender lights add a finishing touch
- High quality construction



Description	WPS#
A Fender Light w/fin Clear	225-5128
B Fender Light w/fin Amber	225-5138
C Fender Light Amber	225-5158



**HORIZONTAL/VERTICAL LICENSE MOUNT**

Accutronix "horizontal" and "vertical" side mount license plate kits will really clean up the back of your Sportster. They mount to the left side of the swing arm and are secured with the axle nut. Installation instructions and mounting hardware are included as required. Depending on how you assemble it, your license plate will sit "horizontal" or "vertical". Machined from 6061 T-6 Billet Aluminum.

Description	Application	Black	Chrome
Vertical/Horizontal Side Mount	All Sportster Models	811-20200	811-20201





## SIDEMOUNT TAIL LIGHT KITS

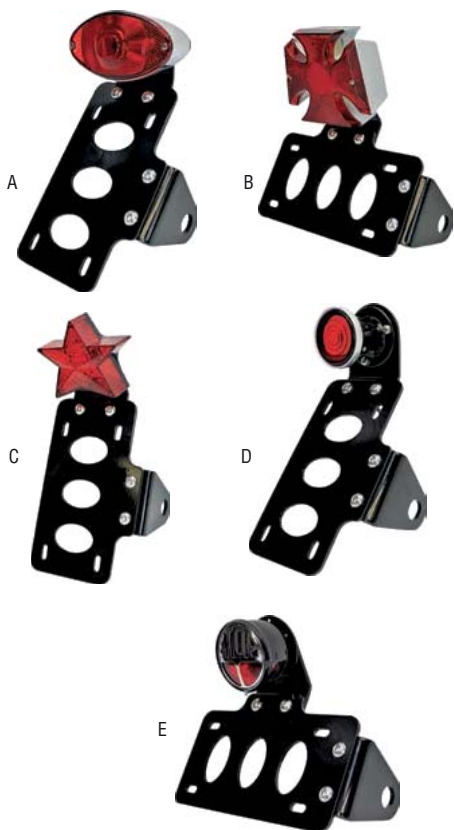

- Unique modular design
- License plate can be mounted horizontally or vertically on either the left or right side of the bike
- Bolt it together using the pre-cut mounting holes in the bracket
- Includes three different mounting brackets
- Bolt bracket to your axle, shock, or weld the included raw steel slug anywhere on your frame and clamp it to that
- Can be used on Harleys with 3/4" axles and metric bikes with 20mm axles
- This is the most versatile bracket on the market!
- Mix and match the mounts to give your bike a unique look
- Includes a 12V brake/tail lamp with license plate light
- The bracket is powder coated gloss black and comes with stainless steel button head bolts/nuts

	Description	WPS#
A	Cateye Sidemount Tail Light/License Plate Bracket	563-01350
B	Maltese Sidemount Tail Light/License Plate Bracket	563-01351
C	Star Sidemount Tail Light/License Plate Bracket	563-01352
D	2" Round Sidemount Tail Light/License Plate Bracket	563-01353
E	Stop Sidemount Tail Light/License Plate Bracket	563-01354
F	Sidemount Tail Light/License Plate Bracket (NO LIGHT)	563-01355
G	Stop Model A Sidemount Tail Light/License Plate Bracket	563-01356
H	Model A Sidemount Tail Light/License Plate Bracket	563-01357
I	33 Ford Sidemount Tail Light/License Plate Bracket	563-01358
J	Black 33 Ford Sidemount Tail Light/License Plate Bracket	563-01359



## LED SIDEMOUNT TAIL LIGHTS



	Description	WPS#
A	LED Model A Sidemount Tail Light/License Plate Bracket	563-01500
B	LED 33 Ford Sidemount Tail Light/License Plate Bracket	563-01501
C	LED Black 33 Ford Sidemount Tail Light/License Plate Bracket	563-01502

- WINDSHIELDS / FAIRINGS
- AUDIO / COMMUNICATION
- SEATS / LUGGAGE
- BARS / MIRRORS / CONTROLS
- EXHAUST
- AIR / FUEL SYSTEMS
- ENGINE
- TRANSMISSION / DRIVELINE
- GASKETS / SEALS
- ELECTRICAL
- LIGHTING**
- CABLES
- BRAKES
- OIL FILTERS
- SUSPENSION
- BODY
- WHEELS
- TIRES / TIRE ACC.
- BIKE ACC.
- VICTORY / INDIAN
- COVERS / LOCKS / TIEDOWNS
- CHEMICALS
- TOOLS
- HELMETS
- HELMET ACC.
- EYEWEAR
- APPAREL / RIDER ACC.
- PROMOTIONAL
- REFERENCE
- INDEX



# SIDEMOUNT TAIL LIGHTS AND LICENSE PLATE FRAMES

- Chrome Plated Billet Aluminum is tough and looks great
- Some models include LED taillight
- Many styles to complement your bike

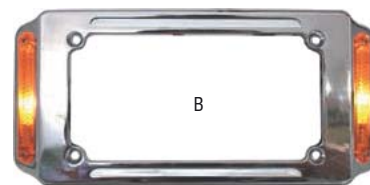

C

D

E

F

G



J

H

I

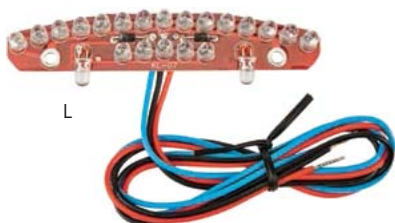

L



L



M

Description / Application	License Plate Size	Color & Style	Vertical / Horizontal	Flat / Curved	Rear / Side Mount	Light Style	WPS#
A Universal		Chrome Ball milled	Horizontal	Flat	Rear		<b>820-2100</b>
B Universal w/ 12v amber lights	9" x 4-1/4"	Louvered Aluminum	Horizontal	Flat	Rear	Running or Directional	<b>820-2722</b>
C '08+ Softail	7" x 4"	Chrome Plated Billet Aluminum	Vertical	Curved	Side	Half Moon LED	<b>820-2105</b>
D '08+ Softail	7" x 4"	Chrome Plated Billet Aluminum	Vertical	Flat	Side	Half Moon LED	<b>820-2106</b>
E '08+ Softail	7" x 4"	Chrome Plated Billet Aluminum	Vertical	Curved	Side	Cateye LED	<b>820-2107</b>
F '86-03 Softail	7" x 4"	Chrome Plated Billet Aluminum	Vertical	Flat	Side	Slayer LED	<b>820-2114</b>
G '86-03 Softail	7" x 4"	Chrome Plated Billet Aluminum	Vertical	Curved	Side	Slayer LED	<b>820-2115</b>
H All HD with standard 3-bolt bracket	7" x 4"	Chrome Plated Billet Aluminum	Horizontal	Curved	Rear		<b>820-2116</b>
I All HD with standard 3-bolt bracket	7" x 4"	Chrome Plated Billet Aluminum	Horizontal	Curved	Rear	Half Moon LED	<b>820-2117</b>

REPLACEMENT PARTS							
J Amber lens						Running or Directional	<b>820-2723</b>
K LED Array for Half Moon						Half Moon LED	<b>820-2110</b>
L Red Lens for Half Moon						Half Moon LED	<b>820-2110R</b>
M Bushing and spacer for radius side mount curved license plate / '86-Up Softail							<b>820-2112</b>

**SDC LED LICENSE PLATE FRAMES**



- These dual intensity LED License Plate Frames have been designed to give greater visibility and conspicuity to your motorcycle
- Engineered to function in both high and low intensity brightness for a multitude of applications
- Because many motorcycles have only one brake/running light bulb, these units can easily be used as back-up brake, and running lights, providing you a greater degree of safety and added visibility
- Some models feature 3 amber LEDs on both sides of the light bars that function as auxiliary turning signals
- Mount and install this beautifully crafted license plate frame and give your bike an excellent finished appearance compared to an otherwise obtrusive license plate

	Description	WPS#
A	Standard Chrome/ Red Lens	28-02001
B	Standard Chrome/ Clear Lens w/ Turn Signals	28-02601
C	Standard Black/ Red Lens	28-02003
D	Standard Black/ Clear Lens w/ Turn Signals	28-02603
E	Twisted Chrome/ Clear Lens w/ Turn Signals	28-02602
F	Twisted Chrome/ Red lens	28-02002



**SKULL LICENSE PLATE SCREWS**

- LED lights in the eyes add rear visibility
- Available in various colors
- Sold in pairs

Description	Color	WPS#
Lighted Skull License Plate Bolts	Yellow	820-55550
	Red	820-55551
	Blue	820-55552
	Green	820-55553
	White	820-55554

**SISSY BAR LICENSE PLATE MOUNT**



- This license plate/tail light mount bolts to most sissy bars for an uncluttered look
- Tail light sold separately



Application	WPS#
Fits Most Square and Round Sissy Bars	750-02073

WINDSHIELDS / FAIRINGS  
 AUDIO / COMMUNICATION  
 SEATS / LUGGAGE  
 BARS / MIRRORS / CONTROLS  
 EXHAUST  
 AIR / FUEL SYSTEMS  
 ENGINE  
 TRANSMISSION / DRIVELINE  
 GASKETS / SEALS  
 ELECTRICAL  
**LIGHTING**  
 CABLES  
 BRAKES  
 OIL FILTERS  
 SUSPENSION  
 BODY  
 WHEELS  
 TIRES / TIRE ACC.  
 BIKE ACC.  
 VICTORY / INDIAN  
 COVERS / LOCKS / TIEDOWNS  
 CHEMICALS  
 TOOLS  
 HELMETS  
 HELMET ACC.  
 EYEWEAR  
 APPAREL / RIDER ACC.  
 PROMOTIONAL  
 REFERENCE  
 INDEX



**FENDER TIP LIGHTS**

- Meets or exceeds OEM specifications
- DOT approved



	Description	Application	WPS#	Replacement Lens
A	Rear Fender tip LED light w/ red lens	'09-13 touring models	<b>820-0402</b>	
B	Rear Fender tip LED light w/ smoked lens	'09-13 touring models	<b>820-0401</b>	
C	Rear Fender tip light w/ red lens	'99-08 touring models	<b>820-0394</b>	<b>820-0392</b>
D	Rear Fender tip light w/ smoked lens	'99-08 touring models	<b>820-0393</b>	<b>820-0391</b>
E	Rear Fender tip light w/ red lens	'04-13 softail models	<b>820-0400</b>	<b>820-0392</b>
F	Rear Fender tip light w/ smoked lens	'04-13 softail models	<b>820-0399</b>	<b>820-0391</b>
G	Front Fender tip light w/ amber lens	'00-13 touring models	<b>820-0395</b>	<b>820-0396</b>
H	Front Fender tip light w/ smoked lens	'00-13 touring models	<b>820-0398</b>	<b>820-0397</b>

**TOUR PAK REPLACEMENT LENS**

- OEM direct replacement
- Give your Tour Pak a different look by adding smoked lenses



	Description	Application	WPS#
A	Corner light rep. lens, red	'89-13 King Tour Pak	<b>820-0388</b>
B	Corner light rep. lens, smoke	'89-13 King Tour Pak	<b>820-0387</b>
C	Side light rep. lens, red	'87-06 King Tour Pak	<b>820-0390</b>
D	Side light rep. lens, smoked	'87-06 King Tour Pak	<b>820-0389</b>





E. BLACK

### BAG LIGHTS

These LED turn signals fit nicely between the saddlebag & fender on a custom FLH or on any flat surface. They are a great solution for adding rear lights to custom baggers. The LED unit is a 3-wire light & can be used as a running, turn and/or brake light. A load equalizer or turn signal controller may be needed for your application. The billet housing is 8-3/8" Long & 1-1/2" Wide. The LED unit has 10 LED's & is 5-1/4" Long & 1/2" Wide. Approximately 3/4" of clearance is needed behind the surface. Machined from 6061 T6 billet aluminum. They are available in a chrome plated finish or our "Night Series", brilliantly Black Anodized, then areas are machined again for a contrast of a black anodized & a raw aluminum finish. Sold in pairs.

Description	Chrome	Black
A Aero Light Red Lens	<b>811-20010</b>	<b>811-20012</b>
B Aero Light Amber Lens	<b>811-20011</b>	<b>811-20013</b>
C Diamond Light Red Lens	<b>811-20014</b>	<b>811-20016</b>
D Diamond Light Amber Lens	<b>811-20015</b>	<b>811-20017</b>
E Tribal Light Red Lens	<b>811-20018</b>	<b>811-20020</b>
F Tribal Light Amber Lens	<b>811-20019</b>	<b>811-20021</b>



A. Chrome

B. Black

C. Chrome

D. Black



E. Black

F. Chrome



E. Chrome

- WINDSHIELDS / FAIRINGS
- AUDIO / COMMUNICATION
- SEATS / LUGGAGE
- BARS / MIRRORS / CONTROLS
- EXHAUST
- AIR / FUEL SYSTEMS
- ENGINE
- TRANSMISSION / DRIVELINE
- GASKETS / SEALS
- ELECTRICAL
- LIGHTING**
- CABLES
- BRAKES
- OIL FILTERS
- SUSPENSION
- BODY
- WHEELS
- TIRES / TIRE ACC.
- BIKE ACC.
- VICTORY / INDIAN
- COVERS / LOCKS / TIEDOWNS
- CHEMICALS
- TOOLS
- HELMETS
- HELMET ACC.
- EYEWEAR
- APPAREL / RIDER ACC.
- PROMOTIONAL
- REFERENCE
- INDEX



## FENDER STRUT MARKER LIGHTS

CNC machined from solid billet aluminum, carefully polished, then hit with a super-durable black anodized or chrome finish that will never fade or flake off. Includes smoked lenses. LEDs are single function but can be converted to multifunction brake, turn signal, running lights, etc., by installing an optional conversion module. Fit '06-16 Dynas except FLD, FXDF, FXDB and FXDWG. Sold in pairs.



Application	Description	Chrome	Black
Fit '06-16 FXD	Amber	<b>812-02098</b>	<b>812-02099</b>
	Red	<b>812-02101</b>	<b>812-02100</b>

## TURN SIGNAL BARS

Pro One turn signal bars fit between the forks and mount to the headlight mounting bolt. Machined from billet aluminum. Come with elliptical amber lenses. Wide Glide version measures 8-1/8" x 3/4" x 1-1/2". Narrow Glide version measures 5-1/4" x 3/4" x 1-1/2". Load equalizer required to properly control the signal action on most models.

Application	Chrome	Black
Narrow Glide Forks	<b>812-02094</b>	<b>812-02095</b>
Wide Glide Forks	<b>812-02096</b>	<b>812-02097</b>

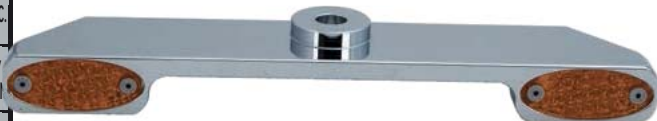

## TURN SIGNAL ELIMINATORS

Pro One turn signal eliminators are CNC machined from solid billet aluminum, carefully polished and then finished with a durable black anodized or chrome finish. Adds a custom billet accent when you relocate your stock front turn signals. Easy to install, mounts to the stock holes and includes chrome mounting hardware. Fits 06-13 FLHX, FLHXXX TRIKE models. Sold in pairs.

Description	Chrome	Black
Turn Signal Eliminators	<b>812-02090</b>	<b>812-02091</b>





**BILLET SIGNAL LIGHTS FLHX**

- Billet LED signal lights fit FLHX models and FLHT models without spotlight bars installed
- Load equalizer required for most models
- Sold in pairs
- Smoke lenses included

Description	Chrome	Black
Billet Signal Lights	<b>812-02102</b>	<b>812-02103</b>

**BILLET SIGNAL LIGHTS FLTR**



- For '98-13 FLTR models.
- CNC machined from solid Billet Aluminum, carefully polished, then triple-chrome plated.
- Includes both Smoked and Amber Lenses.
- Replaces your stock front turn signals for a cleaner, custom look. Bolts to stock mounting holes with no drilling.
- Load equalizer required on most models

Description	Chrome	Black
Billet Signal Lights	<b>812-02092</b>	<b>812-02093</b>

**REAR TURN SIGNAL BLOCK OFF PLATES**



- Used to cover the holes in fender struts when relocating rear turn signals
- Fit most models with rear strut mounted turn signals
- Black powder coated finish

Description	WPS #
Universal Turn Signal Block Off Plates	<b>750-02021</b>



WINDSHIELDS / FAIRINGS

AUDIO / COMMUNICATION

SEATS / LUGGAGE

BARS / MIRRORS / CONTROLS

EXHAUST

AIR / FUEL SYSTEMS

ENGINE

TRANSMISSION / DRIVELINE

GASKETS / SEALS

ELECTRICAL

**LIGHTING**

CABLES

BRAKES

OIL FILTERS

SUSPENSION

BODY

WHEELS

TIRES / TIRE ACC.

BIKE ACC.

VICTORY / INDIAN

COVERS / LOCKS / TIEDOWNS

CHEMICALS

TOOLS

HELMETS

HELMET ACC.

EYEWEAR

APPAREL / RIDER ACC.

PROMOTIONAL

REFERENCE

INDEX



## TURN SIGNAL MOUNTS

These brackets bolt to the head lamp nacelle on '94-13 Road King and other Touring models, except those equipped with non-vented fairing lowers. Allows fitment of many aftermarket turn signals that are to be mounted with a 5/16" bolt. Sold in sets in chrome or black.



Application	Chrome	Black
'97-13 Touring Models	820-52356	820-52357



## LIGHT BAR

- Available in black or chrome finish
- With standard amber lenses or smoked lenses
- DOT approved

Application	Lense Color	Chrome	Black
'86-16 FLST/FLSTC, 93-96 FLSTN and '91-08 FLHT, FLT, FLHR (except '04-14 FLHRS and FLTR Models) '09-14 FLHRC, FLHTC, FLHTCU and FLHTK Models	Amber	820-52361	820-52362
	Smoke	820-52363	820-52364



## LED CHOPPED FENDER TAIL LIGHTS

- Ideal for chopped fenders like Short Flat Bob or Bobber Style Type I & II
- More visibility for models with turn signal-tail light combos
- Will not work with OEM license bracket
- Requires side license plate mounting (sold separately)

Color	WPS#
<b>CHOPPED FENDER TAIL LIGHT FOR '09-13 XL883/1200N, X, V</b>	
A Clear Lens	750-01280
B Red Lens	750-01281
C Smoked Lens	750-01282
<b>CHOPPED FENDER TAIL LIGHT FOR '14-UP XL883/1200N, X, V</b>	
Clear Lens	750-01283
Red Lens	750-01284
Smoked Lens	750-01285





## LED LIGHTS

- Mount on your engine guard or handlebars (1.25" diameter)
- 1.25" diameter x 3.75" long
- Available LED colors: white and amber
- 300 lumen output LED
- Lenses are made of polycarbonate with UV and scratch protection
- Marine grade 316 stainless steel

Description	Polished	Gloss Black	Textured Black
White LED	602-6001	602-6002	602-6003
Amber LED	602-6004	602-6005	602-6006

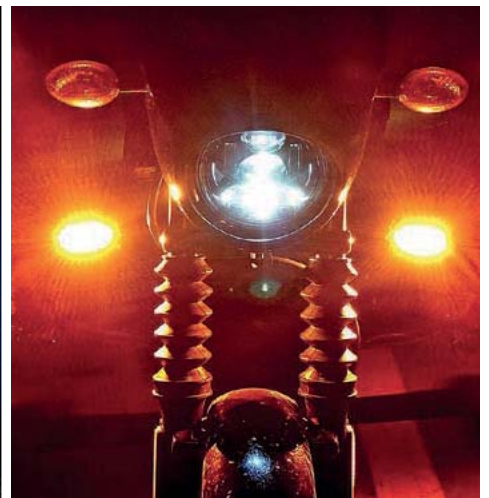

- WINDSHIELDS / FAIRINGS
- AUDIO / COMMUNICATION
- SEATS / LUGGAGE
- BAR / MIRRORS / CONTROLS
- EXHAUST
- AIR / FUEL SYSTEMS
- ENGINE
- TRANSMISSION / DRIVELINE
- GASKETS / SEALS
- ELECTRICAL
- LIGHTING**
- CABLES
- BRAKES
- OIL FILTERS
- SUSPENSION
- BODY
- WHEELS
- TIRES / TIRE ACC.
- BIKE ACC.
- VICTORY / INDIAN
- COVERS / LOCKS / TIEDOWNS
- CHEMICALS
- TOOLS
- HELMETS
- HELMET ACC.
- EYEWEAR
- APPAREL / RIDER ACC.
- PROMOTIONAL
- REFERENCE
- INDEX

WINDSHIELDS / FAIRINGS  
 AUDIO / COMMUNICATION  
 SEATS / LUGGAGE  
 BARS / MIRRORS / CONTROLS  
 EXHAUST  
 AIR / FUEL SYSTEMS  
 ENGINE  
 TRANSMISSION / DRIVELINE  
 GASKETS / SEALS  
 ELECTRICAL  
**LIGHTING**  
 CABLES  
 BRAKES  
 OIL FILTERS  
 SUSPENSION  
 BODY  
 WHEELS  
 TIRES / TIRE ACC.  
 BIKE ACC.  
 VICTORY / INDIAN  
 COVERS / LOCKS / TIEDOWNS  
 CHEMICALS  
 TOOLS  
 HELMETS  
 HELMET ACC.  
 EYEWEAR  
 APPAREL / RIDER ACC.  
 PROMOTIONAL  
 REFERENCE  
 INDEX



### **ER MINI LED FINNED TAIL LIGHTS**

- Machined from billet aluminum
- Finned grill is removable and can be mounted vertical or horizontal
- Available in black machine cut finish or polished finish
- Matching turn signals available
- Clear lens with red LEDs



Description	WPS#
Fined Mini Tail light Black	<b>750-01912</b>
Fined Mini Tail light Polished	<b>750-01913</b>



### **ER MINI LED FINNED TURN SIGNALS**

- Machined from billet aluminum
- Fined grill is removable and can be mounted vertical or horizontal
- Available in black machine cut finish or polished finish
- Matching tail light available
- Clear lens with amber LEDs
- Sold in pairs



Description	WPS#
Fined Mini Turnsignals Black (pr)	<b>750-01910</b>
Fined Mini Turnsignals Polished (pr)	<b>750-01911</b>





## UNIVERSAL TURN SIGNALS

- High quality, rugged cast aluminum body
- Standard (incandescent bulb) and LED versions available
- Available in black or chrome finish in a variety of lens colors
- All turn signals listed are 3 wire (marker and turn signal) unless noted
- Not DOT approved, intended for off highway use
- Dimensions listed are width (less stud) x depth x lens diameter



	Black	Chrome
<b>STYLE 1 STANDARD BULB (2 5/8" X 2 3/4" X 1 7/8")</b>		
Amber Lens	225-8323BK	225-8323C
Clear Lens	225-8324BK	225-8324C
Red Lens	225-8325BK	225-8325C
<b>STYLE 1 LED (2 5/8" X 2 3/4" X 1 7/8")</b>		
Amber Lens	226-8323BK	226-8323C
Clear Lens	226-8324BK	226-8324C
Smoke Lens (2 wire)	226-8325BK	226-8325C
<b>STYLE 2 STANDARD BULB (2 3/8" X 2 3/4" X 1 7/16")</b>		
Amber Lens	225-8333BK	225-8333C
Clear Lens	225-8334BK	225-8334C
Red Lens	225-8335BK	225-8335C
<b>STYLE 2 LED (2 3/8" X 2 3/4" X 1 7/16")</b>		
Amber Lens	226-8333BK	226-8333C
Clear Lens	226-8334BK	226-8334C
Smoke Lens	226-8335BK	226-8335C
<b>STYLE 3 STANDARD BULB (2 3/8" X 1 7/16" X 1 7/16")</b>		
Amber Lens	225-8633BK	225-8607C
Red Lens	225-8636BK	225-8625C
Smoke Lens	225-8631BK	225-8605C
<b>STYLE 3 LED (2 3/8" X 1 7/16" X 1 7/16")</b>		
Amber Lens	226-8633BK	226-8607C
Smoke Lens	226-8631BK	226-8605C
<b>REPLACEMENT STANDARD BULBS (SOLD EACH)</b>		
Amber	225-8047A	
Clear	225-8047	

## O.E.M. STYLE TURN SIGNAL ASSEMBLIES

- D.O.T. Approved
- Manufactured to O.E.M. specifications
- Sold EACH



Application	Year	FRONT		REAR	
		Side	WPS#	Side	WPS#
<b>HARLEY DAVIDSON</b>					
FLH	'86-92	L or R	225-5115	L or R	225-5116
FX w/threads	'73-85	L or R	225-5015	L or R	225-5016
FX w/o threads	'73-85	L or R	225-5085	L or R	225-5086
FXR w/threads	'73-85	L or R	225-5015	L or R	225-5016
FXR w/o threads	'73-85	L or R	225-5085	L or R	225-5086
XL w/threads	'73-85	L or R	225-5015	L or R	225-5016
XL w/o threads	'73-85	L or R	225-5085	L or R	225-5086
FL	'63-85	L or R	225-5035	L or R	225-5036
FX	'71-73	L or R	225-5035	L or R	225-5036
Most models w/threads	'86-93	L or R	225-5025	L or R	225-5026
Most models w/o threads	'86-93	L or R	225-5095	L or R	225-5096

WINDSHIELDS / FAIRINGS  
 AUDIO / COMMUNICATION  
 SEATS / LUGGAGE  
 BARS / MIRRORS / CONTROLS  
 EXHAUST  
 AIR / FUEL SYSTEMS  
 ENGINE  
 TRANSMISSION / DRIVELINE  
 GASKETS / SEALS  
 ELECTRICAL  
**LIGHTING**  
 CABLES  
 BRAKES  
 OIL FILTERS  
 SUSPENSION  
 BODY  
 WHEELS  
 TIRES / TIRE ACC.  
 BIKE ACC.  
 VICTORY / INDIAN  
 COVERS / LOCKS / TIEDOWNS  
 CHEMICALS  
 TOOLS  
 HELMETS  
 HELMET ACC.  
 EYEWEAR  
 APPAREL / RIDER ACC.  
 PROMOTIONAL  
 REFERENCE  
 INDEX



**L.E.D. HALO TURN SIGNALS**

- The new custom HALO turn signals & marker lights are fitted with hi-quality LED
- Can be used as a direct replacement for the OEM or custom applications
- Beautifully finished aluminum housings in chrome or black
- Available with clear or smoke lens
- There is also a combo light with stop/tail light & indicator functions available
- Fits stock 2-bolt indicator mounts on many '86-up FXR, FLH, Softail '86-Up and 2006 FLST
- Does NOT fit models with OEM bullet style turn signals
- Sold each



820-52395



820-52398



820-52399



820-52402

Description	LED	Housing	Function	T/S	Lens	WPS#
* HALO LED turn/stop	Amber/Red combo	Chrome	Combo	Rear	Smoke	<b>820-52395</b>
* HALO LED turn/stop	Amber/Red combo	Black	Combo	Rear	Smoke	<b>820-52396</b>
* HALO LED turn/stop	Amber/Red combo	Chrome	Combo	Rear	Clear	<b>820-52397</b>
* HALO LED turn/stop	Amber/Red combo	Black	Combo	Rear	Clear	<b>820-52398</b>
HALO LED front turn signal	Amber	Chrome	Dual	Front	Smoke	<b>820-52399</b>
HALO LED rear turn signal	Amber	Chrome	Single	Rear	Smoke	<b>820-52400</b>
HALO LED front turn signal	Amber	Black	Dual	Front	Smoke	<b>820-52401</b>
HALO LED rear turn signal	Amber	Black	Single	Rear	Smoke	<b>820-52402</b>
HALO LED front turn signal	Amber	Chrome	Dual	Front	Clear	<b>820-52403</b>
HALO LED rear turn signal	Amber	Chrome	Single	Rear	Clear	<b>820-52404</b>
HALO LED front turn signal	Amber	Black	Dual	Front	Clear	<b>820-52405</b>
HALO LED rear turn signal	Amber	Black	Single	Rear	Clear	<b>820-52406</b>

\*The center LED is for the turn signal and the outer LED can be wired to work with running, marker, tail or stop lights.

**L.E.D. TURN SIGNALS NEW**

- Black Anodized Bullet Styled LED Light
- Clear or Smoked Lens
- Available in Turn signal, Run/Turn and Tail Light/Turn Signal Options

Description	Application	WPS #
Amber LED w/Clear Lens	Turn Signal BLK	<b>820-55555</b>
Amber LED w/ Smoked Lens	Turn Signal BLK	<b>820-55556</b>
White/Amber w/Clear Lens	Run/ Turn Signal BLK	<b>820-55557</b>
White/Amber w/Smoked Lens	Run/ Turn Signal BLK	<b>820-55558</b>
Red/Amber w/Clear Lens	Tail Light/Turn Signal BLK	<b>820-55559</b>
Red/Amber w/Smoked Lens	Tail Light/Turn Signal BLK	<b>820-55560</b>





## TURN SIGNALS



Description	WPS#
<b>UNIVERSAL LED CHROME BULLET MARKER LIGHT PAIR</b>	
A Amber Lens	820-0370A
B Clear Lens	820-0370C
C Red Lens	820-0370R
<b>MINI LED CHROME BULLET MARKER LIGHT PAIR</b>	
D Amber LED & Clear lens	820-0373A
<b>REPLACEMENT PARTS</b>	
E Amber Lens	820-0371A
F Clear Lens	820-0371C
G Red Lens	820-0371R

## 3D LICENSE PLATE LIGHTS



Description	WPS#
A Chrome 5 LED light	820-0375C
B Black 5 LED light	820-0375B

## SMOKED TURN SIGNAL LENS KITS

- Smoked lens kits for OEM style turn signals
- Four lenses and amber bulbs included
- Kits come with single element bulbs

Application	Description	WPS #
A '04-16 FLHRS, FLTR/X/U and FLHX, '02-16 FLST/F/N, '00-16 FXST models, '01-16 FXD and XL models	Smoked Lens Kit Bullet	820-51050
B '86-01 XL, FXD, FXR and '86-99 FXST	Smoked Lens Kit Domed	820-51051
C '86-14 All models (unless listed above)	Smoked Lens Kit Flat	820-51052

\*Kits come with Single Element Bulbs



WINDSHIELDS / FAIRINGS  
 AUDIO / COMMUNICATION  
 SEATS / LUGGAGE  
 BARS / MIRRORS / CONTROLS  
 EXHAUST  
 AIR / FUEL SYSTEMS  
 ENGINE  
 TRANSMISSION / DRIVELINE  
 GASKETS / SEALS  
 ELECTRICAL  
**LIGHTING**  
 CABLES  
 BRAKES  
 OIL FILTERS  
 SUSPENSION  
 BODY  
 WHEELS  
 TIRES / TIRE ACC.  
 BIKE ACC.  
 VICTORY / INDIAN  
 COVERS / LOCKS / TIEDOWNS  
 CHEMICALS  
 TOOLS  
 HELMETS  
 HELMET ACC.  
 EYEWEAR  
 APPAREL / RIDER ACC.  
 PROMOTIONAL  
 REFERENCE  
 INDEX

WINDSHIELDS / FAIRINGS  
 AUDIO / COMMUNICATION  
 SEATS / LUGGAGE  
 BARS / MIRRORS / CONTROLS  
 EXHAUST  
 AIR / FUEL SYSTEMS  
 ENGINE  
 TRANSMISSION / DRIVELINE  
 GASKETS / SEALS  
 ELECTRICAL  
**LIGHTING**  
 CABLES  
 BRAKES  
 OIL FILTERS  
 SUSPENSION  
 BODY  
 WHEELS  
 TIRES / TIRE ACC.  
 BIKE ACC.  
 VICTORY / INDIAN  
 COVERS / LOCKS / TIEDOWNS  
 CHEMICALS  
 TOOLS  
 HELMETS  
 HELMET ACC.  
 EYEWEAR  
 APPAREL / RIDER ACC.  
 PROMOTIONAL  
 REFERENCE  
 INDEX



AMERICAN V-TWIN PRODUCTS

**BULLET LIGHTS**

- Bullet marker lights in dual or single filament bulb configuration
- Available in chrome or satin black
- For use as supplemental lighting
- Sold each

Description	Chrome	Black
Red Lens Single Filament	<b>820-55500</b>	<b>820-55504</b>
Amber Lens Single Filament	<b>820-55501</b>	<b>820-55505</b>
Red Lens Dual Filament	<b>820-55502</b>	<b>820-55506</b>
Amber Lens Dual Filament	<b>820-55503</b>	<b>820-55507</b>



820-55500



820-55501



820-55504



820-55505

**BULLET LIGHTS WITH BRACKET**

- Bullet marker lights with mounting tab
- Single filament with red or amber lenses
- Sold in pairs

Description	Chrome	Black
Red Lens Single Filament	<b>820-55508</b>	<b>820-55510</b>
Amber Lens Single Filament	<b>820-55509</b>	<b>820-55511</b>



820-55508



820-55509



820-55510



820-55511



## H-D TURN SIGNAL LED RETRO FIT KITS

- Convert your Harley Davidson deuce style marker/turn signal lights from incandescent bulbs to ultra-bright LED lights
- LEDs can last up to 100 times longer than incandescent bulbs. They draw 10 times less amperage and turn on significantly faster than standard factory bulbs, and because they are solid state, there is no filament to burn out or be damaged by vibration.

### Each Kit Contains:

- Two (2) Clear Polycarbonate Outer Bullet Light Lenses (specific for 'deuce' style bullet lights)
- Two (2) Harley Davidson Deuce Marker/Turn Signal LED Light boards
- Two (2) Amber or Red Inner Lens/Disc to be placed on the LED light board
- Six (6) male connectors for simple wire splicing
- Six (6) female connectors for simple wire connection
- Two (2) Jumper wires (Black, Blue and Purple to match stock HD wiring)
- One (1) DUAL LOAD EQUALIZER

Description	WPS#
Red Retro Fit Kit	<b>28-02450</b>
Amber Retro Fit Kit	<b>28-02451</b>



## TURN SIGNAL CLAMPS

- Available in chrome or gloss black finish
- Die cast aluminum
- Sold in pairs

Description	Chrome	Black
39mm Clamps	<b>820-51706</b>	<b>820-51709</b>
41mm Clamps	<b>820-51707</b>	<b>820-51710</b>
49mm Clamps	<b>820-51708</b>	<b>820-51711</b>

- WINDSHIELDS / FAIRINGS
- AUDIO / COMMUNICATION
- SEATS / LUGGAGE
- BAR / MIRRORS / CONTROLS
- EXHAUST
- AIR / FUEL SYSTEMS
- ENGINE
- TRANSMISSION / DRIVELINE
- GASKETS / SEALS
- ELECTRICAL
- LIGHTING**
- CABLES
- BRAKES
- OIL FILTERS
- SUSPENSION
- BODY
- WHEELS
- TIRES / TIRE ACC.
- BIKE ACC.
- VICTORY / INDIAN
- COVERS / LOCKS / TIEDOWNS
- CHEMICALS
- TOOLS
- HELMETS
- HELMET ACC.
- EYEWEAR
- APPAREL / RIDER ACC.
- PROMOTIONAL
- REFERENCE
- INDEX



# TURN SIGNAL BRACKETS

X



A



B



C



D



E



Description	Application	WPS#
A Axle Mount Turn Signal Bracket	'91-05 Dynas, '97-04 XL	<b>750-01320</b>
B Frame Mount Front Turn Signal Bracket	'91-Up Dynas	<b>750-01323</b>
C Frame Mount Front Turn Signal Bracket	'04-Up XL	<b>750-01321</b>
Frame Mount Front Turn Signal Bracket	Universal	<b>750-01325</b>
D Rear Turnsignal Offset Spacers	'04-Up XL	<b>750-01322</b>
E Step Turn Signal Bracket	'04-Up XL	<b>750-01324</b>

- WINDSHIELDS / FAIRINGS
- AUDIO / COMMUNICATION
- SEATS / LUGGAGE
- BARS / MIRRORS / CONTROLS
- EXHAUST
- AIR / FUEL SYSTEMS
- ENGINE
- TRANSMISSION / DRIVELINE
- GASKETS / SEALS
- ELECTRICAL
- LIGHTING**
- CABLES
- BRAKES
- OIL FILTERS
- SUSPENSION
- BODY
- WHEELS
- TIRES / TIRE ACC.
- BIKE ACC.
- VICTORY / INDIAN
- COVERS / LOCKS / TIEDOWNS
- CHEMICALS
- TOOLS
- HELMETS
- HELMET ACC.
- EYEWEAR
- APPAREL / RIDER ACC.
- PROMOTIONAL
- REFERENCE
- INDEX

**SPOTLIGHT BARS**



Shown with optional  
Spotlight Visors



Application	Year	MFG#	WPS#
<b>SOFTAIL</b>			
FXST/FXSTI Softail Standard	'99-12	N938	<b>562-30061</b>
FXSTC Softail Custom	'07-10	N938	<b>562-30061</b>
FXSTB/FXSTBI Softail Night Train	'99-09	N938	<b>562-30061</b>
FXSTD/FXSTDI Softail Deuce	'00-07	N938	<b>562-30061</b>
FXSTC Softail Custom	'87-99	N938	<b>562-30061</b>
FXST/FXSTI Softail Standard	'84-90	N938	<b>562-30061</b>
<b>DYNA/FXR</b>			
FXDWG Dyna Wide Glide	'93-05	N938	<b>562-30062</b>
FXD/FXDL/FXDX/FXDC (Dyna Series)	'93-05	N935	<b>562-30062</b>
FXDS Dyna Convertible	'94-00	N935	<b>562-30062</b>
FXR/FXRS Low Rider	'82-94	N935	<b>562-30062</b>
FXLR Low Rider Custom	'87-94	N935	<b>562-30062</b>
FXWG Wide Glide	'80-85	N938	<b>562-30061</b>
FXDG Disc Glide	'83	N938	<b>562-30061</b>
<b>SPORTSTER</b>			
XL1200V 72	'12-16	N935	<b>562-30062</b>
XL883N Iron	'09-16	N935	<b>562-30062</b>
XL1200R/XL883R Sportster Roadster	'02-13	N935	<b>562-30062</b>
XL1200N Nightster	'07-12	N935	<b>562-30062</b>
XL1200L Sportster Low	'06-11	N935	<b>562-30062</b>
XL883L Sportster Low	'05-10	N935	<b>562-30062</b>
XL1200C/ XL883C Sportster Custom	'96-10	N935	<b>562-30062</b>
XL1200/ XL883 Sportster	'04-10	N935	<b>562-30062</b>
XL1200S Sportster Sport	'96-03	N935	<b>562-30062</b>
XLH1200/ XLH883 Sportster	'88-03	N935	<b>562-30062</b>

**SPOTLIGHT BAR ACCESSORIES**

Description	WPS#
Light Bar Visors/pr	<b>562-30109</b>
Light Bar Switch	<b>562-30108</b>

**REPLACEMENT PARTS**

Description	WPS#
Light Assembly-H3 Bulb 25 watt	<b>562-30111</b>
Light Assembly-H3 Bulb 35 watt	<b>562-30101</b>
Sealed Beam lamp	<b>562-30102</b>
H-3 lamp	<b>562-30103</b>
25w H-3 Bulb	<b>562-30105</b>
35w H-3 Bulb	<b>562-30104</b>
Turn Signal Assembly/each	<b>562-30106</b>
Turn Signal Lens, Amber/each	<b>562-30107</b>



- WINDSHIELDS / FAIRINGS
- AUDIO / COMMUNICATION
- SEATS / LUGGAGE
- BAR / MIRRORS / CONTROLS
- EXHAUST
- AIR / FUEL SYSTEMS
- ENGINE
- TRANSMISSION / DRIVELINE
- GASKETS / SEALS
- ELECTRICAL
- LIGHTING**
- CABLES
- BRAKES
- OIL FILTERS
- SUSPENSION
- BODY
- WHEELS
- TIRES / TIRE ACC.
- BIKE ACC.
- VICTORY / INDIAN
- COVERS / LOCKS / TIEDOWNS
- CHEMICALS
- TOOLS
- HELMETS
- HELMET ACC.
- EYEWEAR
- APPAREL / RIDER ACC.
- PROMOTIONAL
- REFERENCE
- INDEX

- WINDSHIELDS / FAIRINGS
- AUDIO / COMMUNICATION
- SEATS / LUGGAGE
- BARS / MIRRORS / CONTROLS
- EXHAUST
- AIR / FUEL SYSTEMS
- ENGINE
- TRANSMISSION / DRIVELINE
- GASKETS / SEALS
- ELECTRICAL
- LIGHTING**
- CABLES
- BRAKES
- OIL FILTERS
- SUSPENSION
- BODY
- WHEELS
- TIRES / TIRE ACC.
- BIKE ACC.
- VICTORY / INDIAN
- COVERS / LOCKS / TIEDOWNS
- CHEMICALS
- TOOLS
- HELMETS
- HELMET ACC.
- EYEWEAR
- APPAREL / RIDER ACC.
- PROMOTIONAL
- REFERENCE
- INDEX



**PASSING LAMP BRACKETS**

X

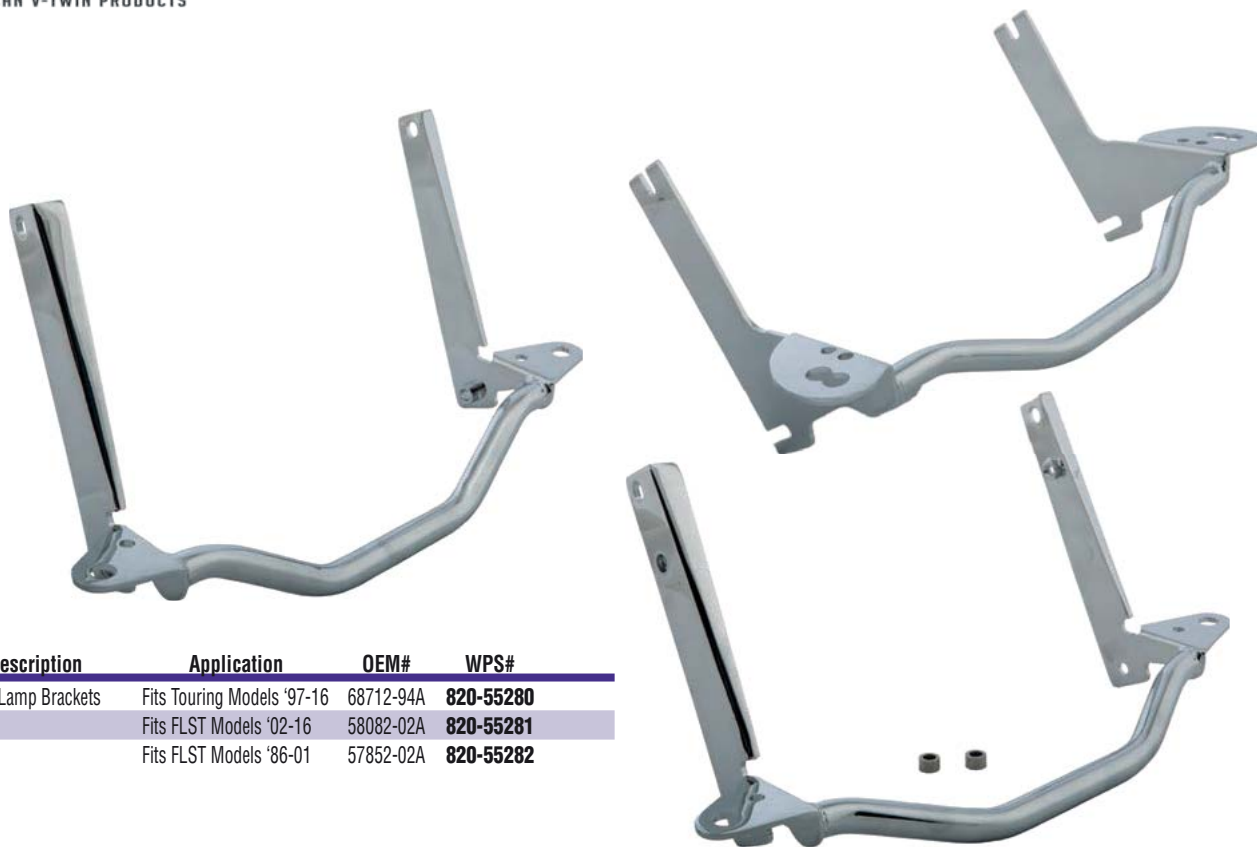

Description	Application	OEM#	WPS#
Passing Lamp Brackets	Fits Touring Models '97-16	68712-94A	<b>820-55280</b>
	Fits FLST Models '02-16	58082-02A	<b>820-55281</b>
	Fits FLST Models '86-01	57852-02A	<b>820-55282</b>

**4.5" SEALED BEAMS**

	Description	WPS#
A	4.5" Amber Fluted 12V 35W	<b>820-57300</b>
	4.5" Amber Fluted 12V 50W	<b>820-57301</b>
B	4.5" Amber Non-Fluted 12V 30W	<b>820-57302</b>
	4.5" Amber Non-Fluted 12V 100W	<b>820-57303</b>
C	4.5" Clear Fluted 12V 30W	<b>820-57304</b>
	4.5" Clear Fluted 12V 50W	<b>820-57305</b>
D	4.5" Clear Non-Fluted 12V 30W	<b>820-57306</b>
	4.5" Clear Non-Fluted 12V 100W	<b>820-57307</b>

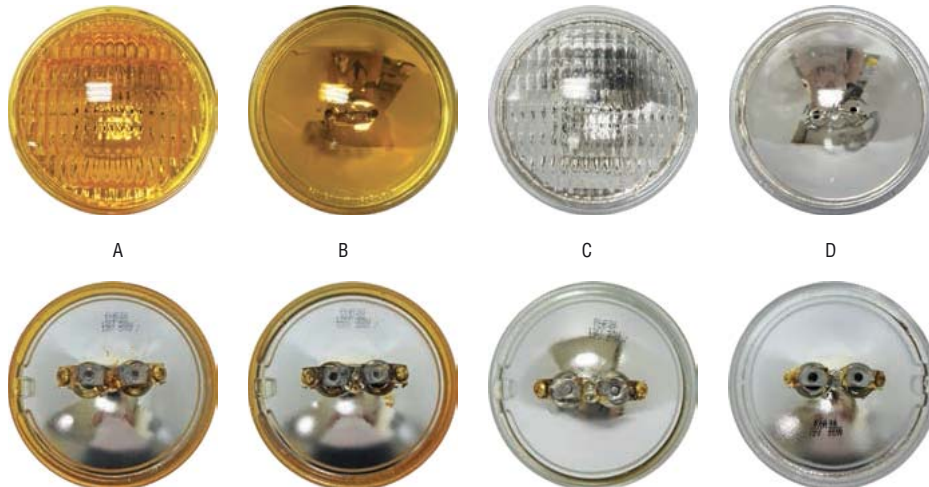

PIAA Corporation was established in 1963 with the commitment to manufacture world-class products that customers could use with pride and confidence. Today, PIAA upholds that commitment by combining market driven concepts with the latest technology to make night and inclement weather driving as safe as possible.



x

**LP270 SERIES LED DRIVING LIGHT KIT**



Description	WPS#
270 LED - 2 Lamp Kit	602-73272

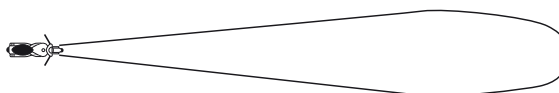

x

**BILLET MOUNTING BRACKETS**



Description	Black	Chrome
7/8" - 1 1/4"	602-74000	602-74005
1 1/2" - 1 3/4"	602-74004	

WINDSHIELDS / FAIRINGS

AUDIO / COMMUNICATION

SEATS / LUGGAGE

BAR / MIRRORS / CONTROLS

EXHAUST

AIR / FUEL SYSTEMS

ENGINE

TRANSMISSION / DRIVELINE

GASKETS / SEALS

ELECTRICAL

**LIGHTING**

CABLES

BRAKES

OIL FILTERS

SUSPENSION

BODY

WHEELS

TIRES / TIRE ACC.

BIKE ACC.

VICTORY / INDIAN

COVERS / LOCKS / TIEDOWNS

CHEMICALS

TOOLS

HELMETS

HELMET ACC.

EYEWEAR

APPAREL / RIDER ACC.

PROMOTIONAL

REFERENCE

INDEX



- WINDSHIELDS / FAIRINGS
- AUDIO / COMMUNICATION
- SEATS / LUGGAGE
- BARS / MIRRORS / CONTROLS
- EXHAUST
- AIR / FUEL SYSTEMS
- ENGINE
- TRANSMISSION / DRIVELINE
- GASKETS / SEALS
- ELECTRICAL
- LIGHTING**
- CABLES
- BRAKES
- OIL FILTERS
- SUSPENSION
- BODY
- WHEELS
- TIRES / TIRE ACC.
- BIKE ACC.
- VICTORY / INDIAN
- COVERS / LOCKS / TIEDOWNS
- CHEMICALS
- TOOLS
- HELMETS
- HELMET ACC.
- EYEWEAR
- APPAREL / RIDER ACC.
- PROMOTIONAL
- REFERENCE
- INDEX

## H.I.D. LIGHT KITS

- Replaces stock headlight bulb
- Super bright for night time driving
- Uses less current draw than an oem bulb
- Small ballast for quick and easy install
- Plug and play, available in white or blue
- 1 Light/1 ballast to each kit
- Full 2 year replacement warranty
- Replacement bulbs available

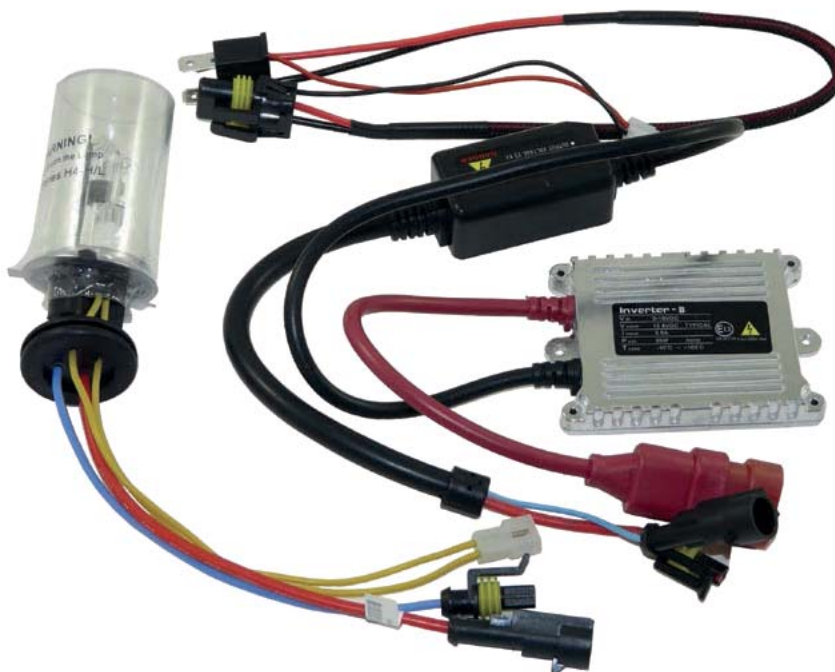

Bulb Type	White	Blue
<b>H.I.D. LIGHT KITS 35 WATT</b>		
H4 Halogen Hi/HID Low	<b>621-9010W</b>	<b>621-9010BU</b>
H4 HID Hi/Lo	<b>621-9015W</b>	<b>621-9015BU</b>
H7	<b>621-9011W</b>	<b>621-9011BU</b>
H9	<b>621-9012W</b>	<b>621-9012BU</b>
H11	<b>621-9013W</b>	<b>621-9013BU</b>
H13	<b>621-9017W</b>	<b>621-9017BU</b>
9005	<b>621-9014W</b>	<b>621-9014BU</b>
<b>REPLACEMENT BULBS</b>		
H4 Halogen Hi/HID Low	<b>621-9020W</b>	<b>621-9020BU</b>
H4 HID Hi/Lo *	<b>621-9027W</b>	<b>621-9027BU</b>
H7	<b>621-9021W</b>	<b>621-9021BU</b>
H9	<b>621-9022W</b>	<b>621-9022BU</b>
H11	<b>621-9023W</b>	<b>621-9023BU</b>
H13	<b>621-9028W</b>	<b>621-9028BU</b>
9005	<b>621-9024W</b>	<b>621-9024BU</b>
<b>REPLACEMENT PARTS</b>		
Wiring Harness w/relay		<b>621-9026</b>
Capacitor (use if HID flickers)		<b>621-9025</b>

\* Not suitable as a replacement for H4 Halogen Hi/HID low replacement bulb





**SILVER-LUX LED HEADLIGHT BULBS**

- Custom designed aluminum tower
- High power Phillips Lumileds with 4000 lumens light output on dual filament high-beam operation
- Clockable collar, allows for adjustment of the light beam
- Features Putco's patented 100% copper weave cloth heat sink
- Fully enclosed driver and harness assembly
- 2 Year warranty

Bulb	WPS#
H4	12-7860
H7	12-7861
H9/H11	12-7862
H13	12-7863
9005	12-7864
9006	12-7865
9007	12-7866



**PASSING LAMP BULB**



- These bulbs draw less than 1 amp, but they are amazingly bright!
- More visible either day or night
- They run extremely cool compared to your stock bulbs
- Your passing lights will have a nice clean look instead of the yellow tones of the standard stock bulbs
- Direct LED replacement for H-D # 68348-05

Description	WPS#
'06-Up H-D models w/ passing lamps	226-0001

**REPLACEMENT BULBS**



226-0002

226-0003

- Easily replace stock to LED
- Instant intensity
- Powered by Cree LED
- These are one of the best and brightest LED bulbs you can buy
- Impressive lighting output compared to your stock lights!
- Increase your visibility to other drivers/riders
- Lower the electric load on your alternator and battery
- Increase the life span of your lights



Amber  
226-0004

Red  
226-0005

Amber  
226-0025

Red  
226-0006

Red  
226-0020

Amber  
226-0021

Description	WPS#
T10/194	226-0002
H3	226-0003
1156 Amber	226-0004
1157 Red	226-0005
1157 Amber	226-0025
3157 Red	226-0006
7443/7440 Red	226-0020
7443/7440 Amber	226-0021

WINDSHIELDS / FAIRINGS

AUDIO / COMMUNICATION

SEATS / LUGGAGE

BARS / MIRRORS / CONTROLS

EXHAUST

AIR / FUEL SYSTEMS

ENGINE

TRANSMISSION / DRIVELINE

GASKETS / SEALS

ELECTRICAL

**LIGHTING**

CABLES

BRAKES

OIL FILTERS

SUSPENSION

BODY

WHEELS

TIRES / TIRE ACC.

BIKE ACC.

VICTORY / INDIAN

COVERS / LOCKS / TIEDOWNS

CHEMICALS

TOOLS

HELMETS

HELMET ACC.

EYEWEAR

APPAREL / RIDER ACC.

PROMOTIONAL

REFERENCE

INDEX

- WINDSHIELDS / FAIRINGS
- AUDIO / COMMUNICATION
- SEATS / LUGGAGE
- BARS / MIRRORS / CONTROLS
- EXHAUST
- AIR / FUEL SYSTEMS
- ENGINE
- TRANSMISSION / DRIVELINE
- GASKETS / SEALS
- ELECTRICAL
- LIGHTING**
- CABLES
- BRAKES
- OIL FILTERS
- SUSPENSION
- BODY
- WHEELS
- TIRES / TIRE ACC.
- BIKE ACC.
- VICTORY / INDIAN
- COVERS / LOCKS / TIEDOWNS
- CHEMICALS
- TOOLS
- HELMETS
- HELMET ACC.
- EYEWEAR
- APPAREL / RIDER ACC.
- PROMOTIONAL
- REFERENCE
- INDEX



## HEADLIGHT LED BULB UPGRADE KITS



- Take the guesswork out of upgrading your headlight bulbs to LED
- Passive cooling heat sink
- Plug & play
- Ultra bright Hi/Lo beam LEDs
- Low amp draw
- 6000K color temperature with 4000 Lumens

Description	Application	WPS#
Headlight LED Bulb Upgrade Kit	Road Glide Models '98-13	226-0091
	Fat Bob Models '08-17	226-0090



## HIGH PERFORMANCE TRI-LED BULBS

New Generation LED's are here and it's easier than ever to replace the yellow dull stock headlight on your bike!

- Plug N Play and easy installation
- These bulbs are very bright and they put out some serious light, over 2000 lumens
- Drawing only a few amps and no ballasts required, it plugs directly into your bike's power connector
- Available in H4/H7/H11/H13 applications
- 226-0008 is recommended for 2014 H-D touring models that have a dual top and bottom head lamp system
- Color temp: 6000K
- 36W low power draw

Description	WPS#
H4 LED w/ fan heatsink	226-0007
H11 LED w/ fan heatsink	226-0008
H7 LED w/ fan heatsink	226-0009
H13 LED w/ fan heatsink	226-0010





## PERFORMANCE LED PASSIVE HEAT SINK

- Plug N Play
- This high performance LED headlamp is the closest LED replacement of an incandescent bulb but benefits in LED technology
- Low Power/AMP draw, Ultra bright white and about 2-3x better lighting coverage compared to your stock bulbs
- LO/HI BEAM - 2000/3000 LUMENS per bulb
- Available in H4 and H11 fits

Description	WPS#
H4 LED w/ fanless heatsink	<b>226-0022</b>
H4 LED w/ fanless heatsink (pair) *	<b>226-0023</b>
H11 LED w/ fanless heatsink	<b>226-0024</b>

\*Recommended for Road Glide models



A



B



C

## RUGGED FANLESS LED BULBS

- 4000 Lumens (SFS bulbs)
- H11 is a perfect fit for V-Rod models equipped with H11 bulb and '14-Up touring models that have a dual top and bottom headlight system
- Drop In Replacement Led Bulb
- Color temp 6500K
- Low AMP draw

Description	WPS#
A H4 Fanless LED bulb	<b>226-0038</b>
B H7 Fanless LED bulb	<b>226-0039</b>
C H11 Fanless LED bulb	<b>226-0037</b>
D H13 Fanless LED bulb	<b>226-0040</b>



D

- WINDSHIELDS / FAIRINGS
- AUDIO / COMMUNICATION
- SEATS / LUGGAGE
- BARS / MIRRORS / CONTROLS
- EXHAUST
- AIR / FUEL SYSTEMS
- ENGINE
- TRANSMISSION / DRIVELINE
- GASKETS / SEALS
- ELECTRICAL
- LIGHTING**
- CABLES
- BRAKES
- OIL FILTERS
- SUSPENSION
- BODY
- WHEELS
- TIRES / TIRE ACC.
- BIKE ACC.
- VICTORY / INDIAN
- COVERS / LOCKS / TIEDOWNS
- CHEMICALS
- TOOLS
- HELMETS
- HELMET ACC.
- EYEWEAR
- APPAREL / RIDER ACC.
- PROMOTIONAL
- REFERENCE
- INDEX



OEM STYLE REPLACEMENT BULBS

**GREATER PERFORMANCE:** PIAA bulbs are engineered with XTRA Technology for greater performance per watt than any other bulb on the road. (XTRA is a term coined by PIAA to designate a high-efficiency bulb that is designed to produce greater light output than its rated power consumption, i.e. 55W = 85W of light output.) Greatly enhance your ability to see and be seen. A metal bond holds the heat-resistant glass tube securely to prevent cracks and leaks. A welded focus ring and one-piece filament support assures proper positioning.

**BRILLIANT COLOR:** Beam color affects visibility and eye strain over long periods. The brilliant white/blue light allows comfortable night driving over extended periods of time. PIAA bulbs are both a performance upgrade and an aesthetic enhancement. You will see the difference even in the daytime.

**WARRANTY AND SUPPORT:** PIAA is so confident in the durability and reliability of our products that we offer a no questions asked, replacement of any halogen bulb that fails within one year of purchase. PIAA bulbs are an investment in safety and peace of mind.

**Super Plasma GT-X** - The Super Plasma GT-X bulbs offer an unmatched combination of fashion and performance with a bluish-purple color very similar to H.I.D. and the closest yet to sunlight.

**Xtreme White / Xtreme White Plus / Xtreme Plus Hybrid** - The Xtreme White Series of bulbs have a cool white light output that gives the driver better color recognition on depth perception and better contrast than stock halogen lamps. The blue top coat on this series of bulbs adds a slight blue tint to a lamp with no loss of performance.

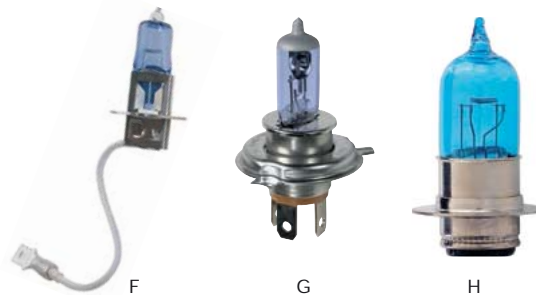

Type	Description	Watts	WPS#
A 881	Xtreme White Plus 4000K	27W	602-70821
A 881	Xtreme White Plus 4000K	27W	602-70822
B 1157	Xtreme White	27/8 W	602-72720
C 9005	Xtreme White 4150K	60 W	602-71556
C 9005	Xtreme White 4150K	60 W	602-19605
D HS1	Xtreme White 4150K	35/35 W	602-70473
E H1	Xtreme White 4150K	55 W	602-70165
F H3	Xtreme White 4150K	35 W	602-70323
F H3	Xtreme White 4150K	55 W	602-70325
F H3	Xtreme White Hybrid 3900K	55 W	602-70103
G H4	Super Plasma GT-X 5000K	60/55	602-70476
G H4	Xtreme White 4150K	60/55 W	602-70456
G H4	Xtreme White 4150K	60/55 W	602-70856
G H4	Xtreme White Hybrid 3900K	60/55 W	602-70104
H H6M	Xtreme White 4150K	35/35 W	602-70023
I H7	Xtreme White Plus 4000K	55 W	602-70755
I H7	Xtreme White Hybrid 3900K	55 W	602-70107
J H8	Xtreme White 4150K	35W	602-70853
K H9	Xtreme White 4150K	65 W	602-70955
K H9	Xtreme White Hybrid 3900K	65 W	602-70109
L H11	Xtreme White Hybrid 3900K	55 W	602-70111
L H11	Xtreme White Plus 4000K	55 W	602-70555
M H13	Xtreme White Plus 4000K	65/55 W	602-71856

- WINDSHIELDS / FAIRINGS
- AUDIO / COMMUNICATION
- SEATS / LUGGAGE
- BAR / MIRRORS / CONTROLS
- EXHAUST
- AIR / FUEL SYSTEMS
- ENGINE
- TRANSMISSION / DRIVELINE
- GASKETS / SEALS
- ELECTRICAL
- LIGHTING**
- CABLES
- BRAKES
- OIL FILTERS
- SUSPENSION
- BODY
- WHEELS
- TIRES / TIRE ACC.
- BIKE ACC.
- VICTORY / INDIAN
- COVERS / LOCKS / TIEDOWNS
- CHEMICALS
- TOOLS
- HELMETS
- HELMET ACC.
- EYEWEAR
- APPAREL / RIDER ACC.
- PROMOTIONAL
- REFERENCE
- INDEX

# HALOGEN BULBS



- Putco Night White Pure Halogen bulbs in 3250 Kelvin (DOT approved) offer a whiter color output than OEM with a longer light beam that increases safety, style and performance. They feature a heavy duty filament and German quartz glass
- Putco Ion Spark White Pure halogen bulbs in 3800 Kelvin (DOT approved) offer vastly improved light output over OEM headlight bulbs

- Putco Nitro Blue Pure halogen bulbs in 6000 Kelvin (non DOT approved) offer a rich, blue color for those that want that custom look

- These bulbs improve driver awareness and are a direct replacement to your factory headlight or auxiliary bulbs

- Lifetime Guarantee\*

- Constructed of the highest grade materials

- Sold each



\* Putco's warranty is for the original purchaser of the product and specifically excludes defects resulting from misuse, abuse, neglect, alteration, modification, improper installation, unauthorized repairs, submersion, theft, vehicle crash, or by any other type of impact.

Bulb Type	Mirror White	Nitro Blue
A H1 55 Watt		<b>12-7800B</b>
B H3 55 Watt	<b>12-7801M</b>	<b>12-7801B</b>
C H4 60/55 Watt	<b>12-7802M</b>	<b>12-7802B</b>
D H7 55 Watt	<b>12-7803M</b>	<b>12-7803B</b>
E H8 35 Watt	<b>12-7804M</b>	<b>12-7804B</b>
F H9 65 Watt	<b>12-7805M</b>	<b>12-7805B</b>
G H10 42 Watt	<b>12-7806M</b>	<b>12-7806B</b>
H H11 55 Watt	<b>12-7807M</b>	<b>12-7807B</b>
I H12 55 Watt	<b>12-7808M</b>	<b>12-7808B</b>
J H13 60/55 Watt	<b>12-7809M</b>	<b>12-7809B</b>
K 880 27 Watt	<b>12-7813M</b>	<b>12-7813B</b>
L 881 27 Watt	<b>12-7814M</b>	<b>12-7814B</b>
M 886 50 Watt		<b>12-7815B</b>
N 893 37.5 Watt	<b>12-7816M</b>	<b>12-7816B</b>
O 9004 65/45 Watt	<b>12-7817M</b>	<b>12-7817B</b>
P 9005 65 Watt	<b>12-7818M</b>	<b>12-7818B</b>
Q 9006 55 Watt	<b>12-7819M</b>	<b>12-7819B</b>
R 9007 65/55 Watt	<b>12-7820M</b>	<b>12-7820B</b>



- WINDSHIELDS / FAIRINGS
- AUDIO / COMMUNICATION
- SEATS / LUGGAGE
- BAR / MIRRORS / CONTROLS
- EXHAUST
- AIR / FUEL SYSTEMS
- ENGINE
- TRANSMISSION / DRIVELINE
- GASKETS / SEALS
- ELECTRICAL
- LIGHTING**
- CABLES
- BRAKES
- OIL FILTERS
- SUSPENSION
- BODY
- WHEELS
- TIRES / TIRE ACC.
- BIKE ACC.
- VICTORY / INDIAN
- COVERS / LOCKS / TIEDOWNS
- CHEMICALS
- TOOLS
- HELMETS
- HELMET ACC.
- EYEWEAR
- APPAREL / RIDER ACC.
- PROMOTIONAL
- REFERENCE
- INDEX

- WINDSHIELDS / FAIRINGS
- AUDIO / COMMUNICATION
- SEATS / LUGGAGE
- BARS / MIRRORS / CONTROLS
- EXHAUST
- AIR / FUEL SYSTEMS
- ENGINE
- TRANSMISSION / DRIVELINE
- GASKETS / SEALS
- ELECTRICAL
- LIGHTING**
- CABLES
- BRAKES
- OIL FILTERS
- SUSPENSION
- BODY
- WHEELS
- TIRES / TIRE ACC.
- BIKE ACC.
- VICTORY / INDIAN
- COVERS / LOCKS / TIEDOWNS
- CHEMICALS
- TOOLS
- HELMETS
- HELMET ACC.
- EYEWEAR
- APPAREL / RIDER ACC.
- PROMOTIONAL
- REFERENCE
- INDEX

## HALOGEN BULBS

H-4 Bulbs will replace many original equipment headlights in all major brands of bikes. The Heavy Duty bulb is recommended where severe vibration exists.



12-6264



12-1085

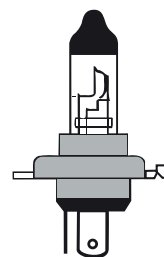

P43 BASE

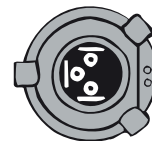

P43 BASE	Description	WPS#
12 volt 35/35w	Heavy duty bulb	<b>12-1085</b>
12 volt 45/45w	ST/1100/GL1500	<b>12-1091</b>
12 volt 55/60w	Standard bulb	<b>12-1070</b>
	Heavy duty bulb	<b>12-1079</b>
	All season	<b>12-6267</b>
	Bright Blue Bulb	<b>12-6270</b>
12 volt 55/100w	Heavy duty bulb	<b>12-6263</b>
12 volt 80/100w	Standard bulb	<b>12-1083</b>
12 volt 90/100w	Heavy duty bulb	<b>12-6265</b>
12 volt 55/100w	Xenon bright blue bulb	<b>12-6264</b>



12-6270



12-6267

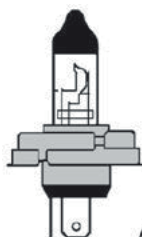

"BA" P45T BASE



"BA" P45T BASE	Description	WPS#
12 volt 55/60w	Heavy duty bulb	<b>12-6361</b>
12 volt 90/100w	Heavy duty bulb	<b>12-6364</b>

## H6M / H-7 / H-9 / H-11 BULBS

Type	Base	Description	Sold	WPS#
H6M	P15D-1	12 volt 30/30w Standard bulb	10 pk	<b>12-6030</b>
H-7	PX26d	12 volt 55w Long Life bulb	Each	<b>12-6260</b>
		Bright Blue bulb	Each	<b>12-6261</b>
		+50% Brighter bulb	Each	<b>12-6262</b>
H-9	PGJ19-5	12 volt 65w Standard bulb	Each	<b>12-1077</b>
H-11	PGJ19-2	12 volt 55w Long life bulb	Each	<b>12-1082</b>



12-1082



12-6260



12-1077



## HALOGEN HEADLAMPS

Designed specifically to meet the unique requirements of the motorcycle rider. Available in four popular sizes, these remarkable lamps combine a dual filament H-4 halogen bulb with a precision-built optical unit creating the ultimate in lighting safety and performance. Direct plug-in, no additional wiring required to replace the sealed beam in motorcycles, snowmobiles, cars, pickups and off-road vehicles using GE sealed beam numbers listed below.

Application	Description	Replaces	WPS#
FX Softail, Dyna and Sportster models	5 3/4" Round	GE4492	<b>12-1072</b>
Touring (except FLTR), and FL Softail models	7" Round	GE6014	<b>12-1078</b>

All are 12 volt 55/60w  
COMPLETE WITH BULB

## SEALED BEAMS



Description	WPS#
GE 4492, 60 watt, 12 volt, 5 3/4" diameter.	<b>12-1061</b>
GE 4431, 45/35 watt, 12 volt, 5 3/4" diameter.	<b>12-1062</b>
GE H4467, 50/35 watt halogen, 12 volt, 5 3/4" diameter.	<b>12-1105</b>
GE 4449, 30 watt, 12 volt, 4 1/2" diameter passing lamp	<b>12-1100</b>
GE 4415, 35 watt, 12 volt, 4 1/2" diameter fog/passing lamp	<b>12-1101</b>
GE 4415A, 35 watt, 12 volt, 4 1/2" diameter fog/passing lamp (amber)	<b>12-1102</b>
GE 4440, 40/40 watt, 12 volt, 4 1/2" diameter headlamp	<b>12-1103</b>
GE 4454, 60/60 watt, 12 volt, 4 1/2" diameter headlamp	<b>12-1104</b>

## REPLACEMENT BULBS

MOST BULBS SOLD IN BOXES OF 10 ONLY  
ORDER OF 1 = 10 BULBS

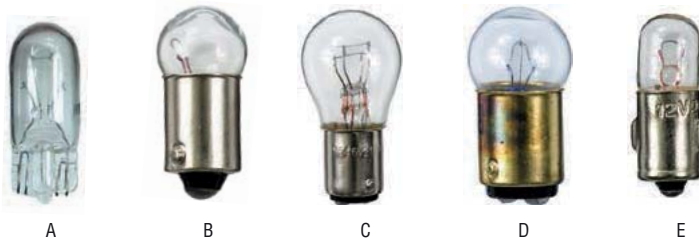

Base	Replaces	Volts/Watts	Contact	WPS#	Sold in
A	194	12v/4CP	Wedge	<b>12-1080</b>	10 pak
B	A62	6v/3w	Single	<b>12-6406</b>	10 pak
	A72	12v/3w	Single	<b>12-6408</b>	10 pak
	57, 1895	12v/2CP	Single	<b>12-1074</b>	10 pak
	A4527/1156	12v/25w(32CP)	Single	<b>12-6607</b>	10 pak
C	A4813	6v/5/20w	Double	<b>12-6606</b>	10 pak
	1157 Universal Tail/Stop	12v/32-4CP	Double	<b>12-1081</b>	10 pak
D	90	12v/6CP	Double	<b>12-6400</b>	10 pak
E	A745 1272J	12v/2w	Single	<b>12-1095</b>	10 pak
F	A7028, 6245J	12v/45-45w	Double	<b>12-1064</b>	10 pak
G	1156 Red Turn Signal	12v/24CP	Single	<b>12-6608</b>	10 pak
H	1156 Amber Turn Signal	12v/24CP	Single	<b>12-6610</b>	10 pak
I	1157 Red Stop/Tail	12v/24CP	Double	<b>12-6609</b>	10 pak
J	1157 Amber Stop/Tail	12v/24CP	Double	<b>12-6611</b>	10 pak

Photos are not actual size.  
OEM #s are for reference only.

- WINDSHIELDS / FAIRINGS
- AUDIO / COMMUNICATION
- SEATS / LUGGAGE
- BAR / MIRRORS / CONTROLS
- EXHAUST
- AIR / FUEL SYSTEMS
- ENGINE
- TRANSMISSION / DRIVELINE
- GASKETS / SEALS
- ELECTRICAL
- LIGHTING**
- CABLES
- BRAKES
- OIL FILTERS
- SUSPENSION
- BODY
- WHEELS
- TIRES / TIRE ACC.
- BIKE ACC.
- VICTORY / INDIAN
- COVERS / LOCKS / TIEDOWNS
- CHEMICALS
- TOOLS
- HELMETS
- HELMET ACC.
- EYEWEAR
- APPAREL / RIDER ACC.
- PROMOTIONAL
- REFERENCE
- INDEX

- WINDSHIELDS / FAIRINGS
- AUDIO / COMMUNICATION
- SEATS / LUGGAGE
- BARS / MIRRORS / CONTROLS
- EXHAUST
- AIR / FUEL SYSTEMS
- ENGINE
- TRANSMISSION / DRIVELINE
- GASKETS / SEALS
- ELECTRICAL
- LIGHTING**
- CABLES
- BRAKES
- OIL FILTERS
- SUSPENSION
- BODY
- WHEELS
- TIRES / TIRE ACC.
- BIKE ACC.
- VICTORY / INDIAN
- COVERS / LOCKS / TIEDOWNS
- CHEMICALS
- TOOLS
- HELMETS
- HELMET ACC.
- EYEWEAR
- APPAREL / RIDER ACC.
- PROMOTIONAL
- REFERENCE
- INDEX



## PLUG & PLAY HEADLIGHT MODULE

- Modulator pulses headlight for extra daytime visibility
- Features Heads Up Alert; pressing horn button makes headlight flash 3 times
- Surge protected, auto night shut-Off
- Compact size - 2 1/4" long X 1 5/8" wide X 5/8" high
- Weather Resistant Heat Sink Case
- 1-Year Warranty

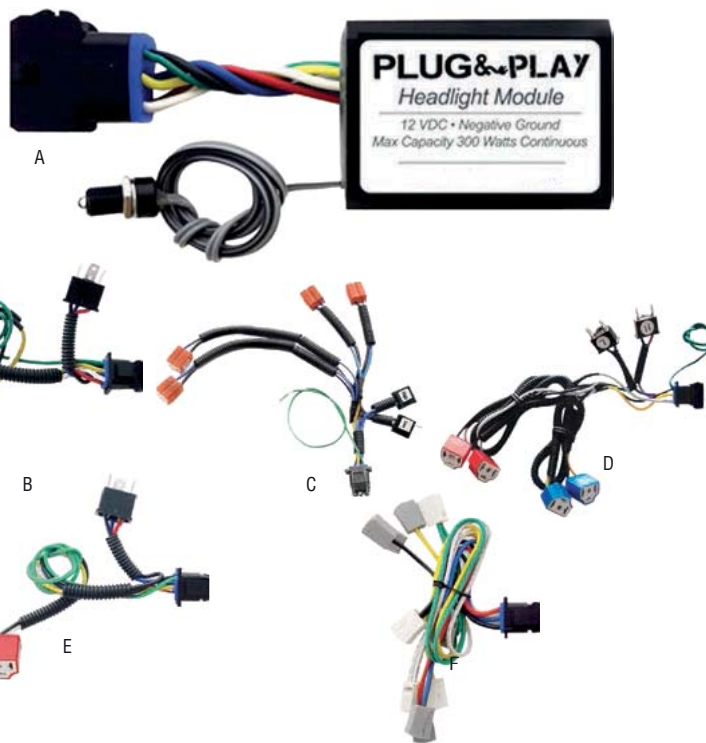

	Description	WPS#
A	Diamond Star headlight modulator	28-01015
B	Plug & Play H4 Dual adapter	28-01080
C	Plug & Play H7 Dual adapter	28-01081
D	Plug & Play H7 Single adapter	28-01082
E	Plug & Play H4 Single adapter	28-01083
F	Plug & Play universal harness	28-01084

## TRI-STAR TAIL LIGHT MODULE

The Tri-Star module converts the rear turn signal lights to function as brake and turn signal lights. When the brakes are applied, the turn signal lights illuminate. If a turn signal is applied, it has priority over the brake light function on the side that is selected. If the turn signal is canceled and the brakes are still applied, the brake light function of the turn signal lights illuminate steady on.

- Adds brake light function to existing turn signals
- Weather proof solid-state electronic components.
- Dimension: 2 1/4" L x 1 5/8" W x 5/8" H
- Mounting: Secure to flat surface with double sided VHB tape (included).
- NOTE: If your bike does not have a variable load turn signal flasher, a Dual Load Equalizer will be needed for this installation.



WPS#  
28-01006

## TRI-STAR XP TAIL LIGHT MODULE

- The Tri-Star XP module converts the rear turn signal lights to function as brake and turn signal lights...and now has running light capabilities!
- When the brakes are applied, the turn signal lights illuminate. If a turn signal is applied, it has priority over the brake light function on the side that is selected. If the turn signal is canceled and the brakes are still applied, the brake light functions of the turn signal lights illuminate steady on.
- Adds brake light function to existing turn signals
- Dimension: 2 1/4" L x 1 5/8" W x 5/8" H
- Mounting: Secure to flat surface with double sided VHB tape (included).
- Weather proof solid-state electronic components
- NOTE: If your bike does not have a variable load turn signal flasher, the included Dual Load Equalizer will be needed for this installation.



WPS#  
28-01016



WINDSHIELDS / FAIRINGS  
 AUDIO / COMMUNICATION  
 SEATS / LUGGAGE  
 BARS / MIRRORS / CONTROLS  
 EXHAUST  
 AIR / FUEL SYSTEMS  
 ENGINE  
 TRANSMISSION / DRIVELINE  
 GASKETS / SEALS  
 ELECTRICAL  
**LIGHTING**  
 CABLES  
 BRAKES  
 OIL FILTERS  
 SUSPENSION  
 BODY  
 WHEELS  
 TIRES / TIRE ACC.  
 BIKE ACC.  
 VICTORY / INDIAN  
 COVERS / LOCKS / TIEDOWNS  
 CHEMICALS  
 TOOLS  
 HELMETS  
 HELMET ACC.  
 EYEWEAR  
 APPAREL / RIDER ACC.  
 PROMOTIONAL  
 REFERENCE  
 INDEX

## SELF-CANCELING TURN SIGNAL MODULE



- Three turn signal timing modes - self canceling + hazard mode – non self-canceling.
- Non-Load Dependent Flash Duration - flash time constant whether using incandescent or LED lighting
- Weather proof solid-state electronic components - potted with soft cell technology to prevent wire chaffing and damage.
- Four unique turn signal modes of operation
- Mounting: Secure to flat surface with double sided VHB tape (included).
- Dimension: 2 1/4" L x 1 5/8" W x 5/8" H

Note: This unit will not work on bikes that have the left and right turn signal switch built into one unit that you must push to cancel.

**WPS#**

**28-01501**

## PENTA-STAR TAIL LIGHT MODULE



- The Penta-Star™ module combines all of the functions of the Self-Canceling Turn Signal Module and the Tri-Star Module
- Three turn signal timing Modes - Self Canceling non-load dependent flash duration: all three modes are flash time constant whether using incandescent or LED lighting
- Five unique turn signal modes of operation
- Hazard Mode – Non self-canceling
- Adds brake light function to turn signals
- Designed for use with individual momentary type turn signal switches mounted on the left and right handle bars
- Weather proof dependable solid-state electronic components
- Dimension: 2 1/4" L x 1 5/8" W x 5/8" H Mounting: Secure to flat surface with double sided VHB tape (included).

**WPS#**

**28-01007**

## PENTA-STAR XP MODULE



- This module combines all of the functions of the Self-Canceling Turn Signal Module and the Tri-Star Module ... and now has running lights capabilities!!!
- Three turn signal timing modes – self-canceling
- Five Unique Turn Signal Modes of Operation
- Hazard mode – Non self-canceling
- Adds brake light function to turn signals
- Non-load dependent flash duration: all three modes are flash time constant whether using incandescent or LED lighting
- Voltage: 12 VDC, Negative Ground. Max Load Capacity: 6 amps per left or right channel.
- Dimension: 2 1/4" L x 1 5/8" W x 5/8" H
- Mounting: Secure to flat surface with double sided VHB tape (included).
- Weather Proof Dependable Solid-state electronic components.

**WPS#**

**28-01017**

Note: This unit will not work on bikes that have the left and right turn signal switch built into one unit that you must push to cancel.

- WINDSHIELDS / FAIRINGS
- AUDIO / COMMUNICATION
- SEATS / LUGGAGE
- BAR / MIRRORS / CONTROLS
- EXHAUST
- AIR / FUEL SYSTEMS
- ENGINE
- TRANSMISSION / DRIVELINE
- GASKETS / SEALS
- ELECTRICAL
- LIGHTING**
- CABLES
- BRAKES
- OIL FILTERS
- SUSPENSION
- BODY
- WHEELS
- TIRES / TIRE ACC.
- BIKE ACC.
- VICTORY / INDIAN
- COVERS / LOCKS / TIEDOWNS
- CHEMICALS
- TOOLS
- HELMETS
- HELMET ACC.
- EYEWEAR
- APPAREL / RIDER ACC.
- PROMOTIONAL
- REFERENCE
- INDEX



## DUAL-LOAD EQUALIZER

- The Dual Load Equalizer is designed to correct the issue of turn signals flashing too quickly or not at all. It does this by adding back the load to your mechanical flasher relay that was removed by converting stock incandescent turn signals to LED's
- Dependable weather proof Solid-state electronic components
- Dimensions: 2 1/4" L x 1 5/8" W x 5/8" H
- One equalizer per set of lights



**WPS#**

**28-01008**

## HEADS UP VOLTAGE MONITOR

- This module is a micro-processor that monitors the output of the charging system and is accurate to within 200 milli-volts. The Heads-Up Voltage Monitor's™ onboard microprocessor performs a self-test each time voltage is applied.. Additionally, you will be notified of serious fault conditions by an attention-getting flash of the LED.
- The single, multi-color LED (red-amber-green) visually indicates the state of your motorcycle's battery / charging system. At a glance, you will instantly know whether the voltage is normal or abnormal. Auto-dimming - after 8 seconds at a single voltage, the LED intensity is lowered to 50%
- Voltage Range: 6 to 17 VDC, Accuracy: within 200 millivolts, Amp Draw: 20–85 milli-amps.
- Dimension: 2 1/4" L x 1 5/8" W x 5/8" H



**WPS#**

**28-01050**

## THE ORIGINAL BACKOFF™

- Compact solid state module converts your ordinary brake light into an attention getting visual alerting device, more visibility and conspicuity when you are stopped or stopping
- With BackOFF installed, when you apply your brakes, it causes your brake light to automatically emit a visual alerting signal of 3 short light flashes, followed by 1 steady on light condition of 3.5 seconds
- Signal automatically repeats itself as long as the brakes are applied
- Compact size. - 2-1/4"L x 1-5/8"W x 5/8"H
- 12v DC, 10A max



**WPS#**

**28-01001**



WPS#  
 28-01020

**BACKOFF™ BRAKE HOLD MODULE**

- The Brake Hold Module connects to your bike's electronic speed pick-up sensor (will not work with cable driven speedometers); to keep your brake lights on when you release your brakes but are still decelerating
- Mode #1: Emits a visual signal of 3 short light flashes, followed by 1 long light flash (3.5 seconds). The signal automatically repeats itself as long as the brake lights are on. Mode #2: Emits a visual signal of 5 quick flashes, followed by a steady on light that remains steady as long as the brake lights are on
- 12 volts DC - Maximum Capacity: 10 Amps (normally up to 3 bulbs)!
- Compact size. - 2-1/4"L x 1-5/8"W x 5/8"H sealed weather resistant heat sink case.
- 1 Year limited warranty
- Your Bike MUST have Electronic Pick-Up Sensor for this module to function



WPS#  
 28-01009

**BACKOFF™ WIG WAG MODULE**

- The Wig-Wag enables your brake lights to alternate back and forth in a wig-wagging pattern.
- This module is specifically designed for use with motorcycle's that are equipped with 2 brake lights located side by side.
- Choice of 2 different modes during installation.
- 12 volts DC, Maximum Capacity 10 Amps!
- Compact size. - 2-1/4"L x 1-5/8"W x 5/8"H sealed weather resistant heat sink case
- Limited Warranty - One Year



WPS#  
 28-01004

**BACKOFF™ XP**

- This module converts your ordinary brake lights into your choice of two attention getting visual alerting signals when you apply your brakes:
- Mode #1: Emits a visual signal of 4 short light flashes, followed by 1 long light flash (3.5 seconds). The signal automatically repeats itself as long as the brakes are applied. Mode #2: Emits a visual signal of 5 short flashes, followed by a steady on light that remains steady on as long as the brakes are applied
- Compact - 2-1/4"L x 1-5/8"W x 5/8"H sealed weather resistant heat sink case
- 12 volts DC, 10A max capacity
- Limited Warranty - One Year
- NOTE: This module is rated at 10 Amps which will only drive 3 - 1156/1157 bulbs. Please DO NOT install any BackOFF Brake Light product on your turn signals, it is illegal and also confusing to following vehicles.

WINDSHIELDS / FAIRINGS  
 AUDIO / COMMUNICATION  
 SEATS / LUGGAGE  
 BARS / MIRRORS / CONTROLS  
 EXHAUST  
 AIR / FUEL SYSTEMS  
 ENGINE  
 TRANSMISSION / DRIVELINE  
 GASKETS / SEALS  
 ELECTRICAL  
**LIGHTING**  
 CABLES  
 BRAKES  
 OIL FILTERS  
 SUSPENSION  
 BODY  
 WHEELS  
 TIRES / TIRE ACC.  
 BIKE ACC.  
 VICTORY / INDIAN  
 COVERS / LOCKS / TIEDOWNS  
 CHEMICALS  
 TOOLS  
 HELMETS  
 HELMET ACC.  
 EYEWEAR  
 APPAREL / RIDER ACC.  
 PROMOTIONAL  
 REFERENCE  
 INDEX

- WINDSHIELDS / FAIRINGS
- AUDIO / COMMUNICATION
- SEATS / LUGGAGE
- BARS / MIRRORS / CONTROLS
- EXHAUST
- AIR / FUEL SYSTEMS
- ENGINE
- TRANSMISSION / DRIVELINE
- GASKETS / SEALS
- ELECTRICAL
- LIGHTING**
- CABLES
- BRAKES
- OIL FILTERS
- SUSPENSION
- BODY
- WHEELS
- TIRES / TIRE ACC.
- BIKE ACC.
- VICTORY / INDIAN
- COVERS / LOCKS / TIEDOWNS
- CHEMICALS
- TOOLS
- HELMETS
- HELMET ACC.
- EYEWEAR
- APPAREL / RIDER ACC.
- PROMOTIONAL
- REFERENCE
- INDEX



## SMART BRAKE LIGHT MODULE

New safety technology designed to reduce rear end collisions! GearBrake detects when you decelerate even in instances of downshifting and engine braking where the brake is not applied, automatically lighting your taillight with a flashing alert!

- Dimensions: 2.08 x 1.28 x 0.45 inches (L x W x H)
- Max Current: 10 amps
- Voltage: 12V DC
- Limited lifetime warranty
- Proudly made in the USA
- Flashes for 2 seconds then turns solid until you release the brake



Description	WPS#
Flashing	<b>28-03100</b>
Non-Flashing	<b>28-03101</b>

## VECTOR LASER

- Simple installation
- Laser can act as a brake light or running light
- Projects a bright red line on the ground behind you to mark your space in traffic



Description	WPS#
Vector Laser	<b>28-03102</b>



**FUSION LED SYSTEMS**

The most complete way to quickly customize your motorcycle with LEDs, yet not spend a fortune. The Fusion systems eliminate time consuming wiring of LEDs and simply plug into a main control module that can create the wildest flash patterns.

**FUSION MOTORCYCLE LED LIGHTING SYSTEM - STAGE 5 THE SHOW STOPPER**



Fusion LED Systems are the most complete way to quickly customize your motorcycle with LED's, yet not spend a fortune. Our Fusion systems eliminate time consuming wiring of LEDs and simply plug into a main control module that can create the wildest flash patterns. Fusion 21 color LED systems allow you to change colors with the press of a button. Every Fusion system comes with a wireless remote, CPU, LED light strips, and mounting hardware.

- Multi-color, three-zone, six lines, plug-n-play CPU with wireless remote
- 13 Flash Patterns (5 Music / Engine Thump Modes)
- 5 Speed Flash Driver
- 5 Levels of sound sensitivity
- 21 Colors, including million color mode and 7 color mode
- Secondary Power Up Option

Description	WPS #
Stage 5 kit	127-0017
Spare Remote Fob	127-0000



**FUSION MC STAGE 3**

Now we're talking about some serious lighting. Guaranteed to turn some heads, this kit will fully cover mid-weight cruisers and sport bikes. Whether you want to light up your Suzuki GSXR, Harley-Davidson Fat Boy, or any bike of similar size this kit is right for you. Fusion 21 color system allows you to change colors with the press of a button. Features: A multi-color, three-zone, six lines, plug-n-play CPU with wireless remote.

Description	WPS #
Stage 3 kit	127-0016
Spare Remote Fob	127-0000

- 13 Flash Patterns (5 Music / Engine Thump Modes)
- 5 Speed Flash Driver
- 5 Levels of sound sensitivity
- 21 Colors, including million color mode and seven color mode
- Secondary Power Up Option
- CPU and Wireless Remote
- (4) 3" Flex-Tech LED strips
- (6) 5" Flex-Tech LED strips
- (2) 10" Flex-Tech LED strips
- (6) Y-Splitter cables
- Mounting hardware
- Total number of LEDs: 192

- WINDSHIELDS / FAIRINGS
- AUDIO / COMMUNICATION
- SEATS / LUGGAGE
- BARS / MIRRORS / CONTROLS
- EXHAUST
- AIR / FUEL SYSTEMS
- ENGINE
- TRANSMISSION / DRIVELINE
- GASKETS / SEALS
- ELECTRICAL
- LIGHTING**
- CABLES
- BRAKES
- OIL FILTERS
- SUSPENSION
- BODY
- WHEELS
- TIRES / TIRE ACC.
- BIKE ACC.
- VICTORY / INDIAN
- COVERS / LOCKS / TIEDOWNS
- CHEMICALS
- TOOLS
- HELMETS
- HELMET ACC.
- EYEWEAR
- APPAREL / RIDER ACC.
- PROMOTIONAL
- REFERENCE
- INDEX



**FUSION LED SYSTEMS**

**FUSION LED SYSTEM - STAGE 1 HARLEY DAVIDSON**

The absolutely amazing Harley-Davidson Fusion LED Lighting system is designed to be the easiest, most affordable way to light a Harley-Davidson motorcycle from front to rear. The Fusion Stage 1 Harley-Davidson LED system is designed for the non-touring Harley-Davidson motorcycles such as Sportster, V-Rod, Dyna and Softtails.

- Multi-color, three-zone, six lines, plug-n-play CPU with wireless remote
- 13 Flash Patterns (5 Music / Engine Thump Modes)
- 5 Speed Flash Driver
- 5 Levels of sound sensitivity
- 21 Colors, including million color mode and seven color mode
- Secondary Power Up Option

- LED KIT Contains:
- CPU and Wireless Remote
  - (4) 4" Flex-Tech LED strips
  - (4) 15" Flex-Tech LED strips
  - (2) Y-Splitter cables
  - (2) 12" extension cables
  - Mounting hardware



Description	WPS #
Stage 1 Kit- HD	127-0010
Spare Remote Fob	127-0000

**FUSION MC STAGE 1 STARTER KIT**

Here is a great LED kit that is inexpensive and quick to install. Consider the stage one kit if you don't want to go wild (yet). The ideal kit for mild accenting through out your bike, or to explode a single area such as the engine. Add more LED strips at any time.

Fusion systems come in two models: single color or million color systems. Million color systems allow you to change colors with the press of a button. Features: A multi-color, three-zone, six lines, plug-n-play CPU with wireless remote.

- 13 Flash Patterns (5 Music/Engine Thump Modes)
- 5 Speed Flash Driver
- 5 Levels of sound sensitivity
- 21 Colors, including million color mode and seven color mode
- Secondary Power Up Option
- CPU and Wireless Remote
- (2) 3" Flex-Tech LED strips
- (4) 5" Flex-Tech LED strips
- Mounting hardware
- Total number of LEDs: 90



Description	WPS #
Stage 1 Kit	127-0015
Spare Remote Fob	127-0000



**MILLION COLOR FLEX-TECH PODS**



Add more million color pods to your FUSION MC-X6+ system. Pods are 100% waterproof and shock resistant. Each pod comes with four feet of cable and attached connector plug for easy, plug-n-play installation. Million color pods include double-sided adhesive tape for mounting. The double-sided 3M adhesive foam tape is pre-applied to the back of each pod to streamline the installation process. Our

Flex-Tech pods can bend 180 degrees, allowing the pods to flow with the natural curves of your bike. ATTENTION: You will need to purchase one Y-splitter cable for every pod you want to add to a system. For example: if you purchase three additional pods, you also will want to purchase three additional Y-Splitter cables.



**MILLION COLOR FLEX-TECH POD (3")**

Each million color pod has 3 SMD LEDs. Each SMD LED has 7 internal diodes making a total of 21 LEDs per 3" pod. Dimensions: 2.6" long, 1/2" wide, 1/4" high.

**WPS #**

**127-0020**



**MILLION COLOR FLEX-TECH POD (5")**

Each million color pod has six SMD LEDs. Each SMD LED has 7 internal diodes making a total of 42 LEDs per 5" pod. Dimensions: 4.75" long, 1/2" wide, 1/4" high.

**WPS #**

**127-0021**



**MILLION COLOR FLEX-TECH POD (10")**

10", waterproof, flexible LED strip with black PCB. 34" cable with attach plug. Extended 40" cable. 3M red tape applied. 15 of the 5050 SMD style LEDs. LED total: 45

**WPS #**

**127-0022**



**FRONT AND REAR FUSION LED RIM KIT**

LED Rim Lights are here! This is the motorcycle industry's first completely round LED lighting disk designed specifically for adding accent lighting to your motorcycle's wheels or rims. The Fusion Rim Lights plug into the Fusion MC-x6 or MC-x3 controllers and display 21 different colors and will flash in sequence with the existing Fusion LED Lighting System. With 36 LEDs shining outward in a perfect cylindrical pattern you will get an even spread of light on your entire rim. Must have a Fusion LED Kit to run these lights, as they are multi-color and require a controller.

- 72" wire leads for front mount rim lights and 40" cable for rear mounted rim lights
- Light weight black Delrin construction
- Size is .4" thick by 2.25" diameter. Check clearance between brake caliper and wheel spoke to ensure 1/2" of clearance
- Inner brake caliper must be smooth surface for mounting

**WPS #**

**127-0029**



**MILLION COLOR FUSION 24" EXTENSION CABLE**

- 24 inch extension cable for multi-color system. Male plug to female plug.

**WPS #**

**127-0028**



**MILLION COLOR Y-SPLITTER CABLE**

Y-Splitter cables make it easy to add more pods to your FUSION MC-X6 system. Simply attach the splitter cable to the L.E.D. driver (CPU) cable; making each cable capable of driving 2 pods instead of one.

**WPS #**

**127-0026**

WINDSHIELDS / FAIRINGS  
 AUDIO / COMMUNICATION  
 SEATS / LUGGAGE  
 BARS / MIRRORS / CONTROLS  
 EXHAUST  
 AIR / FUEL SYSTEMS  
 ENGINE  
 TRANSMISSION / DRIVELINE  
 GASKETS / SEALS  
 ELECTRICAL  
**LIGHTING**  
 CABLES  
 BRAKES  
 OIL FILTERS  
 SUSPENSION  
 BODY  
 WHEELS  
 TIRES / TIRE ACC.  
 BIKE ACC.  
 VICTORY / INDIAN  
 COVERS / LOCKS / TIEDOWNS  
 CHEMICALS  
 TOOLS  
 HELMETS  
 HELMET ACC.  
 EYEWEAR  
 APPAREL / RIDER ACC.  
 PROMOTIONAL  
 REFERENCE  
 INDEX



## FLEX PRO COLOR CHANGE KIT

- 60 bright color changing LED's
- 10 - 4" Flexible light strips, easily installed anywhere with included 3M tape
- Select from 7 colors or color change modes
- Remote control key chain

Description	WPS#
Flex Pro Kit	12-6770
<b>ACCESSORIES</b>	
Remote	12-6770R
2 Strip Extension	12-6770E
Rim Light Pucks Black	12-6790
Rim Light Pucks Chrome	12-6789



Everything you need to light up your ride!

## PRO KIT

Color	Black	Chrome
Orange		12-67260R
Red	12-6725R	
White	12-6725W	
Yellow	12-6725Y	12-6726Y

**Kits include:** 6 oval electropods (in black or chrome case), 2 9.5" flex light strips, on-off switch, wiring and mounting hardware..



## LIGHT STRIP KITS

**Kits include:** 1 rectangular shaped (six L.E.D.) light strip, wiring, main fuse, and mounting hardware. Works with all 12 volt vehicles. Modular design allows for more than one light strip to be mounted in series.

LED Color	WPS#
Blue	12-6707B
Orange	12-6707OR
Purple	12-6707P

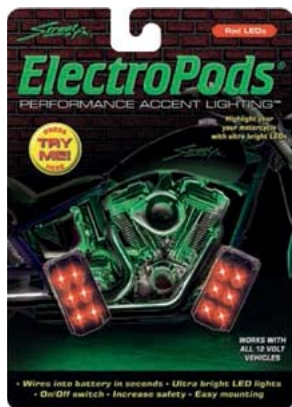

## BOLT-FX

- Bolt anywhere on your motorcycle
- Perfect for license plates
- Stainless steel construction, 5/16" shaft size
- Long lasting L.E.D.'s, sold in pairs

Color	WPS#
Blue	12-6730B



## SCAN PODS

- 6 ultra-bright L.E.D.s with a unique chasing effect
- Wires directly to a 12 volt battery
- Can be easily connected to an alarm system
- Peel and stick application

Color	WPS#
Green	12-6711G

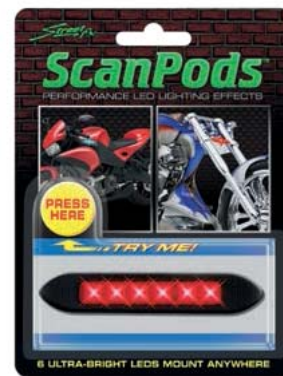





### STEP LIGHTS

*Put the light where you need it!*

**Kits include:** 2 rectangular shaped ultra brite (3 L.E.D.) light pods, wiring, and mounting hardware. Available in black or chrome, works with all 12 volt vehicles.

LED Color	Black	Chrome
Blue		<b>12-6701B</b>
Green	<b>12-6700G</b>	<b>12-6701G</b>
Red		<b>12-6701R</b>

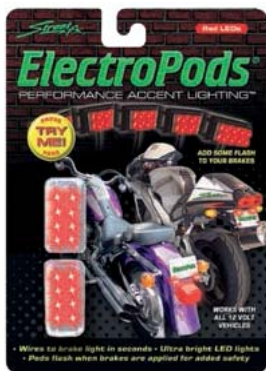

### BRAKE LIGHT KIT

**Kits include:** 2 rectangular shaped (8 L.E.D.) light pods, wiring, main fuse, and mounting hardware. Works with all 12 volt vehicles. Easily connects to existing brake wiring, pods flash red when brakes are applied for added safety. Available in black or chrome.

Finish	WPS#
Black	<b>12-6705</b>
Chrome	<b>12-6706</b>



### FLEX LIGHT STRIPS

9.5" long (24 L.E.D.) flexible light strip, conforms to fit most any surface. Use with your own power switch or any Street FX power module. Sold each.

L.E.D. Color	WPS #
Purple	<b>12-6702P</b>
Yellow	<b>12-6702Y</b>
Multi color	<b>12-6702M</b>



### FLEX LIGHT STRANDS

12" long (15 L.E.D.) flexible light strip, conforms to fit most any surface. Use with your own power switch or any Street FX power module. Sold each

L.E.D. Color	WPS#
Green	<b>12-6704G</b>
Purple	<b>12-6704P</b>
Yellow	<b>12-6704Y</b>

- WINDSHIELDS / FAIRINGS
- AUDIO / COMMUNICATION
- SEATS / LUGGAGE
- BARS / MIRRORS / CONTROLS
- EXHAUST
- AIR / FUEL SYSTEMS
- ENGINE
- TRANSMISSION / DRIVELINE
- GASKETS / SEALS
- ELECTRICAL
- LIGHTING**
- CABLES
- BRAKES
- OIL FILTERS
- SUSPENSION
- BODY
- WHEELS
- TIRES / TIRE ACC.
- BIKE ACC.
- VICTORY / INDIAN
- COVERS / LOCKS / TIEDOWNS
- CHEMICALS
- TOOLS
- HELMETS
- HELMET ACC.
- EYEWEAR
- APPAREL / RIDER ACC.
- PROMOTIONAL
- REFERENCE
- INDEX



## 5MM L.E.D. SPOTLIGHTS

- Four ultra-bright 5mm single L.E.D. spotlights
- Add light anywhere with easy peel and stick application
- Each L.E.D. includes 3 feet of wire

Color	WPS#
Blue	12-6751B
Red	12-6751R
White	12-6751W



## L.E.D. REPLACEMENT BULBS

- Each bulb contains 15 ultra-bright L.E.D.s
- Much less power draw than standard incandescent bulbs
- Available in 1156 and 1157 bulb styles

Base	Red	White	Amber
1156	12-6774R	12-6774W	12-6774A

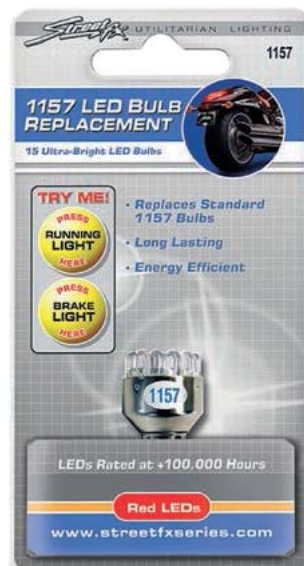

## L.E.D. SUPER CLUSTER REPLACEMENT BULBS

- Ultra-Bright replacement bulb
- 48 long lasting, energy efficient LEDs
- Includes adapter ring

Base	Amber	White
1156	12-6767A	12-6767W

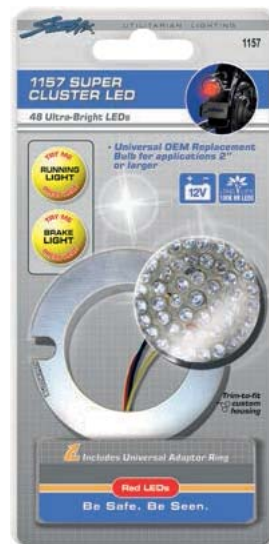

**LIGHTING EFFECTS MODULES**

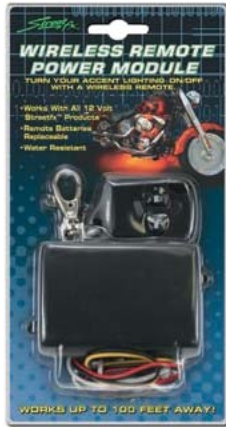

- Multi Function Power Module controls flash speed and brightness of lights. Controls up to 6 lighting accessories
- Power Distribution Module allows you to connect multiple pods to one power source
- Sound FX Sound Reactor module will flash your accessory lights to the sound of you motorcycle or any other outside sound source. Works with any ElectroPod product
- Wireless Remote works with all 12 volt ElectroPod lighting accessories, and allows you to turn your accessory lights on or off from a distance of up to 100 feet

Description	WPS#
Multi Function Power Module	<b>12-6720</b>
Power Distribution Module	<b>12-6721</b>
Sound FX Module	<b>12-6723</b>
Wireless Remote	<b>12-6722</b>
Electrical Noise Filter	<b>12-6724</b>

**TIRE TECHNIX MOTION ACTIVATED WHEEL EFFECTS**



Ballistic



Hex

- Ultra bright motion activated L.E.D. light
- Replaces your existing valve stem cap
- Tire Technix are intended for off highway use only!



Micro

Color	WPS#
<b>A. BALLISTIC</b>	
Blue	<b>12-6715B</b>
Green	<b>12-6715G</b>
Red	<b>12-6715R</b>
6pc. Display	<b>12-6715D</b>
<b>B. HEX</b>	
Blue	<b>12-6716B</b>
Green	<b>12-6716G</b>
Red	<b>12-6716R</b>
6pc. Display	<b>12-6716D</b>
<b>C. MICRO</b>	
Blue	<b>12-6717B</b>
Green	<b>12-6717G</b>
Red	<b>12-6717R</b>
6pc. Display	<b>12-6717D</b>

WINDSHIELDS / FAIRINGS  
 AUDIO / COMMUNICATION  
 SEATS / LUGGAGE  
 BARS / MIRRORS / CONTROLS  
 EXHAUST  
 AIR / FUEL SYSTEMS  
 ENGINE  
 TRANSMISSION / DRIVELINE  
 GASKETS / SEALS  
 ELECTRICAL  
**LIGHTING**  
 CABLES  
 BRAKES  
 OIL FILTERS  
 SUSPENSION  
 BODY  
 WHEELS  
 TIRES / TIRE ACC.  
 BIKE ACC.  
 VICTORY / INDIAN  
 COVERS / LOCKS / TIEDOWNS  
 CHEMICALS  
 TOOLS  
 HELMETS  
 HELMET ACC.  
 EYEWEAR  
 APPAREL / RIDER ACC.  
 PROMOTIONAL  
 REFERENCE  
 INDEX

- WINDSHIELDS / FAIRINGS
- AUDIO / COMMUNICATION
- SEATS / LUGGAGE
- BARS / MIRRORS / CONTROLS
- EXHAUST
- AIR / FUEL SYSTEMS
- ENGINE
- TRANSMISSION / DRIVELINE
- GASKETS / SEALS
- ELECTRICAL
- LIGHTING**
- CABLES
- BRAKES
- OIL FILTERS
- SUSPENSION
- BODY
- WHEELS
- TIRES / TIRE ACC.
- BIKE ACC.
- VICTORY / INDIAN
- COVERS / LOCKS / TIEDOWNS
- CHEMICALS
- TOOLS
- HELMETS
- HELMET ACC.
- EYEWEAR
- APPAREL / RIDER ACC.
- PROMOTIONAL
- REFERENCE
- INDEX



## ILLUMINATED LICENSE PLATE BOLTS

- Stainless steel construction
- Bright white LED's with 16" leads
- Great for motorcycles, trailers, and automotive use
- Sold in pairs



Color	WPS#
Black	225-9160BK
Natural	225-9160

## TURN SIGNAL RESISTORS

- Corrects the "fast-flash" problem when using LED turn signals
- Simple splice in installation
- Sold in pairs - connectors included



WPS#
225-9180



## FLASHER UNITS

Universal 12 volt 2 prong flasher unit. Capacity: 32cp (23W)-192cp(138W) Maximum 6 lamps.

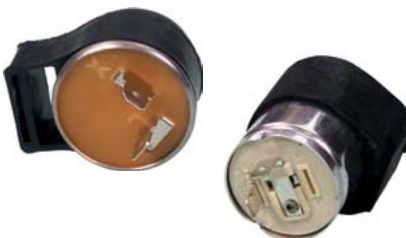

Description	WPS#
12 volt Universal electronic 2-prong	10-1395
12 volt Universal electronic 3-prong	10-1396



## COMPACT LOAD RESISTOR

- Use with signals to correct high flash rate
- Splice tabs included for easy install
- Space saving compact design



WPS#
12-6769

# BLACK VINYL THROTTLE & IDLE CABLES



- Uses precise OEM component dimensions
- Manufactured to meet or exceed OEM specifications
- Part number embossed on each cable
- Color coded header card indicates brand of machine
- OEM part number listed on each package
- Special nylon inner liner assures smooth operation
- Extra outer sleeve to protect cable



Application	Throttle				Idle				
	WPS#	OEM#	Plus/Minus	Housing Length inches	WPS#	OEM#	Plus/Minus	Housing Length Inches	Elbow
<b>TOURING MODELS</b>									
'75 FL/H	<b>70-6055</b>	56302-74	Std	33.7					
	<b>70-6056</b>		6	39.6					
'76-80 FL/H	<b>70-6031</b>	56313-76	Std	32.6					90°
	<b>70-6033</b>		4	36.6					90°
	<b>70-6057</b>		6	38.6					90°
'80 FLT/C	<b>70-6097</b>	56316-80	Std	43.3					90°
'81-84 FLH and FLT	<b>70-6008</b>	56324-81A	Std	32.5	<b>70-6007</b>	56323-81C	Std	32.5	45°
	<b>70-6150</b>		2	34.9	<b>70-6151</b>		2	34.9	45°
	<b>70-6058</b>		6	38.5	<b>70-6059</b>		6	38.5	45°
	<b>70-6175</b>		8	40.9	<b>70-6178</b>		8	40.8	45°
'81, '84-89 FLTC, '84-88 FLHTP	<b>70-6060</b>	56327-81B	Std	42.5	<b>70-6061</b>	56328-81A	Std	42.5	90°
	<b>70-6173</b>		6	48.5	<b>70-6176</b>		6	48.5	90°
'90-95 FLT and FLH/T	<b>70-6195</b>	56327-90	Std	37.7	<b>70-6197</b>	56328-90	Std	38.2	70°
	<b>70-6211</b>		6	43.7	<b>70-6217</b>		6	44.2	70°
'94-95 FLHR	<b>70-6253</b>	56376-94	Std	39.1	<b>70-6254</b>	56375-94	Std	38.5	90°
'96 FLTCU-I, '96-01 FLHTCU-I, '98-01 FLTR-I (Idle w/CC Switch)	<b>70-6373</b>		Std	40.7	<b>70-6363</b>	56358-96	Std	41.6	70°
'96-01 FLHR	<b>70-6302</b>	56376-96	Std	39.2	<b>70-6303</b>	56375-96	Std	38.6	90°
	<b>70-63441</b>		6	44.5	<b>70-6345</b>		6	44.5	90°
'96-01 FLHTC-I	<b>70-6373</b>	56357-96	Std	40.7					70°
'96-97 FLHTU, '98-99 FLTR-I, '96-01 FLHT/C	<b>70-6278</b>	56327-96	Std	37.5	<b>70-6279</b>	56328-96	Std	38"	70°
'02 FLHR, '03-06 FLHR/C-I, '07 FLHR/C (Idle w/CC Switch)	<b>70-6302</b>	56523-02	Std	39.2	<b>70-6362</b>	56237-99A	Std	38.3	90°
'02 FLHR/C-I, '02-07 FLHT/C/U-I, FLTR-I, '06-07 FLHX (Idle w/CC Switch)	<b>70-6358</b>	56357-02	Std	39.2	<b>70-6364</b>	56358-02	Std	38.3	70°
'02 FLHT/C (Idle w/CC Switch)	<b>70-6278</b>	56327-96	Std	37.5	<b>70-6362</b>	56237-99A	Std	38.3	70°
'04-05 FLHRS (Idle w/CC Switch)	<b>70-6372</b>	56295-03	Std	40.4	<b>70-6374</b>	56554-04	Std	41.1	90°
'06-07 FLHRS (Idle w/CC Switch)	<b>70-6372</b>	56295-03	Std	40.4	<b>70-6392</b>	56293-03	Std	40.2	
<b>SOFTAIL MODELS</b>									
'86-89 FLST/C, '84-89 FXST/C	<b>70-6008</b>	56324-81C	Std	32.5	<b>70-6007</b>	56323-81C	Std	32.5	45°
	<b>70-6150</b>		2	34.9	<b>70-6151</b>		2	34.9	45°
	<b>70-6058</b>		6	38.5	<b>70-6059</b>		6	38.5	45°
	<b>70-6175</b>		8	40.9	<b>70-6178</b>		8	40.8	45°
'88-89 FXSTS	<b>70-6150</b>	56306-88	Std	34.9	<b>70-6151</b>	56305-88	Std	34.9	45°
	<b>70-6058</b>		4	38.5	<b>70-6059</b>		4	38.5	45°
	<b>70-6175</b>		6	40.9	<b>70-6178</b>		6	40.8	45°
'90-95 FLST/C/F/N, FXST/C/SB	<b>70-6194</b>	56343-90	Std	29.6	<b>70-6196</b>	56342-90	Std	29.6	90°
	<b>70-6257</b>		2	32	<b>70-6258</b>		2	31.2	90°
	<b>70-6208</b>		6	35.6	<b>70-6214</b>		6	35.7	90°
	<b>70-6253</b>		8	39.1	<b>70-6254</b>		8	38.5	90°
'90-95 FXSTS	<b>70-6245</b>	56306-90	Std	32.6	<b>70-6246</b>	56305-90	Std	32.6	70°
	<b>70-6194</b>		-3	29.6	<b>70-6196</b>		-3	29.6	90°
	<b>70-6195</b>		5	37.7	<b>70-6197</b>		5	38.2	70°
'96-00 FLSTC/F/N/S, FXST/C/SB	<b>70-6266</b>	56343-96	Std	29.6	<b>70-6267</b>	56342-96	Std	29.5	90°
	<b>70-6318</b>		-4	25.6	<b>70-6319</b>		-4	25.6	90°
					<b>70-6323</b>		-1.5	27.2	
	<b>70-62741</b>		2	32.1	<b>70-6275</b>		2	31.3	90°
	<b>70-6268</b>		6	35.6	<b>70-6269</b>		6	35.6	90°
	<b>70-6302</b>		8	39.2	<b>70-6303</b>		8	38.6	90°
	<b>70-63441</b>		15	44.5	<b>70-6345</b>		15	44.5	90°

- WINDSHIELDS / FAIRINGS
- AUDIO / COMMUNICATION
- SEATS / LUGGAGE
- BARS / MIRRORS / CONTROLS
- EXHAUST
- AIR / FUEL SYSTEMS
- ENGINE
- TRANSMISSION / DRIVELINE
- GASKETS / SEALS
- ELECTRICAL
- LIGHTING
- CABLES**
- BRAKES
- OIL FILTERS
- SUSPENSION
- BODY
- WHEELS
- TIRES / TIRE ACC.
- BIKE ACC.
- VICTORY / INDIAN
- COVERS / LOCKS / TIEDOWNS
- CHEMICALS
- TOOLS
- HELMETS
- HELMET ACC.
- EYEWEAR
- APPAREL / RIDER ACC.
- PROMOTIONAL
- REFERENCE
- INDEX



# BLACK VINYL THROTTLE & IDLE CABLES

Application	Throttle				Idle				
	WPS#	OEM#	Plus/Minus	Housing Length inches	WPS#	OEM#	Plus/Minus	Housing Length Inches	Elbow
<b>SOFTAIL MODELS (CONT'D...)</b>									
'96-03 FXSTS	<b>70-62961</b> <b>70-6266</b> <b>70-6278</b>	56306-96	Std -3 5	32.5 29.6 37.5	<b>70-62971</b> <b>70-6267</b> <b>70-6279</b>	56305-96	Std -3 5	32.5 29.5 38	70° 45° 70°
'99-09 FXSTB, '10-11 FLSTFB, '12-13 FXS	<b>70-6318</b>  <b>70-6266</b> <b>70-62741</b> <b>70-6268</b> <b>70-6302</b> <b>70-63441</b>	56432-98	Std  3.5 6 9.5 12.5 18	25.6  29.6 32.1 35.6 39.2 44.5	<b>70-6319</b>  <b>70-6323</b> <b>70-6267</b> <b>70-6275</b> <b>70-6269</b> <b>70-6303</b> <b>70-6345</b>	56433-98	Std 1.5 3.5 6 9.5 12.5 18	25.6 27.2 29.5 31.3 35.6 38.6 44.5	90° 90° 45° 90° 90° 90° 90°
'01-09 FLST/C/S/SC, '01-13 FLSTF/B, '01-13 FXST/D/S, '05-13 FLSTN, '08-11 FXCW/C, '13-14 FLS	<b>70-6266</b>  <b>70-6318</b>  <b>70-62741</b> <b>70-6268</b> <b>70-6302</b> <b>70-63441</b>	56343-01	Std  -4  2 6 8 15	29.6  25.6  32.1 35.6 39.2 44.5	<b>70-6267</b>  <b>70-6319</b>  <b>70-6323</b> <b>70-6275</b> <b>70-6269</b> <b>70-6303</b> <b>70-6345</b>	56342-01	Std  -4 -1.5 2 6 8 15	29.5  25.6 27.2 31.3 35.6 38.6 44.5	45°  90° 90° 90° 90° 90° 90°
'07 FXSTC	<b>70-62741</b> <b>70-6318</b>  <b>70-6266</b> <b>70-6268</b> <b>70-6302</b> <b>70-63441</b>	56939-07	Std -6  -2.5 3 6 12	32.1 25.6  29.6 35.6 39.2 44.5	<b>70-6275</b> <b>70-6319</b>  <b>70-6267</b> <b>70-6269</b> <b>70-6303</b> <b>70-6345</b>	56934-07	Std -6 -4 -2.5 3 6 12	31.3 25.6 27.2 29.5 35.6 38.6 44.5	90° 90° 90° 45° 90° 90° 90°
'08-11 FLSTSB, '08-10 FXSTC, '10-13 FLSTC	<b>70-6394</b> <b>70-6318</b>  <b>70-6266</b> <b>70-62741</b> <b>70-6268</b> <b>70-6302</b> <b>70-63441</b>	56939-07A	Std -7.5  -3.5 -1 2.5 2.5 11.5	33.1 25.6  29.6 32.1 35.6 39.2 44.5	<b>70-6393</b> <b>70-6319</b>  <b>70-6267</b> <b>70-6275</b> <b>70-6269</b> <b>70-6303</b> <b>70-6345</b>	56934-07A	Std -7.5 -5 -3.5 -1 2.5 2.5 11.5	33.1 25.6 27.2 29.5 31.3 35.6 38.6 44.5	90° 90° 90° 45° 90° 90° 90° 90°
<b>DYNA/FXR MODELS</b>									
'74-75 FX1200/FXE	<b>70-6055</b> <b>70-6056</b>	56389-74	Std 6	33.7 39.6					0 0
'76-78 FX1200, '76-80 FXE/F/FXS, '80 FXB/FXWG	<b>70-6031</b> <b>70-6033</b> <b>70-6057</b>	56313-76	Std 4 6	32.6 36.6 38.6					90° 90° 90°
'81-84 FXS/FXE/F, '81-86 FXWG, '82-89 FXR, '82-86 FXRS '82 FXB, '83-85 FXSB	<b>70-6008</b>  <b>70-6150</b> <b>70-6058</b> <b>70-6175</b>	56324-81C	Std  2 6 8	32.5  34.9 38.5 40.9	<b>70-6007</b>  <b>70-6151</b> <b>70-6059</b> <b>70-6178</b>	56323-81C	Std  2 6 8	32.5  34.9 38.5 40.8	45°  45° 45° 45°
'81 FXB Sturgis	<b>70-6095</b>	56332-81	Std	26.5	<b>70-6096</b>	56331-81	Std	26.5	90°
'83-89 FXRT, '86 FXRD	<b>70-6098</b> <b>70-6074</b> <b>70-6174</b>	56336-83	Std 6	30.2 32.5 38.5	<b>70-6075</b> <b>70-6177</b>	56337-83	Std 6	32.5 38.5	90° 90°
'91 FXDB-S, '90-94 FXR/S/T	<b>70-6194</b> <b>70-6257</b> <b>70-6208</b> <b>70-6253</b>	56343-90	Std 2 6 9	29.6 32 35.6 39.1	<b>70-6196</b> <b>70-6258</b> <b>70-6214</b> <b>70-6254</b>	56342-90	Std 2 6 9	29.6 31.2 35.7 38.5	90° 90° 90° 90°
'85-88 FXRP	<b>70-6174</b>	56346-85	Std	38.5	<b>70-6177</b>	56349-85	Std	38.5	90°
'92 FXDB/FXDC, '93-95 FXDL/FXDWG, '95 FXD/S	<b>70-6257</b> <b>70-6208</b> <b>70-6253</b>	56356-92	Std 3 6	32 35.6 39.1	<b>70-6258</b> <b>70-6214</b> <b>70-6254</b>	56355-92	Std 3 6	31.2 35.7 38.5	90° 90° 90°

# BLACK VINYL THROTTLE & IDLE CABLES



Application	Throttle				Idle				Elbow
	WPS#	OEM#	Plus/Minus	Housing Length inches	WPS#	OEM#	Plus/Minus	Housing Length Inches	
<b>DYNA/FXR MODELS (CONT'D...)</b>									
'96-08 FXDWG, '96-00 FXDS, '96-05 FXD/L '05 FXDC, '06-13 FXDB	<b>70-6318</b>		-6	25.6	<b>70-6319</b>		-6	25.6	90°
	<b>70-6266</b>		-2.5	29.6	<b>70-6267</b>		-2.5	29.5	45°
					<b>70-6323</b>		-4	27.2	
	<b>70-62741</b>	56356-96	Std	32.1	<b>70-6275</b>	56355-96	Std	31.3	90°
	<b>70-6268</b>		3	35.6	<b>70-6269</b>		3	35.6	90°
	<b>70-6302</b>		7	39.2	<b>70-6303</b>		7	38.6	90°
'06-13 FXDL, '07-13 FXDC, '10-13 FXDWG, '12-13 FLD	<b>70-6318</b>		-4	25.6	<b>70-6319</b>		-4	25.6	90°
					<b>70-6323</b>		-1.5	27.2	
	<b>70-6266</b>	56421-06	Std	29.6	<b>70-6267</b>	56415-06	Std	29.5	45°
	<b>70-62741</b>		2	32.1	<b>70-6275</b>		2	31.3	90°
	<b>70-6268</b>		6	35.6	<b>70-6269</b>		6	35.6	90°
	<b>70-6302</b>		9	39.2	<b>70-6303</b>		9	38.6	90°
'06 FXDC, '06-10 FXD, '08-13 FXDF	<b>70-6318</b>	56633-06	-2	25.6	<b>70-6319</b>		-2	25.6	90°
					<b>70-6323</b>	56634-06	Std	27.2	
	<b>70-6266</b>		1.5	29.6	<b>70-6267</b>		1.5	29.5	45°
	<b>70-62741</b>		4	32.1	<b>70-6275</b>		3.5	31.3	90°
	<b>70-6268</b>		7.5	35.6	<b>70-6269</b>		7.5	35.6	90°
	<b>70-6302</b>		11	39.2	<b>70-6303</b>		11	38.6	90°
<b>SPORTSTER MODELS</b>									
'79-80 XLX 1000	<b>70-6031</b>	56313-76	Std	32.6"			Std		90°
	<b>70-6033</b>		4	36.6"			4		90°
	<b>70-6057</b>		6	38.6"			6		90°
'81-85 XLX 1000, '81-85 XLH1100	<b>70-6008</b>	56324-81A	Std	32.5"	<b>70-6007</b>	56323-81C	Std	32.5"	45°
	<b>70-6150</b>		2	34.9"	<b>70-6151</b>		2	34.9"	45°
	<b>70-6058</b>		6	38.5"	<b>70-6059</b>		6	38.5"	45°
	<b>70-6175</b>		8	40.9"	<b>70-6178</b>		8	40.8"	45°
'86-87 XLH883 Hugger/Deluxe, '86-87 XLH1100	<b>70-6092</b>	56308-86	Std	31.9"	<b>70-6090</b>	56309-86	Std	32.1"	45°
'88-95 XLH883/Hugger/Deluxe, '88-95 XLH1200	<b>70-6138</b>	56308-88		30.1"	<b>70-6139</b>	56309-88		30.3"	45°
'96-06 XL1200/XL883	<b>70-6334</b>	56400-96	Std	28.5"	<b>70-6335</b>	56401-96	Std	28.5"	45°
	<b>70-6282</b>		1	30"	<b>70-6284</b>		1	30"	45°
	<b>70-6288</b>		3	32"	<b>70-6290</b>		3	32"	45°
'00-01 XLH 883C, XL1200C	<b>70-6350</b>	56436-00		30"	<b>70-6351</b>			30"	90°
'07-13 XL1200/XL883	<b>70-6282</b>	56308-96	Std	30"	<b>70-6391</b>		Std	30.1"	45°
<b>VROD</b>									
'07-11 VRSCDX, '08 VRSCDXA, '07 VRSCX	<b>70-6385</b>	56984-07	Std	27.2"	<b>70-6386</b>	56985-07	Std	26.2"	90°
'07-08 VRSCD, '06-07 VRSCR, '04-05 VRSCB	<b>70-6383</b>	56593-04	Std	27.6"	<b>70-6384</b>	56594-04	Std	26.8"	70°
'01-10 VRSCA/W, '09-13 VRSCF, '12-13 VRSCDX	<b>70-6387</b>	56365-01	Std	29.6"	<b>70-6388</b>	56367-01	Std	28.6"	70°

## BLACK VINYL THROTTLE & IDLE

WPS #	WPS #	WPS #	WPS #	WPS #
<b>70-6007</b>	<b>70-6097</b>	<b>70-6211</b>	<b>70-6282</b>	<b>70-6358</b>
<b>70-6008</b>	<b>70-6098</b>	<b>70-6214</b>	<b>70-6284</b>	<b>70-6362</b>
<b>70-6031</b>	<b>70-6138</b>	<b>70-6217</b>	<b>70-6288</b>	<b>70-6363</b>
<b>70-6033</b>	<b>70-6139</b>	<b>70-6245</b>	<b>70-6290</b>	<b>70-6364</b>
<b>70-6055</b>	<b>70-6150</b>	<b>70-6246</b>	<b>70-62961</b>	<b>70-6372</b>
<b>70-6056</b>	<b>70-6151</b>	<b>70-6253</b>	<b>70-62971</b>	<b>70-6373</b>
<b>70-6057</b>	<b>70-6173</b>	<b>70-6254</b>	<b>70-6302</b>	<b>70-6383</b>
<b>70-6058</b>	<b>70-6174</b>	<b>70-6257</b>	<b>70-6303</b>	<b>70-6384</b>
<b>70-6059</b>	<b>70-6175</b>	<b>70-6258</b>	<b>70-6318</b>	<b>70-6385</b>
<b>70-6060</b>	<b>70-6176</b>	<b>70-6266</b>	<b>70-6319</b>	<b>70-6386</b>
<b>70-6061</b>	<b>70-6177</b>	<b>70-6267</b>	<b>70-6323</b>	<b>70-6387</b>
<b>70-6074</b>	<b>70-6178</b>	<b>70-6268</b>	<b>70-6334</b>	<b>70-6388</b>
<b>70-6075</b>	<b>70-6194</b>	<b>70-6269</b>	<b>70-6335</b>	<b>70-6391</b>
<b>70-6090</b>	<b>70-6195</b>	<b>70-62741</b>	<b>70-63441</b>	<b>70-6392</b>
<b>70-6092</b>	<b>70-6196</b>	<b>70-6275</b>	<b>70-6345</b>	<b>70-6393</b>
<b>70-6095</b>	<b>70-6197</b>	<b>70-6278</b>	<b>70-6350</b>	<b>70-6394</b>
<b>70-6096</b>	<b>70-6208</b>	<b>70-6279</b>	<b>70-6351</b>	

WINDSHIELDS / FAIRINGS  
AUDIO / COMMUNICATION  
SEATS / LUGGAGE  
BARS / MIRRORS / CONTROLS  
EXHAUST  
AIR / FUEL SYSTEMS  
ENGINE  
TRANSMISSION / DRIVELINE  
GASKETS / SEALS  
ELECTRICAL  
LIGHTING  
CABLES  
BRAKES  
OIL FILTERS  
SUSPENSION  
BODY  
WHEELS  
TIRES / TIRE ACC.  
BIKE ACC.  
VICTORY / INDIAN  
COVERS / LOCKS / TIEDOWNS  
CHEMICALS  
TOOLS  
HELMETS  
HELMET ACC.  
EYEWEAR  
APPAREL / RIDER ACC.  
PROMOTIONAL  
REFERENCE  
INDEX



# BLACK VINYL CLUTCH CABLES

- Uses precise OEM component dimensions
- Manufactured to meet or exceed OEM specifications
- Part number embossed on each cable
- OEM part number listed on each package
- Special nylon inner liner assures smooth operation
- Extra outer sleeve to protect cable
- Longitudinally-wound housing will not compress and feel mushy under heavy loads

Application	Coil Wound	Longitudinally Wound	OEM#	Over/Under	Housing Length	Free Length
<b>TOURING</b>						
'52-67 FL/H	<b>70-6000</b>		38618-52	Std	<b>31</b>	2.4
	<b>70-6064</b>			6	<b>37</b>	2.4
'68-84 FL/H	<b>70-6001</b>	<b>70-6120</b>	38618-68A/B	Std	<b>52.1</b>	5.7
	<b>70-6044</b>	<b>70-6125</b>		4	<b>56.1</b>	5.7
	<b>70-6063</b>	<b>70-6127</b>		6	<b>58.1</b>	5.7
'80-82 FLT/C	<b>70-6004</b>		38599-80A	Std	<b>55.4</b>	3.7
	<b>70-6046</b>			6	<b>61.3</b>	3.7
'83-86 FLHT/C/P and FLT/C	<b>70-6005</b>	<b>70-6123</b>	38599-83A	Std	<b>53.3</b>	4.5
'87-99 All Touring models		<b>70-6145</b>	38601-89	Std	<b>62.8</b>	2.6
		<b>70-6164</b>		6	<b>68.8</b>	2.6
		<b>70-6222</b>		8	<b>70.8</b>	2.6
		<b>70-6293</b>		16	<b>78.8</b>	2.6
'00-06 All Touring models		<b>70-6355</b>	38667-00	Std	<b>62.8</b>	2.7
'07 All Touring models		<b>70-6380</b>	38667-07	Std	<b>62.8</b>	3.2
		<b>70-6381</b>		6	<b>68.8</b>	3.2
'08-14 All Touring models		<b>70-6390</b>	38667-08A	Std	<b>62.8</b>	3.7
<b>SOFTAIL</b>						
'84-85 FXST	<b>70-6001</b>	<b>70-6120</b>	38618-68A	Std	<b>52.1</b>	5.7
	<b>70-6044</b>	<b>70-6125</b>		4	<b>56.1</b>	5.7
'86 FLST	<b>70-6005</b>	<b>70-6123</b>	38611-86	Std	<b>53.3</b>	4.5
'86 FXST/C		<b>70-6086</b>	38605-86	Std	<b>53.4</b>	7.7
'87-99 FLST/C/F/N/S, FXST/C/S		<b>70-6145</b>	38607-87A	Std	<b>62.8</b>	2.6
		<b>70-6327</b>		-4	<b>58.9</b>	2.6
		<b>70-6164</b>		6	<b>68.8</b>	2.6
		<b>70-6222</b>		8	<b>70.8</b>	2.6
		<b>70-6293</b>		16	<b>78.8</b>	2.6
'95-97 FXSTSB		<b>70-6329</b>	38617-95	Std	<b>64.8</b>	2.6
		<b>70-6145</b>		-2	<b>62.8</b>	2.6
		<b>70-6293</b>		14	<b>78.8</b>	2.6
'00-06 FLST/C/F/S, FXST/C/S		<b>70-6329</b>	38666-00	Std	<b>64.8</b>	2.6
		<b>70-6145</b>		-2	<b>62.8</b>	2.6
		<b>70-6222</b>		6	<b>70.8</b>	2.6
		<b>70-6293</b>		14	<b>78.8</b>	2.6
'00-06 FXSTB		<b>70-6327</b>	38665-00	Std	<b>58.9</b>	2.6
		<b>70-6145</b>		4	<b>62.8</b>	2.6
		<b>70-6329</b>		6	<b>64.8</b>	2.6
		<b>70-6164</b>		10	<b>68.8</b>	2.6
		<b>70-6222</b>		12	<b>70.8</b>	2.6
		<b>70-6293</b>	38601-89	20	<b>78.8</b>	2.6
'00-06 FXSTD, '05-06 FLSTN		<b>70-6145</b>	38664-00	Std	<b>62.8</b>	2.6
		<b>70-6327</b>		-4	<b>58.9</b>	2.6
		<b>70-6164</b>		6	<b>68.8</b>	2.6
		<b>70-6222</b>		8	<b>70.8</b>	2.6
		<b>70-6293</b>		16	<b>78.8</b>	2.6
'01-06 FXSTS	<b>70-6251</b>	<b>70-6261</b>	38666-00	10	<b>74.8</b>	2.6
'07-10 FLSTC, FXST/C, '07 FLSTF, FLSTSC, '08-10 FXCW/C		<b>70-6379</b>	38666-07	Std	<b>64.8</b>	3.2
		<b>70-6377</b>		4	<b>68.8</b>	3.2
		<b>70-6382</b>		6	<b>70.7</b>	3.2
'09-11 FLSTSB		<b>70-6378</b>	38883-08A	Std	<b>65.5</b>	3.2
'11-13 FLSTC, FXST/C, '11 FXCWC		<b>70-6377</b>	38666-07C	3	<b>68.8</b>	3.2
		<b>70-6379</b>		-1	<b>64.8</b>	3.2
		<b>70-6382</b>		5	<b>70.7</b>	3.2
'12-13 FXS, '07-09 FXSTB		<b>70-6376</b>	38665-07	Std	<b>57.8</b>	3.2
'13-14 FLS, '07-13 FLSTN, '07 FXSTD, '08-13 FLSTF/B		<b>70-6375</b>	38664-07	Std	<b>63</b>	3.2



# BLACK VINYL CLUTCH CABLES



Application	Coil Wound	Longitudinally Wound	OEM#	Over/Under	Housing Length	Free Length
<b>DYNA/FXR</b>						
'71-78 FX 1200, '73-84 FXE, '77-84 FXS, '79-85 FXEF, '80-82 FXB, '80-86 FXWG, '83-85 FXSB	<b>70-6001</b>	<b>70-6120</b>	38618-68C	Std	<b>52.1</b>	5.7
	<b>70-6044</b>	<b>70-6125</b>		4	<b>56.1</b>	5.7
	<b>70-6063</b>	<b>70-6127</b>		6	<b>58.1</b>	5.7
'82 FXR/S	<b>70-6004</b>		38599-80A	Std	<b>55.4</b>	3.7
	<b>70-6046</b>			6	<b>61.3</b>	3.7
'83-86 FXR/D/DG/P/S/T	<b>70-6005</b>	<b>70-6123</b>	38599-83A	Std	<b>53.3</b>	4.5
'87-88 FXRP		<b>70-6145</b>	38607-87A	Std	<b>62.8</b>	2.6
		<b>70-6327</b>		-4	<b>58.9</b>	2.6
		<b>70-6222</b>		8	<b>70.8</b>	2.6
		<b>70-6293</b>		16	<b>78.8</b>	2.6
'87-94 FXR/D/S/T		<b>70-6146</b>	38606-87A	Std	<b>63.7</b>	2.3
		<b>70-6144</b>		-3	<b>60.7</b>	2.3
		<b>70-6143</b>		-6	<b>57.7</b>	2.3
		<b>70-6163</b>		3	<b>66.7</b>	2.3
		<b>70-6165</b>		6	<b>69.7</b>	2.3
'91 FXDB-S		<b>70-6329</b>	38604-90A	Std	<b>64.8</b>	2.6
		<b>70-6164</b>		4	<b>68.8</b>	2.6
		<b>70-6222</b>		6	<b>70.8</b>	2.6
		<b>70-6293</b>		14	<b>78.8</b>	2.6
'91-92 FXDB-D/S		<b>70-6145</b>	38607-87A	-6	<b>62.8</b>	2.6
'92 FXDC/FXDB-D, '93-99 FXDL/FXDWG, '95-99 FXD/S	<b>70-6251</b>	<b>70-6164</b>	38602-92	Std	<b>68.8</b>	2.6
		<b>70-6329</b>		-4	<b>64.8</b>	2.6
		<b>70-6222</b>		2	<b>70.8</b>	2.6
		<b>70-6261</b>		6	<b>74.8</b>	2.9
		<b>70-6293</b>		10	<b>78.8</b>	2.6
'93-99 FXDL/FXDWG, '95-99 FXDS, '95-99 FXD	<b>70-6251</b>	<b>70-6145</b>	38602-92	-6	<b>62.8</b>	2.6
		<b>70-6261</b>		6	<b>74.8</b>	2.9
'00 FXDL/FXDS, '00-05 FXDWG	<b>70-6251</b>	<b>70-6164</b>	38661-00	Std	<b>68.8</b>	2.6
		<b>70-6329</b>		-4	<b>64.8</b>	2.6
		<b>70-6222</b>		2	<b>70.8</b>	2.6
		<b>70-6261</b>		6	<b>74.8</b>	2.9
		<b>70-6293</b>		10	<b>78.8</b>	2.6
'00-05 FXD/C, '01-05 FXDL		<b>70-6329</b>	38666-00	Std	<b>64.8</b>	2.6
		<b>70-6164</b>		4	<b>68.8</b>	2.6
		<b>70-6293</b>		14	<b>78.8</b>	2.6
'06 FXDL		<b>70-6378</b>	38788-06	Std	<b>65.5</b>	3.2
'06-13 FXDB, '06-08 FXDWG		<b>70-6377</b>	38789-06B	Std	<b>68.8</b>	3.2
		<b>70-6382</b>		2	<b>70.7</b>	3.2
'06-10 FXD, '06 FXDC, '10-13 FXDWG		<b>70-6379</b>	38787-06A/B/C	Std	<b>64.8</b>	3.2
		<b>70-6377</b>		4	<b>68.8</b>	3.2
		<b>70-6382</b>		6	<b>70.7</b>	3.2
'08-13 FXDF, '13 FXDBP W/OE Drag Bars		<b>70-6379</b>	38785-08/A	3.5	<b>64.8</b>	3.2
		<b>70-6377</b>		7.5	<b>68.8</b>	3.2
		<b>70-6382</b>		9.5	<b>70.7</b>	3.2
'12-13 FLD, '07-13 FXDC/FXDL		<b>70-6378</b>	38788-06C	Std	<b>65.5</b>	3.2

- WINDSHIELDS / FAIRINGS
- AUDIO / COMMUNICATION
- SEATS / LUGGAGE
- BAR / MIRRORS / CONTROLS
- EXHAUST
- AIR / FUEL SYSTEMS
- ENGINE
- TRANSMISSION / DRIVELINE
- GASKETS / SEALS
- ELECTRICAL
- LIGHTING
- CABLES**
- BRAKES
- OIL FILTERS
- SUSPENSION
- BODY
- WHEELS
- TIRES / TIRE ACC.
- BIKE ACC.
- VICTORY / INDIAN
- COVERS / LOCKS / TIEDOWNS
- CHEMICALS
- TOOLS
- HELMETS
- HELMET ACC.
- EYEWEAR
- APPAREL / RIDER ACC.
- PROMOTIONAL
- REFERENCE
- INDEX



# BLACK VINYL CLUTCH CABLES

Application	Coil Wound	Longitudinally Wound	OEM#	Over/Under	Housing Length	Free Length
<b>SPORTSTER</b>						
'57-70 XLH/XLCH	70-6002 70-6067		38619-57A	Std 6		8.3 8.3
'71-77 XLCH, '77, '81-83 XLT1000, '77-83 XLH1100	70-6236	70-6126	38619-71B	6	53.2	7
'71-76 XLCH, '77-78 XLT1000, '77-85 XLH1100, '83-84 XR1000	70-6107 70-6236	70-6088 70-6126	38619-84	Std 6	47.3 53.2	7 7
'77-78 XLCR, '83-85 XLX 1000	70-6106		38626-77B	Std	42.3	7
'86-87 XLH1100, '88-95 XLH1200, '92-95 XLH883 DLX, '87-95 XLH883 HUGGER	70-6203	70-6147 70-6161 70-6286 70-6145 70-6164 70-6222 70-6293	38621-86A	Std -3 -4 1 7 9 17	61.2 58.7 57.2 62.8 68.8 70.8 78.8	2.8 2.6 2.5 2.6 2.6 2.6 2.6
'86-91 XLH883DLX, '86-99 XLH883, '96-99 XLH1200S		70-6137 70-6286 70-6161 70-6147 70-6145	38619-86A	Std 4 6 8 10	52.8 57.2 58.7 61.2 62.8	2.6 2.5 2.6 2.8 2.6
'96-99 XLH883HUG/XLH1200/XL1200C, '99 XLH 883C	70-6203	70-6286 70-6137 70-6161 70-6147 70-6145	38620-96	Std -5 1 4 5	57.2 52.8 58.7 61.2 62.8	2.5 2.6 2.6 2.8 2.6
'00-03 XLH 883C/HUG, '00 XLH883/XL1200C, '01-03 XLH1200	70-6203	70-6286 70-6137 70-6161 70-6147 70-6145	38662-00	Std -5 1 4 5	57.2 52.8 58.7 61.2 62.8	2.5 2.6 2.6 2.8 2.6
'00 XLH1200S		70-6145	38662-00	8	62.8	2.6
'00 XLH1200, '01-03 XL1200C/S, '00 XLH883 HUG, '01-03 XLH883, '02-03 XL883R	70-6203	70-6137 70-6286 70-6161 70-6147 70-6145	38663-00	Std 4 6 8 10	52.8 57.2 58.7 61.2 62.8	2.6 2.5 2.6 2.8 2.6
'04-08 XL1200C/R/XLH883C/R, '05 XL883L	70-6203	70-6369 70-6286 70-6161 70-6147 70-6145	38699-04/A	Std 2 3 6 8	54.8 57.2 58.7 61.2 62.8	2.6 2.5 2.6 2.8 2.6
'09-10 XLH883C/XL1200C, '09-13 XL883N/R, '11-13 XL883L, '12 XL1200X, '12-13 XL1200C		70-6369	38699-04C	Std	54.8	2.6
'07-10 XL883L, '07-12 XL1200N/L		70-6389	38702-05/C	Std	57.1	2.7

## BLACK VINYL CLUTCH

WPS#	WPS#	WPS#	WPS#
70-6000	70-6107	70-6163	70-6369
70-6001	70-6120	70-6164	70-6375
70-6002	70-6123	70-6165	70-6376
70-6004	70-6125	70-6203	70-6377
70-6005	70-6126	70-6222	70-6378
70-6044	70-6127	70-6236	70-6379
70-6046	70-6137	70-6251	70-6380
70-6063	70-6143	70-6261	70-6381
70-6064	70-6144	70-6286	70-6382
70-6067	70-6145	70-6293	70-6389
70-6086	70-6146	70-6327	70-6390
70-6088	70-6147	70-6329	
70-6106	70-6161	70-6355	

# BLACK VINYL SPEEDO CABLES



- Uses precise OEM component dimensions
- Manufactured to meet or exceed OEM specifications
- Part number embossed on each cable
- OEM part number listed on each package
- Special nylon inner liner assures smooth operation
- Extra outer sleeve to protect cable
- Longitudinally-wound housing will not compress and feel mushy under heavy loads

Application	Plus/Minus	OEM#	WPS#	Length
<b>TOURING MODELS</b>				
'37-51 Big Twin, '52-61 FL/H	Std	67026-37	<b>70-6152</b>	36
'62-80 FL/h	Std	67026-62	<b>70-6012</b>	35
80-86 FLT/C, '83-85 FLHT/C/P, '87-95 FLHTC/U, '87, '95 FLHT, '87-88 FLHTP	Std	67072-79/A	<b>70-6011</b>	39
81-84 FL/H, '86 FLHT/C/P, '87-91 FLTC, '87-94 FLHS, '89-96 FLTCU, '96-97 FLHT/C/U	Std	67026-81	<b>70-6013</b>	35
'98-99 FLTR	Std	67051-73A	<b>70-6010</b>	40
<b>SOFTAIL</b>				
'84-95 FXST/C/S/SB	Std	67038-84	<b>70-6011</b>	39
'86-95 FLST/C/F/N	Std	67079-86A	<b>70-6013</b>	35
<b>DYNA/FXR</b>				
'71-72 FX, '80-83 FXWG	Std	67026-62	<b>70-6012</b>	35
'73-78 FX/E, '77-80 FXS	Std	67051-73	<b>70-6010</b>	40
78 FX, '79-84 FXE/F, '80-82 FXB, '81-84 FXS, '83-85 FXSB, '84-87 FXRS, '85 FXRP	Std	67052-78A	<b>70-6010</b>	40
'82-83 FXR/S, '84 FXRP	Std	67060-79A	<b>70-6109</b>	41.4
'83-92 FXRT, '84 FXRDG, '86 FXRD	Std	67054-83B	<b>70-6116</b>	46.6
'84-86 FXWG, '93-94 FXDWG	Std	67024-84A	<b>70-6011</b>	39
'85 FXRP	3.0	67052-78A	<b>70-6050</b>	43
'85 FXRT, '87-93 FXRS-SP, '94 FXRS-CON	Std	67063-89	<b>70-6250</b>	36.7
'85, '87 FXRC, '85-86 FXRS-SP '86-88 FXRP	Std	67052-78B	<b>70-6050</b>	43
'86-94 FXR/LR	Std	67078-85A	<b>70-6010</b>	40
'88-92 FXRS, '91 FXDB-S, '92 FXDC/B-D, '93-94 FXDL	Std	67186-88	<b>70-6013</b>	35
<b>SPORTSTER</b>				
'70-72 XLCH/XLH	Std	67051-70	<b>70-6207</b>	44.1
	-9.0		<b>70-6012</b>	35
'73 XLH/CH	Std	67051-73	<b>70-6010</b>	40
'74-83 XLH/CH/CR, '77 XLT	Std	67051-74	<b>70-6011</b>	39
	-4.0		<b>70-6013</b>	35
'79-82 XLS	Std	67060-79A	<b>70-6109</b>	41.4
	-6.0		<b>70-6013</b>	35
'83-84 XLS	Std	67054-83A/B	<b>70-6116</b>	46.6
'83-84 XR1000	Std	67052-78B	<b>70-6010</b>	40
	-3.0		<b>70-6050</b>	43
'83-85 XLX, '84-85 XLH	Std	67052-78A/B	<b>70-6010</b>	40
'85 XLS, '91-94 XLH 883/DLX/HUG, '93-94 XLH 1200	Std	67063-89	<b>70-6250</b>	36.7
'86-90 XLH 883/DLX/HUG, '86-87 XLH 1100, '88-92 XLH1200	Std	67052-78B	<b>70-6050</b>	43

# BLACK VINYL CHOKE CABLES

- Black vinyl coil-wound housing
- Meets or exceeds OEM quality
- Inner nylon sleeve for longer life and smooth operation
- 70-6205: Replaces dash mounted choke assemblies with 3/16" shank & 10 x 32 thread
- 70-6247: Thread size 10x32
- 70-6244: Includes knob. Cable is inner wire only - 11.2". Replaces top motor mount choke assembly with 5/32" shank & 8 x 32 thread

Application	Cable Length	OEM#	WPS#	Length
<b>TOURING</b>				
'78-Late '84 FL MODELS,	Std	29213-79	<b>70-6205</b>	16.4
'80-89 FLTC, '89 FLTCU/FLHTCU, '83-87 FLHT/C, '87-89 FLHS, '84-88 FLHTP, '80-83 FLT	Std	29225-79	<b>70-6247</b>	9.1
'90-91 FLTC, '90-95 FLTCU, '90-97 FLHTCU, '95-01 FLHT, '94-01 FLHR, '98-01 FLHTC, '98-03 FLTR	Std	29236-90	<b>70-6204</b>	8.6
<b>SOFTAIL</b>				
'86-89 FLST/C, '84-89 FXST/C, '88-89 FXSTS	Std	29211-86	<b>70-6205</b>	16.4
'90 FLST/FXST, '90-00 FXST/C, '90-04 FXSTS/FLSTF/FLSTC, '93-96 FLSTN, '97-03 FLSTS, '95-97 FXSTSB, '99-04 FXSTB	Std	29229-88A	<b>70-6204</b>	8.6
<b>DYNA</b>				
'73-78 FX, '73-81 FXE, '77-81 FXS, '79-81 FXEF, '80-81 FXB	Std	29216-72	<b>70-6244</b>	
'85 and '87 FXRC, '86 FXRD, '84 FXRDG, '87-89 FXLR, '82-83 and '86-89 FXR, '85-89 FXRS-SP, '83-89 FXRT, '82-89 FXRS, '84-88 FXRP	Std	29225-79	<b>70-6247</b>	9.1
'80-86 FXWG	Std	29213-79	<b>70-6205</b>	16.4
'93-04 FXDWG/FXDL, '95-04 FXD, '90-92 FXRS/FXRT, '91 FXDBS, '99-04 FXDX, '92 FXDBD/FXDC	Std	29229-88A	<b>70-6204</b>	8.6
<b>SPORTSTER</b>				
'72- Early '80 XLH, '72-79 XLCH, '77-78 XLCR, '79-Early '80 XLS, '77 XLT	Std	29216-72	<b>70-6244</b>	
'88-91 XLH883/DLX/HUG/1200	Std	29229-88	<b>70-6204</b>	8.6
'99-03 XL833/C, '92-95 XLH 883DLX/HUG, '92-03 XLH1200, '96-03 XL1200C/S, '02-03 XL883R	Std	29238-92A	<b>70-6295</b>	4.8

- WINDSHIELDS / FAIRINGS
- AUDIO / COMMUNICATION
- SEATS / LUGGAGE
- BAR / MIRRORS / CONTROLS
- EXHAUST
- AIR / FUEL SYSTEMS
- ENGINE
- TRANSMISSION / DRIVELINE
- GASKETS / SEALS
- ELECTRICAL
- LIGHTING
- CABLES**
- BRAKES
- OIL FILTERS
- SUSPENSION
- BODY
- WHEELS
- TIRES / TIRE ACC.
- BIKE ACC.
- VICTORY / INDIAN
- COVERS / LOCKS / TIEDOWNS
- CHEMICALS
- TOOLS
- HELMETS
- HELMET ACC.
- EYEWEAR
- APPAREL / RIDER ACC.
- PROMOTIONAL
- REFERENCE
- INDEX



# ARMOR COAT THROTTLE & IDLE CABLES

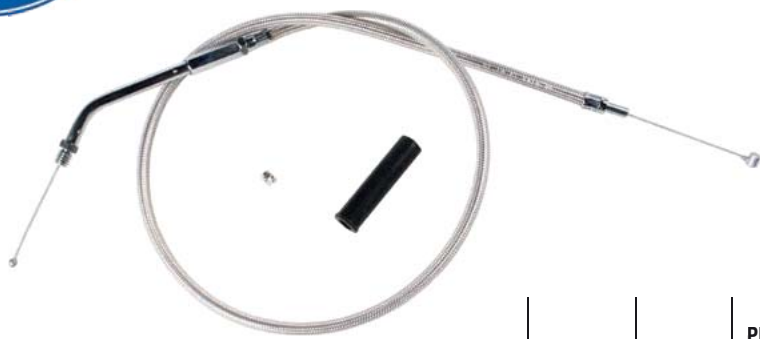

- Attractive stainless steel weave with performance and attitude
- Clear Armor Coat protects chrome and painted surfaces
- Premium chrome fittings

For cable length reference check chart following cable pages

Application	Throttle	OEM#	Plus/Minus	Housing Length inches	Idle	OEM#	Housing Length inches	Elbow
<b>TOURING MODELS</b>								
'81-84 FLH and FLT	<b>70-660070</b>	56324-81A	Std	32.5	<b>70-660068</b>	56323-81C	32.5	45
	<b>70-660182</b>		2	34.6	<b>70-660069</b>		38.5	45
	<b>70-660071</b>		6	38.5	<b>70-660186</b>		34.6	45
	<b>70-660189</b>		8	40.9	<b>70-660192</b>		40.9	45
'84-89 FLHS/FLTC, '84-87 FLHT, '84-89 FLHTC, '84-88 FLHTP	<b>70-660179</b>	56327-81B	Std	42.5	<b>70-660183</b>	56328-81B	42.5	90
	<b>70-660188</b>		-4	38.5	<b>70-660191</b>		38.5	90
	<b>70-660187</b>		+6	48.5	<b>70-660190</b>		48.5	90
'94-95 FLHR	<b>70-660255</b>	56376-94	Std	39.2	<b>70-660256</b>	56375-94	38.6	90
	<b>70-660259</b>		-7	32				
	<b>70-660209</b>	56376-94	-9.5	29.6	<b>70-660215</b>	56375-94	29.7	90
	<b>70-660210</b>		-4	35.6	<b>70-660216</b>		35.7	90
'90-95 FLT and FLH/T	<b>70-660212</b>	56327-90	Std	37.7	<b>70-660218</b>	56328-90	38.2	70
	<b>70-660213</b>		6	43.7	<b>70-660219</b>		44.2	70
'96-06 FLHR and '02 FLHT/FLTR	<b>70-660304</b>	56376-96	Std	39.2	<b>70-660305</b>	56375-96	38.6	90
	<b>70-660272</b>		-4	35.6	<b>70-660273</b>	56375-96	35.6	90
	<b>70-660346</b>		4	43	<b>70-660347</b>	56375-96	42.5	90
	<b>70-660348</b>		6	44.5	<b>70-660349</b>	56375-96	44.5	90
'96-97 FLHTU, '98-99 FLTR-I, '96-01 FLHT/C	<b>70-660280</b>	56327-96	Std	37.5	<b>70-660281</b>	56328-96	38.1	70
'96-01 FLHR-I and '98-01 FLHRC-I	<b>70-660300</b>	56379-96	Std	41.8	<b>70-660301</b>	56368-96	41.2	90
'96-01 FLHR-I and '98-01 FLHRC-I	<b>70-660366</b>		+6	48.1	<b>70-660367</b>		47.7	90
'02-07 FLHR/C, '03-06 FLHR/C-I and '02 FLHT/C/ and FLTR					<b>70-660371</b>		44.4	90
					<b>70-660362</b>	56237-99A	38.3	90
'02 FLHR/C-I, '02-06 FLHT/C/U-I and FLTR-I, '06 FLHX-I, '07 FLH/X/T/C/U and FLTR	<b>70-660350</b>	56357-02	Std	39.2	<b>70-660364</b>	56358-02	38.3	70
	<b>70-660370</b>		+6	45.2	<b>70-660372</b>		44.3	70
'03-05 FLHT/C and '03 FLHT-I and FLTR	<b>70-660378</b>		+6	44.9	<b>70-660376</b>	56525-02	44.1	70
'03-05 FLHR					<b>70-660379</b>	56522-02	44.2	90
'04-05 FLHRS	<b>70-660385</b>	56555-04	Std		<b>70-660387</b>	56554-04	41.1	90
<b>SOFTAIL</b>								
'86-89 FLST/C, '84-89 FXST/C	<b>70-660070</b>	56324-81C	Std	32.5	<b>70-660068</b>	56323-81C	32.5	45
	<b>70-660182</b>		2	34.6	<b>70-660186</b>		34.6	45
	<b>70-660071</b>		6	38.5	<b>70-660069</b>		38.5	45
	<b>70-660189</b>		8	40.9	<b>70-660192</b>		40.9	90
'88-89 FXSTS	<b>70-660182</b>	56306-88	Std	34.6	<b>70-660186</b>	56305-88	34.6	45
	<b>70-660071</b>		4	38.5	<b>70-660069</b>		38.5	45
	<b>70-660189</b>		6	40.9	<b>70-660192</b>		40.9	90
'90-95 FXSTS	<b>70-660264</b>	56306-90	Std	32.6	<b>70-660265</b>	56306-90	32.6	70
	<b>70-660209</b>		-4	29.6	<b>70-660215</b>		29.7	90
	<b>70-660212</b>		5	37.7	<b>70-660218</b>		38.2	70
'90-95 FLST/C/F/N, FXST/C/SB	<b>70-660209</b>	56343-90	Std	29.6	<b>70-660215</b>	56343-90	29.7	90
	<b>70-660259</b>		2	32	<b>70-660260</b>		31.3	90
	<b>70-660210</b>		6	35.6	<b>70-660216</b>		35.7	90
	<b>70-660255</b>		9	39.2	<b>70-660256</b>		38.6	90
'96-00 FLSTC/F/N/S, FXST/C/SB	<b>70-660270</b>	56343-96	Std	29.6	<b>70-660271</b>	56342-96	29.6	90
	<b>70-660320</b>		-4	25.7	<b>70-660321</b>		25.7	90
	<b>70-660276</b>		2	32.2	<b>70-660277</b>		31.3	90
	<b>70-660272</b>		6	35.6	<b>70-660273</b>		35.6	90
	<b>70-660304</b>		9	39.2	<b>70-660305</b>		38.6	90
'96-03 FXSTS	<b>70-660298</b>	56306-96	Std	32.5	<b>70-660299</b>	56305-96	32.5	70
	<b>70-660270</b>		-4	29.6	<b>70-660271</b>		29.6	90
	<b>70-660280</b>		5	37.5	<b>70-660281</b>		38.1	70
'99-09 FXSTB, '10-11 FLSTFB	<b>70-660320</b>	56432-98	Std	25.7	<b>70-660321</b>	56433-98	25.7	90
	<b>70-660270</b>		3.5	29.6	<b>70-660271</b>		29.6	90
	<b>70-660276</b>		6	32.2	<b>70-660277</b>		31.3	90
	<b>70-660272</b>		9.5	35.6	<b>70-660273</b>		35.6	90
	<b>70-660304</b>		12.5	39.2	<b>70-660305</b>		38.6	90

# ARMOR COAT THROTTLE & IDLE CABLES

For cable length reference check chart following cable pages



Application	Throttle	OEM#	Plus/ Minus	Housing Length inches	Idle	OEM#	Housing Length Inches	Elbow
<b>SOFTAIL (CONT'D...)</b>								
'01-09 FLST/C/S/SC, '01-13 FLST/B, '01-13 FXST/D, '04-07 FXSTS, '05-13 FLSTN, '08-11 FXCW/C, '13-14 FLS	70-660270	56343-01	Std	29.6	70-660271	56342-01	29.6	90
	70-660320		-4	25.7	70-660321		25.7	90
	70-660276		2	32.2	70-660277		31.3	90
	70-660272		6	35.6	70-660273		35.6	90
	70-660304		9	39.2	70-660305		38.6	90
'07 FXSTC	70-660276	56939-07	Std	32.2	70-660277	56934-07	31.3	90
	70-660320		-6	25.7	70-660321		25.7	90
	70-660270		-2.5	29.6	70-660271		29.6	90
	70-660272		3	35.6	70-660273		35.6	90
	70-660304		6	39.2	70-660305		38.6	90
'08-11 FLSTSB, '08-10 FXSTC, '10-13 FLSTC	70-660394	56939-07A	Std	33.1	70-660393	56934-07A	33.1	90
	70-660320		-7.5	25.7	70-660321		25.7	90
	70-660270		-3.5	29.6	70-660271		29.6	90
	70-660276		-1	32.2	70-660277		31.3	90
	70-660272		2.5	35.6	70-660273		35.6	90
'12-13 FXS	70-660304		5.5	39.2	70-660305		38.6	90
	70-660270	56432-98	Std	29.6	70-660271	56433-98	29.6	90
	70-660320		-4	25.7	70-660321		25.7	90
	70-660276		2	32.2	70-660277		31.3	90
	70-660272		6	35.6	70-660273		35.6	90
70-660304		9	39.2	70-660305		38.6	90	
<b>DYNA/FXR</b>								
81-84 FXS/FXE/F, '81-86 FXWG, '82-89 FXR, '82-89 FXRS '82 FXB, '83-85 FXSB, '84 FXRDG, '85-86 FXRS-SP, '85 and '87 FXRC	70-660070	56324-81C	Std	32.5	70-660068	56323-81C	32.5	45
	70-660182		2	34.6	70-660186		34.6	45
	70-660071		6	38.5	70-660069		38.5	45
	70-660189		8	40.9	70-660192		40.9	45
'83-89 FXRT, '86 FXRD, '87-89 FXLR, FXRS-SP	70-660180	56336-83	Std	32.5	70-660184	56337-83	32.5	90
	70-660188		6	38.5	70-660191		38.5	90
	70-660179		10	42.5	70-660183		42.5	90
'85-88 FXRP	70-660188	56346-85	Std	38.5	70-660191	56349-85	38.5	90
'91 FXDB-S, '90-94 FXR/S/T, '90-94 FXLR, '90-94 FXRS-CON, '90-93 FXRS-SP	70-660209		Std	29.6	70-660215		29.7	90
	70-660259	56343-90	2	32	70-660260		31.3	90
	70-660210		6	35.6	70-660216		35.7	90
	70-660255		9	39.2	70-660256		38.6	90
'92 FXDB/FXDC, '93-95 FXDL/FXDWG, '95 FXD/S	70-660259	56356-92	Std	32	70-660260	56355-92	31.3	90
	70-660210		3	35.6	70-660216		35.7	90
	70-660255		6	39.2	70-660256		38.6	90
'96-08 FXDWG, '96-00 FXDS, '96-05 FXD/L, FXDX/T '99-05 '05 FXDC, '06-13 FXDB, '13 FXDBP W/OE Mini Ape Bars	70-660276	56356-96	Std	32.2	70-660277	56355-96	31.3	90
	70-660324		-4	28	70-660325		27.2	0
	70-660272		3	35.6	70-660273		35.6	90
	70-660304		6	39.2	70-660305		38.6	90
	70-660320		-6	25.7	70-660321		25.7	90
	70-660270		-2.5	29.6	70-660271		29.6	90
	70-660346		11	43	70-660347		42.5	90
	70-660348		12	44.5	70-660349		44.5	90
	70-660270	56421-06	Std	29.6	70-660271	56415-06	29.6	90
	70-660320		-4	25.7	70-660321		25.7	90
70-660324		-1.5	28	70-660325		27.2	0	
70-660276		2	32.2	70-660277		31.3	90	
70-660272		6	35.6	70-660273		35.6	90	
70-660304		9	39.2	70-660305		38.6	90	
70-660346		13	43	70-660347		42.5	90	
70-660348		15	44.5	70-660349		44.5	90	
'06 FXDC, '06-10 FXD, '08-13 FXDF	70-660324	56633-06	Std	28	70-660325	56634-06	27.2	0
	70-660320		-2	25.7	70-660321		25.7	90
	70-660270		1.5	29.6	70-660271		29.6	90
	70-660276		4	32.2	70-660277		31.3	90
	70-660272		7.5	35.6	70-660273		35.6	90
	70-660304		11	39.2	70-660305		38.6	90
	70-660346		15	43	70-660347		42.5	90
	70-660348		16.5	44.5	70-660349		44.5	90

- WINDSHIELDS / FAIRINGS
- AUDIO / COMMUNICATION
- SEATS / LUGGAGE
- BAR / MIRRORS / CONTROLS
- EXHAUST
- AIR / FUEL SYSTEMS
- ENGINE
- TRANSMISSION / DRIVELINE
- GASKETS / SEALS
- ELECTRICAL
- LIGHTING
- CABLES
- BRAKES
- OIL FILTERS
- SUSPENSION
- BODY
- WHEELS
- TIRES / TIRE ACC.
- BIKE ACC.
- VICTORY / INDIAN
- COVERS / LOCKS / TIEDOWNS
- CHEMICALS
- TOOLS
- HELMETS
- HELMET ACC.
- EYEWEAR
- APPAREL / RIDER ACC.
- PROMOTIONAL
- REFERENCE
- INDEX



# ARMOR COAT CLUTCH CABLES



- Uses precise OEM component dimensions
- Manufactured to meet or exceed OEM specifications
- Part number embossed on each cable
- OEM part number listed on each package

- Special nylon inner liner assures smooth operation
- Extra outer sleeve to protect cable
- Longitudinally-wound housing will not compress and feel mushy under heavy loads

Application	Coil Wound	Longitudinally Wound	OEM#	Over/Under	Housing Length	Free length
<b>TOURING</b>						
'68-84 FL/H	70-660025 70-660026		38618-68C	Std 6	52.1 58.1	5.7 5.7
'84-86 FLHT/C/P and FLT/C	70-660072 70-660223		38599-83A	Std 6	53.3 59.3	4.5 4.5
'87-99 All Touring models	70-660158 70-660326 70-660380 70-660170	70-670158  70-670380 70-670170 70-670409 70-670410	38601-89	Std -4 4 6 8 10 12	62.8 58.7 66.8 68.7 70.8 72.8 74.8	2.8 2.9 2.8 2.8 2.6 2.6 2.8
'00-06 All Touring models	70-660262 70-660357 70-660368	70-670262 70-670357 70-670368	38667-00	Std 6	62.8 68.8	2.9 2.9
'07 All Touring models		70-670395 70-670396	38667-07	Std 6	62.8 68.8	3.2 3.2
'08-14 All Touring models		70-670399 70-670400 70-670401 70-670402 70-670403 70-670404	38667-08A	Std 4 6 10 12 14	62.8 66.8 68.8 72.8 74.8 76.8	3.7 3.7 3.7 3.7 3.7 3.7
<b>SOFTAIL</b>						
'84-85 FXST	70-660025 70-660026		38618-68C	Std 6	52.1 58.1	5.7 5.7
'86 FXST/C	70-660252		38605-86	Std	53.3	7.7
'86 FLST	70-660072 70-660223		38611-86	Std 6	53.3 59.3	4.5 4.5
'87-99 FLST/C/F/N/S, FXST/C/S	70-660158 70-660326 70-660380 70-660170 70-660170	70-670158  70-670380 70-670170 70-670170	38607-87A	Std -4 4 5 6 8 10 12	62.8 58.7 66.8 68.7 68.7 70.8 72.8 74.8	2.8 2.9 2.8 2.8 2.8 2.6 2.6 2.8
'95-97 FXSTSB	70-660262 70-660158 70-660380 70-660170	70-670262 70-670158 70-670380 70-670170	38617-95	2 6 8 10 12 14	62.8 66.8 68.7 70.8 72.8 74.8	2.8 2.8 2.8 2.6 2.6 2.8
'00-06 FLST/C/F/S, FXST/C/S	70-660262 70-660328 70-660158 70-660380	70-670262 70-670328 70-670158 70-670380	38666-00	Std -2.0 2 4 6 8 10	64.8 62.8 66.8 68.8 70.8 72.8 74.8	2.9 2.8 2.8 2.6 2.6 2.6 2.8
'00-06 FXSTB	70-660262 70-660326 70-660328 70-660380 70-660170	70-670262 70-670328 70-670380 70-670170	38665-00	Std 6 8 10 12 14 16.0	58.7 64.8 66.8 68.8 70.8 72.8 74.8	2.9 2.9 2.8 2.8 2.6 2.6 2.8

- WINDSHIELDS / FAIRINGS
- AUDIO / COMMUNICATION
- SEATS / LUGGAGE
- BAR / MIRRORS / CONTROLS
- EXHAUST
- AIR / FUEL SYSTEMS
- ENGINE
- TRANSMISSION / DRIVELINE
- GASKETS / SEALS
- ELECTRICAL
- LIGHTING
- CABLES**
- BRAKES
- OIL FILTERS
- SUSPENSION
- BODY
- WHEELS
- TIRES / TIRE ACC.
- BIKE ACC.
- VICTORY / INDIAN
- COVERS / LOCKS / TIEDOWNS
- CHEMICALS
- TOOLS
- HELMETS
- HELMET ACC.
- EYEWEAR
- APPAREL / RIDER ACC.
- PROMOTIONAL
- REFERENCE
- INDEX



# ARMOR COAT CLUTCH CABLES



- WINDSHIELDS / FAIRINGS
- AUDIO / COMMUNICATION
- SEATS / LUGGAGE
- BARS / MIRRORS / CONTROLS
- EXHAUST
- AIR / FUEL SYSTEMS
- ENGINE
- TRANSMISSION / DRIVELINE
- GASKETS / SEALS
- ELECTRICAL
- LIGHTING
- CABLES**
- BRAKES
- OIL FILTERS
- SUSPENSION
- BODY
- WHEELS
- TIRES / TIRE ACC.
- BIKE ACC.
- VICTORY / INDIAN
- COVERS / LOCKS / TIEDOWNS
- CHEMICALS
- TOOLS
- HELMETS
- HELMET ACC.
- EYEWEAR
- APPAREL / RIDER ACC.
- PROMOTIONAL
- REFERENCE
- INDEX

Application	Coil Wound	Longitudinally Wound	OEM#	Over/Under	Housing Length	Free length		
<b>SOFTAIL (CONT'D...)</b>								
'00-06 FXSTD, '05-06 FLSTN	70-660158	70-670158	38664-00	Std	62.8	2.8		
	70-660326			-4	58.7	2.9		
	70-660328	70-670328		2	64.8	2.9		
	70-660380	70-670380		4	66.8	2.8		
	70-660170	70-670170		6	68.8	2.8		
		70-670409		8	70.8	2.6		
		70-670410		10	74.8	2.8		
'07-10 FLSTC, FXST/C, '07 FLSTF, FLSTSC, '08-10 FXCW/C	70-660262	70-670410	38666-07/A/B	10	74.8	2.8		
	70-660262	70-670262		12	74.8	2.8		
		70-670394		Std	64.8	3.2		
		70-670393		4	68.8	3.2		
		70-670397		6	70.7	3.2		
		70-670405		8	72.8	3.2		
		70-670406		10	74.7	3.2		
'11-13 FLSTC, FXST/C, '11 FXCWC		70-670407	38666-07C	12	76.7	3.2		
		70-670408		14	78.7	3.2		
		70-670394		-1	64.8	3.2		
		70-670393		3	68.8	3.2		
		70-670397		5	70.7	3.2		
		70-670405		7	72.8	3.2		
		70-670406		9	74.7	3.2		
'09-11 FLSTSB		70-670407	38883-08A	11	76.7	3.2		
		70-670408		13	78.7	3.2		
		70-670391		Std	65.5	3.2		
	'13-14 FLS, '07-13 FLSTN, '07 FXSTD, '08-13 FLSTF/B	70-670390		38664-07	Std	63	3.2	
	<b>DYNA/FXR</b>							
	'71-78 FX 1200, '73-84 FXE, '77-84 FXS, '79-85 FXEF, '80-82 FXB, '80-86 FXWG, '83-85 FXSB	70-660025			38618-68A/B/C	Std	52.1	5.7
		70-660026				6	58.1	5.7
'83-86 FXR/D/DG/P/S/T	70-660072		38599-83A	Std	53.3	4.5		
	70-660223			6	59.3	4.5		
'87-88 FXRP	70-660158	70-670158	38607-87A	Std	62.8	2.8		
	70-660326			-4	58.7	2.9		
	70-660380	70-670380		4	66.8	2.8		
	70-660170	70-670170		6	68.7	2.8		
		70-670409		8	70.8	2.6		
		70-670410		10	72.8	2.6		
		70-670262		12	74.8	2.8		
'87-94 FXLR	70-660157		36753-87/A	Std	60.7	2.5		
	70-660156			-3	57.7	2.5		
	70-660159	70-670159		3	63.7	2.5		
	70-660169			6	66.7	2.5		
	70-660171			9	69.7	2.5		
'87-94 FXR/D/S/T	70-660159	70-670159	38606-87A	Std	63.7	2.5		
	70-660156			-6	57.7	2.5		
	70-660157			-3	60.7	2.5		
	70-660169			2	66.7	2.5		
	70-660169			3	66.7	2.5		
	70-660171			6	69.7	2.5		
'87-93 FXRS-SP	70-660156		36755-87/A	Std	57.7	2.5		
	70-660157			3	60.7	2.5		
	70-660159	70-670159		6	63.7	2.5		
	70-660169			9	66.7	2.5		
	70-660171			12	69.7	2.5		
'92 FXDC/FXDB-D, '93-99 FXDL/FXDWG, '95-99 FXD/S	70-660170	70-670170	38602-92	Std	68.7	2.8		
	70-660380	70-670380		-2	66.8	2.8		
	70-660328	70-670328		-4	64.8	2.9		
	70-660158	70-670158		-6	62.8	2.8		
		70-670409		2	70.8	2.6		
		70-670410		4	72.8	2.6		
		70-670262		6	74.8	2.8		
'91 FXDB-S, '99 FXDX	70-660262	70-670262	38604-90A	Std	64.8	2.9		
	70-660328	70-670328		-2	62.8	2.8		
	70-660158	70-670158		2	66.8	2.8		
	70-660380	70-670380		4	68.8	2.6		
		70-670170		6	70.8	2.6		
	70-670409	8	72.8	2.6				
	70-670410							



# ARMOR COAT CLUTCH CABLES



Application	Coil Wound	Longitudinally Wound	OEM#	Over/Under	Housing Length	Free length
<b>DYNA/FXR (CONT'D...)</b>						
'00 FXDL/FXDS, '00-05 FXDWG	70-660170 70-660158 70-660328 70-660380	70-670170 70-670158 70-670328 70-670380 70-670409 70-670410	38661-00	Std -6 -4 -2 2 4 6	68.7 62.8 64.8 66.8 70.8 72.8 74.8	2.8 2.8 2.9 2.8 2.6 2.6 2.8
'00-05 FXD/C/X, '01-05 FXDL	70-660262 70-660328 70-660158 70-660380 70-660170	70-670262 70-670328 70-670158 70-670380 70-670170 70-670409 70-670410 70-670262	38666-00	Std -2 2 3 6 8 10	64.8 62.8 66.8 68.7 70.8 72.8 74.8	2.9 2.8 2.8 2.8 2.6 2.6 2.8
'06-10 FXD, '07 FXDC, 10-13 FXDWG		70-670394 70-670393 70-670397 70-670405 70-670406 70-670407 70-670408	38787-06/A/C	Std 4 6 8 10 12 14	64.8 68.8 70.7 72.8 74.7 76.7 78.7	3.2 3.2 3.2 3.2 3.2 3.2 3.2
'06 FXDL		70-670391	38788-06	Std	65.5	3.2
'06-08 FXDWG, '06-13 FXDB, '13 FXDBP W/OE Mini Ape Bars		70-670393 70-670394 70-670397 70-670405 70-670406 70-670407 70-670408	38789-06/A/C	Std -4 2 4 6 8 10	68.8 64.8 70.7 72.8 74.7 76.7 78.7	3.2 3.2 3.2 3.2 3.2 3.2 3.2
'08-13 FXDF, '13 FXDBP W/OE Drag Bars		70-670394 70-670393 70-670407 70-670397 70-670405 70-670406 70-670407 70-670408	38785-08/A	3.5 7.5 8.5 9.5 11.5 13.5 15.5 17.5	64.8 68.8 76.7 70.7 72.8 74.7 76.7 78.7	3.2 3.2 3.2 3.2 3.2 3.2 3.2 3.2
12-13 FLD, '07-13 FXDC/FXDL, '13 FXDBP W/OE Pull Back Bars		70-670391	38788-06C	Std	65.5	3.2
<b>SPORTSTER</b>						
'71-79 XLCH, '71-85 XLH, '77 XLT, '84 XLS	70-660252		38619-84	Std	53.3	7.7
'82-83 XLS, '84 XR1000	70-660029		38619-71B	Std	47.3	7
'83 XLX	70-660072		38626-77B	Std		
'86-91 XLH 883 DLX, '86-99 XLH 883, '96-99 XLH 1200S	70-660155 70-660287 70-660287 70-660167 70-660160 70-660158 70-660380 70-660170	70-670155 70-670287 70-670287 70-670167 70-670160 70-670158 70-670380 70-670170 70-670409 70-670410	38619-86A	Std 3 4 6 8 10 14 16 18 20	52.8 57.2 57.2 58.7 61.2 62.8 66.8 68.8 70.8 72.8	2.6 2.6 2.6 2.6 2.6 2.6 2.6 2.6 2.6 2.6
'96-99 XLH883HUG/XLH1200/XL1200C, '99 XLH 883C	70-660287 70-660155 70-660167 70-660160	70-670287 70-670155 70-670167 70-670160 70-670160 70-670158	38620-96	Std -5 1 3 4 5 6 8	57.2 52.8 58.7 61.2 61.2 62.8 58.7 61.2	2.6 2.6 2.6 2.6 2.6 2.6 2.8 2.8

- WINDSHIELDS / FAIRINGS
- AUDIO / COMMUNICATION
- SEATS / LUGGAGE
- BAR / MIRRORS / CONTROLS
- EXHAUST
- AIR / FUEL SYSTEMS
- ENGINE
- TRANSMISSION / DRIVELINE
- GASKETS / SEALS
- ELECTRICAL
- LIGHTING
- CABLES**
- BRAKES
- OIL FILTERS
- SUSPENSION
- BODY
- WHEELS
- TIRES / TIRE ACC.
- BIKE ACC.
- VICTORY / INDIAN
- COVERS / LOCKS / TIEDOWNS
- CHEMICALS
- TOOLS
- HELMETS
- HELMET ACC.
- EYEWEAR
- APPAREL / RIDER ACC.
- PROMOTIONAL
- REFERENCE
- INDEX



# ARMOR COAT CLUTCH CABLES

Application	Coil Wound	Longitudinally Wound	OEM#	Over/Under	Housing Length	Free length
<b>SPORTSTER (CONT'D...)</b>						
'86-87 XLH1100, '88-95 XLH1200, '92-95 XLH883 DLX, '87-95 XLH883 HUGGER	70-660160	70-670160	38621-86A	Std	61.2	2.6
	70-660287	70-670287		-4	57.2	2.6
		70-670167		-3	58.7	2.6
	70-660158	70-670158		1	62.8	2.6
	70-660380	70-670380		5	66.8	2.6
	70-660170	70-670170		7	68.8	2.6
		70-670409		9	70.8	2.6
	70-670410	11	72.8	2.6		
	70-670262	13	74.8	2.6		
'00-03 XLH 883C, '00 XLH883/XL1200C/S, '01-03 XLH1200/XLH883HUG	70-660287	70-670287	38662-00	Std	57.2	2.6
	70-660155	70-670155		-5	52.8	2.6
	70-660167	70-670167		1	58.7	2.6
	70-660160	70-670160		3	61.2	2.6
	70-660160	70-670160		4	61.2	2.6
	70-660158	70-670158		5	62.8	2.6
	70-660158	70-670158		8	62.8	2.6
	70-660158	70-670158		10	62.8	2.6
	70-660170	70-670158		16	68.7	2.8
		70-670155		Std	52.8	2.6
'00 XLH1200, '01-03 XL1200C/S, '00 XLH883 HUG, '01-03 XLH883, '02-03 XL883R	70-660167		38663-00	1	58.7	2.8
	70-660287	70-670287		3	57.2	2.6
	70-660287	70-670287		4	57.2	2.6
	70-660167	70-670167		6	58.7	2.6
	70-660160	70-670160		8	61.2	2.6
	70-660158	70-670158		10	62.8	2.6
	70-660380	70-670380		14	66.8	2.6
	70-660170	70-670170		16	68.8	2.6
		70-670409		18	70.8	2.6
		70-670410		20	72.8	2.6
'04-08 XL1200C/R, '04-08 XLH883C/R, '05 XL883L	70-660369	70-670369	38699-04/A	Std	54.8	2.6
	70-660287	70-670287		2	57.2	2.6
	70-660167	70-670167		3	58.7	2.6
	70-660160	70-670160		6	61.2	2.6
		70-670158		8	62.8	2.6
	70-660369	70-670369		Std	54.8	2.6
	70-660369	70-670369		Std	54.8	2.6
'09-10 XLH883C/XL1200C, '09-13 XL883N/R, '11-13 XL883L, '12-17 XL1200X, '12-13 XL1200C	70-660369	70-670369	38699-04C/D	Std	54.8	2.6
		70-670398	38702-05/A	Std	57.1	2.7

## ARMOR COAT CLUTCH CABLES

WPS#	WPS#	WPS#
70-660025	70-660328	70-670391
70-660026	70-660357	70-670393
70-660029	70-660368	70-670394
70-660072	70-660369	70-670395
70-660155	70-660380	70-670396
70-660156	70-670155	70-670397
70-660157	70-670158	70-670398
70-660158	70-670159	70-670399
70-660159	70-670160	70-670400
70-660160	70-670167	70-670401
70-660167	70-670170	70-670402
70-660169	70-670262	70-670403
70-660170	70-670287	70-670404
70-660171	70-670328	70-670405
70-660223	70-670357	70-670406
70-660252	70-670368	70-670407
70-660262	70-670369	70-670408
70-660287	70-670380	70-670409
70-660326	70-670390	70-670410

# ARMOR COAT SPEEDO CABLES



Application	Plus/ Minus	OEM#	WPS#	Length	
<b>TOURING MODELS</b>					
'81-84 FL/H, '87-94 FLHS	Std	67026-81	<b>70-660131</b>	35	
	4.0		<b>70-660129</b>	39	
	6.0		<b>70-660133</b>	41.4	
'81-84 FLH, '87-88 FLHS	6.0	67060-79A	<b>70-660133</b>	41.4	
	'83 FLHT		Std	67060-79A	<b>70-660129</b>
'83-85 FLHT/C, '80-83 FLT, '80-86 FLTC	Std	67072-79A	<b>70-660129</b>	39	
	-4.0		<b>70-660131</b>	35	
	2.0		<b>70-660133</b>	41.4	
'84-85 FLHTP	Std	67072-79	<b>70-660129</b>	39	
	-4.0		<b>70-660131</b>	35	
	2.0		<b>70-660133</b>	41.4	
'86 FLHT/C, '86 FLHTP	-2.0	67060-86A	<b>70-660133</b>	41.4	
	-6.0		<b>70-660129</b>	39	
	-10.0		<b>70-660131</b>	35	
'87-88 FLHTP, '87, 95 FLHT, '90-95 FLHTC	Std	67060-87A	<b>70-660129</b>	39	
	-4.0		<b>70-660131</b>	35	
	2.0		<b>70-660133</b>	41.4	
'87-89 FLHTC	Std	67060-86A	<b>70-660129</b>	39	
	-4.0		<b>70-660131</b>	35	
	2.0		<b>70-660133</b>	41.4	
'87-94 FLHS, '87-91 FLTC	Std	67072-87B	<b>70-660131</b>	35	
	4.0		<b>70-660129</b>	39	
	6.0		<b>70-660133</b>	41.4	
'89-95 FLHTCU	4.0	67060-87A	<b>70-660129</b>	39	
	6.0		<b>70-660133</b>	41.4	
'96-97 FLHT/C/U	Std	67060-96	<b>70-660263</b>	36.7	
	-1.0		<b>70-660128</b>	40	
	2.0		<b>70-660132</b>	43	
	4.0		<b>70-660129</b>	39	
'98-99 FLTR	5.0	67051-73A	<b>70-660135</b>	46.6	
	Std		<b>70-660128</b>	40	
	3.0		<b>70-660132</b>	43	
	6.0		<b>70-660135</b>	46.6	
<b>SOFTAIL</b>					
'86-95 FXST/C/S/SB	Std	67024-84A	<b>70-660129</b>	39	
	-4.0		<b>70-660131</b>	35	
	2.0		<b>70-660133</b>	41.4	
'86-95 FLST/C/F/N	Std	67079-86A	<b>70-660131</b>	35	
	4.0		<b>70-660129</b>	39	
	6.0		<b>70-660133</b>	41.4	
<b>DYNA/FXR</b>					
'73 FXB, '77 FXRT, '80 FX, '85 FXRG, '86 FXLR, '87 FXEF '73-78 FX/E, '77-80 FXS	1.0	67063-89	<b>70-660263</b>	36.7	
	Std		67051-73	<b>70-660128</b>	40
	3.0		<b>70-660132</b>	43	
'79-84 FXEF, '80-82 FXB, '81-84 FXE, '81-85 FXS/B, '85 FXRP	6.0	67052-78A	<b>70-660135</b>	46.6	
	Std		<b>70-660128</b>	40	
	3.0		<b>70-660132</b>	43	
'82-83 FXR/S, '84 FXRP	6.0	67060-79A/B	<b>70-660135</b>	46.6	
	Std		<b>70-660133</b>	41.4	
	-6.0		<b>70-660131</b>	35	
'83 FXRS-SP	-2.0	67063-89	<b>70-660129</b>	39	
	-6.0		<b>70-660263</b>	36.7	

- WINDSHIELDS / FAIRINGS
- AUDIO / COMMUNICATION
- SEATS / LUGGAGE
- BARS / MIRRORS / CONTROLS
- EXHAUST
- AIR / FUEL SYSTEMS
- ENGINE
- TRANSMISSION / DRIVELINE
- GASKETS / SEALS
- ELECTRICAL
- LIGHTING
- CABLES**
- BRAKES
- OIL FILTERS
- SUSPENSION
- BODY
- WHEELS
- TIRES / TIRE ACC.
- BIKE ACC.
- VICTORY / INDIAN
- COVERS / LOCKS / TIEDOWNS
- CHEMICALS
- TOOLS
- HELMETS
- HELMET ACC.
- EYEWEAR
- APPAREL / RIDER ACC.
- PROMOTIONAL
- REFERENCE
- INDEX



# ARMOR COAT SPEEDO CABLES

- WINDSHIELDS / FAIRINGS
- AUDIO / COMMUNICATION
- SEATS / LUGGAGE
- BARS / MIRRORS / CONTROLS
- EXHAUST
- AIR / FUEL SYSTEMS
- ENGINE
- TRANSMISSION / DRIVELINE
- GASKETS / SEALS
- ELECTRICAL
- LIGHTING
- CABLES**
- BRAKES
- OIL FILTERS
- SUSPENSION
- BODY
- WHEELS
- TIRES / TIRE ACC.
- BIKE ACC.
- VICTORY / INDIAN
- COVERS / LOCKS / TIEDOWNS
- CHEMICALS
- TOOLS
- HELMETS
- HELMET ACC.
- EYEWEAR
- APPAREL / RIDER ACC.
- PROMOTIONAL
- REFERENCE
- INDEX

Application	Plus/Minus	OEM#	WPS#	Length
<b>DYNA/FXR (CONT'D...)</b>				
'83 FXRT	Std	67054-83A	<b>70-660135</b>	46.6
	-4.0		<b>70-660132</b>	43
	-7.0		<b>70-660128</b>	40
'84 FXRD	-6.0	67063-89	<b>70-660263</b>	36.7
'84 FXRDG	Std	67054-83A/B	<b>70-660135</b>	46.6
'84 FXRP	1.0	67060-79A/B	<b>70-660263</b>	36.7
'84-86 FXST/FXDWG	Std	67038-84	<b>70-660129</b>	39
	-4.0		<b>70-660131</b>	35
	2.0		<b>70-660133</b>	41.4
'84-87 FXRS	Std	67052-78B	<b>70-660128</b>	40
	3.0		<b>70-660132</b>	43
	6.0		<b>70-660135</b>	46.6
'84-92 FXRT, '86 FXRD	Std	67054-83B	<b>70-660135</b>	46.6
	-4.0		<b>70-660132</b>	43
	-6.0		<b>70-660263</b>	36.7
	-7.0		<b>70-660128</b>	40
'85 FXEF	4.0	67077-85	<b>70-660128</b>	40
	5.0		<b>70-660263</b>	36.7
	7.0		<b>70-660132</b>	43
	10.0		<b>70-660135</b>	46.6
'85 FXR	-2.0	67063-89	<b>70-660263</b>	36.7
'85 FXRT, '87-93 FXRS-SP, '90-94 FXRS-CON	Std	67048-83A / 67063-89	<b>70-660263</b>	36.7
	-1.0		<b>70-660128</b>	40
	2.0		<b>70-660132</b>	43
	5.0		<b>70-660135</b>	46.6
'85-86 FXRC, '85-86 FXRS-SP, 87-88 FXRP	Std	67052-78B	<b>70-660132</b>	43
	3.0		<b>70-660135</b>	46.6
'86-94 FXR/FXLR	Std	67078-85A	<b>70-660128</b>	40
	1.0		<b>70-660263</b>	36.7
	2.0		<b>70-660132</b>	43
	3.0		<b>70-660132</b>	43
'88-92 FXRS, '91 FXSB-S, '92 FXDC/B-D, 93-94 FXDL	6.0	67186-88	<b>70-660135</b>	46.6
	Std		<b>70-660131</b>	35
	4.0		<b>70-660129</b>	39
'90-92 FXRS	6.0	670186-88	<b>70-660133</b>	41.4
	Std		<b>70-660131</b>	35
	6.0		<b>70-660133</b>	41.4
'93-94 FXDWG	Std	67024-84A	<b>70-660129</b>	39
	-4.0		<b>70-660131</b>	35
	2.0		<b>70-660133</b>	41.4
<b>SPORTSTER</b>				
'73 XLH/XLCH	Std	67051-73	<b>70-660128</b>	40
	3.0		<b>70-660132</b>	43
	6.0		<b>70-660135</b>	46.6
'74-79 XLCH, '74-83 XLH, '77-78 XLR, '77 XLT	Std	67051-74	<b>70-660129</b>	39
	-4.0		<b>70-660131</b>	35
	2.0		<b>70-660133</b>	41.4
	Std		<b>70-660133</b>	41.4
'79-82 XLS	Std	67060-79A	<b>70-660133</b>	41.4
'83 XLS	Std	67054-83A/B	<b>70-660135</b>	46.6
'83-84 XR1000	Std	67054-83A/B	<b>70-660128</b>	40
	6.0		<b>70-660135</b>	46.6
	Std		<b>70-660128</b>	40
'83-85 XLX	Std	67052-78A	<b>70-660128</b>	40
	3.0		<b>70-660132</b>	43
	6.0		<b>70-660135</b>	46.6
'84-85 XLH	Std	67052-78B	<b>70-660128</b>	40
	3.0		<b>70-660132</b>	43
	6.0		<b>70-660135</b>	46.6
'85 XLS	-1.0	67048-83	<b>70-660128</b>	40
	2.0		<b>70-660132</b>	43
	5.0		<b>70-660135</b>	46.6
'86-90 XLH 883/DLX/HUG, '86-87 XLH 1100, '88-92 XLH 1201	Std	67052-78B	<b>70-660132</b>	43
	3.0	67052-78B	<b>70-660135</b>	46.6
'91-94 XLH883/DLX/HUG, '93-94 XLH 1200	Std	67063-89	<b>70-660263</b>	36.7
	-1.0		<b>70-660128</b>	40
	2.0		<b>70-660132</b>	43
	2.0		<b>70-660132</b>	43
	5.0		<b>70-660135</b>	46.6

# BLACKOUT THROTTLE & IDLE CABLES



Application	Throttle	OEM#	Plus/ Minus	Housing Length inches	Idle	OEM#	Housing Length Inches	Elbow
<b>TOURING</b>								
'02 FLTR	<b>70-62302</b>	56376-96	Std	39.2				90
'98-01 FLTR	<b>70-62278</b>	56327-96	Std	37.5	<b>70-62279</b>	56351-96	38	70
'96-07 FLHR	<b>70-62302</b>	56376-96	Std	39.2	<b>70-62303</b>		38.6	90
<b>SOFTAIL</b>								
'90-95 FXSTS	<b>70-62194</b>	56306-90	-3.0	29.5	<b>70-62196</b>	56305-90	29.6	90
'90-95 FLST/C/F/N, FXST/C/SB	<b>70-62194</b>	56343-90	Std	29.5	<b>70-62196</b>	56342-90	29.6	90
	<b>70-62208</b>		6.0	35.6	<b>70-62214</b>		35.6	90
'96-00 FLSTC/F/N/S, FXST/C/SB	<b>70-62266</b>	56343-96	Std	29.6	<b>70-62267</b>	56342-96	29.6	90
	<b>70-62318</b>		-4.0	25.6	<b>70-62319</b>		25.6	90
	<b>70-62274</b>		2.0	32.1	<b>70-62275</b>		31.3	90
	<b>70-62268</b>		6.0	35.6	<b>70-62269</b>		35.6	90
	<b>70-62302</b>		9.0	39.2	<b>70-62303</b>		38.6	90
'96-03 FXSTS	<b>70-62278</b>	56306-96	5.0	37.5	<b>70-62279</b>	56305-96	38	70
	<b>70-62266</b>		-3.0	29.6	<b>70-62267</b>		29.6	90
99-09 FXSTB, '10-11 FLSTFB, '12-13 FXS	<b>70-62318</b>	56432-98	Std	25.6	<b>70-62319</b>	56433-98	25.6	90
	<b>70-62266</b>		3.5	29.6	<b>70-62267</b>		29.6	90
	<b>70-62268</b>		9.5	35.6	<b>70-62269</b>		35.6	90
	<b>70-62274</b>		6.0	32.1	<b>70-62275</b>		31.3	90
	<b>70-62302</b>		12.5	39.2	<b>70-62303</b>		38.6	90
'01-09 FLST/C/S/SC, '01-13 FLSTF/B, '01-13 FXST/D, '04-07 FXSTS, '05-13 FLSTN, '08-11 FXCW/C, '13-14 FLS	<b>70-62266</b>	56343-01	Std	29.6	<b>70-62267</b>	56342-01	29.6	90
	<b>70-62318</b>		-4.0	25.6	<b>70-62319</b>		25.6	90
	<b>70-62274</b>		2.0	32.1	<b>70-62275</b>		31.3	90
	<b>70-62268</b>		6.0	35.6	<b>70-62269</b>		35.6	90
	<b>70-62302</b>		9.0	39.2	<b>70-62303</b>		38.6	90
'07 FXSTC	<b>70-62274</b>	56939-07	Std	32.1	<b>70-62275</b>	56934-07	31.3	90
	<b>70-62266</b>		-2.5	29.6	<b>70-62267</b>		29.6	90
	<b>70-62318</b>		-6.0	25.6	<b>70-62319</b>		25.6	90
	<b>70-62268</b>		3.0	35.6	<b>70-62269</b>		35.6	90
	<b>70-62302</b>		6.0	39.2	<b>70-62303</b>		38.6	90
'08-11 FLSTSB, '08-10 FXSTC, '10-13 FLSTC	<b>70-62274</b>	56939-07A	-1.0	32.1	<b>70-62275</b>	56934-07A	31.3	90
	<b>70-62266</b>		-3.5	29.6	<b>70-62267</b>		29.6	90
	<b>70-62318</b>		-7.5	25.6	<b>70-62319</b>		25.6	90
	<b>70-62268</b>		2.5	35.6	<b>70-62269</b>		35.6	90
	<b>70-62302</b>		5.5	39.2	<b>70-62303</b>		38.6	90
<b>DYNA/FXR</b>								
'91 FXDB-S, '90-94 FXR/S/T, '90-94 FXLR, '90-94 FXRS-CON, '90-93 FXRS-SP	<b>70-62194</b>	56343-90	Std	29.5	<b>70-62196</b>	56342-90	29.6	90
'92 FXDB/FXDC, '93-95 FXDL/FXDWG, '95 FXD/S	<b>70-62208</b>	56356-92	3.0	35.6	<b>70-62214</b>	56355-92	35.6	90
'91 FXDB-S, '90-94 FXR/S/T, '90-94 FXLR, '90-94 FXRS-CON, '90-93 FXRS-SP	<b>70-62208</b>	56343-90	6.0	35.6	<b>70-62214</b>	56342-90	35.6	90
'96-08 FXDWG, '96-00 FXDS, '96-05 FXD/L, FXDX/T '99-05 '05 FXDC, '06 FXDB	<b>70-62274</b>	56356-96	Std	32.1	<b>70-62275</b>	56355-96/A	31.3	90
	<b>70-62266</b>		-2.5	29.6	<b>70-62267</b>		29.6	90
	<b>70-62318</b>		-6.0	25.6	<b>70-62319</b>		25.6	90
	<b>70-62302</b>		7.0	39.2	<b>70-62303</b>		38.6	90

- WINDSHIELDS / FAIRINGS
- AUDIO / COMMUNICATION
- SEATS / LUGGAGE
- BARS / MIRRORS / CONTROLS
- EXHAUST
- AIR / FUEL SYSTEMS
- ENGINE
- TRANSMISSION / DRIVELINE
- GASKETS / SEALS
- ELECTRICAL
- LIGHTING
- CABLES**
- BRAKES
- OIL FILTERS
- SUSPENSION
- BODY
- WHEELS
- TIRES / TIRE ACC.
- BIKE ACC.
- VICTORY / INDIAN
- COVERS / LOCKS / TIEDOWNS
- CHEMICALS
- TOOLS
- HELMETS
- HELMET ACC.
- EYEWEAR
- APPAREL / RIDER ACC.
- PROMOTIONAL
- REFERENCE
- INDEX



# BLACKOUT THROTTLE & IDLE CABLES

- WINDSHIELDS / FAIRINGS
- AUDIO / COMMUNICATION
- SEATS / LUGGAGE
- BARS / MIRRORS / CONTROLS
- EXHAUST
- AIR / FUEL SYSTEMS
- ENGINE
- TRANSMISSION / DRIVELINE
- GASKETS / SEALS
- ELECTRICAL
- LIGHTING
- CABLES**
- BRAKES
- OIL FILTERS
- SUSPENSION
- BODY
- WHEELS
- TIRES / TIRE ACC.
- BIKE ACC.
- VICTORY / INDIAN
- COVERS / LOCKS / TIEDOWNS
- CHEMICALS
- TOOLS
- HELMETS
- HELMET ACC.
- EYEWEAR
- APPAREL / RIDER ACC.
- PROMOTIONAL
- REFERENCE
- INDEX

Application	Throttle	OEM#	Plus/Minus	Housing Length inches	Idle	OEM#	Housing Length Inches	Elbow
<b>DYNA/FXR (CONT'D...)</b>								
'06 FXDC, '06-10 FXD, '08-13 FXDF	<b>70-62266</b>	56633-06	1.5	29.6	<b>70-62267</b>	56634-06	29.6	90
	<b>70-62318</b>		-2.0	25.6	<b>70-62319</b>		25.6	90
	<b>70-62268</b>		7.5	35.6	<b>70-62269</b>		35.6	90
	<b>70-62274</b>		4.0	32.1	<b>70-62275</b>		31.3	90
	<b>70-62302</b>		11.0	39.2	<b>70-62303</b>		38.6	90
'06-13 FXDL, '07-13 FXDC, '10-13 FXDWG, '12-13 FLD, '13 FXDBP W/OE Drag and Pull Back Bars	<b>70-62266</b>	56421-06	Std	29.6	<b>70-62267</b>	56415-06	29.6	90
	<b>70-62318</b>		-4.0	25.6	<b>70-62319</b>		25.6	90
	<b>70-62274</b>		2.0	32.1	<b>70-62275</b>		31.3	90
	<b>70-62268</b>		6.0	35.6	<b>70-62269</b>		35.6	90
	<b>70-62302</b>		9.0	39.2	<b>70-62303</b>		38.6	90
'07-13 FXDB, '13 FXDBP W/OE Mini Ape Bars	<b>70-62266</b>	56356-96A	Std	29.6	<b>70-62267</b>	56355-96A	29.6	90
	<b>70-62318</b>		-4.0	25.6	<b>70-62319</b>		25.6	90
	<b>70-62274</b>		2.0	32.1	<b>70-62275</b>		31.3	90
	<b>70-62268</b>		6.0	35.6	<b>70-62269</b>		35.6	90
	<b>70-62302</b>		9.0	39.2	<b>70-62303</b>		38.6	90
<b>SPORTSTER</b>								
'96-06 XL1200/XL883	<b>70-62282</b>	56400-96	Std	30				45
	<b>70-62396</b>		6	36.1				45
	<b>70-62398</b>		10	40				45
'07-13 XL1200/XL883	<b>70-62401</b>	56884-07	-3	26.9	<b>70-62402</b>	56885-07	27.1	90
	<b>70-62282</b>		Std	30	<b>70-62394</b>		30.1	0
	<b>70-62396</b>		6.0	36.1	<b>70-62397</b>		36.1	0
	<b>70-62398</b>		10.0	40	<b>70-62399</b>		40.1	0

## BLACKOUT THROTTLE & IDLE CABLE

WPS#	WPS#
<b>70-62194</b>	<b>70-62282</b>
<b>70-62196</b>	<b>70-62302</b>
<b>70-62208</b>	<b>70-62303</b>
<b>70-62214</b>	<b>70-62318</b>
<b>70-62266</b>	<b>70-62319</b>
<b>70-62267</b>	<b>70-62394</b>
<b>70-62268</b>	<b>70-62396</b>
<b>70-62269</b>	<b>70-62397</b>
<b>70-62274</b>	<b>70-62398</b>
<b>70-62275</b>	<b>70-62399</b>
<b>70-62278</b>	<b>70-62401</b>
<b>70-62279</b>	<b>70-62402</b>

# BLACKOUT CLUTCH CABLES



Application	Longitudinally Wound	OEM#	Over/Under	Housing Length	Free length
<b>TOURING</b>					
'87-99 All Touring models	70-62145	38607-87B/38601-89	Std	62.8	2.6
	70-62327		-4	58.9	2.6
	70-62164		6	68.8	2.6
	70-62261		12	74.8	2.6
'08-14 All Touring models	70-62390	38667-08A	Std	62.8	3.7
	70-62391		6	68.9	3.7
	70-62392		12	74.8	3.7
<b>SOFTAIL</b>					
'87-99 FLST/C/F/N/S, FXST/C/S	70-62145	38607-87A	Std	62.8	2.6
	70-62327		-4	58.9	2.6
	70-62164		6	68.8	2.6
	70-62261		12	74.8	2.6
'95-97 FXSTSB	70-62329	38617-95	Std	64.8	2.6
	70-62145		-2	62.8	2.6
	70-62164		4	68.8	2.6
	70-62261		9	74.8	2.6
'00-06 FXSTD, '05-06 FLSTN	70-62145	38664-00	Std	62.8	2.6
	70-62327		-4	58.9	2.6
	70-62164		6	68.8	2.6
	70-62261		12	74.8	2.6
'00-06 FXSTB	70-62327	38665-00	Std	58.9	2.6
	70-62145		4	62.8	2.6
	70-62329		6	64.8	2.6
	70-62164		10	68.8	2.6
	70-62261		16	74.8	2.6
'00-06 FLST/C/F/S, FXST/C/S	70-62329	38666-00	Std	64.8	2.6
	70-62145		-2	62.8	2.6
	70-62164		4	68.8	2.6
	70-62261		9	74.8	2.6
'07-10 FLSTC, FXST/C, '07-13 FLSTF/B, FLSTSC, '08-10 FXCW/C	70-62379	38666-07	Std	64.8	3.2
'11-13 FLSTC, FXST/C, '11 FXCWC	70-62379	38666-07C	-1	64.8	3.2
'15-17 FLSTC	70-62406	37200119	2.5	68.4	3.7
'15 FXSTC	70-62406	37200119	2	68.4	3.7
'15-17 FLS/FLSTF/B/FLSTN	70-62406	37200117	4.5	68.4	3.7
'15-17 FXSB	70-62406	37200115	7.5	68.4	3.7
<b>DYNA/FXR</b>					
'87-88 FXRP	70-62145	38607-87A	Std	62.8	2.6
'87-94 FXR/D/S/T	70-62146	38606-87A	Std	63.7	2.3
'92 FXDC/FXDB-D, '93-99 FXDL/FXDWG, '95-99 FXD/S	70-62164	38602-92	Std	68.8	2.6
	70-62329		-4	64.8	2.6
	70-62145		-6	62.8	2.6
	70-62261		6	74.8	2.6
'91 FXDB-S, '99 FXDX	70-62329	38604-90A	Std	64.8	2.6
	70-62145		-2	62.8	2.6
	70-62164		4	68.8	2.6
	70-62261		10	74.8	2.6
'00 FXDL/FXDS, '00-05 FXDWG	70-62164	38661-00	Std	68.8	2.6
	70-62329		-4	64.8	2.6
	70-62145		-6	62.8	2.6
	70-62261		6	74.8	2.6
'00-05 FXD/C/X, '01-05 FXDL	70-62329	38666-00	Std	64.8	2.6
	70-62145		-2	62.8	2.6
	70-62164		4	68.8	2.6
	70-62261		10	74.8	2.6
'06-08 FXDWG, '06-13 FXDB, '13 FXDBP W/OE Mini Ape Bars	70-62379	38789-06/A/C	-4	64.8	3.2
'06-10 FXD, '07 FXDC, '10-13 FXDWG	70-62379	38787-06B	Std	64.8	3.2
'07-13 FXDL	70-62403	38788-06A	Std	65.5	3.2
	70-62404		+6	72.5	3.2
'08-13 FXDF, '13 FXDBP W/OE Drag Bars	70-62379	38785-08A	3.5	64.8	3.2

- WINDSHIELDS / FAIRINGS
- AUDIO / COMMUNICATION
- SEATS / LUGGAGE
- BAR / MIRRORS / CONTROLS
- EXHAUST
- AIR / FUEL SYSTEMS
- ENGINE
- TRANSMISSION / DRIVELINE
- GASKETS / SEALS
- ELECTRICAL
- LIGHTING
- CABLES**
- BRAKES
- OIL FILTERS
- SUSPENSION
- BODY
- WHEELS
- TIRES / TIRE ACC.
- BIKE ACC.
- VICTORY / INDIAN
- COVERS / LOCKS / TIEDOWNS
- CHEMICALS
- TOOLS
- HELMETS
- HELMET ACC.
- EYEWEAR
- APPAREL / RIDER ACC.
- PROMOTIONAL
- REFERENCE
- INDEX



## BLACKOUT CLUTCH CABLES

Application	Longitudinally Wound	OEM#	Over/Under	Housing Length	Free length
<b>SPORTSTER</b>					
'86-91 XLH883DLX, '86-99 XLH883, '96-99 XLH1200S	<b>70-62145</b>	38619-86A	10	62.8	2.6
'86-87 XLH1100, '88-95 XLH1200, '92-95 XLH883 DLX, '87-95 XLH883 HUGGER	<b>70-62145</b>	38621-86A	1	62.8	2.6
'96-99 XLH883HUG/XLH1200/XL1200C, '99 XLH 883C	<b>70-62145</b>	38620-96	5	62.8	2.6
'00-03 XLH 883C/HUG, '00 XLH883/XL1200C, '01-03 XLH1200	<b>70-62145</b>	38662-00	5	62.8	2.6
'04-10 XLH883/C/R/XL1200C/R, '09-13 XL883IV/R, '05, '11-13 XL883L, '12-17 XL1200X, '12-13 XL1200C	<b>70-62369</b>	38699-04/A/C/D	Std	54.8	2.7
	<b>70-62389</b>		2	57.1	2.7
	<b>70-62395</b>		8	63.1	2.7
	<b>70-62400</b>		12	67	2.7
'07-10 XL883L, '07-12 XL1200N/L	<b>70-62389</b>	38702-05/A/C	Std	57.1	2.7
	<b>70-62395</b>		6	63.1	2.7
	<b>70-62400</b>		10	67	2.7

## BLACKOUT CLUTCH CABLE

WPS#	WPS#
<b>70-62145</b>	<b>70-62390</b>
<b>70-62146</b>	<b>70-62391</b>
<b>70-62164</b>	<b>70-62392</b>
<b>70-62261</b>	<b>70-62395</b>
<b>70-62327</b>	<b>70-62400</b>
<b>70-62329</b>	<b>70-62403</b>
<b>70-62369</b>	<b>70-62404</b>
<b>70-62379</b>	<b>70-62406</b>
<b>70-62389</b>	

## BLACKOUT SPEEDO CABLES

Application	Plus/Minus	OEM#	WPS#	Length
<b>TOURING MODELS</b>				
'80-86 FLT/C, '83-85 FLHT/C/P, '87-95 FLHTC/U, '87, '95 FLHT, '87-88 FLHTP	Std	67072-79/A	<b>70-62011</b>	39
'81-84 FL/H, '86 FLHT/C/P, '87-91 FLTC, '87-94 FLHS, '89-96 FLTCU, '96-97 FLHT/C/U	Std	67026-81	<b>70-62013</b>	35
'98-99 FLTR	Std	67051-73A	<b>70-62050</b>	40
<b>SOFTAIL</b>				
'84-95 FXST/C/S/SB	Std	67038-84	<b>70-62011</b>	39
'86-95 FLST/C/F/N	Std	67079-86A	<b>70-62013</b>	35
<b>DYNA/FXR</b>				
'73-78 FX/E, '77-80 FXS	Std	67051-73	<b>70-62010</b>	40
'78 FX, '79-84 FXE/F, '80-82 FXB, '81-84 FXS, '83-85 FXSB, '84-87 FXRS, '85 FXRP	Std	67052-78A	<b>70-62010</b>	40
'82-83 FXR/S, '84 FXRP	Std	67060-79A	<b>70-62109</b>	41.4
'84-86 FXWG, '93-94 FXDWG	Std	67024-84A	<b>70-62011</b>	39
'85 FXRP	+3	67052-78A	<b>70-62050</b>	43
'85, 87 FXRC, '85-86 FXRS-SP '86-88 FXRP	Std	67052-78B	<b>70-62050</b>	43
'86-94 FXR/LR	Std	67078-85A	<b>70-62010</b>	40
'88-92 FXRS, '91 FXDB-S, '92 FXDC/B-D, '93-94 FXDL	Std	67186-88	<b>70-62013</b>	35
<b>SPORTSTER</b>				
'73 XLH/CH	Std	67051-73	<b>70-62010</b>	40
'74-83 XLH/CH/CR, '77 XLT	Std	67051-74	<b>70-62011</b>	39
	-4		<b>70-62013</b>	35
'79-82 XLS	Std	67060-79A	<b>70-62109</b>	41.4
	-6		<b>70-62013</b>	35
'83-84 XR1000	Std	67052-78B	<b>70-62010</b>	40
	-3		<b>70-62050</b>	43
'83-85 XLX, '84-85 XLH	Std	67052-78A/B	<b>70-62010</b>	40
'86-90 XLH 883/DLX/HUG, '86-87 XLH 1100, '88-92 XLH1200	Std	67052-78B	<b>70-62050</b>	43



**HYDRAULIC CLUTCH LINES**



Application	Description	WPS#
Fits All Big Twin Models '87-12	62"	<b>817-02000</b>
	63"	<b>817-02001</b>
	65"	<b>817-02002</b>
	67"	<b>817-02003</b>
	68"	<b>817-02004</b>
	69"	<b>817-02005</b>
	70"	<b>817-02006</b>
	71"	<b>817-02007</b>
	73"	<b>817-02008</b>
	75"	<b>817-02009</b>
	77"	<b>817-02010</b>
	79"	<b>817-02011</b>

Application	Description	WPS#
Fits 2013 Big Twin Models ONLY	62"	<b>817-02012</b>
	63"	<b>817-02013</b>
	65"	<b>817-02014</b>
	67"	<b>817-02015</b>
	68"	<b>817-02016</b>
	69"	<b>817-02017</b>
	70"	<b>817-02018</b>
	71"	<b>817-02019</b>
	73"	<b>817-02020</b>
	75"	<b>817-02021</b>
	77"	<b>817-02022</b>
	79"	<b>817-02023</b>

**HYDRAULIC CLUTCH LINES 14-UP FOR TOURING MODELS**

Application	Length	WPS#
<b>CLEAR COATED HOSE CHROME HARDWARE</b>		
Fits All '17-Up Touring Models w/ABS (exc FLTRX/S)	Stock	<b>817-02058</b>
	+2	<b>817-02059</b>
	+4	<b>817-02060</b>
	+6	<b>817-02061</b>
	+8	<b>817-02062</b>
	+10	<b>817-02063</b>
Fits '17-Up FLTRX/S Models	Stock	<b>817-02046</b>
	+2	<b>817-02047</b>
	+4	<b>817-02048</b>
	+6	<b>817-02049</b>
	+8	<b>817-02050</b>
	+10	<b>817-02051</b>
Fits All '14-16 Touring Models w/ABS (exc '15 FLTRX/S)	Stock	<b>817-02024</b>
	+4	<b>817-02030</b>
	+6	<b>817-02031</b>
	+8	<b>817-02032</b>
	+10	<b>817-02033</b>
	Fits '15-16 FLTRX/S Models	Stock
+4		<b>817-02034</b>
+6		<b>817-02035</b>
+8		<b>817-02036</b>
+10		<b>817-02037</b>

Application	Length	WPS#
<b>BLACK HOSE BLACK HARDWARE</b>		
Fits All '17-Up Touring Models w/ABS (exc FLTRX/S)	Stock	<b>817-02064</b>
	+2	<b>817-02065</b>
	+4	<b>817-02066</b>
	+6	<b>817-02067</b>
	+8	<b>817-02068</b>
	+10	<b>817-02069</b>
Fits '17-Up FLTRX/S Models	Stock	<b>817-02052</b>
	+2	<b>817-02053</b>
	+4	<b>817-02054</b>
	+6	<b>817-02055</b>
	+8	<b>817-02056</b>
	+10	<b>817-02057</b>
Fits All '14-16 Touring Models w/ABS (exc '15 FLTRX/S)	Stock	<b>817-02027</b>
	+4	<b>817-02038</b>
	+6	<b>817-02039</b>
	+8	<b>817-02040</b>
	+10	<b>817-02041</b>
	Fits '15-16 FLTRX/S Models	Stock
+4		<b>817-02042</b>
+6		<b>817-02043</b>
+8		<b>817-02044</b>
+10		<b>817-02045</b>

<b>BLACK HOSE, BLACK AT MASTER CYLINDER CHROME AT ACTUATOR</b>		
Fits All '14-16 Touring Models w/ABS (exc '15 FLTRX/S)	Stock	<b>817-02026</b>
Fits '15-16 FLTRX/S Models	Stock	<b>817-02028</b>

- WINDSHIELDS / FAIRINGS
- AUDIO / COMMUNICATION
- SEATS / LUGGAGE
- BARS / MIRRORS / CONTROLS
- EXHAUST
- AIR / FUEL SYSTEMS
- ENGINE
- TRANSMISSION / DRIVELINE
- GASKETS / SEALS
- ELECTRICAL
- LIGHTING
- CABLES**
- BRAKES
- OIL FILTERS
- SUSPENSION
- BODY
- WHEELS
- TIRES / TIRE ACC.
- BIKE ACC.
- VICTORY / INDIAN
- COVERS / LOCKS / TIEDOWNS
- CHEMICALS
- TOOLS
- HELMETS
- HELMET ACC.
- EYEWEAR
- APPAREL / RIDER ACC.
- PROMOTIONAL
- REFERENCE
- INDEX



## CABLE FITTINGS KIT

Description	WPS#
195 Pieces	70-1055



Qty	WPS#	Qty	WPS#	Qty	WPS#
20	70-1000 *	20	70-1004 *	10	70-1009 *
20	70-1001 *	20	70-1005 *	10	70-1010 *
10	70-1002 *	20	70-1006 *	10	70-1011 *
20	70-1003 *	10	70-1007 *	10	70-1012 *
		10	70-1008 *	5	70-1017 **

## SWIVEL HEAD CHROME CABLE CLAMPS

Description	WPS#
A 1 1/4"-1 1/2" Chrome Single Throttle/Clutch	57-10041
1 1/4"-1 1/2" Black Single Throttle/Clutch	57-10090
B 1 1/4"-1 1/2" Chrome Dual Throttle/Clutch	57-10042
1 1/4"-1 1/2" Black Dual Throttle/Clutch	57-10091
1"-1 1/8" chrome single throttle/clutch	57-10043
1"-1 1/8" chrome dual throttle/clutch	57-10044
1 1/4" rubber cable clamp sleeve	57-10045
C 1" rubber cable clamp sleeve	57-10046
D 15/64", 9/32", 5/16", and 11/32" single cable holder	57-10049
E 15/64", 9/32", 5/16", and 11/32" dual cable holder	57-10050
F 15/64" and 9/32" dual throttle/idle cable clamp	57-10094



## CABLE CLAMPS

Description	WPS#
A Clutch cable guide for 1.25" diameter bars, chrome	830-0830
Clutch cable guide for 1.25" diameter bars, black	830-0830B
B Brake line or throttle cable guide for 1.25" dia bars, chrome	830-0831
Brake line or throttle cable guide for 1.25" dia bars, black	830-0831B
C Throttle & idle cable guide for 1.25" dia. bars, chrome	830-0832
Throttle & idle cable guide for 1.25" dia. bars, black	830-0832B
D Throttle, idle, brake line guide for 1.25" dia. bars, chrome	830-0833
Throttle, idle, brake line guide for 1.25" dia. bars, black	830-0833B



WINDSHIELDS / FAIRINGS  
 AUDIO / COMMUNICATION  
 SEATS / LUGGAGE  
 BARS / MIRRORS / CONTROLS  
 EXHAUST  
 AIR / FUEL SYSTEMS  
 ENGINE  
 TRANSMISSION / DRIVELINE  
 GASKETS / SEALS  
 ELECTRICAL  
 LIGHTING  
**CABLES**  
 BRAKES  
 OIL FILTERS  
 SUSPENSION  
 BODY  
 WHEELS  
 TIRES / TIRE ACC.  
 BIKE ACC.  
 VICTORY / INDIAN  
 COVERS / LOCKS / TIEDOWNS  
 CHEMICALS  
 TOOLS  
 HELMETS  
 HELMET ACC.  
 EYEWEAR  
 APPAREL / RIDER ACC.  
 PROMOTIONAL  
 REFERENCE  
 INDEX



## CLUTCH CABLE BRACKET



Description	WPS#
Fits FL Models '65-78 and FX Models '71-78	820-52267

## UNIVERSAL WIRE STOP



Size	WPS#
1/16"	12-3901
1/8"	12-1902

## BRAKE AND CLUTCH CABLE FITTINGS



Nipple type	Size	WPS#
Barrel	3/8" for 2mm wire	70-1002
Barrel	5/16" for 2mm wire	70-1003
Barrel	5/16" for 2.5mm wire	70-1009
Pear	(cable lower) for 2mm wire	70-1007
Pear	(cable lower) for 2.5mm wire	70-1008

## CABLE ADJUSTERS



	WPS#
A	70-1013
B	70-1014
B	70-1015‡
C	70-1017
C	70-10171‡
D	70-10172‡

od pe ag

- WINDSHIELDS / FAIRINGS
- AUDIO / COMMUNICATION
- SEATS / LUGGAGE
- BAR / MIRRORS / CONTROLS
- EXHAUST
- AIR / FUEL SYSTEMS
- ENGINE
- TRANSMISSION / DRIVELINE
- GASKETS / SEALS
- ELECTRICAL
- LIGHTING
- CABLES**
- BRAKES
- OIL FILTERS
- SUSPENSION
- BODY
- WHEELS
- TIRES / TIRE ACC.
- BIKE ACC.
- VICTORY / INDIAN
- COVERS / LOCKS / TIEDOWNS
- CHEMICALS
- TOOLS
- HELMETS
- HELMET ACC.
- EYEWEAR
- APPAREL / RIDER ACC.
- PROMOTIONAL
- REFERENCE
- INDEX

## CONTROL WIRE

Description	Length	WPS#
<b>FOR THROTTLE</b>		
1mm 3/64" O.D.	100 Coil	<b>12-3900</b>
1.5mm 1/16" O.D.	100 Coil	<b>70-1100</b>
<b>FOR CLUTCH &amp; BRAKE</b>		
2mm 5/64" O.D.	100 Coil	<b>70-1101</b>
2.5mm 1/8" O.D.	100 Coil	<b>70-1102</b>



## CONTROL WIRE OUTER HOUSING

Outer Housing	For wire size	Length	WPS#
5mm	1.5mm	22"	<b>12-3905</b>
5mm	1.5mm	60"	<b>12-3907</b>
5mm	1.5mm	50'	<b>70-1104</b>
6mm	2.0mm	50'	<b>70-1105</b>
7mm	2.5mm	50'	<b>70-1103</b>



## THROTTLE CABLE FITTINGS

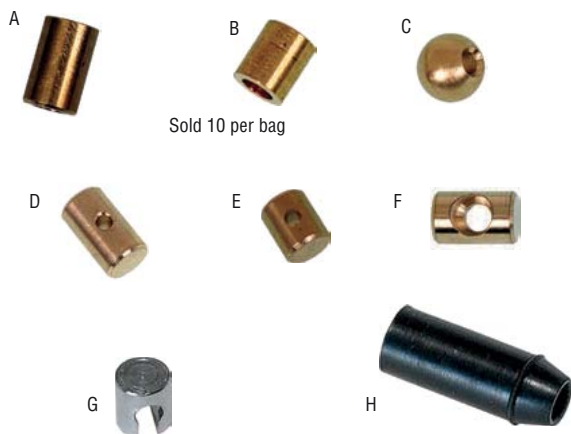

Description	Size	WPS#
A Throttle nipple	carb end for 1.5mm wire	<b>70-1001</b>
B Throttle nipple	short carb end for 1.5mm wire	<b>70-1012</b>
C Throttle nipple	7/32" for 1.5mm wire	<b>70-1000</b>
D Barrel nipple	6 x 10mm for 1.5mm wire	<b>70-1010</b>
E Barrel nipple	6 x 7mm for 1.5mm wire Honda throttle	<b>70-1011</b>
F Brass ferrules	1/4" x 3/8	<b>12-3903</b>
G Slip barrel	6mm x 7mm	<b>70-10032</b>
H Rubber boot	Mikuni adjuster	<b>70-1028</b>

## CABLE HOUSING ENDS



End Size	For Housing	WPS#
6mm	5mm	<b>70-1004</b>
7mm	6mm	<b>70-1005</b>
8mm	7mm	<b>70-1006</b>

## 3 INTO 1 JUNCTION BOX



**WPS#**  
**70-1110**

**TWO-PIECE BRAKE ROTORS**



- Stainless steel outer band
- Designed to match our HardDrive wheels
- Made in the USA



Flow

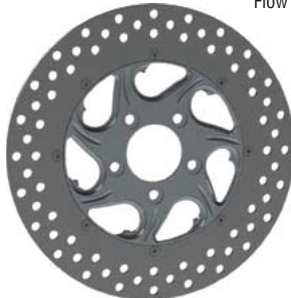

Luck

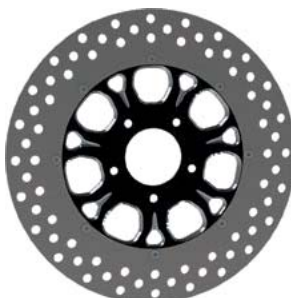
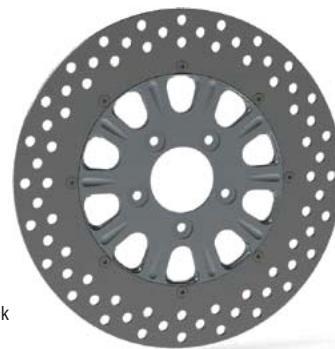

Revolver



Application	Finish	Flow	Luck	Revolver
<b>'00-16 MODELS (EXCEPT '08-UP TOURING, TRIKE, SPRINGERS AND '06-UP DYNA FRONT)</b>				
11.5 Front Left	Black	<b>576-01000</b>	<b>576-01016</b>	<b>576-01024</b>
11.5 Front Right		<b>576-01002</b>	<b>576-01016</b>	<b>576-01024</b>
11.5 Rear Left		<b>576-01004</b>	<b>576-01017</b>	<b>576-01025</b>
11.5 Rear Right		<b>576-01006</b>	<b>576-01017</b>	<b>576-01025</b>
11.5 Front Left	Chrome	<b>576-01008</b>	<b>576-01020</b>	<b>576-01028</b>
11.5 Front Right		<b>576-01010</b>	<b>576-01020</b>	<b>576-01028</b>
11.5 Rear Left		<b>576-01012</b>	<b>576-01021</b>	<b>576-01029</b>
11.5 Rear Right		<b>576-01014</b>	<b>576-01021</b>	<b>576-01029</b>
<b>'08-13 TOURING, TRIKE (FRONT ONLY), '06-UP DYNA (FRONT ONLY)</b>				
11.8 Front Left	Black	<b>576-01001</b>	<b>576-01018</b>	<b>576-01026</b>
11.8 Front Right		<b>576-01003</b>	<b>576-01018</b>	<b>576-01026</b>
11.8 Rear Left		<b>576-01005</b>	<b>576-01019</b>	<b>576-01027</b>
11.8 Rear Right		<b>576-01007</b>	<b>576-01019</b>	<b>576-01027</b>
11.8 Front Left	Chrome	<b>576-01009</b>	<b>576-01022</b>	<b>576-01030</b>
11.8 Front Right		<b>576-01011</b>	<b>576-01022</b>	<b>576-01030</b>
11.8 Rear Left		<b>576-01013</b>	<b>576-01023</b>	<b>576-01031</b>
11.8 Rear Right		<b>576-01015</b>	<b>576-01023</b>	<b>576-01031</b>

\*Will NOT fit wheels with perimeter style mounted rotors  
 \*Designed to fit wheels with HUB mounted rotors

**BRAKE ROTORS**

- Polished stainless steel rotors
- '84-Up part numbers include reducer spacer for '84-99 applications
- Fit most OEM wheels and HardDrive wheels

Description	Application	Year	Front	Rear
<b>TOURING</b>				
11.5" Spoker Rotors	All models	'84-07	<b>576-01322</b>	<b>576-01323</b>
11.8" Spoker Rotors	All models (except Screaming Eagle)	'08-13	<b>576-01326</b>	<b>576-01327</b>
<b>SOFTAIL</b>				
11.5" Spoker Rotor	All models	'84-13	<b>576-01322</b>	<b>576-01323</b>
<b>DYNA</b>				
11.5" Spoker Rotors	All models	'84-07	<b>576-01322</b>	<b>576-01323</b>
11.8" Spoker Rotors		'08-13 & '06-07 Front	<b>576-01326</b>	<b>576-01327</b>
<b>SPORTSTER</b>				
11.5" Spoker Rotor	All models	'84-13	<b>576-01322</b>	<b>576-01323</b>
<b>DRILLED VENTED ROTOR</b>				
Vented	Replaces OEM 44136-84a		<b>820-51836</b>	
Vented Stainless Steel	Replaces OEM 44136-84a		<b>820-51837</b>	
Vented	Replaces OEM 41791-79a		<b>820-51838</b>	
Vented Stainless Steel	Replaces OEM 41791-79a		<b>820-51839</b>	

WINDSHIELDS / FAIRINGS  
 AUDIO / COMMUNICATION  
 SEATS / LUGGAGE  
 BARS / MIRRORS / CONTROLS  
 EXHAUST  
 AIR / FUEL SYSTEMS  
 ENGINE  
 TRANSMISSION / DRIVELINE  
 GASKETS / SEALS  
 ELECTRICAL  
 LIGHTING  
 CABLES  
**BRAKES**  
 OIL FILTERS  
 SUSPENSION  
 BODY  
 WHEELS  
 TIRES / TIRE ACC.  
 BIKE ACC.  
 VICTORY / INDIAN  
 COVERS / LOCKS / TIEDOWNS  
 CHEMICALS  
 TOOLS  
 HELMETS  
 HELMET ACC.  
 EYEWEAR  
 APPAREL / RIDER ACC.  
 PROMOTIONAL  
 REFERENCE  
 INDEX



**TOURING BRAKE ROTORS**

- Replacement floating rotors available in stainless steel and polished stainless steel versions
- Drilled for superior heat dissipation and better stopping power



Application	Rotor Dia.	Style/Finish	WPS#
<b>FRONT ROTORS</b>			
'14-Up Touring models*	11.8"	Drilled / Stainless	<b>820-51264</b>
	11.8"	Drilled / Polished	<b>820-51265</b>
A '08-13 Touring	11.8"	Drilled / Stainless	<b>820-51250</b>
B '08-13 Touring	11.8"	Drilled / Polished	<b>820-51251</b>
C '08-13 Touring Left	11.8"	OE / Stainless	<b>820-51254</b>
D '08-13 Touring Right	11.8"	OE / Polished	<b>820-51255</b>
	11.8"	OE / Stainless	<b>820-51256</b>
	11.8"	OE / Polished	<b>820-51257</b>

Application	Rotor Dia.	Style/Finish	WPS#
<b>REAR ROTORS</b>			
A '08-13 Touring	11.8"	Drilled / Stainless	<b>820-51252</b>
B '08-13 Touring	11.8"	Drilled / Polished	<b>820-51253</b>
C '08-13 Touring	11.8"	OE / Stainless	<b>820-51258</b>
D '08-13 Touring	11.8"	OE / Polished	<b>820-51259</b>
E '86-99 Touring	11.5"	Drilled / Steel	<b>820-51260</b>
F '86-99 Touring	11.5"	Drilled / Stainless	<b>820-51261</b>

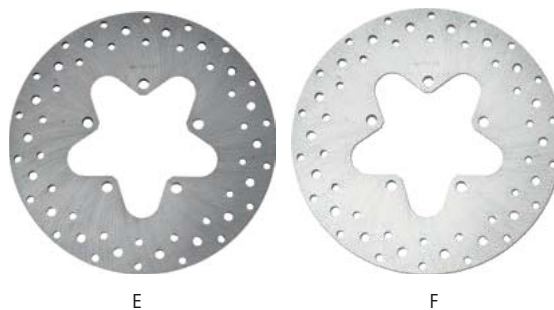

\*Will not fit CVO models

**DYNA BRAKE ROTORS**

- OEM Style replacement stainless steel brake rotors for Dyna models with spoke or cast wheels.

Application	WPS#
A Cast Wheel Models '06-Up	<b>820-51262</b>
B Spoke Wheel Models '00-Up	<b>820-51263</b>

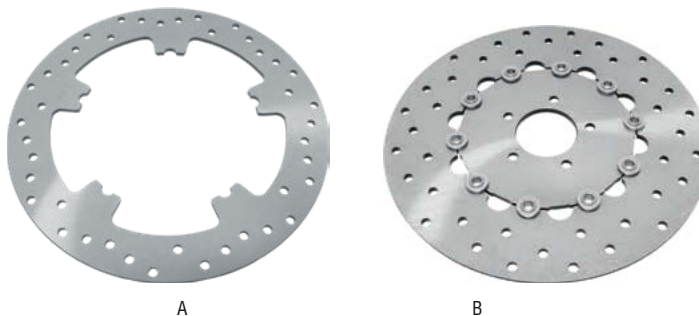

**SUPER FLOW BRAKE ROTORS**

- OEM style brake rotors
- Precision made from stainless steel
- Mirror Polished finish or Raw Machined finish

Application	Rotor Dia.	Finish	WPS#
<b>FRONT ROTORS</b>			
'14-16 XL Models	11.8"	Mirror Polished	<b>820-51268</b>
	11.8"	Machined	<b>820-51269</b>
'84-13 XL Models	11.5"	Mirror Polished	<b>820-51266</b>
	11.5"	Machined	<b>820-51267</b>
<b>REAR ROTORS</b>			
'14-UP XL Models	10.5"	Mirror Polished	<b>820-51272</b>
	10.5"	Machined	<b>820-51273</b>
'84-13 XL Models	11.5"	Mirror Polished	<b>820-51270</b>
	11.5"	Machined	<b>820-51271</b>



## HIGH CARBON STEEL PHOENIX ROTORS



- High carbon steel offers a high coefficient with low wear character
- Lug-drive: Full floating design for predictable, repeatable hard stopping performance
- Fly cut for improved out gassing

- Crown-cut design offers increased cooling capacity while lowering the mass, making it almost half as light as a solid
- Work best with Gold Plus or Extreme Performance pads
- Made in the USA



815-0204



815-0165



815-0162



815-0202

Application	Rotor Dia.	Front Rotor Black	Front Rotor Chrome
<b>TOURING</b>			
All models '00-07	11.5"	<b>815-0205</b>	<b>815-0204</b>
All models '08-13 (except Seaming Eagle models)	11.8"	<b>815-0207</b>	<b>815-0206</b>

Application	Rotor Dia.	Rear Rotor Black	Rear Rotor Chrome
<b>SOFTAIL, DYNA &amp; SPORTSTER</b>			
Sportster and Softail models '00-16	11.5"	<b>815-0205</b>	<b>815-0204</b>
FXDB '06-07 & '14-16, FXD/C '00 & '02-07, FXDL '00-07	11.5"	<b>815-0205</b>	<b>815-0204</b>
FXDB '08-13, FXD/C '08-16, FXDL '08-13, FXDF '08-16, FXDS '00, '02	11.8"	<b>815-0207</b>	<b>815-0206</b>

Application	Rotor Dia.	Front Rotor Black	Front Rotor Chrome
<b>TOURING</b>			
All models '00-07	11.5"	<b>815-0209</b>	<b>815-0208</b>
All models '08-16 (except Seaming Eagle models)	11.8"	<b>815-0211</b>	<b>815-0210</b>

Application	Rotor Dia.	Rear Rotor Black	Rear Rotor Chrome
<b>SOFTAIL, DYNA &amp; SPORTSTER</b>			
Sportster and Softail models '00-16	11.5"	<b>815-0209</b>	<b>815-0208</b>
Dyna models '00-16 (except '00-07 FXDWG)	11.5"	<b>815-0209</b>	<b>815-0208</b>
FXDWG '00-07	11.8"	<b>815-0211</b>	<b>815-0210</b>

Application	Rotor Dia.	Front Rotor Black	Front Rotor Chrome
<b>TOURING</b>			
All models '00-07	11.5"	<b>815-0165</b>	<b>815-0164</b>
All models '08-13 (except Seaming Eagle models)	11.8"	<b>815-0167</b>	<b>815-0166</b>

Application	Rotor Dia.	Rear Rotor Black	Rear Rotor Chrome
<b>SOFTAIL, DYNA &amp; SPORTSTER</b>			
Sportster and Softail models '00-16	11.5"	<b>815-0165</b>	<b>815-0164</b>
FXDB '06-07 & '14-16, FXD/C '00 & '02-07, FXDL '00-07	11.5"	<b>815-0165</b>	<b>815-0164</b>
FXDB '08-13, FXD/C '08-16, FXDL '08-13, FXDF '08-16, FXDS '00, '02	11.8"	<b>815-0167</b>	<b>815-0166</b>

Application	Rotor Dia.	Front Rotor Black	Front Rotor Chrome
<b>TOURING</b>			
All models '00-07	11.5"	<b>815-0169</b>	<b>815-0168</b>
All models '08-16 (except Seaming Eagle models)	11.8"	<b>815-0171</b>	<b>815-0170</b>

Application	Rotor Dia.	Rear Rotor Black	Rear Rotor Chrome
<b>SOFTAIL, DYNA &amp; SPORTSTER</b>			
Sportster and Softail models '00-16	11.5"	<b>815-0169</b>	<b>815-0168</b>
Dyna models '00-16 (except '00-07 FXDWG)	11.5"	<b>815-0169</b>	<b>815-0168</b>
FXDWG '00-07	11.8"	<b>815-0171</b>	<b>815-0170</b>

## HIGH CARBON STEEL PERIMETER ROTORS

- High carbon steel offers a high coefficient with low wear character
- Fly cut for improved out gassing
- Crown-cut design offers increased cooling capacity while lowering the mass, making it almost half as light as a solid
- Work best with Gold Plus or Extreme Performance pads
- Made in the USA

Description	Application	Year	Black	Silver
11.8" Perimeter mount	Touring models	14-Up	<b>815-0161</b>	<b>815-0160</b>
11.8" Perimeter mount	V-Rod models	06-Up	<b>815-0163</b>	<b>815-0162</b>

Description	Application	Year	Black	Silver
11.8" Perimeter Mount	Touring models	14-Up	<b>815-0201</b>	<b>815-0200</b>
11.8" Perimeter Mount	V-Rod models	06-Up	<b>815-0203</b>	<b>815-0202</b>

- WINDSHIELDS / FAIRINGS
- AUDIO / COMMUNICATION
- SEATS / LUGGAGE
- BAR / MIRRORS / CONTROLS
- EXHAUST
- AIR / FUEL SYSTEMS
- ENGINE
- TRANSMISSION / DRIVELINE
- GASKETS / SEALS
- ELECTRICAL
- LIGHTING
- CABLES
- BRAKES**
- OIL FILTERS
- SUSPENSION
- BODY
- WHEELS
- TIRES / TIRE ACC.
- BIKE ACC.
- VICTORY / INDIAN
- COVERS / LOCKS / TIEDOWNS
- CHEMICALS
- TOOLS
- HELMETS
- HELMET ACC.
- EYEWEAR
- APPAREL / RIDER ACC.
- PROMOTIONAL
- REFERENCE
- INDEX



- Ultra-light friction ring CNC machined from functionally gradient metal composite material
- 302 stainless spiral retaining clip in the back, gives a clean uninterrupted look of a solid rotor
- The entire rotor weighs 1.6 pounds
- Use with Gold Plus or Extreme Performance Brake Pads

**PHOENIX BRAKE ROTORS**

Application	Rotor Dia.	Rear Rotor Chrome
<b>TOURING</b>		
All models '00-07	11.5"	<b>815-0109</b>
All models '08-16 (except Seaming Eagle models)	11.8"	<b>815-0111</b>
<b>SOFTAIL</b>		
All models '00-16	11.5"	<b>815-0109</b>
<b>DYNA</b>		
All models '00-16 (except '00-07 FXDWG)	11.5"	<b>815-0109</b>
FXDWG '00-07	11.8"	<b>815-0111</b>
<b>SPORTSTER</b>		
All models '00-16	11.5"	<b>815-0109</b>



**OMEGA BRAKE ROTORS**

Application	Rotor Dia.	Front Rotor Black	Front Rotor Chrome
<b>TOURING</b>			
All models '00-07	11.5"	<b>815-0113</b>	<b>815-0112</b>
All models '08-13 (except Seaming Eagle models)	11.8"	<b>815-0117</b>	<b>815-0116</b>
<b>SOFTAIL</b>			
All models '00-16	11.5"	<b>815-0113</b>	<b>815-0112</b>
<b>DYNA</b>			
FXDB '06-07 & '14-16, FXD/C '00 & '02-07, FXDL '00-07	11.5"	<b>815-0113</b>	<b>815-0112</b>
FXDB '08-13, FXD/C '08-16, FXDL '08-13, FXDF '08-16, FXDS '00, '02	11.8"	<b>815-0117</b>	<b>815-0116</b>
<b>SPORTSTER</b>			
All models '00-16	11.5"	<b>815-0113</b>	<b>815-0112</b>

Application	Rotor Dia.	Rear Rotor Black	Rear Rotor Chrome
<b>TOURING</b>			
All models '00-07	11.5"	<b>815-0115</b>	<b>815-0114</b>
All models '08-16 (except Seaming Eagle models)	11.8"	<b>815-0118</b>	<b>815-0118</b>
<b>SOFTAIL</b>			
All models '00-16	11.5"	<b>815-0115</b>	<b>815-0114</b>
<b>DYNA</b>			
All models '00-16 (except '00-07 FXDWG)	11.5"	<b>815-0115</b>	<b>815-0114</b>
FXDWG '00-07	11.8"	<b>815-0118</b>	<b>815-0118</b>
<b>SPORTSTER</b>			
All models '00-16	11.5"	<b>815-0115</b>	<b>815-0114</b>



- WINDSHIELDS / FAIRINGS
- AUDIO / COMMUNICATION
- SEATS / LUGGAGE
- BARS / MIRRORS / CONTROLS
- EXHAUST
- AIR / FUEL SYSTEMS
- ENGINE
- TRANSMISSION / DRIVELINE
- GASKETS / SEALS
- ELECTRICAL
- LIGHTING
- CABLES
- BRAKES**
- OIL FILTERS
- SUSPENSION
- BODY
- WHEELS
- TIRES / TIRE ACC.
- BIKE ACC.
- VICTORY / INDIAN
- COVERS / LOCKS / TIEDOWNS
- CHEMICALS
- TOOLS
- HELMETS
- HELMET ACC.
- EYEWEAR
- APPAREL / RIDER ACC.
- PROMOTIONAL
- REFERENCE
- INDEX



- Ultra-light friction ring CNC machined from functionally gradient metal composite material
- 302 stainless spiral retaining clip in the back, gives a clean uninterrupted look of a solid rotor
- The entire rotor weighs 1.6 pounds
- Use with Gold Plus or Extreme Performance Brake Pads



**GEMINI BRAKE ROTORS**



Application	Rotor Dia.	Front Rotor Chrome
<b>TOURING</b>		
All models '00-07	11.5"	<b>815-0120</b>
All models '08-13 (except Seaming Eagle models)	11.8"	<b>815-0126</b>
<b>SOFTAIL</b>		
All models '00-16	11.5"	<b>815-0120</b>
<b>DYNA</b>		
FXDB '06-07 & '14-16, FXD/C '00 & '02-07, FXDL '00-07	11.5"	<b>815-0120</b>
FXDB '08-13, FXD/C '08-16, FXDL '08-13, FXDF '08-16, FXDS '00, '02	11.8"	<b>815-0126</b>
<b>SPORTSTER</b>		
All models '00-16	11.5"	<b>815-0120</b>

Application	Rotor Dia.	Rear Rotor Chrome
<b>TOURING</b>		
All models '00-07	11.5"	<b>815-0122</b>
All models '08-16 (except Seaming Eagle models)	11.8"	<b>815-0124</b>
<b>SOFTAIL</b>		
All models '00-16	11.5"	<b>815-0122</b>
<b>DYNA</b>		
All models '00-16 (except '00-07 FXDWG)	11.5"	<b>815-0122</b>
FXDWG '00-07	11.8"	<b>815-0124</b>
<b>SPORTSTER</b>		
All models '00-16	11.5"	<b>815-0122</b>

**INDY BRAKE ROTORS**



Application	Rotor Dia.	Front Rotor Black	Front Rotor Chrome
<b>TOURING</b>			
All models '00-07	11.5"	<b>815-0137</b>	
All models '08-13 (except Seaming Eagle models)	11.8"	<b>815-0141</b>	<b>815-0140</b>
<b>SOFTAIL</b>			
All models '00-16	11.5"	<b>815-0137</b>	
<b>DYNA</b>			
FXDB '06-07 & '14-16, FXD/C '00 & '02-07, FXDL '00-07	11.5"	<b>815-0137</b>	
FXDB '08-13, FXD/C '08-16, FXDL '08-13, FXDF '08-16, FXDS '00, '02	11.8"	<b>815-0141</b>	<b>815-0140</b>
<b>SPORTSTER</b>			
All models '00-16	11.5"	<b>815-0137</b>	

Application	Rotor Dia.	Rear Rotor Black	Rear Rotor Chrome
<b>TOURING</b>			
All models '00-07	11.5"		<b>815-0138</b>
All models '08-16 (except Seaming Eagle models)	11.8"	<b>815-0143</b>	<b>815-0142</b>
<b>SOFTAIL</b>			
All models '00-16	11.5"		<b>815-0138</b>
<b>DYNA</b>			
All models '00-16 (except '00-07 FXDWG)	11.5"		<b>815-0138</b>
FXDWG '00-07	11.8"	<b>815-0143</b>	<b>815-0142</b>
<b>SPORTSTER</b>			
All models '00-16	11.5"		<b>815-0138</b>

- WINDSHIELDS / FAIRINGS
- AUDIO / COMMUNICATION
- SEATS / LUGGAGE
- BARS / MIRRORS / CONTROLS
- EXHAUST
- AIR / FUEL SYSTEMS
- ENGINE
- TRANSMISSION / DRIVELINE
- GASKETS / SEALS
- ELECTRICAL
- LIGHTING
- CABLES
- BRAKES**
- OIL FILTERS
- SUSPENSION
- BODY
- WHEELS
- TIRES / TIRE ACC.
- BIKE ACC.
- VICTORY / INDIAN
- COVERS / LOCKS / TIEDOWNS
- CHEMICALS
- TOOLS
- HELMETS
- HELMET ACC.
- EYEWEAR
- APPAREL / RIDER ACC.
- PROMOTIONAL
- REFERENCE
- INDEX



- Ultra-light friction ring CNC machined from functionally gradient metal composite material
- 302 stainless spiral retaining clip in the back, gives a clean uninterrupted look of a solid rotor
- The entire rotor weighs 1.6 pounds
- Use with Gold Plus or Extreme Performance Brake Pads

**MILLENIUM BRAKE ROTORS**

Application	Rotor Dia.	Front Rotor Black	Front Rotor Chrome
<b>TOURING</b>			
All models '00-07	11.5"	<b>815-0145</b>	<b>815-0144</b>
All models '08-13 (except Seaming Eagle models)	11.8"		<b>815-0148</b>
<b>SOFTAIL</b>			
All models '00-16	11.5"	<b>815-0145</b>	<b>815-0144</b>
<b>DYNA</b>			
FXDB '06-07 & '14-16, FXD/C '00 & '02-07, FXDL '00-07	11.5"	<b>815-0145</b>	<b>815-0144</b>
FXDB '08-13, FXD/C '08-16, FXDL '08-13, FXDF '08-16, FXDS '00 & '02	11.8"		<b>815-0148</b>
<b>SPORTSTER</b>			
All models '00-16	11.5"	<b>815-0145</b>	<b>815-0144</b>
Application	Rotor Dia.	Rear Rotor Black	Rear Rotor Chrome
<b>TOURING</b>			
All models '08-16 (except Seaming Eagle models)	11.8"	<b>815-0151</b>	<b>815-0150</b>
<b>DYNA</b>			
FXDWG '00-07	11.8"	<b>815-0151</b>	<b>815-0150</b>



**TRIANGULUM BRAKE ROTORS**

Application	Rotor Dia.	Front Rotor Black	Front Rotor Chrome
<b>TOURING</b>			
All models '00-07	11.5"	<b>815-0129</b>	<b>815-0128</b>
All models '08-13 (except Seaming Eagle models)	11.5"		<b>815-0132</b>
<b>SOFTAIL</b>			
All models '00-16	11.5"	<b>815-0129</b>	<b>815-0128</b>
<b>DYNA</b>			
FXDB '06-07 & '14-16, FXD/C '00 & '02-07, FXDL '00-07	11.5"	<b>815-0129</b>	<b>815-0128</b>
FXDB '08-13, FXD/C '08-16, FXDL '08-13, FXDF '08-16, FXDS '00, '02	11.8"		<b>815-0132</b>
<b>SPORTSTER</b>			
All models '00-16	11.5"	<b>815-0129</b>	<b>815-0128</b>
Application	Rotor Dia.	Rear Rotor Black	Rear Rotor Chrome
<b>TOURING</b>			
All models '00-07	11.5"		<b>815-0130</b>
All models '08-16 (except Seaming Eagle models)	11.8"	<b>815-0135</b>	<b>815-0134</b>
<b>SOFTAIL</b>			
All models '00-16	11.5"		<b>815-0130</b>
<b>DYNA</b>			
All models '00-16 (except '00-07 FXDWG)	11.5"		<b>815-0130</b>
FXDWG '00-07	11.8"	<b>815-0135</b>	<b>815-0134</b>
<b>SPORTSTER</b>			
All models '00-16	11.5"		<b>815-0130</b>





**ONE PIECE ROTORS**



Description	Application	Year	Silver
11.8" front one-piece rotor	V-Rod and Dyna models	'06-16	<b>815-0105</b>

**WAVE ROTORS**



- Narrow Band Series full floating rotors
- Black stainless steel carrier with stainless steel rotor blade
- Available in 5 and 10 spoke design

Application	Year	Front 5 Spoke	Front 10 Spoke	Rear
<b>TOURING SERIES</b>				
All Models	'00-07	<b>15-FSD006</b>	<b>15-FSD025</b>	<b>15-RSD014</b>
	'86-99	<b>15-FSD005</b>	<b>15-FSD024</b>	<b>15-RSD013</b>
<b>SOFTAIL SERIES</b>				
All Models (except Springer)	'00-14	<b>15-FSD006</b>	<b>15-FSD025</b>	<b>15-RSD014</b>
All models (except Springer)	L'87-99	<b>15-FSD005</b>	<b>15-FSD024</b>	<b>15-RSD013</b>
<b>FXR AND DYNA SERIES</b>				
All Models	'00-05	<b>15-FSD006</b>	<b>15-FSD025</b>	<b>15-RSD014</b>
FXDWG	L'87-99	<b>15-FSD005</b>	<b>15-FSD024</b>	<b>15-RSD013</b>
FXDS-CON	'84-86	<b>15-FSD005</b>	<b>15-FSD024</b>	<b>15-RSD013</b>
All FXR Models	'84-99	<b>15-FSD005</b>	<b>15-FSD024</b>	<b>15-RSD013</b>
<b>SPORTSTER SERIES</b>				
All Models	'00-13	<b>15-FSD006</b>	<b>15-FSD025</b>	
	'00-10			<b>15-RSD014</b>



- WINDSHIELDS / FAIRINGS
- AUDIO / COMMUNICATION
- SEATS / LUGGAGE
- BARS / MIRRORS / CONTROLS
- EXHAUST
- AIR / FUEL SYSTEMS
- ENGINE
- TRANSMISSION / DRIVELINE
- GASKETS / SEALS
- ELECTRICAL
- LIGHTING
- CABLES
- BRAKES**
- OIL FILTERS
- SUSPENSION
- BODY
- WHEELS
- TIRES / TIRE ACC.
- BIKE ACC.
- VICTORY / INDIAN
- COVERS / LOCKS / TIEDOWNS
- CHEMICALS
- TOOLS
- HELMETS
- HELMET ACC.
- EYEWEAR
- APPAREL / RIDER ACC.
- PROMOTIONAL
- REFERENCE
- INDEX

# EBC BRAKE ROTORS

- Standard rotors are made from billet steel
- All front rotors feature a forged alloy center hub
- All rotors are sold each

Application	Year	Front	Rear
<b>TOURING SERIES</b>			
All models	'14-16	<b>15-0529</b>	<b>15-0521</b>
	'08-13	<b>15-0520</b>	<b>15-0521</b>
	'00-07	<b>15-FSD010 #</b>	<b>15-RSD020 #</b>
	'86-99	<b>15-FSD009 #</b>	<b>15-0509SR #</b>
<b>TRIKE SERIES</b>			
All models	'14-16	<b>15-0530</b>	
	'09-13	<b>15-0520</b>	
<b>SOFTAIL SERIES</b>			
FLSTC/FLSTN/FLS	'15-16	<b>15-0526</b>	<b>15-RSD020 #</b>
FLSTF/FLSTFB	'15-16	<b>15-0530</b>	<b>15-RSD020 #</b>
FXSB	'15-16		<b>15-RSD020 #</b>
All models (except listed below)	'00-14	<b>15-FSD010 #</b>	<b>15-RSD020 #</b>
FXSTS	00-05	<b>15-FSD009 #</b>	<b>15-RSD020 #</b>
	L'87-99	<b>15-FSD009 #</b>	<b>15-RSD019 #</b>
	'84-E87	<b>15-FSD009 #</b>	
<b>FX SUPERGLIDE, FXR AND DYNA SERIES</b>			
All models (except listed below)	'06-16	<b>15-0518</b>	<b>15-RSD020 #</b>
FXDL (Cast wheel)	'14-16	<b>15-0516</b>	<b>15-RSD020 #</b>
Floating rotor conversion		<b>15-0516X</b>	
FLD Switchback	'12-16	<b>15-0516</b>	<b>15-RSD020 #</b>
Floating rotor conversion		<b>15-0516X</b>	
FXDF Fat Bob (Cast wheel)	'08-16	<b>15-0518</b>	<b>15-RSD020 #</b>
FXD (Cast wheel)	'06-10	<b>15-0516</b>	<b>15-RSD020 #</b>
Floating rotor conversion		<b>15-0516X</b>	
FXDL (Cast wheel)	'06-09	<b>15-0516</b>	<b>15-RSD020 #</b>
Floating rotor conversion		<b>15-0516X</b>	
FXDC (Cast wheel)	'06	<b>15-0516</b>	<b>15-RSD020 #</b>
Floating rotor conversion		<b>15-0516X</b>	
FXDC	'05	<b>15-FSD010 #</b>	<b>15-RSD020 #</b>
FXD/FXDL/FXDWG	'04-05	<b>15-FSD010 #</b>	<b>15-RSD020 #</b>
FXDXT	'01-03	<b>15-FSD010 #</b>	<b>15-RSD020 #</b>
FXDX	'00-05	<b>15-FSD010 #</b>	<b>15-RSD020 #</b>
FXD	'00-03	<b>15-FSD010 #</b>	<b>15-RSD020 #</b>
FXDL	'00-03	<b>15-FSD010 #</b>	<b>15-RSD020 #</b>
FXDWG	'00-03	<b>15-FSD010 #</b>	<b>15-RSD020 #</b>
FXDS-CON	'00-02	<b>15-FSD010 #</b>	<b>15-RSD020 #</b>
All models	L'87-99		<b>15-RSD020 #</b>
	'84-86	<b>15-FSD009 #</b>	
<b>SPORTSTER SERIES</b>			
All models (except listed below)	'14-16	<b>15-0526</b>	<b>15-0524</b>
XL883N	'16		<b>15-0524</b>
All models (except listed below)	'00-13	<b>15-FSD010 #</b>	<b>15-RSD020 #</b>
XL883N	'11-13	<b>15-FSD010 #</b>	<b>15-0524</b>
XL883L Superlow	'11-13	<b>15-FSD010 #</b>	<b>15-0524</b>
XL1200L	'07-11	<b>15-FSD010 #</b>	<b>15-0524</b>
XL1200X Forty Eight	'10-13	<b>15-FSD010 #</b>	<b>15-0524</b>
XL1200C	'04-13	<b>15-FSD004 #</b>	<b>15-RSD020 #</b>
XR1200/X	'08-12	<b>15-0523X #</b>	<b>15-0524</b>
XL883R and 1200R	'03,'04-08	<b>15-FSD004 #</b>	<b>15-RSD020 #</b>
XL1200s Sport	'00-03	<b>15-FSD010 #</b>	<b>15-RSD020 #</b>
All models	L'87-99	<b>15-FSD009 #</b>	<b>15-RSD019 #</b>
	84-E87	<b>15-FSD009 #</b>	
<b>STREET SERIES</b>			
All models	'14-15	<b>15-0531</b>	<b>15-0532</b>
<b>V-ROD SERIES</b>			
All models (except listed below)	'06-16	<b>15-0516</b>	<b>15-0517</b>
Floating rotor conversion		<b>15-0516X</b>	
VRSCF	'09-16	<b>15-0516</b>	<b>15-0525</b>
Floating rotor conversion		<b>15-0516X</b>	
VRSCAW V-Rod (Spoke wheel)	'08-09	<b>15-0519</b>	<b>15-0517</b>
VRSCX V-Rod	'07	<b>15-0519</b>	<b>15-0517</b>
All models (left front L & right front R)	'02-05	<b>15-0514L</b>	<b>15-0515</b>
	'02-05	<b>15-0514R</b>	<b>15-0515</b>



15-FSD010



15-FSD010B



15-FSD009B



15-RSD020B



15-0516X

**BRAKE ROTOR HARDWARE**



- Chrome plated hardware
- Made in the USA!



A	Description	Application	WPS#
A	Front rotor screw kit chrome plated 8mm x 1.25 x 30mm torx	'14-Up Touring models (OEM# 41500020)	<b>830-1107</b>
B	Front rotor screw kit chrome plated button head torx	'06-Up Dyna w/ cast wheels (OEM# 3762M)	<b>830-1105</b>
C	Front rotor screw and nut kit chrome plated 5/16-7 x 7/8 torx bolts and lock nuts	'84-Up FXST and FXDWG	<b>830-1115</b>
D	Front rotor screw kit chrome plated 5/16-7 x 7/8 torx	'84-Up FX, FXR, XL, FLT/FLH w/ single disc (dual disc require 2 sets)	<b>830-1114</b>
E	Rear rotor screw kit chrome plated 3/8-16 x 1 button head torx bolts	'97-Up all models w/ rear spoke wheel (OEM# 43567-92)	<b>830-1117</b>
F	Rear rotor screw and nut kit chrome plated 3/8-16 x 1 torx bolts and lock nuts	'92-Up XL, FLT/FLH, FLST, FXD models (OEM# 43567-92)	<b>830-1116</b>

**ROTOR BOLTS**



- Made in the USA!

- Put the finishing touches on your custom rotor
- Choose from chrome plated Torx or Allen head bolts
- Will not fit models with perimeter mounted rotors such as '14-up Touring and '06-up Dyna with cast wheels



Description	Application	WPS#
Front brake rotor chrome allen bolts	'84-Up Big Twin modes with laced wheels	<b>830-1057</b>
Front brake rotor chrome allen bolts	'84-Up Big Twin modes with cast wheels	<b>830-1058</b>
Front brake rotor chrome torx buttonhead bolts	'84-Up Big Twin modes with laced wheels	<b>830-1060</b>
Front brake rotor chrome torx buttonhead bolts	'84-Up Big Twin modes with cast wheels	<b>830-1061</b>
Rear brake rotor chrome allen bolts	'92-Up Big Twin models with laced wheels	<b>830-1062</b>
Rear brake rotor chrome allen bolts	'92-Up Big Twin modes with cast wheels	<b>830-1063</b>
Rear brake rotor chrome torx buttonhead bolts	'92-Up Big Twin models with laced wheels	<b>830-1064</b>
Rear brake rotor chrome torx buttonhead bolts	'92-Up Big Twin modes with cast wheels	<b>830-1065</b>

**CALIPER MOUNTING KITS**



- Caliper mounting allen bolts and washers
- Chrome plated and polished



Application	WPS#
<b>CALIPER MOUNTING KITS</b>	
A Front Caliper Mount Kit '08-UP Softail Dyna	<b>830-1166</b>
B Rear Caliper Mount Kit '08-UP Softail Dyna	<b>830-1167</b>
C Front Caliper Mount Kit '00-07 XL,FXD,FLST, FXST	<b>830-1132</b>
D Rear Caliper Mount Kit '00-07 XL,FXD,FLST, FXST	<b>830-1133</b>

WINDSHIELDS / FAIRINGS  
 AUDIO / COMMUNICATION  
 SEATS / LUGGAGE  
 BARS / MIRRORS / CONTROLS  
 EXHAUST  
 AIR / FUEL SYSTEMS  
 ENGINE  
 TRANSMISSION / DRIVELINE  
 GASKETS / SEALS  
 ELECTRICAL  
 LIGHTING  
 CABLES  
**BRAKES**  
 OIL FILTERS  
 SUSPENSION  
 BODY  
 WHEELS  
 TIRES / TIRE ACC.  
 BIKE ACC.  
 VICTORY / INDIAN  
 COVERS / LOCKS / TIEDOWNS  
 CHEMICALS  
 TOOLS  
 HELMETS  
 HELMET ACC.  
 EYEWEAR  
 APPAREL / RIDER ACC.  
 PROMOTIONAL  
 REFERENCE  
 INDEX



**CHROME CALIPERS**



- Show quality chrome
- Direct OEM replacement
- Calipers come ready to go with bleeders and brake pads installed
- Not for Springer models unless noted

Application	Chrome
<b>BRAKE CALIPERS</b>	
08-Up Softail/Dyna Left Front	<b>820-32000</b>
08-Up Softail/Dyna Rear	<b>820-32001</b>
06-07 Softail Rear	<b>820-32002</b>
06-07 Dyna Rear	<b>820-32003</b>
00-07 Left Front	<b>820-32004</b>
00-07 Softail/Dyna/FLT Right Frnt	<b>820-32005</b>
00-05 Softail Rear	<b>820-32006</b>
00-03 Sportster Rear	<b>820-32007</b>
00-05 Dyna Rear	<b>820-32008</b>
02-07 FLH models Rear	<b>820-32009</b>



820-32000



820-32002



820-32003



820-32004



820-32005



820-32006



820-32007



820-32008



Application	Chrome
<b>CALIPER REBUILD KITS</b>	
07-Up XL w/2 pistons	<b>820-32012</b>
08-Up FLT seal kit	<b>820-50600</b>

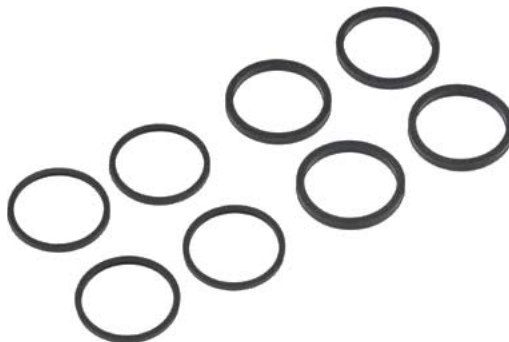

- WINDSHIELDS / FAIRINGS
- AUDIO / COMMUNICATION
- SEATS / LUGGAGE
- BARS / MIRRORS / CONTROLS
- EXHAUST
- AIR / FUEL SYSTEMS
- ENGINE
- TRANSMISSION / DRIVELINE
- GASKETS / SEALS
- ELECTRICAL
- LIGHTING
- CABLES
- BRAKES**
- OIL FILTERS
- SUSPENSION
- BODY
- WHEELS
- TIRES / TIRE ACC.
- BIKE ACC.
- VICTORY / INDIAN
- COVERS / LOCKS / TIEDOWNS
- CHEMICALS
- TOOLS
- HELMETS
- HELMET ACC.
- EYEWEAR
- APPAREL / RIDER ACC.
- PROMOTIONAL
- REFERENCE
- INDEX



**Z PLUS  
BRAKE PADS**



- Z+ compound is racing pad material
- Optimum stopping power
- DuPont Carbon-Kevlar (organic)
- The most rotor friendly pad in the industry
- Produces no dust, no noise, while providing 20% more stopping torque than stock pads
- The service life generally averages about 18,000 miles
- Made in the USA

**GOLD PLUS  
BRAKE PADS**

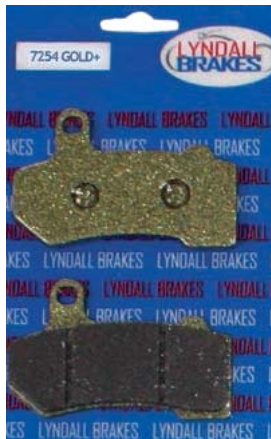

- Gold Plus pads are a DuPont Carbon-Kevlar (Organic) compound
- High performance friction materials
- Extreme stopping power in both wet and dry conditions
- As close to a full race pad as you can get without it actually being a race pad
- We softened the compound to make it better for street riding while still providing premium stopping power
- The Gold Plus pads are ideal for heavy touring and hard stopping
- Produces no dust, no noise, and no rotor wear while providing 30% more stopping torque than stock pads
- The service life generally averages about 18,000 miles

**EXTREME PERFORMANCE BRAKE PADS**

- For use with Lyndall composite or steel rotors
- 40% more stopping power than stock brakes!
- No noise, no dust
- 15,000 service miles

Application	Year	Front Z+	Front Gold+	Front Extreme
<b>TOURING SERIES</b>				
All models	'08-17	<b>815-0006</b>	<b>815-0011</b>	<b>815-0020</b>
	'00-07	<b>815-0004</b>	<b>815-0010</b>	<b>815-0018</b>
	'84-99	<b>815-0002</b>	<b>815-0026</b>	<b>815-0016</b>
<b>TRIKE SERIES</b>				
All models	08-17	<b>815-0006</b>	<b>815-0011</b>	<b>815-0020</b>
<b>SOFTAIL SERIES</b>				
All models (except Springer models)	'08-17	<b>815-0007</b>	<b>815-0013</b>	<b>815-0021</b>
All models w/ Springer front end (except FLSTSB, FXSTSSE2)	'08-17		<b>815-0013</b>	
All models w/ Springer front end	'00-12	<b>815-0002</b>	<b>815-0026</b>	<b>815-0016</b>
	'84-99	<b>815-0002</b>	<b>815-0026</b>	<b>815-0016</b>
	'00-05	<b>815-0004</b>	<b>815-0010</b>	<b>815-0018</b>
All models	'06-07	<b>815-0004</b>	<b>815-0010</b>	<b>815-0018</b>
<b>DYNA SERIES</b>				
All models	'08-17	<b>815-0007</b>	<b>815-0013</b>	<b>815-0021</b>
	'00-07	<b>815-0004</b>	<b>815-0010</b>	<b>815-0018</b>
FXD, FXDL, FXDWG	'84-99	<b>815-0002</b>	<b>815-0026</b>	<b>815-0016</b>
<b>FX SUPERGLIDE AND FXR SERIES</b>				
FXR, FXRS, FXRT, FXRD, FXLR	'84-99	<b>815-0002</b>	<b>815-0026</b>	<b>815-0016</b>
FX, FXE, FXEF, FXWG, FXS	'84-86	<b>815-0002</b>	<b>815-0026</b>	<b>815-0016</b>
<b>SPORTSTER SERIES</b>				
All models	'04-13	<b>815-0024</b>	<b>815-0029</b>	<b>815-0033</b>
	'00-03	<b>815-0004</b>	<b>815-0010</b>	<b>815-0018</b>
	'84-99	<b>815-0002</b>	<b>815-0026</b>	<b>815-0016</b>
<b>V-ROD SERIES</b>				
All models	'06-16	<b>815-0006</b>	<b>815-0011</b>	<b>815-0020</b>
	'02-05	<b>815-0004</b>	<b>815-0010</b>	<b>815-0018</b>
<b>BUELL</b>				
M2 Cyclone, X1 Lightning	'98-05	<b>815-0005</b>		<b>815-0019</b>
S1 Lightning, S1 White Lightning, S3/S3T Thunderbolt	'98-01	<b>815-0005</b>		<b>815-0019</b>

- WINDSHIELDS / FAIRINGS
- AUDIO / COMMUNICATION
- SEATS / LUGGAGE
- BAR / MIRRORS / CONTROLS
- EXHAUST
- AIR / FUEL SYSTEMS
- ENGINE
- TRANSMISSION / DRIVELINE
- GASKETS / SEALS
- ELECTRICAL
- LIGHTING
- CABLES
- BRAKES**
- OIL FILTERS
- SUSPENSION
- BODY
- WHEELS
- TIRES / TIRE ACC.
- BIKE ACC.
- VICTORY / INDIAN
- COVERS / LOCKS / TIEDOWNS
- CHEMICALS
- TOOLS
- HELMETS
- HELMET ACC.
- EYEWEAR
- APPAREL / RIDER ACC.
- PROMOTIONAL
- REFERENCE
- INDEX



**REAR BRAKE PADS**

Application	Year	Rear Z+	Rear Gold+	Rear Extreme
<b>TOURING SERIES</b>				
All models	'08-16	<b>815-0006</b>	<b>815-0011</b>	<b>815-0020</b>
	'00-07	<b>815-0004</b>	<b>815-0010</b>	<b>815-0018</b>
	'86-99	<b>815-0023</b>	<b>815-0027</b>	
<b>SOFTAIL SERIES</b>				
All models	'08-16	<b>815-0008</b>	<b>815-0014</b>	<b>815-0022</b>
All models (except listed below)	'00-07	<b>815-0004</b>	<b>815-0010</b>	<b>815-0018</b>
All models w/ 200mm rear tire	'06-07	<b>815-0035</b>	<b>815-0036</b>	
	'87-99	<b>815-0001</b>	<b>815-0028</b>	<b>815-0015</b>
<b>DYNA SERIES</b>				
All models	'08-16	<b>815-0008</b>	<b>815-0014</b>	<b>815-0022</b>
	'00-07	<b>815-0004</b>	<b>815-0010</b>	<b>815-0018</b>
FXD, FXDL, FXDWG	'91-99	<b>815-0001</b>	<b>815-0028</b>	<b>815-0015</b>
<b>FXR SERIES</b>				
FXR, FXRS, FXRT, FXRD, FXLR	'87-94	<b>815-0001</b>	<b>815-0028</b>	<b>815-0015</b>
<b>SPORTSTER SERIES</b>				
All models	'04-13	<b>815-0025</b>	<b>815-0030</b>	<b>815-0034</b>
	'00-03	<b>815-0004</b>	<b>815-0010</b>	<b>815-0018</b>
	'87-99	<b>815-0001</b>	<b>815-0028</b>	<b>815-0015</b>
<b>V-ROD SERIES</b>				
All models	'06-16	<b>815-0006</b>	<b>815-0011</b>	<b>815-0020</b>
	'02-05	<b>815-0004</b>	<b>815-0010</b>	<b>815-0018</b>

**PADS FOR PERFORMANCE MACHINE CALIPERS**

Performance Machine Calipers	Z +	Gold +	Extreme
125 X 4R	<b>815-0003</b>	<b>815-0009</b>	<b>815-0017</b>
125 X 4RSPH	<b>815-0003</b>	<b>815-0009</b>	<b>815-0017</b>
137 X 4B	<b>815-0003</b>	<b>815-0009</b>	<b>815-0017</b>
124 X 4HR	<b>815-0003</b>	<b>815-0009</b>	<b>815-0017</b>
125 x 2		<b>815-0031</b>	<b>815-0032</b>







**FRONT STREET APPLICATIONS**

EBC Brakes offer a full line of brake pads and brake shoes for most street bikes, dirt bikes and ATVs.

**BRAKE SHOES**

- Standard Shoes:** FS rated, higher rating than O.E.M. shoes for better stopping power.
- Grooved Shoes:** FG rated, high friction grooved linings, efficiency improves with heat, for wet and muddy conditions. Listed with suffix G

**BRAKE PADS - STREET**

**Black Coded:** Street Sport/Touring with Aramid fibre composite, the most popular pad for street use.

**V series:** Heavy duty organic/copper sintered material gives the feel of an organic pad with the wear characteristics of a sintered pad. Great for larger touring bikes, offers stable braking with minimal pad/rotor wear and lower brake dusting of wheels.

**Double-H:** New high friction superbike/race sintered formula. Double-H sintered pads offer the maximum brake effect and a lifetime approximately double that of any organic pad.



Race inspired pads with a very exotic blend of sintered bronze including Tungsten and Moly metal to bring you the grippiest, most fade resistant pad we have ever tested.

Application	Year	Front Standard	Front V-Series	Front Hi-Perf.	Front Extreme Pro
<b>TOURING SERIES</b>					
All Models	'08-17 *	<b>15-409</b>	<b>15-409V</b> #	<b>15-409H</b>	<b>15-409EP</b>
	'00-07 *	<b>15-400</b>	<b>15-400V</b> #	<b>15-400H</b>	<b>15-400EP</b>
	'84-99 *	<b>15-94</b>	<b>15-94V</b>	<b>15-94H</b>	<b>15-94EP</b>
	'80-83 *	<b>15-72</b>	<b>15-72V</b>		
FL, FLH (Banana Caliper)	'72-84	<b>15-24/2</b>	<b>15-24/2V</b>		
<b>TRIKE SERIES</b>					
All models	'14-17 *	<b>15-638</b>	<b>15-638V</b>	<b>15-638H</b>	
	'09-13 *	<b>15-409</b>	<b>15-409V</b> #	<b>15-409H</b>	
<b>SOFTAIL SERIES</b>					
All models (except models listed below)	'15-17			<b>15-296H</b>	
FLSTF/B	'15-17		<b>15-458V</b> #	<b>15-458H</b>	
All Models	'08-14		<b>15-457V</b> #	<b>15-457H</b>	<b>15-457EP</b>
	'00-07	<b>15-400</b>	<b>15-400V</b> #	<b>15-400H</b>	<b>15-400EP</b>
	'84-99	<b>15-94</b>	<b>15-94V</b>	<b>15-94H</b>	<b>15-94EP</b>
All models w/ Spinger front end	'00-10	<b>15-94</b>	<b>15-94V</b>	<b>15-94H</b>	<b>15-94EP</b>
<b>DYNA SERIES</b>					
All models (except models listed below)	'08-17		<b>15-457V</b> #	<b>15-457H</b>	<b>15-457EP</b>
FXDF	'08-17 *		<b>15-457V</b> #	<b>15-457H</b>	<b>15-457EP</b>
FXDBC Street Bob LTD	'16 *		<b>15-457V</b> #	<b>15-457H</b>	<b>15-457EP</b>
FXDL	'14-17 *		<b>15-457V</b> #	<b>15-457H</b>	<b>15-457EP</b>
All models (models listed below require 2 sets)	'00-07	<b>15-400</b>	<b>15-400V</b> #	<b>15-400H</b>	<b>15-400EP</b>
FXDX Super Glide Sport	'00-05 *	<b>15-400</b>	<b>15-400V</b> #	<b>15-400H</b>	<b>15-400EP</b>
FXDL, FXDWG, and FXDS	'00-03 *	<b>15-400</b>	<b>15-400V</b> #	<b>15-400H</b>	<b>15-400EP</b>
FXDXT Superglide T-Sport	'01-03 *	<b>15-400</b>	<b>15-400V</b> #	<b>15-400H</b>	<b>15-400EP</b>
All models	'91-99 *	<b>15-94</b>	<b>15-94V</b>	<b>15-94H</b>	<b>15-94EP</b>
<b>FX SUPERGLIDE AND FXR SERIES</b>					
All models	'84-99 *	<b>15-94</b>	<b>15-94V</b>	<b>15-94H</b>	<b>15-94EP</b>
FXWG, FXSB	'83	<b>15-71</b>	<b>15-71V</b>		
(Twin Fronts)	'82-83	<b>15-71</b>	<b>15-71V</b>		
(Twin Fronts)	'78-83	<b>15-71</b>	<b>15-71V</b>		
FX, FXE (Rivet Type)	'73-77	<b>15-26</b>			
<b>SPORTSTER SERIES</b>					
All models	'14-17	<b>15-640</b>	<b>15-640V</b>	<b>15-640H</b>	
All models (except models listed below)	'04-13	<b>15-381</b>	<b>15-381V</b>	<b>15-381H</b>	<b>15-381EP</b>
XR 1200/X	'08-12 *			<b>15-296H</b>	<b>15-296EP</b>
XL 883R and 1200R	'04-08 *	<b>15-381</b>	<b>15-381V</b>	<b>15-381H</b>	<b>15-381EP</b>
XL 883R and 1200R	'03 *	<b>15-400</b>	<b>15-400V</b> #	<b>15-400H</b>	<b>15-400EP</b>
XL 1200S Sport	'00-03 *	<b>15-400</b>	<b>15-400V</b> #	<b>15-400H</b>	<b>15-400EP</b>
All models	'00-03	<b>15-400</b>	<b>15-400V</b> #	<b>15-400H</b>	<b>15-400EP</b>
(Girling Caliper)	'84-99	<b>15-94</b>	<b>15-94V</b>	<b>15-94H</b>	<b>15-94EP</b>
(Twin fronts)	'79-83 *	<b>15-71</b>	<b>15-71V</b>		
(XLH, XLCH) (Rivet Type)	'73-77	<b>15-26</b>			
<b>STREET SERIES</b>					
All models	'16	<b>15-209/2</b>	<b>15-209/2V</b>	<b>15-209/2H</b>	
	'14-15	<b>15-643</b>	<b>15-643V</b>	<b>15-643HH</b>	
<b>V-ROD SERIES</b>					
All models	'06-16 *	<b>15-409</b>	<b>15-409V</b> #	<b>15-409H</b>	
	'02-05 *	<b>15-400</b>	<b>15-400V</b> #	<b>15-400H</b>	<b>15-400EP</b>

\* 2 Sets Required # Limited Edition Chrome backing plate. Add "C" to end of part number.

- WINDSHIELDS / FAIRINGS
- AUDIO / COMMUNICATION
- SEATS / LUGGAGE
- BARS / MIRRORS / CONTROLS
- EXHAUST
- AIR / FUEL SYSTEMS
- ENGINE
- TRANSMISSION / DRIVELINE
- GASKETS / SEALS
- ELECTRICAL
- LIGHTING
- CABLES
- BRAKES**
- OIL FILTERS
- SUSPENSION
- BODY
- WHEELS
- TIRES / TIRE ACC.
- BIKE ACC.
- VICTORY / INDIAN
- COVERS / LOCKS / TIEDOWNS
- CHEMICALS
- TOOLS
- HELMETS
- HELMET ACC.
- EYEWEAR
- APPAREL / RIDER ACC.
- PROMOTIONAL
- REFERENCE
- INDEX

# EBC

## REAR STREET APPLICATIONS

EBC Brakes offer a full line of brake pads and brake shoes for most street bikes, dirt bikes and ATVs.

### BRAKE SHOES

**Standard Shoes:** FS rated, higher rating than O.E.M. shoes for better stopping power.

**Grooved Shoes:** FG rated, high friction grooved linings, efficiency improves with heat, for wet and muddy conditions. Listed with suffix G



### BRAKE PADS - STREET

**Black Coded:** Street Sport/Touring with Aramid fibre composite, the most popular pad for street use.

**V series:** Heavy duty organic/copper sintered material gives the feel of an organic pad with the wear characteristics of a sintered pad. Great for larger touring bikes, offers stable braking with minimal pad/rotor wear and lower brake dusting of wheels.

**Double-H:** New high friction superbike/race sintered formula. Double-H sintered pads offer the maximum brake effect and a lifetime approximately double that of any organic pad.



Race inspired pads with a very exotic blend of sintered bronze including Tungsten and Moly metal to bring you the grippiest, most fade resistant pad we have ever tested.

Application	Year	Rear Standard	Rear V-Series	Rear Hi-Perf.
<b>TOURING SERIES</b>				
All models	'08-16	<b>15-409</b>	<b>15-409V #</b>	<b>15-409H</b>
	'00-07	<b>15-400</b>	<b>15-400V #</b>	<b>15-400H</b>
	'86-99	<b>15-201</b>	<b>15-201V</b>	<b>15-201H</b>
FLT, FLHT, FLHTCI	'80-85	<b>15-79</b>		
FL, FLH (Banana Caliper)	'72-84	<b>15-24/2</b>	<b>15-24/2V</b>	
<b>TRIKE SERIES</b>				
All models	'14-16		<b>15-641/4V *</b>	<b>15-641/4H *</b>
	'09-13		<b>15-605/4V</b>	<b>15-605/4H</b>
<b>SOFTAIL SERIES</b>				
All models	'08-16		<b>15-458V #</b>	<b>15-458H</b>
(except listed below)	'00-07	<b>15-400</b>	<b>15-400V #</b>	<b>15-400H</b>
All models w/ 200mm rear tire	'06-07	<b>15-434</b>	<b>15-434V #</b>	<b>15-434H</b>
All models	'84-E87	<b>15-78</b>	<b>15-78V</b>	
	L'87-99	<b>15-200</b>	<b>15-200V</b>	<b>15-200H</b>
<b>DYNA SERIES</b>				
All models	'08-16		<b>15-458V #</b>	<b>15-458H</b>
	'00-07	<b>15-400</b>	<b>15-400V #</b>	<b>15-400H</b>
	'91-99	<b>15-200</b>	<b>15-200V</b>	<b>15-200H</b>
<b>FX SUPERGLIDE AND FXR SERIES</b>				
All models	L'87-99	<b>15-200</b>	<b>15-200V</b>	<b>15-200H</b>
	'82-E87	<b>15-78</b>	<b>15-78V</b>	
All models (except listed below)	'73-83	<b>15-24/2</b>	<b>15-24/2V</b>	
FXWG, FXSB	'83	<b>15-78</b>	<b>15-78V</b>	
<b>SPORTSTER SERIES</b>				
All models	'14-16	<b>15-254</b>	<b>15-254V</b>	<b>15-254H</b>
	'04-13	<b>15-387</b>	<b>15-387V</b>	<b>15-387H</b>
	'00-03	<b>15-400</b>	<b>15-400V #</b>	<b>15-400H</b>
	L'87-99	<b>15-200</b>	<b>15-200V</b>	<b>15-200H</b>
(will not fit models equipped w/ drum brakes)	'82-87	<b>15-78</b>	<b>15-78V</b>	
	'73-81	<b>15-72</b>	<b>15-72V</b>	
<b>STREET SERIES</b>				
All models	'16	<b>15-181X</b>		<b>15-181H</b>
	'14-15	<b>15-643</b>	<b>15-643V</b>	<b>15-643HH</b>
<b>V-ROD SERIES</b>				
All models	'02-05	<b>15-400</b>	<b>15-400V #</b>	<b>15-400H</b>
	'06-16	<b>15-409</b>	<b>15-409V #</b>	<b>15-409H</b>

\* 2 Sets Required # Limited Edition Chrome backing plate. Add "C" to end of part number.

**AFTERMARKET CALIPER BRAKE PADS**



**BRAKE PADS - STREET**

**Black Coded:** Street Sport/Touring with Aramid fibre composite, the most popular pad for street use.

**V series:** Heavy duty organic/copper sintered material gives the feel of an organic pad with the wear characteristics of a sintered pad. Great for larger touring bikes, offers stable braking with minimal pad/rotor wear and lower brake dusting of wheels.

**Double-H:** High friction superbike/race sintered formula. Double-H sintered pads offer the maximum brake effect and a lifetime approximately double that of any organic pad.

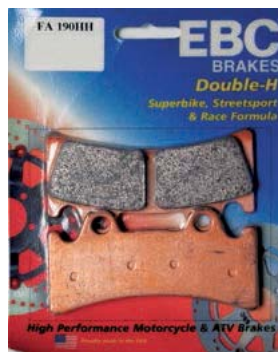
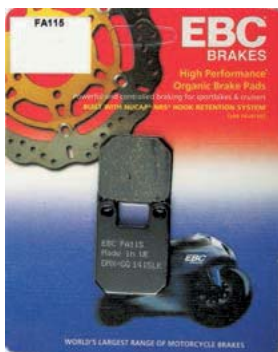

AFTER MARKET CALIPERS	Style	Front Standard	Front V-Series	Front Hi-Perf.
<b>JAYBRAKE</b>				
Early design	2 piston	<b>15-76</b>	<b>15-76V</b>	
Dual/Quad 300-04	2 & 4 piston	<b>15-115</b>		
J-Four 300-44	4 piston	<b>15-424</b>		<b>15-424H</b>
J-Six 300-64	6 piston	<b>15-243</b>		<b>15-243H</b>
6PF-L	6 piston			<b>15-455H</b>
<b>HHI</b>				
Sprocket brake	4 piston	<b>15-623</b>		
All	4 piston	<b>15-216/3</b>	<b>15-216/3V</b>	<b>15-216/3H</b>
All	6 piston	<b>15-424</b>		<b>15-424H</b>
<b>PERFORMANCE MACHINE</b>				
125x2	2 piston	<b>15-115</b>		<b>15-115HH</b>
162x2	2 piston	<b>15-32</b>		
124x4HR	4 piston	<b>15-216/2</b>		<b>15-216/2HH</b>
125x4R	4 piston	<b>15-216/3</b>	<b>15-216/3V</b>	<b>15-216/3H</b>
125x4RSPH	4 piston	<b>15-216/3</b>	<b>15-216/3V</b>	<b>15-216/3H</b>
125x4S	4 piston	<b>15-115</b>		<b>15-115HH</b>
125x4SL	4 piston	<b>15-115</b>		<b>15-115HH</b>
137x4	4 piston	<b>15-216/2</b>		<b>15-216/2HH</b>
137x4B	4 piston	<b>15-216/3</b>	<b>15-216/3V</b>	<b>15-216/3H</b>
112x6RSB	6 piston	<b>15-190</b>		<b>15-190H</b>
112x6SSB	6 piston	<b>15-190</b>		<b>15-190H</b>
125x6	6 piston	<b>15-210</b>		
125x6QC	6 piston	<b>15-190</b>		<b>15-190H</b>
137x6	6 piston	<b>15-210</b>		
<b>GMA</b>				
"A" Caliper	2 piston	<b>15-36</b>	<b>15-36v</b>	

- WINDSHIELDS / FAIRINGS
- AUDIO / COMMUNICATION
- SEATS / LUGGAGE
- BAR / MIRRORS / CONTROLS
- EXHAUST
- AIR / FUEL SYSTEMS
- ENGINE
- TRANSMISSION / DRIVELINE
- GASKETS / SEALS
- ELECTRICAL
- LIGHTING
- CABLES
- BRAKES**
- OIL FILTERS
- SUSPENSION
- BODY
- WHEELS
- TIRES / TIRE ACC.
- BIKE ACC.
- VICTORY / INDIAN
- COVERS / LOCKS / TIEDOWNS
- CHEMICALS
- TOOLS
- HELMETS
- HELMET ACC.
- EYEWEAR
- APPAREL / RIDER ACC.
- PROMOTIONAL
- REFERENCE
- INDEX



**CALIPER PARTS**



Quality replacements for OE caliper parts used to replace hard to find worn out stock components.

OEM #	Application	WPS#
<b>PAD PINS</b>		
OEM 42345-08	Softail, Dyna '08-16 Front	<b>820-51282</b>
OEM 42832-04	Sportster '04-13 Front	<b>820-51283</b>
OEM 42837-04	Sportster '04-13 Rear	<b>820-51284</b>
OEM 41300009	Sportster '14-16 Rear	<b>820-51285</b>
OEM 44314-00	All Models '00-07 Front/Rear	<b>820-51290</b>
<b>ANTI RATTLE SPRINGS</b>		
OEM 44337-00	Big Twins '00-07 Front/Rear	<b>820-51280</b>
OEM 43959-86	FLT '87-99, XL '91-92 Rear	<b>820-51281</b>
OEM 44337-08	Softail, Dyna '08-16 Front	<b>820-51286</b>
<b>RUBBER BOOTS AND BUMPERS</b>		
OEM 42823-04 Boot, Caliper Bushing	Sportster '04-16 Front	<b>820-51287</b>
OEM 42824-04 Boot Caliper Pin	Sportster '04-16 Front	<b>820-51288</b>
OEM 42863-06 Bumper	Touring, Vrod '08-16 Rear	<b>820-51289</b>
OEM 44351-00 Bumper (pr)	All Models '00-07 Rear	<b>820-51291</b>



**GOODRIDGE PREMIUM BRAKE LINE KITS**  
FLUID TRANSFER SYSTEMS

Goodridge Premium brake line kits feature the most current applications, with and without ABS and are available in clear or black PVC coated stainless braided hose with a teflon liner.

Application	Length	Clear	Black
<b>TOURING</b>			
All FLH/FLT '14-Up w/ABS (except FLTRX/S)	Stock	<b>817-01002</b>	<b>817-01006</b>
	+4	<b>817-01105</b>	<b>817-01120</b>
	+6	<b>817-01106</b>	<b>817-01121</b>
	+8	<b>817-01107</b>	<b>817-01122</b>
	+10	<b>817-01108</b>	<b>817-01123</b>
	+12	<b>817-01109</b>	<b>817-01124</b>
All FLTRX/S '15-Up w/ABS	Stock	<b>817-01003</b>	<b>817-01007</b>
	+4	<b>817-01110</b>	<b>817-01125</b>
	+6	<b>817-01111</b>	<b>817-01126</b>
	+8	<b>817-01112</b>	<b>817-01127</b>
	+10	<b>817-01113</b>	<b>817-01128</b>
	+12	<b>817-01114</b>	<b>817-01129</b>
All FLTRX/S '15-Up Non-ABS	Stock	<b>817-01009</b>	<b>817-01011</b>
	+4	<b>817-01135</b>	<b>817-01145</b>
	+6	<b>817-01136</b>	<b>817-01146</b>
	+8	<b>817-01137</b>	<b>817-01147</b>
	+10	<b>817-01138</b>	<b>817-01148</b>
	+12	<b>817-01139</b>	<b>817-01149</b>
FLHR/FLHX '14-Up Non-ABS	Stock	<b>817-01008</b>	<b>817-01010</b>
	+4	<b>817-01130</b>	<b>817-01140</b>
	+6	<b>817-01131</b>	<b>817-01141</b>
	+8	<b>817-01132</b>	<b>817-01142</b>
	+10	<b>817-01133</b>	<b>817-01143</b>
	+12	<b>817-01134</b>	<b>817-01144</b>
All FLH/FLT '08-13 w/ABS	Stock	<b>817-01001</b>	<b>817-01005</b>
	+4	<b>817-01100</b>	<b>817-01115</b>
	+6	<b>817-01101</b>	<b>817-01116</b>
	+8	<b>817-01102</b>	<b>817-01117</b>
	+10	<b>817-01103</b>	<b>817-01118</b>
	+12	<b>817-01104</b>	<b>817-01119</b>
FLHR/C 2008 w/ABS	Stock	<b>817-01000</b>	<b>817-01004</b>



Application	Length	Clear	Black
<b>SOFTAIL ABS FRONT KITS</b>			
FLSTFB 2011	Stock	<b>817-01012</b>	<b>817-01017</b>
FLSTC '11-Up	Stock	<b>817-01013</b>	<b>817-01018</b>
FLSTF FLSTN FLSTFB FLS '12-Up	Stock	<b>817-01014</b>	<b>817-01019</b>
FLSTF 2011	Stock	<b>817-01015</b>	<b>817-01020</b>
FXSB BREAKOUT '14-Up	Stock	<b>817-01016</b>	<b>817-01021</b>
<b>DYNA FRONT UPPER LINE</b>			
FXDWF FXDF '14-UP	Stock	<b>817-01022</b>	<b>817-01023</b>

**HIGHEND BRAKE LINE KITS**



High End kits are second to none in appearance and durability. This is Goodridge USA's best selling bolt on brake line kit. Featuring clear PVC coated stainless braided hose with PTFE inner liner, chromed fittings and ends that are pre-crimped and ready to install with the provided chrome banjo bolts and copper crush washers.

Application	Length	WPS#
<b>TOURING</b>		
All FLH/FLT '14-Up w/ABS	Stock	<b>817-01026</b>
	+4	<b>817-01155</b>
	+6	<b>817-01156</b>
	+8	<b>817-01157</b>
	+10	<b>817-01158</b>
	+12	<b>817-01159</b>
All FLTRX/S '15-Up w/ABS	Stock	<b>817-01027</b>
	+4	<b>817-01160</b>
	+6	<b>817-01161</b>
	+8	<b>817-01162</b>
	+10	<b>817-01163</b>
	+12	<b>817-01164</b>
FLHR/FLHX '14-Up Non-ABS	Stock	<b>817-01032</b>
	+4	<b>817-01180</b>
	+6	<b>817-01181</b>
	+8	<b>817-01182</b>
	+10	<b>817-01183</b>
All FLH/FLT '08-13 w/ABS	Stock	<b>817-01025</b>
	+4	<b>817-01150</b>
	+6	<b>817-01151</b>
	+8	<b>817-01152</b>
	+10	<b>817-01153</b>
	+12	<b>817-01154</b>
All FLH/FLT '08-13 Non-ABS	Stock	<b>817-01031</b>
	+4	<b>817-01175</b>
	+6	<b>817-01176</b>
	+8	<b>817-01177</b>
	+10	<b>817-01178</b>
	+12	<b>817-01179</b>
FLHT/C/CU '96-07 FLHX '06-07 Non-ABS	Stock	<b>817-01028</b>
	+4	<b>817-01165</b>
	+6	<b>817-01166</b>
	+8	<b>817-01167</b>
	+10	<b>817-01168</b>
	+12	<b>817-01169</b>
FLHR/C 2008 w/ABS	Stock	<b>817-01024</b>
FLHR/C '94-07 FLTR '98-07 Non-ABS	Stock	<b>817-01029</b>
	+4	<b>817-01170</b>
	+6	<b>817-01171</b>
	+8	<b>817-01172</b>
	+10	<b>817-01173</b>
	+12	<b>817-01174</b>
FLHRS/I '04-07 Non-ABS	Stock	<b>817-01030</b>
<b>TOURING REAR</b>		
All FLH/FLT '08-13 (Non-ABS)	Stock	<b>817-01035</b>
FLH/FLT '97-07	Stock	<b>817-01034</b>
FLH/FLT '92-96	Stock	<b>817-01033</b>

Application	Length	WPS#
<b>SOFTAIL ABS FRONT KITS</b>		
FLSTFB 2011	Stock	<b>817-01036</b>
FLSTC '11-UP	Stock	<b>817-01037</b>
FXST '11-UP	Stock	<b>817-01038</b>
FXCW 2011	Stock	<b>817-01039</b>
FLSTF FLSTN FLSTFB FLS '12-UP	Stock	<b>817-01040</b>
FLSTF 2011	Stock	<b>817-01041</b>
FXSB BREAKOUT '14-Up	Stock	<b>817-01042</b>
<b>SOFTAIL NON-ABS FRONT KITS</b>		
FLSTF '90-11 FLSTC '87-08	Stock	<b>817-01043</b>
FLSTC '09-12	Stock	<b>817-01044</b>
FLSTN '05-13 FLSTF/B '12-13	Stock	<b>817-01045</b>
<b>SOFTAIL REAR KITS</b>		
FLST MODELS '00-06	Stock	<b>817-01046</b>
FLSTSC 2007 FLSTC/N 2007	Stock	<b>817-01047</b>
FLSTF 2007	Stock	<b>817-01048</b>
ALL FLST MODELS '08-13	Stock	<b>817-01049</b>
<b>DYNA TRI-FRONT KITS</b>		
FXDF '08-UP	Stock	<b>817-01050</b>
FXDL FXDS '93-00 FXDB/C '91-92	Stock	<b>817-01051</b>
<b>DYNA SINGLE FRONT KITS</b>		
FXDWG '93-05	Stock	<b>817-01052</b>
FXD FXDC '00-05	Stock	<b>817-01053</b>
FXDL '01-05	Stock	<b>817-01054</b>
FXDB '06-15	Stock	<b>817-01055</b>
FXD35 '06-07	Stock	<b>817-01056</b>
FXDL '06-13 FLD '12-14	Stock	<b>817-01057</b>
FXDWG '06-08	Stock	<b>817-01058</b>
FXDWG '10-14	Stock	<b>817-01059</b>
FXDC '06-14	Stock	<b>817-01060</b>
<b>DYNA REAR KITS</b>		
FXD '08-Up	Stock	<b>817-01063</b>
FXD '00-07	Stock	<b>817-01062</b>
FXD '91-99	Stock	<b>817-01061</b>
<b>SPORTSTER FRONT KIT</b>		
XL1200N '08-12 XL883/1200C '04-10	Stock	<b>817-01065</b>
XL883 '04-09 XL883N '10-13	Stock	<b>817-01066</b>
XL1200L '07-11 XL883L '05-UP	Stock	<b>817-01067</b>
XL1200V '12-UP	Stock	<b>817-01068</b>
XL1200X '12-13	Stock	<b>817-01069</b>
XL883N XL1200X '14-15	Stock	<b>817-01070</b>
<b>SPORTSTER TRI-FRONT KIT</b>		
XL1200R '04-09 XL88R '04-13	Stock	<b>817-01064</b>
<b>SPORTSTER REAR KITS</b>		
All '87-03	Stock	<b>817-01071</b>

**ECONOLINE BRAKE LINE KITS**

Econoline OEM style kits feature clear PVC coated stainless braided hose and chromed mild steel hardware. You can pay more for brakeline kits but you cannot buy a more durable kit than Econoline.

Application	Length	WPS#
<b>TOURING TRI-FRONT KITS</b>		
All FLH/FLT '08-13	Stock	<b>817-01203</b>
	+4	<b>817-01310</b>
	+6	<b>817-01311</b>
	+8	<b>817-01312</b>
	+10	<b>817-01313</b>
	+12	<b>817-01314</b>
FLHT/C/CU '96-07 FLHX '06-07	Stock	<b>817-01200</b>
	+4	<b>817-01300</b>
	+6	<b>817-01301</b>
	+8	<b>817-01302</b>
	+10	<b>817-01303</b>
	+12	<b>817-01304</b>

Application	Length	WPS#
<b>TOURING TRI-FRONT KITS (CONT'D...)</b>		
FLHR/C '94-07 FLTR '98-07	Stock	<b>817-01201</b>
	+4	<b>817-01305</b>
	+6	<b>817-01306</b>
	+8	<b>817-01307</b>
	+10	<b>817-01308</b>
	+12	<b>817-01309</b>
FLHRS/I '04-07	Stock	<b>817-01202</b>
<b>TOURING REAR</b>		
All FLH/FLT '08-13 (Non-ABS)	Stock	<b>817-01205</b>
FLH/FLT '97-07	Stock	<b>817-01204</b>

Continued on the next page

- WINDSHIELDS / FAIRINGS
- AUDIO / COMMUNICATION
- SEATS / LUGGAGE
- BARS / MIRRORS / CONTROLS
- EXHAUST
- AIR / FUEL SYSTEMS
- ENGINE
- TRANSMISSION / DRIVELINE
- GASKETS / SEALS
- ELECTRICAL
- LIGHTING
- CABLES
- BRAKES**
- OIL FILTERS
- SUSPENSION
- BODY
- WHEELS
- TIRES / TIRE ACC.
- BIKE ACC.
- VICTORY / INDIAN
- COVERS / LOCKS / TIEDOWNS
- CHEMICALS
- TOOLS
- HELMETS
- HELMET ACC.
- EYEWEAR
- APPAREL / RIDER ACC.
- PROMOTIONAL
- REFERENCE
- INDEX



**ECONOLINE BRAKE LINE KITS**

FLUID TRANSFER SYSTEMS

Econoline OEM style kits feature clear PVC coated stainless braided hose and chromed mild steel hardware. You can pay more for brake line kits but you cannot buy a more durable kit than Econoline.

Application	Length	WPS#
<b>SOFTAIL SINGLE FRONT KITS</b>		
FLSTC '09-13	Stock	817-01206
FLSTFB '10-11	Stock	817-01207
FLST '09-10 FLSTC '86-08	Stock	817-01208
FLSTS '97-03 FXSTD '00-07	Stock	817-01209
FLSTSC '05-07	Stock	817-01210
FLSTF/FB '12-13 FLSTN '05-13 FLS	Stock	817-01211
FXS '11-13	Stock	817-01216
FXSTC '07-10	Stock	817-01217
FXCW FXCWC '08-11	Stock	817-01218
FXST '99-07 '84-90 FXDWG '93-05	Stock	817-01219
FXSTS '88-95	Stock	817-01220
FXSTS '96-06	Stock	817-01221
FXSTSB '95-97	Stock	817-01222
FXSTB '98-09	Stock	817-01223
<b>SOFTAIL REAR KITS</b>		
FLSTC/F/N/S 06-08 FXST/S/B 00-05	Stock	817-01212
FLSTSC FLSTC FLSTN 07 FXSTD 07	Stock	817-01213
FLSTF 07 FXST FXSTB FXSTC 07	Stock	817-01214
FLST ALL 08-15 FXST ALL 08-14	Stock	817-01215
FXSTC/S/SB/B 87-99	Stock	817-01224
FXSTB/S 06 FXST 00-06	Stock	817-01225
<b>DYNA TRI-FRONT KITS</b>		
FXDF '08-UP	Stock	817-01226

Application	Length	WPS#
<b>DYNA SINGLE FRONT KITS</b>		
FXDWG 06-08	Stock	817-01227
FXDWG 10	Stock	817-01228
FXD 00-14 XLH/C 883/1200 86-03	Stock	817-01229
FXDB 06-15	Stock	817-01230
FLD 12-14 FXDL 06-13	Stock	817-01231
FXD35 06-07	Stock	817-01232
<b>DYNA REAR KITS</b>		
FXD '08-UP	Stock	817-01235
FXD '00-07	Stock	817-01234
FXD '91-99	Stock	817-01233
<b>SPORTSTER FRONT KITS</b>		
XL1200N '08-12 XL883/1200C '04-10	Stock	817-01236
XL883 '04-09 XL883N '10-13	Stock	817-01237
XL1200L '07-11 XL883L '05-UP	Stock	817-01238
XL1200V '12-UP	Stock	817-01239
XL1200X '12-13	Stock	817-01240
XL883N XL1200X '14-15	Stock	817-01241
<b>SPORTSTER TRI-FRONT KITS</b>		
XL1200R/883R	Stock	817-01242
<b>SPORTSTER REAR KITS</b>		
All '87-03	Stock	817-01243

**EBONY BRAKE LINE KITS**

Ebony brake line kits are available for most popular Harley models. These budget priced kits feature black PVC coated stainless braided hose with matted black steel fittings and adapters. Kits ship complete in eco-friendly packaging with bolts and washers.

Application	Length	WPS#
<b>TOURING TRI-FRONT KITS</b>		
All FLH/FLT '08-13	Stock	817-01403
	+4	817-01510
	+6	817-01511
	+8	817-01512
	+10	817-01513
	+12	817-01514
FLHT/C/CU '96-07 FLHX '06-07	Stock	817-01400
	+4	817-01500
	+6	817-01501
	+8	817-01502
	+10	817-01503
	+12	817-01504
FLHR/C '94-07 FLTR '98-07	Stock	817-01401
	+4	817-01505
	+6	817-01506
	+8	817-01507
	+10	817-01508
	+12	817-01509
FLHRS/I '04-07	Stock	817-01402
<b>TOURING REAR</b>		
All FLH/FLT '08-13	Stock	817-01404
<b>SOFTAIL SINGLE FRONT KITS</b>		
FLSTN '05-11 FLSTF/B '12-13	Stock	817-01409
FLSTF '90-11 FLST '84-90	Stock	817-01405
FLSTC '09-12	Stock	817-01406
FLSTS '97-03	Stock	817-01407
FLSTSC '05-07	Stock	817-01408
FXSTC '07-10	Stock	817-01410
FXST '84-90 '99 FXSTC '87-99	Stock	817-01411
FXST-S '87-06	Stock	817-01412
FXST-SB '95-97	Stock	817-01413
FXSTB '99-09	Stock	817-01414

Application	Length	WPS#
<b>SOFTAIL REAR KITS</b>		
All FLST/FXST/FXCW '08-13	Stock	817-01415
FXST/FXSTS/FXSTB 2006	Stock	817-01416
FXST '00-05 FXSTD '00-06	Stock	817-01417
FXST 2007 FXSTB FXSTC 2007	Stock	817-01418
FXSTD 2007	Stock	817-01419
<b>DYNA TRI-FRONT KITS</b>		
FXDF '08-UP	Stock	817-01420
FXDL FXDS '93-00 FXDB/C '91-92	Stock	817-01421
FXDX '99-05	Stock	817-01422
<b>DYNA SINGLE FRONT KITS</b>		
FXDWG '93-05	Stock	817-01423
FXD/C '00-05	Stock	817-01424
FXDL '01-05	Stock	817-01425
FXDB '06-15	Stock	817-01426
FXD35 '06-07	Stock	817-01427
FXDLI '06-13 FLD '12-14	Stock	817-01428
FXDWGI '06-08	Stock	817-01429
FXDWGI '10-UP	Stock	817-01430
FXDC '06-14	Stock	817-01431
<b>DYNA REAR KITS</b>		
FXD '08-13	Stock	817-01432
<b>SPORTSTER FRONT KITS</b>		
XL1200N '08-12 XL883/1200C '04-10	Stock	817-01433
XL883 '04-09 XL883N '10-13	Stock	817-01434
XL1200L '07-11 XL883L '05-UP	Stock	817-01435
XL1200V '12-UP	Stock	817-01436
XL1200X '12-13	Stock	817-01437
XL883N XL1200X '14-15	Stock	817-01438



### ABS TUBE ADAPTERS

These adapters are used when installing tall bars on 2014 and later Touring models. They can be combined with extended Highend upper brake lines, so there is no need to purchase a complete 3 line kit.

Description	WPS#
Master Cylinder to ABS Box '14-16 Models	<b>817-02270</b>
Tri Front Tube for Non-ABS '14-16 Models	<b>817-02271</b>



### BRAKE LIGHT BANJOS

Goodridge brake light banjo bolts are banjo bolts with a built in pressure switch and are wired to adapt to virtually any model that utilizes a hydraulic stoplight system. Perfect for eliminating brake tees in HD rear brake line applications or converting Offroad bikes to street legal.



Description	WPS#
3/8-24	<b>817-02200</b>
10mm X 1.25	<b>817-02201</b>
10mm X 1.00	<b>817-02202</b>



### SPEEDBLEEDERS

- Speedbleeder, the patented bleeder screw with the built in check valve
- To bleed the brakes, simply loosen each bleeder 1/4 turn and pump the lever
- When the job is completed re-tighten the bleeder and you're done!

Description	Application	WPS#
10mm X 1.0 1.35" SB1010	Ducati All Models Front	<b>817-02250</b>
1/4-28 1.00" SB1428	FL/FX '58-77 XL '73-77	<b>817-02251</b>
3/8-24 1.29" SB3824	FXD '93-14 FLH '80-07 FXST, FLST '87-13 XL '78-03	<b>817-02252</b>
6mm X 1.0 1.13" SB6100	Ducati All Models Clutch	<b>817-02253</b>
7mm X 1.0 1.38" SB7100	Kawasaki, Suzuki All Models Front CBR1000R Front	<b>817-02254</b>
8mm X 1.25 1.10" SB8125	Kawasaki, Yamaha All Models Clutch	<b>817-02255</b>
8mm X 1.25 Long 1.28" SB8125L	FLH/FLT '08-13 XL '04-13	<b>817-02256</b>
8mm X 1.25 Extra Long 1.50" SB8125LL	Goldwings Front/Rear/Clutch	<b>817-02257</b>

• Please note: Brembo uses SB1010, Nissin uses SB1428L, Tokico uses SB7100

- WINDSHIELDS / FAIRINGS
- AUDIO / COMMUNICATION
- SEATS / LUGGAGE
- BARS / MIRRORS / CONTROLS
- EXHAUST
- AIR / FUEL SYSTEMS
- ENGINE
- TRANSMISSION / DRIVELINE
- GASKETS / SEALS
- ELECTRICAL
- LIGHTING
- CABLES
- BRAKES**
- OIL FILTERS
- SUSPENSION
- BODY
- WHEELS
- TIRES / TIRE ACC.
- BIKE ACC.
- VICTORY / INDIAN
- COVERS / LOCKS / TIEDOWNS
- CHEMICALS
- TOOLS
- HELMETS
- HELMET ACC.
- EYEWEAR
- APPAREL / RIDER ACC.
- PROMOTIONAL
- REFERENCE
- INDEX

**GOODRIDGE**  
FLUID TRANSFER SYSTEMS

**UNIVERSAL BRAKE LINES**

Universal brake lines are the most efficient brake line solution for virtually all bikes. The lines come pre-assembled with -3 female swivels that mate with the accompanying universal fittings. Goodridge offers a variety of fitment options to match the appearance and geometry of any bike. Hoses are available in clear or black PVC coated stainless braided versions. Hardware is available in chrome or black zinc finish.



Description	Clear	Ebony
9"	<b>817-01800</b>	<b>817-01829</b>
11"	<b>817-01801</b>	<b>817-01830</b>
12"	<b>817-01802</b>	<b>817-01831</b>
14"	<b>817-01803</b>	<b>817-01832</b>
15"	<b>817-01804</b>	<b>817-01833</b>
16"	<b>817-01805</b>	<b>817-01834</b>
17"	<b>817-01806</b>	<b>817-01835</b>
18"	<b>817-01807</b>	<b>817-01836</b>
19"	<b>817-01808</b>	<b>817-01837</b>
20"		<b>817-01838</b>
21"	<b>817-01809</b>	<b>817-01839</b>
22"	<b>817-01810</b>	
23"	<b>817-01811</b>	<b>817-01840</b>
24"	<b>817-01812</b>	<b>817-01841</b>
26"		<b>817-01842</b>
28"		<b>817-01843</b>
30"		<b>817-01844</b>
32"	<b>817-01813</b>	

Description	Clear	Ebony
34"		<b>817-01845</b>
36"		<b>817-01846</b>
38"	<b>817-01814</b>	<b>817-01847</b>
40"	<b>817-01815</b>	<b>817-01848</b>
42"	<b>817-01816</b>	<b>817-01849</b>
44"		<b>817-01850</b>
46"	<b>817-01817</b>	<b>817-01851</b>
47"	<b>817-01818</b>	<b>817-01852</b>
48"	<b>817-01819</b>	
50"	<b>817-01820</b>	<b>817-01853</b>
52"	<b>817-01821</b>	<b>817-01854</b>
54"	<b>817-01822</b>	<b>817-01855</b>
61"	<b>817-01823</b>	
63"	<b>817-01824</b>	
65"	<b>817-01825</b>	
71"	<b>817-01826</b>	
73"	<b>817-01827</b>	
75"	<b>817-01828</b>	

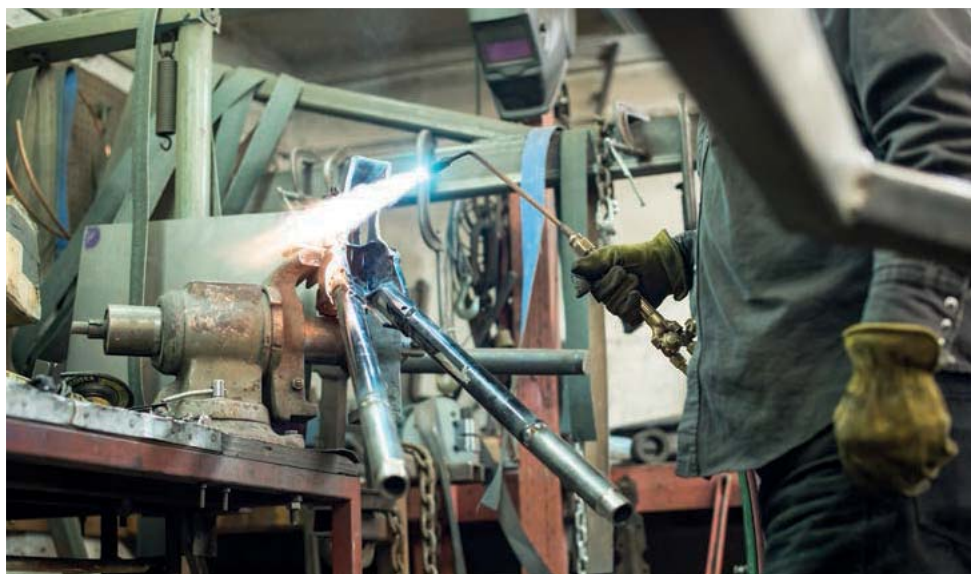





Description	Chrome	Ebony
3/8"-10mm Straight Banjo	<b>817-01856</b>	<b>817-01883</b>
7/16" Straight Banjo	<b>817-01857</b>	<b>817-01884</b>
12mm Straight Banjo	<b>817-01858</b>	
3/8"-10mm 35 Degree Banjo	<b>817-01859</b>	<b>817-01885</b>
7/16" 35 Degree Banjo	<b>817-01860</b>	<b>817-01886</b>
3/8"-10mm 90 Degree Banjo	<b>817-01861</b>	<b>817-01887</b>
7/16" 90 Degree Banjo	<b>817-01862</b>	<b>817-01888</b>
3/8" JIC to -3 Tube Adapter 45 Degree	<b>817-01863</b>	<b>817-01889</b>
3/8" JIC to -3 Tube Adapter 60 Degree	<b>817-01864</b>	<b>817-01890</b>
3/8" JIC to -3 Tube Adapter S-bend	<b>817-01865</b>	<b>817-01891</b>
3/8" JIC to -3 Tube Adapter 90 Degree Short	<b>817-01866</b>	<b>817-01892</b>
3/8" JIC to -3 Tube Adapter 90 Degree Long	<b>817-01867</b>	<b>817-01893</b>
3/8" JIC to -3 Tube Adapter 3/8-24 Male	<b>817-01868</b>	<b>817-01894</b>

Description	Chrome	Ebony
Rear Brake Manifold Softail '00-06	<b>817-01869</b>	
Rear Brake Adapter 45 Degree	<b>817-01870</b>	
Rear Brake Light Tee	<b>817-01871</b>	<b>817-01895</b>
Rear Brake Light Tee w/Bracket	<b>817-01872</b>	<b>817-01896</b>
Rear Brake Tee w/Bracket		<b>817-01897</b>
Tee Adapter for Tri-Front Kit	<b>817-01873</b>	<b>817-01898</b>
Banjo Bolt 3/8-24 Long	<b>817-01874</b>	<b>817-01899</b>
Banjo Bolt 7/16-24	<b>817-01875</b>	<b>817-01900</b>
Banjo Bolt 10mm X 1.0 Short	<b>817-01876</b>	<b>817-01901</b>
Banjo Bolt 10mm X 1.25	<b>817-01877</b>	<b>817-01902</b>
Banjo Bolt 10mm X 1.0 Short '08-13 Touring	<b>817-01878</b>	
Double Banjo Bolt 3/8-24	<b>817-01640</b>	<b>817-01641</b>
Rear Caliper Crush Washer	<b>817-01879</b>	
Clutch Actuator Adapter	<b>817-01880</b>	
Banjo Bolt 3/8-24	<b>817-01881</b>	
Tee Bar	<b>817-01882</b>	<b>817-01903</b>

- WINDSHIELDS / FAIRINGS
- AUDIO / COMMUNICATION
- SEATS / LUGGAGE
- BAR / MIRRORS / CONTROLS
- EXHAUST
- AIR / FUEL SYSTEMS
- ENGINE
- TRANSMISSION / DRIVELINE
- GASKETS / SEALS
- ELECTRICAL
- LIGHTING
- CABLES
- BRAKES**
- OIL FILTERS
- SUSPENSION
- BODY
- WHEELS
- TIRES / TIRE ACC.
- BIKE ACC.
- VICTORY / INDIAN
- COVERS / LOCKS / TIEDOWNS
- CHEMICALS
- TOOLS
- HELMETS
- HELMET ACC.
- EYEWEAR
- APPAREL / RIDER ACC.
- PROMOTIONAL
- REFERENCE
- INDEX

**GOODRIDGE**  
FLUID TRANSFER SYSTEMS

**SNIPER 2 BUILDERS KIT** 

- Available in stainless steel or black finish
- Each kit contains multiples of all Sniper 2 components



Description	WPS#
Sniper 2 Builders Kit CLEAR	<b>817-2300</b>
Sniper 2 Builders Kit BLACK	<b>817-2301</b>



- WINDSHIELDS / FAIRINGS
- AUDIO / COMMUNICATION
- SEATS / LUGGAGE
- BARS / MIRRORS / CONTROLS
- EXHAUST
- AIR / FUEL SYSTEMS
- ENGINE
- TRANSMISSION / DRIVELINE
- GASKETS / SEALS
- ELECTRICAL
- LIGHTING
- CABLES**
- BRAKES**
- OIL FILTERS
- SUSPENSION
- BODY
- WHEELS
- TIRES / TIRE ACC.
- BIKE ACC.
- VICTORY / INDIAN
- COVERS / LOCKS / TIEDOWNS
- CHEMICALS
- TOOLS
- HELMETS
- HELMET ACC.
- EYEWEAR
- APPAREL / RIDER ACC.
- PROMOTIONAL
- REFERENCE
- INDEX

**SNIPER 2 BRAKE LINES**

Sniper 2 products are made to ride hard and excel in high performance applications. They are easily assembled without any specialty tools. Their micro size is ideal for routing through concealed areas such as forks, frames and handlebars. Available in clear or black PVC coated braided hose. Hardware is available in stainless steel or black. Complete Builders Kits are available on request.



Description	Stainless	Black
7/16-24 Straight Male Adapter	<b>817-01600</b>	<b>817-01615</b>
3/8-24 Straight Male Adapter	<b>817-01601</b>	<b>817-01616</b>
3/8 Straight Banjo	<b>817-01602</b>	<b>817-01617</b>
7/16 Straight Banjo	<b>817-01603</b>	<b>817-01618</b>
3/8 20 Degree Banjo	<b>817-01604</b>	<b>817-01619</b>
7/16 20 Degree Banjo	<b>817-01605</b>	<b>817-01620</b>
3/8 90 Degree Banjo	<b>817-01606</b>	<b>817-01621</b>
7/16 90 Degree Banjo	<b>817-01607</b>	<b>817-01622</b>
3/8-24 Female Straight Fitting	<b>817-01608</b>	
1/8" NPT Straight Male Adapter	<b>817-01609</b>	<b>817-01623</b>
1/8" NPT 90 Degree Male Adapter		<b>817-01624</b>
Hose Union		<b>817-01625</b>
3/8-24 Female Straight Adapter		<b>817-01626</b>
Hose Collar 2pk	<b>817-01610</b>	<b>817-01627</b>
7/16-24 Banjo Bolt	<b>817-01612</b>	<b>817-01631</b>
3/8-24 Banjo Bolt	<b>817-01611</b>	<b>817-01630</b>
10mm X 1.25 Banjo Bolt	<b>817-01613</b>	<b>817-01628</b>
10mm X 1.00 Banjo Bolt	<b>817-01614</b>	<b>817-01629</b>
<b>HOSE</b>		
6Ft	<b>817-01635</b>	<b>817-01632</b>
12Ft	<b>817-01636</b>	<b>817-01633</b>
25Ft	<b>817-01637</b>	<b>817-01634</b>

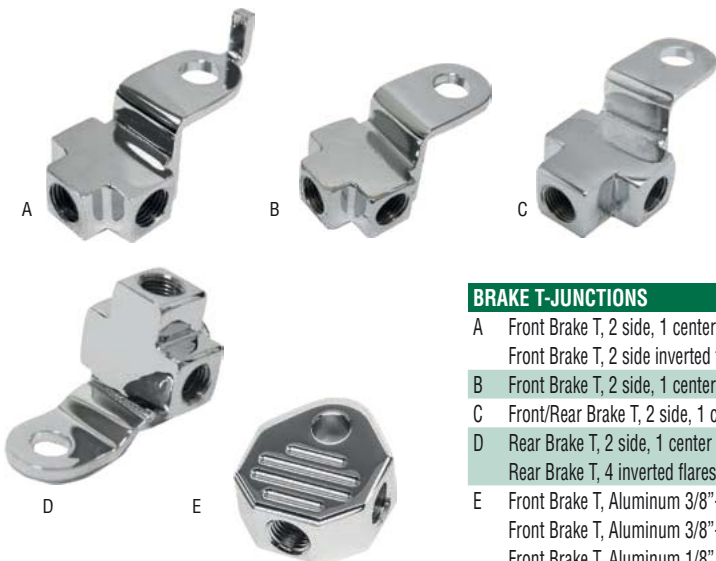

**BRAKE TEES**

- Chrome plated brake line junctions
- Available for various applications front and rear
- Sold each

Application	WPS#
<b>BRAKE T-JUNCTIONS</b>	
A Front Brake T, 2 side, 1 center inverted flare (OE 44310-77)	<b>820-51800</b>
Front Brake T, 2 side inverted flare, 1 center 1/8" NPT (OE 43308-78)	<b>820-51801</b>
B Front Brake T, 2 side, 1 center inverted flare (OE 44311-80)	<b>820-51802</b>
C Front/Rear Brake T, 2 side, 1 center 1/8" NPT for '77-79 FXS (OE 42138-72)	<b>820-51803</b>
D Rear Brake T, 2 side, 1 center inverted flare, 1 bottom 1/8" NPT (OE 83566-51)	<b>820-51804</b>
Rear Brake T, 4 inverted flares (OE 42309-70)	<b>820-51805</b>
E Front Brake T, Aluminum 3/8"-24 inverted flare in all holes	<b>820-51806</b>
Front Brake T, Aluminum 3/8"-24 inverted flare in two holes, 1/8" NPT in center	<b>820-51807</b>
Front Brake T, Aluminum 1/8" NPT in all holes	<b>820-51808</b>

WINDSHIELDS / FAIRINGS  
AUDIO / COMMUNICATION  
SEATS / LUGGAGE  
BARS / MIRRORS / CONTROLS  
EXHAUST  
AIR / FUEL SYSTEMS  
ENGINE  
TRANSMISSION / DRIVELINE  
GASKETS / SEALS  
ELECTRICAL  
LIGHTING  
CABLES  
**BRAKES**  
OIL FILTERS  
SUSPENSION  
BODY  
WHEELS  
TIRES / TIRE ACC.  
BIKE ACC.  
VICTORY / INDIAN  
COVERS / LOCKS / TIEDOWNS  
CHEMICALS  
TOOLS  
HELMETS  
HELMET ACC.  
EYEWEAR  
APPAREL / RIDER ACC.  
PROMOTIONAL  
REFERENCE  
INDEX



AMERICAN V-TWIN PRODUCTS

**BRAKELINE KITS**



- PTFE Teflon lined stainless braided hose
- UV Protected PVC cover to protect painted and or chrome surfaces.
- Clear & Black color options
- Triple chrome plated fittings for superior corrosion resistance
- All installation hardware included (Banjo Bolts, copper crush washers and Tee Junction Block)
- Lifetime warranty

Description	TOURING	Year	MINUS 4"	MINUS 2"	OEM LENGTH	PLUS 1"	PLUS 2"
Steel braided 3 line kit	FLHT w/o ABS	'08-13					<b>820-3098C</b>
Black 3 line kit		'08-13			<b>820-3001B</b>		<b>820-3098B</b>
Steel braided 4 line kit	FLHT/FLHR w/ABS	'09-13			<b>820-3007C</b>		<b>820-3099C</b>
Black 4 line kit		'09-13			<b>820-3007B</b>		<b>820-3099B</b>
Steel braided 4 line kit	FLTR w/ABS	'09-13			<b>820-3025C</b>		<b>820-3026C</b>
Black 4 line kit		'09-13			<b>820-3025B</b>		<b>820-3026B</b>
Steel braided 3 line kit	FLTR/FLHR w/o ABS	'08-13					<b>820-3098C</b>
Black 3 line kit		'08-13			<b>820-3001B</b>		<b>820-3098B</b>
Steel braided 3 line kit	FLTR/FLHR	'96-07			<b>820-3019C</b>		<b>820-3097C</b>
Black 3 line kit		'96-07			<b>820-3019B</b>		<b>820-3097B</b>
<b>DESCRIPTION</b>							
Steel braided single line kit	FL/FXS w/ABS	'11-13			<b>820-3079C</b>	<b>820-3100C</b>	
Black single line kit		'11-13			<b>820-3079B</b>	<b>820-3100B</b>	
Steel braided single line kit	FL w/o ABS (exc. FLSTSB)	'96-13			<b>820-3049C</b>	<b>820-3050C</b>	
Black single line kit		'96-13			<b>820-3049B</b>	<b>820-3050B</b>	
Steel braided single line	FLSTSB	'08-11			<b>820-3061C</b>	<b>820-3062C</b>	
Black single line		'08-11			<b>820-3061B</b>	<b>820-3062B</b>	
Steel braided single line	FX models	'00-10			<b>820-3067C</b>	<b>820-3068C</b>	
Black single line		'00-10			<b>820-3067B</b>	<b>820-3068B</b>	
<b>DESCRIPTION</b>							
Steel braided single line	FXDB	'06-13	<b>820-3031C</b>	<b>820-3101C</b>	<b>820-3102C</b>	<b>820-3034C</b>	
Black single line		'06-13	<b>820-3031B</b>	<b>820-3101B</b>	<b>820-3102B</b>	<b>820-3034B</b>	
Steel braided single line	FXDWG	'06-08			<b>820-3043C</b>	<b>820-3044C</b>	
Black single line					<b>820-3043B</b>	<b>820-3044B</b>	
<b>DESCRIPTION</b>							
Steel braided single line	All models	'04-13					
Black single line		'04-13					
Steel braided single line	All models	'99-03					
Black single line		'99-03					



**UNIVERSAL BRAKELINES**

- Braided stainless steel line with a clear protective sleeve
- Sold each
- Banjo fitting on both ends

Description	WPS#	Description	WPS#
18 Inch	<b>170-0018</b>	26 Inch	<b>170-0026</b>
20 Inch	<b>170-0020</b>	28 Inch	<b>170-0028</b>
22 Inch	<b>170-0022</b>	30 Inch	<b>170-0030</b>
24 Inch	<b>170-0024</b>	32 Inch	<b>170-0032</b>
		34 Inch	<b>170-0034</b>





**BRAKELINE KITS**



- PTFE Teflon lined stainless braided hose
- UV Protected PVC cover to protect painted and or chrome surfaces.
- Clear & Black color options

- Triple chrome plated fittings for superior corrosion resistance
- All installation hardware included (Banjo Bolts, copper crush washers and Tee Junction Block)
- Lifetime warranty

PLUS 4"	PLUS 5"	PLUS 6"	PLUS 7"	PLUS 8"	PLUS 10"	PLUS 12"
		820-3003C		820-3004C	820-3005C	820-3006C
		820-3003B		820-3004B	820-3005B	820-3006B
		820-3009C		820-3010C	820-3011C	820-3012C
		820-3009B		820-3010B	820-3011B	820-3012B
		820-3027C		820-3028C	820-3029C	820-3030C
		820-3027B		820-3028B	820-3029B	820-3030B
		820-3003C		820-3004C	820-3005C	820-3006C
		820-3003B		820-3004B	820-3005B	820-3006B
				820-3022C	820-3023C	820-3024C
				820-3022B	820-3023B	820-3024B
820-3081C		820-3082C		820-3083C	820-3084C	
820-3081B		820-3082B		820-3083B	820-3084B	
820-3051C				820-3053C		
820-3051B		820-3052B			820-3054B	
820-3063C		820-3064C		820-3065C	820-3066C	
820-3063B		820-3064B		820-3065B	820-3066B	
820-3069C		820-3070C		820-3071C	820-3072C	
820-3069B		820-3070B		820-3071B	820-3072B	
	820-3035C		820-3036C			
	820-3035B		820-3036B			
820-3045C		820-3046C		820-3047C	820-3048C	
820-3045B		820-3046B		820-3047B	820-3048B	
		820-3088C		820-3106C	820-3107C	
				820-3106B	820-3107B	
820-3095C		820-3096C		820-3104C	820-3105C	
820-3095B		820-3096B		820-3104B	820-3105B	



A



B

**BRAKELINE CLAMPS**

- Fits all models with 1/4"-20 threaded hole at the base of the triple tree

Description	WPS#
A Chrome brake line clamp	820-2673
B Chrome brake line clamp for 5/16" brake line	820-2674



A



B

**BANJO BOLT KITS**

- Heavy chrome plated banjo bolts to fit single and dual applications
- Includes sealing washers



C

Description	WPS#
A Chrome Hex Banjo bolt kit 3/8"-24 bolt with 10mm washers for front dual disc master cylinders	820-0550
B Chrome 12mm Banjo Bolt kit 7/16"-24 bolt with 12mm washers for front single disc master cylinders	820-0551
C 3/8" Banjo Bolt Washer w/ Seal	820-0552

WINDSHIELDS / FAIRINGS  
 AUDIO / COMMUNICATION  
 SEATS / LUGGAGE  
 BARS / MIRRORS / CONTROLS  
 EXHAUST  
 AIR / FUEL SYSTEMS  
 ENGINE  
 TRANSMISSION / DRIVELINE  
 GASKETS / SEALS  
 ELECTRICAL  
 LIGHTING  
 CABLES  
**BRAKES**  
 OIL FILTERS  
 SUSPENSION  
 BODY  
 WHEELS  
 TIRES / TIRE ACC.  
 BIKE ACC.  
 VICTORY / INDIAN  
 COVERS / LOCKS / TIEDOWNS  
 CHEMICALS  
 TOOLS  
 HELMETS  
 HELMET ACC.  
 EYEWEAR  
 APPAREL / RIDER ACC.  
 PROMOTIONAL  
 REFERENCE  
 INDEX



## REAR MASTER CYLINDERS

AMERICAN V-TWIN PRODUCTS

- Chrome plated replacement master cylinders
- Mount in stock location

OEM#	Application	Chrome
<b>REAR MASTER CYLINDER</b>		
	Kelsey-Hayes Style '79-82 FX, '83 FXE, '80-81 XL	<b>820-51813</b>
42453-82A	FL Softail '86-E87, XL '82-E87	<b>820-51814</b>
42446-87B	FX Softail '87-99	<b>820-51817</b>
42474-90B	FXD '90-05	<b>820-51816</b>
42456-87B	XL '87-03	<b>820-51815</b>
<b>REAR MASTER CYLINDER REBUILD KITS</b>		
42810-04B	XL '04-06	<b>820-50604</b>
42810-07A	XL '07-Up	<b>820-50605</b>

820-51813



820-51814



## REAR MASTER CYLINDERS 4-SPD MODELS

- Complete master cylinders
- Available in chrome plated or raw "blasted" finish

Application	Raw	Chrome
<b>REAR MASTER CYLINDER</b>		
Fits '58-65 FL Drum Brake, '66-72 FX (OE 41761-58)	<b>820-51809</b>	<b>820-51810</b>
Fits '73-E79 FX/FL (OE 41761-78)	<b>820-51811</b>	<b>820-51812</b>

820-51810



820-51811



## SMOOTH REAR MASTER CYLINDER



- Available in Show Chrome and Black With Contrast Cut Accents
- Comes With Chrome Banjo Bolt and Washers
- For Custom Applications

Description	WPS #
Smooth Master Cylinder CHR	<b>820-70205</b>
Smooth Master Cylinder BLK	<b>820-70206</b>
Master Cylinder Rebuild Kit 14MM	<b>820-70207</b>



820-70205



820-70206



820-70207

## REAR BRAKE MASTER CYLINDER COVERS

- OEM replacement
- Chrome finish
- Includes mounting hardware

Description	OEM#	WPS#
'99-04 Touring and '00-05 Softail	45149-99C	<b>820-51820</b>
'05-07 Touring and '06-Up Softail	46425-05	<b>820-51821</b>
'08-16 Touring	46463-08	<b>820-51822</b>



820-51822



820-51821



820-51820



## REAR BRAKE MASTER CYLINDER MOUNTING KIT

- Zinc plated OEM replacement hardware
- Made in the USA!

Description	Application	OEM#	WPS#
Zinc plated stud, bolt, and washer used to mount master cylinder	'87-99 Softail	42301-87	<b>830-1106</b>



**CALIPER REBUILD KITS**



Description	Application	OEM#	WPS#
Front Caliper Seal Kit	XL, FX '74-77	44277-74, 44278-74	<b>865-01200</b>
	FX Dual Disc 'L77-83 (two required)	44151-77, 44153-77	<b>865-01201</b>
	Big Twin, Sportster '84-99	44047-83, 44022-83	<b>865-01202</b>
Rear Caliper Seal Kit	XL '79-81	44152-77, 44180-77	<b>865-01203</b>
	FXR '82-E87	44208-82	<b>865-01204</b>
	FXR 'L87-99	44045-87	<b>865-01205</b>
Front and Rear Caliper Seal Kit	FL '80-84, FX '81-82 (rear only)	44007-80	<b>865-01206</b>
	FL '72-80 (except FLT) Single Disc, FX '73-80 (rear only)	44127-72A, 44133-72	<b>865-01207</b>
Rear Caliper Seal Kit	FLT '79-85 w/Dual Piston (two required)	43945-79, 43947-79	<b>865-01208</b>
Front and Rear Caliper Seal Kit	Big Twin and Sportster '00-07	44328-00, 44330-00	<b>865-01209</b>
Front and Rear Caliper Seal Kit w/Pistons	Big Twin and Sportster '00-07	44313-00	<b>865-01210</b>
Front Caliper Seal Kit w/Pistons	Touring Models 08-Up		<b>865-01211</b>

**MASTER CYLINDER REBUILD KITS**



Application	Description	OEM#	WPS#
A 86-95 Softails , '93-95 FXDWG, '87-94 FXR	Front Master Cylinder Repair Kit 5/8"	45072-87	<b>865-01250</b>
B '96-11 FXD/FXDWG, '96-10 FLST/FXST, '96-07 FLT and '96-03 XL	Front Master Cylinder Repair Kit 11/16"	45072-96	<b>865-01252</b>
	Front Master Cylinder Repair Kit 9/16"	45006-96	<b>865-01253</b>
C 'L87-14 Big Twin (except '91 and '08-Up Touring and Trike), '87-03 XL	Rear Master Cylinder Cartridge	42382-87A/C	<b>865-01251</b>



**MASTER CYLINDER REBUILD KITS**

For OEM and aftermarket front master cylinders.



Description	Application	WPS#
A Master Cylinder Rebuild Kit	Front 96-Up 9/16" Bore	<b>820-50601</b>
	Front 96-Up 5/8" Bore	<b>820-50602</b>
	Front 96-Up 11/16" Bore	<b>820-50603</b>
B	11mm Single '07-Up XL	<b>820-32010</b>
C	1/2" Dual '07-Up XL	<b>820-32011</b>
D	'08-Up Touring Rear	<b>820-52942</b>
Banjo Bolt Washers	3/8" Washer with Seal	<b>820-0552</b>

- WINDSHIELDS / FAIRINGS
- AUDIO / COMMUNICATION
- SEATS / LUGGAGE
- BAR / MIRRORS / CONTROLS
- EXHAUST
- AIR / FUEL SYSTEMS
- ENGINE
- TRANSMISSION / DRIVELINE
- GASKETS / SEALS
- ELECTRICAL
- LIGHTING
- CABLES
- BRAKES**
- OIL FILTERS
- SUSPENSION
- BODY
- WHEELS
- TIRES / TIRE ACC.
- BIKE ACC.
- VICTORY / INDIAN
- COVERS / LOCKS / TIEDOWNS
- CHEMICALS
- TOOLS
- HELMETS
- HELMET ACC.
- EYEWEAR
- APPAREL / RIDER ACC.
- PROMOTIONAL
- REFERENCE
- INDEX

- WINDSHIELDS / FAIRINGS
- AUDIO / COMMUNICATION
- SEATS / LUGGAGE
- BAR / MIRRORS / CONTROLS
- EXHAUST
- AIR / FUEL SYSTEMS
- ENGINE
- TRANSMISSION / DRIVELINE
- GASKETS / SEALS
- ELECTRICAL
- LIGHTING
- CABLES
- BRAKES**
- OIL FILTERS
- SUSPENSION
- BODY
- WHEELS
- TIRES / TIRE ACC.
- BIKE ACC.
- VICTORY / INDIAN
- COVERS / LOCKS / TIEDOWNS
- CHEMICALS
- TOOLS
- HELMETS
- HELMET ACC.
- EYEWEAR
- APPAREL / RIDER ACC.
- PROMOTIONAL
- REFERENCE
- INDEX



## MASTER CYLINDER COVERS



820-55004



820-52940



820-52941



820-52921

Description	Chrome	Black
Replacement Brake Master Cylinder Cover '14-Up FLT	<b>820-55004</b>	
Replacement Clutch Master Cylinder Cover '14-Up FLT (w/Gasket)	<b>820-55006</b>	
Replacement Master Cylinder Cover '96-06	<b>820-52940</b>	<b>820-52941</b>
Replacement Master Cylinder Cover '82-95	<b>820-52921</b>	



## MASTER CYLINDER COVERS

- CNC Machined 6061 aluminum
- Six different anodized colored options
- Machined Rooke logo
- Replaces OEM M/C cover
- '14-Up Touring lid works on '08-Up when OEM gasket 42857-06B or 42857-06C is used
- Sold each
- Made in the USA

Description	Application	Finish	WPS#
Front Master Cylinder Cover	'96-08 Big Twins	Raw	<b>825-02010</b>
		Black	<b>825-02011</b>
		Polished	<b>825-02012</b>
		Gold	<b>825-02013</b>
		Red	<b>825-02014</b>
		Blue	<b>825-02015</b>
	'08-13 Touring	Raw	<b>825-02080</b>
		Black	<b>825-02081</b>
		Polished	<b>825-02082</b>
		Gold	<b>825-02083</b>
Clutch Master Cylinder Cover	'14-Up Touring	Raw	<b>825-02530</b>
		Black	<b>825-02531</b>
		Polished	<b>825-02532</b>
		Gold	<b>825-02533</b>
		Red	<b>825-02534</b>
		Blue	<b>825-02535</b>
	'08-Up Touring	Raw	<b>825-02515</b>
		Black	<b>825-02516</b>
		Polished	<b>825-02517</b>
		Gold	<b>825-02518</b>
Rear Master Cylinder Cover	'08-Up Touring	Raw	<b>825-02500</b>
		Black	<b>825-02501</b>
		Polished	<b>825-02502</b>
		Gold	<b>825-02503</b>
		Red	<b>825-02504</b>
		Blue	<b>825-02505</b>



Raw



Black



Polished



Gold



Red



Blue



Raw



Black



Polished



Gold



Red



Blue



# BILLET UPPER & LOWER BRAKE CYLINDER COVERS



- Precision Billet Darkside cover easily replaces your stock master cylinder cap
- Adds style and a unique look
- CNC milled out of 6061 Aircraft Grade Billet Aluminum
- Black anodized finish contrast cut or our two-tone chrome



Ace's Wild Upper - Chrome



Ace's Wild Upper - Black



Darkside Upper - Black



Ace's Wild Lower - Chrome



Ace's Wild Lower - Black



Darkside Lower - Chrome



Darkside Lower - Black

Application		Chrome	Black
<b>UPPER MASTERCYLINDER COVER</b>			
Ace's Wild	Softail/Dyna '96-14, Touring '96-07, XL '96-03	<b>810-0163</b>	<b>810-0164</b>
Darkside	Softail/Dyna '96-14, Touring '96-07, XL '96-03	<b>810-0161</b>	<b>810-0162</b>
Ace's Wild	Touring '08-17	<b>810-0153</b>	<b>810-0154</b>
Darkside	Touring '08-17	<b>810-0151</b>	<b>810-0152</b>
Darkside	Sportster '04-13	<b>810-0171</b>	<b>810-0172</b>
<b>LOWER MASTER CYLINDER</b>			
Ace's Wild	Softail '00-17, Dyna '06-17, Touring '99-07	<b>810-0223</b>	<b>810-0224</b>
Darkside	Softail '00-17, Dyna '06-17, Touring '99-07	<b>810-0221</b>	<b>810-0222</b>
Ace's Wild	Touring '08-17	<b>810-0203</b>	<b>810-0204</b>
Darkside	Touring '08-17	<b>810-0201</b>	<b>810-0202</b>

- WINDSHIELDS / FAIRINGS
- AUDIO / COMMUNICATION
- SEATS / LUGGAGE
- BAR / MIRRORS / CONTROLS
- EXHAUST
- AIR / FUEL SYSTEMS
- ENGINE
- TRANSMISSION / DRIVELINE
- GASKETS / SEALS
- ELECTRICAL
- LIGHTING
- CABLES
- BRAKES**
- OIL FILTERS
- SUSPENSION
- BODY
- WHEELS
- TIRES / TIRE ACC.
- BIKE ACC.
- VICTORY / INDIAN
- COVERS / LOCKS / TIEDOWNS
- CHEMICALS
- TOOLS
- HELMETS
- HELMET ACC.
- EYEWEAR
- APPAREL / RIDER ACC.
- PROMOTIONAL
- REFERENCE
- INDEX



OIL FILTERS



- Choose from a Chrome or Black finish
- Available with Hex nut on the top, making maintenance a breeze
- Meets or exceeds OE specifications

Model	Year	Black	Black w/ hex nut	Chrome	Chrome w/ hex nut
<b>TOURING</b>					
Milwaukee 8	'17-Up	820-0721	820-0723	820-0720	820-0722
Twin Cam models	'99-17	820-0721	820-0723	820-0720	820-0722
FLHT Electra Glide	'99	820-0701	820-0703	820-0700	820-0702
Evo models	'85-98	820-0701	820-0703	820-0700	820-0702
<b>SOFTAIL</b>					
Milwaukee 8	'18-Up	820-0721	820-0723	820-0720	820-0722
Twin Cam models	'00-17	820-0721	820-0723	820-0720	820-0722
Evo models	'80-99	820-0701	820-0703	820-0700	820-0702
<b>DYNA/FXR</b>					
Twin Cam Dyna models	'99-17	820-0721	820-0723	820-0720	820-0722
Evo FXR models	'82-94	820-0701	820-0703	820-0700	820-0702
<b>SPORTSTER 883-1200CC</b>					
Evo models	Late '84-18	820-0701	820-0703	820-0700	820-0702



PREMIUM QUALITY OIL FILTERS

Application	Year	Standard	Chrome
<b>TOURING</b>			
All models	'84-98	14-6022	14-6065B
	'82-84		14-6019
<b>SOFTAIL</b>			
All models	'84-99	14-6022	14-6065B
<b>DYNA/FXR</b>			
All FXR models	'84-94	14-6022	14-6065B
All Dyna models	'91-98		14-6068
FXWG,FXEF, FXE 1340	'82-86		14-6019
<b>SPORTSTER</b>			
All models	'86-18	14-6022	14-6065B
	'80-early 84		14-6019
<b>V-ROD</b>			
All models	'02-17	14-6100	



- State of the art canister construction eliminates leakage or high pressure blowout
- Fram uses only the finest filtering media to keep oil clean and prevent excessive wear



- Quality oil filters manufactured by one of the largest manufacturers and suppliers of motorcycle oil filters
- High performance oil filter with a high oil flow capacity
- Withstand high heat and pressures
- Microglass filter media traps particles down to 10 microns in size, compared to 20 microns for regular filter media



Application	Year	Standard	Chrome	Microglass Chrome	Microglass Black
<b>TOURING</b>					
All models	'84-98	56-8241	56-8824	56-8246	56-8245
	'82-84	56-8249			
Drop in tank type with seals	'78-84	56-8283			
<b>SOFTAIL</b>					
All models	'84-99	56-8241	56-8824	56-8246	56-8245
<b>DYNA/FXR</b>					
All FXR models	'84-94	56-8241	56-8824	56-8246	56-8245
All Dyna models	'91-98	56-8247			
FXWG,FXEF, FXE 1340	'82-86	56-8249			
Drop in tank type with seals	'79-85	56-8283			
<b>SPORTSTER</b>					
All models	'86-18	56-8241	56-8824	56-8246	56-8245
	'80-early 84	56-8249			
Drop in tank type with seals	'54-78	56-8283			



**BILLET REUSABLE OIL FILTERS**

- CNC Machined billet filter housing
- Finned to increase cooling ability
- Stainless mesh filter media improves flow over paper of fabric media
- Easy to rinse and reuse
- Filter element with three magnets

Application	Year	Chrome	Black
Touring	'82-18	<b>820-55450</b>	<b>820-55451</b>
Softail	'84-18	<b>820-55450</b>	<b>820-55451</b>
Dyna	'91-17	<b>820-55450</b>	<b>820-55451</b>
Sportster	'85-18	<b>820-55450</b>	<b>820-55451</b>
Replacement O-ring		<b>820-55452</b>	



**FLO® REUSABLE OIL FILTERS**

- Reusable filters made from type 304 stainless steel micronic filter cloth
- Rare earth magnet is attached to the top of the element for pre-filtering the oil
- Sophisticated bypass system is engineered for greater oil filtration and proper bypass pressures
- Anodized aluminum housing looks great and helps dissipate heat

Application	Year	Polished	Black	Replacement O-Ring
Touring	'82-18	<b>56-7104</b>	<b>56-7104BK</b>	<b>56-7191</b>
Softail	'84-18	<b>56-7104</b>	<b>56-7104BK</b>	<b>56-7191</b>
Dyna	'91-17	<b>56-7104</b>	<b>56-7104BK</b>	<b>56-7191</b>
Sportster	'85-18	<b>56-7104</b>	<b>56-7104BK</b>	<b>56-7191</b>
V-Rod (all models)	'02-17	<b>56-7106</b>		<b>56-7191</b>
All models with Drop-In tank filter	'53-82	<b>56-7107</b>		

WINDSHIELDS / FAIRINGS

AUDIO / COMMUNICATION

SEATS / LUGGAGE

BAR / MIRRORS / CONTROLS

EXHAUST

AIR / FUEL SYSTEMS

ENGINE

TRANSMISSION / DRIVELINE

GASKETS / SEALS

ELECTRICAL

LIGHTING

CABLES

BRAKES

**OIL FILTERS**

SUSPENSION

BODY

WHEELS

TIRES / TIRE ACC.

BIKE ACC.

VICTORY / INDIAN

COVERS / LOCKS / TIEDOWNS

CHEMICALS

TOOLS

HELMETS

HELMET ACC.

EYEWEAR

APPAREL / RIDER ACC.

PROMOTIONAL

REFERENCE

INDEX



- Provides unbeatable performance and exceptional value, Hiflo filters are the best-selling brand of aftermarket filters for motorcycles worldwide
- To achieve our high quality and to ensure the consistency of our products, we use only premium raw materials from well known manufacturers
- Every oil filter goes through 16 individual quality control checks before it is ready to leave the factory. The whole manufacturing process, including the checking of raw materials and individual filter testing, is regularly audited and verified independently
- Race filters have a welded-on 5/8"/17mm nut with safety wire provisions to make installation and removal easier

Model	Year	OEM#	Chrome	OEM#	Black
<b>BUELL</b>					
All models (exc. below)	'02-10			63806-00Y	<b>550-0177</b>
1125R/CR	'09-10				<b>550-0564</b>
All models	'94-02		<b>550-0171C</b>		<b>550-0171</b>
Race filter	'94-02		<b>550-0171CR</b>		<b>550-0171R</b>
<b>HARLEY DAVIDSON</b>					
<b>TOURING</b>					
All Touring models (exc. below)	'99-18	63798-99	<b>550-0171C</b>	63731-99	<b>550-0171</b>
Race filter	'99-18		<b>550-0171CR</b>		<b>550-0171R</b>
FLHT Electra Glide	'99	63796-77	<b>550-0170C</b>	63805-80A	<b>550-0170</b>
Race Filter	'99		<b>550-0170CR</b>		<b>550-0170R</b>
FLH models	'85-98	63796-77	<b>550-0170C</b>	63805-80A	<b>550-0170</b>
Race Filter	'85-98		<b>550-0170CR</b>		<b>550-0170R</b>
	'82-84	63782-80T	<b>550-0172C</b>		
FLT models	'80-98	63796-77	<b>550-0170C</b>	63805-80A	<b>550-0170</b>
Race Filter	'80-98		<b>550-0170CR</b>		<b>550-0170R</b>
In-Tank Filter	'54-80			63840-53	<b>550-0178</b>
<b>SOFTAIL</b>					
All models (Twin Cam, M8)	'99-18	63798-99	<b>550-0171C</b>	63731-99	<b>550-0171</b>
Race filter (Twin Cam, M8)	'99-18		<b>550-0171CR</b>		<b>550-0171R</b>
All Models (exc. Twin Cam)	'84-99	63796-77	<b>550-0170C</b>	63805-80A	<b>550-0170</b>
Race Filter (exc. Twin Cam)	'84-99		<b>550-0170CR</b>		<b>550-0170R</b>
<b>DYNA/FXR</b>					
All Dyna models	'99-17	63798-99	<b>550-0171C</b>	63731-99	<b>550-0171</b>
Race filter	'99-17		<b>550-0171CR</b>		<b>550-0171R</b>
All Dyna models	'91-98	63813-90	<b>550-0173C</b>		
All FXR models	'82-94	63796-77	<b>550-0170C</b>	63805-80A	<b>550-0170</b>
Race Filter	'82-94		<b>550-0170CR</b>		<b>550-0170R</b>
FXE, FXEF, FXDWG	'82-85	63782-80T	<b>550-0172C</b>		
FXB Sturgis, FXDB Daytona	All	63813-90	<b>550-0173C</b>		
In-Tank Filter	'54-80			63840-53	<b>550-0178</b>
<b>SPORTSTER</b>					
All models	'L84-18	63796-77	<b>550-0170C</b>	63805-80A	<b>550-0170</b>
All models	'L84-18		<b>550-0170CR</b>		<b>550-0170R</b>
	'80-E84	63782-80T	<b>550-0172C</b>		
In-Tank Filter	'54-80			63840-53	<b>550-0178</b>
<b>STREET</b>					
All models	'14-18			62700045	<b>550-0175</b>
<b>V-ROD</b>					
VRSC V-Rod	'02-17	63793-01K	<b>550-0174C</b>		



**STRAP WRENCH**

- Fits all spin-on type oil filters
- Use with 3/8" drive ratchet handle
- Easily loosens tight filters
- Fits into hard to reach locations
- Can be used to loosen or tighten cylindrical shaped parts



Application	WPS#
Cloth Strap	<b>57-8000</b>



- Extra engine protection
- Meets or exceeds OEM flow rates
- Designed for use with synthetic oils
- Silicone impregnated seals for optimum sealing

Model	Year	Black	Chrome
<b>TOURING 74-114CI</b>			
All Touring models (exc. listed below)	'99-18	<b>56-0171</b>	<b>56-0171C</b>
FLHT Electra Glide	'99	<b>56-0170</b>	<b>56-0170C</b>
FLH models	'85-98	<b>56-0170</b>	<b>56-0170C</b>
	'82-84	<b>56-0172</b>	<b>56-0172C</b>
FLT models	'80-98	<b>56-0170</b>	<b>56-0170C</b>
<b>SOFTAIL 74-114CI</b>			
All Softail models	'00-18	<b>56-0171</b>	<b>56-0171C</b>
	'80-99	<b>56-0170</b>	<b>56-0170C</b>
<b>DYNA/FXR 74-110 CI</b>			
All Dyna models	'99-17	<b>56-0171</b>	<b>56-0171C</b>
All Dyna models	'91-98	<b>56-0173</b>	<b>56-0173C</b>

Model	Year	Black	Chrome
<b>DYNA/FXR 74-110 CI (CONT'D...)</b>			
All FXR models*	'82-94	<b>56-0170</b>	<b>56-0170C</b>
FXE, FXEF, FXDWG	'82-85	<b>56-0172</b>	<b>56-0172C</b>
FXB Sturgis	'80, '82	<b>56-0173</b>	<b>56-0173C</b>
<b>SPORTSTER 883-1200CC</b>			
All XL models	Late '84-18	<b>56-0170</b>	<b>56-0170C</b>
All XL models	'80-84	<b>56-0172</b>	<b>56-0172C</b>
<b>STREET 500-750CC</b>			
All XG models	'14-18	<b>56-0204</b>	<b>56-0204C</b>
<b>V-ROD 1130-1250 CC</b>			
All VRSC models	'02-17	<b>56-0174</b>	<b>56-0174C</b>



### STAINLESS STEEL BRAIDED HOSE

- Braided stainless steel oil/fuel line
- Silver finish
- Do not use with E85 fuels



Description	Length	WPS#
Stainless Braided Oil/Fuel Line 1/4"	25'	<b>820-70240</b>
	6'	<b>820-70241</b>
	3'	<b>820-70242</b>
Stainless Braided Oil/Fuel Line 5/16"	25'	<b>820-70243</b>
	6'	<b>820-70244</b>
	3'	<b>820-70245</b>
Stainless Braided Oil/Fuel Line 3/8"	25'	<b>820-70246</b>
	6'	<b>820-70247</b>
	3'	<b>820-70248</b>

### FUEL/OIL LINE



- OEM look and performance
- Black rubber, multilayer (5 layer) extrusion, to handle any fuel, hot oil and other harsh fluids.
- Meets SAE, EPA, & CARB standards for all powersports/motorcycles
- Safe for all types of fuel and oil: pure gas, diesel, E-10, E-15, E-85
- SAE 30R9 rated for fuel injection.



Description	Length	WPS#
OE Style Fuel/Oil Line 3/8"	3'	<b>22-0056</b>
	10'	<b>22-0057</b>

- WINDSHIELDS / FAIRINGS
- AUDIO / COMMUNICATION
- SEATS / LUGGAGE
- BAR / MIRRORS / CONTROLS
- EXHAUST
- AIR / FUEL SYSTEMS
- ENGINE
- TRANSMISSION / DRIVELINE
- GASKETS / SEALS
- ELECTRICAL
- LIGHTING
- CABLES
- BRAKES
- OIL FILTERS**
- SUSPENSION
- BODY
- WHEELS
- TIRES / TIRE ACC.
- BIKE ACC.
- VICTORY / INDIAN
- COVERS / LOCKS / TIEDOWNS
- CHEMICALS
- TOOLS
- HELMETS
- HELMET ACC.
- EYEWEAR
- APPAREL / RIDER ACC.
- PROMOTIONAL
- REFERENCE
- INDEX



### OIL COOLER/FILTER KIT

Cleaner cooler oil with the Feuling® oil cooler/filtration system, this oil cooler is designed with an internal spun glass element cartridge filter which is used as an additional oil filter in conjunction with the factory spin on oil filter. The Feuling® oil cooler system drastically reduces contamination and viscosity breakdown in the oil; protecting the engine from cylinder, piston, ring and bearing wear. Preventing extreme oil temperatures, promoting engine performance, longer engine life & extended oil change intervals.

This oil cooler system makes a clean custom look, mounting between the frame rails in position to take advantage of the air flow from the front tire. Available in chrome or gloss black, the housing measures 5 long and 3-3/4 in diameter.

Kits include filter cooler housing, replaceable spun glass cartridge filter, gloss black mounting bracket, off-set oil filter adapter, braided steel lines with swivel fittings, K&N® spin-on oil filter, ARP® 12 bolt fasteners and all necessary hardware. Kits available in chrome finish with stainless lines, & black finish with black lines.

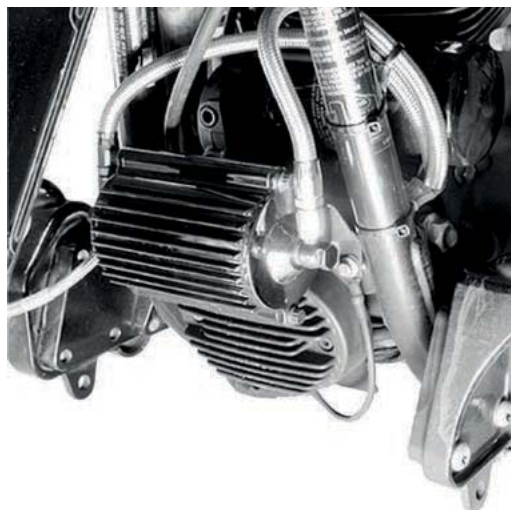

Application	Year	Chrome	Black
Touring	'99-16	811-02002	811-02007
Softail	'99-17	811-02000	811-02005

- WINDSHIELDS / FAIRINGS
- AUDIO / COMMUNICATION
- SEATS / LUGGAGE
- BAR / MIRRORS / CONTROLS
- EXHAUST
- AIR / FUEL SYSTEMS
- ENGINE
- TRANSMISSION / DRIVELINE
- GASKETS / SEALS
- ELECTRICAL
- LIGHTING
- CABLES
- BRAKES
- OIL FILTERS**
- SUSPENSION
- BODY
- WHEELS
- TIRES / TIRE ACC.
- BIKE ACC.
- VICTORY / INDIAN
- COVERS / LOCKS / TIEDOWNS
- CHEMICALS
- TOOLS
- HELMETS
- HELMET ACC.
- EYEWEAR
- APPAREL / RIDER ACC.
- PROMOTIONAL
- REFERENCE
- INDEX



## FOX SERIES FLH/FLT AIR SUSPENSION



Arnott's stylish new chrome rebound adjustable FOX® Air Suspension System has been custom designed for Harley-Davidson Touring models to give the rider superior control, additional ride comfort settings and fast ride height adjustability.

The FOX shock's custom valving, designed for your motorcycle, provides you with a safe and comfortable ride. Arnott's patent-pending kit offers TruAIR technology with a rugged Goodyear air spring bladder and shock damper design, not an air cylinder or air-assisted unit. For added ride comfort this kit includes FOX's adjustable rebound control dial so you can quickly and easily adjust your shocks' internal damping characteristics – a feature not found elsewhere in the air suspension market.

Application	Year	Black	Chrome
FLH/FLT	'09-17	850-01035	850-01036
<b>WITH REBOUND ADJUSTMENT</b>			
FLH/FLT	'09-17	850-01033	850-01034



## FOX SERIES SOFTAIL AIR SUSPENSION

Arnott's new adjustable Air Suspension System for the Harley-Davidson Softail® has been custom designed for the Softail frame to provide the rider with superior control, ride comfort and height adjustability. The kit, featuring Arnott's TruAIR technology, includes a rugged air spring bladder and is not an air cylinder or air-assisted unit. Arnott includes a powerful compressor and black anodized cover which attaches to the regulator rectifier to hide and protect the compressor.

Application	Year	Black	Chrome
Softails	'01-17	850-01090	850-01091



## FOX SERIES V-ROD AIR SUSPENSION

At the core of this system are two custom nitrogen charged FOX shock absorbers. Then, using a patent-pending design, Arnott adds a rugged Goodyear® air spring, ensuring superior comfort, ride quality, and durability. Arnott pairs your shocks with a small but powerful compressor, application-specific mounting bracket, and air distribution valve block which include a muffler to control how fast air is released. Each kit includes everything you need for a fast and flawless installation including Detailed Installation Manual, fused wiring harness and relay assembly, handlebar-mounted inflation switch, all necessary tubing, cable ties, fittings, bolt covers, and mounting accessories.

Application	Year	Black	Chrome
V-Rod	'07-17	850-01044	850-01045
<b>WITH REBOUND ADJUSTMENT</b>			
V-Rod	'07-17	850-01042	850-01043

- WINDSHIELDS / FAIRINGS
- AUDIO / COMMUNICATION
- SEATS / LUGGAGE
- BAR / MIRRORS / CONTROLS
- EXHAUST
- AIR / FUEL SYSTEMS
- ENGINE
- TRANSMISSION / DRIVELINE
- GASKETS / SEALS
- ELECTRICAL
- LIGHTING
- CABLES
- BRAKES
- OIL FILTERS
- SUSPENSION**
- BODY
- WHEELS
- TIRES / TIRE ACC.
- BIKE ACC.
- VICTORY / INDIAN
- COVERS / LOCKS / TIEDOWNS
- CHEMICALS
- TOOLS
- HELMETS
- HELMET ACC.
- EYEWEAR
- APPAREL / RIDER ACC.
- PROMOTIONAL
- REFERENCE
- INDEX



## BILSTEIN SERIES AIR SUSPENSION

The chrome Bilstein® Series shocks feature a patented monotube shock and a Goodyear® air spring. Bilstein's patented valving will eliminate heat build up in the shock that can lead to unsafe driving conditions. These hand-crafted shocks are proudly made in the USA.

### Features

- Bilstein Monotube Shock
- Patented Monotube Design
- Fade-Free Dampening
- Black Anodize or Show Quality Chrome Finish
- Improves Ride Quality



Application	Year	Black	Chrome
<b>BILSTEIN SERIES</b>			
FLH/FLT 12"	'09-17	<b>850-01012</b>	<b>850-01037</b>
	'80-07	<b>850-01038</b>	<b>850-01039</b>
Dyna 12"	'08-17	<b>850-01062</b>	<b>850-01063</b>
	'91-07	<b>850-01066</b>	<b>850-01067</b>
Sportster 12"	'09-17	<b>850-01080</b>	<b>850-01081</b>
	'05-08	<b>850-01082</b>	<b>850-01083</b>

## ACCESSORIES



Our handle bar mounted push button switch control is available as an option with every Harley-Davidson® suspension system, and features momentary push button controls that manage the air suspension. The left button activates the compressor to inflate the system, while the right opens the vent valve for deflation. This kit is pre-wired and easy to install, and comes in black anodize or chrome finish.

### Features

- Ideal Mounting Location
- Easy to Install
- CNC-Machined Aluminum
- Black Anodize or Chrome Finish
- Weather-Resistant Switches
- Engineered & Assembled in USA



Description	Application	Black	Chrome
Handlebar Control Button	Universal	<b>850-01200</b>	<b>850-01201</b>
Pressure Gauge	Touring Models	<b>850-01202</b>	<b>850-01203</b>
Pressure Gauge w/Toggle	Touring Models	<b>850-01204</b>	<b>850-01205</b>
LED Pressure Gauge w/Toggle		<b>850-01206</b>	<b>850-01207</b>





## FOX SHOCKS FOR TOURING MODELS

- Model-specific optimized ride tune
- Gas-charged mono-tube, with internal floating piston
- 1.5" 6061-T6 aluminum type III hard anodized body
- Fully serviceable and rebuildable
- Advanced high-flow, deflective disk, velocity-sensitive damping
- Hand-adjustable spring preload
- Hand-adjustable rebound damping (REB ADJ VERSION ONLY)
- 1/2" low friction, super-finished hard chrome shaft
- Carbon Black spring available with standard or heavy duty spring rates
- Available in standard 13" or low 12" lengths
- Machine cut aluminum billet preload adjuster and spring seat
- Laser-etched FOX logos



Application	Description	WPS#
<b>PRELOAD ADJUSTABLE</b>		
Fit Touring Models '84-16	12"	<b>897-27000</b>
	12" Heavy Duty	<b>897-27001</b>
	13"	<b>897-27002</b>
	13" Heavy Duty	<b>897-27003</b>
<b>PRELOAD/REBOUND ADJUSTABLE</b>		
Fit Touring Models '84-16	12"	<b>897-27004</b>
	12" Heavy Duty	<b>897-27005</b>
	13"	<b>897-27006</b>
	13" Heavy Duty	<b>897-27007</b>
Shock Preload Wrench		<b>535-9795</b>

- WINDSHIELDS / FAIRINGS
- AUDIO / COMMUNICATION
- SEATS / LUGGAGE
- BARS / MIRRORS / CONTROLS
- EXHAUST
- AIR / FUEL SYSTEMS
- ENGINE
- TRANSMISSION / DRIVELINE
- GASKETS / SEALS
- ELECTRICAL
- LIGHTING
- CABLES
- BRAKES
- OIL FILTERS
- SUSPENSION**
- BODY
- WHEELS
- TIRES / TIRE ACC.
- BIKE ACC.
- VICTORY / INDIAN
- COVERS / LOCKS / TIEDOWNS
- CHEMICALS
- TOOLS
- HELMETS
- HELMET ACC.
- EYEWEAR
- APPAREL / RIDER ACC.
- PROMOTIONAL
- REFERENCE
- INDEX



**FOX SHOCKS FOR DYNA/FXR MODELS**

- Model-specific optimized ride tune
- Available in gas-charged mono-tube or remote reservoir versions both with internal floating piston
- 1.5" 6061-T6 aluminum type III hard anodized body
- Fully serviceable and rebuildable
- Advanced high-flow, deflective disk, velocity-sensitive damping
- Hand-adjustable spring preload
- 1/2" low friction, super-finished hard chrome shaft
- Carbon Black spring
- Monotube shock available in stock 12.5" or 11.5" inch lowered height
- Remote reservoir shock available in stock 12.5" or 13.5" raised height
- Remote reservoir shock features adjustable compression and rebound
- Machine cut aluminum billet preload adjuster and spring seat
- Laser-etched FOX logos



A



D



B



C

Application	Description	WPS#
<b>MONOTUBE SHOCK</b>		
Fit Dyna Models '91-Up	11.5"	<b>897-27100</b>
	A 12.5"	<b>897-27101</b>
Fit FXR Models '82-94	B 13"	<b>897-27020</b>
	C 14" w/Rebound Adjust	<b>897-27021</b>
<b>RC1 SHOCK</b>		
Fit Dyna Models '91-Up	12.5"	<b>897-27110</b>
	D 13.5"	<b>897-27111</b>
Shock Preload Wrench		<b>535-9795</b>



- WINDSHIELDS / FAIRINGS
- AUDIO / COMMUNICATION
- SEATS / LUGGAGE
- BARS / MIRRORS / CONTROLS
- EXHAUST
- AIR / FUEL SYSTEMS
- ENGINE
- TRANSMISSION / DRIVELINE
- GASKETS / SEALS
- ELECTRICAL
- LIGHTING
- CABLES
- BRAKES
- OIL FILTERS
- SUSPENSION**
- BODY
- WHEELS
- TIRES / TIRE ACC.
- BIKE ACC.
- VICTORY / INDIAN
- COVERS / LOCKS / TIEDOWNS
- CHEMICALS
- TOOLS
- HELMETS
- HELMET ACC.
- EYEWEAR
- APPAREL / RIDER ACC.
- PROMOTIONAL
- REFERENCE
- INDEX

**FOX SHOCKS FOR SPORTSTER MODELS**



Adjustments:

**RC1**

- Wide-range rebound
- Low-speed compression
- Spring preload

**IFP-R**

- Wide-range rebound
- Spring preload

**IFP**

- Spring preload



A



C



B

- Model-specific optimized ride tune
- Gas-charged piggyback reservoir with internal floating piston on RC1 version
- Gas-charged mono-tube, with internal floating piston on IFP and IFP-R versions
- 1.5" 6061-T6 aluminum type III hard anodized body
- Fully serviceable and rebuildable
- Advanced high-flow, deflective disk, velocity-sensitive damping
- 5/8" low friction, super-finished hard chrome shaft on IFP-R and RC1 versions
- 1/2" low friction, super-finished hard chrome shaft on IFP version
- Carbon Black spring
- Black aluminum billet preload adjuster and spring seat
- Optional "Blackout" reservoir decal included
- Laser-etched FOX logos

Application	Description	WPS#
<b>MONOTUBE SHOCK</b>		
Fit Sportster Models '88-Up	11"	<b>897-27016</b>
A	12"	<b>897-27022</b>
	13"	<b>897-27015</b>
B	13" w/Rebound Adjust	<b>897-27018</b>
<b>RC1 SHOCK</b>		
Fit Sportster Models '88-Up	C 13.5"	<b>897-27017</b>
Shock Preload Wrench		<b>535-9795</b>



- WINDSHIELDS / FAIRINGS
- AUDIO / COMMUNICATION
- SEATS / LUGGAGE
- BAR / MIRRORS / CONTROLS
- EXHAUST
- AIR / FUEL SYSTEMS
- ENGINE
- TRANSMISSION / DRIVELINE
- GASKETS / SEALS
- ELECTRICAL
- LIGHTING
- CABLES
- BRAKES
- OIL FILTERS
- SUSPENSION**
- BODY
- WHEELS
- TIRES / TIRE ACC.
- BIKE ACC.
- VICTORY / INDIAN
- COVERS / LOCKS / TIEDOWNS
- CHEMICALS
- TOOLS
- HELMETS
- HELMET ACC.
- EYEWEAR
- APPAREL / RIDER ACC.
- PROMOTIONAL
- REFERENCE
- INDEX



**RUSTY BUTCHER SIGNATURE SERIES**



Mark Atkins (@MarkTheButcher) is the face behind Rusty Butcher, a premium clothing and leather goods brand.

Growing up he started riding motocross at 3 years old, racing at 4 and it was only a matter of time before his obsession with Harleys and love for jumping anything collided. Mark is a leader in innovation in free riding and dirt track racing on Harley Davidson Motorcycles. FOX worked closely with Mark to develop the Rusty Butcher Signature Series Street Performance QS3-R shocks.

**FEATURES:**

- High-performance Rusty Butcher-developed ride tune
- Aluminum piggyback reservoir
- Advanced high-flow deflective disc velocity-sensitive damping
- 1.5" 6061-T6 aluminum type III hard anodized body
- 5/8" low friction, super-finished hard chrome shaft
- Matte Black spring
- Billet preload adjuster and spring seat
- Fully rebuildable and revalveable
- Designed and Assembled in the US

Application	Description	WPS#
<b>QS3-R SHOCKS</b>		
Fit Sportster Models '88-Up	14"	<b>897-27019</b>



- WINDSHIELDS / FAIRINGS
- AUDIO / COMMUNICATION
- SEATS / LUGGAGE
- BAR / MIRRORS / CONTROLS
- EXHAUST
- AIR / FUEL SYSTEMS
- ENGINE
- TRANSMISSION / DRIVELINE
- GASKETS / SEALS
- ELECTRICAL
- LIGHTING
- CABLES
- BRAKES
- OIL FILTERS
- SUSPENSION**
- BODY
- WHEELS
- TIRES / TIRE ACC.
- BIKE ACC.
- VICTORY / INDIAN
- COVERS / LOCKS / TIEDOWNS
- CHEMICALS
- TOOLS
- HELMETS
- HELMET ACC.
- EYEWEAR
- APPAREL / RIDER ACC.
- PROMOTIONAL
- REFERENCE
- INDEX

State of the art suspension technology for riders that demand the best performance from their motorcycle suspension.



### AIR CANNON HLR SHOCKS



- 6061-T6 Cold forged mounting cap and one piece damping body increases strength and fatigue resistance by 15%
- Fully tunable and serviceable SAV (Speed Adaptive Valve) damping system
- Co-axial Hi/Lo speed compression damping adjustment. High speed damping 24 clicks, low speed damping 24 clicks

- Wide range low speed rebound adjustment 24 clicks
- 36mm CNC 7075-T6 damping piston
- 42mm Type 3 hard coat anodized damper body
- IFP (Internal Floating Piston) design ensures the most stable damping quality and enables the shock to be mounted in either direction



Air pump included

Application	Description	WPS#
Fit Dyna Models '91-Up (except FXDF)	12.5"	<b>890-01161</b>
	13"	<b>890-01162</b>
	14"	<b>890-01163</b>
Fit Sportster Models '91-Up FXR '84-94	12.5"	<b>890-01164</b>
	13"	<b>890-01165</b>
	14"	<b>890-01166</b>

### MONOTUBE AIR SHOCKS



- 6061-T6 Cold forged mounting cap and one piece damping body increases strength and fatigue resistance by 15%
- Fully tunable and serviceable SAV (Speed Adaptive Valve) damping system
- Wide range low speed rebound adjustment 24 clicks

- 36mm CNC 7075-T6 damping piston
- 42mm Type 3 hard coat anodized damper body
- IFP (Internal Floating Piston) design ensures the most stable damping quality and enables the shock to be mounted in either direction



Air pump included



Application	Description	WPS#
Fit Touring Models '84-17	12"	<b>890-01150</b>
	12.5"	<b>890-01151</b>
	13"	<b>890-01152</b>
Fit Dyna Models '91-Up (except FXDF)	12"	<b>890-01153</b>
	12.5"	<b>890-01154</b>
	13"	<b>890-01155</b>
	14"	<b>890-01156</b>
Fit Sportster Models '91-Up FXR '84-94	12"	<b>890-01157</b>
	12.5"	<b>890-01158</b>
	13"	<b>890-01159</b>
	14"	<b>890-01160</b>



Dial



Digital

### DIGITAL AIR PUMP



Make exact adjustments to your Racing Bros Air Cannon shocks with the digital or dial air pump, set your sag to the desired setting every time. Pumps can be used for other air shocks.

Description	WPS#
Digital Air Pump	<b>890-01061</b>
Dial Air Pump	<b>890-01062</b>

- WINDSHIELDS / FAIRINGS
- AUDIO / COMMUNICATION
- SEATS / LUGGAGE
- BAR / MIRRORS / CONTROLS
- EXHAUST
- AIR / FUEL SYSTEMS
- ENGINE
- TRANSMISSION / DRIVELINE
- GASKETS / SEALS
- ELECTRICAL
- LIGHTING
- CABLES
- BRAKES
- OIL FILTERS
- SUSPENSION**
- BODY
- WHEELS
- TIRES / TIRE ACC.
- BIKE ACC.
- VICTORY / INDIAN
- COVERS / LOCKS / TIEDOWNS
- CHEMICALS
- TOOLS
- HELMETS
- HELMET ACC.
- EYEWEAR
- APPAREL / RIDER ACC.
- PROMOTIONAL
- REFERENCE
- INDEX



State of the art suspension technology for riders that demand the best performance from their motorcycle suspension.

**SCEPTER 25 FORK CARTRIDGE** 

- The most advanced fork cartridge kit available for Harley Davidson motorcycles.
- High performance cartridge with IFP design, 25mm CNC 7075-T6 damping piston ensures stable damping quality
- High strength Cr-Si steel material used for the spring ensures a consistent spring rate and best fatigue resistance
- Wide range rebound adjuster 24 clicks
- Wide range compression adjuster 24 clicks
- Preload adjustability of 15mm on both sides
- Multiple spring rate options available



Application	Description	WPS#
Fit FXD, FXDL, FXDB '06-Up (49mm)	STD	<b>890-01203</b>
	MED	<b>890-01204</b>
	HVY	<b>890-01205</b>
Fit XL883R '11-15, '09-15 XL1200V, '91-10 XL1200C/883C/N	STD	<b>890-01167</b>
	HVY	<b>890-01200</b>
Fit '11-15 XL883N, '91-15 XL883L, '10-15 XL1200X, '07-12 XL1200N, '06-12 XL1200L	STD	<b>890-01201</b>
	HVY	<b>890-01202</b>
<b>OPTIONAL SPRINGS</b> Springs for 49mm Cartridge	STD	<b>890-01252</b>
	MED	<b>890-01253</b>
	HVY	<b>890-01254</b>
Springs for 39mm Cartridge	STD	<b>890-01250</b>
	HVY	<b>890-01251</b>

- WINDSHIELDS / FAIRINGS
- AUDIO / COMMUNICATION
- SEATS / LUGGAGE
- BARS / MIRRORS / CONTROLS
- EXHAUST
- AIR / FUEL SYSTEMS
- ENGINE
- TRANSMISSION / DRIVELINE
- GASKETS / SEALS
- ELECTRICAL
- LIGHTING
- CABLES
- BRAKES
- OIL FILTERS
- SUSPENSION**
- BODY
- WHEELS
- TIRES / TIRE ACC.
- BIKE ACC.
- VICTORY / INDIAN
- COVERS / LOCKS / TIEDOWNS
- CHEMICALS
- TOOLS
- HELMETS
- HELMET ACC.
- EYEWEAR
- APPAREL / RIDER ACC.
- PROMOTIONAL
- REFERENCE
- INDEX



## BAZOOKA REAR SHOCKS

HardDrive Bazooka rear shocks with RacingBros' race proven SAV, "Speed Adaptive Valving", damping system provides superior ride quality regardless of road conditions!  
Details:

- Speed Adaptive Valving (SAV)
- Internal Floating Piston (IFP) stabilizes damping performance
- One-Piece damping body construction forged from A7075 aluminum
- Easy set up spring preload cap, no special tool needed
- Rebound adjustable version available
- Available in 12", 12.5" or 13" lengths
- Heavy Duty spring rate recommended for riders over 200 lbs or frequent 2-up riding

Application	Description	WPS#
<b>PRELOAD ADJUSTABLE</b>		
Fit Touring Models '84-17	12" STD	<b>890-01030</b>
	13" STD	<b>890-01031</b>
	12" HD	<b>890-01032</b>
	13" HD	<b>890-01033</b>
Fit Dyna Models '91-17	12.5" STD	<b>890-01003</b>
	13" STD	<b>890-01004</b>
	12.5" HD	<b>890-01070</b>
	13" HD	<b>890-01071</b>
Fit Sportster Models '91-17 FXR '82-94	12.5" STD	<b>890-01040</b>
	13" STD	<b>890-01041</b>
	12.5" HD	<b>890-01042</b>
	13" HD	<b>890-01043</b>
<b>PRELOAD/REBOUND ADJUSTABLE</b>		
Fit Touring Models '84-17	12" STD	<b>890-01010</b>
	13" STD	<b>890-01011</b>
	12" HD	<b>890-01012</b>
	13" HD	<b>890-01013</b>
Fit Dyna Models '91-17	12.5" STD	<b>890-01005</b>
	13" STD	<b>890-01006</b>
	12.5" HD	<b>890-01072</b>
	13" HD	<b>890-01073</b>
Fit Sportster Models '91-17 FXR '82-94	12.5" STD	<b>890-01044</b>
	13" STD	<b>890-01045</b>
	12.5" HD	<b>890-01046</b>
	13" HD	<b>890-01047</b>
<b>REPLACEMENT SPRINGS</b>		
Fit Bazooka Series Touring Shocks	12" STD	<b>890-01034</b>
	12" HD	<b>890-01035</b>
	13" STD	<b>890-01036</b>
	13" HD	<b>890-01037</b>
Fit Bazooka Series Dyna Shocks	12.5" HD	<b>890-01055</b>
	13" HD	<b>890-01054</b>
Replacement Bushings and Sleeves	All Shocks	<b>890-01060</b>

- WINDSHIELDS / FAIRINGS
- AUDIO / COMMUNICATION
- SEATS / LUGGAGE
- BARS / MIRRORS / CONTROLS
- EXHAUST
- AIR / FUEL SYSTEMS
- ENGINE
- TRANSMISSION / DRIVELINE
- GASKETS / SEALS
- ELECTRICAL
- LIGHTING
- CABLES
- BRAKES
- OIL FILTERS
- SUSPENSION**
- BODY
- WHEELS
- TIRES / TIRE ACC.
- BIKE ACC.
- VICTORY / INDIAN
- COVERS / LOCKS / TIEDOWNS
- CHEMICALS
- TOOLS
- HELMETS
- HELMET ACC.
- EYEWEAR
- APPAREL / RIDER ACC.
- PROMOTIONAL
- REFERENCE
- INDEX

- WINDSHIELDS / FAIRINGS
- AUDIO / COMMUNICATION
- SEATS / LUGGAGE
- BAR / MIRRORS / CONTROLS
- EXHAUST
- AIR / FUEL SYSTEMS
- ENGINE
- TRANSMISSION / DRIVELINE
- GASKETS / SEALS
- ELECTRICAL
- LIGHTING
- CABLES
- BRAKES
- OIL FILTERS
- SUSPENSION**
- BODY
- WHEELS
- TIRES / TIRE ACC.
- BIKE ACC.
- VICTORY / INDIAN
- COVERS / LOCKS / TIEDOWNS
- CHEMICALS
- TOOLS
- HELMETS
- HELMET ACC.
- EYEWEAR
- APPAREL / RIDER ACC.
- PROMOTIONAL
- REFERENCE
- INDEX

**HardDrive**  
AMERICAN V-TWIN PRODUCTS



BY *racinbros*

## REMOTE RESERVOIR REAR SHOCKS

HardDrive remote reservoir rear shocks by RacingBros' feature full adjustability with preload, compression and rebound adjusters to easily adapt to all riding styles and conditions. Whether you choose stock 12.5" length for your Dyna or Sportster, or you want the tall 14" curb hopper club style look, these performance shocks with race proven "Speed Adaptive Valving" will provide you with the ultimate ride.

- Speed Adaptive Valving (SAV)
- Internal floating piston design for consistent performance
- Components made from A7075 forged aluminum then precision CNC machined
- Progressive rate springs with tapered ends to avoid bowing and bottoming
- '04-13 Sportsters may require relocation of rear master cylinder with 14" shocks



Application	Description	WPS#
Fit Dyna Models '91-Up (except FXDF)	12.5"	<b>890-01001</b>
	14" STD	<b>890-01002</b>
	14" HD	<b>890-01007</b>
Fit Sportster Models '91-Up FXR '84-94	12.5" STD	<b>890-01048</b>
	13" STD	<b>890-01052</b>
	14" STD	<b>890-01049</b>
	12.5" HD	<b>890-01050</b>
	13" HD	<b>890-01053</b>
	14" HD	<b>890-01051</b>

### REPLACEMENT SPRINGS

Fits Dyna 14" STD	<b>890-01036</b>
Fits Dyna 14" HVY	<b>890-01037</b>
Fits Dyna 13" STD	<b>890-01038</b>
Fits Dyna 12.5" STD	<b>890-01039</b>
Fits Sportster 13" and 14" HVY	<b>890-01036</b>
Fits Sportster 13" and 14" STD	<b>890-01065</b>
Replacement Bushings and Sleeves	All Shocks <b>890-01060</b>

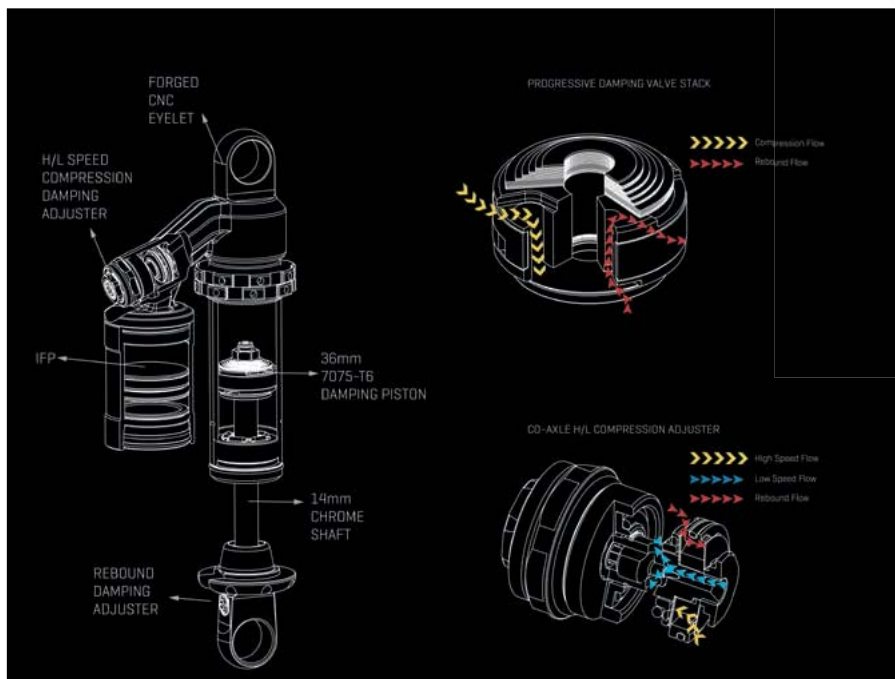





### SHORT SHOCKS

Give your bike that extreme low look with these 10.5" lowering shocks. Preload adjustable and available in chrome or gloss black finish. Check all clearances after installation. Sold in pairs.

Application	Description	Chrome	Black
Fits XL Models '91-17 and '87-94 FXR Models	10.5" Lowering Shocks	<b>890-01100</b>	<b>890-01101</b>

### 4-SPEED SHOCKS

Chrome replacement shocks for most 4-speed Big Twins and Sportsters, some available with or without full cover shroud.



Application	Description	WPS#
Fit Big Twins '73-86	Chrome 12" Shocks w/Short Cover	<b>820-52703</b>
	Chrome 12" Shocks w/Full Cover	<b>820-52704</b>
	Chrome 11" Shocks w/Short Cover	<b>820-52705</b>
	Chrome 11" Shocks w/Full Cover	<b>820-52706</b>
Fit FL Models '58-72 and XL Models '54-74	Chrome 13.5" Shocks w/Short Cover	<b>820-52701</b>
	Chrome 13.5" Shocks w/Full Cover	<b>820-52702</b>
Fit XL Models '54-78	Chrome 14.5" Shocks	<b>820-52700</b>

- WINDSHIELDS / FAIRINGS
- AUDIO / COMMUNICATION
- SEATS / LUGGAGE
- BAR / MIRRORS / CONTROLS
- EXHAUST
- AIR / FUEL SYSTEMS
- ENGINE
- TRANSMISSION / DRIVELINE
- GASKETS / SEALS
- ELECTRICAL
- LIGHTING
- CABLES
- BRAKES
- OIL FILTERS
- SUSPENSION**
- BODY
- WHEELS
- TIRES / TIRE ACC.
- BIKE ACC.
- VICTORY / INDIAN
- COVERS / LOCKS / TIEDOWNS
- CHEMICALS
- TOOLS
- HELMETS
- HELMET ACC.
- EYEWEAR
- APPAREL / RIDER ACC.
- PROMOTIONAL
- REFERENCE
- INDEX



## SOFTAIL SHOCKS

Chrome replacement OEM style shocks for Softail models from '89-up. The earlier '89-99 versions feature height and preload adjustability.



Application	WPS#
Fit Softails '89-99	<b>820-52707</b>
Fit Softails '00-17	<b>820-52708</b>

## SOFTAIL LOWERING KIT

- Easily lowers your Softail up to 2"
- Adjustable to allow lowering between 0" and 2"
- Fits most Softails from 2000-2015 (except FXCW/FXCWC, FLSTFB, FLSTSB, FLSTN, FXSTD, FXS, FXSB, and FLS or models with profile lowering kits)



Application	Year	WPS#
Softail	'00-up	<b>820-1747</b>



## SOFTAIL LOWERING KIT

- Adjustable lowering kit permits easy ride height control
- Includes all necessary hardware
- Installation should be performed by a certified mechanic



Application	Year	WPS#
Softail	'89-99	<b>830-0200</b>



## SHOCK MOUNTING KIT



- Chrome plated mounting hardware
- Give your bike that custom look

Application	WPS#
<b>SHOCK MOUNTING KIT</b>	
A For '84-99 Softail	<b>830-1162</b>
B For 2004-UP Sportster	<b>830-1148</b>
C For '00-13 Sportster	<b>830-1149</b>
D For '91-01 Dyna	<b>830-1203</b>
E For '02-05 Dyna	<b>830-1169</b>



B

C

E



Paul Yaffé's  
**Bagger  
Nation**



**FRONT END KIT**

Big wheel bikes are all about balance. Our geometry provides the perfect look you crave with the added performance you never knew existed. Our kits provide perfect trail and there is no decrease in suspension travel and no increase in spring pre-load. In short, a Cadillac ride & a bitchin' look! Get ready to be blown away



**SRT BUILDERS KIT COMPONENTS**



Have your favorite wheel style created by your company of choice. Shinko SRT 777 front tire sold separately (Part# 87-4200).

Made from billet steel to provide precision and increased strength, makes easy work out of raking your frame

Ensures correct rake and trail measurements that provide unparalleled performance and handling

Spacers included

Choose from four different styles



Description	Black	Chrome
Kit w/Domino Yaxle Caps	<b>834-02000</b>	<b>834-02001</b>
Kit w/Speed Freak Yaxle Caps	<b>834-02002</b>	<b>834-02003</b>
Kit w/Smooth Yaxle Caps	<b>834-02004</b>	<b>834-02005</b>
Kit w/Yafterburner Yaxle Caps	<b>834-02006</b>	<b>834-02007</b>

- WINDSHIELDS / FAIRINGS
- AUDIO / COMMUNICATION
- SEATS / LUGGAGE
- BAR / MIRRORS / CONTROLS
- EXHAUST
- AIR / FUEL SYSTEMS
- ENGINE
- TRANSMISSION / DRIVELINE
- GASKETS / SEALS
- ELECTRICAL
- LIGHTING
- CABLES
- BRAKES
- OIL FILTERS
- SUSPENSION**
- BODY
- WHEELS
- TIRES / TIRE ACC.
- BIKE ACC.
- VICTORY / INDIAN
- COVERS / LOCKS / TIEDOWNS
- CHEMICALS
- TOOLS
- HELMETS
- HELMET ACC.
- EYEWEAR
- APPAREL / RIDER ACC.
- PROMOTIONAL
- REFERENCE
- INDEX



## BOLT ON RAKE KITS

“STOP” Do not cut your stock frame any longer. Because EZ-ON Rake Kits are a bolt on application, you simply remove your existing parts and bolt on our kit.

You can do all of this with your own basic tool kit. These kits provide precision alignment, great cornering stability along with high quality parts while maintaining stock linked ABS function. With the included wheel bearing installed there is no need for an expensive calibration unit.

Every single bolt included in the EZ-ON kit is made of SAE 4140 high strength steel and the main frame is made of 6061 T-6 aluminum.

The EZ-ON kit maintains stock steel ABS brake lines simply by using a unique bracket. The kit retains stock ground clearance and handling characteristics with built in fork extensions. Built in preload adjusters eliminate the need to disassemble the forks. Neck bearings can be adjusted via an external nut underneath the tree to optimize steering characteristics.



EZ-On Neck Rake Kit



Chin Spoilers



Headlight Bezels



Description	Application/Year	WPS#
EZ-On Neck Rake Kit for 26" Wheel	Touring Models '14-Up	<b>811-40007</b>
	Touring Models '09-13	<b>811-40002</b>
	Touring Models '97-08	<b>811-40004</b>
EZ-On Neck Rake Kit for 30" Wheel	Touring Models '14-Up	<b>811-40001</b>
	Touring Models '09-13	<b>811-40003</b>
	Touring Models '97-08	<b>811-40005</b>
EZ-On Neck Rake Kit for 23" Wheel	Touring Models '14-Up	<b>811-40009</b>
	Touring Models '09-13	<b>811-40006</b>
Fairing Mount	FLTR '14-Up 30" Wheel	<b>811-40010</b>
	FLTR '14-Up 23-26" Wheel	<b>811-40011</b>
	FLTR '09-13	<b>811-40012</b>
Steel Chin Spoiler	Touring Models '09-Up	<b>811-40040</b>
Hand Made Chin Spoiler	Touring Models '09-Up	<b>811-40045</b>
Raked Headlight Bezel Chrome	Touring Models '96-Up	<b>811-40041</b>
Raked Headlight Bezel Black		<b>811-40042</b>
MC Baggers ABS Wheel Bearing 21"	Touring Models '08-Up	<b>811-40021</b>
MC Baggers ABS Wheel Bearing 23"		<b>811-40023</b>
MC Baggers ABS Wheel Bearing 26"		<b>811-40026</b>
MC Baggers ABS Wheel Bearing 30"		<b>811-40030</b>





## FORK STOP KITS



"Hourglass" style kit is used in necks that are 7" long. Used on later stock Harley-Davidson frames and many aftermarket custom frames. Fits all Pro-One Triple Trees and other brands with 4 pre-drilled holes. On brands without the necessary holes, kit can still be installed by drilling and tapping 4 holes. Easy to follow instructions included. Bearing Race fits 1.990" neck bore. Measure the neck bore where the races install in the neck, or the length of the neck to be sure this is the kit you need.

Press-in bearing cup style kit is used on many older Harley-Davidson frames and many custom aftermarket frames. Designed for necks that are 5-11/16" long (not including the cups). Includes Polished Stainless Steel bearing cups. Easy to follow instructions included. Bearing cups fit 1.325" neck bore. Measure the neck bore where the external neck cups install in the neck, or the length of the neck to be sure this is the kit you need.

Description	Application	WPS#
Fork Stop Kit	"Hourglass" style necks, OEM Frames	<b>812-02015</b>
Replacement Race w/Stop	For Kit 812-02015	<b>812-02017</b>
Fork Stop Kit	Intrenal Kit w/Press in Bearing Cups	<b>812-02016</b>
	Universal External Bolt-On Style	<b>812-02018</b>

## 39MM TRIPLE TREES

- CNC Machined 6061 aluminum
- Raw, black & polished options
- Fits 39mm front ends
- 8" Center to center width, sturdy 1.5" thick material
- Made in the USA



Description	Finish	WPS#
Grooved 39mm Triple Trees	Raw	<b>825-02260</b>
	Black	<b>825-02261</b>
	Polished	<b>825-02262</b>

- WINDSHIELDS / FAIRINGS
- AUDIO / COMMUNICATION
- SEATS / LUGGAGE
- BAR / MIRRORS / CONTROLS
- EXHAUST
- AIR / FUEL SYSTEMS
- ENGINE
- TRANSMISSION / DRIVELINE
- GASKETS / SEALS
- ELECTRICAL
- LIGHTING
- CABLES
- BRAKES
- OIL FILTERS
- SUSPENSION**
- BODY
- WHEELS
- TIRES / TIRE ACC.
- BIKE ACC.
- VICTORY / INDIAN
- COVERS / LOCKS / TIEDOWNS
- CHEMICALS
- TOOLS
- HELMETS
- HELMET ACC.
- EYEWEAR
- APPAREL / RIDER ACC.
- PROMOTIONAL
- REFERENCE
- INDEX



**PROGRESSIVELY WOUND FORK SPRING KITS**



**MULTIRATE FORK SPRING KITS**

Our Multirate fork springs are produced from the best spring materials available. They are precision wound and stress relieved and mechanically polished to increase surface density to improve corrosion resistance. Straight rate springs have the same rate every inch that they are compressed, which is fine on flat super smooth roads but they lack the ability of our Multirate fork springs to handle some of the more unpredictable road conditions without sacrificing ride quality. If you have a heavier bike or increased load, try our new "GENISIS SERIES" fork springs.

**MULTIRATE LOWERING KITS**

The Multirate lowering kits are engineered to lower the front end of your bike 1 to 2 inches and still preserve ride quality. The lowering springs undergo the same thorough process as the Multirate fork springs. The kit comes with two specially designed Multirate fork springs, washers, aluminum spacer, two lowering springs and instructions

Application	Year	Stock Height	Lowered
<b>TOURING</b>			
FLH/FLT (except Trike)	'14-16	015-01005	015-01013
	'06-13	015-01003	015-01012
	'49-01	015-01003	015-01012
FLHR	'02-05	015-01003	015-01012
<b>SOFTAIL</b>			
FLST/FXST All models	'84-16	015-01003	015-01012
FXSB	'13-16	015-01005	015-01013
FXCW/C	'08-11	015-01005	-
<b>DYNA/FXR</b>			
FXD models	'06-16	015-01005	015-01013
FXDL	'93-05	015-01004	015-01011
FXDS/Conv.	'94-00	015-01004	015-01011
FXDWG	'93-05	015-01003	015-01012
FXDX/T	'00-05	015-01002	-
FXDX	'99	015-01004	015-01011
FXD/B/C	'95-05	015-01004	015-01011
	'91-92	015-01004	015-01011
FXLR	'87-94	015-01004	015-01011
FXR/FXRS	'88-94	015-01004	015-01011
	'82-87	015-01001	015-01010
FXR-SP/Conv.	'87-94	015-01004	015-01011
FXRT	'88-92	015-01004	015-01011
	'83-87	015-01001	015-01010
FXWG	'80-86	015-01003	015-01012
FX	'71-86	015-01001	015-01010
<b>SPORTSTER</b>			
All XL models	'88-16	015-01004	015-01011
	'84-87	015-01001	015-01010
	'53-83	015-01001	-
XR1000	'83-84	015-01001	-
<b>STREET</b>			
XG500/750	'15-16	015-01004	015-01011
<b>V-ROD</b>			
VRSCDX	'07-11	015-01005	015-01014
VRSCAW	'09-10	015-01005	015-01014
VRSC/A/AW/D/X	'07-08	015-01005	015-01014
VRSA/B/D	'02-06	015-01005	015-01014



# GENESIS SERIES FORK SPRING KITS



## STOCK HEIGHT KITS

The innovative Genesis Series dual spring set up contains a specially designed Multirate outer spring and a one of a kind Genesis inner spring that are assembled together to make the Genesis Series. The Genesis Series works great whether you ride alone or with a passenger, by putting the Genesis spring inside the outer fork spring it allows the springs to work together instead of against each other. The inner fork spring is there when you need it for hard braking and extreme riding conditions of any kind, making them almost impossible to bottom. Each standard Genesis Series kit comes with two Genesis series fork springs (preassembled), 4 Genesis washers, aluminum spacer and instructions.

## LOWERED KITS

We use the dual spring combination of the Genesis Series springs and our polished lowering springs to give you what we consider as one of the best front end lowering kits available today. By using the Genesis Series fork springs we are able to give you a comfortable ride without worrying about bottoming out because the Genesis inner spring is there to give you that extra power when you need it.



Application	Year	Stock Height	Lowered
<b>TOURING</b>			
FLH/FLT (except Trike)	'14-16	015-01025	015-01033
	'06-13	015-01023	015-01032
	'49-01	015-01022	015-01031
FLHR	'05	015-01024	015-01031
	'02-04	015-01022	015-01031
<b>SOFTAIL</b>			
FLST/FXST All models	'84-16	015-01022	015-01031
FXSB	'13-16	015-01025	015-01033
FXCW/C	'08-11	015-01026	-
<b>DYNA/FXR</b>			
FXD models	'06-16	015-01025	015-01033
FXDL	'93-05	015-01021	015-01030
FXDS/Conv.	'94-00	015-01021	015-01030
FXDWG	'93-05	015-01022	015-01031
FXDX	'99	015-01021	015-01030
FXD/B/C	'95-05	015-01021	015-01030
	'91-92	015-01021	015-01030
FXLR	'87-94	015-01021	015-01030
FXR/FXRS	'88-94	015-01021	015-01030
FXR-SP/Conv.	'87-94	015-01021	015-01030
FXRT	'88-92	015-01021	015-01030
FXWG	'80-86	015-01022	015-01031
<b>SPORTSTER</b>			
All XL models	'04-16	015-01021	015-01030
	'88-03	015-01021	015-01030
<b>STREET</b>			
XG500/750	'15-16	015-01021	015-01030
<b>V-ROD</b>			
VRSCDX	'07-11	015-01025	015-01034
VRSCAW	'09-10	015-01025	015-01034
VRSC/A/AW/D/X	'07-08	015-01025	015-01034
VRSA/B/D	'02-06	015-01025	015-01034
<b>OVERLENGTH SPRING KITS</b>			
Fits 39mm Front Ends, 18.5" Spring Length		015-01050	
Fits 41mm Front Ends, 18" Spring Length		015-01051	
Fits 41mm Front Ends, 20" Spring Length		015-01052	
Fits 49mm Front Ends, 20" Spring Length		015-01053	

- WINDSHIELDS / FAIRINGS
- AUDIO / COMMUNICATION
- SEATS / LUGGAGE
- BAR / MIRRORS / CONTROLS
- EXHAUST
- AIR / FUEL SYSTEMS
- ENGINE
- TRANSMISSION / DRIVELINE
- GASKETS / SEALS
- ELECTRICAL
- LIGHTING
- CABLES
- BRAKES
- OIL FILTERS
- SUSPENSION**
- BODY
- WHEELS
- TIRES / TIRE ACC.
- BIKE ACC.
- VICTORY / INDIAN
- COVERS / LOCKS / TIEDOWNS
- CHEMICALS
- TOOLS
- HELMETS
- HELMET ACC.
- EYEWEAR
- APPAREL / RIDER ACC.
- PROMOTIONAL
- REFERENCE
- INDEX



# GOLD VALVE EMULATORS FOR H-D FORKS

H-D Damping Rod Style Forks are notorious for being both too harsh and too mushy. Gold Valve Cartridge Emulators remedy this problem by controlling the motion with a tunable valve that sits on top of the damping rod. They are held in place by the main fork springs. Simply put; Emulators make damping rod forks perform like well-tuned cartridge forks.

- Increased tune-ability
- Dual stage tune-ability
- Personalized setup
- Reduced harshness
- Increased bottoming resistance
- Improved traction
- Consistent feel
- Technical support
- 100% Guaranteed
- Made in the USA

Application	Description	WPS#
'14-16 Touring models (except Trike)	49mm forks	<b>200-S4901</b>
'69-01 Touring models, '94-05 FLHR, '06-13 Touring models	41mm forks	<b>200-S3802</b>
'84-15 Softail models (except FLS, FXCW, and Springer models)	41mm forks	<b>200-S3802</b>
'06-15 Dyna models (except FXDWG and FLD)	49mm forks	<b>200-S4901</b>
'87-05 Dyna models (except FXDWG)	39mm forks	<b>200-S3501</b>
'13-15 Dyna Wide Glide FXDWG	49mm forks	<b>200-S4901</b>
'93-12 Dyna Wide Glide FXDWG	41mm forks	<b>200-S3802</b>
'87-94, '99 FXR models (except '83-92 FXRT)	39mm forks	<b>200-S3501</b>
'88-15 XL models (does not fit XR1200)	39mm forks	<b>200-S3501</b>
'02-11 VRSC models (except Street Rod)	49mm forks	<b>200-S4901</b>



## FORK SPRING KIT

- RT Fork Suspension/Lowering Kits are designed to improve the ride, comfort and handling of your bike
- The kits allow the suspension to be customized for the rider
- They include a set of Gold Valve Cartridge Emulators, a pair of Hi-Performance Springs and Lowering Hardware
- The Lowering Hardware allows the option to lower the front end 1"-2"
- Lowering is not required and is recommended for show models only



Application	Year	Spring Rate	WPS#
<b>TOURING</b>			
All models (except Trike)	'14-16	.95kg	<b>200-49095</b>
		1.0kg	<b>200-49100</b>
		1.10kg	<b>200-49110</b>
		1.20kg	<b>200-49120</b>
		1.30kg	<b>200-49130</b>
		1.40kg	<b>200-49140</b>
All models (except Trike and models listed below)	'69-13	1.50kg	<b>200-49150</b>
		.80kg	<b>200-3880</b>
		.85kg	<b>200-3885</b>
		.90kg	<b>200-3890</b>
		.95kg	<b>200-3895</b>
FLHT and FLTR models	'02-05	1.0kg	<b>200-3810</b>
		.80kg	<b>200-41080</b>
		.85kg	<b>200-41085</b>
		.90kg	<b>200-41090</b>
		.95kg	<b>200-41095</b>
All models (except FLS, FXCW, Springer models)	'84-15	1.0kg	<b>200-41100</b>
		.80kg	<b>200-3880</b>
		.85kg	<b>200-3885</b>
		.90kg	<b>200-3890</b>
		.95kg	<b>200-3895</b>
		1.0kg	<b>200-3810</b>
<b>SOFTAIL</b>			

Application	Year	Spring Rate	WPS#
<b>DYNA/FXR</b>			
FLD Switchback	'12-13	.80kg	<b>200-41080</b>
		.85kg	<b>200-41085</b>
		.90kg	<b>200-41090</b>
		.95kg	<b>200-41095</b>
		1.0kg	<b>200-41100</b>
FXD models and FXDWG	'13-15	.95kg	<b>200-49095</b>
		1.0kg	<b>200-49100</b>
		1.10kg	<b>200-49110</b>
		1.20kg	<b>200-49120</b>
		1.30kg	<b>200-49130</b>
FXD models (except listed below)	'87-05	1.40kg	<b>200-49140</b>
		1.50kg	<b>200-49150</b>
		.80kg	<b>200-3580</b>
		.85kg	<b>200-3585</b>
		.90kg	<b>200-3590</b>
FXDWG	'93-12	.95kg	<b>200-3595</b>
		.80kg	<b>200-3880</b>
		.85kg	<b>200-3885</b>
		.90kg	<b>200-3890</b>
		.95kg	<b>200-3895</b>
FXR models (except FXRT)	'87-94, '99	1.0kg	<b>200-3810</b>
		.80kg	<b>200-3580</b>
		.85kg	<b>200-3585</b>
		.90kg	<b>200-3590</b>
		.95kg	<b>200-3595</b>
<b>SPORTSTER MODELS</b>			
All models except (XR1200, XL1200V, and XL1200S)	'88-12	.80kg	<b>200-3580</b>
		.85kg	<b>200-3585</b>
		.90kg	<b>200-3590</b>
		.95kg	<b>200-3595</b>



# HI-PERFORMANCE FORK SPRINGS



- High quality
- These springs are made from chrome silicon wire
- High stiffness to mass ratio
- Shot-peened and heat treated for durability
- These are the finest springs available!
- Accurate Rates
- No Sacking-Out

Application	Description	WPS#
'82-86 FXR models (except FXRT), '77-85 XL models (35MM)	RT FORK SPR 23.5x410MM .85KG	<b>200-2341085</b>
'82-86 FXR models (except FXRT), '77-85 XL models (35MM)	RT FORK SPR 23.5x410MM .90KG	<b>200-2341090</b>
'82-86 FXR models (except FXRT), '77-85 XL models (35MM)	RT FORK SPR 24.1x410MM 1.0KG	<b>200-2341100</b>
'87-94 FXR, '93-05 Dyna models (except FXDWG) '88-15 XL models (39MM)	RT FORK SPR 29.0x377MM .80KG	<b>200-2938080</b>
'87-94 FXR, '93-05 Dyna models (except FXDWG) '88-15 XL models (39MM)	RT FORK SPR 29.0x377MM .85KG	<b>200-2938085</b>
'87-94 FXR, '93-05 Dyna models (except FXDWG) '88-15 XL models (39MM)	RT FORK SPR 29.0x377MM .90KG	<b>200-2938090</b>
'69-13 Touring models (except Trike), '84-16 Softail models (except FXCW, and Springers) '93-09 FXDWG, '12-16 FLD (41MM)	RT FORK SPR 31.7x340 .80KG	<b>200-3234080</b>
'69-13 Touring models (except Trike), '84-16 Softail models (except FXCW, and Springers) '93-09 FXDWG, '12-16 FLD (41MM)	RT FORK SPR 31.7x340 .85KG	<b>200-3234085</b>
'69-13 Touring models (except Trike), '84-16 Softail models (except FXCW, and Springers) '93-09 FXDWG, '12-16 FLD (41MM)	RT FORK SPR 31.7x340 .90KG	<b>200-3234090</b>
'69-13 Touring models (except Trike), '84-16 Softail models (except FXCW, and Springers) '93-09 FXDWG, '12-16 FLD (41MM)	RT FORK SPR 31.7x340 .95KG	<b>200-3234095</b>
'69-13 Touring models (except Trike), '84-16 Softail models (except FXCW, and Springers) '93-09 FXDWG, '12-16 FLD (41MM)	RT FORK SPR 31.7x340 1.0KG	<b>200-3234100</b>
'14-16 Touring models (except Trike), '08-11 FXCW/C, '06-16 Dyna models (except FXDWG), '10-16 FXDWG, '02-10 VRSC (49MM)	RT FORK SPR 43.5x300 .90KG	<b>200-4430090</b>
'14-16 Touring models (except Trike), '08-11 FXCW/C, '06-16 Dyna models (except FXDWG), '10-16 FXDWG, '02-10 VRSC (49MM)	RT FORK SPR 43.5x300 .95KG	<b>200-4430095</b>
'14-16 Touring models (except Trike), '08-11 FXCW/C, '06-16 Dyna models (except FXDWG), '10-16 FXDWG, '02-10 VRSC (49MM)	RT FORK SPR 43.5x300 1.0KG	<b>200-4430100</b>
'14-16 Touring models (except Trike), '08-11 FXCW/C, '06-16 Dyna models (except FXDWG), '10-16 FXDWG, '02-10 VRSC (49MM)	RT FORK SPR 43.5x300 1.10KG	<b>200-4430110</b>
'14-16 Touring models (except Trike), '08-11 FXCW/C, '06-16 Dyna models (except FXDWG), '10-16 FXDWG, '02-10 VRSC (49MM)	RT FORK SPR 43.5x300 1.30KG	<b>200-4430130</b>
'14-16 Touring models (except Trike), '08-11 FXCW/C, '06-16 Dyna models (except FXDWG), '10-16 FXDWG, '02-10 VRSC (49MM)	RT FORK SPR 43.5x300 1.50KG	<b>200-4430150</b>
'10-16 Vrod Models, '10-12 XR1200/X (inverted forks)	RT FORK SPR 38.2x36x273 .85KG	<b>200-3827085</b>
'10-16 Vrod Models, '10-12 XR1200/X (inverted forks)	RT FORK SPR 38.2x36x273 .90KG	<b>200-3827090</b>
'10-16 Vrod Models, '10-12 XR1200/X (inverted forks)	RT FORK SPR 38.2x36x273 .95KG	<b>200-3827095</b>
'10-16 Vrod Models, '10-12 XR1200/X (inverted forks)	RT FORK SPR 38.2x36x273 1.0KG	<b>200-3827100</b>

- WINDSHIELDS / FAIRINGS
- AUDIO / COMMUNICATION
- SEATS / LUGGAGE
- BAR / MIRRORS / CONTROLS
- EXHAUST
- AIR / FUEL SYSTEMS
- ENGINE
- TRANSMISSION / DRIVELINE
- GASKETS / SEALS
- ELECTRICAL
- LIGHTING
- CABLES
- BRAKES
- OIL FILTERS
- SUSPENSION**
- BODY
- WHEELS
- TIRES / TIRE ACC.
- BIKE ACC.
- VICTORY / INDIAN
- COVERS / LOCKS / TIEDOWNS
- CHEMICALS
- TOOLS
- HELMETS
- HELMET ACC.
- EYEWEAR
- APPAREL / RIDER ACC.
- PROMOTIONAL
- REFERENCE
- INDEX

**HardDrive** **FORK TUBES**  
AMERICAN V-TWIN PRODUCTS

- Hard Chrome fork tubes and assemblies (sold in pairs)
- Available with or without internals (damper, springs and caps)
- Lengths listed for OE reference may not be exact OE length depending on model and year
- Lengths listed are overall lengths
- Please measure your tubes before ordering to ensure correct length is ordered

Description	Length (inches)	Tubes Only	Tube Assembly
<b>49MM FORK TUBES FLHT</b>			
STD Size	22 7/8"	<b>820-52316</b>	<b>820-52306</b>
	24 7/8"	<b>820-52317</b>	<b>820-52307</b>
	26 7/8"	<b>820-52318</b>	<b>820-52308</b>
<b>49MM FORK TUBES FXDF</b>			
STD Size	25 1/2"	<b>820-52313</b>	<b>820-52303</b>
	27 1/2"	<b>820-52314</b>	<b>820-52304</b>
	29 1/2"	<b>820-52315</b>	<b>820-52305</b>
<b>49MM FORK TUBES FXD</b>			
STD Size	25 1/2"	<b>820-52309</b>	<b>820-52300</b>
	27 1/2"	<b>820-52310</b>	<b>820-52301</b>
	29 1/2"	<b>820-52311</b>	<b>820-52302</b>
	31 1/2"	<b>820-52312</b>	-
<b>41MM FORK TUBES</b>			
STD Size for FLH/FLT	20 1/4"	<b>820-52345</b>	-
STD Size for FLST	22 7/8"	<b>820-52346</b>	<b>820-52347</b>
	22 1/4"	<b>820-52325</b>	-
STD Size for FXST/FXDWG	24 1/4"	<b>820-52326</b>	<b>820-52319</b>
	26 1/4"	<b>820-52327</b>	<b>820-52320</b>
	28 1/4"	<b>820-52328</b>	<b>820-52321</b>
	30 1/4"	<b>820-52329</b>	<b>820-52322</b>
	32 1/4"	<b>820-52330</b>	<b>820-52323</b>
	34 1/4"	-	<b>820-52324</b>
<b>39MM FORK TUBES '04-UP XL MODELS</b>			
	23"	<b>820-52331</b>	-
STD Size	25"	<b>820-52332</b>	-
	27"	<b>820-52333</b>	-
	29"	<b>820-52334</b>	-
	31"	<b>820-52335</b>	-
<b>35MM FORK TUBES '75-83 XL, '76-83 FX MODELS</b>			
	21 1/4"	<b>820-52336</b>	-
STD Size	23 1/4"	<b>820-52337</b>	-
	25 1/4"	<b>820-52338</b>	-
	27 1/4"	<b>820-52339</b>	-
	29 1/4"	<b>820-52340</b>	-
	31 1/4"	<b>820-52341</b>	-



**FORK SLIDER COVERS**

- Precision made from high grade steel
- Available in chrome or gloss black finish



Application	Chrome	Black
'14-Up Touring Models	<b>820-52370</b>	<b>820-52371</b>
+2	<b>820-52376</b>	<b>820-52377</b>
'84-13 Touring and '86-14 FLST Models	<b>820-52372</b>	<b>820-52373</b>
+2"	<b>820-52374</b>	<b>820-52375</b>
<b>BILLET FORK SLIDER COVERS</b>	<b>HOLE SHOT BLACK</b>	<b>TALON BLACK</b>
'14-Up Touring Models	<b>820-52378</b>	<b>820-52379</b>





### FORK COVERS

- Die cast aluminum fork tube covers mount between the stock upper and lower triple tree
- Available for 49mm front ends
- Come in raw cast or black powder coated finish
- Ribs can be polished or accented to add a custom touch

Application	Description	WPS#
49mm Front Ends	Bombshell Fork Tube Covers Raw	<b>866-05400</b>
	Bombshell Fork Tube Covers Black	<b>866-05401</b>



### FORK BOOT CAPS

- Give your bike a custom look
- All fork boot caps are Chrome



Application	WPS#
A '80-86 FXDWG and '84-Up FLST models	<b>820-2719</b>
B '49-77 FL and FLH w/ 1 5/8" glide fork '76-87 FX and XL w/ 35mm Showa fork	<b>820-2718</b> <b>820-2717</b>
C '73-76 FX and XL w/ 35mm Kayaba fork	<b>820-2716</b>

### FORK TUBE REBUILD KITS

- All hardware, seals and gaskets needed for a fork slider rebuild
- Fitments for most applications

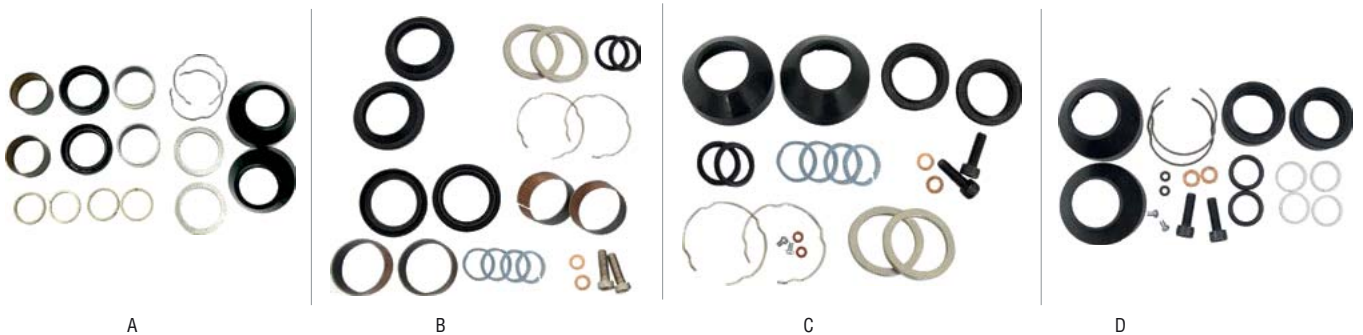

Description	WPS#
49mm forks	<b>820-2730</b>
49mm fork seals (10 Pack)	<b>820-2733</b>
A 41mm forks	<b>820-2710</b>
41 mm forks (basic kit, seals, bushings and clips only)	<b>820-2731</b>
41 mm fork seals (10 pack)	<b>820-2732</b>
B 39mm forks	<b>820-2711</b>
C 35mm forks 'L84-87 models	<b>820-2713</b>
D 35mm forks '75-E84 models	<b>820-2712</b>

- WINDSHIELDS / FAIRINGS
- AUDIO / COMMUNICATION
- SEATS / LUGGAGE
- BARS / MIRRORS / CONTROLS
- EXHAUST
- AIR / FUEL SYSTEMS
- ENGINE
- TRANSMISSION / DRIVELINE
- GASKETS / SEALS
- ELECTRICAL
- LIGHTING
- CABLES
- BRAKES
- OIL FILTERS
- SUSPENSION**
- BODY
- WHEELS
- TIRES / TIRE ACC.
- BIKE ACC.
- VICTORY / INDIAN
- COVERS / LOCKS / TIEDOWNS
- CHEMICALS
- TOOLS
- HELMETS
- HELMET ACC.
- EYEWEAR
- APPAREL / RIDER ACC.
- PROMOTIONAL
- REFERENCE
- INDEX



## FORK BOOTS

Besides offering a great nostalgic or custom look, fork boots protect your fork tubes from dirt and rubble thus prolonging fork seal life. Available for most models, sold in pairs.

	Description	Application	WPS#
A	Custom Fork Boot Short (7")	49mm Forks	<b>820-50310</b>
	Custom Fork Boot Long (9")	49mm Forks	<b>820-50311</b>
B	Custom 230mm Fork Boot Black (9")	41mm Forks	<b>820-50301</b>
C	Custom 230mm Fork Boot Red (9")	41mm Forks	<b>820-50302</b>
D	Fork Boot Sportster Iron 07-Up	39mm Forks	<b>820-50303</b>
E	Custom Fork Boot 175mm (7")	39mm Forks	<b>820-50305</b>
	Custom Fork Boot 190mm (7.5")	39mm Forks	<b>820-50306</b>
F	Fork Boot XL Models 54-70	35mm Forks	<b>820-50304</b>

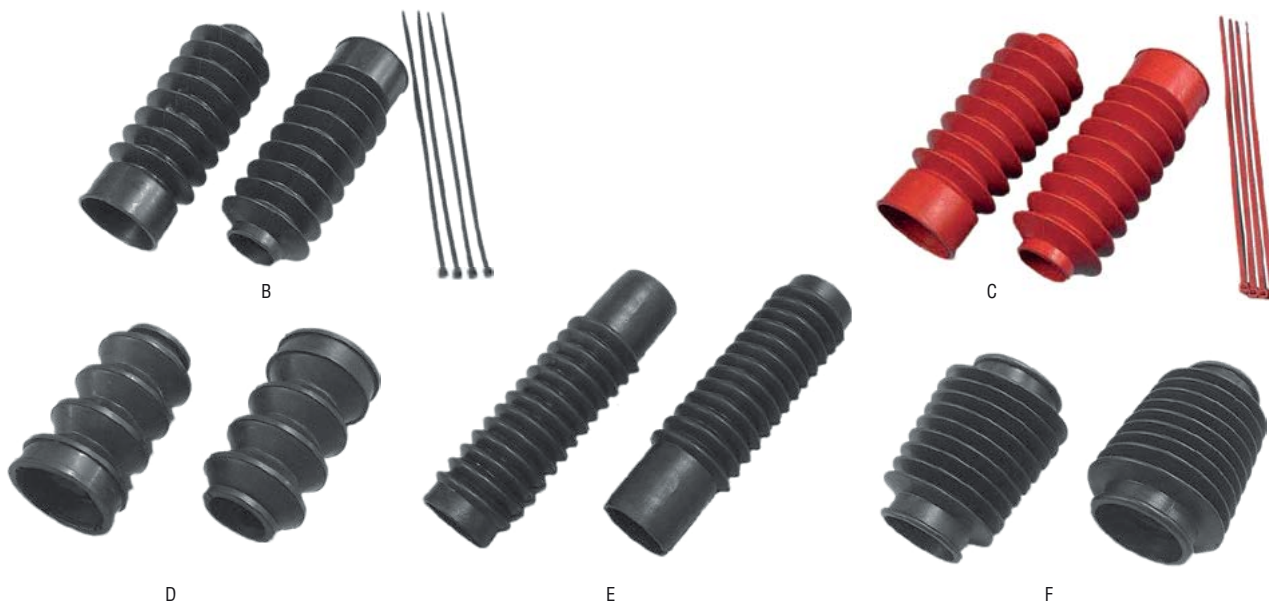

## FORK DUST BOOTS

- OEM replacement fork dust boots
- Protect fork seals from debris
- Available for early Showa and Kayaba forks

Description	Application	WPS#
<b>FORK DUST BOOTS</b>		
A	Kayaba Forks XL, FX OEM 45983-73	<b>820-50307</b>
B	Showa Forks XL, FX OEM 45404-75	<b>820-50308</b>
C	Wide Glide Forks FL, FLH	<b>820-50309</b>





## FORK / DUST SEAL KITS

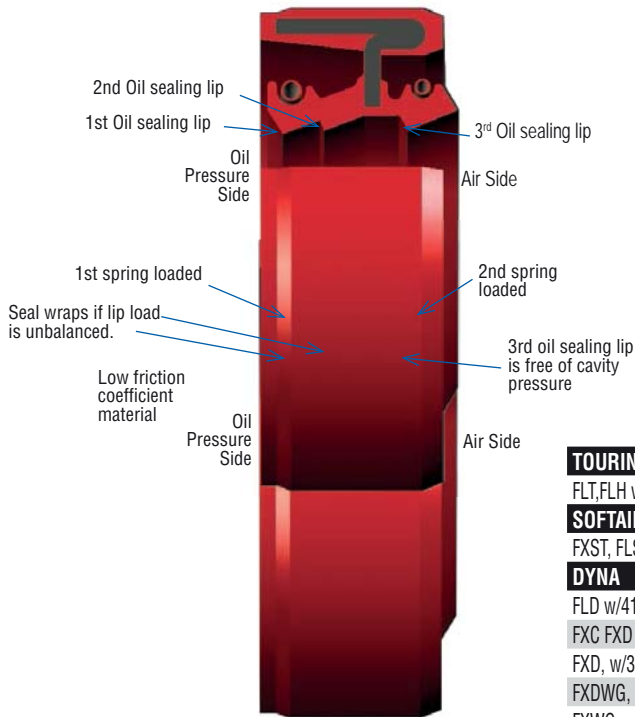

- Patented fork seal features a balanced 3 lip design that evenly distributes the pressure reducing operating temperature, wear and friction
- Custom Elastomer Fork Seals have been tested to outlast OEM fork seals. Extends typical seal life by 3 to 5 times over OEM seals
- Stiction (friction) measures from 1/3 to 1/2 less than OEM seals for smoother fork action
- Sold in pairs

Application	Year	Size	Fork Seal kit	Fork and Dust Seal kit
<b>TOURING</b>				
FLT,FLH w/41mm Showa forks	'84-16	41 x 54 x 11	<b>22-55119</b>	<b>22-56132</b>
<b>SOFTAIL</b>				
FXST, FLST, w/41mm Showa forks	'84-16	41 x 54 x 11	<b>22-55119</b>	<b>22-56132</b>
<b>DYNA</b>				
FLD w/41mm Showa forks	'12-16	41 x 54 x 11	<b>22-55119</b>	
FXC FXD w/49mm Showa forks	'08-16	49 x 60 x 11	<b>22-55129</b>	<b>22-56144</b>
FXD, w/39mm Showa forks	'91-05	39 x 52 x 11	<b>22-55113</b>	<b>22-56125</b>
FXDWG, w/41mm Showa forks	'93-05	41 x 54 x 11	<b>22-55119</b>	<b>22-56132</b>
FXWG, w/41mm Showa forks	'84-86	41 x 54 x 11	<b>22-55119</b>	<b>22-56132</b>
<b>FXR &amp; SPORTSTER</b>				
FXR & XL, w/39mm Showa forks	'87-16	39 x 52 x 11	<b>22-55113</b>	<b>22-56125</b>
XR1200 43mm	'08-09	43 x 54 x 11	<b>22-55120</b>	<b>22-56133</b>
<b>V-ROD</b>				
V-Rod w/ 49mm Showa forks	'02-16	49 x 60 x 11	<b>22-55129</b>	<b>22-56144</b>
VRSCF	'09-16	43 x 54 x 11	<b>22-55120</b>	<b>22-56133</b>

## FORK SEALS



### REFERENCE CHART

Size (ID x OD x W)	WPS #
<b>FORK SEAL KITS</b>	
35 x 48 x 11	<b>116-1020</b>
35 x 48 x 13	<b>116-1055</b>
39 x 52 x 11	<b>116-1035</b>
41 x 54 x 11	<b>116-1041</b>
41.3 x 54 x 13	<b>116-1056</b>

- High quality OEM replacement fork and dust seals
- Manufactured to factory specifications
- Packaged 1 pair per package



## FORK AND DUST SEALS APPLICATION CHART

Application	Year	Fork Seals
<b>TOURING</b>		
FL	'78-84	<b>116-1056</b>
FLT	'80-83	<b>116-1056</b>
All models (exc. '84 FL)	'84-16	<b>116-1041</b>
<b>SOFTAIL</b>		
All models	'84-16	<b>116-1041</b>
<b>DYNA/FXR</b>		
FXEF	'85	<b>116-1020</b>
FXR (exc. FXRS-SP & FXLR)	'84-87	<b>116-1020</b>
FXSB	'85	<b>116-1020</b>
Dyna Glide exc. FXDWGs	'91-05	<b>116-1035</b>
FXR	'88-94	<b>116-1035</b>
FXR2	'99	<b>116-1035</b>
FXRS-SP & FXLR	'87	<b>116-1035</b>
FXDWG	'93-05	<b>116-1041</b>
FXSB	'84	<b>116-1041</b>
FXD	'06-07	<b>116-1041</b>
FXWG	'85-86	<b>116-1041</b>

Application	Year	Fork Seals
<b>DYNA/FXR (CONT'D...)</b>		
FX-1200	'78	<b>116-1055</b>
FXB-80	'80-82	<b>116-1055</b>
FXDG	'83	<b>116-1055</b>
FXE	'81-83	<b>116-1055</b>
FXE 1200	'73-80	<b>116-1055</b>
FXEF	'79-80	<b>116-1055</b>
FXEF 80	'79-81	<b>116-1055</b>
FXS	'77-79	<b>116-1055</b>
FXS 80	'79-82	<b>116-1055</b>
FXSB	'83	<b>116-1055</b>
FXWG	'80-84	<b>116-1056</b>
<b>SPORTSTER</b>		
All models	'75-83	<b>116-1055</b>
All models	'84-87	<b>116-1020</b>
All models (except XR-1200)	'88-09	<b>116-1035</b>

- WINDSHIELDS / FAIRINGS
- AUDIO / COMMUNICATION
- SEATS / LUGGAGE
- BARS / MIRRORS / CONTROLS
- EXHAUST
- AIR / FUEL SYSTEMS
- ENGINE
- TRANSMISSION / DRIVELINE
- GASKETS / SEALS
- ELECTRICAL
- LIGHTING
- CABLES
- BRAKES
- OIL FILTERS
- SUSPENSION
- BODY
- WHEELS
- TIRES / TIRE ACC.
- BIKE ACC.
- VICTORY / INDIAN
- COVERS / LOCKS / TIEDOWNS
- CHEMICALS
- TOOLS
- HELMETS
- HELMET ACC.
- EYEWEAR
- APPAREL / RIDER ACC.
- PROMOTIONAL
- REFERENCE
- INDEX



## STEERING HEAD BEARINGS

- Applications to cover all the way back to 1949
- Comes with upper and lower bearings with races and lower seal
- All kits come with tapered roller bearings
- A performance upgrade for stock bikes that came with loose ball bearings



Application	Year	WPS#
<b>HARLEY DAVIDSON</b>		
Big Twin (except listed below)	'49-16	<b>22-2032</b>
FLH	'14-16	<b>22-1068</b>
Sportster	'82-16	<b>22-2032</b>
V-Rod	'02-16	<b>22-2032</b>



## BRASS FORK STEM NUT

Brass triple tree stem nut manufactured in Phoenix Arizona USA from solid 360 brass. Fits all Accutronix 0° raked triple trees, many other aftermarket triple trees, as well as stock trees for 71-85 FX, 82-87 FXR, 78-87 XL and also replaces the OEM # 45718-71 that are threaded 7/8"-24.



Description	WPS#
Brass Stem Nut	<b>811-20000</b>



## UPPER FORK BEARING ADJUSTMENT KIT **NEW**

- Cadmium Plated
- Reproduction of OEM

Application	WPS#
<b>UPPER FORK BEARING ADJUSTMENT KIT</b>	
For '84-09 Softail '91-05 FXDWG	<b>830-1168</b>



WINDSHIELDS / FAIRINGS  
AUDIO / COMMUNICATION  
SEATS / LUGGAGE  
BARS / MIRRORS / CONTROLS  
EXHAUST  
AIR / FUEL SYSTEMS  
ENGINE  
TRANSMISSION / DRIVELINE  
GASKETS / SEALS  
ELECTRICAL  
LIGHTING  
CABLES  
BRAKES  
OIL FILTERS  
**SUSPENSION**  
BODY  
WHEELS  
TIRES / TIRE ACC.  
BIKE ACC.  
VICTORY / INDIAN  
COVERS / LOCKS / TIEDOWNS  
CHEMICALS  
TOOLS  
HELMETS  
HELMET ACC.  
EYEWEAR  
APPAREL / RIDER ACC.  
PROMOTIONAL  
REFERENCE  
INDEX



## FORK STEM LOCK WASHERS

Application	WPS#
Fits FXST/FLST '84-Up and FL '60-84 (Repl. OEM 45717-63) 10pk	<b>820-53224</b>



## FORK STEM CAP / NUT

Application	WPS#
<b>FORK STEM BOLT</b>	
For '86-UP FLST FXR FXD XL (includes washer)	<b>830-1200</b>
For '86-UP FLST FXR FXD XL	<b>830-1202</b>
<b>FORK STEM CAP</b>	
For '80-UP FXST FXWG	<b>830-1129</b>
For '86-UP FLST FXR FXD XL	<b>830-1201</b>
<b>FORK STEM NUT</b>	
For '71-UP FX '79-UP XL w/Stock Trees	<b>830-1177</b>
For '49-59 Wide Glide	<b>830-1191</b>



## FORK TUBE BOLT / PLUG

Application	WPS#
<b>FORK TUBE BOLT</b>	
For FLT '84-01	<b>830-1164</b>
For '88-UP XL and FX	<b>830-1199</b>
For '78-UP Wideglide	<b>830-1184</b>
<b>FORK TUBE PLUG</b>	
For FLT '84-01	<b>830-1165</b>
For '78-UP Wideglide	<b>830-1188</b>
<b>FORK TUBE BOLT WASHERS</b>	
For '78-Up Big Twin OEM# 5710	<b>830-1198</b>

- WINDSHIELDS / FAIRINGS
- AUDIO / COMMUNICATION
- SEATS / LUGGAGE
- BAR / MIRRORS / CONTROLS
- EXHAUST
- AIR / FUEL SYSTEMS
- ENGINE
- TRANSMISSION / DRIVELINE
- GASKETS / SEALS
- ELECTRICAL
- LIGHTING
- CABLES
- BRAKES
- OIL FILTERS
- SUSPENSION**
- BODY
- WHEELS
- TIRES / TIRE ACC.
- BIKE ACC.
- VICTORY / INDIAN
- COVERS / LOCKS / TIEDOWNS
- CHEMICALS
- TOOLS
- HELMETS
- HELMET ACC.
- EYEWEAR
- APPAREL / RIDER ACC.
- PROMOTIONAL
- REFERENCE
- INDEX



STEERING DAMPERS



- Eliminate High Speed Wobble
- Allows Full Lock to Lock Turning
- Includes All Mounting Hardware and Mounts

Description	Application	Finish	WPS#
Steering Damper	00-08 FLT	Silver	820-52283
	09-13 FLT	Silver	820-52284
	14-16 FLT	Silver	820-52285
	91-05 FXD	Silver	820-52286
	91-05 FXD	Black	820-52287
	06-17 FXD	Silver	820-52288
	06-17 FXD	Black	820-52289



- WINDSHIELDS / FAIRINGS
- AUDIO / COMMUNICATION
- SEATS / LUGGAGE
- BAR / MIRRORS / CONTROLS
- EXHAUST
- AIR / FUEL SYSTEMS
- ENGINE
- TRANSMISSION / DRIVELINE
- GASKETS / SEALS
- ELECTRICAL
- LIGHTING
- CABLES
- BRAKES
- OIL FILTERS
- SUSPENSION**
- BODY
- WHEELS
- TIRES / TIRE ACC.
- BIKE ACC.
- VICTORY / INDIAN
- COVERS / LOCKS / TIEDOWNS
- CHEMICALS
- TOOLS
- HELMETS
- HELMET ACC.
- EYEWEAR
- APPAREL / RIDER ACC.
- PROMOTIONAL
- REFERENCE
- INDEX





## WIDE SPRINGER FORKS

These Springer fork assemblies come assembled and include the fork stem, top nut, crown nut, top clamp, outer springs, and the shock absorber (where applicable). They have 3° stem angles and are for use with 3/4" axles (sold separately).

Description	Application	WPS #
Wide Springer Forks	Stock Length Without Shock	<b>830-3950</b>
	Stock Length With Shock	<b>830-3951</b>
	+3 Length With Shock	<b>830-3952</b>
Springer Axles	No Brake	<b>830-3960</b>
	PM Brake	<b>830-3961</b>
	Stock Brake	<b>830-3962</b>

## SPRINGER FRONT END SPRINGS



- Patriot Suspension is proud to offer high quality stock replacement springs for Springer front ends
- Replace your tired and worn out Springer Springs!
- Quality Checked
- Exceptional mirror finish inside and out!
- Lifetime Warranty
- 100% Made in the U.S.A.

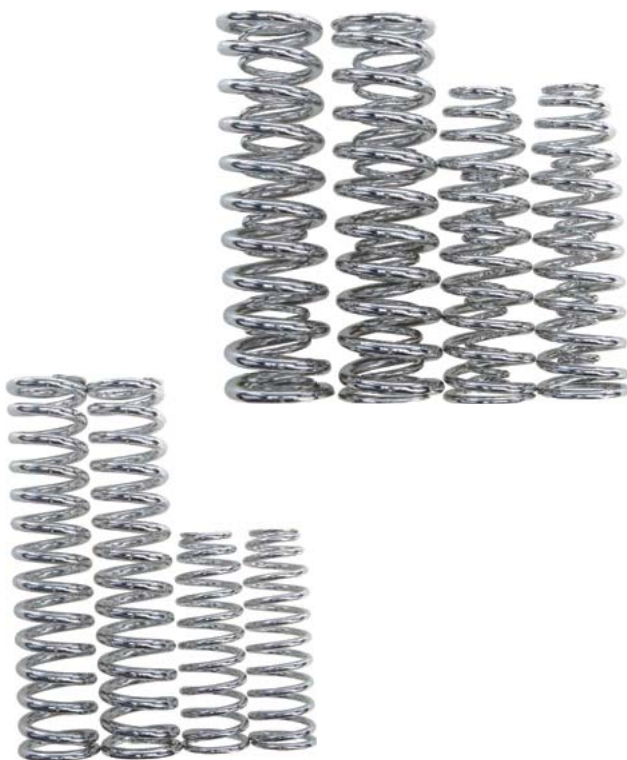

### 015-01040 includes:

- TOP SPRING (2 springs) 5 5/8" L 1 1/2" OD top 1.2" OD
- TOP SPRING INNER (2 springs) 4" L 1 1/2" OD
- BOTTOM SPRING (2 springs) 6 1/4" L 1 7/8" OD
- BOTTOM SPRING INNER (2 springs) 6 1/2" L 1 1/8" OD

### 015-01041 includes:

- TOP SPRING : 5" L 1 1/2" OD top 1.275" OD
- BOTTOM SPRING (with dead coils): 8 1/2" L with 1 7/8" OD

### 015-01042 includes:

- TOP SPRING 5" L 1 1/2" OD top 1.275" OD
- BOTTOM SPRING 8 1/2" L 1 7/8" OD

Application	WPS#
Stock H-D models w/ 74" and 45" Springer Ends and Paughco Springer front ends (non shock style)	<b>015-01040</b>
Shock style Springers	<b>015-01041</b>
Shock style Springers	<b>015-01042</b>

- WINDSHIELDS / FAIRINGS
- AUDIO / COMMUNICATION
- SEATS / LUGGAGE
- BAR / MIRRORS / CONTROLS
- EXHAUST
- AIR / FUEL SYSTEMS
- ENGINE
- TRANSMISSION / DRIVELINE
- GASKETS / SEALS
- ELECTRICAL
- LIGHTING
- CABLES
- BRAKES
- OIL FILTERS
- SUSPENSION
- BODY
- WHEELS
- TIRES / TIRE ACC.
- BIKE ACC.
- VICTORY / INDIAN
- COVERS / LOCKS / TIEDOWNS
- CHEMICALS
- TOOLS
- HELMETS
- HELMET ACC.
- EYEWEAR
- APPAREL / RIDER ACC.
- PROMOTIONAL
- REFERENCE
- INDEX



## 23" COMPOSITE FENDER

- Our front fenders perfectly follow the contour of your 23" inch front wheel
- Carbon composite fenders are constructed from a blend of composite materials with a layer of carbon fiber for fenders as strong as steel with less than half the weight.
- These fenders are an average of 8 lbs lighter than most similar steel fenders, saving weight and improving gas mileage.
- Ready to paint finish



Description	Application	WPS#
Carbon Composite Fender for 23" Wheels	'14-Up Touring Models	<b>820-80011</b>
	'87-13 Touring Models	<b>820-80010</b>

## FENDER ADAPTER BRACKETS

- Used to re-position the front fender on '14-Up FLT models to allow the use of a 21" front wheel
- Jig-drilled for the perfect fit and simple bolt-on installation
- Steel with a powder-coated finish
- Sold in pairs



Description	Application	WPS#
Fender Brackets for 21" Wheels	'14-Up Touring Models	<b>820-80005</b>



- WINDSHIELDS / FAIRINGS
- AUDIO / COMMUNICATION
- SEATS / LUGGAGE
- BARS / MIRRORS / CONTROLS
- EXHAUST
- AIR / FUEL SYSTEMS
- ENGINE
- TRANSMISSION / DRIVELINE
- GASKETS / SEALS
- ELECTRICAL
- LIGHTING
- CABLES
- BRAKES
- OIL FILTERS
- SUSPENSION
- BODY**
- WHEELS
- TIRES / TIRE ACC.
- BIKE ACC.
- VICTORY / INDIAN
- COVERS / LOCKS / TIEDOWNS
- CHEMICALS
- TOOLS
- HELMETS
- HELMET ACC.
- EYEWEAR
- APPAREL / RIDER ACC.
- PROMOTIONAL
- REFERENCE
- INDEX



### SMOOTH FENDER SPACERS 49MM

The 49mm FLH "SMOOTH" fender spacers have a 2-bolt pattern for a smoother custom look.

Description	Thickness	Chrome	Black
Fender Spacers	7/16"	811-20064	811-20067
	5/8"	811-20065	811-20068
	7/8"	811-20066	811-20069



### FENDER SPACERS 41MM

These FLH billet fender spacers are designed to work with Arlen Ness "Hot Legs" billet lower legs, American Suspension "Bagger Legs" billet lower legs, or stock Harley Davidson 41MM FLH & FLT lower legs, not FX or XL legs. The 1-1/4" thick fender spacers can be used with a 6-3/8" wide custom front fender. The 1.0" thick fender spacers can be used with a 6" wide custom front fender. The 0.8125" thick fender spacers can be used with a 5-1/2" wide custom front fender.

Description	Thickness	Chrome	Black
Fender Spacers	0.8125"	811-20050	811-20053
	1"	811-20051	811-20054
	1-1/4"	811-20052	811-20055



### SMOOTH FENDER SPACERS 41MM

FLH fender spacers fit H-D FLH & FLT 41mm fork legs. The bolt spacing is 3.0" on these spacers & they are radiused to clear the fork leg. These fender spacers are machined from 6061 T-6 Billet Aluminum and brilliantly Black Anodized or Chrome Plated.

NOTE: For use with a 5-1/2" wide custom fender on OEM FLH or FLT 41mm fork legs.

Description	Chrome	Black
Fender Spacers	811-20056	811-20057

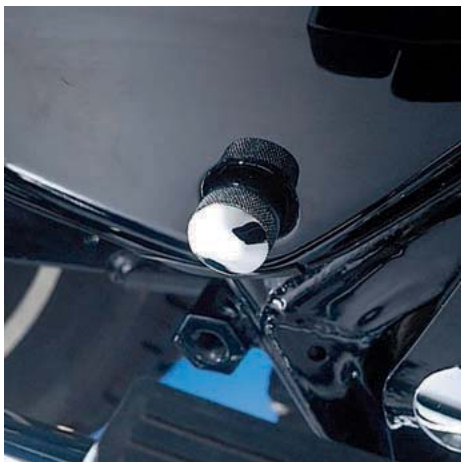

### HARLEY-DAVIDSON SIDE COVER KNOB

- Knurled with a chrome finish
- Includes O-ring
- 5/16-8 threaded mounting screw
- Sold in pairs
- Made in the USA!

Application	WPS#
'80-96 Touring models	62-2070



- WINDSHIELDS / FAIRINGS
- AUDIO / COMMUNICATION
- SEATS / LUGGAGE
- BARS / MIRRORS / CONTROLS
- EXHAUST
- AIR / FUEL SYSTEMS
- ENGINE
- TRANSMISSION / DRIVELINE
- GASKETS / SEALS
- ELECTRICAL
- LIGHTING
- CABLES
- BRAKES
- OIL FILTERS
- SUSPENSION
- BODY**
- WHEELS
- TIRES / TIRE ACC.
- BIKE ACC.
- VICTORY / INDIAN
- COVERS / LOCKS / TIEDOWNS
- CHEMICALS
- TOOLS
- HELMETS
- HELMET ACC.
- EYEWEAR
- APPAREL / RIDER ACC.
- PROMOTIONAL
- REFERENCE
- INDEX



## SHORT FRONT FENDERS FOR SPORTSTER AND DYNA MODELS

- These short front fenders give your bike a custom look that gets even better when combined with our custom rear fender kits.
- Made from black gel coated fiberglass
- All tire clearances and fitment must be checked before painting

	Description	Application	WPS#
A	Short Front Fender	'06-17 Dynas w/49mm Forks (except FLD, FXDWG and FXDF)	<b>750-01103</b>
B		All FXD/XL w/39mm Forks 18", 19" and 21"	<b>750-01104</b>
C		Sportster 48 Models	<b>750-01105</b>
D	Super Short Front Fender	All FXD/XL w/39mm Forks 18", 19" and 21"	<b>750-01106</b>



## UNIVERSAL FRONT FENDERS FOR CUSTOM APPLICATIONS

- Made from gel coated fiberglass
- Requires drilling of mounting holes
- Check tire clearances and fitment before painting



	Description	WPS#
A	Long Front Fender for 19" & 21" Wheels 125mm Width	<b>750-01100</b>
B	Cafe Style Front Fender for 19" Wheels 115mm Width	<b>750-01101</b>
C	Short Front Fender for 19" & 21" Wheels 115mm Width	<b>750-01102</b>

### FLT FRONT FENDERS

- Available for '86-13 Touring models with holes for stock trim
- A smooth FLHX style version for '00-13 Touring models is also available



Description	Application	WPS#
Front Fender for FLT Models	Fits '87-99 FLT (OE 59093-87)	<b>820-52003</b>
	Fits '00-13 FLT with Fender Tip Indent and Trim Holes	<b>820-52004</b>
	Fits '00-13 FLT Smooth No Trim Holes FLHX Style	<b>820-52005</b>
	Fits '14-Up FLT with Fender Tip Indent and Trim Holes	<b>820-52226</b>
	Fits '14-Up FLT Smooth No Trim Holes FLHX Style	<b>820-52228</b>
2-Piece Trim Set (Side pieces w/Hardware) Chrome		<b>820-57100</b>
2-Piece Trim Set (Side pieces w/Hardware) Black		<b>820-57101</b>

### FL SOFTAIL FENDERS

- Heritage style fender available with or without trim holes
- Fat Boy style fender also fit FLSTC Heritage models



Description	Application	WPS#
Heritage Style Front Fender	Fits '86-12 Heritage Softail Stock Replacement (OE 59129-86)	<b>820-52009</b>
	Fits '86-12 Heritage Softail Smooth Style No Trim Holes	<b>820-52010</b>
Fat Boy Style Front Fender	Fits '90-13 FLSTF Models	<b>820-52008</b>
Softail Slim Style Front Fender	Fits '12-Up FLS Models with Trim Holes	<b>820-52229</b>
	Fits '12-Up FLS Models Smooth Style No Trim Holes	<b>820-52230</b>
2-Piece Trim Set (Side pieces w/Hardware) Chrome		<b>820-57100</b>
2-Piece Trim Set (Side pieces w/Hardware) Black		<b>820-57101</b>

### FL FRONT FENDERS

- Front fenders for '49-84 FL models
- Available with or without trim holes
- With rolled edges and riveted brackets for durability



Description	Application	WPS#
Front Fender for FL Models	Fits '49-84 FLH with Trim Holes	<b>820-52000</b>
	Fits '79-84 FLH with Fender Tip Indent and Trim Holes	<b>820-52001</b>
	Fits '54-84 4-Speed FL Models No Trim Holes	<b>820-52002</b>
2-Piece Trim Set (Side pieces w/Hardware) Chrome		<b>820-57100</b>
2-Piece Trim Set (Side pieces w/Hardware) Black		<b>820-57101</b>

### FX & XL STYLE FRONT FENDERS

- Accurate reproductions of narrow glide and FX wide glide style fenders
- Mounting brackets are riveted for strength and accept stock hardware
- Durable stamped steel construction



Description	Application	WPS#
Narrow Front Fenders	For Narrow Glide Front Ends '73-12 FX, FXR, XL and Dyna Models	<b>820-52006</b>
	For Wide Glide Front Ends '80-Up FXWG, FXST/C/B, '93-05 FXDWG	<b>820-52007</b>
	For FXSTS Models '93-06	<b>820-52013</b>
	For 49mm Front Ends	<b>820-52015</b>
Short style	For Narrow Glide Front Ends '73-12 FX, FXR, XL and Dyna Models	<b>820-52014</b>
Early Style with Chrome Brackets		<b>820-52011</b>
Repl. Brackets for 820-52011		<b>820-52012</b>

- WINDSHIELDS / FAIRINGS
- AUDIO / COMMUNICATION
- SEATS / LUGGAGE
- BAR / MIRRORS / CONTROLS
- EXHAUST
- AIR / FUEL SYSTEMS
- ENGINE
- TRANSMISSION / DRIVELINE
- GASKETS / SEALS
- ELECTRICAL
- LIGHTING
- CABLES
- BRAKES
- OIL FILTERS
- SUSPENSION
- BODY**
- WHEELS
- TIRES / TIRE ACC.
- BIKE ACC.
- VICTORY / INDIAN
- COVERS / LOCKS / TIEDOWNS
- CHEMICALS
- TOOLS
- HELMETS
- HELMET ACC.
- EYEWEAR
- APPAREL / RIDER ACC.
- PROMOTIONAL
- REFERENCE
- INDEX



## FL SOFTAIL REAR FENDERS

- Designed for '86-99 Heritage Softail models
- Smooth version without taillight mount can be used for custom applications

Application	WPS#
Fits '86-99 Heritage Softail Stock Replacement (OE 59126-86B)	<b>820-52100</b>
Fits '86-99 Heritage Softail or Custom Applications Smooth Style 7" Wide	<b>820-52101</b>



## FXR REAR FENDERS

- Reproduction fender with all OE mounting holes for struts lights etc.
- Heavy duty steel construction (unpainted)

Application	WPS#
Fits '82-94 FXR (OE 59634-81A)	<b>820-52104</b>



## BIG TWIN HINGED REAR FENDERS

- Excellent reproduction of the hinged rear fender used on '58-Up four speed Big Twins
- Available with no taillight mount or mount for '73-98 style taillight

Application	WPS#
Fits '58-84 Big Twins No Taillight Mount	<b>820-52105</b>
Fits '58-84 Big Twins w/'73-98 Style Taillight Mount	<b>820-52106</b>



## BIG TWIN RIGID REAR FENDERS

Application	WPS#
Fits '49-57 Big Twins	<b>820-52102</b>
Fits '36-48 Big Twins	<b>820-52103</b>



## FLAT FENDERS

- Flat fenders for custom applications
- Available in two styles, 6" wide
- 14-gauge steel construction

Description	Application	WPS#
6" Flat Fenders	Universal w/Bobbed End	<b>820-52107</b>
	Universal w/Straight End	<b>820-52108</b>



- WINDSHIELDS / FAIRINGS
- AUDIO / COMMUNICATION
- SEATS / LUGGAGE
- BARS / MIRRORS / CONTROLS
- EXHAUST
- AIR / FUEL SYSTEMS
- ENGINE
- TRANSMISSION / DRIVELINE
- GASKETS / SEALS
- ELECTRICAL
- LIGHTING
- CABLES
- BRAKES
- OIL FILTERS
- SUSPENSION
- BODY**
- WHEELS
- TIRES / TIRE ACC.
- BIKE ACC.
- VICTORY / INDIAN
- COVERS / LOCKS / TIEDOWNS
- CHEMICALS
- TOOLS
- HELMETS
- HELMET ACC.
- EYEWEAR
- APPAREL / RIDER ACC.
- PROMOTIONAL
- REFERENCE
- INDEX



**STEEL FENDERS**



- Raw steel fenders made from 16 gauge steel for custom applications
- 820-52016 4 1/2" wide, 6 3/4" between fender mounts
- 820-52017 4 1/2" wide, 6 3/4" between fender mounts
- 820-52018 6 3/8" wide
- 820-52019 6 3/8" wide
- Fenders are NOT pre drilled

Description	WPS #
Outlaw 21" Front Fender Raw Steel	<b>820-52016</b>
Gunfire 21" Front Fender Raw Steel	<b>820-52017</b>
Long Skirted Ground Pounder FRT Fender	<b>820-52018</b>
Round Skirted GroundPounder FRT Fender	<b>820-52019</b>



820-52016



820-52017



820-52018



820-52019

- WINDSHIELDS / FAIRINGS
- AUDIO / COMMUNICATION
- SEATS / LUGGAGE
- BARS / MIRRORS / CONTROLS
- EXHAUST
- AIR / FUEL SYSTEMS
- ENGINE
- TRANSMISSION / DRIVELINE
- GASKETS / SEALS
- ELECTRICAL
- LIGHTING
- CABLES
- BRAKES
- OIL FILTERS
- SUSPENSION
- BODY**
- WHEELS
- TIRES / TIRE ACC.
- BIKE ACC.
- VICTORY / INDIAN
- COVERS / LOCKS / TIEDOWNS
- CHEMICALS
- TOOLS
- HELMETS
- HELMET ACC.
- EYEWEAR
- APPAREL / RIDER ACC.
- PROMOTIONAL
- REFERENCE
- INDEX

- WINDSHIELDS / FAIRINGS
- AUDIO / COMMUNICATION
- SEATS / LUGGAGE
- BARS / MIRRORS / CONTROLS
- EXHAUST
- AIR / FUEL SYSTEMS
- ENGINE
- TRANSMISSION / DRIVELINE
- GASKETS / SEALS
- ELECTRICAL
- LIGHTING
- CABLES
- BRAKES
- OIL FILTERS
- SUSPENSION
- BODY**
- WHEELS
- TIRES / TIRE ACC.
- BIKE ACC.
- VICTORY / INDIAN
- COVERS / LOCKS / TIEDOWNS
- CHEMICALS
- TOOLS
- HELMETS
- HELMET ACC.
- EYEWEAR
- APPAREL / RIDER ACC.
- PROMOTIONAL
- REFERENCE
- INDEX



## SOFTAIL FENDER AND SEAT KITS

These kits will give your Softail the most radical custom look. Extremely short fender with your choice of smooth or diamond stitch custom seat in a smooth or ribbed fender version.

- Made from gel coated fiberglass
- High quality vinyl seat with urethane foam
- Looks best with lowered suspension and side mount taillight
- OEM rear lighting must be relocated
- Mounting hardware included
- Check fitment and tire clearances before paint and final assembly
- Not for Rocker or Crossbone models



A

B

	Application	Description	WPS#
	Softail Models '08-17 w/200mm rear tire	Smooth Rear Fender Kit with Diamond Stitch Seat	<b>750-01060</b>
A		Smooth Rear Fender Kit with Smooth Seat	<b>750-01061</b>
		Ribbed Rear Fender Kit with Smooth Seat	<b>750-01062</b>
B		Ribbed Rear Fender Kit with Diamond Stitch Seat	<b>750-01063</b>

## BREAKOUT FENDER

- Bobber style rear fender for FXSB Breakout models
- Gel coated fiberglass (check fitment before paint)
- Custom solo seat required (not included)



Description	Year	WPS#
FXSB Bobber Fender	'13-17	<b>750-01084</b>





## DYNA FENDER KITS

Turn your Dyna into a bobber or just show off some more of that rear tire with one of these custom rear fender kits.



- Made from gel coated fiberglass
- Turn signal and taillight relocation may be required, we recommend a side mount taillight
- Glide style fender works well with chopped fender taillights (# 750-01280 thru 750-01282)
- Requires a custom solo seat (not included)
- Check fitment and tire clearances before paint and final installation

Application	Description	WPS#
A Dyna Models '06-17	Bobber Style Rear Fender Kit	<b>750-01071</b>
B	Short Fat Bob Rear Fender Kit	<b>750-01072</b>
C	Glide Rear Fender Kit	<b>750-01086</b>



## STILETTO SOFTAIL FENDER KIT

The ultimate short fender kit for Softails. Show off that rear tire and give your bike some attitude!

- Struts and fender are made from steel (unpainted)
- OEM taillight and turn signals will not work with this kit
- We recommend using a side mount taillight
- ECM mounting bracket included
- Will not fit Rocker models



Application	Description	WPS#
Softail Models '08-17 w/200mm rear tire	Stiletto Rear Fender Kit	<b>750-01070</b>

- WINDSHIELDS / FAIRINGS
- AUDIO / COMMUNICATION
- SEATS / LUGGAGE
- BARS / MIRRORS / CONTROLS
- EXHAUST
- AIR / FUEL SYSTEMS
- ENGINE
- TRANSMISSION / DRIVELINE
- GASKETS / SEALS
- ELECTRICAL
- LIGHTING
- CABLES
- BRAKES
- OIL FILTERS
- SUSPENSION
- BODY**
- WHEELS
- TIRES / TIRE ACC.
- BIKE ACC.
- VICTORY / INDIAN
- COVERS / LOCKS / TIEDOWNS
- CHEMICALS
- TOOLS
- HELMETS
- HELMET ACC.
- EYEWEAR
- APPAREL / RIDER ACC.
- PROMOTIONAL
- REFERENCE
- INDEX



## **GUNFIGHTER COWL KITS**

- For the ultimate cafe hotrod look
- Made of gel coated fiberglass, ready for paint or mount as is
- Kits include seats and all necessary mounting hardware
- Four different style seats available
- Shortening of frame struts required for installation



Smooth



Pleated



Vertical Pleat



Diamond Stitch



<b>Application</b>	<b>Description</b>	<b>WPS #</b>
Fits XL Models '04-06 and '10-Up	Smooth	<b>750-01064</b>
	Pleated	<b>750-01065</b>
	Vertical Pleat	<b>750-01066</b>
	Diamond Stitch	<b>750-01067</b>



## REAR FENDER KITS FOR SPORTSTERS

Whether you're turning your Sporty into a cafe racer, bobber or chopper we have a fender kit to finish the job! Ideal when combined with our custom short front fenders.

- Made from gel coated fiberglass
- Turn signal and taillight relocation required for some kits
- Mounting hardware included
- Custom solo seat required (not included)
- Check fitment and tire clearances before painting and final assembly



Description	Year	WPS#
A XL Bobber Fender Type 2	'04-06 and '10-Up	<b>750-01073</b>
	'07-09	<b>750-01074</b>
	'94-03	<b>750-01082</b>
B XL Short Bobber Fender	'04-06 and '10-Up	<b>750-01075</b>
	'07-09	<b>750-01076</b>
C XL Short Fat Bob Fender	'04-06 and '10-Up	<b>750-01077</b>
	'07-09	<b>750-01078</b>
D XL Center Ribbed Fender	'04-06 and '10-Up	<b>750-01079</b>
E XL Short Iron Fender	'04-06 and '10-Up	<b>750-01080</b>
F XL Short Flat Bob Fender	'04-06 and '10-Up	<b>750-01081</b>
G XL Bicycle Flat Fender	'04-06 and '10-Up	<b>750-01083</b>
H XL Frisco Fender	'04-06 and '10-Up	<b>750-01085</b>

- WINDSHIELDS / FAIRINGS
- AUDIO / COMMUNICATION
- SEATS / LUGGAGE
- BARS / MIRRORS / CONTROLS
- EXHAUST
- AIR / FUEL SYSTEMS
- ENGINE
- TRANSMISSION / DRIVELINE
- GASKETS / SEALS
- ELECTRICAL
- LIGHTING
- CABLES
- BRAKES
- OIL FILTERS
- SUSPENSION
- BODY**
- WHEELS
- TIRES / TIRE ACC.
- BIKE ACC.
- VICTORY / INDIAN
- COVERS / LOCKS / TIEDOWNS
- CHEMICALS
- TOOLS
- HELMETS
- HELMET ACC.
- EYEWEAR
- APPAREL / RIDER ACC.
- PROMOTIONAL
- REFERENCE
- INDEX



**UNIVERSAL CAFE SEAT COWL**



- Gel coated fiberglass, ready for paint
- Overall length 24.4"
- Width at the front 5.5"
- Width at the widest point at rear of seating surface 8.85"
- Length of seating surface 13.8"
- Seat pad and mounting hardware must be custom made



Description	Application	WPS#
Cafe Seat Cowl	Universal	<b>750-01087</b>

**SOLO SEATS**



- West Eagle solo seats are a perfect match for their Sportster custom fender kits but will also work on stock bikes
- High grade vinyl cover material is easily maintained



Application	WPS#
<b>SOLO GUNFIGHTER SEATS FOR '04-UP SPORTSTERS</b>	
A Smooth	<b>750-01550</b>
B Deluxe	<b>750-01551</b>
C Diamond	<b>750-01552</b>
D Tuck & Roll	<b>750-01553</b>

Application	WPS#
<b>SOLO COBRA SEATS FOR '04-06 AND '10-UP SPORTSTERS</b>	
E Diamond	<b>750-01554</b>
F Tuck & Roll	<b>750-01555</b>
G Pleated	<b>750-01556</b>



## CUSTOM RIBBED FENDERS

- Ribbed fenders for custom applications
- Available in different widths and flare styles
- Made from polished aluminum or unpainted steel
- These fenders are handcrafted which makes them more resistant to cracking and gives them a superior finish and overall better quality than stamped steel counterparts offered elsewhere



Description	WPS#
A Center Ribbed Fender Aluminum Polished 4 3/4"	<b>750-01041</b>
B Center Ribbed Fender Steel 4 3/4"	<b>750-01042</b>
C Twin Ribbed Fender Steel 4 3/4"	<b>750-01043</b>
Center Ribbed Fender Aluminum Polished 6"	<b>750-01044</b>
D Center Ribbed Fender Steel 6"	<b>750-01045</b>
E Wide Center Ribbed Fender Steel 7 1/4"	<b>750-01046</b>
F Flat Bicycle Style Fender 5 1/2"	<b>750-01050</b>



## FENDER STRUT KIT

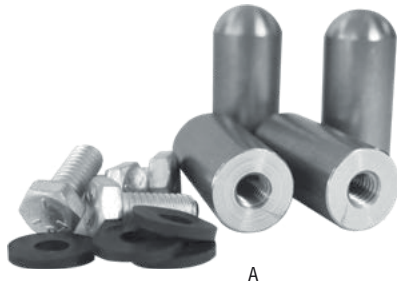

A

- Universal fender strut kit for choppers and bobbers
- Kit includes: 4 CNC Machined steel bungs with 3/8-16 threaded hole and two 12" long 1/2" diameter steel rods
- Everything is made from 1018 mild steel for easy welding!
- Threaded bungs can be used to mount fenders, tanks, and virtually anything that you want to bolt to your frame
- 1.75" Overall Length
- Includes Bolts and Rubber Washers to protect your paint
- Sold in quantities of 4

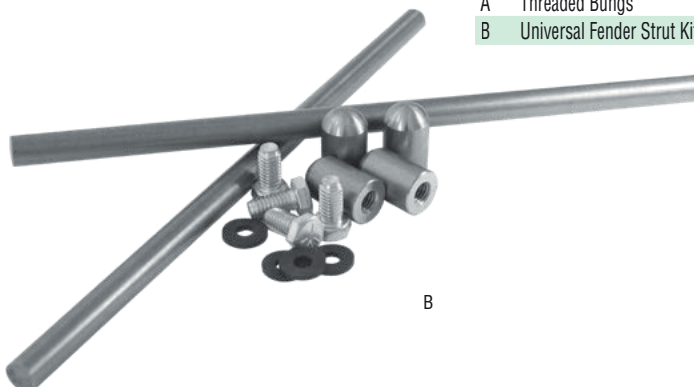

B

Description	WPS#
A Threaded Bungs	<b>563-01150</b>
B Universal Fender Strut Kit	<b>563-01151</b>

WINDSHIELDS / FAIRINGS

AUDIO / COMMUNICATION

SEATS / LUGGAGE

BAR / MIRRORS / CONTROLS

EXHAUST

AIR / FUEL SYSTEMS

ENGINE

TRANSMISSION / DRIVELINE

GASKETS / SEALS

ELECTRICAL

LIGHTING

CABLES

BRAKES

OIL FILTERS

SUSPENSION

**BODY**

WHEELS

TIRES / TIRE ACC.

BIKE ACC.

VICTORY / INDIAN

COVERS / LOCKS / TIEDOWNS

CHEMICALS

TOOLS

HELMETS

HELMET ACC.

EYEWEAR

APPAREL / RIDER ACC.

PROMOTIONAL

REFERENCE

INDEX



## RIBBED FENDERS

- For use with 18", 19" or 21" rims
- For OE replacement or custom applications



Application	Description	WPS#
'73-Up Narrow Glide Forks	Ribbed Fender Raw Bracket	<b>820-52109</b>
	Ribbed Fender Chrome Bracket	<b>820-52110</b>
	Ribbed Fender No Bracket	<b>820-52111</b>

## RIBBED TANKS

- Available with cam style bung, screw bung or chrome pop up cap fitted on right hand side
- Tank measures approximately 17" L x 11.5" W & 2" W tunnel
- 3.3 Gal capacity, fitted center right hand 3/8" NPT gas outlet with 2 x 1/4" cross over outlets one either side at rear, allows for multiple choice routing of fuel lines



Application	Description	WPS#
Custom Applications	Ribbed Mustang Tank, Screw Bung	<b>820-52200</b>
	Ribbed Mustang Tank, Cam Style Bung	<b>820-52201</b>
	Ribbed Mustang Tank, Pop-Up Cap	<b>820-52202</b>



## GAS TANK PARTS

- Want a sight gauge on your gas or oil tank but don't want bulky lines and fittings hanging off the side? TC Bros. has the solution! Crystal clear glass viewing lens sealed tight into a CNC machined brass housing. Also included is a forged 3/4" NPT mild steel bung for easy welding. Proudly made in the USA!
- Aluminum filler cap for oil tanks (unvented). Standard 1 5/16"-12 thread fits many chopper oil tanks. CNC Machined From 6061 Billet Aluminum with a leak free O-ring seal. Cap is knurled for extra grip and features a dome top contour for classic looks. Proudly made in the USA!



Description	WPS#
A Sight Glass Kit	<b>563-01822</b>
B Aluminum Filler Cap (unvented)	<b>563-01823</b>
C Aluminum Filler Cap w/Weld in Bung	<b>563-01824</b>



**HAND SHIFT TANKS**

A reproduction of the long unavailable hand shift style 3.5 gallon tank set as used on the 1947 thru 1965 Big Twins. This reproduction takes original rod type shut-off valve, cam style gas caps, cross over gas line and is designed to accept the 1947 thru 1965 shifter guide. Measurement may slightly vary from OEM tank.

Application	Description	WPS#
'47-65 Big Twins	3.5 Gal, Rod Style Shut Off Valve	<b>820-52203</b>
	3.5 Gal, '75-Up Style Petcock Bung	<b>820-52204</b>



**FAT BOB TANKS**

Reproductions of the classic Fat Bob gas tank. Mounting is made to OEM specifications for a perfect fit on stock Harley 4 Speed Big Twin frames thru 1984 (except Softails). Also fits custom rigid and swing arm frames. Each tank is made to accept either the FX style dual instrument dash or the FL-FXWG style large speedo dash. Available in 3.5 gallon and 5 gallon. Tank accepts OEM or after market gas caps and fuel valve.

Application	Description	WPS#
4-Speed Big Twins to '84 (except Softails)	3.5 Gal, Cam Style Bungs	<b>820-52205</b>
	3.5 Gal, Screw Style Bungs	<b>820-52207</b>
	5 Gal, Cam Style Bungs	<b>820-52206</b>
	5 Gal, Screw Style Bungs	<b>820-52208</b>



**FLAT SIDE TANKS**

These tank sets are a duplication of the late style "Flatside" tank sets. They fit FXST models 1984 thru 1999 and are available with two versions of tank caps such as OEM style cam lock gas cap and Screw-In bung. Can be used for crash repairs or any other Custom application. Available in a 3.5 and a 5 gallon capacity. Accepts most FL, FXWG and FXST style dashes

Application	Description	WPS#
'84-99 Softails	3.5 Gal, Screw Style Bungs	<b>820-52209</b>
	5 Gal, Screw Style Bungs	<b>820-52210</b>

**SOFTAIL TANKS**

Gas tanks with dash mount for Twin Cam Softail models. Can be used with the stock or stock style seats. Made from heavy gauge steel for years of leak and trouble free riding. Tanks are available for use with OEM style Screw-In gas caps and the gauge equipped OEM left side cap. Available for carburetor and EFI models. Tanks take approx. 5.1 gallon.



Application	Description	WPS#
'00-07 Softails	5 Gal Tank for Carb Models	<b>820-52211</b>
	5 Gal Tank for EFI Models	<b>820-52212</b>
EFI Tanks	Block off kit for fuel gauge bung	<b>820-52227</b>

WINDSHIELDS / FAIRINGS  
AUDIO / COMMUNICATION  
SEATS / LUGGAGE  
BARS / MIRRORS / CONTROLS  
EXHAUST  
AIR / FUEL SYSTEMS  
ENGINE  
TRANSMISSION / DRIVELINE  
GASKETS / SEALS  
ELECTRICAL  
LIGHTING  
CABLES  
BRAKES  
OIL FILTERS  
SUSPENSION  
**BODY**  
WHEELS  
TIRES / TIRE ACC.  
BIKE ACC.  
VICTORY / INDIAN  
COVERS / LOCKS / TIEDOWNS  
CHEMICALS  
TOOLS  
HELMETS  
HELMET ACC.  
EYEWEAR  
APPAREL / RIDER ACC.  
PROMOTIONAL  
REFERENCE  
INDEX



**SLIM LINE LEGACY GAS TANK**

- These new Slim-line Legacy gas tanks have been narrowed & tapered for a great new custom look
- Available with screw-in style center bung position
- Holds approx 2.75 Gal
- Old school rubber knee pad kits also available, sold separately



Application	Description	WPS#
'83-03 Sportster models	Comes with twin petcocks and chrome block-off nut. Replaces stock tanks 61023-93 and 61348-96A	<b>820-52220</b>
'04-06 Sportster models	Replaces stock tank 61348-04 with single LH petcock	<b>820-52224</b>
Legacy EFI Tank Screw in Style	Uses '07-Up OEM Sportster Fuel Pump	<b>820-52114</b>
Legacy EFI Lynx Style	Uses '07-Up OEM Sportster Fuel Pump	<b>820-52115</b>
Custom applications	Comes with 3 piece weld-on mounting bracket and bushing kit	<b>820-52222</b>
Legacy Tanks	Black rubber knee pad kit sold in pairs	<b>820-52225</b>

**XL EFI TANKS**

Peanut style tanks to fit 2004 to present stock Sportster frames. Fuel capacity is approximately 3.9 gallon. Available complete with your choice of stock style screw bung or pop-up style gas cap (included). Tanks are approximately 19" long, 11" wide, and 8" high.

Application	Description	WPS#
'04-06 XL Models	3.3 Gal. Pop-Up Cap	<b>820-52215</b>
'07-Up XL Models	3.3 Gal. Stock Screw Style Cap	<b>820-52216</b>
'07-Up EFI XL Models	3.3 Gal. Stock Screw Style Cap	<b>820-52112</b>
Custom Application EFI	3.3 Gal. Stock Screw Style Cap w/Weld on Brackets	<b>820-52113</b>
'07-Up EFI XL Models	Dished Tank 3.3 Gal. Stock Screw Style Cap	<b>820-52116</b>



**XL RUBBER MOUNTED TANKS**

This upgraded stock style Peanut Sportster gas tank features rubber mounting. Rubber mounts isolate the tank from engine vibration and prevent cracking of the welds. This is a great improvement over the OE tank. Tank holds approximately 2.25 gallons and is available with a screw-in type bung, gas cap not included.

Application	Description	WPS#
'83-94 XL Models	2.25 Gal	<b>820-52213</b>
'95-03 XL Models	2.25 Gal	<b>820-52214</b>



**XL KING TANKS**

King Size tanks for Sportster models have been a popular choice of Custom bike builders for many years. Will bolt to the Stock frame mounts on all '79-03 Sportsters. Has a larger than stock fuel capacity for extra mileage. Holds approximately 3.1 gallons. The '79-81 version accepts cam style gas caps while the later versions have screw style bungs. Gas caps sold separately.

Application	Description	WPS#
'79-81 XL Models	3.1 Gal	<b>820-52217</b>
'82-94 XL Models	3.1 Gal	<b>820-52218</b>
'95-03 XL Models	3.1 Gal	<b>820-52219</b>







**DISHED TANKS**

These single cap tanks have the late stock-style screw-in filler necks, and have 22mm petcock bungs on the 1995 thru 2006 tanks. Re-use your OEM fuel pump assembly on the 2007-up tanks

	Description	Application	WPS #
A	3 Gallon Custom Dished Tank	Universal	<b>830-3803</b>
	3.5 Gallon Dished Tank	Fits '95-03 XL Models	<b>830-3804</b>
		Fits '04-06 XL Models	<b>830-3805</b>
B		Fits '07-Up XL Models	<b>830-3806</b>



**MUSTANG TANKS**

All tanks come with "horseshoe" style mounts in a bare metal finish and have been pressure tested. We recommend they be test fitted before paint. Cam style gas caps sold separately.

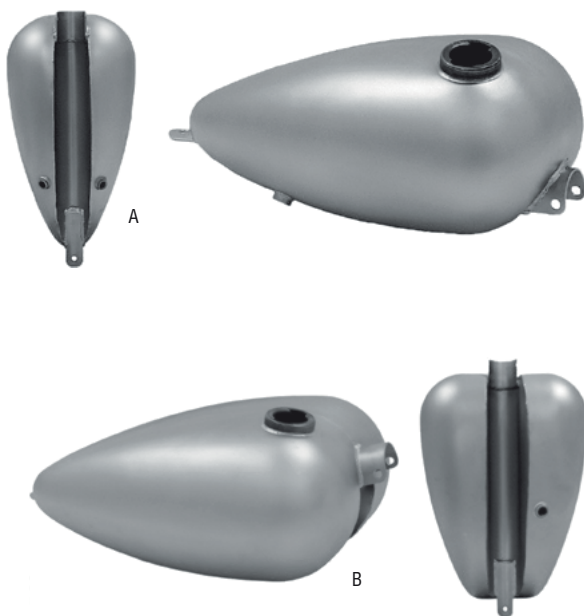

	Description	Application	WPS #
A	2.4 Gallon Narrow Tunnel Single Cap	1/4" Petcock Bung	<b>830-3800</b>
B	3 Gallon High Tunnel Single Cap	3/8" NPT Petcock Bung	<b>830-3801</b>
C	4.75 Gallon Low Tunnel Single Cap	22mm Petcock Bung	<b>830-3802</b>

**TANK DIMENSIONS**

WPS #	Tank Length	Tank Width	Tank Depth	Tunnel Length	Tunnel Depth	Tunnel Width	Centerline Hole to Hole Mounting Brackets
<b>830-3800</b>	16-1/2"	9"	7"	16-1/2"	2-1/2"	2-1/4"	17"
<b>830-3801</b>	16-1/2"	12"	7"	16-1/2"	5"	2-1/2"	17-11/16"
<b>830-3802</b>	19-1/2"	13"	8"	19-1/2"	4-1/4"	2-3/16"	19-3/4"
<b>830-3803</b>	16"	10"	9"	16"	2-1/2"	2-1/2"	16-3/4"
<b>830-3804</b>	16"	12"	9"	16"	2-1/4"	2-1/2"	14-5/8"
<b>830-3805</b>	16"	12"	9"	16"	2-3/4"	3-1/4"	23"
<b>830-3806</b>	16"	12"	9"	16"	2-3/4"	3-1/4"	23"

- WINDSHIELDS / FAIRINGS
- AUDIO / COMMUNICATION
- SEATS / LUGGAGE
- BAR / MIRRORS / CONTROLS
- EXHAUST
- AIR / FUEL SYSTEMS
- ENGINE
- TRANSMISSION / DRIVELINE
- GASKETS / SEALS
- ELECTRICAL
- LIGHTING
- CABLES
- BRAKES
- OIL FILTERS
- SUSPENSION
- BODY**
- WHEELS
- TIRES / TIRE ACC.
- BIKE ACC.
- VICTORY / INDIAN
- COVERS / LOCKS / TIEDOWNS
- CHEMICALS
- TOOLS
- HELMETS
- HELMET ACC.
- EYEWEAR
- APPAREL / RIDER ACC.
- PROMOTIONAL
- REFERENCE
- INDEX



## TANK MOUNT KITS

- Our quick mount kit for Fat Bob tanks (820-52260) is a precise way to mount the OEM or aftermarket Fat Bob tanks to custom or original frames that have the OEM mounting tabs removed. Allows you to locate the bracket for a visual check of the tank location on the frame and once the position is selected the whole bracket set can be welded in place
- Our front bottom mount (820-52262) is an exact reproduction of the lower bracket as featured on the 4-speed frames thru 1984. Easy to weld on and can be adapted to many custom frames
- Our Flat-Side tank mounting kit (820-52265) makes it possible to mount the late style Flat-Side gas tank on your early style 4-speed Big Twin frame
- Our Flat-Side tank mount kit (820-52266) can be used to update your existing Flat-Side tank mounts, or for use on newly constructed vehicles instead of purchasing the original parts. The beveled washers and mounting screws are chrome-plated. Fits '84-99 Softail, and all other models with split tanks from '85-99.



A



B



C



D



E



F



G



H

Application	WPS#
A For OE or Aftermarket Fat Bob Tanks	820-52259
B For One Piece Tanks on Softails	820-52264
C For Flat Side Tanks on 4-Speed Frames	820-52265
D For Flat Side Tanks	820-52266
<b>QUICK MOUNT KIT</b>	
E For Fat Bob Tanks on Frames with No Mounts	820-52260
<b>FRONT BOTTOM MOUNT</b>	
F For 4-Speed Frames with Fat Bob Tanks	820-52262
<b>RUBBER MOUNTING GROMMETS</b>	
G For Fat Bob Tanks (10 Pk)	820-52261
H For Flat Side Tanks (6 Pk)	820-52263



A



B



C



D



E



F

**TANK MOUNTS**



- Chrome plated mounting hardware
- Made in the U.S.A

Application	WPS#
A For '91-99 Softail	<b>830-1130</b>
B For '91-17 Dyna	<b>830-1131</b>
C For '98-UP Touring	<b>830-1135</b>
D For '96-03 Sportster	<b>830-1136</b>
E For '04-UP Sportster	<b>830-1137</b>
<b>RUBBER MOUNTING GROMMETS</b>	
F Grommets and Spacers kit '84-99 Softail	<b>830-1134</b>

**REPLACEMENT PETCOCKS**



- These petcocks are highly polished and then chrome plated
- Petcocks are designed to maximize fuel flow in both main and reserve modes
- 22mm metric petcocks fit all 1975 to present Big Twin and Sportster models as well most Custom tanks



A



B



C



D



E



F



G

Application	Description	WPS#	Application	Description	WPS#
Tanks with 13/16" Bungs ('75-Up)	Straight Down Spigot	<b>820-52250</b>	E Tank with 13/16" Bungs ('75-Up)	Straight Down Spigot BLK	<b>820-52235</b>
A	Left Spigot	<b>820-52251</b>		Left Spigot BLK	<b>820-52236</b>
B	Right Spigot	<b>820-52252</b>		Right Spigot BLK	<b>820-52237</b>
C Tanks with 3/8" NPT Bungs (Pre '75)	Right Spigot	<b>820-52253</b>	F Tank with 13/16" Bungs ('75-Up)	Round Chrome Right Spigot	<b>820-50567</b>
D	Straight Down Spigot	<b>820-52254</b>	G	Round Chrome Straight Down Spigot	<b>820-50568</b>
Tanks with 1/4" NPT Bungs	Right Spigot	<b>820-52255</b>		Replacement Gaskets (10 pk)	
	Straight Down Spigot	<b>820-52256</b>		4 Hole Viton Gasket	<b>820-52257</b>
				3 Hole Viton Gasket	<b>820-52258</b>

- WINDSHIELDS / FAIRINGS
- AUDIO / COMMUNICATION
- SEATS / LUGGAGE
- BAR / MIRRORS / CONTROLS
- EXHAUST
- AIR / FUEL SYSTEMS
- ENGINE
- TRANSMISSION / DRIVELINE
- GASKETS / SEALS
- ELECTRICAL
- LIGHTING
- CABLES
- BRAKES
- OIL FILTERS
- SUSPENSION
- BODY**
- WHEELS
- TIRES / TIRE ACC.
- BIKE ACC.
- VICTORY / INDIAN
- COVERS / LOCKS / TIEDOWNS
- CHEMICALS
- TOOLS
- HELMETS
- HELMET ACC.
- EYEWEAR
- APPAREL / RIDER ACC.
- PROMOTIONAL
- REFERENCE
- INDEX

WINDSHIELDS / FAIRINGS  
 AUDIO / COMMUNICATION  
 SEATS / LUGGAGE  
 BARS / MIRRORS / CONTROLS  
 EXHAUST  
 AIR / FUEL SYSTEMS  
 ENGINE  
 TRANSMISSION / DRIVELINE  
 GASKETS / SEALS  
 ELECTRICAL  
 LIGHTING  
 CABLES  
 BRAKES  
 OIL FILTERS  
 SUSPENSION  
**BODY**  
 WHEELS  
 TIRES / TIRE ACC.  
 BIKE ACC.  
 VICTORY / INDIAN  
 COVERS / LOCKS / TIEDOWNS  
 CHEMICALS  
 TOOLS  
 HELMETS  
 HELMET ACC.  
 EYEWEAR  
 APPAREL / RIDER ACC.  
 PROMOTIONAL  
 REFERENCE  
 INDEX



**DIAMOND STITCH TANK COVER**

- Protects paint while adding an old school touch
- Fits OEM 3.3 Gal tanks
- Weather resistant vinyl material

Application	WPS#
'04-Up XL w/3.3 Gallon Tank	<b>750-01350</b>



**SPORTSTER TANK LIFT KIT**

- Raises the front of the stock tank by approximately two inches
- Add a set of narrow Z-bars or Attack bars to complete your Frisco style chopper

Description	Application	WPS#
Tank Lift Kit 2"	'04-Up XL Models	<b>750-01260</b>

BEFORE



AFTER



**CUSTOM GAS CAPS**



- Designed to match our grips and pegs
- Three styles in two finishes available
- For models with left side gas gauge a dummy cap or cap with low fuel indicator LED is available

- Made in the USA
- Sold each



A



A



B



B



C



C



D



D



E



E



F



F

Application/Year	Description	WPS Part#
A Late 96-Up	Gas Cap Vented Shock Black	820-4081
A	Gas Cap Vented Shock Chrome	820-4082
B	Gas Cap Vented Dash Black	820-4083
B	Gas Cap Vented Dash Chrome	820-4084
C	Gas Cap Vented Throttle Black	820-4085
C	Gas Cap Vented Throttle Chrome	820-4086
D All Models with Left Gas Gauge	Dummy Cap Shock Black	820-4087
D	Dummy Cap Shock Chrome	820-4088
E	Dummy Cap Dash Black	820-4089
E	Dummy Cap Dash Chrome	820-4090
F	Dummy Cap Throttle Black	820-4091
F	Dummy Cap Throttle Chrome	820-4092
	LED (Low Fuel Indicator) Cap Shock Black	820-4093
	LED (Low Fuel Indicator) Cap Shock Chrome	820-4094
	LED (Low Fuel Indicator) Cap Dash Black	820-4095
	LED (Low Fuel Indicator) Cap Dash Chrome	820-4096
	LED (Low Fuel Indicator) Cap Throttle Black	820-4097
	LED (Low Fuel Indicator) Cap Throttle Chrome	820-4098

- WINDSHIELDS / FAIRINGS
- AUDIO / COMMUNICATION
- SEATS / LUGGAGE
- BARS / MIRRORS / CONTROLS
- EXHAUST
- AIR / FUEL SYSTEMS
- ENGINE
- TRANSMISSION / DRIVELINE
- GASKETS / SEALS
- ELECTRICAL
- LIGHTING
- CABLES
- BRAKES
- OIL FILTERS
- SUSPENSION
- BODY**
- WHEELS
- TIRES / TIRE ACC.
- BIKE ACC.
- VICTORY / INDIAN
- COVERS / LOCKS / TIEDOWNS
- CHEMICALS
- TOOLS
- HELMETS
- HELMET ACC.
- EYEWEAR
- APPAREL / RIDER ACC.
- PROMOTIONAL
- REFERENCE
- INDEX



**GAS CAPS**

- Screw-In type Gas Caps
- Pop-Up Screw-in Smooth Gas Caps
- Gas cap screw-in with lock & cover
- Flush-Mount Gas Cap - Chromed die-cast aircraft style gas cap, includes mounting ring, gasket, screws & cap



A



B vented



C non-vented



D



E



F



G

Application/Year	Description	WPS Part#
A '96-UP Fatbob Tank	Screw in Smooth Vented Chrome	<b>820-2300</b>
	Screw in Smooth Vented Gloss Black	<b>820-52411</b>
	Screw in Smooth Vented Matte Black	<b>820-52413</b>
	Screw in Smoothe Non-Vented Chrome	<b>820-2301</b>
	Screw in Smoothe Non-Vented Gloss Black	<b>820-52412</b>
	Screw in Smoothe Non-Vented Matte Black	<b>820-52414</b>
	Screw in w/Lock & Cover Vented Black	<b>820-2307</b>
B	Screw in w/Lock & Cover Non-Vented Black	<b>820-2308</b>
	Flush Mount Gas Cap Vented	<b>820-2310</b>
C	Flush Mount Gas Cap Non-Vented	<b>820-2311</b>
D '82-95 HD & '04-06XL	Pop-up Screw in Smooth Vented Wrinkle Black	<b>820-2302B</b>
	Pop-up Screw in Smooth Vented Chrome	<b>820-2302C</b>
'96-UP HD (except 04-06XL)	Pop-up Screw in Smooth Vented Chrome	<b>820-2304C</b>
F	Pop-up Screw in Smooth Vented Black	<b>820-2304B</b>
G '82-95 HD	Screw in w/Lock & Cover Vented Chrome	<b>820-2305</b>
	Screw in w/Lock & Cover Non-Vented Chrome	<b>820-2306</b>



**CAM STYLE GAS CAPS**



Description	Application	WPS#
Single Cap Vented Chrome	Pre-82 Cam Style Tanks	<b>820-52415</b>
Cap Set Chrome		<b>820-52416</b>
Single Cap Vented Black		<b>820-52417</b>
Cap Set Black		<b>820-52418</b>



820-52382

**FUEL TANK CONSOLE DOORS**

- The new fuel tank console doors are made from aluminum
- Available in Chrome, Gloss Black, and Satin Black
- Also available are the push button or key operated release kits, sold separately



820-52384



820-52385

820-52386



820-52387

Description	Chrome	Gloss Black	Satin Black
Fuel door for '92-16 Touring/Trike models	<b>820-52382</b>	<b>820-52383</b>	<b>820-52384</b>
<b>FUEL DOOR RELEASE KITS</b>			
Key operated	<b>820-52385</b>		
Push button	<b>820-52386</b>	<b>820-52387</b>	

WINDSHIELDS / FAIRINGS  
 AUDIO / COMMUNICATION  
 SEATS / LUGGAGE  
 BARS / MIRRORS / CONTROLS  
 EXHAUST  
 AIR / FUEL SYSTEMS  
 ENGINE  
 TRANSMISSION / DRIVELINE  
 GASKETS / SEALS  
 ELECTRICAL  
 LIGHTING  
 CABLES  
 BRAKES  
 OIL FILTERS  
 SUSPENSION  
**BODY**  
 WHEELS  
 TIRES / TIRE ACC.  
 BIKE ACC.  
 VICTORY / INDIAN  
 COVERS / LOCKS / TIEDOWNS  
 CHEMICALS  
 TOOLS  
 HELMETS  
 HELMET ACC.  
 EYEWEAR  
 APPAREL / RIDER ACC.  
 PROMOTIONAL  
 REFERENCE  
 INDEX



**BRASS BALLS**  
CYCLES

**FUEL DOORS**

- Replace your boring stock fuel door with one of these stunning pieces
- Available in natural or black finish with hammered copper or carbon inlay
- Matching tank panels and master cylinder covers available

Description	Black	Natural
Fuel Door w/Carbon Inlay	826-01200	826-01201
Fuel Door w/Copper Inlay	826-01202	826-01203



826-01200



826-01202



826-01201



826-01203

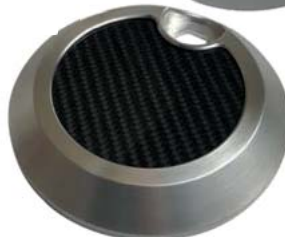

**TANK PANELS**

- Replace your boring stock tank panel with one of these stunning pieces
- Available in natural or black finish with hammered copper or carbon inlay
- Matching fuel doors and master cylinder covers available

Description	Black	Natural
Tank Panel w/Carbon Inlay	826-01210	826-01211
Tank Panel w/Copper Inlay	826-01212	826-01213



826-01210



826-01212



826-01211



826-01213





**CREEPSTER FILL CAP**



Comes with weld on vent fittings for venting tank into frame. The caps are available in chrome or brass. For weld on applications only. Can be used for gas or oil tank. Machined out of mild steel for easy welding. O-Ring included. Weld in vent bungs are 1/8" tapered pipe thread, which is standard for most oil fittings. 2" width base fill spout base 2" wide, 1-3/4" height, inside diameter of 1-3/8" with 2" threaded cap.

Description	WPS #
A Creepster Fill Cap Brass	<b>811-30100</b>
B Creepster Fill Cap Chrome	<b>811-30101</b>



**BILLET TANK COVERS**

- Precision Billet tank insert put a finishing touch on your bike
  - CNC milled aluminum
  - Easy installation
- Available in hard Black anodized contrast cut or show chrome finish

Application	Year	Description	Chrome	Black
Touring models	'08-Up	Ace's Wild	A <b>810-0553</b>	<b>810-0554</b>
Touring models	'08-Up	Darkside	B <b>810-0551</b>	<b>810-0552</b>

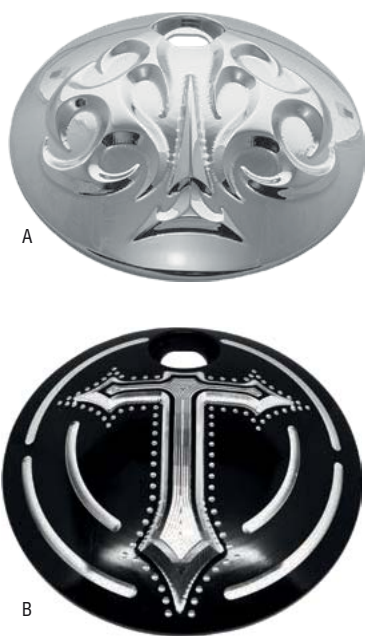

**BILLET FUEL DOOR**

- Precision Billet Fuel Door adds that extra finishing touch
- CNC milled for over 90 minutes out of 6061 Aircraft Grade Billet Aluminum
- Custom piece with virtually no flat surface
- Available with a hard coat Black anodized contrast cut finish or our two-tone chrome
- Long lasting beautiful and durable finish
- Perfect fit design that ensures no rattling

Application	Year	Description	WPS#
<b>HARLEY DAVIDSON</b>			
Touring models	'08-Up	Ace's Wild Black	<b>810-0504</b>
Touring models	'08-Up	Ace's Wild Chrome	A <b>810-0503</b>
Touring models	'08-Up	Darkside Black	B <b>810-0502</b>
Touring models	'08-Up	Darkside Chrome	<b>810-0501</b>

WINDSHIELDS / FAIRINGS

AUDIO / COMMUNICATION

SEATS / LUGGAGE

BAR / MIRRORS / CONTROLS

EXHAUST

AIR / FUEL SYSTEMS

ENGINE

TRANSMISSION / DRIVELINE

GASKETS / SEALS

ELECTRICAL

LIGHTING

CABLES

BRAKES

OIL FILTERS

SUSPENSION

**BODY**

WHEELS

TIRES / TIRE ACC.

BIKE ACC.

VICTORY / INDIAN

COVERS / LOCKS / TIEDOWNS

CHEMICALS

TOOLS

HELMETS

HELMET ACC.

EYEWEAR

APPAREL / RIDER ACC.

PROMOTIONAL

REFERENCE

INDEX



## ABS SADDLEBAGS

- Saddlebags with lids accept OEM latches and hardware
- Require minimal prep for paint
- Block off plates available for stretched versions to accommodate custom exhaust
- Stretched bags are stretched 4"



820-55401



820-55402

Description	Application	WPS#
Stretched Saddlebags w/Lids	Fits Touring Models '97-13	<b>820-55400</b>
	Fits Touring Models '14-UP	<b>820-55401</b>
Standard Saddlebags w/Lids		<b>820-55402</b>
Block Off Plate Left Side	For '14-UP Only	<b>820-55403</b>
Block Off Plate Right Side	For '14-UP Only	<b>820-55404</b>

## SADDLEBAG SPEAKER LIDS

- Perfect for upgrading existing bags to speaker lids
- Accept all OEM hardware and latch mechanisms
- For use with OEM speaker sizes but can be upgraded with adapters
- Unpainted ABS from precision molds



820-55430



820-55431

Description	Application	WPS#
Saddlebag Speaker Lids	Fit Touring Models '14-UP	<b>820-55430</b>
	Fit Touring Models '94-13	<b>820-55431</b>

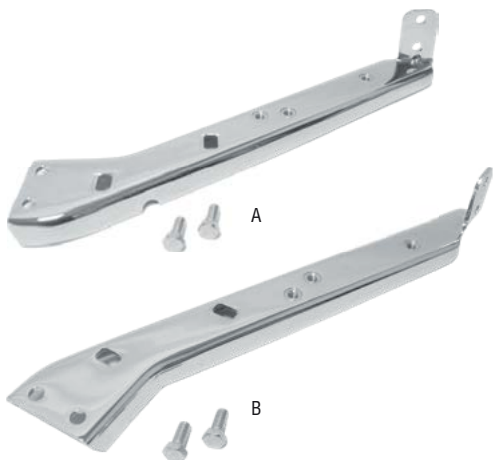

### REAR SADDLEBAG BRACKETS

- Thicker material than stock saddlebag brackets
- Chrome plated finish
- Right and left side sold separately

Description	Application	WPS#
A Saddlebag Bracket Left	'85-'08 Touring Models	<b>820-70550</b>
B Saddlebag Bracket Right		<b>820-70551</b>



### OEM STYLE LOCK SETS

- OEM style saddlebag and/or tour pack lock sets
- Keys included

Description	WPS#
Saddlebag lock set w/ key '93-13 OEM hard saddlebags	<b>820-54650</b>
Tour Pak lock set w/ key '93-13 Chopped and King tour packs	<b>820-54651</b>



### SADDLEBAG SUPPORT BRACKETS

- These new saddle bag support brackets are high quality replacements
- Chrome plated or black finish
- Sold as a set ( 1 x LH side bracket & 1 x RH side bracket)

Application	Chrome	Black
'14-Up FLHX/S and FLTRX/S (OEM# 90200549 and 9200550)	<b>820-54669</b>	<b>820-54668</b>

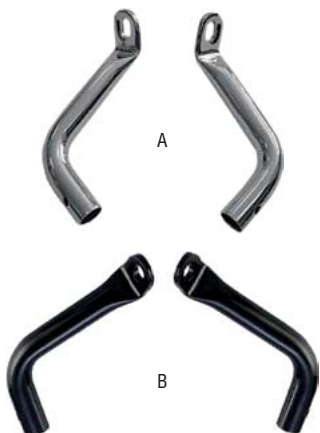

### SADDLEBAG BRACKETS

- To be used when you want to eliminate your rear highway bars and saddlebag guard rails for a clean look.
- Fit Harley FLHR Road King, FLHRC Road King Classic, FLHT Electra Glide Standard, FLHTC Electra Glide Classic & FLHTCU Electra Glide Ultra Classic models 1993 thru 2013 and FLTR Road Glide models 1998 thru 2003.
- Sold in Pairs

Application	Description	WPS#
A '93-13 Touring Models	Chrome Saddlebag Support Bracket Short (pair)	<b>866-01035</b>
B	Black Saddlebag Support Bracket Short (pair)	<b>866-01036</b>

- WINDSHIELDS / FAIRINGS
- AUDIO / COMMUNICATION
- SEATS / LUGGAGE
- BAR / MIRRORS / CONTROLS
- EXHAUST
- AIR / FUEL SYSTEMS
- ENGINE
- TRANSMISSION / DRIVELINE
- GASKETS / SEALS
- ELECTRICAL
- LIGHTING
- CABLES
- BRAKES
- OIL FILTERS
- SUSPENSION
- BODY**
- WHEELS
- TIRES / TIRE ACC.
- BIKE ACC.
- VICTORY / INDIAN
- COVERS / LOCKS / TIEDOWNS
- CHEMICALS
- TOOLS
- HELMETS
- HELMET ACC.
- EYEWEAR
- APPAREL / RIDER ACC.
- PROMOTIONAL
- REFERENCE
- INDEX



**SADDLE BAG SUPPORTS**



- Available in Show Chrome and Gloss Black
- Easy Bolt Installation
- OEM Replacement
- Works With OEM Hard Bags

Description	Application	WPS #
Chrome Saddle Bag Support Kit	85-2008 FLH/FLT Models	<b>820-54671</b>
Black Saddle Bag Support Kit	85-2008 FLH/FLT Models	<b>820-54672</b>
Chrome Saddle Bag Support Kit	97-08 FLH/FLT Models (eliminates OEM front saddle bag guard)	<b>820-54673</b>
Black Saddle Bag Support Kit	97-08 FLH/FLT Models	<b>820-54674</b>
Chrome Saddle Bag Support Kit	09-13 FLH/FLT Models Does (will not fit with saddle bag filler strips)	<b>820-54675</b>
Black Saddle Bag Support Kit	09-13 FLH/FLT Models	<b>820-54676</b>
Chrome RR Saddle Bag Guard Kit	09-13FLHX/FLTR Models	<b>820-54679</b>
Heavy Duty Saddl Bag Bumper	93-13 FLH/FLT Hard Bags	<b>820-54662</b>



820-54671



820-54672



820-54673



820-54674

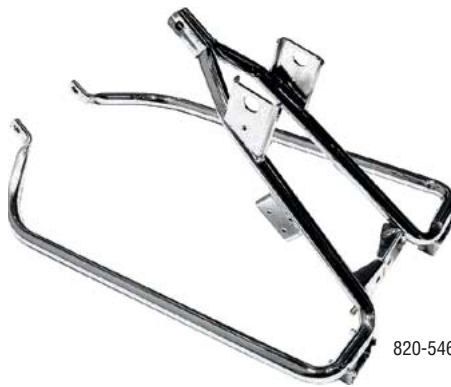

820-54675



820-54676



820-54679



820-54662

- WINDSHIELDS / FAIRINGS
- AUDIO / COMMUNICATION
- SEATS / LUGGAGE
- BARS / MIRRORS / CONTROLS
- EXHAUST
- AIR / FUEL SYSTEMS
- ENGINE
- TRANSMISSION / DRIVELINE
- GASKETS / SEALS
- ELECTRICAL
- LIGHTING
- CABLES
- BRAKES
- OIL FILTERS
- SUSPENSION
- BODY**
- WHEELS
- TIRES / TIRE ACC.
- BIKE ACC.
- VICTORY / INDIAN
- COVERS / LOCKS / TIEDOWNS
- CHEMICALS
- TOOLS
- HELMETS
- HELMET ACC.
- EYEWEAR
- APPAREL / RIDER ACC.
- PROMOTIONAL
- REFERENCE
- INDEX

## SADDLEBAG LATCH KIT



- This kit is a direct OE replacement for saddlebag lids
- Great for custom saddlebags
- Comes with all necessary tethers, hardware, seals, and hinges
- Includes a saddlebag lockset & keys
- Fits : '93-13 Touring models

Description	WPS#
Latch Kit for '93-13 Touring models w/ hardbags	<b>820-54666</b>

## SADDLEBAG LATCH ACCESSORIES

- OEM replacement parts
- '93-13 Touring Hard Bags
- Work great for custom bag replacement parts

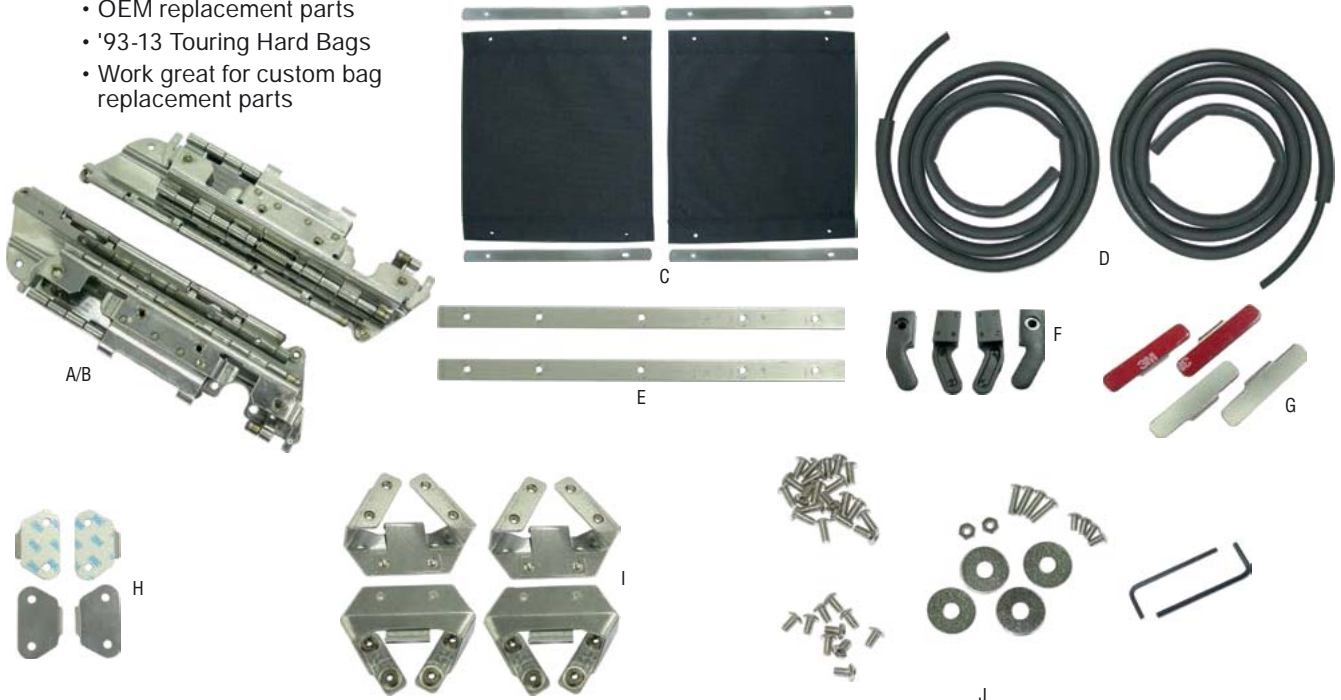

Description	OEM#	WPS#
A Right Side Latch	90665-93	<b>820-54652</b>
B Left Side Latch	90664-93	<b>820-54653</b>
Latches		<b>866-01025</b>
C Tether, Saddlebag Cover	53567-93	<b>820-54663</b>
D Saddlebag Cover Gaskets	90675-93A	<b>820-54656</b>
E Saddlebag Backing Plate	90770-93	<b>820-54654</b>
F Saddlebag Rub Bar	53482-93 and 53483-93	<b>820-54657</b>
G Saddlebag Lid Wear Plates	90972-93	<b>820-54659</b>
H Wear Plate Cover	90962-93	<b>820-54658</b>
I Saddlebag Cover Bracket	90958-93	<b>820-54655</b>
J Hardware kit for Saddlebag Latch Kit (820-54666)		<b>820-54665</b>
K Lock and Key Assembly		<b>866-01027</b>
L Bail Mount Fastener Studs	90834-85B and 6229W	<b>866-01030</b>
M Grommets	11464	<b>866-01031</b>
N Lower Cushions (set of 4)	90764-93	<b>866-01032</b>

- WINDSHIELDS / FAIRINGS
- AUDIO / COMMUNICATION
- SEATS / LUGGAGE
- BAR / MIRRORS / CONTROLS
- EXHAUST
- AIR / FUEL SYSTEMS
- ENGINE
- TRANSMISSION / DRIVELINE
- GASKETS / SEALS
- ELECTRICAL
- LIGHTING
- CABLES
- BRAKES
- OIL FILTERS
- SUSPENSION
- BODY**
- WHEELS
- TIRES / TIRE ACC.
- BIKE ACC.
- VICTORY / INDIAN
- COVERS / LOCKS / TIEDOWNS
- CHEMICALS
- TOOLS
- HELMETS
- HELMET ACC.
- EYEWEAR
- APPAREL / RIDER ACC.
- PROMOTIONAL
- REFERENCE
- INDEX

- WINDSHIELDS / FAIRINGS
- AUDIO / COMMUNICATION
- SEATS / LUGGAGE
- BARS / MIRRORS / CONTROLS
- EXHAUST
- AIR / FUEL SYSTEMS
- ENGINE
- TRANSMISSION / DRIVELINE
- GASKETS / SEALS
- ELECTRICAL
- LIGHTING
- CABLES
- BRAKES
- OIL FILTERS
- SUSPENSION
- BODY**
- WHEELS
- TIRES / TIRE ACC.
- BIKE ACC.
- VICTORY / INDIAN
- COVERS / LOCKS / TIEDOWNS
- CHEMICALS
- TOOLS
- HELMETS
- HELMET ACC.
- EYEWEAR
- APPAREL / RIDER ACC.
- PROMOTIONAL
- REFERENCE
- INDEX



## SADDLEBAG LATCH INSERTS

- CNC Machined 6061 aluminum
- Six different anodized colored options
- Machined Rooke logo
- Replaces the red reflectors on stock saddlebag latches 14-Up
- Sold in pairs
- Made in the USA



Description	Application	Finish	WPS#
Bag Latch Inserts	'14-Up Touring Models	Raw	<b>825-02000</b>
		Black	<b>825-02001</b>
		Polished	<b>825-02002</b>
		Gold	<b>825-02003</b>
		Red	<b>825-02004</b>
		Blue	<b>825-02005</b>



## SADDLEBAG LATCH COVERS

- 1-piece design
- CNC machined from solid billet aluminum
- Sold in pairs
- Includes all necessary mounting hardware



Application	Description	Chrome	Black
Fit '93-13 Touring Models w/Hard Bags	Smooth	<b>812-02030</b>	<b>812-02031</b>
	Milled	<b>812-02032</b>	<b>812-02033</b>

## SADDLEBAG LATCH INSERTS



Saddlebag latch cover Inserts for 2014-Up FLH's. These inserts replace the factory reflector and really clean up the stock latch cover. They are machined from 6061 T6 billet aluminum. They are available in a chrome plated finish and "Night Series", brilliantly black anodized, then areas are machined again for a contrast of black anodized & a raw aluminum finish. Sold in pairs.



A. Chrome



A. Black



B. Chrome



B. Black

Description	Chrome	Black
A Speed Ball Insert	811-20030	811-20031
B Velocity Insert	811-20032	811-20033

## SADDLEBAG LATCH COVERS



- CNC Machined from billet aluminum
- Available in chrome plated or black with machined accents
- Sold in pairs



A. Chrome



A. Black

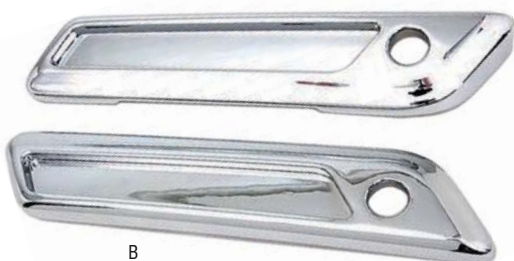

B

Description	Chrome	Black
A Machined Finish	820-55300	820-55301
B Radium Smooth Finish	820-54667	

- WINDSHIELDS / FAIRINGS
- AUDIO / COMMUNICATION
- SEATS / LUGGAGE
- BAR / MIRRORS / CONTROLS
- EXHAUST
- AIR / FUEL SYSTEMS
- ENGINE
- TRANSMISSION / DRIVELINE
- GASKETS / SEALS
- ELECTRICAL
- LIGHTING
- CABLES
- BRAKES
- OIL FILTERS
- SUSPENSION
- BODY**
- WHEELS
- TIRES / TIRE ACC.
- BIKE ACC.
- VICTORY / INDIAN
- COVERS / LOCKS / TIEDOWNS
- CHEMICALS
- TOOLS
- HELMETS
- HELMET ACC.
- EYEWEAR
- APPAREL / RIDER ACC.
- PROMOTIONAL
- REFERENCE
- INDEX

- WINDSHIELDS / FAIRINGS
- AUDIO / COMMUNICATION
- SEATS / LUGGAGE
- BAR / MIRRORS / CONTROLS
- EXHAUST
- AIR / FUEL SYSTEMS
- ENGINE
- TRANSMISSION / DRIVELINE
- GASKETS / SEALS
- ELECTRICAL
- LIGHTING
- CABLES
- BRAKES
- OIL FILTERS
- SUSPENSION
- BODY**
- WHEELS
- TIRES / TIRE ACC.
- BIKE ACC.
- VICTORY / INDIAN
- COVERS / LOCKS / TIEDOWNS
- CHEMICALS
- TOOLS
- HELMETS
- HELMET ACC.
- EYEWEAR
- APPAREL / RIDER ACC.
- PROMOTIONAL
- REFERENCE
- INDEX



## SADDLEBAG KNOBS

These saddlebag lid knurled knobs replace the OEM # 90200902 & 90200903 levers on a 2014-Up FLH. They really clean up the look of the saddle bag lid. The knobs are machined from 6061 T6 billet aluminum. Available in a chrome plated finish or black anodized with machined accents.

Application	Chrome	Black
Fit '14-Up Touring Models	<b>811-20180</b>	<b>811-20181</b>



## SADDLEBAG LATCH COVERS

These latch covers replace the boring factory cover, they have a sleek hole feature leading to the lock cylinder between two raised islands. Machined from 6061 T6 billet aluminum with a brilliant chrome plated or black anodized finish. Installs quickly with OEM hardware. (Sold in pairs.)

Description	Chrome	Black
Drilled Latch Covers	<b>811-20034</b>	<b>811-20035</b>







## BILLET BAG LATCHES



- Perfect fit design that ensures no rattling
- Retains full function of the stock latches
- Machined from billet aluminum
- Sold in pairs
- Black Anodized contrast cut finish or our two-tone chrome



A



B



C

Application	Year	Description	Chrome	Black
A Touring models w/ OE hard bags	'94-13	Ace's Wild	<b>810-0253</b>	<b>810-0254</b>
B Touring models w/ OE hard bags	'94-13	Bad Axe	<b>810-0258</b>	<b>810-0257</b>
C Touring models w/ OE hard bags	'94-13	Darkside	<b>810-0251</b>	<b>810-0252</b>



## BILLET IGNITION COVER

- Add the final touch to your bike switch with the Precision Billet ignition switch cover
- Crafted from solid 6061 Billet Aluminum
- Available in our Black Hard Anodized Contrast Cut or Show Chrome Finishes



A



B

Application	Year	Description	Chrome	Black
Touring Models (except FLHR/FLHRC)	'08-Up	A Ace's Wild Chrome	<b>810-0703</b>	<b>810-0704</b>
Touring Models (except FLHR/FLHRC)	'08-Up	B Darkside Chrome	<b>810-0701</b>	<b>810-0702</b>

- WINDSHIELDS / FAIRINGS
- AUDIO / COMMUNICATION
- SEATS / LUGGAGE
- BAR / MIRRORS / CONTROLS
- EXHAUST
- AIR / FUEL SYSTEMS
- ENGINE
- TRANSMISSION / DRIVELINE
- GASKETS / SEALS
- ELECTRICAL
- LIGHTING
- CABLES
- BRAKES
- OIL FILTERS
- SUSPENSION
- BODY**
- WHEELS
- TIRES / TIRE ACC.
- BIKE ACC.
- VICTORY / INDIAN
- COVERS / LOCKS / TIEDOWNS
- CHEMICALS
- TOOLS
- HELMETS
- HELMET ACC.
- EYEWEAR
- APPAREL / RIDER ACC.
- PROMOTIONAL
- REFERENCE
- INDEX



**CAST FENDER TIPS**

- Cast in the traditional method by hand, not just a stamped sheet like the other guys
- An economical way to add shine and a custom touch
- Installation is determined by best styling, fit and material of stock fender; depending on model, application will include countersunk outside screws or concealed screw mounts
- Many models available including 2-piece front fender kits and rear fender applications

[See page 755 for applications.](#)



**CHROME SPEEDOMETER COWL**

- No more trouble seeing instruments in bright sunlight or having the backlit readout reflect on windshields at night
- Cast metal, not stamped, with quality polished chrome
- Stylish and functional
- Secure 3M® industrial tape mounting
- Fits all standard Harley-Davidson® tank console speedometers



[See page 755 for applications.](#)

WINDSHIELDS / FAIRINGS  
 AUDIO / COMMUNICATION  
 SEATS / LUGGAGE  
 BARS / MIRRORS / CONTROLS  
 EXHAUST  
 AIR / FUEL SYSTEMS  
 ENGINE  
 TRANSMISSION / DRIVELINE  
 GASKETS / SEALS  
 ELECTRICAL  
 LIGHTING  
 CABLES  
 BRAKES  
 OIL FILTERS  
 SUSPENSION  
**BODY**  
 WHEELS  
 TIRES / TIRE ACC.  
 BIKE ACC.  
 VICTORY / INDIAN  
 COVERS / LOCKS / TIEDOWNS  
 CHEMICALS  
 TOOLS  
 HELMETS  
 HELMET ACC.  
 EYEWEAR  
 APPAREL / RIDER ACC.  
 PROMOTIONAL  
 REFERENCE  
 INDEX

**FENDER TIPS / SPEEDO COWLS**



Applications	Year	FENDER TIPS			SPEED-OMETER GLARE STOPPER
		Front Fender		Rear Fender	WPS#
		Front & RearTip	Front Tip Only	Rear Tip	
<b>HARLEY DAVIDSON</b>					
<b>XL MODELS SPORTSTERS</b>					
XL1200L Sportster Low	'06-11	<b>562-30147</b>			
XL883L Sportster low	'05-10	<b>562-30147</b>			
XL1200C/XL883C Sportster Custom	'04-10	<b>562-30147</b>			
XL1200R/XL883R Sportster	'02-13	<b>562-30147</b>			
XL1200N Nightster	'07-12	<b>562-30147</b>			
XL1200V Sportster	'12-14	<b>562-30147</b>			
XL883N IRON 883	'09-14	<b>562-30147</b>			
<b>FX MODELS DYNA / GLIDE</b>					
FXDWG Dyna Wide Glide	'93-08				<b>562-30320</b>
FXDF Dyna Fat Bob	'08-14				<b>562-30320</b>
FXDC Dyna Super Glide Custom	'10-14				<b>562-30320</b>
FXWG Wide Glide	'80-85	<b>562-30147</b>			
FXDG Disc Glide	'83	<b>562-30147</b>			
<b>FX MODELS SOFTAILS</b>					
FXST/FXSTI Softail Standard	'84-90	<b>562-30147</b>			<b>562-30320</b>
FXST/FXSTI Softail Standard	'99-05	<b>562-30147</b>			<b>562-30320</b>
FXST/FXSTI Softail Standard	'06-12	<b>562-30147</b>		<b>562-30145</b>	<b>562-30320</b>
FXSTC Softail Custom	'07-10	<b>562-30147</b>		<b>562-30145</b>	<b>562-30320</b>
FXSTC Softail Custom	'87-99	<b>562-30147</b>			<b>562-30320</b>
FXSTD/FXSTDI Deuce	'00-07	<b>562-30147</b>			<b>562-30320</b>
FXSTB/FXSTBI Night Train	'06-09	<b>562-30147</b>		<b>562-30145</b>	<b>562-30320</b>
FXSTB/FXSTBI Night Train	'99-05	<b>562-30147</b>			<b>562-30320</b>
FXSTS Springer	'89-06	<b>562-30147</b>			<b>562-30320</b>
FXSTSB Bad Boy	'95-97	<b>562-30147</b>			<b>562-30320</b>
FXSTC Custom	'87-99	<b>562-30147</b>			<b>562-30320</b>
<b>FL MODELS DUO / ELECTRA</b>					
FLHX STREET GLIDE	'06-13	<b>562-30149</b>			
FLTR/FLTRU/FLTRX/FLTRUSE ROAD GLIDE	'00-13	<b>562-30149</b>			
FLTR ROAD GLIDE	'02-08			<b>562-30150</b>	
<b>FL MODELS ROAD KINGS</b>					
FLHR/I Road King	'94-08				<b>562-30320</b>
FLHR/I Road King	'09-14				<b>562-30320</b>
FLHRS/I Road King Custom	'04-07	<b>562-30149</b>		<b>562-30150</b>	<b>562-30320</b>
FLHRC/I Road King Classic	'09-13				<b>562-30320</b>
FLHRC/I Road King Classic	'96-08				<b>562-30320</b>
<b>FL MODEL DYNA</b>					
FLD Switchback	'12-13				<b>562-30320</b>
<b>FL MODELS SOFTAILS</b>					
FLSTFI Fat Boy	'07-11	<b>562-30143</b>		<b>562-30148</b>	<b>562-30320</b>
FLSTFI Fat Boy	'12-13	<b>562-30143</b>		<b>562-30148</b>	<b>562-30320</b>
FLSTFB FATBOY LO/Special	'10-13	<b>562-30143</b>		<b>562-30148</b>	<b>562-30320</b>
FLSTF Fat Boy	'01-06	<b>562-30143</b>		<b>562-30144</b>	<b>562-30320</b>
FLSTF Fat Boy	'90-00		<b>562-30140</b>	<b>562-30141</b>	<b>562-30320</b>
FLSTC Heritage Softail Classic	'87-13				<b>562-30320</b>
FLSTS Heritage Springer	'97-05			<b>562-30141</b>	<b>562-30320</b>
FLSTSC Heritage Springer Classic	'05-07				<b>562-30320</b>
FLSTN/I Softail Deluxe	'05-13				<b>562-30320</b>
FLSTN(H) Heritage Softail Special	'94-96				<b>562-30320</b>
FLSTN Heritage Softail Nostalgia	'93				<b>562-30320</b>

- WINDSHIELDS / FAIRINGS
- AUDIO / COMMUNICATION
- SEATS / LUGGAGE
- BARS / MIRRORS / CONTROLS
- EXHAUST
- AIR / FUEL SYSTEMS
- ENGINE
- TRANSMISSION / DRIVELINE
- GASKETS / SEALS
- ELECTRICAL
- LIGHTING
- CABLES
- BRAKES
- OIL FILTERS
- SUSPENSION
- BODY**
- WHEELS
- TIRES / TIRE ACC.
- BIKE ACC.
- VICTORY / INDIAN
- COVERS / LOCKS / TIEDOWNS
- CHEMICALS
- TOOLS
- HELMETS
- HELMET ACC.
- EYEWEAR
- APPAREL / RIDER ACC.
- PROMOTIONAL
- REFERENCE
- INDEX



## AXLE NUT COVERS

- Cover up those stock axle nuts with a matching look and custom set of axle nut cover
- Avon now offers axle nut caps to match their most popular grip and peg ends
- The small details on your bike matter, axle nut covers by Avon make the difference
- They are available in anodized black or chrome
- Fits all models: 7/8" or 1" axle nuts



Spike



Application / Description	Black	Chrome
<b>ALL MODELS (EXCEPT 08-UP TOURING AND DYNA) WITH 3/4" AXLE</b>		
Spike	<b>40-4805BK</b>	<b>40-4805C</b>
<b>ALL 08-UP TOURING AND DYNA MODELS 1" AXLE</b>		
Spike	<b>40-4802BK</b>	<b>40-4802C</b>
Excalibur	<b>40-4806BK</b>	<b>40-4806C</b>
Gatlin	<b>40-4807BK</b>	<b>40-4807C</b>
Rival	<b>40-4808BK</b>	<b>40-4808C</b>



Excalibur



Gatlin



Rival





### AXLE COVERS

- Harddrive axle covers give your bike a custom look and clean finish
- Deep polished chrome finish
- Sold in pairs

Description	Application	WPS Part#
Chrome Billet	Front '08-Up Dyna, Softail and Touring Models	<b>820-2360</b>



### REAR AXLE COVERS

- HardDrive rear axle covers add a clean custom look
- Easy to install
- Sold in pairs

Description	WPS Part #
Rear Axle Chrome Die Cast, fits 00-UP Softail (except FXLSTS/FLSTSC, will not fit w/saddlebags)	<b>820-2362</b>

### REAR SPROCKET BOLT COVERS



Description	Color	Application	WPS#
A Rear Sprocket Bolt cover with internal spring clips	Chrome	'93-Up Softail; 99-Up Touring (except Trike); '04-Up XL	<b>820-0560C</b>
B Rear Sprocket Bolt cover with internal spring clips	Black	'93-Up Softail; 99-Up Touring (except Trike); '04-Up XL	<b>820-0560B</b>

### SWINGARM PIVOT BOLT COVERS

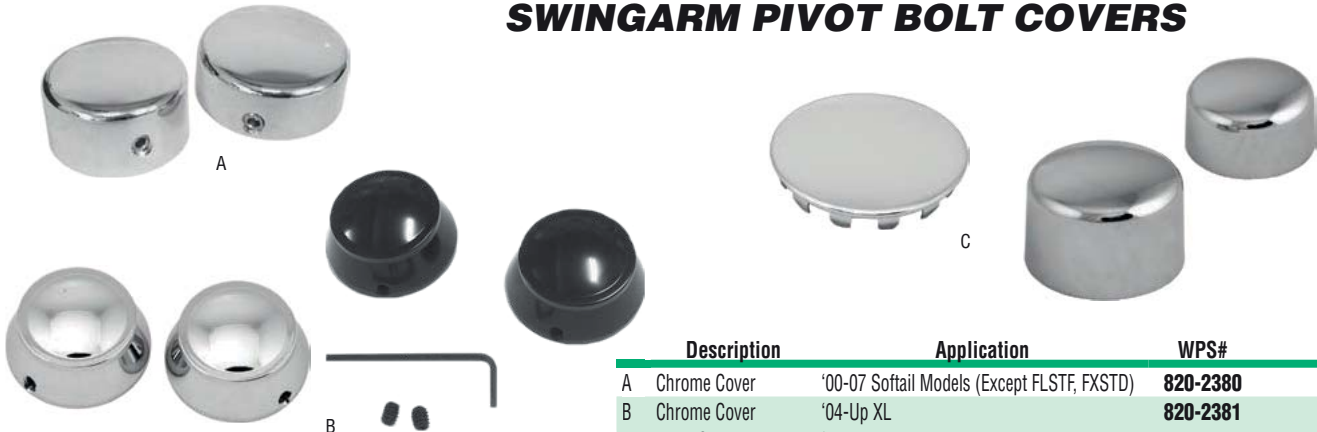

Description	Application	WPS#
A Chrome Cover	'00-07 Softail Models (Except FLSTF, FXSTD)	<b>820-2380</b>
B Chrome Cover	'04-Up XL	<b>820-2381</b>
Black Cover	'04-Up XL	<b>820-50940</b>
C Chrome Plug	'06-11 Dyna	<b>820-2382</b>
Chrome Cover	'08-17 Dyna and Softail (except FXCW)	<b>820-2361</b>

- WINDSHIELDS / FAIRINGS
- AUDIO / COMMUNICATION
- SEATS / LUGGAGE
- BARS / MIRRORS / CONTROLS
- EXHAUST
- AIR / FUEL SYSTEMS
- ENGINE
- TRANSMISSION / DRIVELINE
- GASKETS / SEALS
- ELECTRICAL
- LIGHTING
- CABLES
- BRAKES
- OIL FILTERS
- SUSPENSION
- BODY**
- WHEELS
- TIRES / TIRE ACC.
- BIKE ACC.
- VICTORY / INDIAN
- COVERS / LOCKS / TIEDOWNS
- CHEMICALS
- TOOLS
- HELMETS
- HELMET ACC.
- EYEWEAR
- APPAREL / RIDER ACC.
- PROMOTIONAL
- REFERENCE
- INDEX

- WINDSHIELDS / FAIRINGS
- AUDIO / COMMUNICATION
- SEATS / LUGGAGE
- BARS / MIRRORS / CONTROLS
- EXHAUST
- AIR / FUEL SYSTEMS
- ENGINE
- TRANSMISSION / DRIVELINE
- GASKETS / SEALS
- ELECTRICAL
- LIGHTING
- CABLES
- BRAKES
- OIL FILTERS
- SUSPENSION
- BODY**
- WHEELS
- TIRES / TIRE ACC.
- BIKE ACC.
- VICTORY / INDIAN
- COVERS / LOCKS / TIEDOWNS
- CHEMICALS
- TOOLS
- HELMETS
- HELMET ACC.
- EYEWEAR
- APPAREL / RIDER ACC.
- PROMOTIONAL
- REFERENCE
- INDEX



## FRONT AXLE NUT COVERS

- CNC Machined 6061 aluminum
- Six different anodized colored options
- Covers OEM axle nut
- Sold in pairs
- Made in the USA



Raw



Black

Polished

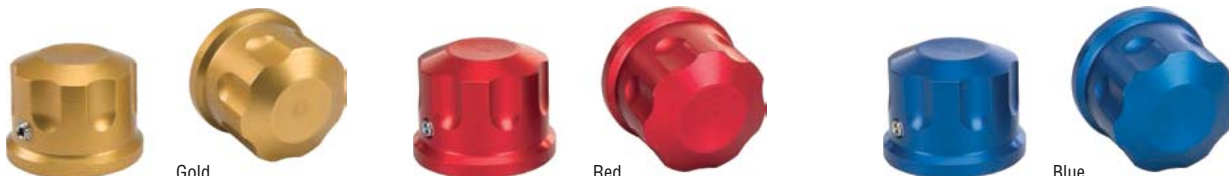

Gold

Red

Blue

Description	Application	Raw	Black	Polished	Gold	Red	Blue
Front Axle Covers	FLH/FLT '00-07	<b>825-02240</b>	<b>825-02241</b>	<b>825-02242</b>			
	FLH/FLT '08-Up	<b>825-02243</b>	<b>825-02244</b>	<b>825-02245</b>	<b>825-02246</b>	<b>825-02247</b>	<b>825-02248</b>



## SWINGARM BEARING KITS

- Contains all of the bearings required to rebuild a swing arm to factory specs.
- Manufactured from 52100 bearing steel for improved performance and extended life

Application	WPS#
<b>HARLEY DAVIDSON</b>	
Big Twin (Except Softail & Dyna)	'58-85 <b>22-81111</b>
Big Twin Softail	'84-99 <b>22-81095</b>
	'00-08 <b>22-81139</b>
FLT FLH	'02-up <b>22-81204</b>



## SWINGARM BUSHING

Application	WPS#
Fits FXD '91-17 (Repl. OEM 47624-90A)	<b>820-53310</b>



## SWINGARM ISOLATOR MOUNT

- Meets or exceeds OEM specifications
- Sold each

Application	WPS#
'86-08 Touring and '86-94 FXR models (Repl. OEM 47564-86)	<b>820-5383</b>





## FXR TRACKER SWINGARM

Custom Design Studio's FXR Tracker swingarm takes the flex out of the rear end of your FXR. By adding a lower brace to stiffen the construction of the otherwise stock looking swingarm you retain the classic look of the bike but add a visual and functional upgrade. We recommend the use of Paughco's spherical bearing upgrade kit to further upgrade the stability.



Description	WPS#
Tracker FXR Swingarm	825-06000



## SPHERICAL BEARING SWINGARM CONVERSION KIT

Specially-designed to upgrade the quality and feel of the driveline on your FXR or Touring model bike. These 7-piece kits convert the old-style Original Equipment parts to high-tech spherical bearings with CNC-machined precision spacers and collars.



Description	Application	WPS#
Spherical Bearing Conversion Kit	FXR/FLT '80-01	830-4020

- WINDSHIELDS / FAIRINGS
- AUDIO / COMMUNICATION
- SEATS / LUGGAGE
- BAR / MIRRORS / CONTROLS
- EXHAUST
- AIR / FUEL SYSTEMS
- ENGINE
- TRANSMISSION / DRIVELINE
- GASKETS / SEALS
- ELECTRICAL
- LIGHTING
- CABLES
- BRAKES
- OIL FILTERS
- SUSPENSION
- BODY**
- WHEELS
- TIRES / TIRE ACC.
- BIKE ACC.
- VICTORY / INDIAN
- COVERS / LOCKS / TIEDOWNS
- CHEMICALS
- TOOLS
- HELMETS
- HELMET ACC.
- EYEWEAR
- APPAREL / RIDER ACC.
- PROMOTIONAL
- REFERENCE
- INDEX

- WINDSHIELDS / FAIRINGS
- AUDIO / COMMUNICATION
- SEATS / LUGGAGE
- BAR / MIRRORS / CONTROLS
- EXHAUST
- AIR / FUEL SYSTEMS
- ENGINE
- TRANSMISSION / DRIVELINE
- GASKETS / SEALS
- ELECTRICAL
- LIGHTING
- CABLES
- BRAKES
- OIL FILTERS
- SUSPENSION
- BODY**
- WHEELS
- TIRES / TIRE ACC.
- BIKE ACC.
- VICTORY / INDIAN
- COVERS / LOCKS / TIEDOWNS
- CHEMICALS
- TOOLS
- HELMETS
- HELMET ACC.
- EYEWEAR
- APPAREL / RIDER ACC.
- PROMOTIONAL
- REFERENCE
- INDEX



## RIGID FRAMES

Standard width rigid frames. They can be combined with a variety of drivetrains, including Shovelhead and Evolution engines, and most transmission combinations. Straight Leg or the timeless Wishbone frame styles with OEM-style necks, with or without tank mounts for pre-1984 Fat Bob gas tanks. These frames are not stock replacement frames, we recommend pre-fitting parts before painting.

All frames have 0° stretch up and out, neck rake is 30°

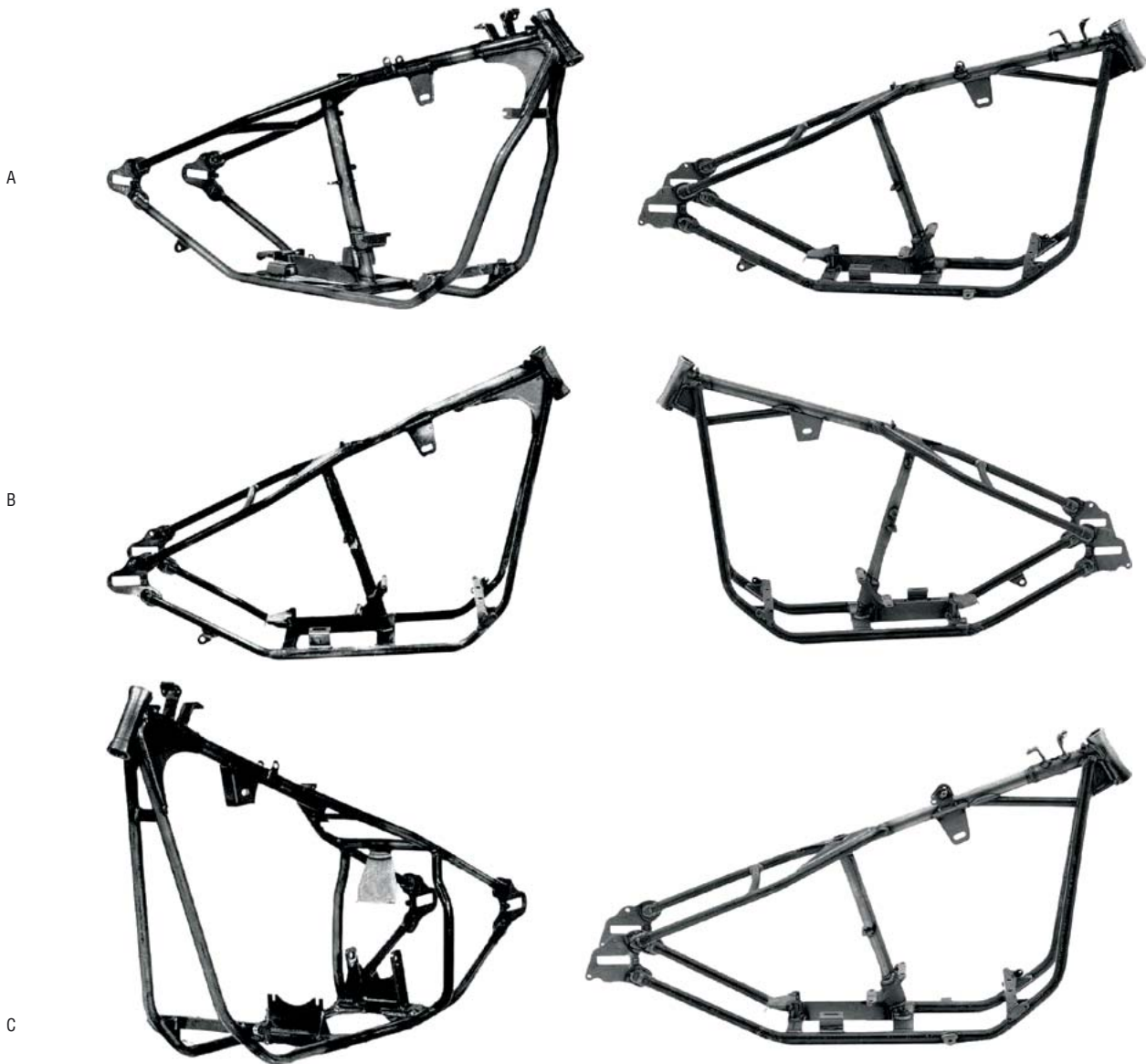

	Description	Application	WPS #
	Wishbone Frame	Without Fat Bob Tank Mounts	<b>830-4000</b>
A		With Fat Bob Tank Mounts	<b>830-4001</b>
B	Straight Leg Frame	Without Fat Bob Tank Mounts	<b>830-4002</b>
C		With Fat Bob Tank Mounts	<b>830-4003</b>
	Rigid Frame Axle		<b>830-4025</b>





## OIL TANKS



A. 830-3700 - when used with an FXE battery, will fit rigid and 1958–1964 swingarm frames, and will also clear 1979–up 4-speed transmissions. The tanks measure 55/8”-tall x 85/8”-deep x 12 1/4”-wide, and the battery compartment is 7 1/2”-wide x 51/8”-deep.



B. 830-3701 - for 1965–1986 FL and FX 4-speed models, that provide easy access to the battery, and bolt to the stock mounts. Each tank includes a two-piece front bracket for easy installation, and measures 59/16”-tall x 7 1/2”-deep x 12”-wide. The battery compartment is 73/8”-wide x 41/8”-deep.

C. Both tanks require the purchase of drain plug 830-3702. Oil tanks come with filler plug and fittings as shown.



	Description	Application	WPS #
A	3.5 Qt Custom Oil Tank	Fits '65-86 FL/FX 4-Spd Frames	<b>830-3700</b>
B	3.5 Qt Wrap Around Oil Tank	Fits rigid and '58-64 Swingarm Frames	<b>830-3701</b>
C	Oil Tank Drain Plug		<b>830-3702</b>



## OIL LINE FITTINGS

Description	WPS#
Straight 1/8” NPT Fittings for 3/8” Hose (pr)	<b>820-53400</b>
90 Degree Elbow 1/8” NPT x 1/8” NPT Female (5pk)	<b>820-53401</b>

- WINDSHIELDS / FAIRINGS
- AUDIO / COMMUNICATION
- SEATS / LUGGAGE
- BARS / MIRRORS / CONTROLS
- EXHAUST
- AIR / FUEL SYSTEMS
- ENGINE
- TRANSMISSION / DRIVELINE
- GASKETS / SEALS
- ELECTRICAL
- LIGHTING
- CABLES
- BRAKES
- OIL FILTERS
- SUSPENSION
- BODY**
- WHEELS
- TIRES / TIRE ACC.
- BIKE ACC.
- VICTORY / INDIAN
- COVERS / LOCKS / TIEDOWNS
- CHEMICALS
- TOOLS
- HELMETS
- HELMET ACC.
- EYEWEAR
- APPAREL / RIDER ACC.
- PROMOTIONAL
- REFERENCE
- INDEX

- WINDSHIELDS / FAIRINGS
- AUDIO / COMMUNICATION
- SEATS / LUGGAGE
- BARS / MIRRORS / CONTROLS
- EXHAUST
- AIR / FUEL SYSTEMS
- ENGINE
- TRANSMISSION / DRIVELINE
- GASKETS / SEALS
- ELECTRICAL
- LIGHTING
- CABLES
- BRAKES
- OIL FILTERS
- SUSPENSION
- BODY**
- WHEELS
- TIRES / TIRE ACC.
- BIKE ACC.
- VICTORY / INDIAN
- COVERS / LOCKS / TIEDOWNS
- CHEMICALS
- TOOLS
- HELMETS
- HELMET ACC.
- EYEWEAR
- APPAREL / RIDER ACC.
- PROMOTIONAL
- REFERENCE
- INDEX



## UNIVERSAL HARDTAIL KIT

TC Bros. Choppers USA Made Universal Hardtail Kit. The CNC Mandrel Bent Tubing is 1 1/8" Diameter Steel with .120 (about 1/8" wall thickness. The axle plates are CNC laser cut from 3/8" thick steel and have an integrated mounting tab for easy fender mounting. The axle slots are 20mm (.787"). In addition to the cross tubes offered, we also include solid cold rolled steel slugs that fit tightly into the inner diameter of the tubing for joining the hard tail to the stock frame tubes. You can determine stretch, ground clearance, width, etc. Fitment possibilities are nearly endless. Remember that since this kit is universal, you will be responsible for modifying your frame and making this kit fit and function properly. All modification is done at your own risk.

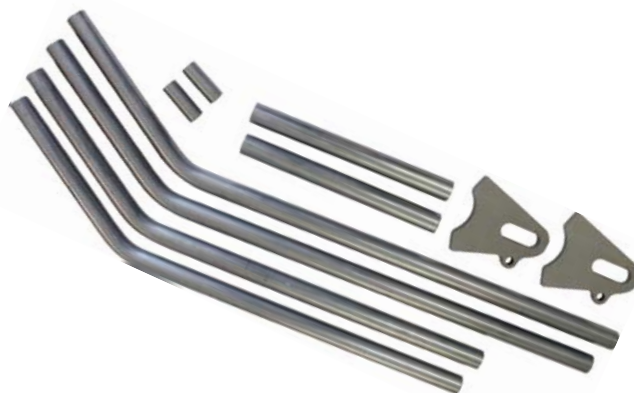

Description	WPS#
Universal Weld-on Hardtail Kit	<b>563-01810</b>

## ELECTRONICS BOX

TC Bros. Choppers USA Made Custom Chopper/Bobber Battery Box and electronics box that looks like a round oil tank. The electronics box is 4.5" diameter and has removable caps for hiding all of your wiring and ignition components while still having access to them. Mounts are already TIG welded in for you and mounting bolts are included. Kit is raw finish steel and ready to paint. Mounting straps for both the battery box and electronics box are included and ready to bolt or weld on. Battery box fits a 12N14 type battery perfectly. Can fit many models and applications! Battery Box dimensions: 4-1/4" W, 5-1/2" H and 5-7/8" L. Electronics Tank(fake oil tank) dimensions: 4 1/2" diameter x 8" long with caps installed.



Description	WPS#
A Electronics Tank	<b>563-01800</b>
B Battery Box/Electronics Tank	<b>563-01801</b>

## BATTERY HOLEY BOX

TC Bros. Holey battery boxes come in two sizes for YTX14AH, 12N14 or YTX20, YB16 series batteries. Inside dimensions of small battery box are 3.75in wide x 5.5in long. Inside dimensions of large battery box are 4in wide x 7in long. Proudly made in the USA! Includes stainless mounting hardware and rubber cushion to isolate battery from vibration.



Description	WPS#
A Battery Box Small	<b>563-01820</b>
B Battery Box Large	<b>563-01821</b>

# RUBBER MOUNTING TABS



563-02011



563-02012



563-02013

- TC Bros. Choppers universal fit, weld-on rubber mounting tabs are CNC laser cut from 1/4" thick American made mild steel for easy welding.
- The CNC machined, 6061 aluminum tophat style spacer and military spec rubber grommet perform under the most demanding rigid frame applications. Included 5/16"-18 x 1" stainless steel button head mounting bolt looks great and is very corrosion resistant.
- These tabs save you a lot of time on your build and provide you with professional quality results. Perfect for mounting oil tanks, gas tanks, or any other component that can be easily damaged by excessive vibration. Sold individually.
- Proudly made in the USA.

Description	WPS#
Straight Rubber Mounting Tab	<b>563-02011</b>
Triangular Rubber Mounting Tab	<b>563-02012</b>
Tank Mounting Kit	<b>563-02013</b>

# TOPHAT & COUNTERBORE STYLE BUNGS



563-02031



563-02032



563-02033



563-02034

- Save time and create a super strong mount for just about anything on your bike using these bungs. Proudly made in the USA from premium American 1018 cold rolled steel for easy welding. Counterbored bungs fit standard socket head bolts so that the head of the bolt is flush inside the bung for a clean looking installation. Pair these bungs with any of our matching threaded bungs and you have a professional quality mounting solution.
- Tophat style blind threaded hole bungs are perfect for mounting gas tanks, oil tanks, or any other item requiring a leak free mount. These bungs install easily by inserting into a hole and welding around the flange. See photos for all dimensions.

Description	QTY	WPS#
Counterbored Bungs for 5/16 Socket Head Bolts	4 pk	<b>563-02031</b>
Counterbored Bungs for 3/8 Socket Head Bolts	4 pk	<b>563-02032</b>
Tophat Blind Threaded Bungs 5/16-18	4 pk	<b>563-02033</b>
Tophat Blind Threaded Bungs 3/8-16	4 pk	<b>563-02034</b>

- WINDSHIELDS / FAIRINGS
- AUDIO / COMMUNICATION
- SEATS / LUGGAGE
- BARS / MIRRORS / CONTROLS
- EXHAUST
- AIR / FUEL SYSTEMS
- ENGINE
- TRANSMISSION / DRIVELINE
- GASKETS / SEALS
- ELECTRICAL
- LIGHTING
- CABLES
- BRAKES
- OIL FILTERS
- SUSPENSION
- BODY**
- WHEELS
- TIRES / TIRE ACC.
- BIKE ACC.
- VICTORY / INDIAN
- COVERS / LOCKS / TIEDOWNS
- CHEMICALS
- TOOLS
- HELMETS
- HELMET ACC.
- EYEWEAR
- APPAREL / RIDER ACC.
- PROMOTIONAL
- REFERENCE
- INDEX



## STRAIGHT & COPED THREADED BUNGS

Save time and create a super strong mount for just about anything on your bike using these fully threaded coped and straight bungs. Proudly made in the USA from premium American 1018 cold rolled steel for easy welding.

563-02037

563-02043

563-02038

563-02044

563-02039

563-02045

563-02040

563-02046

563-02041

563-02047

563-02042

563-02048

Description	Straight Bungs	Coped Bungs
Threaded Bungs 5/16-18 Length 1/2"	<b>563-02037</b>	<b>563-02043</b>
Threaded Bungs 3/8-16 Length 1/2"	<b>563-02038</b>	<b>563-02044</b>
Threaded Bungs 5/16-18 Length 1"	<b>563-02039</b>	<b>563-02045</b>
Threaded Bungs 3/8-16 Length 1"	<b>563-02040</b>	<b>563-02046</b>
Threaded Bungs 5/16-18 Length 1-1/2"	<b>563-02041</b>	<b>563-02047</b>
Threaded Bungs 3/8-16 Length 1-1/2"	<b>563-02042</b>	<b>563-02048</b>

# RISERLESS HANDLEBAR BUNGS

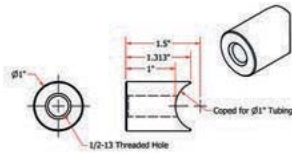

563-02050

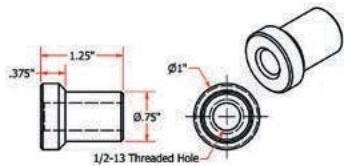

563-02051

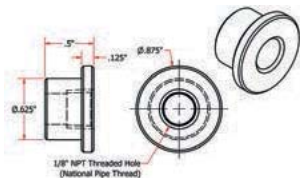

563-02052

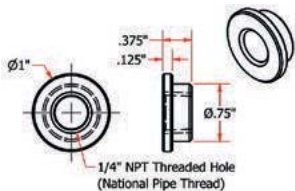

563-02053

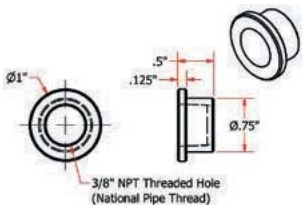

563-02049

- 'Knurled' For Extra Grip
- Leak Free O-Ring Seal
- 100% Made In USA



563-02065



563-02066

- These bungs are perfect for building custom riserless handlebars. Proudly made in the USA from premium American 1018 cold rolled steel for easy welding.
- The internal riser bungs are designed to fit inside 1" outer diameter steel tubing with a maximum wall thickness of .120" (11 gauge). A machined chamfer allows for proper weld penetration. The 1" diameter is a perfect match to your tubing and the 1-1/4" overall length allows for sufficient thread engagement. The coped end bungs fit perfectly to 1" diameter tubing and the 1" length from edge of cope to flat face provides 1" of rise once welded to your handlebar.
- These bungs feature 1/2-13 internal threads for mounting to Harley Davidson® style triple trees. Your handlebar mounting bolts pass through the bottom of the triple trees and thread into these bungs for a much cleaner installation as compared to traditional clamp style risers. See photos for all dimensions.

Description	QTY	WPS#
Coped Handlebar Riser Bungs	Pair	<b>563-02050</b>
Internal Riser Bungs	Pair	<b>563-02051</b>

## NPT PETCOCK BUNGS

These NPT (National Pipe Thread) bungs are most commonly used for gas tank petcock bungs or for oil tank fittings. Proudly made in the USA from premium American 1018 cold rolled steel for easy welding. Note: NPT threads are tapered. They are only designed to be used with corresponding NPT threaded fittings or pipe. The tapered design allows the threads to create a leak proof seal when tightened. They are not to be used with standard bolts or hardware. These bungs install easily by inserting into a 3/4" diameter hole and welding around the 1" diameter flange. See photos for all dimensions.

Description	QTY	WPS#
1/8" NPT Weld In Bungs	Pair	<b>563-02052</b>
1/4" NPT Weld In Bungs	Pair	<b>563-02053</b>
3/8" NPT Weld In Bungs	Pair	<b>563-02049</b>

## VENTED OIL/FUEL TANK CAPS

These caps are the perfect finishing touch when building a custom oil or gas tank for your chopper. Easy to weld 1018 mild steel bung features a 1 5/16" x 12 thread and comes with CNC machined billet aluminum cap (vented).

Description	QTY	WPS#
Fill cap	Each	<b>563-02065</b>
Fill cap w/bung	Each	<b>563-02066</b>

- WINDSHIELDS / FAIRINGS
- AUDIO / COMMUNICATION
- SEATS / LUGGAGE
- BAR / MIRRORS / CONTROLS
- EXHAUST
- AIR / FUEL SYSTEMS
- ENGINE
- TRANSMISSION / DRIVELINE
- GASKETS / SEALS
- ELECTRICAL
- LIGHTING
- CABLES
- BRAKES
- OIL FILTERS
- SUSPENSION
- BODY**
- WHEELS
- TIRES / TIRE ACC.
- BIKE ACC.
- VICTORY / INDIAN
- COVERS / LOCKS / TIEDOWNS
- CHEMICALS
- TOOLS
- HELMETS
- HELMET ACC.
- EYEWEAR
- APPAREL / RIDER ACC.
- PROMOTIONAL
- REFERENCE
- INDEX

- WINDSHIELDS / FAIRINGS
- AUDIO / COMMUNICATION
- SEATS / LUGGAGE
- BAR / MIRRORS / CONTROLS
- EXHAUST
- AIR / FUEL SYSTEMS
- ENGINE
- TRANSMISSION / DRIVELINE
- GASKETS / SEALS
- ELECTRICAL
- LIGHTING
- CABLES
- BRAKES
- OIL FILTERS
- SUSPENSION
- BODY**
- WHEELS
- TIRES / TIRE ACC.
- BIKE ACC.
- VICTORY / INDIAN
- COVERS / LOCKS / TIEDOWNS
- CHEMICALS
- TOOLS
- HELMETS
- HELMET ACC.
- EYEWEAR
- APPAREL / RIDER ACC.
- PROMOTIONAL
- REFERENCE
- INDEX



## RADIUS BUNGS



Radius Style Threaded 3/8-16 Short Length Steel Bungs by TC Bros. Save time and create professional quality mounts using these blind threaded radius bungs. Perfect for mounting fenders or anything where a clean, finished appearance is desired. Proudly made in the USA from premium American 1018 cold rolled steel for easy welding. 3/4" diameter x 1-1/4" long.

Description	QTY	WPS#
3/8-16 Radius Short Threaded Bungs	4 pk	<b>563-02000</b>
5/16-18 Radius Short Threaded Bungs	4 pk	<b>563-02035</b>
3/8-16 Radius Long Threaded Bungs	4 pk	<b>563-02036</b>
5/16-18 Radius Long Threaded Bungs	4 pk	<b>563-02054</b>

## WELD ON MOUNTING TABS

TC Bros. Universal Mounting Tabs are CNC laser cut from 1/4" thick American made mild steel for easy welding. Heavy duty design performs under the most demanding rigid frame applications. Save yourself a lot of time on your build by using these tabs to mount almost anything. Proudly made in the USA.

Description	QTY	WPS#
A Mounting Tab Style 1	4 pk	<b>563-02001</b>
B Mounting Tab Style 2	4 pk	<b>563-02002</b>
C Mounting Tab Style 3	4 pk	<b>563-02003</b>
D Mounting Tab Style 4	4 pk	<b>563-02004</b>
E Mounting Tab Style 5	4 pk	<b>563-02005</b>
F Vintage Style Mounting Tab Style 6	4 pk	<b>563-02006</b>
G Vintage Style Mounting Tab Style 7	4 pk	<b>563-02007</b>
H Vintage Style Mounting Tab Style 8	4 pk	<b>563-02008</b>
I Vintage Style Mounting Tab Style 9	4 pk	<b>563-02009</b>
J Vintage Style Mounting Tab Style 10	4 pk	<b>563-02010</b>

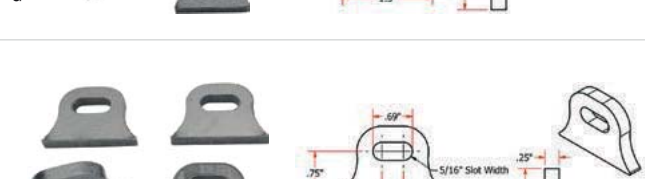
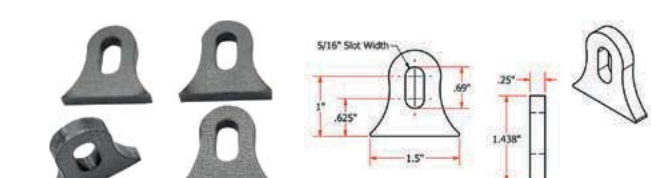
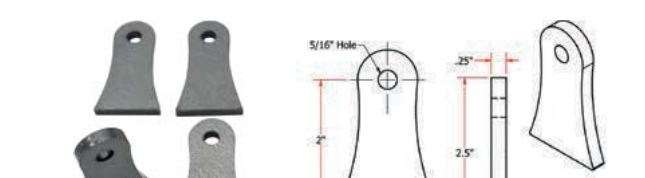
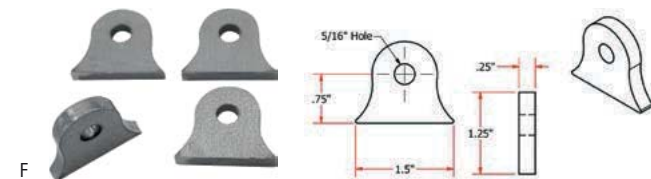
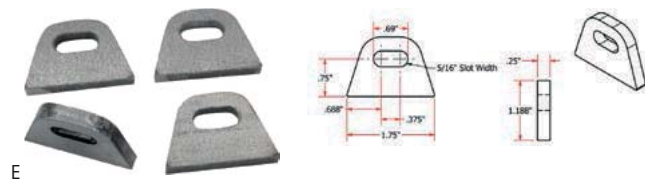
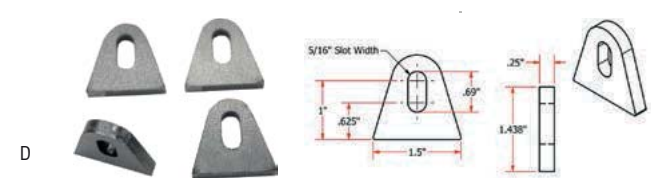
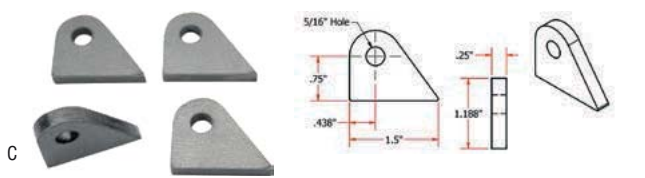
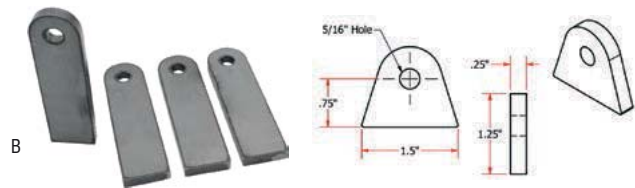
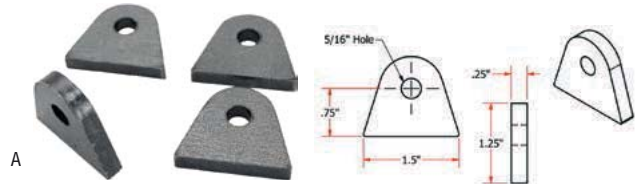

Coped for  $\phi 1.125$ " Tubing  
Easy fit to 1" and 1.25" Diameter



## WELD ON BRAKE STAY

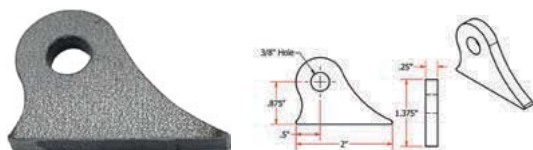

TC Bros. Choppers universal fit, weld-on brake stay mounting tabs are CNC laser cut from 1/4" thick American made mild steel for easy welding. Vintage style curves and contours provide eye appeal while the 3/8" diameter hole makes for easy attachment of your brake anchor rod end.

Description	QTY	WPS#
Brake Stay	Each	563-02014

## IGNITION SWITCH TABS

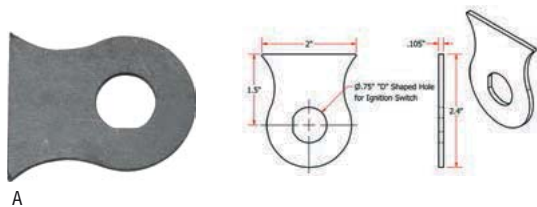

A

TC Bros. Choppers universal fit, ignition switch mounting tabs are CNC laser cut from 12 gauge (.105" thick) American made mild steel. Vintage style curves and contours provide eye appeal while saving you serious time on your build. Most ignition switches require a "D" shaped installation hole to prevent rotation while turning the key. These tabs have the proper shaped hole to fit most ignition switches with 3/4" or 13/16" diameter threads. The bolt-on ignition switch mounting tabs come with a durable black powdercoat finish.

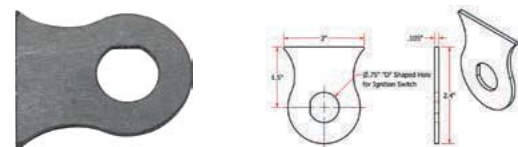

B

Description	WPS#
A 3/4" Ignition Switch Mounting Tab, Weld On	563-02020
B 13/16" Ignition Switch Mounting Tab, Weld On	563-02021
C 3/4" Ignition Switch Mounting Tab, Bolt On	563-02022
D 13/16" Ignition Switch Mounting Tab, Bolt On	563-02023

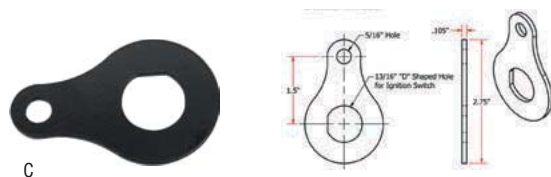

C

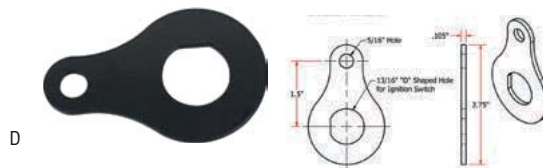

D

## WELD ON REAR FENDER MOUNT

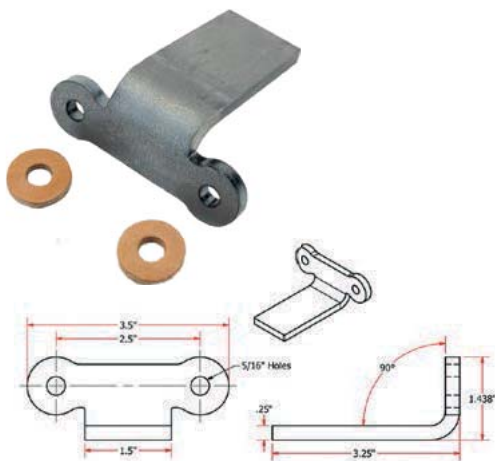

TC Bros. Choppers universal fit, weld-on fender mounting bracket is constructed from a single piece of 1/4" thick American made mild steel for easy welding. Vintage style curves and contours provide eye appeal while the 5/16" diameter mounting holes make for a simple installation. Leather washers are provided to prevent paint damage and provide vibration resistance. This fender bracket is most commonly used to mount flat profile fenders (4.5" minimum width) to a frame cross member. The straight portion of the bracket is easily trimmed to length to fit your application.

Description	QTY	WPS#
Weld On Rear Fender Mount	Each	563-02030

## AXLE PLATES



TC Bros. Universal hardtail axle plates with 3/4" or 1" slots. They are cut from 3/8" thick steel and have an integrated fender mounting tab. Perfect for people building hardtails who have access to tubing, but can't get axle plates made.

Description	QTY	WPS#
3/4" Axle Plates	Pair	563-02060
1" Axle Plates	Pair	563-02061

- WINDSHIELDS / FAIRINGS
- AUDIO / COMMUNICATION
- SEATS / LUGGAGE
- BARS / MIRRORS / CONTROLS
- EXHAUST
- AIR / FUEL SYSTEMS
- ENGINE
- TRANSMISSION / DRIVELINE
- GASKETS / SEALS
- ELECTRICAL
- LIGHTING
- CABLES
- BRAKES
- OIL FILTERS
- SUSPENSION
- BODY**
- WHEELS
- TIRES / TIRE ACC.
- BIKE ACC.
- VICTORY / INDIAN
- COVERS / LOCKS / TIEDOWNS
- CHEMICALS
- TOOLS
- HELMETS
- HELMET ACC.
- EYEWEAR
- APPAREL / RIDER ACC.
- PROMOTIONAL
- REFERENCE
- INDEX



## RUBBER MOUNTS AND WELLNUTS



820-52500



820-52503



820-52504

Description	WPS#
Vibration Mounts Each (repl. OE# 69123-92)	<b>820-52500</b>
Vibration mounts 5/pk	<b>820-52505</b>
Well Nuts 10-32 5/pk	<b>820-52503</b>
Well Nuts 10-24 10/pk	<b>820-52508</b>
Well Nuts 1/4-20 10/pk	<b>820-52509</b>
Windshield Bushings 4/pk	<b>820-52504</b>
Floorboard Isolation Dampers 8/pk	<b>820-52506</b>



820-52506



580-52505

**BODY**

## RUBBER MOUNTING STUDS

- Steel side plates
- Mount gas and oil tanks perfectly
- OEM replacement
- Heavy Duty mount has an internal spring

Description	WPS#
A 1/4"-20 x 1/2" threads 5pk	<b>820-2690</b>
B 5/16"-24 x 3/4" threads 3pk	<b>820-2689</b>
C 1/4"-20 x 1/2" threads (heavy duty) 5pk	<b>820-2691</b>



A



B



C



**WELD ON KICKSTANDS**

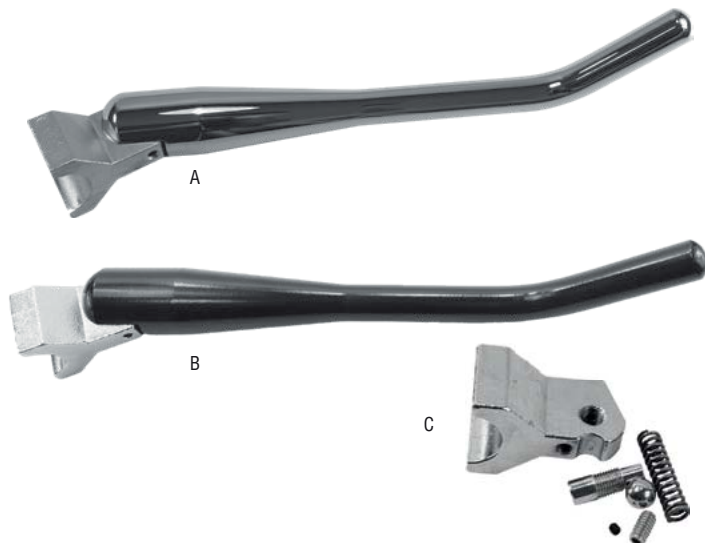

Get rid of your ugly stock kickstand and replace it with TC Bros. Choppers super clean chrome or black kickstand with hidden spring. Kit includes kickstand and weldable mild steel block coped to fit 1", 1 1/8" or 1 1/4" tubing on your frame.

	Description	WPS#
A	Chrome Weld-On Kick Stand (1-1/8")	<b>563-01100</b>
	Chrome Weld-On Kick Stand (1")	<b>563-01101</b>
	Chrome Weld-On Kick Stand (1-1/4")	<b>563-01102</b>
B	Black Weld-On Kick Stand (1")	<b>563-01103</b>
	Black Weld-On Kick Stand (1-1/8")	<b>563-01104</b>
	Black Weld-On Kick Stand (1-1/4")	<b>563-01105</b>
C	Repl. Mount 1-1/8"	<b>563-01106</b>
	Repl. Mount 1"	<b>563-01107</b>
	Repl. Mount 1-1/4"	<b>563-01108</b>



**HARD DRIVE KICKSTANDS**

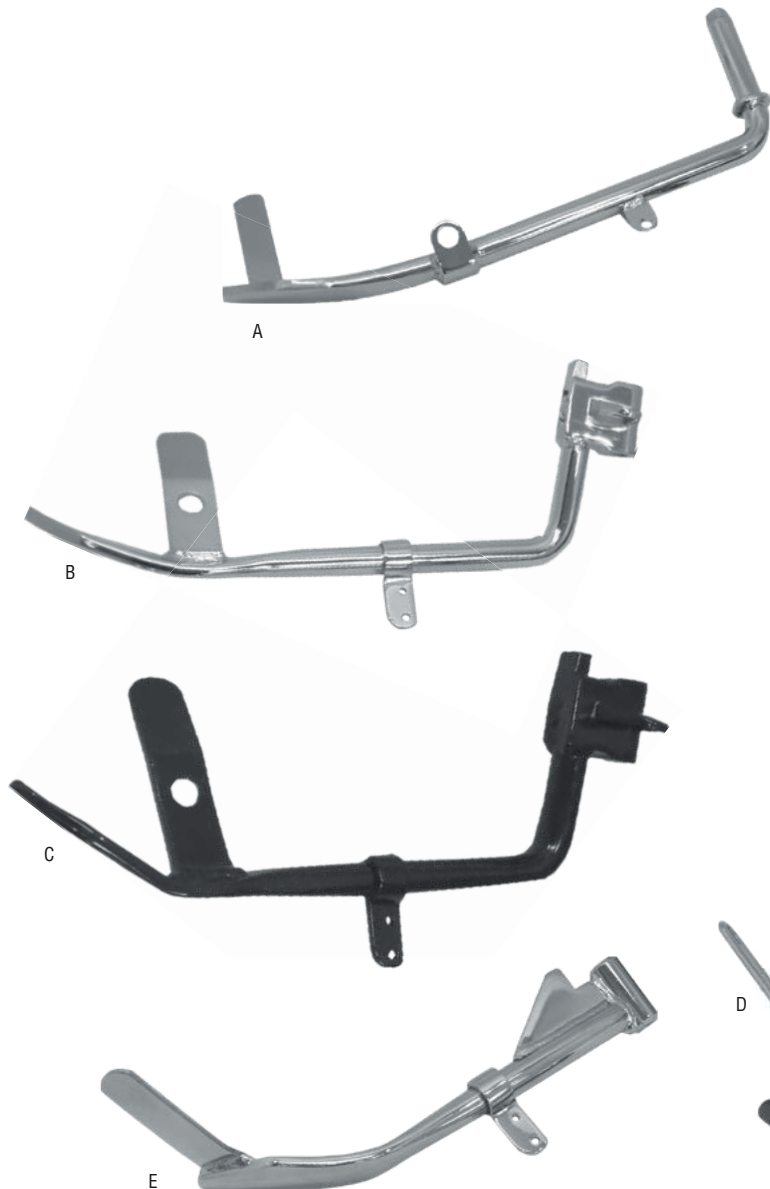

	Description	Year	WPS#
<b>TOURING</b>			
A	9.5" chrome	'07-18	<b>820-0522</b>
	1" understock chrome	'07-18	<b>820-0523</b>
<b>SOFTAIL</b>			
B	8.75" chrome	'07-17	<b>820-0518</b>
	1" under stock chrome	'07-17	<b>820-0519</b>
C	1" under stock black	'07-17	<b>820-0519B</b>
	Stock length chrome	'89-06	<b>820-53100</b>
	1" under stock chrome	'89-06	<b>820-0517</b>
<b>DYNA</b>			
D	11" chrome	'91-17	<b>820-0526</b>
	11" black	'91-17	<b>820-0526B</b>
	1" under stock chrome	'91-17	<b>820-0527</b>
	1" under stock black	'91-17	<b>820-0528</b>
	1" over stock chrome	'91-17	<b>820-0525</b>
	1" over stock black	'91-17	<b>820-0525B</b>
<b>SPORTSTER</b>			
	8" chrome	'04-18	<b>820-0540</b>
E	1" under stock chrome	'04-18	<b>820-0520</b>
F	1" under stock black	'04-18	<b>820-0521</b>
	8.25" chrome	'92-03	<b>820-0529</b>
	Chrome Stock	'89-03	<b>820-0541</b>
	+1" Over Stock Chrome	'89-03	<b>820-0542</b>

- WINDSHIELDS / FAIRINGS
- AUDIO / COMMUNICATION
- SEATS / LUGGAGE
- BAR / MIRRORS / CONTROLS
- EXHAUST
- AIR / FUEL SYSTEMS
- ENGINE
- TRANSMISSION / DRIVELINE
- GASKETS / SEALS
- ELECTRICAL
- LIGHTING
- CABLES
- BRAKES
- OIL FILTERS
- SUSPENSION
- BODY**
- WHEELS
- TIRES / TIRE ACC.
- BIKE ACC.
- VICTORY / INDIAN
- COVERS / LOCKS / TIEDOWNS
- CHEMICALS
- TOOLS
- HELMETS
- HELMET ACC.
- EYEWEAR
- APPAREL / RIDER ACC.
- PROMOTIONAL
- REFERENCE
- INDEX

- WINDSHIELDS / FAIRINGS
- AUDIO / COMMUNICATION
- SEATS / LUGGAGE
- BAR / MIRRORS / CONTROLS
- EXHAUST
- AIR / FUEL SYSTEMS
- ENGINE
- TRANSMISSION / DRIVELINE
- GASKETS / SEALS
- ELECTRICAL
- LIGHTING
- CABLES
- BRAKES
- OIL FILTERS
- SUSPENSION
- BODY**
- WHEELS
- TIRES / TIRE ACC.
- BIKE ACC.
- VICTORY / INDIAN
- COVERS / LOCKS / TIEDOWNS
- CHEMICALS
- TOOLS
- HELMETS
- HELMET ACC.
- EYEWEAR
- APPAREL / RIDER ACC.
- PROMOTIONAL
- REFERENCE
- INDEX



## KICKSTAND SPRINGS

- Replace those worn out kickstand springs
- Helps keep your kickstand from sagging

Application	WPS#
A '71-84 FX, FXWG, FL; '80-90 FLT; '84 FXST; '82-90 FXR; '81-E84 XL	50011-30A <b>820-0510</b>
B '87-Up Most Big Twins; Late '84 & '86-Up Sportsters	50005-85A <b>820-0511</b>
C '85 Sportster	41836-84 <b>820-0512</b>
D '91-01 FXD	50057-91 <b>820-0513</b>
E '07-17 Touring & Softail models	49725-07 <b>820-0514</b>
F '02-17 FXD	50057-02 <b>820-0515</b>
G '99-06 FLT	50112-99 <b>820-0516</b>

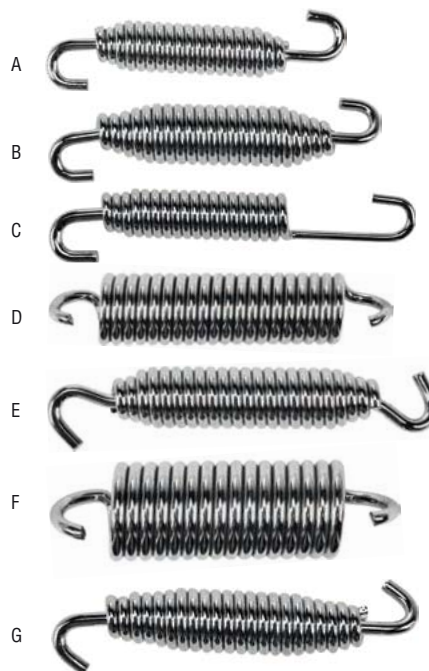

## KICKSTAND BUMPERS

- Replace those missing or worn out bumpers
- Protect your cases, quiets rattling kickstands

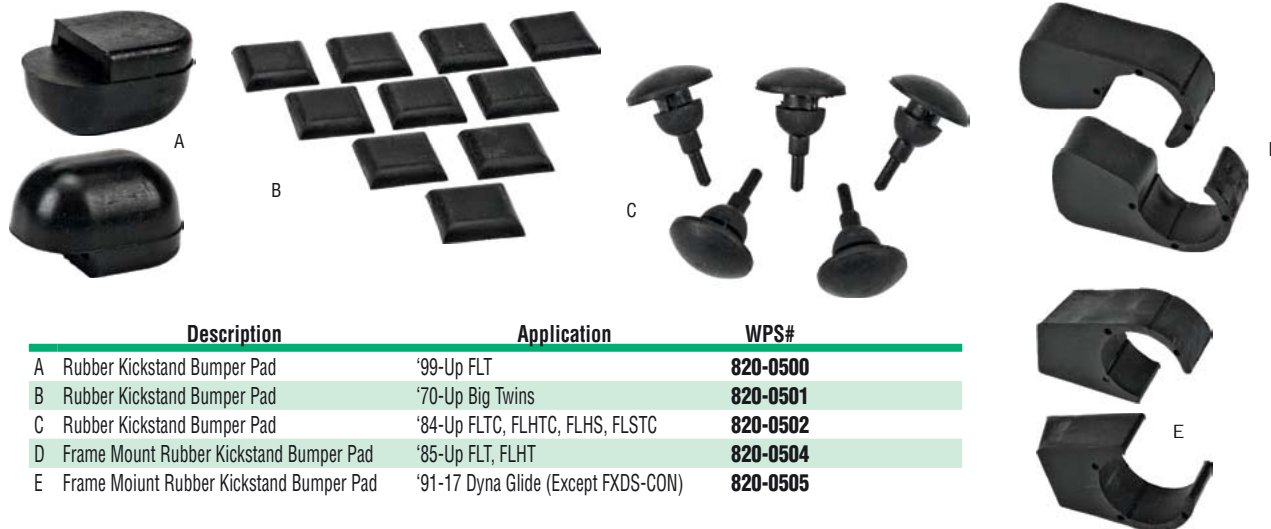

Description	Application	WPS#
A Rubber Kickstand Bumper Pad	'99-Up FLT	<b>820-0500</b>
B Rubber Kickstand Bumper Pad	'70-Up Big Twins	<b>820-0501</b>
C Rubber Kickstand Bumper Pad	'84-Up FLTC, FLHTC, FLHS, FLSTC	<b>820-0502</b>
D Frame Mount Rubber Kickstand Bumper Pad	'85-Up FLT, FLHT	<b>820-0504</b>
E Frame Mount Rubber Kickstand Bumper Pad	'91-17 Dyna Glide (Except FXDS-CON)	<b>820-0505</b>

## KICKSTAND EXTENSION

- Chrome plated finish
- Makes extending and retracting kickstand easier
- Requires a hole to be drilled in the existing kickstand for mounting
- Necessary hardware included



Description	WPS#
Kickstand Extension Softail and Touring Models	<b>820-51750</b>

## KICKSTAND BUSHING

- Replaces OEM 53138-98

Description	Year	WPS#
Kick Stand Bushings	07-Up Softail	<b>820-0543</b>



## SOFTAIL KICKSTAND KIT



Complete kickstand kit with brackets, spring and mounting hardware. Fits Softails '89-99 and most aftermarket frames that require a Softail style kickstand.



Description	WPS#
Complete Kickstand Kit for Softails '89-99	820-53101

## KICKSTAND ANGLE PLATE



Sometimes a lowered Harley-Davidson motorcycle will lean over too much! Our Kickstand Angle Plate is the answer! Fits kickstands up to 1999 and includes all necessary hardware.

Description	Application	WPS#
Kickstand Angle Plate	Fits '36-99 Big Twins	812-02010



A



B

## KICKSTAND PADS

- 4" diameter durable plastic kickstand pad
- Sold in a pack of 20 w/display box

Description	WPS#
<b>KICKSTAND PADS 20 PK W/DISPLAY BOX</b>	
A Fly	360-9930
B HardDrive	820-99100

WINDSHIELDS / FAIRINGS  
 AUDIO / COMMUNICATION  
 SEATS / LUGGAGE  
 BARS / MIRRORS / CONTROLS  
 EXHAUST  
 AIR / FUEL SYSTEMS  
 ENGINE  
 TRANSMISSION / DRIVELINE  
 GASKETS / SEALS  
 ELECTRICAL  
 LIGHTING  
 CABLES  
 BRAKES  
 OIL FILTERS  
 SUSPENSION  
**BODY**  
 WHEELS  
 TIRES / TIRE ACC.  
 BIKE ACC.  
 VICTORY / INDIAN  
 COVERS / LOCKS / TIEDOWNS  
 CHEMICALS  
 TOOLS  
 HELMETS  
 HELMET ACC.  
 EYEWEAR  
 APPAREL / RIDER ACC.  
 PROMOTIONAL  
 REFERENCE  
 INDEX



**SKID PLATES**

- Made from gel coated fiberglass, ready to paint or mount as is
- Distinct ribbed design with venting holes
- Mounting hardware included



750-02030



750-02031

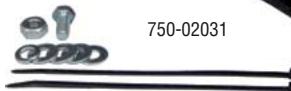

750-02032

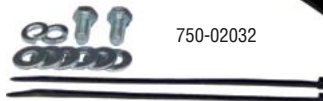

Description	WPS #
Fits Dyna Models '06-17 w/Mid-Controls	<b>750-02030</b>
Fits Sportster Models '94-03	<b>750-02031</b>
Fits Sportster Models '04-Up	<b>750-02032</b>

- WINDSHIELDS / FAIRINGS
- AUDIO / COMMUNICATION
- SEATS / LUGGAGE
- BARS / MIRRORS / CONTROLS
- EXHAUST
- AIR / FUEL SYSTEMS
- ENGINE
- TRANSMISSION / DRIVELINE
- GASKETS / SEALS
- ELECTRICAL
- LIGHTING
- CABLES
- BRAKES
- OIL FILTERS
- SUSPENSION
- BODY**
- WHEELS
- TIRES / TIRE ACC.
- BIKE ACC.
- VICTORY / INDIAN
- COVERS / LOCKS / TIEDOWNS
- CHEMICALS
- TOOLS
- HELMETS
- HELMET ACC.
- EYEWEAR
- APPAREL / RIDER ACC.
- PROMOTIONAL
- REFERENCE
- INDEX

**SKID PLATE**

Model	Year	Brushed	Black
Dyna	'06-17	<b>940-0254</b>	<b>940-0255</b>
Sportster	'04-17	<b>940-0252</b>	<b>940-0253</b>
	'91-03	<b>940-0250</b>	<b>940-0251</b>

- Laser cut from 3/32" thick aluminum and hand finished for precise fitment
- Hand crafted with pride in Anaheim, California by people who ride motorcycles.
- Available in brushed aluminum or black powder coat
- Engine case and wrap around frame rail coverage
- TIG welded construction
- Supplied with all necessary mounting hardware



940-0254



940-0255



940-0252



940-0253



940-0250



940-0251

- WINDSHIELDS / FAIRINGS
- AUDIO / COMMUNICATION
- SEATS / LUGGAGE
- BAR / MIRRORS / CONTROLS
- EXHAUST
- AIR / FUEL SYSTEMS
- ENGINE
- TRANSMISSION / DRIVELINE
- GASKETS / SEALS
- ELECTRICAL
- LIGHTING
- CABLES
- BRAKES
- OIL FILTERS
- SUSPENSION
- BODY**
- WHEELS
- TIRES / TIRE ACC.
- BIKE ACC.
- VICTORY / INDIAN
- COVERS / LOCKS / TIEDOWNS
- CHEMICALS
- TOOLS
- HELMETS
- HELMET ACC.
- EYEWEAR
- APPAREL / RIDER ACC.
- PROMOTIONAL
- REFERENCE
- INDEX



## FRONT MUD GUARDS

If you don't run a front fender and have ever been caught in the rain you will appreciate these gadgets. These mud guards are made from heavy duty nylon. They easily attach to your front forks when needed and roll up into a small, easy to carry bundle when not needed. Ideal to keep water and other road grime from splashing up into your face. Available for 39mm front ends and stock type springers.



Description	WPS#
A Front Mudguard 39mm Forks	750-01030
B Front Mudguard Springer Forks	750-01031

## SIDE COVER GARNISH FOR SPORTSTERS

- Available in two styles, dimpled and batwing
- Sold in pairs
- Black gel coated fiberglass
- Comes with double sided tape for mounting
- Check fitment before painting and final installation



Description	Application	WPS#
A Side Cover Garnish Dimpled	'04-Up XL	750-01340
B Side Cover Garnish Batwing	'04-Up XL	750-01341

## SPORTSTER PASSENGER PEG RELOCATION KIT

- 6 Different mounting positions with one kit!
- Helps clear certain exhaust or saddlebag configurations
- Pegs not included



Description	Application	WPS#
Passenger Peg Relocation Kit	'04-Up XL Models	750-01270



**ENGINE GUARD WITH FOOTRESTS**

These engine guards combine form and function like no other on the market. Integrated rubber footrests make long rides more comfortable and their curved flowing design gives a classic look to your bike. Mounting hardware included.

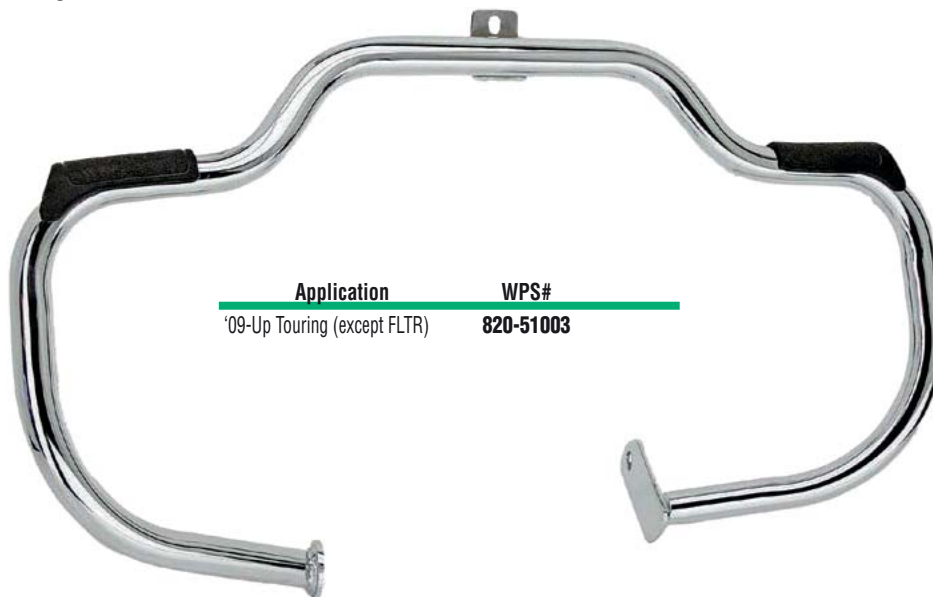

Application	WPS#
'09-Up Touring (except FLTR)	820-51003

**THE MAGNUMBAR® ENGINE GUARD**

**LINDBY  
CUSTOM, INC.**



- Triple chrome plated
- 1 1/2" outside diameter
- Easily installed with simple hand tools
- Comes with all necessary hardware and instructions

Application	Year	Chrome	Black
<b>TOURING</b>			
FLH models	'97-Up	830-5009	830-5008
<b>SOFTAIL</b>			
FLST models	'00-17	830-5010	830-5011
<b>REPLACEMENT PARTS</b>			
Replacement o-rings (10/pc)			830-5059

- WINDSHIELDS / FAIRINGS
- AUDIO / COMMUNICATION
- SEATS / LUGGAGE
- BAR / MIRRORS / CONTROLS
- EXHAUST
- AIR / FUEL SYSTEMS
- ENGINE
- TRANSMISSION / DRIVELINE
- GASKETS / SEALS
- ELECTRICAL
- LIGHTING
- CABLES
- BRAKES
- OIL FILTERS
- SUSPENSION
- BODY**
- WHEELS
- TIRES / TIRE ACC.
- BIKE ACC.
- VICTORY / INDIAN
- COVERS / LOCKS / TIEDOWNS
- CHEMICALS
- TOOLS
- HELMETS
- HELMET ACC.
- EYEWEAR
- APPAREL / RIDER ACC.
- PROMOTIONAL
- REFERENCE
- INDEX



# THE LINBAR® ENGINE GUARD

- Triple chrome plated
- 1 1/4" outside diameter
- Easily installed with simple hand tools
- Comes with all necessary hardware and instructions

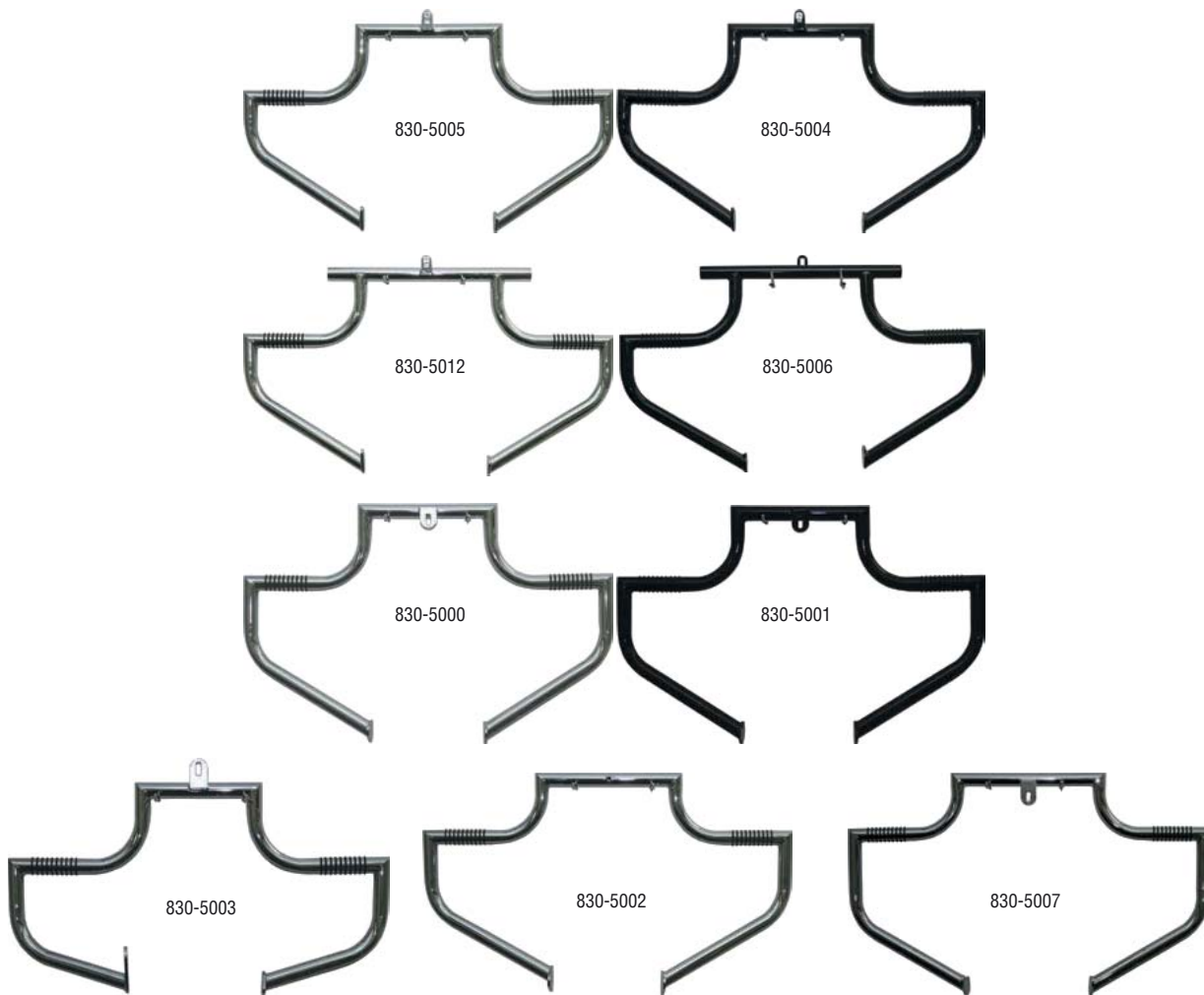

Application	Year	Chrome	Black	Flat Black
<b>TOURING</b>				
FLH models	'97-Up	<b>830-5005</b>	<b>830-5004</b>	<b>830-5029</b>
	'81-96	<b>830-5023</b>		
FLTR models	'15-Up	<b>830-5013</b>	<b>830-5006</b>	
	'98-13	<b>830-5012</b>	<b>830-5014</b>	
<b>SOFTAIL</b>				
FLST models	'00-Up	<b>830-5000</b>	<b>830-5001</b>	
	'86-99	<b>830-5003</b>		
Rear Linbar for Softail	* '96-17	<b>830-5032</b>		
FXST models	'00-Up	<b>830-5002</b>		
Adapter Bracket for FXST	'86-99	<b>830-5056</b>		
<b>DYNA</b>				
FLD	'11-17	<b>830-5028</b>		
Models w/mid controls	'91-17	<b>830-5025</b>	<b>830-5031</b>	
Models w/stock forward controls	'91-17	<b>830-5007</b>	<b>830-5030</b>	
<b>SPORTSTER</b>				
All models	'04-UP	<b>830-5027</b>		
Models w/mid controls	'86-03	<b>830-5024</b>		
Models w/stock forward controls	'86-03	<b>830-5026</b>		
<b>REPLACEMENT PARTS</b>				
Replacement o-rings (20/pc)			<b>830-6004</b>	



WINDSHIELDS / FAIRINGS  
AUDIO / COMMUNICATION  
SEATS / LUGGAGE  
BARS / MIRRORS / CONTROLS  
EXHAUST  
AIR / FUEL SYSTEMS  
ENGINE  
TRANSMISSION / DRIVELINE  
GASKETS / SEALS  
ELECTRICAL  
LIGHTING  
CABLES  
BRAKES  
OIL FILTERS  
SUSPENSION  
**BODY**  
WHEELS  
TIRES / TIRE ACC.  
BIKE ACC.  
VICTORY / INDIAN  
COVERS / LOCKS / TIEDOWNS  
CHEMICALS  
TOOLS  
HELMETS  
HELMET ACC.  
EYEWEAR  
APPAREL / RIDER ACC.  
PROMOTIONAL  
REFERENCE  
INDEX



830-5034

**TWINBAR ENGINE GUARD** 

- Triple chrome plated
- 1 1/4" outside diameter
- Flip Down Foot Pegs
- Comes with all necessary hardware and instructions



830-5035

**Application Year Chrome**

<b>TOURING</b>		
FLH models	'97-UP	<b>830-5034</b>
FLTR models	'98-UP	<b>830-5035</b>

**SOFTAIL**

FLS models	'00-17	<b>830-5033</b>
------------	--------	-----------------

**REPLACEMENT PARTS**

Rubber strips (3 short/3 long)	<b>830-5057</b>
Pegs (sold as a set)	<b>830-5058</b>



830-5057



830-5033



830-5048

**UNIBAR ENGINE GUARD** 

- Perfect for the traditionalist who want simplicity and clean lines
- 1 1/4" outside diameter
- Triple chrome plated or in a black powdercoat finish

**Application Year Chrome Black**

<b>TOURING</b>			
FLH models	'97-Up	<b>830-5048</b>	<b>830-5052</b>

**SOFTAIL**

All models	'00-17	<b>830-5049</b>	<b>830-5053</b>
------------	--------	-----------------	-----------------

**DYNA**

FLD	'11-17	<b>830-5050</b>	<b>830-5054</b>
-----	--------	-----------------	-----------------

**SPORTSTER**

All models	'04-UP	<b>830-5051</b>	<b>830-5055</b>
------------	--------	-----------------	-----------------



830-5052



830-5049



830-5053



830-5050



830-5054



830-5051



830-5055

**LINDBY  
CUSTOM, INC.**

**MULTIBAR ENGINE GUARD**



- Triple chrome plated
- 1 1/4" outside diameter w/ built in rubber footrests
- Comes with all necessary hardware and instructions
- Easy to install

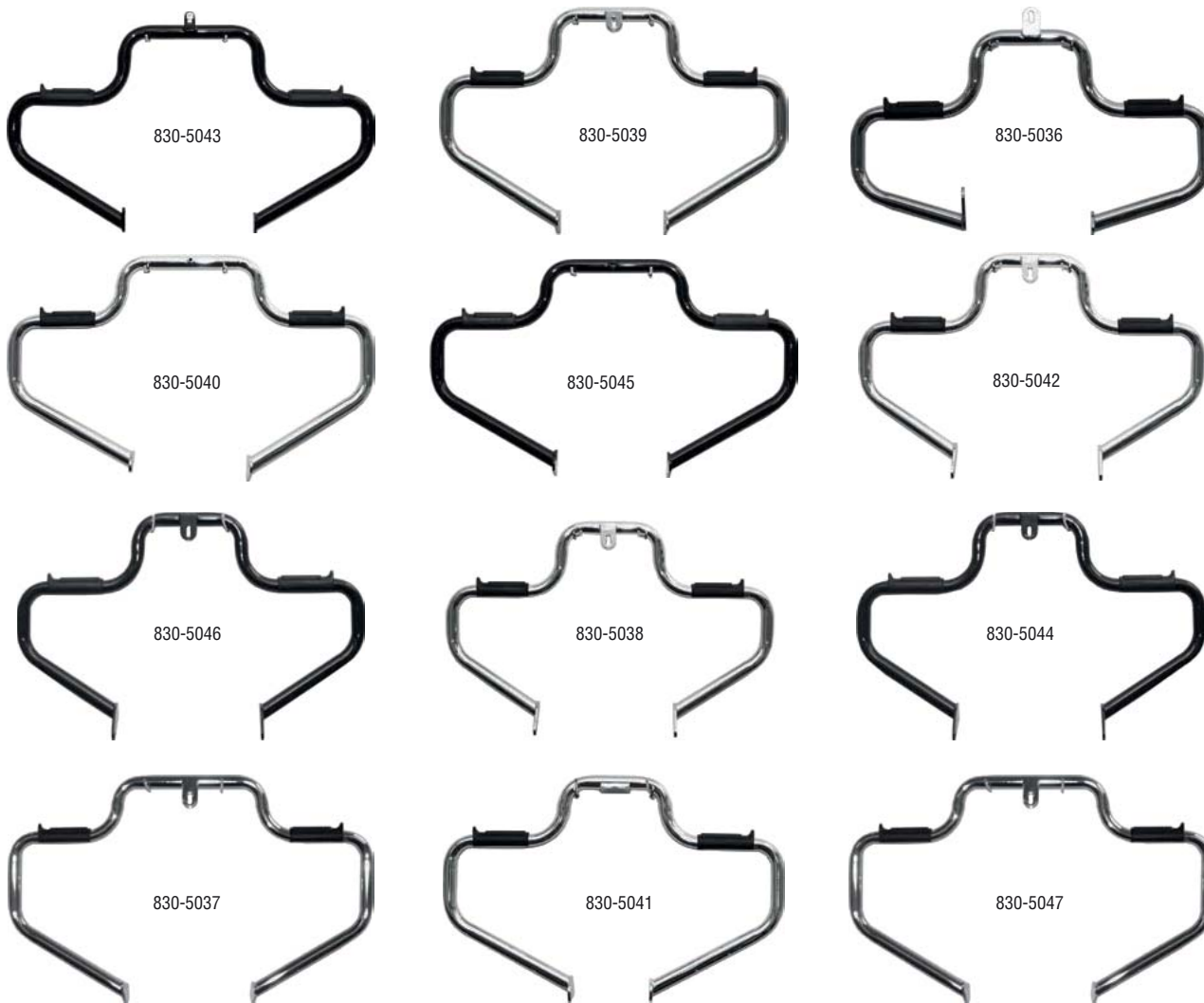

	Application	Year	Chrome	Black
<b>TOURING</b>				
	FLH models	'97-Up	<b>830-5022</b>	<b>830-5043</b>
<b>SOFTAIL</b>				
	FLST models	'00-17	<b>830-5039</b>	
		'86-99	<b>830-5036</b>	
	FXST and Springer models	'00-17	<b>830-5040</b>	<b>830-5045</b>
<b>DYNA</b>				
	FLD	'11-17	<b>830-5042</b>	<b>830-5046</b>
	Models w/mid controls	'91-17	<b>830-5038</b>	<b>830-5044</b>
	Models w/stock forward controls	'91-17	<b>830-5037</b>	
<b>SPORTSTER</b>				
	All models	'04-UP	<b>830-5041</b>	<b>830-5047</b>
<b>REPLACEMENT PARTS</b>				
	Rubber pads (2 pieces)			<b>830-6008</b>

- WINDSHIELDS / FAIRINGS
- AUDIO / COMMUNICATION
- SEATS / LUGGAGE
- BARS / MIRRORS / CONTROLS
- EXHAUST
- AIR / FUEL SYSTEMS
- ENGINE
- TRANSMISSION / DRIVELINE
- GASKETS / SEALS
- ELECTRICAL
- LIGHTING
- CABLES
- BRAKES
- OIL FILTERS
- SUSPENSION
- BODY**
- WHEELS
- TIRES / TIRE ACC.
- BIKE ACC.
- VICTORY / INDIAN
- COVERS / LOCKS / TIEDOWNS
- CHEMICALS
- TOOLS
- HELMETS
- HELMET ACC.
- EYEWEAR
- APPAREL / RIDER ACC.
- PROMOTIONAL
- REFERENCE
- INDEX



830-6001



830-6000BK

830-6000

## CLAMP-ON PEGS

**LINDBY  
CUSTOM, INC.**

- Triple Chrome plated with high quality replaceable rubber accents.
- These high quality billet aluminum clamp-on foot pegs will fit any engine guard with specified O.D. (includes Set of 2 Pegs /Left & Right)
- Looks great on the LINBAR, UNIBAR, MULTIBAR or any highway bar

CLAMP-ON PEGS	Bar Size	Finish	WPS#
Wide O-Ring	1½"	Chrome	<b>830-6000</b>
		Black	<b>830-6000BK</b>
3 Wide O-Rings	1¼"	Chrome	<b>830-6002</b>
		Black	<b>830-6002BK</b>
8 O-Rings	1¼"	Chrome	<b>830-6001</b>
		Black	<b>830-6001BK</b>
Rubber Strips	1¼"	Chrome	<b>830-6003</b>
		Black	<b>830-6003BK</b>
PEG REPLACEMENT PARTS			
O-Ring set 6 pc	830-6002/BK		<b>830-6006</b>
O-Ring set 16 pc	830-6001/BK		<b>830-6005</b>
Rubber strip set 8 pc	830-6003/BK		<b>830-6007</b>

## FAIRING SUPPORT BAR



Application	Finish	WPS#
Fits FLTR Models '98-Up	Chrome	<b>830-5060</b>
	Black	<b>830-5061</b>

- Roadglide fairing support bar eliminates the need for stock crash bars.



## FAIRING SUPPORTS/TIE DOWNS

**HardDrive**  
AMERICAN V-TWIN PRODUCTS

- Road Glide Fairing Supports Available in Show Chrome and Black
- Bat Wing Fairing Side Brackets Available in Both Show Chrome and Black
- Bat Wing Fairing Bracket Have Incorporated Tie Down Mounts



Description	Application	WPS #
Chrome Fairing Support	15-Up Road Glide	<b>820-52451</b>
Black Fairing Support	15-Up Road Glide	<b>820-52452</b>
Chrome Tie Down Bracket	14-Up Models	<b>820-52453</b>
Black Tie Down Bracket	14-Up Models	<b>820-52454</b>
Chrome Tie Down Bracket	95-13 Models	<b>820-52455</b>
Black Tie Down Bracket	95-13 Models	<b>820-52456</b>

- WINDSHIELDS / FAIRINGS
- AUDIO / COMMUNICATION
- SEATS / LUGGAGE
- BAR / MIRRORS / CONTROLS
- EXHAUST
- AIR / FUEL SYSTEMS
- ENGINE
- TRANSMISSION / DRIVELINE
- GASKETS / SEALS
- ELECTRICAL
- LIGHTING
- CABLES
- BRAKES
- OIL FILTERS
- SUSPENSION
- BODY**
- WHEELS
- TIRES / TIRE ACC.
- BIKE ACC.
- VICTORY / INDIAN
- COVERS / LOCKS / TIEDOWNS
- CHEMICALS
- TOOLS
- HELMETS
- HELMET ACC.
- EYEWEAR
- APPAREL / RIDER ACC.
- PROMOTIONAL
- REFERENCE
- INDEX

**HardDrive**  
AMERICAN V-TWIN PRODUCTS

**FORGED ALUMINUM WHEELS**



FLOW

LUCK

REVOLVER



- WINDSHIELDS / FAIRINGS
- AUDIO / COMMUNICATION
- SEATS / LUGGAGE
- BARS / MIRRORS / CONTROLS
- EXHAUST
- AIR / FUEL SYSTEMS
- ENGINE
- TRANSMISSION / DRIVELINE
- GASKETS / SEALS
- ELECTRICAL
- LIGHTING
- CABLES
- BRAKES
- OIL FILTERS
- SUSPENSION
- BODY
- WHEELS**
- TIRES / TIRE ACC.
- BIKE ACC.
- VICTORY / INDIAN
- COVERS / LOCKS / TIEDOWNS
- CHEMICALS
- TOOLS
- HELMETS
- HELMET ACC.
- EYEWEAR
- APPAREL / RIDER ACC.
- PROMOTIONAL
- REFERENCE
- INDEX



# FORGED ALUMINUM WHEELS



- Set your bike apart from the crowd with a set of our custom billet wheels! Available in three distinct designs to complement the style you are going for. They come in black anodized finish with machined details or high gloss triple chrome finish. All wheels are CNC machined from forged aluminum for superior strength and durability. Our wheels fit most current Harley models and are designed to accept stock rotors and pulleys or our matching two piece custom rotors and pulleys that are listed in the brake and drive sections. Some wheels may require extra pulley and rotor spacers depending on application. We do not list all possible sizes for all models so if you can't find the size/application combo you are looking for contact your HardDrive sales rep, we will do what is possible to accommodate your needs

Application	Finish	Size	Flow	Luck	Revolver	
<b>TOURING MODELS</b> NOTE: ON '14-UP TOURING MODELS STOCK ROTORS CANNOT BE USED.						
'08-Up Touring Dual Disc w/ABS	Front	Black	18x3.5	576-02000	576-02008	576-02016
			21x3.5	576-02024	576-02032	576-02040
			23x3.5	576-02048	576-02056	576-02064
	Chrome	18x3.5	576-02001	576-02009	576-02017	
		21x3.5	576-02025	576-02033	576-02041	
		23x3.5	576-02049	576-02057	576-02065	
'08-Up Touring Dual Disc Non ABS	Front	Black	18x3.5	576-02002	576-02010	576-02018
			21x3.5	576-02026	576-02034	576-02042
			23x3.5	576-02050	576-02058	576-02066
	Chrome	18x3.5	576-02003	576-02011	576-02019	
		21x3.5	576-02027	576-02035	576-02043	
		23x3.5	576-02051	576-02059	576-02067	
'08-Up Touring Single Disc w/ABS	Front	Black	18x3.5	576-02004	576-02012	576-02020
			21x3.5	576-02028	576-02036	576-02044
			23x3.5	576-02052	576-02060	576-02068
	Chrome	18x3.5	576-02005	576-02013	576-02021	
		21x3.5	576-02029	576-02037	576-02045	
		23x3.5	576-02053	576-02061	576-02069	
'08-Up Touring Single Disc Non ABS	Front	Black	18x3.5	576-02006	576-02014	576-02022
			21x3.5	576-02030	576-02038	576-02046
			23x3.5	576-02054	576-02062	576-02070
	Chrome	18x3.5	576-02007	576-02015	576-02023	
		21x3.5	576-02031	576-02039	576-02047	
		23x3.5	576-02055	576-02063	576-02071	
'00-07 Touring Dual Disc	Front	Black	18x3.5	576-02100	576-02104	576-02108
			21x3.5	576-02112	576-02116	576-02120
			23x3.5	576-02124	576-02128	576-02132
	Chrome	18x3.5	576-02101	576-02105	576-02109	
		21x3.5	576-02113	576-02117	576-02121	
		23x3.5	576-02125	576-02129	576-02133	
'00-07 Touring Single Disc	Front	Black	18x3.5	576-02102	576-02106	576-02110
			21x3.5	576-02114	576-02118	576-02122
			23x3.5	576-02126	576-02130	576-02134
	Chrome	18x3.5	576-02103	576-02107	576-02111	
		21x3.5	576-02115	576-02119	576-02123	
		23x3.5	576-02127	576-02131	576-02135	
'09-Up Touring w/ABS	Rear	Black	16x5	576-02500	576-02504	576-02508
			17x6.25	576-02512	576-02516	576-02520
			18x5.5	576-02524	576-02528	576-02532
	Chrome	16x5	576-02501	576-02505	576-02509	
		17x6.25	576-02513	576-02517	576-02521	
		18x5.5	576-02525	576-02529	576-02533	
'09-Up Touring Non ABS	Rear	Black	16x5	576-02502	576-02506	576-02510
			17x6.25	576-02514	576-02518	576-02522
			18x5.5	576-02526	576-02530	576-02534
	Chrome	16x5	576-02503	576-02507	576-02511	
		17x6.25	576-02515	576-02519	576-02523	
		18x5.5	576-02527	576-02531	576-02535	
'08 Touring w/ABS	Rear	Black	18x3.5	576-02536	576-02540	576-02544
			18x4.25	576-02548	576-02552	576-02556
	Chrome	18x3.5	576-02537	576-02541	576-02545	
		18x4.25	576-02549	576-02553	576-02557	
'08 Touring Non ABS	Rear	Black	18x3.5	576-02538	576-02542	576-02546
			18x4.25	576-02550	576-02554	576-02558
	Chrome	18x3.5	576-02539	576-02543	576-02547	
		18x4.25	576-02551	576-02555	576-02559	

- WINDSHIELDS / FAIRINGS
- AUDIO / COMMUNICATION
- SEATS / LUGGAGE
- BARS / MIRRORS / CONTROLS
- EXHAUST
- AIR / FUEL SYSTEMS
- ENGINE
- TRANSMISSION / DRIVELINE
- GASKETS / SEALS
- ELECTRICAL
- LIGHTING
- CABLES
- BRAKES
- OIL FILTERS
- SUSPENSION
- BODY
- WHEELS**
- TIRES / TIRE ACC.
- BIKE ACC.
- VICTORY / INDIAN
- COVERS / LOCKS / TIEDOWNS
- CHEMICALS
- TOOLS
- HELMETS
- HELMET ACC.
- EYEWEAR
- APPAREL / RIDER ACC.
- PROMOTIONAL
- REFERENCE
- INDEX



**FORGED ALUMINUM WHEELS**

- WINDSHIELDS / FAIRINGS
- AUDIO / COMMUNICATION
- SEATS / LUGGAGE
- BAR / MIRRORS / CONTROLS
- EXHAUST
- AIR / FUEL SYSTEMS
- ENGINE
- TRANSMISSION / DRIVELINE
- GASKETS / SEALS
- ELECTRICAL
- LIGHTING
- CABLES
- BRAKES
- OIL FILTERS
- SUSPENSION
- BODY
- WHEELS**
- TIRES / TIRE ACC.
- BIKE ACC.
- VICTORY / INDIAN
- COVERS / LOCKS / TIEDOWNS
- CHEMICALS
- TOOLS
- HELMETS
- HELMET ACC.
- EYEWEAR
- APPAREL / RIDER ACC.
- PROMOTIONAL
- REFERENCE
- INDEX

Application	Finish	Size	Flow	Luck	Revolver	
<b>TOURING MODELS (CONT'D...)</b>						
NOTE: On '14-UP Touring models stock rotors cannot be used.						
'02-07 Touring	Rear	Black	18x3.5	576-02560	576-02562	
			18x4.25	576-02566	576-02568	
	Chrome	18x3.5	576-02561	576-02563	576-02565	
		18x4.25	576-02567	576-02569	576-02571	
<b>SOFTAIL</b>						
'13-Up FXSB Breakout w/ABS	Front	Black	21x3.5	576-02150	576-02154	
			23x3.5	576-02162	576-02166	
		Chrome	21x3.5	576-02151	576-02155	576-02159
			23x3.5	576-02163	576-02167	576-02171
'13-Up FXSB Breakout Non ABS	Front	Black	21x3.5	576-02152	576-02156	
			23x3.5	576-02164	576-02168	
		Chrome	21x3.5	576-02153	576-02157	576-02161
			23x3.5	576-02165	576-02169	576-02173
'11-Up FLSTC/F/N w/ABS	Front	Black	18x3.5	576-02174	576-02176	
			21x3.5	576-02180	576-02182	
		Chrome	18x3.5	576-02175	576-02177	576-02179
			21x3.5	576-02181	576-02183	576-02185
'08-10 FLSTC/F/N	Front	Black	18x3.5	576-02186	576-02188	
			21x3.5	576-02192	576-02194	
		Chrome	18x3.5	576-02187	576-02189	576-02191
			21x3.5	576-02193	576-02195	576-02197
'00-06 FLSTF	Front	Black	18x3.5	576-02198	576-02200	
			21x3.5	576-02204	576-02206	
		Chrome	18x3.5	576-02199	576-02201	576-02203
			21x3.5	576-02205	576-02207	576-02209
'11-Up FXST w/ABS	Front	Black	21x2.15	576-02250	576-02252	
			21x3.5	576-02256	576-02258	
		Chrome	23x3.5	576-02262	576-02264	576-02266
			21x2.15	576-02251	576-02253	576-02255
'08-10 FXSTB/C and 07 FXSTD, FLST	Front	Black	21x3.5	576-02257	576-02259	
			23x3.5	576-02263	576-02265	
		Chrome	21x2.15	576-02268	576-02270	576-02272
			21x3.5	576-02274	576-02276	576-02278
'00-06 FXST/B/D and Custom WG	Front	Black	23x3.5	576-02280	576-02282	
			21x2.15	576-02269	576-02271	
		Chrome	21x3.5	576-02275	576-02277	576-02279
			23x3.5	576-02281	576-02283	576-02285
'84-99 FXST/B/D and Custom WG	Front	Black	21x2.15	576-02286	576-02288	
			21x3.5	576-02292	576-02294	
		Chrome	23x3.5	576-02298	576-02300	576-02302
			21x2.15	576-02287	576-02289	576-02291
'13-Up FXSB Breakout w/ABS	Rear	Black	21x3.5	576-02293	576-02295	
			23x3.5	576-02299	576-02301	
		Chrome	21x2.15	576-02304	576-02306	576-02308
			21x3.5	576-02310	576-02312	576-02314
'13-Up FXSB Breakout Non ABS	Rear	Black	21x2.15	576-02305	576-02307	
			21x3.5	576-02311	576-02313	
		Chrome	18x8.5	576-02862	576-02864	576-02866
			18x8.5	576-02863	576-02865	576-02867
'11-Up FLSTC/F/N/SB w/ABS	Rear	Black	18x8.5	576-02868	576-02870	
			18x8.5	576-02869	576-02871	
		Chrome	17x6.25	576-02600	576-02602	576-02604
			18x4.25	576-02606	576-02608	576-02610
08-Up Softail	Rear	Black	18x5.5	576-02612	576-02614	
			17x6.25	576-02601	576-02603	
		Chrome	18x4.25	576-02607	576-02609	576-02611
			18x5.5	576-02613	576-02615	576-02617
		Black	17x6.25	576-02618	576-02620	
			18x4.25	576-02624	576-02626	
		Chrome	18x5.5	576-02630	576-02632	576-02634
			17x6.25	576-02619	576-02621	576-02623
			18x4.25	576-02625	576-02627	
			18x5.5	576-02631	576-02633	576-02635

# FORGED ALUMINUM WHEELS



Application		Finish	Size	Flow	Luck	Revolver
<b>SOFTAIL (CONT'D...)</b>						
'07 FXST/B and FLSTF	Rear	Black	17x6.25	<b>576-02636</b>	<b>576-02638</b>	<b>576-02640</b>
		Chrome	18x5.5	<b>576-02642</b>	<b>576-02644</b>	<b>576-02646</b>
			17x6.25	<b>576-02637</b>	<b>576-02639</b>	<b>576-02641</b>
'00-05 Softail	Rear	Black	18x5.5	<b>576-02643</b>	<b>576-02645</b>	<b>576-02647</b>
			18x3.5	<b>576-02648</b>	<b>576-02650</b>	<b>576-02652</b>
		Chrome	18x4.25	<b>576-02654</b>	<b>576-02656</b>	<b>576-02658</b>
'84-99 Big Twins	Rear	Black	18x3.5	<b>576-02649</b>	<b>576-02651</b>	<b>576-02653</b>
			18x4.25	<b>576-02655</b>	<b>576-02657</b>	<b>576-02659</b>
		Chrome	18x3.5	<b>576-02730</b>	<b>576-02732</b>	<b>576-02734</b>
<b>DYNA</b>						
'08-Up FXD/C/B/L Non ABS	Front	Black	18x3.5	<b>576-02350</b>	<b>576-02352</b>	<b>576-02354</b>
			21x2.15	<b>576-02356</b>	<b>576-02358</b>	<b>576-02360</b>
		Chrome	21x2.15	<b>576-02351</b>	<b>576-02353</b>	<b>576-02355</b>
			21x3.5	<b>576-02357</b>	<b>576-02359</b>	<b>576-02361</b>
'08-Up FXDWG w/ABS	Front	Black	21x3.5	<b>576-02362</b>	<b>576-02366</b>	<b>576-02370</b>
			23x3.5	<b>576-02374</b>	<b>576-02378</b>	<b>576-02382</b>
		Chrome	21x3.5	<b>576-02363</b>	<b>576-02367</b>	<b>576-02371</b>
			23x3.5	<b>576-02375</b>	<b>576-02379</b>	<b>576-02383</b>
'08-Up FXDWG non/ABS	Front	Black	21x3.5	<b>576-02364</b>	<b>576-02368</b>	<b>576-02372</b>
			23x3.5	<b>576-02376</b>	<b>576-02380</b>	<b>576-02384</b>
		Chrome	21x3.5	<b>576-02365</b>	<b>576-02369</b>	<b>576-02373</b>
			23x3.5	<b>576-02377</b>	<b>576-02381</b>	<b>576-02385</b>
'12-Up FXD all w/ABS	Rear	Black	17x6.25	<b>576-02736</b>	<b>576-02738</b>	<b>576-02740</b>
			18x5.5	<b>576-02742</b>	<b>576-02744</b>	<b>576-02746</b>
		Chrome	17x6.25	<b>576-02737</b>	<b>576-02739</b>	<b>576-02741</b>
			18x5.5	<b>576-02743</b>	<b>576-02745</b>	<b>576-02747</b>
'08-Up FXD all non/ABS	Rear	Black	17x6.25	<b>576-02700</b>	<b>576-02702</b>	<b>576-02704</b>
			18x5.5	<b>576-02706</b>	<b>576-02708</b>	<b>576-02710</b>
		Chrome	17x6.25	<b>576-02701</b>	<b>576-02703</b>	<b>576-02705</b>
			18x5.5	<b>576-02707</b>	<b>576-02709</b>	<b>576-02711</b>
'06-07 FXDWG	Rear	Black	17x6.25	<b>576-02712</b>	<b>576-02714</b>	<b>576-02716</b>
			18x5.5	<b>576-02718</b>	<b>576-02720</b>	<b>576-02722</b>
		Chrome	17x6.25	<b>576-02713</b>	<b>576-02715</b>	<b>576-02717</b>
			18x5.5	<b>576-02719</b>	<b>576-02721</b>	<b>576-02723</b>
'00-05 FXD	Rear	Black	18x3.5	<b>576-02724</b>	<b>576-02726</b>	<b>576-02728</b>
		Chrome	18x3.5	<b>576-02725</b>	<b>576-02727</b>	<b>576-02729</b>
<b>SPORTSTER</b>						
'14-Up XL w/ABS (except 48)	Front	Black	21x2.15	<b>576-02450</b>	<b>576-02452</b>	<b>576-02454</b>
		Chrome	21x2.15	<b>576-02451</b>	<b>576-02453</b>	<b>576-02455</b>
'14-Up XL 48 w/ABS	Front	Black	21x2.15	<b>576-02456</b>	<b>576-02458</b>	<b>576-02460</b>
		Chrome	21x2.15	<b>576-02457</b>	<b>576-02459</b>	<b>576-02461</b>
'08-13 XL	Front	Black	21x2.15	<b>576-02462</b>	<b>576-02464</b>	<b>576-02466</b>
		Chrome	21x2.15	<b>576-02463</b>	<b>576-02465</b>	<b>576-02467</b>
'00-07 XL	Front	Black	21x2.15	<b>576-02468</b>	<b>576-02470</b>	<b>576-02472</b>
		Chrome	21x2.15	<b>576-02469</b>	<b>576-02471</b>	<b>576-02473</b>
'14-Up XL w/ABS	Rear	Black	18x4.25	<b>576-02800</b>	<b>576-02802</b>	<b>576-02804</b>
		Chrome	18x4.25	<b>576-02801</b>	<b>576-02803</b>	<b>576-02805</b>
'08-13 XL	Rear	Black	18x4.25	<b>576-02806</b>	<b>576-02808</b>	<b>576-02810</b>
		Chrome	18x4.25	<b>576-02807</b>	<b>576-02809</b>	<b>576-02811</b>
'04-07 XL	Rear	Black	18x3.5	<b>576-02812</b>	<b>576-02814</b>	<b>576-02816</b>
		Chrome	18x3.5	<b>576-02813</b>	<b>576-02815</b>	<b>576-02817</b>
<b>CUSTOM APPLICATIONS</b>						
Custom Wide Tire 3/4" Axle	Rear	Black	18x8.5	<b>576-02850</b>	<b>576-02852</b>	<b>576-02854</b>
		Chrome	18x8.5	<b>576-02851</b>	<b>576-02853</b>	<b>576-02855</b>
Custom Wide Tire 1" Axle	Rear	Black	18x8.5	<b>576-02856</b>	<b>576-02858</b>	<b>576-02860</b>
		Chrome	18x8.5	<b>576-02857</b>	<b>576-02859</b>	<b>576-02861</b>

- WINDSHIELDS / FAIRINGS
- AUDIO / COMMUNICATION
- SEATS / LUGGAGE
- BARS / MIRRORS / CONTROLS
- EXHAUST
- AIR / FUEL SYSTEMS
- ENGINE
- TRANSMISSION / DRIVELINE
- GASKETS / SEALS
- ELECTRICAL
- LIGHTING
- CABLES
- BRAKES
- OIL FILTERS
- SUSPENSION
- BODY
- WHEELS**
- TIRES / TIRE ACC.
- BIKE ACC.
- VICTORY / INDIAN
- COVERS / LOCKS / TIEDOWNS
- CHEMICALS
- TOOLS
- HELMETS
- HELMET ACC.
- EYEWEAR
- APPAREL / RIDER ACC.
- PROMOTIONAL
- REFERENCE
- INDEX



### CUSTOM PULLEYS



- Designed to match our HardDrive billet wheel collection
- On some models the installation of a spacer is required for proper fitment (see chart see below)



Flow black



luck black



revolver black



Flow chrome



luck chrome



revolver chrome

Application	Size	Finish	Flow	Luck	Revolver
'07-17 FXST/B/C	66T x 20mm	Black	<b>576-01218</b>	<b>576-01220</b>	<b>576-01222</b>
		Chrome	<b>576-01219</b>	<b>576-01221</b>	<b>576-01223</b>
'07-17 FLST/C/N, '07 FXSTD, '08-11 FXCW, '11 FXS, '07-17 FXD	66T x 1"	Black	<b>576-01200</b>	<b>576-01202</b>	<b>576-01204</b>
		Chrome	<b>576-01201</b>	<b>576-01203</b>	<b>576-01205</b>
'00-05 FXST, '00-06 FLST/C/N, '00-05 FXD, '04-06 FLHT, FLHX, FLHR, FLTR, '06 FXD	70T x 1 1/8"	Black	<b>576-01206</b>	<b>576-01208</b>	<b>576-01210</b>
		Chrome	<b>576-01207</b>	<b>576-01209</b>	<b>576-01211</b>
'86-99 FXST/FLST, '84-03 FLT, FLHT, FLHR, FLTR, '91-99 FXD, '85-94 FXR	70T x 1 1/2"	Black	<b>576-01212</b>	<b>576-01214</b>	<b>576-01216</b>
		Chrome	<b>576-01213</b>	<b>576-01215</b>	<b>576-01217</b>

### PULLEY SPACERS

Application	Finish	WPS#
Pre '99 for 65 and 70 Tooth Pulleys	Polished	<b>576-01300</b>
	Black	<b>576-01301</b>
'08-11 FXSTB/C, FLSTF (200mm Tire)	Black	<b>576-01302</b>
	Polished	<b>576-01303</b>
'08-Up FLSTN/C, FXCW/C	Black	<b>576-01304</b>
	Polished	<b>576-01305</b>
'08-Up FXD/C/B/L/F/WG	Black	<b>576-01306</b>
	Polished	<b>576-01307</b>



# LYNDALL WHEELS



Lyndall Wheels are manufactured in the USA combining cutting edge design and craftsmanship with premium quality rotary forgings. Bringing you the first and foremost in performance, Lyndall Wheels, are both stronger and lighter than stock; improving the performance, functionality, and beauty of your bike like no other can. Their B-52 and TT Tracker designs are available exclusively through HardDrive. Matching pulleys, sprockets and rotors are available separately to complete the look. Other applications available on request per special order, please allow at least three weeks for delivery.



TT Chrome



B-52 Black



576-07535



576-07534



576-07539



576-07538

Application	Finish	Size	TT Tracker	B-52	
<b>TOURING MODELS</b>					
'08-Up Touring Dual Disc w/ABS	Front	Black	19x3	<b>576-07500</b>	<b>576-07504</b>
		Chrome	21x3.25	<b>576-07508</b>	<b>576-07512</b>
	Rear	Black	19x3	<b>576-07501</b>	<b>576-07505</b>
		Chrome	21x3.25	<b>576-07509</b>	<b>576-07513</b>
'08-Up Touring Dual Disc Non ABS	Front	Black	19x3	<b>576-07502</b>	<b>576-07506</b>
		Chrome	21x3.25	<b>576-07510</b>	<b>576-07514</b>
	Rear	Black	19x3	<b>576-07503</b>	<b>576-07507</b>
		Chrome	21x3.25	<b>576-07511</b>	<b>576-07515</b>
'09-Up Touring w/ABS	Rear	Black	17x6	<b>576-07524</b>	<b>576-07528</b>
		Chrome	18x5.5	<b>576-07516</b>	<b>576-07520</b>
	Front	Black	17x6	<b>576-07525</b>	<b>576-07529</b>
		Chrome	18x5.5	<b>576-07517</b>	<b>576-07521</b>
'09-Up Touring Non ABS	Rear	Black	17x6	<b>576-07526</b>	<b>576-07530</b>
		Chrome	18x5.5	<b>576-07518</b>	<b>576-07522</b>
	Front	Black	17x6	<b>576-07527</b>	<b>576-07531</b>
		Chrome	18x5.5	<b>576-07519</b>	<b>576-07523</b>
<b>DYNA/FXR</b>					
'14-Up FXDL w/ABS Dual Disc	Front	Black	19x3	<b>576-07546</b>	<b>576-07550</b>
		Chrome	19x3	<b>576-07547</b>	<b>576-07551</b>
'14-Up FXDL NON-ABS Dual Disc	Front	Black	19x3	<b>576-07544</b>	<b>576-07548</b>
		Chrome	19x3	<b>576-07545</b>	<b>576-07549</b>
'12-Up FXDB/C w/ABS Single Disc (Hub Mount/Lyndall Rotor)	Front	Black	19x3	<b>576-07540</b>	<b>576-07542</b>
		Chrome	19x3	<b>576-07541</b>	<b>576-07543</b>
'08-Up FXDB/C NON-ABS Single Disc (Hub Mount/Lyndall Rotor)	Front	Black	19x3	<b>576-07534</b>	<b>576-07538</b>
		Chrome	19x3	<b>576-07535</b>	<b>576-07539</b>
'08-10 FXD, FXDL Single Disc (Stock Perimeter Rotor)	Front	Black	19x3	<b>576-07532</b>	<b>576-07536</b>
		Chrome	19x3	<b>576-07533</b>	<b>576-07537</b>
'06-07 FXD, FXDL Single Disc (Stock Perimeter Rotor)	Front	Black	19x2.15	<b>576-07583</b>	<b>576-07596</b>
		Chrome	19x2.15	<b>576-07589</b>	<b>576-07602</b>
'06-07 FXD, FXDL Single Disc (Hub Mount/Lyndall Rotor)	Front	Black	19x2.15	<b>576-07582</b>	<b>576-07595</b>
		Chrome	19x2.15	<b>576-07588</b>	<b>576-07601</b>
'04-05 FXD Single Disc	Front	Black	19x2.15	<b>576-07581</b>	<b>576-07594</b>
		Chrome	19x2.15	<b>576-07587</b>	<b>576-07600</b>
'04-05 FXD Dual Disc	Front	Black	19x2.15	<b>576-07580</b>	<b>576-07593</b>
		Chrome	19x2.15	<b>576-07586</b>	<b>576-07599</b>
'00-03 FXD Single Disc	Front	Black	19x2.15	<b>576-07579</b>	<b>576-07592</b>
		Chrome	19x2.15	<b>576-07585</b>	<b>576-07598</b>
'00-03 FXD Dual Disc	Front	Black	19x2.15	<b>576-07578</b>	<b>576-07591</b>
		Chrome	19x2.15	<b>576-07584</b>	<b>576-07597</b>
'91-99 FXD/FXR Dual Disc	Front	Black	19x2.15	<b>576-07577</b>	<b>576-07590</b>
		Chrome	19x2.15	<b>576-07615</b>	<b>576-07616</b>
'12-Up FXD all w/ABS	Rear	Black	17x6	<b>576-07562</b>	<b>576-07566</b>
		Chrome	18x5.5	<b>576-07554</b>	<b>576-07558</b>
	Front	Black	17x6	<b>576-07563</b>	<b>576-07567</b>
		Chrome	18x5.5	<b>576-07555</b>	<b>576-07559</b>
'08-Up FXD all non/ABS	Rear	Black	17x6	<b>576-07560</b>	<b>576-07564</b>
		Chrome	18x5.5	<b>576-07552</b>	<b>576-07556</b>
	Front	Black	17x6	<b>576-07561</b>	<b>576-07565</b>
		Chrome	18x5.5	<b>576-07553</b>	<b>576-07557</b>
'06 FXD all	Rear	Black	16x3.5	<b>576-07605</b>	<b>576-07611</b>
		Chrome	16x3.5	<b>576-07608</b>	<b>576-07614</b>
'00-05 FXD all	Rear	Black	16x3.5	<b>576-07604</b>	<b>576-07610</b>
		Chrome	16x3.5	<b>576-07607</b>	<b>576-07613</b>
		Black	16x3.5	<b>576-07603</b>	<b>576-07609</b>
'84-99 FXD/FXR w/Belt Drive	Rear	Black	16x3.5	<b>576-07606</b>	<b>576-07612</b>
		Chrome	16x3.5	<b>576-07606</b>	<b>576-07612</b>

- WINDSHIELDS / FAIRINGS
- AUDIO / COMMUNICATION
- SEATS / LUGGAGE
- BAR / MIRRORS / CONTROLS
- EXHAUST
- AIR / FUEL SYSTEMS
- ENGINE
- TRANSMISSION / DRIVELINE
- GASKETS / SEALS
- ELECTRICAL
- LIGHTING
- CABLES
- BRAKES
- OIL FILTERS
- SUSPENSION
- BODY
- WHEELS**
- TIRES / TIRE ACC.
- BIKE ACC.
- VICTORY / INDIAN
- COVERS / LOCKS / TIEDOWNS
- CHEMICALS
- TOOLS
- HELMETS
- HELMET ACC.
- EYEWEAR
- APPAREL / RIDER ACC.
- PROMOTIONAL
- REFERENCE
- INDEX



# LYNDALL TT TRACKER AND B-52 ROTORS

Create your own rotors to match your Lyndall wheels. Choose your center carrier design and finish then choose the friction ring that fits your application in silver or black high carbon steel in crown cut or smooth. Lyndall's patented lug drive design allows for easy assembly and unmatched braking performance. Carriers fit 2000 and later wheels with hub mounted rotors, for perimeter style rotors (used on '14-Up Touring models and '06-Up Dynas with cast

wheels) see the Lyndall rotors in the brake section. Quick application guide (for exact rotor dimensions for your model refer to your OEM parts guide):

- '00-07 Touring models require 11.5" rotors front and back
- '08-13 Touring models require 11.8" rotors front and back
- '08-Up Dynas with laced wheels require 11.8" rotors front and 11.5" rear rotors

Carriers	WPS#	Carriers	WPS#
TT Tracker Front Chrome 11.5 or 11.8	<b>576-07100</b>	B-52 Rear Black 11.8	<b>576-07111</b>
TT Tracker Front Black 11.5 or 11.8	<b>576-07101</b>	<b>FRICITION RINGS</b>	
TT Tracker Rear Chrome 11.5	<b>576-07102</b>	Crown Cut 11.5 Silver	<b>576-07150</b>
TT Tracker Rear Black 11.5	<b>576-07103</b>	Crown Cut 11.5 Black	<b>576-07151</b>
TT Tracker Rear Chrome 11.8	<b>576-07104</b>	Crown Cut 11.8 Silver	<b>576-07152</b>
TT Tracker Rear Black 11.8	<b>576-07105</b>	Crown Cut 11.8 Black	<b>576-07153</b>
B-52 Front Chrome 11.5 or 11.8	<b>576-07106</b>	Smooth 11.5 Silver	<b>576-07154</b>
B-52 Front Black 11.5 or 11.8	<b>576-07107</b>	Smooth 11.5 Black	<b>576-07155</b>
B-52 Rear Chrome 11.5	<b>576-07108</b>	Smooth 11.8 Silver	<b>576-07156</b>
B-52 Rear Black 11.5	<b>576-07109</b>	Smooth 11.8 Black	<b>576-07157</b>
B-52 Rear Chrome 11.8	<b>576-07110</b>		



TT Tracker Chrome w/ Crown Cut Silver



TT Tracker Chrome w/ Crown Cut Black



TT Tracker Chrome w/ Smooth Silver



TT Tracker Chrome w/ Smooth Black



TT Tracker Black w/ Crown Cut Silver



TT Tracker Black w/ Crown Cut Black



TT Tracker Black w/ Smooth Silver



TT Tracker Black w/ Smooth Black



B-52 Silver w/ Crown Cut Silver



B-52 Silver w/ Crown Cut Black



B-52 Silver w/ Smooth Silver



B-52 Silver w/ Smooth Black



B-52 Black w/ Crown Cut Silver



B-52 Black w/ Crown Cut Black



B-52 Black w/ Smooth Silver



B-52 Black w/ Smooth Black



## SPROCKETS AND PULLEYS

- Matching pulleys and sprockets for Lyndall TT Tracker and B-52 wheels
- Pulleys are machined from rotary forged 6061 aluminum
- Sprockets are machined from rotary forged 7075 aluminum for maximum durability

Pulleys	Size	Finish	TT Tracker	B-52
Fits '08-Up FXD Models, '07-Up FLST/C/N, '07 FXSTD, '08-11 FXCW, '11 FXS	66T x 1"	Black	<b>576-07301</b>	<b>576-07303</b>
		Chrome	<b>576-07300</b>	<b>576-07302</b>
<b>SPROCKETS</b>				
Fit Lyndall Wheels on Models with Chain Conversions	51T	Black	<b>576-07351</b>	<b>576-07353</b>
		Chrome	<b>576-07350</b>	<b>576-07352</b>
	52T	Black	<b>576-07355</b>	<b>576-07357</b>
		Chrome	<b>576-07354</b>	<b>576-07356</b>
	54T	Black	<b>576-07359</b>	<b>576-07361</b>
		Chrome	<b>576-07358</b>	<b>576-07360</b>



576-07300



576-07301



576-07302



576-07303



576-07350



576-07351



576-07352



576-07353

- WINDSHIELDS / FAIRINGS
- AUDIO / COMMUNICATION
- SEATS / LUGGAGE
- BAR / MIRRORS / CONTROLS
- EXHAUST
- AIR / FUEL SYSTEMS
- ENGINE
- TRANSMISSION / DRIVELINE
- GASKETS / SEALS
- ELECTRICAL
- LIGHTING
- CABLES
- BRAKES
- OIL FILTERS
- SUSPENSION
- BODY
- WHEELS**
- TIRES / TIRE ACC.
- BIKE ACC.
- VICTORY / INDIAN
- COVERS / LOCKS / TIEDOWNS
- CHEMICALS
- TOOLS
- HELMETS
- HELMET ACC.
- EYEWEAR
- APPAREL / RIDER ACC.
- PROMOTIONAL
- REFERENCE
- INDEX



**FRONT 40/48/60 SPOKE WHEELS**

- Chrome wheels available for many stock and custom applications in 40 and 60 spoke and the 48 Big Spoke
- Sealed for tubeless tires
- Application listed for axle size and location diameter only, additional spacing of rotors and pulleys may be required for exact fitment on some applications

- Wheels can be upgraded with 25mm bearings (sold separately) and bearing spacer (not included) for '08-Up applications
- Will not fit with front wheel speedometer drive on narrow glide front ends

Application	Spokes	Bearing	WPS#
<b>16X3.5- FRONT SINGLE DISC</b>			
'86-99 FLST	40 Spoke	3/4"	<b>576-04100</b>
'00-06 FLST	40 Spoke	3/4"	<b>576-04101</b>
'00-Up Custom Applications (Wide hub)	40 Spoke	1"	<b>576-04102</b>
'00-06 FLST	48 Big Spoke	3/4"	<b>576-04130</b>
'00-Up Custom Applications (Wide hub)	48 Big Spoke	1"	<b>576-04131</b>
'00-06 FLST	60 Spoke	3/4"	<b>576-04163</b>
'00-Up Custom Applications (Wide hub)	60 Spoke	1"	<b>576-04164</b>
<b>16X3.5- FRONT DUAL DISC</b>			
'84-99 FLH/FLT	40 Spoke	3/4"	<b>576-04103</b>
'00-Up Custom Applications (Wide hub)	40 Spoke	3/4"	<b>576-04104</b>
'00-07 FLH/FLT	40 Spoke	1"	<b>576-04105</b>
'00-Up Custom Applications (Wide hub)	48 Big Spoke	3/4"	<b>576-04132</b>
'00-07 FLH/FLT	48 Big Spoke	1"	<b>576-04133</b>
'00-Up Custom Applications (Wide hub)	60 Spoke	3/4"	<b>576-04165</b>
'00-07 FLH/FLT	60 Spoke	1"	<b>576-04166</b>
<b>21X2.15- FRONT SINGLE DISC</b>			
'84-99 FXD, FXR, Sportsters	40 Spoke	3/4"	<b>576-04112</b>
'00-03 FXD, '00-07 Sportsters	40 Spoke	3/4"	<b>576-04113</b>
'04-07 FXD ('06-Up requires aftermarket rotor)	40 Spoke	1"	<b>576-04114</b>
<b>19X2.15- FRONT DUAL/SINGLE DISC</b>			
'84-99 FXD, FXR, Sportsters	40 Spoke	3/4"	<b>576-04115</b>
'00-03 FXD, '00-07 Sportsters	40 Spoke	3/4"	<b>576-04116</b>
'04-07 FXD ('06-Up requires aftermarket rotor)	40 Spoke	1"	<b>576-04117</b>
<b>19X2.15- FRONT DUAL/SINGLE DISC</b>			
'00-03 FXD, '00-07 Sportsters	60 Spoke	3/4"	<b>576-04177</b>
'04-07 FXD ('06-Up requires aftermarket rotor)	60 Spoke	1"	<b>576-04178</b>
<b>21X2.15- FRONT SINGLE DISC</b>			
'93-99 FXDWG, '84-99 FXST	40 Spoke	3/4"	<b>576-04118</b>
'00-05 FXDWG, '00-06 FXST	40 Spoke	3/4"	<b>576-04119</b>
'06-07 FXDWG	40 Spoke	1"	<b>576-04120</b>
'00-05 FXDWG, '00-06 FXST	48 Big Spoke	3/4"	<b>576-04144</b>
'06-07 FXDWG	48 Big Spoke	1"	<b>576-04145</b>
'08-17 Softails	48 Big Spoke	25 mm	<b>576-04154</b>
'00-05 FXDWG, '00-06 FXST	60 Spoke	3/4"	<b>576-04179</b>
'06-07 FXDWG	60 Spoke	1"	<b>576-04180</b>
<b>21X3.5- FRONT SINGLE DISC</b>			
'00-06 FLST/FXST	48 Big Spoke	3/4"	<b>576-04146</b>
'06-07 FXDWG	48 Big Spoke	1"	<b>576-04147</b>
'08-17 Softails	48 Big Spoke	25 mm	<b>576-04155</b>
'06-07 FXDWG	60 Spoke	1"	<b>576-04181</b>
<b>21X3.5- FRONT DUAL DISC</b>			
'00-Up Custom Applications (Wide hub)	48 Big Spoke	3/4"	<b>576-04148</b>
'00-07 FLH/FLT	48 Big Spoke	1"	<b>576-04149</b>
'08-Up FLH/FLT	48 Big Spoke	25 mm	<b>576-04156</b>
'00-Up Custom Applications (Wide hub)	60 Spoke	3/4"	<b>576-04182</b>
'00-07 FLH/FLT	60 Spoke	1"	<b>576-04183</b>
'08-Up FLH/FLT	60 Spoke	25 mm	<b>576-04188</b>
<b>23X3.5- FRONT SINGLE DISC</b>			
'00-06 FLST/FXST	60 Spoke	3/4"	<b>576-04184</b>
'06-07 FXDWG	60 Spoke	1"	<b>576-04185</b>
<b>23X3.5- FRONT DUAL DISC</b>			
'00-Up Custom Applications (Wide hub)	60 Spoke	3/4"	<b>576-04186</b>
'00-07 FLH/FLT	60 Spoke	1"	<b>576-04187</b>
<b>23X3.5- FRONT SINGLE DISC</b>			
'00-06 FLST/FXST	48 Big Spoke	3/4"	<b>576-04150</b>
'06-07 FXDWG	48 Big Spoke	1"	<b>576-04151</b>
<b>23X3.5- FRONT DUAL DISC</b>			
'00-Up Custom Applications (Wide hub)	48 Big Spoke	3/4"	<b>576-04152</b>
'00-07 FLH/FLT	48 Big Spoke	1"	<b>576-04153</b>



40 Spoke



48 Big Spoke



60 Spoke

## REAR 40/48/60 SPOKE WHEELS



- Chrome wheels available for many stock and custom applications in 40 and 60 Spoke and the 48 Big Spoke
- Sealed for tubeless tires
- Application listed for axle size and location diameter only, additional spacing of rotors and pulleys may be required for exact fitment on some applications
- Wheels can be upgraded with 25mm bearings (sold separately) and bearing spacer (not included) for '08-Up applications

Application	Spokes	Bearing	WPS#
<b>16X3.5- REAR</b>			
'84-99 Big Twins and Sportsters	40 Spoke	3/4"	<b>576-04106</b>
'00-07 Softails, '00-05 Dynas, '00-04 XL, '00-01 Touring	40 Spoke	3/4"	<b>576-04107</b>
'02-07 Touring, '06-07 Dynas, '05-07 XL	40 Spoke	1"	<b>576-04108</b>
'00-07 Softails, '00-05 FXDWG, '00-01 Touring	48 Big Spoke	3/4"	<b>576-04134</b>
'02-07 Touring, '06-07 FXDWG	48 Big Spoke	1"	<b>576-04135</b>
'00-07 Softails, '00-05 Dynas, '00-04 XL, '00-01 Touring	60 Spoke	3/4"	<b>576-04167</b>
'02-07 Touring, '06-07 Dynas, '05-07 XL	60 Spoke	1"	<b>576-04168</b>
<b>16X5.5- REAR</b>			
'00-07 Softails, '00-05 FXDWG, '00-01 Touring	48 Big Spoke	3/4"	<b>576-04136</b>
'02-07 Touring, '06-07 FXDWG	48 Big Spoke	1"	<b>576-04137</b>
'08-Up Custom Applications	48 Big Spoke	25 mm	<b>576-04157</b>
'00-07 Softails, '00-05 Dynas, '00-01 Touring	60 Spoke	3/4"	<b>576-04169</b>
'02-07 Touring, '06-07 Dynas	60 Spoke	1"	<b>576-04170</b>
'08-Up Custom Applications	60 Spoke	25 mm	<b>576-04189</b>
<b>18X3.5- REAR</b>			
'84-99 Big Twins and Sportsters	40 Spoke	3/4"	<b>576-04109</b>
'00-07 Softails, '00-05 Dynas, '00-04 XL, '00-01 Touring	40 Spoke	3/4"	<b>576-04110</b>
'02-07 Touring, '06-07 Dynas, '05-07 XL	40 Spoke	1"	<b>576-04111</b>
'00-07 Softails, '00-05 FXDWG, '00-01 Touring	48 Big Spoke	3/4"	<b>576-04138</b>
'02-07 Touring, '06-07 FXDWG	48 Big Spoke	1"	<b>576-04139</b>
'00-07 Softails, '00-05 Dynas, '00-04 XL, '00-01 Touring	60 Spoke	3/4"	<b>576-04171</b>
'02-07 Touring, '06-07 Dynas, '05-07 XL	60 Spoke	1"	<b>576-04172</b>
<b>18X4.25- REAR</b>			
'00-07 Softails, '00-05 FXDWG, '00-01 Touring	48 Big Spoke	3/4"	<b>576-04142</b>
'02-07 Touring, '06-07 FXDWG	48 Big Spoke	1"	<b>576-04143</b>
'00-07 Softails, '00-05 Dynas, '00-01 Touring	60 Spoke	3/4"	<b>576-04175</b>
'02-07 Touring, '06-07 Dynas	60 Spoke	1"	<b>576-04176</b>
<b>18X5.5- REAR</b>			
'00-07 Softails, '00-05 FXDWG, '00-01 Touring	48 Big Spoke	3/4"	<b>576-04140</b>
'02-07 Touring, '06-07 FXDWG	48 Big Spoke	1"	<b>576-04141</b>
'00-07 Softails, '00-05 Dynas, '00-01 Touring	60 Spoke	3/4"	<b>576-04173</b>
'02-07 Touring, '06-07 Dynas	60 Spoke	1"	<b>576-04174</b>

- WINDSHIELDS / FAIRINGS
- AUDIO / COMMUNICATION
- SEATS / LUGGAGE
- BARS / MIRRORS / CONTROLS
- EXHAUST
- AIR / FUEL SYSTEMS
- ENGINE
- TRANSMISSION / DRIVELINE
- GASKETS / SEALS
- ELECTRICAL
- LIGHTING
- CABLES
- BRAKES
- OIL FILTERS
- SUSPENSION
- BODY
- WHEELS**
- TIRES / TIRE ACC.
- BIKE ACC.
- VICTORY / INDIAN
- COVERS / LOCKS / TIEDOWNS
- CHEMICALS
- TOOLS
- HELMETS
- HELMET ACC.
- EYEWEAR
- APPAREL / RIDER ACC.
- PROMOTIONAL
- REFERENCE
- INDEX



## FRONT AND REAR AXLES

- Chrome plated axles with hardware (except where noted)
- Spacers, nuts and washers included



Application	WPS#
<b>FRONT AXLES</b>	
Fits EL, FL and UL Models from '36-48	<b>820-51320</b>
Fits FL Models from '49-66	<b>820-51321</b>
Fits FL Models from '67-71	<b>820-51322</b>
Fits 4-Speed FL '73-80 and FXWG '80-83	<b>820-51323</b>
Fits Sportster, FX and K Models '52-72	<b>820-51325</b>
Fits Sportster and FX w/Single Disc '73-77	<b>820-51326</b>
Fits Sportster, FX and FXR Models w/Dual Disc from '77-83	<b>820-51327</b>
Fits Sportster, FX and FXR Models w/35mm Forks from '84-87	<b>820-51328</b>
Fits FXST/C '84-99, FLT, FLHT '84-99, FXWG '85-86 and FXDWG '93-99	<b>820-51324</b>
Fits FLH/FLT Models '00-07	<b>820-51334</b>
Fits FLH/FLT Models '08-Up	<b>820-54117</b>
Fits FL Softail Models '86-99	<b>820-51329</b>
Fits FLST Models '07-Up and FLS Models '12-Up	<b>820-51335</b>
Fits FXST Models '07-10 and FXS '11-13	<b>820-54120</b>
Fits FXSB '13-Up	<b>820-54119</b>
Fits FXD Models (except FXDF) '08-Up	<b>820-54121</b>
Fits FXDF '08-Up and FLD '12-Up	<b>820-54122</b>
Fits XL 1200X '10-Up and FXD '08-Up (AXLE ONLY)	<b>820-51330</b>
Fits Sportster Models '88-99	<b>820-51355</b>
Fits Spotster Models '88-99 (AXLE ONLY)	<b>820-51354</b>
Fits Sportster Models '00-07	<b>820-51333</b>
Fits XL 883L/1200C/XV '11-Up	<b>820-54123</b>
Fits XL 883R/N/1200V '11-13	<b>820-54125</b>
Fits XL 883N/1200V '14-Up	<b>820-54124</b>

Application	WPS#
<b>REAR AXLES</b>	
Fits EL, FL and UL Models '36-57	<b>820-51300</b>
Fits FL Models '58-66	<b>820-51301</b>
Fits FL and FX Models '67-72	<b>820-51302</b>
Fits 4-Speed FL and FX w/Chain Drive '73-85	<b>820-51303</b>
Fits 4-Speed FL and FX w/Belt Drive '80-86	<b>820-51304</b>
Fits Sportster and K Models '52-E78	<b>820-51305</b>
Fits Sportster Models '79-03	<b>820-51306</b>
Fits FXR Models '82-94	<b>820-51307</b>
Fits Softail Models '86-06	<b>820-51308</b>
Fits Softail Models '08-Up (AXLE ONLY)	<b>820-51331</b>
Fits FXSB '13-Up and FXCW/C '08-11	<b>820-54126</b>
Fits FXD Models '08-Up (AXLE ONLY)	<b>820-51332</b>
Fits FLT, FLHT, FLHS and FLHR Models '87-01 (AXLE ONLY)	<b>820-51309</b>
Fits Touring Models '09-Up	<b>820-54128</b>
Fits Sportster Models '08-Up	<b>820-54127</b>
Custom Acorn Style Axle Kit 9"L and 5/8" ID (includes spacer)	<b>820-54129</b>

## CHROME AXLE ADJUSTER SPACERS

- Chrome plated steel replacement axle adjuster spacers

Application	WPS#
Fits '00-07 Softails	<b>820-52351</b>



## AXLE ADJUSTER BLOCKS

- Rear axle block adjuster kits ensure better alignment of the rear axle
- Prevent swing arm tube collapse due to over-tightening.
- Kit includes heavy duty washer

Description	WPS #
Axle Adjuster Set Zinc '84-96 FLT (OEM 41573-84)	<b>820-51350</b>
Axle Adjuster Set Chrome FXST '87-92 (OEM 44-0545)	<b>820-51351</b>
Axle Adjuster Set FXR '84-91, FX '85, FXWG '85-86, XL '86-96	<b>820-52355</b>
Heavy Duty Axle Adjuster Set FXR '84-91	<b>820-51352</b>
Axle Adjuster Collars Chrome FXST '00-07 (OEM 47577-00)	<b>820-51353</b>





### AXLE ADJUSTER PLATES

- Billet belt/chain adjusters for FXR and early FXD models
- Upgrade the look and strength of the OEM nickel plated steel plate
- Made from A7075 alloy
- Hardware included

	Description	WPS#
A	FXR Models '82-94	811-50080
B	FXD Models '91-05	811-50081



### RIGID AXLE LOCATORS

- Rigid frame axle locators keep the axle in place in the event the axle should come loose or try to shift when hitting a pothole
- Made from A7075 alloy for superior strength
- Available in matte silver or chrome finish
- Made for 3/4" axles and 7/8" axle slots common on most rigid frames

	Description	WPS#
A	Silver	811-50082
B	Chrome	811-50083



### REAR WHEEL ADJUSTMENT BOLTS

- Made in the USA
- Polished chrome finish

Application	Year	Polished Chrome plated	Chrome plated
Softail	'08-Up	830-1055	
	'93-07	830-1052	830-1048
	'87-92	830-1054	830-1050
Dyna	'07-Up	830-1056	
	'92-06	830-1053	830-1049
Big Twin models	'72 and earlier	830-1051	830-1047

- WINDSHIELDS / FAIRINGS
- AUDIO / COMMUNICATION
- SEATS / LUGGAGE
- BAR / MIRRORS / CONTROLS
- EXHAUST
- AIR / FUEL SYSTEMS
- ENGINE
- TRANSMISSION / DRIVELINE
- GASKETS / SEALS
- ELECTRICAL
- LIGHTING
- CABLES
- BRAKES
- OIL FILTERS
- SUSPENSION
- BODY
- WHEELS**
- TIRES / TIRE ACC.
- BIKE ACC.
- VICTORY / INDIAN
- COVERS / LOCKS / TIEDOWNS
- CHEMICALS
- TOOLS
- HELMETS
- HELMET ACC.
- EYEWEAR
- APPAREL / RIDER ACC.
- PROMOTIONAL
- REFERENCE
- INDEX



### 3/4" AXLE SPACERS

- OEM replacement spacers for front and rear wheels
- Sold as each
- Chrome or Zinc finish

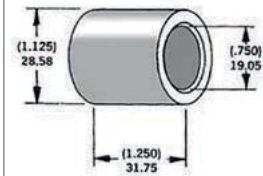

820-54000  
820-54100

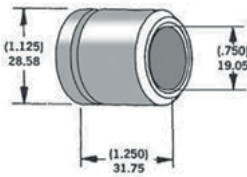

820-54001  
820-54101

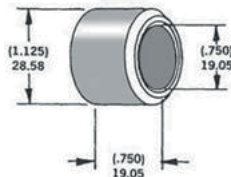

820-54002  
820-54102

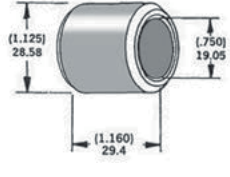

820-54003  
820-54103

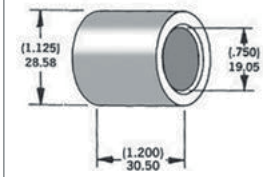

820-54004  
820-54104

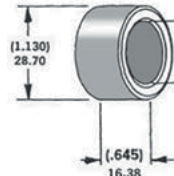

820-54005  
820-54105

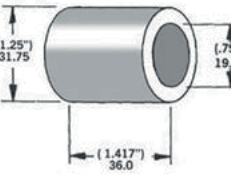

820-54006  
820-54106

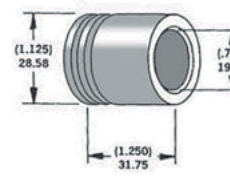

820-54007  
820-54107

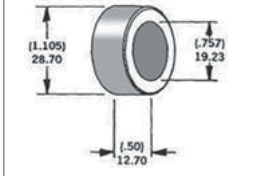

820-54008  
820-54108

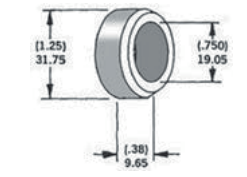

820-54009  
820-54109

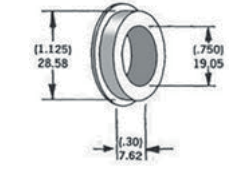

820-54010  
820-54110

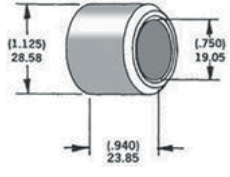

820-54011  
820-54111

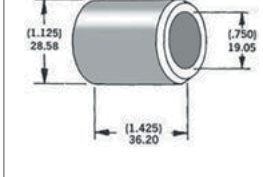

820-54012  
820-54112

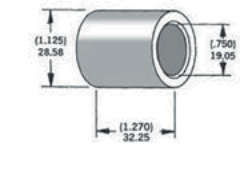

820-54013  
820-54113

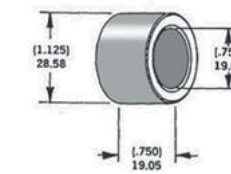

820-54014  
820-54114

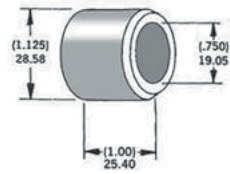

820-54015  
820-54115

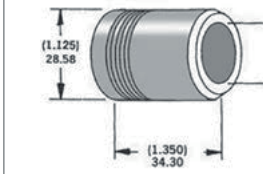

820-54016  
820-54116

OEM#	Width	Chrome	Zinc
40910-84A	1.250"	<b>820-54100</b>	<b>820-54000</b>
40915-94	1.250"	<b>820-54101</b>	<b>820-54001</b>
41196-83	.750"	<b>820-54102</b>	<b>820-54002</b>
41591-81	1.160"	<b>820-54103</b>	<b>820-54003</b>
41591-90	1.410"	<b>820-54106</b>	<b>820-54006</b>
41592-79	1.200"	<b>820-54104</b>	<b>820-54004</b>
41594-73	.645"	<b>820-54105</b>	<b>820-54005</b>
41595-86	1.250"	<b>820-54107</b>	<b>820-54007</b>
41607-83	.50"	<b>820-54108</b>	<b>820-54008</b>

OEM#	Width	Chrome	Zinc
43358-83A	.38"	<b>820-54109</b>	<b>820-54009</b>
43548-74	.30"	<b>820-54110</b>	<b>820-54010</b>
43617-95	.940"	<b>820-54111</b>	<b>820-54011</b>
43654-86A	.750"	<b>820-54114</b>	<b>820-54014</b>
43657-89	1.00"	<b>820-54115</b>	<b>820-54015</b>
43674-95	1.425"	<b>820-54112</b>	<b>820-54012</b>
43683-97	1.350"	<b>820-54116</b>	<b>820-54016</b>
43648-86	1.270"	<b>820-54113</b>	<b>820-54013</b>





### PULLEY SPACERS

Aluminum spacers that are ideal for lining up pulleys and sprockets. The spacers can easily be machined down to the next size under without having to worry about the spigot alignment when you machine the face of the spacer down to the desired thickness. They are drilled for up to 7/16" bolts. Can also be used as disc spacers.

Application	Width	WPS#	Application	Width	WPS#
'00-Up	1/2"	820-60550	'84-99	1/2"	820-60500
	3/4"	820-60551		3/4"	820-60501
	1"	820-60552		11/16"	820-60502
	1-1/4"	820-60553		1"	820-60503
	1-3/8"	820-60554		1-1/4"	820-60504
				1-1/2"	820-60505



### SPROCKET / DISC SPACERS

Used to line up Sprocket to chain or disc to caliper. Fits between sprocket or disc and hub. 50.8mm locating diameter.

Width	WPS#
0.2"	820-60570
0.06"	820-60571



### ADAPTER RING

Used to install '00-Up pulleys and rotors to '84-99 wheels.

Description	WPS#
56.4mm to 50.8mm	820-60572

- WINDSHIELDS / FAIRINGS
- AUDIO / COMMUNICATION
- SEATS / LUGGAGE
- BAR / MIRRORS / CONTROLS
- EXHAUST
- AIR / FUEL SYSTEMS
- ENGINE
- TRANSMISSION / DRIVELINE
- GASKETS / SEALS
- ELECTRICAL
- LIGHTING
- CABLES
- BRAKES
- OIL FILTERS
- SUSPENSION
- BODY
- WHEELS**
- TIRES / TIRE ACC.
- BIKE ACC.
- VICTORY / INDIAN
- COVERS / LOCKS / TIEDOWNS
- CHEMICALS
- TOOLS
- HELMETS
- HELMET ACC.
- EYEWEAR
- APPAREL / RIDER ACC.
- PROMOTIONAL
- REFERENCE
- INDEX



**SPEEDOMETER DRIVES**

- Designed as stock replacement if not otherwise noted



**Application**

**WPS#**

A	FLT '96-99 Left Side 2240:60 Ratio (OEM 67101-96)	<b>820-50400</b>
C	FLT '87-95 Left Side 2240:60 Ratio (OEM 67073-87A)	<b>820-50406</b>
D	FLH '81-84 FLT '84-86 2:1 Ratio (OEM 67073-81)	<b>820-50407</b>
	FLT '80-81 Right Side 2:1 Ratio (OEM 67071-79)	<b>820-50402</b>
	FXSTS '88-95 2240:60 Ratio Left Side (OEM 67166-88)	<b>820-50401</b>
B	FLSTC/FLSTF '86-95 Left Side 2240:60 Ratio (OEM 67125-86A)	<b>820-50405</b>
	FXR '84-95 XL '84-94 FXD '91-94 Left Side 2:1 Ratio (OEM 67127-84A)	<b>820-50403</b>
	FXLR '87-95 Left Side 2:1 Ratio (OEM 67132-85A)	<b>820-50404</b>
E	21" Wheel Conversion (Custom Applications) 2240:60 Ratio	<b>820-50408</b>
F	EL '36-40 FL '41-61 Transmission Drive	<b>820-50409</b>



**WHEEL SPACERS**

- These unique spacer kits fill the gap between the front wheel & fork slider
- The rounded design complements any wheel & rotor combination
- Kit includes left & right spacers



**Description**

**Application**

**WPS#**

Domed Wheel Spacer Kit Chrome	Touring Models 00-07 front wheel	<b>820-50001</b>
-------------------------------	----------------------------------	------------------



**WHEEL COVER**

- "Toy" wheel covers turn any 16" spoke wheel into an old school solid disc wheel
- Sold in pairs
- Requires drilling for valve stem clearance and fasteners
- Use three threaded rods and acorn nuts to sandwich the wheel covers in place as you would with Moon discs
- Outside diameter 15.5", inside diameter 5.4"

**Application**

**Description**

**WPS#**

Fits Most 16" Wheels	Toy Wheel Cover Raw	<b>866-05500</b>
	Toy Wheel Cover Black	<b>866-05501</b>





Model	Year	Front	Rear
<b>FLHR/FLHT/FLHX/FLTC/FLTR</b>			
	'95-99	820-0200	820-0210
	'00-01	820-0202	820-0211
	'02-07	820-0202	820-0212
	'08	820-0203 *	820-0213 *
	'09-13	820-0203 *	820-0215 *
<b>FLST/FXST</b>			
	'95-99	820-0200	820-0210
	'00-06	820-0201	820-0211
	'07	820-0203	820-0211
	'08-13	820-0203 *	820-0213 *
<b>FLSTSB</b>			
	'08-11	820-0201	820-0213
<b>FXCW</b>			
	'09-11	820-0203	820-0213
<b>FXD/FXR</b>			
	'95-99	820-0200	820-0210
	'00-03	820-0201	820-0211
	'04-05	820-0202	820-0211
	'06-07	820-0202	820-0212
	'08-13	820-0203 *	820-0213 *
<b>XL</b>			
	'00-04	820-0201	820-0211
	'05-07	820-0201	820-0212
	'08-13	820-0203	820-0213
	'95-99	820-0200	820-0210
<b>XR</b>			
	'09-13	820-0203	820-0213
<b>VRSC</b>			
	'02-07	820-0202	
	'08-13	820-0203 *	820-0214 *

\* Non ABS models only

## WHEEL BEARING KITS

- Kit includes long lasting, high quality bearings and seals
- Put the smooth back in your ride
- An essential maintenance item
- Sold in pairs



## STREET WHEEL BEARING AND SEAL KITS



Application	Year	Front	Rear
<b>TOURING</b>			
	'67-72	22-51366	22-51366
	'73-99	22-51002	22-51002
	'00-01	22-51394	22-51368
	'02-07	22-51394	22-51394
Non ABS models	'08-17	22-51571	22-51405
ABS models	'08-17	22-51691	22-51692
<b>SOFTAIL</b>			
	'80-99	22-51002	22-51002
	'00-06	22-51368	22-51368
	'07	22-51571	22-51368
Non ABS models	'08-17	22-51571	22-51571
ABS models	'08-17	22-51691	22-51691
Springer	'07	22-51368	22-51368
	'08	22-51368	22-51571
<b>DYNA/FXR</b>			
FX/FXE	'71-72	22-51369	22-51366
FXD, FXR	'73-99	22-51001	22-51002
FXWG, FXDWG	'80-99	22-51002	22-51002
FXD	'00-03	22-51368	22-51368
	'04-07	22-51394	22-51394
Non ABS models	'08-17	22-51571	22-51571
ABS models	'08-17	22-51691	22-51691
<b>SPORTSTER</b>			
XL models	'58-72	22-51369	22-51370
	'73-78	22-51001	22-51370
	'79-99	22-51001	22-51002
	'00-04	22-51368	22-51368
	'05-07	22-51368	22-51394
Non ABS models	'08-17	22-51571	22-51571
ABS models	'14-17	22-51691	22-51691
<b>V-ROD</b>			
V-Rod (1" axle)	'02-07	22-51394	22-51394
V-Rod (25mm axle) Non ABS models	'08-17	22-51571	22-51571
V-Rod (25mm axle) ABS models	'08-17	22-51691	22-51691

- Contains all of the bearings and seals required to re-fit a wheel
- Wheel bearings typically fail from water and dirt contamination. The All Balls wheel bearing was developed in partnership with KML Bearing and is designed to excel in the difficult operating environment street riding
- Premium EMQ quality, hi-speed-bearing featuring low drag, double lip rubber seals which provide superior exclusion of water, dirt and to improved grease retention
- Type TC Nitrile Elastomer wheel seals are specifically designed to keep out water and dirt
- The rubber coated outside diameter creates an optimum seal at the hub
- Steel garter spring guarantees constant pressure on the axle shaft over the life of the seal



- WINDSHIELDS / FAIRINGS
- AUDIO / COMMUNICATION
- SEATS / LUGGAGE
- BARS / MIRRORS / CONTROLS
- EXHAUST
- AIR / FUEL SYSTEMS
- ENGINE
- TRANSMISSION / DRIVELINE
- GASKETS / SEALS
- ELECTRICAL
- LIGHTING
- CABLES
- BRAKES
- OIL FILTERS
- SUSPENSION
- BODY
- WHEELS**
- TIRES / TIRE ACC.
- BIKE ACC.
- VICTORY / INDIAN
- COVERS / LOCKS / TIEDOWNS
- CHEMICALS
- TOOLS
- HELMETS
- HELMET ACC.
- EYEWEAR
- APPAREL / RIDER ACC.
- PROMOTIONAL
- REFERENCE
- INDEX

# TIRE CONVERSION CHARTS

THESE REFERENCE CHARTS ARE AS ACCURATE AS THE INFORMATION AVAILABLE TO US.

**SIZE CONVERSION TABLES:** Use these tables to convert your older style inch size to the new style metric sizing.

## STREET TIRES

- Front and Rear tires should be properly matched and sized to maintain correct clearance
- Mount tube type or tubeless tires only on the rims designed for each type of tire
- Before mounting, check for directional arrows on tire tubes. It is advisable to replace tube
- Before use, check wheel balance, wheel alignment, and most importantly, tire air pressure

Metric	Alpha	Inch
<b>REAR STREET TIRES</b>		
110/90	MN90	3.75/4.25
120/80	MP85	4.50/4.75
120/90	MP85	4.50/4.75
130/70	*	*
130/80	*	5.00/5.10
130/90	MT90	5.00/5.10
140/60	*	*
140/70	*	*
140/80	MU85	5.50/6.00
140/90	MU90	5.50/6.00
150/70	*	*
150/80	*	6.00/6.25
150/90	*	6.00/6.25
160/60	*	*
160/70	*	*
160/80	*	*
170/60	*	*
170/80	*	*
180/50	*	*
180/55	*	*

Metric	Alpha	Inch
<b>FRONT STREET TIRES</b>		
80/90	MH90	2.50/2.75
90/90	MJ90	2.75/3.00
100/80	MJ90	3.00
100/90	MM90	3.25/3.50
110/70	*	*
110/80	*	3.25/3.50
110/90	MN90	3.75/4.00
120/80	*	*
120/70	*	*
120/80	*	3.75/4.25/4.60
120/90	MR90	4.25/4.50
130/60	*	*
130/70	*	*
130/90	MT90	5.00/5.10

\* Should not change from OEM low profile sizing.

### SPEED RATINGS

CODE		
J	100	62
K	110	68
L	120	75
M	130	81
N	140	87
P	150	94
Q	160	100
R	170	106
S	180	112
T	190	118
U	200	124
H	210	130
V	240	149
(V) greater than	>240	>149
Z greater than	>240	>149
W	270	168
(W) greater than	>240	>168

### LOAD INDEX

INDEX								
30	106	234	53	206	454	77	412	908
31	109	240	54	212	467	78	425	937
32	112	245	55	218	490	79	437	963
33	115	254	56	224	494	80	450	992
34	118	260	57	230	507	81	462	1019
35	121	267	58	236	520	82	475	1047
36	125	276	59	243	536	83	487	1074
37	128	282	60	250	551	84	500	1102
38	128	282	61	257	567	85	515	1135
39	136	300	62	265	584	86	530	1168
40	140	309	63	272	600	87	545	1201
41	145	320	64	280	617	88	560	1235
42	150	331	65	290	640	89	580	1279
43	155	342	66	300	661	90	600	1323
44	160	353	67	307	677			
45	165	364	68	315	695			
46	170	375	69	325	717			
47	175	386	70	335	738			
48	180	397	71	345	761			
49	185	408	72	355	783			
50	190	419	73	365	805			
51	195	430	74	375	827			
52	200	441	75	387	853			
53	206	454	76	400	882			



More Miles for Your Money!!

A new standard in cruiser tire longevity  
Innovative technology



FRONT

REAR



Size	Load/Speed Rating	WPS#
<b>FRONT BIAS</b>		
MT90-B16	72H	<b>87-9770</b>
130/90-B16	73H	<b>87-9740</b>
100/80-B17	52H	<b>87-9765</b>
120/90-B17	64S	<b>87-9741</b>
130/80-B17	65H	<b>87-9742</b>
140/80-B17	69H	<b>87-9763</b>
110/90-B18	61H	<b>87-9761</b>
130/70-B18	63H	<b>87-9746</b>
100/90-B19	57H	<b>87-9744</b>
110/90-B19	62H	<b>87-9762</b>
130/60-B19	61H	<b>87-9764</b>
MH90-21	54H	<b>87-9771</b>
80/90-21	54H	<b>87-9745</b>
90/90-21	54H	<b>87-9747</b>
120/70-B21	68H	<b>87-9748</b>
<b>FRONT RADIAL</b>		
140/75R-17	67V	<b>87-9743</b>
120/70ZR 19	60W	<b>87-9760</b>

Size	Load/Speed Rating	WPS#
<b>REAR BIAS</b>		
140/90-B15	76H	<b>87-9749</b>
150/90-B15	74H	<b>87-9750</b>
170/80-B15	77H	<b>87-9751</b>
180/70-B15	76H	<b>87-9757</b>
MT90-B16	74H	<b>87-9772</b>
130/90-B16	73H	<b>87-9753</b>
MU85-B16	77H	<b>87-9773</b>
140/90-B16	77H	<b>87-9754</b>
150/80-B16	77H	<b>87-9755</b>
180/65-B16	81H	<b>87-9756</b>
160/70-B17	73V	<b>87-9758</b>
150/70-B18	76H	<b>87-9752</b>
180/55-18	80H	<b>87-9767</b>
<b>REAR RADIAL</b>		
140/75-R15	65H	<b>87-9768</b>
200/55-R17	78V	<b>87-9759</b>
240/40-R18	79V	<b>87-9769</b>

- WINDSHIELDS / FAIRINGS
- AUDIO / COMMUNICATION
- SEATS / LUGGAGE
- BARS / MIRRORS / CONTROLS
- AIR / FUEL SYSTEMS
- ENGINE
- TRANSMISSION / DRIVELINE
- GASKETS / SEALS
- ELECTRICAL
- LIGHTING
- CABLES
- BRAKES
- OIL FILTERS
- SUSPENSION
- BODY
- WHEELS
- TIRES / TIRE ACC.**
- BIKE ACC.
- VICTORY / INDIAN
- COVERS / LOCKS / TIEDOWNS
- CHEMICALS
- TOOLS
- HELMETS
- HELMET ACC.
- EYEWEAR
- APPAREL / RIDER ACC.
- PROMOTIONAL
- REFERENCE
- INDEX



Factory Authorized Replacement Tires for Your Harley-Davidson® Motorcycle

	Model Fitment	Stock / Approved	Tread	Size	Rim Size (in.)	WPS#
	<b>STREET™-- FRONT</b>					
	'15-later XG	Stock	Scorcher® 11	100/80-17	2.50 x 17	<b>87-9416</b>
	'17-later Street Rod	Stock	Scorcher® 21	120/70R17		<b>87-9421</b>
	<b>STREET™-- REAR</b>					
	'15-later XG	Stock	Scorcher® 11	140/75R15	3.50 x 15	<b>87-9423</b>
	'17-later Street Rod	Stock	Scorcher® 21	160/60R17		<b>87-9438</b>
	<b>SPORTSTER™-- FRONT</b>					
	'11-later XL1200C	Stock on MY '11-later	Scorcher® 31	130/90B16	3.00 x 16	<b>87-9430</b>
	'10-later XL1200X	Stock on MY '11-later	Scorcher® 31	130/90B16	3.00 x 16	<b>87-9430</b>
	'11-later XL883L	Stock	Scorcher® 11F	120/70ZR18	3.50 x 18	<b>87-9418</b>
	'08-'13 XR1200/X	Stock on MY '12-later	Scorcher® 11F	120/70ZR18	3.50 x 18	<b>87-9418</b>
	'04-later XL (except XL Custom, XL1200T, XL1200X, XL1200V, XR1200/X or '11-later XL883L)	Stock on MY '11-later	Scorcher® 31	100/90B19	2.15 x 19	<b>87-9433</b>
	'12-later XL1200V, '04-'10 XL 883C, '04-10 XL1200C	Approved	Scorcher® 31	80/90-21	2.15 x 21	<b>87-9435</b>
	'14-later XL1200T	Stock	Scorcher® 11T	120/70ZR18	3.50 x 18	<b>87-9419</b>
	<b>SPORTSTER® -- REAR</b>					
	'04-later XL (except XR1200/X, XL1200T or '11-later XL883L)	Stock on MY '11-later (except XL1200V)	Scorcher® 31	150/80B16	3.00 x 16	<b>87-9439</b>
	'08-'13 XR1200/X	Stock on MY '12-later	Scorcher® 11	180/55ZR17	5.50 x 17	<b>87-9426</b>
	'11-later XL883L	Stock	Scorcher® 11	150/60ZR17	4.50 x 17	<b>87-9424</b>
	'14-later XL1200T	Stock	Scorcher® 11T	150/70ZR17	4.50 x 17	<b>87-9425</b>
	<b>DYNA® -- FRONT</b>					
	'06-later Dyna (except FLD, FXDF, FXDFSE and '10-later FXDWG)	Stock MY '10-later	Scorcher® 31	100/90-19	2.15 x 19	<b>87-9433</b>
	'08-later FXDF	Approved	Scorcher® 32	130/90B16	3.00 x 16	<b>87-9436</b>
	'10-later FXDWG	Stock MY '12-later	Scorcher® 31	80/90-21	2.15 x 21	<b>87-9435</b>
	<b>DYNA® -- REAR</b>					
	'08-later FXDF	Approved	Scorcher® 32	180/70B16	5.00 x 16	<b>87-9443</b>
	'06-later Dyna (except FLD, FXDF, FXDFSE and '10-later FXDWG)	Stock MY '10-later	Scorcher® 31	160/70B17	4.50 x 17	<b>87-9441</b>
	'10-later FXDWG	Stock MY '12-later	Scorcher® 31	180/60B17	4.50 x 17	<b>87-9442</b>
	<b>SOFTAIL® -- FRONT</b>					
	'07-later FLSTF, '10-later FLSTFB, '16-later FLSTFBS	Approved	Scorcher® 11	140/75R17	3.50 x 17	<b>87-9417</b>
	<b>SOFTAIL® -- REAR</b>					
	'07-later FLSTF, '10-later FLSTFB, '16-later FLSTFBS	Approved	Scorcher® 11	200/55R17	6.00 x 17	<b>87-9427</b>
	<b>V-ROD® -- FRONT</b>					
	'06 VRSCSE2, '07 VRSCX, '07-10 VRSCAW, '07-08 VRSCD	Approved	Scorcher® 11	120/70ZR19	3.00 x 19	<b>87-9420</b>
	'07-later VRSCDX, '09-later VRSCF	Stock MY '11-later	Scorcher® 11	120/70ZR19	3.00 x 19	<b>87-9420</b>
	<b>V-ROD® -- REAR</b>					
	'06 VRSCSE2, '07 VRSCX, '07-10 VRSCAW, '07-08 VRSCD	Approved	Scorcher® 11	240/40R18	8.00 x 18	<b>87-9428</b>
	'07-later VRSCDX, '09-later VRSCF	Stock MY '11-later	Scorcher® 11	240/40R18	8.00 x 18	<b>87-9428</b>
	<b>TOURING -- FRONT</b>					
	'09-later FLHR, FLHTCU, FLHTCUTC, FL HTCUCL, FLHTCULTC, FLTRU, FLHTK, FLHTKL, FLHTKSE, Optional '09-13 FLHT, FLHTC, FLTR, FLHTCUSE, '09 FLHX, '09-later FLHP/E, FLHTP	Approved	Scorcher® 31	130/80B17	3.00 x 17	<b>87-9431</b>
	'10-13 FLHX and FLTRX, '10 FLHXSE	Approved	Scorcher® 31	130/70B18	3.50 x 18	<b>87-9432</b>
	'15-later FLTRX, FLTRXS, '14-later FLHX, FLHXS, '09-later Touring models equipped with 19" accessory wheels	Approved	Scorcher® 31	130/60B19	3.50 x 19	<b>87-9434</b>
	<b>TOURING -- REAR</b>					
	'09-later FLHR, FLHTCU, FLHTCUTC, FL HTCUCL, FLHTCULTC, FLTRU, FLHTK, FLHTKL, FLHTKSE, Optional '09-13 FLHT, FLHTC, FLTR, FLHTCUSE, '09 FLHX, '09-later FLHP/E, FLHTP	Approved	Scorcher® 31	180/65B16	5.00 x 16	<b>87-9440</b>
	'10-13 FLHX and FLTRX, '10 FLHXSE	Approved	Scorcher® 31	180/65B16	5.00 x 16	<b>87-9440</b>
	'15-later FLTRX, FLTRXS, '14-later FLHX, FLHXS, '09-later Touring models equipped with 19" accessory wheels	Approved	Scorcher® 31	180/65B16	5.00 x 16	<b>87-9440</b>

**MICHELIN® INNER TUBES**

**WPS#**

17" Center Metal Valve Fits 17" 160/70-17 and 180/60-17 tire/rim	<b>87-09551</b>
19" Center Metal Valve Fits 19" 100/90-19 tire/rim	<b>87-09772</b>
19" Center Metal Valve Fits VRSC models with 120/70-19 Radial front tires	<b>87-09772</b>
16" Side Metal Valve Fits 130/90-16, 150/80-16, MT90-16 and MU85-16 tire/rim	<b>87-09481</b>
16" Center Metal Valve Fits 130/90-16, 150/80-16, MT90-16 and MU85-16 tire/rim	<b>87-09482</b>
21" Center Metal Valve Fits 80/90-21 and MH90-21 tire/rim	<b>87-09881</b>

**MICHELIN® Rim Bands**

**WPS#**

17" Center Valve Rim (4.5" x 17" /18")	<b>87-90561</b>
19" Center Valve Rim (1.6" /2.0" x 18" /19")	<b>87-90581</b>
19" VRSC 120/10-19 Radial Rim (2.15" /3" x 17" /18" /19")	<b>87-90561</b>
16" Side Metal Valve Rim (3" x 16")	<b>87-90542</b>
16" Center Metal Valve Rim (3" x 16")	<b>87-90541</b>
21" Center Metal Valve Rim (1.6" /1.85" x 17" /18" /19")	<b>87-90621</b>

**ALWAYS REMEMBER: Monitor your tire pressure frequently, inspect tires for damage and tread wear, and do not overload tires**

- WINDSHIELDS / FAIRINGS
- AUDIO / COMMUNICATION
- SEATS / LUGGAGE
- BARS / MIRRORS / CONTROLS
- EXHAUST
- AIR / FUEL SYSTEMS
- ENGINE
- TRANSMISSION / DRIVELINE
- GASKETS / SEALS
- ELECTRICAL
- LIGHTING
- CABLES
- BRAKES
- OIL FILTERS
- SUSPENSION
- BODY
- WHEELS
- TIRES / TIRE ACC.
- BIKE ACC.
- VICTORY / INDIAN
- COVERS / LOCKS / TIEDOWNS
- CHEMICALS
- TOOLS
- HELMETS
- HELMET ACC.
- EYEWEAR
- APPAREL / RIDER ACC.
- PROMOTIONAL
- REFERENCE
- INDEX

Co-Branded Tires for Harley-Davidson® Motorcycles

**MICHELIN** Scorchers

**MICHELIN** Scorchers



The MICHELIN Co-Branded Tire for Select Harley-Davidson Motorcycles

- Outstanding Grip
- Excellent Tread Life
- Precise Handling

Size	Load/Speed Rating	WPS#
<b>FRONT</b>		
100/80-17	52H	<b>87-9416</b>
140/75-R17	67V	<b>87-9417</b>
120/70-ZR18	59W	<b>87-9418</b>
120/70-ZR18F T	59W	<b>87-9419</b>
120/70-ZR19	60W	<b>87-9420</b>
130/60-B21	63H	<b>87-9414</b>
160/60-R18	70V	<b>87-9415</b>
<b>REAR</b>		
140/75-R15	65H	<b>87-9423</b>
150/60-ZR17	66W	<b>87-9424</b>
150/70-ZR17 T	69W	<b>87-9425</b>
180/55-ZR17	73W	<b>87-9426</b>
200/55-ZR17	78V	<b>87-9427</b>
240/40-R18	79V	<b>87-9428</b>

**MICHELIN** Scorchers



The MICHELIN® Co-Branded Tire for Select Harley-Davidson® Dyna®, Sportster® and Touring Models

- Cruise with Confidence
- Exceptional Comfort and Handling
- Long Mileage

Size	Load/Speed Index	WPS#
<b>FRONT</b>		
130/90B16	73H	<b>87-9430</b>
130/80B17	65H	<b>87-9431</b>
130/70B18	63H	<b>87-9432</b>
100/90B19	57H	<b>87-9433</b>
110/90B19	62H	<b>87-9413</b>
130/60B19	61H	<b>87-9434</b>
80/90B21	54H	<b>87-9435</b>
<b>REAR</b>		
150/80B16	77H	<b>87-9439</b>
180/65B16	81H	<b>87-9440</b>
180/70B16	77H	<b>87-9437</b>
160/70B17	73V	<b>87-9441</b>
180/60B17	75V	<b>87-9442</b>

**MICHELIN** Scorchers



The MICHELIN® Co-Branded Tire for Fat Bob® Motorcycle Riders

- Impressive Durability
- Agile Handling and Smooth Ride
- Dependable Grip

Size	Load/Speed Index	WPS#
<b>FRONT</b>		
130/90B16F	73H	<b>87-9436</b>
<b>REAR</b>		
180/70B16R	77H	<b>87-9443</b>

- WINDSHIELDS / FAIRINGS
- AUDIO / COMMUNICATION
- SEATS / LUGGAGE
- BARS / MIRRORS / CONTROLS
- EXHAUST
- AIR / FUEL SYSTEMS
- ENGINE
- TRANSMISSION / DRIVELINE
- GASKETS / SEALS
- ELECTRICAL
- LIGHTING
- CABLES
- BRAKES
- OIL FILTERS
- SUSPENSION
- BODY
- WHEELS
- TIRES / TIRE ACC.**
- BIKE ACC.
- VICTORY / INDIAN
- COVERS / LOCKS / TIEDOWNS
- CHEMICALS
- TOOLS
- HELMETS
- HELMET ACC.
- EYEWEAR
- APPAREL / RIDER ACC.
- PROMOTIONAL
- REFERENCE
- INDEX



# NIGHT DRAGON / NIGHT DRAGON GT

HIGH PERFORMANCE WITH AN AGGRESSIVE LOOK

NIGHT DRAGON GT



Size	Load/Speed Rating	WPS #
<b>FRONT</b>		
130/90-16	67H	<b>871-2131</b>
130/90-16	73H	<b>871-2133</b>
MT90B-16	72H	<b>871-2132</b>
150/80B-16	71H	<b>871-2134</b>
130/80B-17	62H	<b>871-2135</b>
140/75R-17	67V	<b>871-2136</b>
140/80B-17	69H	<b>871-2137</b>
130/70B-18	63H	<b>871-2140</b>
130/70R-18	63V	<b>871-2139</b>
140/70B-18 REINF	73H	<b>871-2138</b>
100/90-19	57H	<b>871-2142</b>
110/90-19	62H	<b>871-2143</b>
120/70ZR-19	(60W)	<b>871-2144</b>
130/60B-19	61H	<b>871-2174</b>
MH90-21	54H	<b>871-2147</b>
90/90B-21	54H	<b>871-2148</b>
120/70B-21 REINF	68H	<b>871-2145</b>
130/60B-23	65H	<b>871-2149</b>

Size	Load/Speed Rating	WPS #
<b>REAR</b>		
170/80B-15 GT	77H	<b>871-2184</b>
180/70B-15	76H	<b>871-2155</b>
200/70B-15	82H	<b>871-2156</b>
130/90B-16 REINF GT	73H	<b>871-2189</b>
MU85-16 GT	77H	<b>871-2180</b>
MT90B-16 GT	74H	<b>871-2186</b>
150/80B-16 REINF GT	77H	<b>871-2183</b>
180/65B-16 REINF GT	81H	<b>871-2181</b>
180/70R-16	77H	<b>871-2159</b>
160/70B-17 REINF GT	79V	<b>871-2188</b>
170/60R-17	78V	<b>871-2172</b>
180/60B-17	75V	<b>871-2173</b>
180/60B-17 REINF	81H	<b>871-2164</b>
200/55R-17 GT	78V	<b>871-2185</b>
150/70B-18 REINF	76H	<b>871-2167</b>
180/55B-18 REINF GT	80H	<b>871-2187</b>
180/55ZR-18	(74W)	<b>871-2168</b>
200/50ZR-18 REINF GT	82H	<b>871-2190</b>
240/40VR-18	(79V)	<b>871-2169</b>



- WINDSHIELDS / FAIRINGS
- AUDIO / COMMUNICATION
- SEATS / LUGGAGE
- BAR / MIRRORS / CONTROLS
- EXHAUST
- AIR / FUEL SYSTEMS
- ENGINE
- TRANSMISSION / DRIVELINE
- GASKETS / SEALS
- ELECTRICAL
- LIGHTING
- CABLES
- BRAKES
- OIL FILTERS
- SUSPENSION
- BODY
- WHEELS
- TIRES / TIRE ACC.**
- BIKE ACC.
- VICTORY / INDIAN
- COVERS / LOCKS / TIEDOWNS
- CHEMICALS
- TOOLS
- HELMETS
- HELMET ACC.
- EYEWEAR
- APPAREL / RIDER ACC.
- PROMOTIONAL
- REFERENCE
- INDEX





## MT66

### CRUISER

- Designed for wet grip, exceptional handling, riding comfort and durability
- The MT66 will exceed the performance of your OE tires at a very affordable price
- Designed to provide a smooth ride with superior stability
- H-rated for speeds up to 130mph, S-rated for speeds up to 112mph
- TT = Tubetype tire
- REINF = Reinforced

Size	Load/Speed Rating	WPS#
<b>FRONT</b>		
130/90-16	67H	<b>871-2032</b>
150/80-16	71H	<b>871-2034</b>
120/90-17 TT	64S	<b>871-2036</b>
100/90-18	56H	<b>871-2038</b>
3.00-18	47S	<b>871-2039</b>
100/90-19	57H	<b>871-2042</b>
100/90-19 TT	57S	<b>871-2043</b>
110/90-19	62H	<b>871-2044</b>
90/90-19	52H	<b>871-2046</b>
80/90-21 TT	48H	<b>871-2048</b>

Size	Load/Speed Rating	WPS#
<b>REAR</b>		
130/90-15	66S	<b>871-2051</b>
140/90-15	70H	<b>871-2052</b>
150/90-15	74H	<b>871-2053</b>
170/80-15	77H	<b>871-2055</b>
180/70-15	76H	<b>871-2056</b>
130/90-16 REINF	73H	<b>871-2061</b>
140/90-16	71H	<b>871-2062</b>
150/80-16	71H	<b>871-2063</b>
120/90-18	65H	<b>871-2066</b>



- WINDSHIELDS / FAIRINGS
- AUDIO / COMMUNICATION
- SEATS / LUGGAGE
- BARS / MIRRORS / CONTROLS
- EXHAUST
- AIR / FUEL SYSTEMS
- ENGINE
- TRANSMISSION / DRIVELINE
- GASKETS / SEALS
- ELECTRICAL
- LIGHTING
- CABLES
- BRAKES
- OIL FILTERS
- SUSPENSION
- BODY
- WHEELS
- TIRES / TIRE ACC.**
- BIKE ACC.
- VICTORY / INDIAN
- COVERS / LOCKS / TIEDOWNS
- CHEMICALS
- TOOLS
- HELMETS
- HELMET ACC.
- EYEWEAR
- APPAREL / RIDER ACC.
- PROMOTIONAL
- REFERENCE
- INDEX



# CRUISER / TOURING TIRES

Introducing the REFLECTOR!!! The next evolution in motorcycle tire technology. Almost completely un-noticeable until light hits the reflective material on the sidewall and then BOOM...the sidewall of the tire lights up! BE SAFE. BE SEEN!

With a newly re-designed reinforced carcass, the 777 H.D. has higher load ratings and HIGHER MILEAGE! Heavier (Aramid) belting provides ample load capacity while also giving more stability and longer life. Specifically designed for cruiser machines and is available in a multitude of sizes to fit many V-Twin and metric cruiser models.

- Now available in REFLECTIVE sidewall in select sizes
- Higher mileage and load capacity
- H.D. (Heavy Duty) version with reinforced carcass
- H rated tubeless, 4 or 6 ply rated sidewall in select sizes
- Aramid belted (150/80-16, 100/90-19, 90/90-21 nylon belted)



**ARAMID BELTED**



Description		Ply Rating	Load Index	WPS#
<b>FRONT</b>				
130/90-16	H.D.	4	73	<b>87-4585</b>
130/90-16 W/W	H.D.	4	73	<b>87-4586</b>
150/80-16	H.D.	4	71	<b>87-4604</b>
150/80-16 W/W	H.D.	4	71	<b>87-4605</b>
120/90-17		4	64	<b>87-4560</b>
130/80-17		4	65	<b>87-4566</b>
130/80-17 W/W		4	65	<b>87-4567</b>
140/80-17		4	69	<b>87-4561</b>
140/80-17 W/W		4	69	<b>87-4562</b>
120/90-18		4	65	<b>87-4563</b>
130/70-18		4	69	<b>87-4616</b>
130/70-18 W/W		4	69	<b>87-4617</b>
100/90-19	H.D.	4	61	<b>87-4587</b>
100/90-19 W/W	H.D.	4	61	<b>87-4588</b>
100/90-19	H.D. Reflector	4	61	<b>87-4801</b>
110/90-19		4	62	<b>87-4564</b>
130/60-19		4	67	<b>87-4606</b>
130/60-19 W/W		4	67	<b>87-4607</b>
6.5-20	SRT 777	4	77	<b>87-4200</b>
80/90-21	H.D.	4	54	<b>87-4589</b>
90/90-21		4	54	<b>87-4182</b>
90/90-21 W/W		4	54	<b>87-4565</b>
120/70-21	H.D.	4	68	<b>87-4583</b>
120/70-21 W/W	H.D.	4	68	<b>87-4584</b>
130/60-23	H.D.	4	75	<b>87-4581</b>
130/60-23 W/W	H.D.	4	75	<b>87-4582</b>
120/50-26	H.D.	4	73	<b>87-4603</b>
140/40-30		4	57H	<b>87-4580</b>

Description		Ply Rating	Load Index	WPS#
<b>REAR</b>				
150/90-15	H.D.	4	80	<b>87-4590</b>
150/90-15 W/W	H.D.	4	80	<b>87-4591</b>
160/80-15		4	74	<b>87-4572</b>
170/80-15	H.D.	4	83	<b>87-4592</b>
170/80-15 W/W	H.D.	4	83	<b>87-4593</b>
180/70-15	H.D.	4	82	<b>87-4614</b>
180/70-15 W/W	H.D.	4	82	<b>87-4615</b>
130/90-16	H.D.	6	73	<b>87-4594</b>
130/90-16 W/W	H.D.	6	73	<b>87-4595</b>
130/90-16	H.D. Reflector	6	73	<b>87-4800</b>
MU85-16	H.D.	4	77	<b>87-4568</b>
MU85-16 W/W	H.D.	4	77	<b>87-4569</b>
140/90-16	H.D.	4	77	<b>87-4596</b>
150/80-16	H.D.	4	77	<b>87-4597</b>
150/80-16 W/W	H.D.	4	77	<b>87-4598</b>
150/80-16	H.D. Reflector	4	77	<b>87-4805</b>
170/70-16		4	75	<b>87-4573</b>
170/70-16 W/W		4	75	<b>87-4574</b>
180/65-16	H.D.	6	81	<b>87-4599</b>
180/65-16 W/W	H.D.	6	81	<b>87-4600</b>
180/65-16	H.D. Reflector	6	81	<b>87-4809</b>
160/70-17	H.D.	4	79	<b>87-4601</b>
160/70-17 W/W	H.D.	4	79	<b>87-4602</b>
140/70-18	H.D.	4	72	<b>87-4610</b>
140/70-18 W/W	H.D.	4	72	<b>87-4611</b>
150/70-18	H.D.	4	76	<b>87-4612</b>
150/70-18 W/W	H.D.	4	76	<b>87-4613</b>
180/55-18	H.D.	6	84	<b>87-4608</b>
180/55-18 W/W	H.D.	6	84	<b>87-4609</b>



**CRUISER / TOURING TIRES**



**SRT 777 20 INCH**



- Requires Paul Yaffe's 20" big wheel performance SRT Kit for installation
- This is a front tire designed specifically for it's purpose not like other fat front tire conversions that use a rear tire
- Fat 6.5" wide front tire with a true front tire profile and tread ensures superior handling

Description	Ply Rating	Load Index	WPS#
<b>FRONT</b>			
6.5" - 20	SRT 777	4	77 <b>87-4200</b>



**777 30 INCH**



- Specifically designed for the custom 30" front wheel market
- Legendary 777 handling and performance now available in a 30"!
- H-rated tubeless, 6-ply rated.
- Higher mileage and load capacity
- Tread compound designed for a great combination of traction and mileage
- Directional tread pattern offers excellent wet and dry traction
- Aramid belted
- DOT approved

Description	Ply Rating	Load Index	WPS#
<b>FRONT</b>			
140/40-30	4	57H	<b>87-4580</b>



- WINDSHIELDS / FAIRINGS
- AUDIO / COMMUNICATION
- SEATS / LUGGAGE
- BAR / MIRRORS / CONTROLS
- EXHAUST
- AIR / FUEL SYSTEMS
- ENGINE
- TRANSMISSION / DRIVELINE
- GASKETS / SEALS
- ELECTRICAL
- LIGHTING
- CABLES
- BRAKES
- OIL FILTERS
- SUSPENSION
- BODY
- WHEELS
- TIRES / TIRE ACC.**
- BIKE ACC.
- VICTORY / INDIAN
- COVERS / LOCKS / TIEDOWNS
- CHEMICALS
- TOOLS
- HELMETS
- HELMET ACC.
- EYEWEAR
- APPAREL / RIDER ACC.
- PROMOTIONAL
- REFERENCE
- INDEX



# CRUISER / TOURING TIRES

## 230 TOUR MASTER

- Designed for long distance, high speed riding
- Aramid belted
- Staggered tread design offers a quiet ride with excellent handling
- V rated tubeless (unless noted), 4 ply rated



Description	Load Index	WPS#	Description	Load Index	WPS#
<b>FRONT</b>			<b>REAR</b>		
130/90V16	67	<b>87-4165</b>	130/90V15	66	<b>87-4171</b>
150/80H16	71	<b>87-4169</b>	140/90V15	76	<b>87-4175</b>
120/90H17	64	<b>87-4168</b>	150/90V15	80	<b>87-4176</b>
150/80H17	72	<b>87-4166</b>	170/80V15	83	<b>87-4177</b>
100/90V18	56	<b>87-4160</b>	180/70H15	76	<b>87-4178</b>
110/90V18	61	<b>87-4162</b>	130/90V16	73	<b>87-4172</b>
120/90V18	65	<b>87-4164</b>	140/90V16	77	<b>87-4179</b>
100/90V19	57	<b>87-4161</b>	150/80H16	71	<b>87-4130</b>
110/90V19	62	<b>87-4163</b>	130/90V17	74	<b>87-4173</b>
80/90H21	48	<b>87-4167</b>	120/90V18	71	<b>87-4170</b>
			130/90V18	69	<b>87-4174</b>

## 712

- Designed for mileage and performance
- Staggered tread pattern provides excellent wet weather performance
- H rated tubeless, 4 ply nylon carcass



Description	Load Index	WPS#	Description	Load Index	WPS#
<b>FRONT</b>			<b>REAR</b>		
120/80-16	60	<b>87-4143</b>	140/90-15	70	<b>87-4154</b>
100/90-18	56	<b>87-4140</b>	130/90-16	67	<b>87-4152</b>
3.00-18	55	<b>87-4157</b>	130/90-17	68	<b>87-4153</b>
100/90-19	57	<b>87-4141</b>	150/70-17	69	<b>87-4155</b>
110/90-19	61	<b>87-4142</b>	3.50-18	60	<b>87-4158</b>
			100/90-18	56	<b>87-4156</b>
			110/90-18	61	<b>87-4150</b>
			120/90-18	65	<b>87-4151</b>

## 611 AND 718

- Directional tread design for excellent adhesion in both wet and dry conditions
- Aramid belt for added stability under high loads
- H rated tubeless, 4 ply (except 21") nylon carcass



Description	Load Index	WPS#
<b>FRONT 611</b>		
MT90-16	71	<b>87-4120</b>
MM90-19	61	<b>87-4121</b>
MH90-21	56	<b>87-4122</b>
<b>REAR 718</b>		
MT90-16	74	<b>87-4125</b>



CRUISER / TOURING TIRES



**250**

- Designed for both excellent handling and long life
- Available in white side wall
- Aramid belt for high load stability
- H rated tubeless, 4 ply (except 21") nylon carcass



Description	Load Index	WPS#
<b>FRONT</b>		
MT90-16	73	<b>87-4100</b>
MT90-16 W/W	73	<b>87-4101</b>
MJ90-19	56	<b>87-4103</b>
MH90-21	56	<b>87-4104</b>
<b>REAR</b>		
MT90-16 A/B	74	<b>87-4105</b>
MT90-16 W/W	74	<b>87-4106</b>



**CLASSIC 240**

- Compounded for high mileage
- Also available in single and double stripe white side wall
- Aramid belt offsets tread distortion for better grip and durability
- H rated tube type, 4 ply nylon carcass



Description	Load Index	Fitment	WPS#
<b>240 CLASSIC</b>			
MT90-16	74	F/R	<b>87-4110</b>
MT90-16 W/W	74	F/R	<b>87-4111</b>
MT90-16 Double W/W	74	F/R	<b>87-4112</b>
100/90-19	63	F	<b>87-4115</b>
100/90-19 W/W	63	F	<b>87-4116</b>



**270**

- Classic full aspect ratio sawtooth design
- Available in white side wall
- Full 4 ply rated nylon carcass for extended wear with a classic appearance
- S speed rated, tube type

Description	Ply Rating	Speed Rating	Load Index	Fitment	WPS #
<b>SUPER CLASSIC 270</b>					
5.00-16	4	S	69	F/R	<b>87-4620</b>
5.00-16 W/W	4	S	69	F/R	<b>87-4621</b>
4.00-18	4	H	64	F/R	<b>87-4624</b>
4.00-18 W/W	4	H	64	F/R	<b>87-4626</b>
4.50-18	4	H	70	F/R	<b>87-4628</b>
4.50-18 W/W	4	H	70	F/R	<b>87-4632</b>
4.00-19	4	H	61	F	<b>87-4622</b>
4.00-19 W/W	4	H	61	F	<b>87-4623</b>
3.00-21	6	S	57	F	<b>87-4633</b>
3.00-21 W/W	6	S	57	F	<b>87-4634</b>

- WINDSHIELDS / FAIRINGS
- AUDIO / COMMUNICATION
- SEATS / LUGGAGE
- BAR / MIRRORS / CONTROLS
- EXHAUST
- AIR / FUEL SYSTEMS
- ENGINE
- TRANSMISSION / DRIVELINE
- GASKETS / SEALS
- ELECTRICAL
- LIGHTING
- CABLES
- BRAKES
- OIL FILTERS
- SUSPENSION
- BODY
- WHEELS
- TIRES / TIRE ACC.**
- BIKE ACC.
- VICTORY / INDIAN
- COVERS / LOCKS / TIEDOWNS
- CHEMICALS
- TOOLS
- HELMETS
- HELMET ACC.
- EYEWEAR
- APPAREL / RIDER ACC.
- PROMOTIONAL
- REFERENCE
- INDEX



**DRAG / RACE RADIALS**

**HOOK-UP PRO DRAG RADIAL**

- The ultimate DOT drag tire.....Just got better!!
- HOOK-UP PRO! All of the great features of the original Hook-Up, but lighter, faster and now even better at the top-end of the track! Competition-developed design allows for more horsepower to be used throughout the run due to a larger contact patch at high speed. Enhanced carcass resists distortion, chunking, and the stresses of centrifugal force to maintain a more constant footprint.
- Due to the soft compound of this tire, it is not for use on dynamometers!



*Ultra Lightweight!  
Hook-Up Like A Pro!*

Description	Speed Rating	Load Index	WPS#
190/50ZR17	W	73	<b>87-4651P</b>
200/50ZR17	W	75	<b>87-4652P</b>

**HOOK-UP DRAG RADIAL**

- Light weight extremely flexible carcass
- Softest street compound available from Shinko
- Tread pattern and profile designed specifically for the demands of drag racing
- Aramid belted, DOT approved, not intended for use on public roads or street use
- Combine with the Shinko 003 Stealth front tire for a matching tread pattern
- Due to the soft compound of this tire, it is not for use on dynamometers!



Description	Speed Rating	Load Index	WPS#
180/55ZR17	W	73	<b>87-4650</b>
190/50ZR17	W	73	<b>87-4651</b>
200/50ZR17	W	75	<b>87-4652</b>

**STEALTH-D**

- Specifically designed for V-Twin Drag racing
- DOT approved
- Ultra-Soft compound for maximum traction
- "W" speed rated (168 mph) DOT approved
- Fits right onto your stock 16" wheel!!



Stacey Bortz is the fastest female in the world of American V-Twin drag racing. She has run as fast as 8.86 seconds in the quarter mile with speeds over 150 MPH. She uses Shinko tires on her AMRA Outlaw Street bike as well as her 10 second Superglide.

Description	Speed Rating	WPS#
150/80ZR16	W	<b>87-4002U</b>

**REACTOR III**

**REACTOR DRAG SLICK**

- NEW light weight design
- Wider footprint and softer sidewall
- Wrinkle wall drag slick, for track use only
- Tread compound designed for maximum traction
- 26" x 7" x 17" size fits most sport bike rear wheels
- Recommended rim width 5½" to 7½"



Description	WPS #
26" x 7" - 17	<b>87-4656</b>

**SPECIALTY TIRES**



**FLAT TRACK SR267/268**

Description	Soft	Medium	Hard
<b>FRONT</b>			
130/80-19 (27.0 x 7.0-19)	<b>87-4750S</b>	<b>87-4750M</b>	<b>87-4750H</b>
<b>REAR</b>			
140/80-19 (27.5 x 7.5-19)	<b>87-4751S</b>	<b>87-4751M</b>	<b>87-4751H</b>
<b>JUNIOR FRONT/REAR</b>			
120/70-17	<b>87-4752S</b>		

**SPORT TOURING RADIALS**



**011 VERGE RADIAL**



Description	Speed Rating	Load Index	WPS#
<b>FRONT</b>			
120/60ZR17	W	55	<b>87-4080</b>
120/70ZR17	W	58	<b>87-4081</b>
140/75VR17	V	67	<b>87-4079</b>
120/70ZR18	W	59	<b>87-4082</b>
130/60VR23	V	65	<b>87-4088</b>
<b>REAR</b>			
150/80ZR16	W	71	<b>87-4090</b>
160/60ZR17	W	69	<b>87-4091</b>
170/60ZR17	W	72	<b>87-4092</b>
180/55ZR17	W	73	<b>87-4093</b>
190/50ZR17	W	73	<b>87-4094</b>
200/50ZR17	W	75	<b>87-4095</b>
200/55VR17	V	67	<b>87-4087</b>
200/50VR18	V	76	<b>87-4096</b>
300/35VR18	V	87	<b>87-4089</b>

- WINDSHIELDS / FAIRINGS
- AUDIO / COMMUNICATION
- SEATS / LUGGAGE
- BARS / MIRRORS / CONTROLS
- EXHAUST
- AIR / FUEL SYSTEMS
- ENGINE
- TRANSMISSION / DRIVELINE
- GASKETS / SEALS
- ELECTRICAL
- LIGHTING
- CABLES
- BRAKES
- OIL FILTERS
- SUSPENSION
- BODY
- WHEELS
- TIRES / TIRE ACC.**
- BIKE ACC.
- VICTORY / INDIAN
- COVERS / LOCKS / TIEDOWNS
- CHEMICALS
- TOOLS
- HELMETS
- HELMET ACC.
- EYEWEAR
- APPAREL / RIDER ACC.
- PROMOTIONAL
- REFERENCE
- INDEX



**PERFORMANCE HEAVY DUTY  
TAPERED TUBES**



TR-4

Fits Tire Size	Stem Type	WPS#
4.50/5.10-17 HD	TR-4	87-0362
3.50/4.00-18 HD	TR-4	87-0370
400/460-18 HD	TR-4	87-0372
4.50/5.10-18 HD	TR-4	87-0376
100-110/90-19 HD	TR-4	87-0384
110-120/90-19 HD	TR-4	87-0385
2.75/3.00-21 HD	TR-4	87-0386

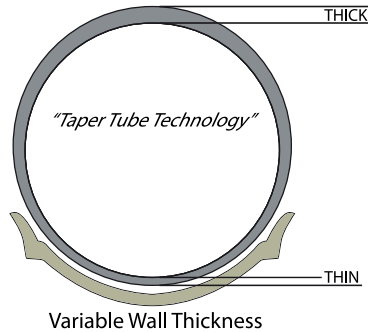

**MOTORCYCLE TUBES**

Constructed of ultra-high grade synthetic and natural rubber for long life and pinch resistance



TR-87  
JS-244A

TR-6

TR-13

TR-15

TR-15 Side  
same as - at angle  
or reference Only

Fits Tire Size	Stem Type	WPS#
170/80-15	TR-4	87-0147
4.00/4.50-16	TR-4	87-0148
5.00/5.10-16	TR-6 side	87-0150
5.00/5.10-16	TR-6	87-0151
5.00/5.10-16	TR-15	87-0152
3.25/3.50-17	TR-4	87-0158
3.50/4.00-17	TR-4	87-0163
4.00/4.50-17	TR-4	87-0159
4.50/5.10-17	TR-4	87-0160
4.00/4.50-18	TR-4	87-0172
4.50/5.10-18	TR-4	87-0174
5.00/5.10-18	TR-4	87-0176
100-110/90-19	TR-4	87-0184
100-120/90-19	TR-4	87-0185
2.75/3.00-21	TR-4	87-0186
3.25/3.50-21	TR-4	87-0188



**INNER TUBE SIZING CHART**

INCH:	2.75/3	3.25	3.5	3.75/4	4.25/4.5	5.00/5.1	5.5	6
IC								

- WINDSHIELDS / FAIRINGS
- AUDIO / COMMUNICATION
- SEATS / LUGGAGE
- BARS / MIRRORS / CONTROLS
- EXHAUST
- AIR / FUEL SYSTEMS
- ENGINE
- TRANSMISSION / DRIVELINE
- GASKETS / SEALS
- ELECTRICAL
- LIGHTING
- CABLES
- BRAKES
- OIL FILTERS
- SUSPENSION
- BODY
- WHEELS
- TIRES / TIRE ACC.**
- BIKE ACC.
- VICTORY / INDIAN
- COVERS / LOCKS / TIEDOWNS
- CHEMICALS
- TOOLS
- HELMETS
- HELMET ACC.
- EYEWEAR
- APPAREL / RIDER ACC.
- PROMOTIONAL
- REFERENCE
- INDEX



**INNER TUBES**



TR-4 TR-6 TR-13

TR-15 Side



TR-87 JS-244A TR-15

Fits Tire Size	Stem Type	WPS#
<b>STREET TUBES</b>		
140/90-15, 150/90-15	TR-87	<b>87-0930</b>
170/80-15, 180/70-15	TR-87	<b>87-0930</b>
120/90-16, 130/90-16	TR-4 offset	<b>87-09482</b>
120/90-16, 130/90-16	TR-87	<b>87-09481</b>
140/90-16, 150/80-16	TR-4 offset	<b>87-09482</b>
140/90-16, 150/80-16	TR-87	<b>87-09481</b>
MT90/MU85-16	TR-4 offset	<b>87-09482</b>
MT90/MU85-16	TR-87	<b>87-09481</b>
120/70-17	TR-4	<b>87-09553</b>
130/70-17	TR-4	<b>87-09552</b>
130/90-17, 140/80-17, 150/70-17, 160/70-17	TR-4	<b>87-09551</b>
110/90-18, 130/70-18	TR-4	<b>87-09752</b>
100/90-19, 110/90-19	TR-4	<b>87-09772</b>
90/90-21, MH90-21	TR-4	<b>87-09881</b>
140/80-17	TR-4	<b>87-0951</b>
120/90-18, 130/80-18 Ultra Heavy Duty	TR-4	<b>87-09751</b>
120/90-18, 130/80-18	TR-4	<b>87-09741</b>
140/80-18	TR-4	<b>87-09741</b>
140/80-18 Ultra Heavy Duty	TR-4	<b>87-0987</b>
4.00-18 Heavy Duty	TR-4	<b>87-0973</b>
100/90-19, 120/80-19	TR-4	<b>87-09781</b>
100/90-19, 110/90-19 Ultra Heavy Duty	TR-4	<b>87-09791</b>
110/90-19, 130/70-19	TR-4	<b>87-09801</b>
120/80-19, 130/70-19 Ultra Heavy Duty	TR-4	<b>87-09791</b>
80/90-21, 80/100-21	TR-4	<b>87-0985</b>
90/90-21, 90/100-21	TR-4	<b>87-0985</b>
2.50/2.75/3.00-21	TR-4	<b>87-0985</b>
2.75-21 Heavy Duty	TR-4	<b>87-0988</b>
90/90-21, 80/100-21 Ultra Heavy Duty	TR-4	<b>87-09861</b>



**HEAVY DUTY INNER TUBES**



Tube sizes	Stem Type	WPS#
2.75/3.75, 70/100-17	TR-4	<b>871-0173</b>
130/90 - 160/70-17	TR-4	<b>871-0172</b>
150/70-18	TR-4	<b>871-0186</b>
100/90 - 120/90-19	TR-4	<b>871-0195</b>
90/90-21	TR-4	<b>871-0214</b>
90/90, 80/100-21	TR-4	<b>871-0215</b>

- WINDSHIELDS / FAIRINGS
- AUDIO / COMMUNICATION
- SEATS / LUGGAGE
- BAR / MIRRORS / CONTROLS
- EXHAUST
- AIR / FUEL SYSTEMS
- ENGINE
- TRANSMISSION / DRIVELINE
- GASKETS / SEALS
- ELECTRICAL
- LIGHTING
- CABLES
- BRAKES
- OIL FILTERS
- SUSPENSION
- BODY
- WHEELS
- TIRES / TIRE ACC.**
- BIKE ACC.
- VICTORY / INDIAN
- COVERS / LOCKS / TIEDOWNS
- CHEMICALS
- TOOLS
- HELMETS
- HELMET ACC.
- EYEWEAR
- APPAREL / RIDER ACC.
- PROMOTIONAL
- REFERENCE
- INDEX

- WINDSHIELDS / FAIRINGS
- AUDIO / COMMUNICATION
- SEATS / LUGGAGE
- BARS / MIRRORS / CONTROLS
- EXHAUST
- AIR / FUEL SYSTEMS
- ENGINE
- TRANSMISSION / DRIVELINE
- GASKETS / SEALS
- ELECTRICAL
- LIGHTING
- CABLES
- BRAKES
- OIL FILTERS
- SUSPENSION
- BODY
- WHEELS
- TIRES / TIRE ACC.**
- BIKE ACC.
- VICTORY / INDIAN
- COVERS / LOCKS / TIEDOWNS
- CHEMICALS
- TOOLS
- HELMETS
- HELMET ACC.
- EYEWEAR
- APPAREL / RIDER ACC.
- PROMOTIONAL
- REFERENCE
- INDEX



## MOTORCYCLE TUBES

Fits Tire Size	Stem Type	WPS#
140/90, 150/90-15	TR-4	<b>87-5920</b>
170/80-15	PV-78	<b>87-5921</b>
4.00/4.60-16	TR-4	<b>87-5928</b>
5.10-16, 130/90-16	TR-4	<b>87-5932</b>
3.25/3.50-17	TR-4	<b>87-5938</b>
3.25/4.10-19	TR-4	<b>87-5956</b>
100/90-19 Heavy Duty	TR-4	<b>87-5968</b>
2.75/3.00-21	TR-4	<b>87-5958</b>
80/100-21 Heavy Duty	TR-4	<b>87-5972</b>
2.75/3.00-23	TR-4	<b>87-5962</b>



PV-78



TR-4



TR-15

or reference Only

## EXTRA WIDE RIM STRIPS

Size	WPS#
16" Rim Strip 3" Wide	<b>87-90543</b>
17" Rim Strip 2.5" Wide	<b>87-90562</b>
18" Rim Strip 2" Wide	<b>87-90582</b>



## RIM STRIPS

Rim Size	Width	WPS#	
10"	21mm	<b>87-90461</b>	10/pk
12"	22mm	<b>87-90481</b>	10/pk
14"	24mm	<b>87-90501</b>	10/pk
15"	24mm	<b>87-90521</b>	10/pk
16"	38mm	<b>87-90541</b>	10/pk
16" (side valve)		<b>87-90542</b>	10/pk
17"	21mm	<b>87-90561</b>	10/pk
18"	30mm	<b>87-90581</b>	10/pk
19"	24mm	<b>87-90601</b>	10/pk
21"	24mm	<b>87-90621</b>	10/pk



**INNER TUBES**



- High quality 1.5mm thick butyl tube pre-loaded with Counteract Balancing Beads
- Balanced for the life of the tire
- Extend tire life, even tread wear, increases horsepower due to decreased rolling resistance.
- Provides the smoothest and most efficient ride possible
- No need for unsightly wheel weights or a tire balancer
- Cost effective
- Will not void tire warranties

Size	Stem Type	WPS#
2.50/2.75-10	TR-6	85-4045
3.00/3.50-10	TR-6	85-4044
2.50/2.75-12	TR-6	85-4043
3.00/3.50-12	TR-6	85-4042
170/80-15	TR-6	85-4041
5.00/5.10-16	TR-6	85-4030
5.00/5.10-16 side stem	TR-6	85-4046
5.00/5.10-16	TR-87	85-4031
2.50/3.00-17	TR-6	85-4040

Size	Stem Type	WPS#
4.00/4.50-17	TR-6	85-4033
6.00/6.50-17	TR-6	85-4032
4.00/4.60-18	TR-6	85-4034
5.00/5.10-18 w/out rim lock	TR-6	85-4035
5.00/5.10-18 w/rim lock	TR-6	85-4039
3.50/4.00-19	TR-6	85-4036
2.75/3.00-21	TR-6	85-4037
2.75/3.00-23	TR-6	85-4038

**TIRE BALANCING BEADS**

- No more external weights!
- Made from micro-glass beads
- Increases tire life, improves fuel economy
- Reduced vibration and heat build up
- Tires are balanced all the time, not just at over 30 mph like other products
- No rebalancing every time you come to a stop
- No dust to clog valve cores
- Guaranteed safe for all tire pressure monitoring systems (TPMS)
- Can be used in tube type and tubeless tires
- Simply throw in a bag when mounting a new tubeless tire or use the DIY kit for "on the bike" and tube type installation

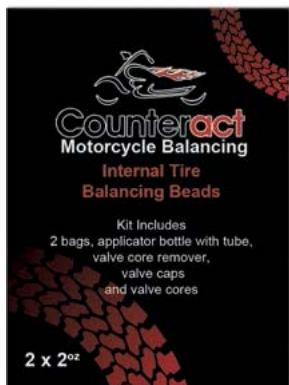

**Application Chart**

MOTORCYCLE	Application	WPS #
Front 80mm-120mm tire width	1 oz	85-4000
Front 130mm and up tire width	2 oz	85-4001
Rear 130mm-200mm width	2 oz	85-4008
Rear 210mm-360mm tire width	3 oz	85-4009
Rear 195mm-205mm car tire	3 oz	85-4002

**DIY Kits**

DIY Kits	WPS #
<b>INC. BALANCING BEADS AND INSTALLATION BOTTLE</b>	
Motorcycle, 2 - 1 oz bags	85-4000
Motorcycle, 2 - 2 oz bags	85-4001
Motorcycle, 1 - 1 oz bag, 1 - 2 oz bag	85-4008
Motorcycle, 1 - 1 oz bag, 1 - 3 oz bag	85-4009
Motorcycle, 1 - 2 oz bag, 1 - 3 oz bag	85-4002
Trike, 1 - 2 oz bag, 2 - 3 oz bags	85-4003
<b>SHOP PACKS (ORDER 1 QTY = 4 PACK UNLESS NOTED)</b>	
1 oz bag	85-4010
2 oz bag	85-4011
3 oz bag	85-4012
16 oz bag (order 1 = 28 bags)	85-4018

- WINDSHIELDS / FAIRINGS
- AUDIO / COMMUNICATION
- SEATS / LUGGAGE
- BAR / MIRRORS / CONTROLS
- EXHAUST
- AIR / FUEL SYSTEMS
- ENGINE
- TRANSMISSION / DRIVELINE
- GASKETS / SEALS
- ELECTRICAL
- LIGHTING
- CABLES
- BRAKES
- OIL FILTERS
- SUSPENSION
- BODY
- WHEELS
- TIRES / TIRE ACC.**
- BIKE ACC.
- VICTORY / INDIAN
- COVERS / LOCKS / TIEDOWNS
- CHEMICALS
- TOOLS
- HELMETS
- HELMET ACC.
- EYEWEAR
- APPAREL / RIDER ACC.
- PROMOTIONAL
- REFERENCE
- INDEX



## VALVE STEM CAPS

- Add some spice to your wheels
- Available in fun designs and colors
- Sold in pairs

Description	WPS#
A Black Dice	820-2500B
B Chrome Dice	820-2500C
C Gold Dice	820-2500G
D Blue Dice	820-2500BU
E Red Dice	820-2500R
F 8 Ball	820-2501
G Chrome Skull, for Metal Stem	820-2502
Chrome Skull, for Center Stem	820-2503
H Chrome Bullet	820-2504C
I Gold Bullet	820-2504G



## VALVE STEMS

Description	WPS#	Sold
A Pop-in 412 series .453"	85-0447	4/pack
	85-0447B	50/pack
B Chrome .327"	85-0448	4/pack
C Pop-in 413 series .453"	85-0449	4/pack
	85-0449B	50/pack
D Chrome .453"/.625"	85-0450	4/pack
E 90° .327"	85-0445	4/pack
	85-0446	4/pack



- Pop-in valve stem seals well in OEM and aftermarket rims
- Shorter for ATV applications



- Threaded full 1-3/16" length for various rim thicknesses
- Fits .327" valve hole and equipped with O-ring seal



- Pop-in valve meets the same rigid standards required for OEM applications
- Designed to resist damage from ozone and premature rubber deterioration from valve hole compression, heat, cold and moisture



- Chrome plated sealing valve cap
- Grommets to fit either .453 or .625" valve holes



- 90° valve stem style
- 85-0435 fits .327 valve hole
- 85-0436 fits .453 or .625



## VALVE CORE REMOVER

- Made from Hex Steel
- Allows for easy removal and installation of standard valve cores

WPS#  
57-8183





WINDSHIELDS / FAIRINGS  
 AUDIO / COMMUNICATION  
 SEATS / LUGGAGE  
 BARS / MIRRORS / CONTROLS  
 EXHAUST  
 AIR / FUEL SYSTEMS  
 ENGINE  
 TRANSMISSION / DRIVELINE  
 GASKETS / SEALS  
 ELECTRICAL  
 LIGHTING  
 CABLES  
 BRAKES  
 OIL FILTERS  
 SUSPENSION  
 BODY  
 WHEELS  
**TIRES / TIRE ACC.**  
 BIKE ACC.  
 VICTORY / INDIAN  
 COVERS / LOCKS / TIEDOWNS  
 CHEMICALS  
 TOOLS  
 HELMETS  
 HELMET ACC.  
 EYEWEAR  
 APPAREL / RIDER ACC.  
 PROMOTIONAL  
 REFERENCE  
 INDEX



### LED SMART CAPS

- Ride-On LED Smart Caps are the easiest TPMS (Tire Pressure Monitoring System) to install on your tire valve stems
- The LED Smart Caps automatically calibrate to the pressure in the tire and sets itself when the cap are installed
- TPMS caps can be used with pressures from 10 psi to 70 psi
- Automatically compensates for ambient temperature changes to avoid false alarms
- Comes with integrated anti-theft device
- Ride-On TPMS LED Smart Caps blink red to alert of low pressure for up to 750 hours
- Low battery alarm - the LED Smart Caps will blink yellow for up to 100 hours to alert you that the batteries are running low
- Uses standard watch batteries
- Bright blinking LED light that is visible in daylight and night time

Description	WPS#
LED Smart Caps/pr	85-4210
Repl. anti-theft wrench	85-4211

The purchase of Ride-On LED Smart Caps entitles you to a free 1 year membership to Ride-On's exclusive road side assistance program

### SPOKED WHEEL WEIGHTS



- Weights are made from quality Zinc
- They are Non-Lead Compliant
- Sold in packs of 10

Description	WPS#
1/4 oz	232-7091
1/2 oz	232-7092
3/4 oz	232-7093
1 oz	232-7094



### WHEEL WEIGHTS



- Perfect size for use on motorcycles
- Applies to cast aluminum and spoke wheels
- Adhesive backing holds weight securely
- Will not come off in extreme conditions
- 6 Strips of 12, 1/4 oz. weights per card = 72 pieces
- 90oz. box contains 30 strips with 12 segments per strip

Description	Color	WPS#
1/4 oz Steel	Silver	57-80454
1/4 oz Steel 90oz. box	Silver	57-80452
1/4 oz Steel	Black	57-80455
1/4 oz Steel 90oz. box	Black	57-80453
1/4 oz Steel	Nickel	57-80498
1/4 oz Steel 90oz. box	Nickel	57-80484
1/8 oz Steel 144pcs.	Silver	57-80552
1/8 oz Steel 144pcs.	Black	57-80553



**SPIN TRUE WHEEL WEIGHTS**



- CNC Machined, Chrome Plated Stainless Steel
- Lead Free
- 6-Different Weights to Choose From
- .25oz, .5oz, .75oz, 1oz, 1.25oz and 1.5oz (10 of each size in kits)
- Symmetrical Halves Lock Onto the Nipple
- Fits 0.250" to 0.300" Nipple Diameters (SMALL)
- Fits 0.300" to 0.350" Nipple Diameters (LARGE)

Description	WPS#
60 PC Kit Large Nipples	<b>191-40001</b>
60 PC Kit Small Nipples	<b>191-40002</b>
6 Piece Kit Large Nipples	<b>191-40003</b>
6 Piece Kit Small Nipples	<b>191-40004</b>
.25 Oz Weight Refill 10 Pk Small	<b>191-40005</b>
.50 Oz Weight Refill 10 Pk Small	<b>191-40007</b>
.50 Oz Weight Refill 10 Pk Large	<b>191-40008</b>
.75 Oz Weight Refill 10 Pk Small	<b>191-40009</b>
.75 Oz Weight Refill 10 Pk Large	<b>191-40010</b>
1 Oz Weight Refill 10 Pk Small	<b>191-40011</b>
1 Oz Weight Refill 10 Pk Large	<b>191-40012</b>
1.25 Oz Weight Refill 10 Pk Small	<b>191-40013</b>
1.25 Oz Weight Refill 10 Pk Large	<b>191-40014</b>
1.5 Oz Weight Refill 10 Pk Small	<b>191-40015</b>
1.5 Oz Weight Refill 10 Pk Large	<b>191-40016</b>
Wheel Weight Screws 240 Pk	<b>191-40017</b>
Wheel Weight Screws 120 Pk	<b>191-40018</b>
Wheel Weight Screws 40 Pk	<b>191-40019</b>



191-40005



191-40007



191-40009



191-40015



WINDSHIELDS / FAIRINGS  
 AUDIO / COMMUNICATION  
 SEATS / LUGGAGE  
 BARS / MIRRORS / CONTROLS  
 EXHAUST  
 AIR / FUEL SYSTEMS  
 ENGINE  
 TRANSMISSION / DRIVELINE  
 GASKETS / SEALS  
 ELECTRICAL  
 LIGHTING  
 CABLES  
 BRAKES  
 OIL FILTERS  
 SUSPENSION  
 BODY  
 WHEELS  
**TIRES / TIRE ACC.**  
 BIKE ACC.  
 VICTORY / INDIAN  
 COVERS / LOCKS / TIEDOWNS  
 CHEMICALS  
 TOOLS  
 HELMETS  
 HELMET ACC.  
 EYEWEAR  
 APPAREL / RIDER ACC.  
 PROMOTIONAL  
 REFERENCE  
 INDEX



### TPS TIRE BALANCER AND SEALANT

- Ride-On TPS (Tire Protection System) is a tire balancer and sealant compound for tube or tubeless tires that evenly coats the inner surface of your tires
- Eliminates the need wheel weights, specially formulated to hydro-dynamically balance high speed tires, dampen road noise and vibrations that cause a rough ride
- If the tire is punctured in the contact patch, the centrifugal force of the rotating tire and the internal air pressure force Ride-On into the hole, sealing it instantly
- Ride-On is a Green biodegradable product that is designed to be non-hazardous and non-flammable, and contains corrosion inhibitors that protect all alloys of steel, aluminum, magnesium and yellow metals against oxidation
- Note: Refer to Dosage table/calculator to find the amount needed for each tire
- Ride-On TPS will act as a balancer and will result in erroneous readings from a dynamic spin balancer
- Available in motorcycle and ATV formulas, simply squeeze/pump the fluid into the tires and you are set to go, refer to dosage table below to find the amount needed for each tire

**IMPORTANT NOTE:** After installing Ride-On TPS Motorcycle Formula sealant into the tires, a slight vibration may be noticed until the sealant has warmed up and distributed evenly in the tires. This process usually takes 2 to 5 miles. DO NOT attempt to rebalance tires after the installation of Ride-On TPS Motorcycle Formula. Ride-On TPS is a balancing compound

Description	WPS#
<b>MOTORCYCLE FORMULA</b>	
8 oz	12/case <b>85-4200</b>
5 gallon pail	* <b>85-4201</b>
Pump for 5 gallon pail	<b>85-4202</b>

\*DOES NOT COME WITH PUMP

#### RIDE-ON DOSAGE (all measurements in inches):

High speed street tires: Diameter x Width x .055 = ounces of Ride-On  
 Off road tires: Diameter x Width x .075 = ounces of Ride-On  
 ATV tires: Diameter x Width x .087

### TIRE COVERAGE PLUS PROGRAM

The TCP/24 program is a comprehensive benefit program that is available with the purchase and installation of Ride-On TPS from select motorcycle repair shops and dealerships. It is for all on-road motorcycles, trikes, scooters and mopeds (non-commercial use). TCP/24 cards are sold to dealers in packs of 10. **Only one TCP/24 card is needed per vehicle, cards will be shipped direct from Ride-On to the dealership.**

#### The TCP/24 membership program includes the following:

- 1 Year membership in the program
- 24 Hour emergency towing up to 15 miles
- 24 Hour emergency road service (includes battery service and fluid/fuel delivery)
- Travel benefits and trip routing
- Trip interruption protection
- Online travel discounts
- Rental car and hotel discounts
- Theft and hit-and-run coverage
- Program covers street/dual sport motorcycles and trikes only



Description	WPS#
TCP/24 cards	<b>85-TCP24</b> 10/pack
Roadside Assistance cards	<b>85-RSA</b> 6/pack

### ROADSIDE ASSISTANCE PROGRAM

The Roadside Assistance Program includes all items listed above without the tire repair/replacement benefit. Purchase/installation of Ride-On TPS is not mandatory with the basic Roadside Assistance Program. **Roadside assistance cards are sold each and will ship from the nearest WPS warehouse.**

- WINDSHIELDS / FAIRINGS
- AUDIO / COMMUNICATION
- SEATS / LUGGAGE
- BARS / MIRRORS / CONTROLS
- EXHAUST
- AIR / FUEL SYSTEMS
- ENGINE
- TRANSMISSION / DRIVELINE
- GASKETS / SEALS
- ELECTRICAL
- LIGHTING
- CABLES
- BRAKES
- OIL FILTERS
- SUSPENSION
- BODY
- WHEELS
- TIRES / TIRE ACC.**
- BIKE ACC.
- VICTORY / INDIAN
- COVERS / LOCKS / TIEDOWNS
- CHEMICALS
- TOOLS
- HELMETS
- HELMET ACC.
- EYEWEAR
- APPAREL / RIDER ACC.
- PROMOTIONAL
- REFERENCE
- INDEX



**SUPER DUTY AND ORIGINAL FORMULA**

**“THE FLAT TIRE ELIMINATOR”**

In tubeless tires the SLIME seal is as effective as a normal repair. In tubed tires, regard SLIME in the same way as you would a patch. If you would be content riding a patched tube, then the SLIME seal is fine. If you regard the patch as a “get you home” emergency repair, then fit a new tube. SLIME can be easily removed with cold water. There is no other product like SLIME on the market. There are no glues, no latex, no adhesives in its formulation. SLIME is the most innovative breakthrough in flat tire prevention.

- Uses:**  
 Motorcycle's / ATVs  
 Bicycles  
 Golf Carts  
 Utility Vehicles  
 Wheel Chairs  
 Wheelbarrows  
 Agriculture  
 Any pneumatic tire tube or tubeless



Application:	Ounces per tire
Motorcycle	8
Bicycle	4
Wheelbarrow	8
Boat/Snowmobile	8
Trailer	
Compact car/Lt.Truck	8
4x4/SUV	8
ATV	16-32
Riding Mower	20

- Super duty slime seals punctures up to ¼”
- Fine tunes balance of all tires
- Will not freeze down to -35°, dry-out or ball-up inside the tire
- Prevents corrosion of the tire and rim
- SLIME is formulated to last as long as the life of your tire

**Or simply use this formula**

Under 45 mph:

Tread Width (inches) x Height (inches) x .13 = \_\_\_\_\_ oz.                      Example 8 x 22 x .13 = 23 oz.

Over 45 mph:

(Tread Width (inches) x Height (inches) x .13) /2 = \_\_\_\_\_ oz.                      Example (8 x 22 x .13)/2 = 12 oz.

Description	WPS#
<b>SUPER DUTY FOR TUBELESS TIRES</b>	
8 oz - 6/case	<b>85-2019</b>
16 oz - 6/case	<b>85-2017</b>
24 oz - 6/case	<b>85-2034</b>
32 oz - 6/case	<b>85-2033</b>
1 gal - 2/case	<b>85-2018</b>
5 gal keg	<b>85-2020</b>

Description	WPS#
<b>ORIGINAL FORMULA FOR TUBE TYPE TIRES</b>	
8 oz - 6/case	<b>85-2008</b>
16 oz - 6/case	<b>85-2016</b>

Description	WPS#
<b>ACCESSORIES</b>	
Pump for 5 gal bucket	<b>85-2028</b>
32oz Bead SealantI - 6/case	<b>85-1044</b>

**ASK ABOUT AVAILABLE DISPLAY RACKS**



# BIG BIKE PARTS<sup>®</sup>

## TIRE PRESSURE MONITORING SYSTEM



WPS#  
94-13318



## TIRE INFLATOR



Description	WPS #
Tire Inflator with 16oz Slime	85-2035
Tire Inflator only	85-2037



## SMART SPAIR TIRE REPAIR KIT

Description	WPS #
Smart Spair 5/case	85-2036



Size	WPS#
1"	85-2023

## SKABS™ Pre-Glued Patches

- WINDSHIELDS / FAIRINGS
- AUDIO / COMMUNICATION
- SEATS / LUGGAGE
- BAR / MIRRORS / CONTROLS
- EXHAUST
- AIR / FUEL SYSTEMS
- ENGINE
- TRANSMISSION / DRIVELINE
- GASKETS / SEALS
- ELECTRICAL
- LIGHTING
- CABLES
- BRAKES
- OIL FILTERS
- SUSPENSION
- BODY
- WHEELS
- TIRES / TIRE ACC.**
- BIKE ACC.
- VICTORY / INDIAN
- COVERS / LOCKS / TIEDOWNS
- CHEMICALS
- TOOLS
- HELMETS
- HELMET ACC.
- EYEWEAR
- APPAREL / RIDER ACC.
- PROMOTIONAL
- REFERENCE
- INDEX

- WINDSHIELDS / FAIRINGS
- AUDIO / COMMUNICATION
- SEATS / LUGGAGE
- BARS / MIRRORS / CONTROLS
- EXHAUST
- AIR / FUEL SYSTEMS
- ENGINE
- TRANSMISSION / DRIVELINE
- GASKETS / SEALS
- ELECTRICAL
- LIGHTING
- CABLES
- BRAKES
- OIL FILTERS
- SUSPENSION
- BODY
- WHEELS
- TIRES / TIRE ACC.**
- BIKE ACC.
- VICTORY / INDIAN
- COVERS / LOCKS / TIEDOWNS
- CHEMICALS
- TOOLS
- HELMETS
- HELMET ACC.
- EYEWEAR
- APPAREL / RIDER ACC.
- PROMOTIONAL
- REFERENCE
- INDEX

# BLU

TECHNOLOGY PRODUCTS

## BLUETOOTH® TIRE PRESSURE MONITORING SYSTEM

Description	WPS#
2 tire external sensor	71-9160
2 tire internal sensor	71-9162
3 tire external sensor	71-9163
3 tire internal sensor	71-9164
4 tire external sensor	71-9165
4 tire internal sensor	71-9166



TIRE REPAIR



A



B



C



D



E



G



H



I



F



K



L

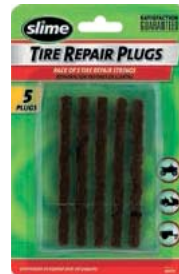

M



N



J



O



P



Q



R

Description

WPS#

TIRE REPAIR ACCESSORIES

A	Foot Pump	85-2063
B	0-99 psi Digital Gauge	85-1038
C	1-20 psi Low Pressure Gauge	85-1010
D	10-50 psi Pencil Gauge (Color Anodized)	85-1012
E	1-20 psi Dial Gauge w/Bleed Valve	85-1037
F	5-60 psi Dial Gauge w/Bleed Valve Chrome	85-1036
G	Reamer Plugger Kit (Screwdriver Type For Softer, Thinner Tires)	85-1032
H	Reamer Plugger Kit (T-Handle Type Steel Belted Tires)	85-1034
I	22pc Tire Tackle w/Box	85-1043

Description

WPS#

TIRE REPAIR ACCESSORIES (cont'd...)

J	9pc Tire Tackle T-Handle w/Box	85-1045
K	Rubber Patch Kit	85-1022
L	Classic Rubber Repair Patch Kit	85-4060
M	5pc Plug Pack	85-1031
N	30pc Plug Pack	85-1041
O	6pc Skabs Pre-Glued Patches	85-2023
P	Tire Marker White	85-1046
Q	4pc Valve Cores Short	85-1047
R	2pc Tubeless Valves 1¼" Tr 413 45	85-1042

WINDSHIELDS / FAIRINGS  
 AUDIO / COMMUNICATION  
 SEATS / LUGGAGE  
 BARS / MIRRORS / CONTROLS  
 EXHAUST  
 AIR / FUEL SYSTEMS  
 ENGINE  
 TRANSMISSION / DRIVELINE  
 GASKETS / SEALS  
 ELECTRICAL  
 LIGHTING  
 CABLES  
 BRAKES  
 OIL FILTERS  
 SUSPENSION  
 BODY  
 WHEELS  
**TIRES / TIRE ACC.**  
 BIKE ACC.  
 VICTORY / INDIAN  
 COVERS / LOCKS / TIEDOWNS  
 CHEMICALS  
 TOOLS  
 HELMETS  
 HELMET ACC.  
 EYEWEAR  
 APPAREL / RIDER ACC.  
 PROMOTIONAL  
 REFERENCE  
 INDEX

*The Original*  
**Ryder Balls®**  
By RyderClips

Description	WPS #
A Crazy Clown	26-7100
B Bad Girl	26-7101
C Eagle Head	26-7102
D Flames	26-7103
E Iron Cross	26-7104
F Live To Ride	26-7105
G Never Ride Faster Than Your Angel Can Fly	26-7106
H Peace	26-7107
I Pink Ribbon	26-7108
J Spider Web	26-7109
K 3 Skulls	26-7110
L V-Twin Engine	26-7111
M Wicked Skull	26-7112



A



B



C



D



E



F



G



H



I



J



K



L



M

- WINDSHIELDS / FAIRINGS
- AUDIO / COMMUNICATION
- SEATS / LUGGAGE
- BARS / MIRRORS / CONTROLS
- EXHAUST
- AIR / FUEL SYSTEMS
- ENGINE
- TRANSMISSION / DRIVELINE
- GASKETS / SEALS
- ELECTRICAL
- LIGHTING
- CABLES
- BRAKES
- OIL FILTERS
- SUSPENSION
- BODY
- WHEELS
- TIRES / TIRE ACC.
- BIKE ACC.**
- VICTORY / INDIAN
- COVERS / LOCKS / TIEDOWNS
- CHEMICALS
- TOOLS
- HELMETS
- HELMET ACC.
- EYEWEAR
- APPAREL / RIDER ACC.
- PROMOTIONAL
- REFERENCE
- INDEX

## GARAGE DOOR OPENER REMOTE



Flat black



Gloss black



- Garage door opener mounts in place of the OEM front master cylinder cover for an ultra clean look
- Works with garage door, gate and commercial door openers that are 315 or 390 MHz and have a learn/programming button (inc. most all models with pet safety sensors)



“Let us open your garage door”



Application	Year	Flat Black	Gloss Black
<b>HARLEY-DAVIDSON</b>			
Dyna	'06-17	<b>12-8902FBK</b>	<b>12-8902GBK</b>
Softail	'06-14	<b>12-8902FBK</b>	<b>12-8902GBK</b>
Sportster	'04-16	<b>12-8903FBK</b>	<b>12-8903GBK</b>
Touring	'05-07	<b>12-8902FBK</b>	<b>12-8902GBK</b>
	'08-13	<b>12-8901FBK</b>	<b>12-8901GBK</b>
V-Rod	'06-17	<b>12-8901FBK</b>	<b>12-8901GBK</b>



## GARAGE DOOR/GATE OPENER



The Flash2Pass system turns your existing headlight high-beam switch into a transmitter to open and close your garage door or gate.



A



B



C

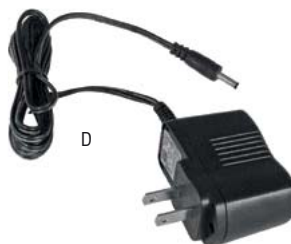

D

- Uses an encrypted radio frequency (RF) signal
- Safely and conveniently opens doors/gates; eliminates the need to carry and use a standard, push button door opener
- No extra switches or buttons needed, activated by the double clicking of the headlight high beam or other 12 volt switch
- Works with any vehicle with a 12-Volt electrical system: motorcycles, cars, trucks, ATVs, snowmobiles, golf carts
- Proprietary receiver operates with virtually all automatic garage door or gate opener brands manufactured from 1982 to the present
- Easy, DIY instructions; installs in less than 15 minutes with standard household tools

### Details

- Unobstructed range of more than 100 feet
- Weatherproof transmitter
- Patented technology
- 1-year limited warranty
- Made in the USA

Description	WPS#
A Flash2Pass kit	<b>71-9030</b>
<b>REPLACEMENT PARTS AND ACCESSORIES</b>	
B Transmitter	<b>71-9031</b>
C Receiver	<b>71-9032</b>
D AC adapter *	<b>71-9033</b>

\* Optional AC adapter for the receiver unit may be needed if the system does not function properly.

- WINDSHIELDS / FAIRINGS
- AUDIO / COMMUNICATION
- SEATS / LUGGAGE
- BARS / MIRRORS / CONTROLS
- EXHAUST
- AIR / FUEL SYSTEMS
- ENGINE
- TRANSMISSION / DRIVELINE
- GASKETS / SEALS
- ELECTRICAL
- LIGHTING
- CABLES
- BRAKES
- OIL FILTERS
- SUSPENSION
- BODY
- WHEELS
- TIRES / TIRE ACC.
- BIKE ACC.
- VICTORY / INDIAN
- COVERS / LOCKS / TIEDOWNS
- CHEMICALS
- TOOLS
- HELMETS
- HELMET ACC.
- EYEWEAR
- APPAREL / RIDER ACC.
- PROMOTIONAL
- REFERENCE
- INDEX

- WINDSHIELDS / FAIRINGS
- AUDIO / COMMUNICATION
- SEATS / LUGGAGE
- BAR / MIRRORS / CONTROLS
- EXHAUST
- AIR / FUEL SYSTEMS
- ENGINE
- TRANSMISSION / DRIVELINE
- GASKETS / SEALS
- ELECTRICAL
- LIGHTING
- CABLES
- BRAKES
- OIL FILTERS
- SUSPENSION
- BODY
- WHEELS
- TIRES / TIRE ACC.
- BIKE ACC.
- VICTORY / INDIAN
- COVERS / LOCKS / TIEDOWNS
- CHEMICALS
- TOOLS
- HELMETS
- HELMET ACC.
- EYEWEAR
- APPAREL / RIDER ACC.
- PROMOTIONAL
- REFERENCE
- INDEX



## GPSMAP 276Cx



If you're a jack-of-all-trades, you need a GPS navigator that's as versatile as you are. Take a look at the GPSMAP 276Cx. With a large 5-inch display, versatile cartography, connected features and flexible power options, it has the capability to function the best way for you.



Description	WPS#
A 276Cx GPS Unit	<b>989-1404</b>
<b>ACCESSORIES</b>	
Anti-Glare Screen Protector	<b>989-1405</b>
B Protective Storage Cover	<b>989-1406</b>
C Replacement Battery	<b>989-1407</b>
D 12v Car Power Cable	<b>989-1408</b>

B

### The Mapping You Want

- Almost anywhere you want to go, GPSMAP 276Cx has a compatible map to take you there. It comes preloaded with worldwide basemap and includes a free 1-year BirdsEye Satellite Imagery subscription. It also supports a variety of other mapping options such as Garmin TOPO maps, Garmin HuntView™ maps, BlueChart® g2 HD marine charts, turn-by-turn directions on City Navigator® NT, Garmin Custom Maps, raster maps and vector maps.

### The Connected Navigator

- In addition to GPS and GLONASS reception, GPSMAP 276Cx is ANT+® compatible for the integration of external sensors like the Tempe™ ambient temperature sensor. You can even connect it to Wi-Fi® for over-the-air updates and Garmin Connect™ database syncs. Pair with your compatible mobile device¹ for additional features like LiveTrack and smart notifications¹.

### Tough and Ready

- GPSMAP 276Cx was designed for your rugged lifestyle. You'll navigate with confidence by seeing clearly on the large 5-inch sunlight-readable screen. The navigator's flexible mounting lets you keep the device exactly where you need it. Operate GPSMAP 276Cx with its reliable push-button controls that resist dirt, dust and grit, and best of all -- keep all your maps on hand with 8 GB of internal memory, expandable by a microSD™ card (sold separately).

### More Power Options

- Get peace of mind knowing that the GPSMAP 276Cx GPS navigator is going to be ready when you need it, now that there are more ways to power your device. It features in-unit charging with an included lithium-ion battery pack and even has the ability to use standard AA batteries.

### 276Cx ALL-TERRAIN GPS NAVIGATOR

- Internal antenna with GPS and GLONASS satellite reception for tracking in more challenging environments than GPS alone; for better reception in vehicle interiors add an external antenna (sold separately) to the built-in MCX connector
- Built-in worldwide basemap and free 1-year BirdsEye Satellite Imagery subscription
- Supports Garmin TOPO maps, Garmin HuntView™ maps, BlueChart® g2 HD marine charts and more
- Supports Active Weather forecasts and animated weather tracking
- Pairs with your compatible smartphone¹ for automatic uploads, smart notifications and more

#### Includes:

- GPSMAP 276Cx
- 1 year BirdsEye Satellite Imagery subscription¹
- AMPS powered mounting bracket with marine bail mount
- Lithium-ion rechargeable battery pack
- USB cable
- AC charger
- Quickstart Guide



C



D

# ZUMO 595LM NAVIGATOR



Zumo® 595LM motorcycle GPS navigator offers a premium navigation experience with adventurous routing for those twisty, thrilling rides, along with a big 5-inch sunlight-readable touchscreen, Bluetooth® connectivity for hands-free calling, music streaming from Pandora® and Spotify®, smart notifications<sup>4</sup> plus rider alerts to encourage a safer ride. You're warned of sharp curves, animal crossings, nearby red light, speed cameras and more.



Description	WPS#
595LM Navigator	989-1385

- Large 5-inch dual-orientation touchscreen display that is glove friendly and easy to read — even in bright sunlight
- Rugged design withstands fuel vapors, UV rays, rain and harsh weather, IPX7 rated
- Garmin Adventurous Routing™ lets you avoid major highways and find curvy, hilly roads—even see upcoming elevation information.
- Rider alerts for upcoming sharp curves, animal crossings, state helmet laws, wrong way on a one-way street, fatigue warning and more
- Warnings for nearby red light and speed cameras, where applicable
- Lets you control music and media from compatible MP3 player or smartphone right on your Zumo® navigator display — and even streams Pandora® and Spotify® music services
- Preloaded with detailed 3-D terrain maps of North America, plus lifetime<sup>1</sup> map updates
- Hands-free phone control and spoken directions heard in-helmet via Bluetooth® technology, with compatible headset
- Smart notifications<sup>4</sup> (calls/texts, calendar updates, etc.) via free Smartphone Link app
- LiveTrack tool lets you use free Smartphone Link app<sup>4</sup> to wirelessly share your live route — great for riding in groups
- Motorcycle-specific points of interest (POIs) for cycle repair services, dealers, etc.
- Live weather radar and live traffic via Smartphone Link<sup>4</sup> app (subscription may be required)
- PhotoReal and Bird's Eye junction views with Active Lane Guidance help you navigate interchanges with ease
- Easily see places along your route and milestones up ahead, without leaving the map
- Easy Route Shaping feature lets you easily add a point on the map to ride through preferred areas or follow specific roads
- Spoken Garmin Real Directions™ feature guides like a friend, using recognizable landmarks, buildings and traffic lights
- Foursquare® data for millions more new and popular places
- Service history log helps simplify your record keeping for bike maintenance
- Round trip routing lets you plan your ride based on time, distance or location
- TracBack® feature makes it easy to follow the same route for your return trip
- Supports custom and TOPO maps (additional mapping sold separately)
- Easily find addresses and millions of points of interest
- Displays current street, current speed, speed limit and arrival time
- Compatible with VIRB® action cameras (sold separately); start and stop recording right from your Zumo® navigator display
- Monitor motorcycle tire pressure on Zumo® display with TPMS accessory<sup>6</sup> (sold separately)
- Motorcycle and automotive mounts included
- Music and Media control work with iPhone® 4 or later, some iPod® devices, and some Android™ devices.

- WINDSHIELDS / FAIRINGS
- AUDIO / COMMUNICATION
- SEATS / LUGGAGE
- BAR / MIRRORS / CONTROLS
- EXHAUST
- AIR / FUEL SYSTEMS
- ENGINE
- TRANSMISSION / DRIVELINE
- GASKETS / SEALS
- ELECTRICAL
- LIGHTING
- CABLES
- BRAKES
- OIL FILTERS
- SUSPENSION
- BODY
- WHEELS
- TIRES / TIRE ACC.
- BIKE ACC.**
- VICTORY / INDIAN
- COVERS / LOCKS / TIEDOWNS
- CHEMICALS
- TOOLS
- HELMETS
- HELMET ACC.
- EYEWEAR
- APPAREL / RIDER ACC.
- PROMOTIONAL
- REFERENCE
- INDEX



# ZUMO 395LM NAVIGATOR

Zumo® 395LM motorcycle GPS navigator offers adventurous routing for those twisty, thrilling rides, along with a glove-friendly, sunlight-readable 4.3-inch touchscreen, Bluetooth® connectivity<sup>2</sup> for hands-free calling, control for music<sup>7</sup> from MP3 player or smartphone free lifetime maps<sup>1</sup> and innovative rider alerts to encourage a safer ride. You're warned of sharp curves, animal crossings, nearby red light and speed cameras<sup>3</sup> and more.



Description	WPS#
395LM M/C Navigator	989-1384

- Glove-friendly, sunlight-readable 4.3-inch touchscreen display
- Rugged design withstands fuel vapors, UV rays, rain and harsh weather, IPX7 Rated
- Garmin Adventurous Routing™ lets you avoid major highways and find curvy, hilly roads—even see upcoming elevation information.
- Rider alerts for upcoming sharp curves, speed changes, state helmet laws, wrong way on a one-way street, fatigue warning and more
- Warnings for nearby red light and speed cameras, where applicable
- Lets you control music and media from compatible MP3 player or smartphone right on your zmo navigator display
- Preloaded with detailed maps of North America with free lifetime<sup>1</sup> updates
- Hands-free phone control and spoken directions heard in-helmet via Bluetooth® technology, with compatible BT headset
- Motorcycle-specific points of interest (POIs) for cycle repair services, dealers, etc.
- Lane assist with junction view eases navigation of complex interchanges
- Easily see places along your route and milestones up ahead, without leaving the map
- Easy Route Shaping feature lets you easily add a point on the map to ride through preferred areas or follow specific roads

- Spoken Garmin Real Directions™ feature guides like a friend, using recognizable landmarks, buildings and traffic lights
- Foursquare® data for millions more new and popular places
- Service history log helps simplify your record keeping for bike maintenance
- Round trip routing lets you plan your ride based on time, distance or location
- TracBack® feature makes it easy to follow the same route for your return trip
- Supports custom and TOPO maps (additional mapping sold separately)
- Easily find addresses and millions of points of interest
- Displays current street, current speed, speed limit and arrival time
- Compatible with VIRB® action cameras (sold separately); start and stop recording right from your Zumo® navigator display
- Monitor motorcycle tire pressure on Zumo® display with TPMS accessory (sold separately)
- Motorcycle and automotive mounts included



ZUMO ACCESSORIES



Accessories	WPS#
<b>590LM/595LM</b>	
A 12v Power Cable	989-1399
B TPMS Valve Cap (Sold Each)	989-1396
C MC Mount	989-1402
D Repl. Battery	989-1403
<b>660LM/665LM</b>	
E Vehicle Power Cable	989-1392
F Portable Mount	989-1393
Ram Plate for BMW	71-7220
G Mini USB cable	989-1351
<b>395LM</b>	
A 12v Power Cable	989-1399
B TPMS Valve Cap (Sold Each)	989-1396
H Power Cable (hardwire for motorcycle)	989-1400
I Motorcycle Mount	989-1401



FENIX 3 WATCH

- High Resolution Color Display – 1.2" Sunlight readable color ChromaTMdisplay
- Altimeter, Barometer, 3-axis Compass, Thermometer
- Wirelessly sync with BaseCamp Mobile for Adventure Search/Creation
- Store up to 10,000 Tracks, 1,000 Waypoints, and navigate to them
- Remotely control your VIRB Elite action camera
- Connect IQ compatibility to download apps to watch

Description	WPS#
Fenix 3 Watch	989-1305



WINDSHIELDS / FAIRINGS

AUDIO / COMMUNICATION

SEATS / LUGGAGE

BAR / MIRRORS / CONTROLS

EXHAUST

AIR / FUEL SYSTEMS

ENGINE

TRANSMISSION / DRIVELINE

GASKETS / SEALS

ELECTRICAL

LIGHTING

CABLES

BRAKES

OIL FILTERS

SUSPENSION

BODY

WHEELS

TIRES / TIRE ACC.

**BIKE ACC.**

VICTORY / INDIAN

COVERS / LOCKS / TIEDOWNS

CHEMICALS

TOOLS

HELMETS

HELMET ACC.

EYEWEAR

APPAREL / RIDER ACC.

PROMOTIONAL

REFERENCE

INDEX



## FENIX 5 WATCH

- **Wrist-Based Heart Rate Elevate™**-Wrist-based heart rate gives you 24/7 monitoring — no chest strap required<sup>1</sup>
- **Ruggedized For Adventure-Fit** for adventure with rugged design featuring stainless steel bezel, buttons and rear case
- **Glass Or Sapphire Lenses**-Choose from a model with vibrant glass lens or scratch-resistant sapphire lens
- **Training Statistics**-Get key stats at your fingertips with the performance widget that shows your training status, training load and more
- **Multiple Sport/Activity Profiles**-Preloaded activity profiles for all of your sports and adventures
- **Wi-Fi®-Enabled**-Wi-Fi-enabled for automatic activity uploads directly to Garmin Connect™ online fitness community when connected to wireless networks (available in Sapphire versions only)
- **Connected Features**-Includes smart notifications<sup>2</sup>, automatic uploads to Garmin Connect and personalization through free watch faces and apps from our Connect IQ™ store
- **Quickfit Bands**-A selection of QuickFit bands in your choice of premium leather, metal or silicone makes it easy to mix and match styles to go with any sport or activity (no tools required — just swap, click and go)
- **Navigator + ABC**-Built-in navigation sensors include 3-axis compass, gyroscope and barometric altimeter as well as GPS and GLONASS capability to track in more challenging environments
- **FENIX 5X**-includes preloaded maps with TOPO U.S. mapping, routable cycling maps, 40,000 golf courses and other outdoor navigation features



A



B



C

	Description	WPS#
A	Fenix 5X 52mm Watch	989-1352
B	Fenix 5 47mm Watch	989-1353
C	Fenix 5S 42mm Watch	989-1354

- WINDSHIELDS / FAIRINGS
- AUDIO / COMMUNICATION
- SEATS / LUGGAGE
- BARS / MIRRORS / CONTROLS
- EXHAUST
- AIR / FUEL SYSTEMS
- ENGINE
- TRANSMISSION / DRIVE SHAFT
- GASKETS / SEALS
- ELECTRICAL
- LIGHTING
- CABLES
- BRAKES
- OIL FILTERS
- SUSPENSION
- BODY
- BIKE ACC.
- VICTORY / INDIAN
- COVERS / LOCKS / TIEDOWNS
- CHEMICALS
- TOOLS
- HELMETS
- HELMET ACC.
- EYEWEAR
- APPAREL / RIDER ACC.
- PROMOTIONAL
- REFERENCE
- INDEX

# VIRB™ ULTRA 30 ACTION CAMERA



- Ultra HD video - Crystal-clear 4K/30fps footage, 1080p/120fps or slow motion capability at 720p/240fps
- G-Metrix - GPS data overlays help prove how far, how high and how fast you went
- LCD color touchscreen - 1.75-inch display is easy to operate; fully functional in and out of waterproof case
- Voice control - Shoot hands-free by using voice commands to start/stop recording, take a photo or tag footage
- 3-axis image stabilization - Captures steady footage up to 1080p/60fps
- High-sensitivity microphone - Captures clear audio, even in windy conditions or underwater
- Automatic video creation - Create videos that show off the best moments from your activity
- 1-touch live streaming (for compatible Apple® devices) - Share your video with friends in real-time
- Simple, 1-touch controls and dedicated “instant on” record switch to turn on the camera and start/stop recording; use the separate photo button to capture still images
- Presets let you save camera configurations for fast setup when switching operation
- Auto pause sensing: starts recording when VIRB® starts moving; avoids capturing boring footage before activity begins
- Photo - 12 megapixels; burst up to 60 frames per second

- in wide mode (8 megapixels); night shots, time lapse, extended time lapse and travelapse photo capture
- Multicamera sync - VIRB Edit® software syncs clips from multiple angles based on GPS time
- Custom, wide-angle aspherical glass lens: maximum image sharpness, lowest distortion above and below water
- Built-in motion sensors sync to video, using 10 Hz GPS, gyroscope, compass, altimeter and accelerometer to capture motion data
- VIRB® Ultra 30 works with many compatible Garmin devices using ANT+® wireless technology to remotely control the camera and capture sensor data for performance data sharing or display on footage
- Free VIRB® app turns your compatible smartphone or tablet into a Wi-Fi® remote control for your camera; lets you view and control multiple cameras, add G-Metrix™ overlays, select highlight clips, live-stream3 footage online and more
- Free VIRB® Edit software lets you easily create and edit video. Add music and/or G-Metrix™ animated data graphs and gauges to your footage; share with friends online

Description	WPS#
Garmin VIRB Ultra 30 Camera	989-1309



## ACCESSORIES

Description	WPS#
Rechargeable Lithium Battery pack	989-1411
Dual Battery Charger	989-1410
Head Strap	989-1334
Chest Strap Mount	989-1336
Small Tube Mount	989-1338

Description	WPS#
Large Tube Mount	989-1339
Suction Mount	989-1342
Mount Base Kit	989-1343
360 Mount Base Kit	989-1344
Adjustable Mounting Arm Kit	989-1345

Description	WPS#
Cycling Combo Mount	989-1346
Wireless Temp Sensor	989-1373
Vehicle power cable	989-1329

## MICRO SD CARDS

- Class 10 micro SD memory cards
- Works with most all cameras, tablets, cell phones, GPS and more
- Includes adapter

Description	WPS#
8 GB	510-1510
16 GB	510-1511
32 GB	510-1512
64 GB	510-1513



- WINDSHIELDS / FAIRINGS
- AUDIO / COMMUNICATION
- SEATS / LUGGAGE
- BARS / MIRRORS / CONTROLS
- EXHAUST
- AIR / FUEL SYSTEMS
- ENGINE
- TRANSMISSION / DRIVELINE
- GASKETS / SEALS
- ELECTRICAL
- LIGHTING
- CABLES
- BRAKES
- OIL FILTERS
- SUSPENSION
- BODY
- WHEELS
- TIRES / TIRE ACC.
- BIKE ACC.
- VICTORY / INDIAN
- COVERS / LOCKS / TIEDOWNS
- CHEMICALS
- TOOLS
- HELMETS
- HELMET ACC.
- EYEWEAR
- APPAREL / RIDER ACC.
- PROMOTIONAL
- REFERENCE
- INDEX



**VIRB™ 360 CAMERA**



If it's worth remembering, it's worth a VIRB® 360. With one touch or a voice command, this rugged, waterproof camera captures fully-spherical 360-degree video in up to 5.7K/30 fps resolution with 360-degree audio, and it includes built-in sensors for augmented reality G-Metrix™ data overlays. 4K spherical stabilization ensures smooth video regardless of camera movement. Videos and photos are automatically stitched in camera, enabling fast sharing as well as instant livestreaming with the free, easy-to-use VIRB Mobile app.



- Video Resolution 5.7K/30 FPS unstitched, 5K/30FPS unstitched, 4K/30FPS Stitched
- 360 Audio 4 Microphones
- Stabilization Modes (up to 4K) 3 Modes: Stabilize, Lock, Follow
- Water Rating 10m
- Replaceable Glass Cover Lens
- Works with VIRB Mobile App and VIRB Edit on desktop Control, edit, stabilize, share and add G-Metrix overlays
- Livestream to Facebook and YouTube iOS only
- Connectivity Wi-Fi®, Bluetooth®, NFC (one-tap connection w/ Android), ANT+
- Field of View 360 degrees vertical and horizontal
- Android and IOS Compatible
- Battery Life Rechargeable Lithium-Ion, up to 1 hour 5 minutes
- Voice Control
- Photo Resolution Up to 15MP (stitched-in-camera)
- Photo Modes Single Capture, Burst Shooting, Time Lapse, Travelapse
- Sensors barometer, accelerometer, gyroscope & compass
- Real-Time 360 Viewing with VIRB Mobile App
- VR Compatible
- VR Mode with VIRB Mobile App Immediate Playback with VR Headsets
- Memory up to 128GB microSD card; UHS-I, class U3 or higher (sold separately)

Description	WPS#
Garmin Virb® 360	989-1415

**ACCESSORIES**

Accessories	WPS #
Virb USB Power Adapter	989-1326
A Heart Rate Monitor	989-1331
Chest Strap Mount	989-1336
B Wrist Strap Mount	989-1337
Small Tube Mount	989-1338
C Large Tube Mount	989-1339
D Vented Helmet Strap	989-1340

Accessories	WPS #
E Tripod Mount	989-1341
F Suction Mount	989-1342
G Mount Base Kit	989-1343
H Adj Mounting Arm Kit	989-1345
I Cycling Combo Mount	989-1346
Replacement Battery	989-1412
Dual Battery Charger	989-1413
Powered Tripod Mount	989-1414





**VIRB® X CAMERA**



The Garmin VIRB® X action camera shoots rich, high definition, video at 1080p/30fps, 12MP photos at up to 10 frames per second. The rugged compact camera fits every activity and all conditions with a waterproof rating of 50 meters, with no case needed. VIRB® X features an intuitive user menu and one touch control switch, making it incredibly easy to use. Combined with VIRB® App on your smart phone VIRB® X even provides live preview before and during recording, remote control, and editing/transfer of video for sharing. G-Metrix™ creates true excitement by recording video and data at the same time so you can add auto-synched gauges and graphs with speed, distance, g-force and more.

Description	WPS#
Garmin® VIRB™ X	<b>989-1306</b>

**ACCESSORIES**

Description	WPS#
Lithium Battery pack	<b>989-1347</b>
AA Battery Pack	<b>989-1333</b>
Head Strap	<b>989-1334</b>
Rugged Power Cable	<b>989-1335</b>
Chest Strap Mount	<b>989-1336</b>
Wrist Strap Mount	<b>989-1337</b>
Small Tube Mount	<b>989-1338</b>
Large Tube Mount	<b>989-1339</b>
Vented Helmet Strap	<b>989-1340</b>
TriPod Mount	<b>989-1341</b>
Suction Mount	<b>989-1342</b>

Description	WPS#
Mount Base Kit	<b>989-1343</b>
360 Mount Base Kit	<b>989-1344</b>
Adjustable Mounting Arm Kit	<b>989-1345</b>
Cycling Combo Mount	<b>989-1346</b>
Battery Pack	<b>989-1347</b>
Charge Cable	<b>989-1348</b>
Replacement Repair Kit	<b>989-1349</b>
Anti-Fog Desiccants	<b>989-1350</b>
USB Power adapter	<b>989-1326</b>
Vehicle Power Cable	<b>989-1329</b>

For more mounting options see pages 832-839 for Ram Mounts

**GO PRO CAMERA MOUNT**

- This billet aluminum mount allows for 360 degree rotation to allow you set your camera precisely to your preferred field of view.
- This mount is also compatible with all of the camera's supplied mounting accessories so that you can mount the camera perpendicular to the bar and more.



Description	Black WPS#	Silver WPS#	# clamps needed
Go Pro camera mount	<b>12-9158</b>	<b>12-9207</b>	1

**UNIVERSAL CLAMPS**

- This universal mounting bracket allows you to mount just about anything to your roll cage
- This bracket clamps around your tubing giving you the ability to mount roofs, speaker bars, speaker pods, cameras, racks, lights, gun racks, etc.



Description	Black WPS#	Silver WPS#
0.875" Strap Clamp	<b>12-9180</b>	<b>12-9129</b>
1.0" Strap Clamp	<b>12-9181</b>	<b>12-9130</b>
1.125" Strap Clamp	<b>12-9131</b>	<b>12-9132</b>
1.25" Strap Clamp	<b>12-9182</b>	<b>12-9133</b>
1.5" Strap Clamp	<b>12-9150</b>	<b>12-9250</b>
1.625" Strap Clamp	<b>12-9184</b>	<b>12-9134</b>
1.7" Strap Clamp	<b>12-9151</b>	<b>12-9135</b>
1.75" Strap Clamp	<b>12-9152</b>	<b>12-9252</b>
1.85" Strap Clamp	<b>12-9136</b>	<b>12-9137</b>
1.875" Strap Clamp	<b>12-9185</b>	<b>12-9138</b>
2.0" Strap Clamp	<b>12-9153</b>	<b>12-9253</b>
2.25" Strap Clamp	<b>12-9139</b>	<b>12-9140</b>
2.375" Strap Clamp	<b>12-9141</b>	<b>12-9142</b>
2.5" Strap Clamp	<b>12-9143</b>	<b>12-9144</b>
2.625" Strap Clamp	<b>12-9145</b>	<b>12-9146</b>
2.75" Strap Clamp	<b>12-9147</b>	<b>12-9148</b>
2.875" Strap Clamp	<b>12-9149</b>	<b>12-9223</b>
3.0" Strap Clamp	<b>12-9169</b>	<b>12-9224</b>
3.25" Strap Clamp	<b>12-9170</b>	<b>12-9225</b>

WINDSHIELDS / FAIRINGS  
 AUDIO / COMMUNICATION  
 SEATS / LUGGAGE  
 BARS / MIRRORS / CONTROLS  
 EXHAUST  
 AIR / FUEL SYSTEMS  
 ENGINE  
 TRANSMISSION / DRIVELINE  
 GASKETS / SEALS  
 ELECTRICAL  
 LIGHTING  
 CABLES  
 BRAKES  
 OIL FILTERS  
 SUSPENSION  
 BODY  
 WHEELS  
 TIRES / TIRE ACC.  
 BIKE ACC.  
 VICTORY / INDIAN  
 COVERS / LOCKS / TIEDOWNS  
 CHEMICALS  
 TOOLS  
 HELMETS  
 HELMET ACC.  
 EYEWEAR  
 APPAREL / RIDER ACC.  
 PROMOTIONAL  
 REFERENCE  
 INDEX

WINDSHIELDS / FAIRINGS  
 AUDIO / COMMUNICATION  
 SEATS / LUGGAGE  
 BARS / MIRRORS / CONTROLS  
 EXHAUST  
 AIR / FUEL SYSTEMS  
 ENGINE  
 TRANSMISSION / DRIVELINE  
 GASKETS / SEALS  
 ELECTRICAL  
 LIGHTING  
 CABLES  
 BRAKES  
 OIL FILTERS  
 SUSPENSION  
 BODY  
 WHEELS  
 TIRES / TIRE ACC.  
 BIKE ACC.  
 VICTORY / INDIAN  
 COVERS / LOCKS / TIEDOWNS  
 CHEMICALS  
 TOOLS  
 HELMETS  
 HELMET ACC.  
 EYEWEAR  
 APPAREL / RIDER ACC.  
 PROMOTIONAL  
 REFERENCE  
 INDEX

**ADAPTIV™**  
 TECHNOLOGIES

**TPX™ PRO RADAR/LASER DETECTOR**

- Superior radar and laser detection performance
- Equipped with GPS data points for Red Light Camera and Radar Camera locations
- Free lifetime monthly GPS data points updates
- Six selectable detection modes
- Ability to turn Radar Detection and GPS functions on and off
- Specifically designed for motorcycle use; water, shock, and vibration resistant
- Detects all radar and laser bands and is certified by Speed Measurement Labs
- Audio and visual alerts
- Oversize, backlit control buttons, easy to operate even with gloves on
- Angled, backlit, daylight visible liquid crystal display
- 3.5mm auxiliary out jack for integration with other audio or communication systems, including Bluetooth systems with use of TPX Bluetooth Transceiver (sold separately)
- Optional TPX Wireless Headset for in helmet audio alerts (sold separately)
- Includes Visual Alert, Wiring Harness, Universal Mount Plate Adapter with hardware
- Industry leading 2 year warranty



WPS#  
**71-9101**

**TPX™ 2.0 RADAR/LASER DETECTOR**

- Version 2.0 features increased detection sensitivity and 3 additional user modes compared to the original version Adaptiv detectors
- Specifically designed for motorcycle use, water, shock, and vibration resistant
- Detects all radar and laser bands and is certified by Speed Measurement Labs
- Audio and visual alerts
- Oversize, backlit control buttons, easy to operate, even with gloves on
- Angled, backlit, daylight visible liquid crystal display
- 3.5mm auxiliary out jack for integration with other audio or communication systems
- Recommended for use with TPX Wireless Headset and/or TPX visual alert
- Includes visual alert, wiring harness, universal mount plate adapter with hardware



WPS#  
**71-9103**

**BLUETOOTH TRANSMITTER & 12 VOLT POWER SUPPLY**

**TPX™ BLUETOOTH TRANSMITTER**

- Wirelessly syncs with most any Bluetooth audio device
- Transmits alerts from the TPX radar detector and laser jammer along with music and sound from any device with a 3.5mm audio-out plug
- Includes AC wall charger



Description	WPS#
TPX Bluetooth transmitter	<b>71-9115</b>

**TPX™ 12 VOLT POWER SUPPLY**

- Power or charges any USB device
- Can also be used in conjunction with the TPX™ Bluetooth adapter, eliminating the need to charge with the AC wall charger



Description	WPS#
12 volt power supply	<b>71-9116</b>

**WIRELESS HEADSET**

- For use with the TPX Radar/Laser Detector main console
- Alerts the rider to the detection of radar/laser signals by audio beeps through the earphone
- Wireless, water resistant design easily attaches to most open or full face helmets
- Can be used in conjunction with the TPX Visual Alert
- Powered by a lithium coin cell battery (included)



WPS#  
**71-9102**

**VISUAL ALERT**

- For use with the TPX Radar/Laser Detector main console
- Alerts the rider to the detection of radar/laser signals by flashing 3 ultra bright LEDs
- Water resistant and designed to be mounted most anywhere: gauge cluster, handlebars etc.
- Ideal for riders that don't wear a full or open faced helmet, can be used in conjunction with the TPX Wireless Headset



WPS#  
**71-9106**

For radar detector mounts, see pages 831

**ACCESSORIES AND MOUNTS FOR TPX SERIES RADAR/LASER DETECTOR**



- AdaptivMount mounting assemblies are constructed from high strength steel and aircraft grade aluminum and feature AdaptiSorb anti-vibration technology
- Universal Mount Adapter - Only needed if you want to replace a lost or damaged mount adapter or want an addition mount for another motorcycle
- AdaptivGrip device holder - holds devices up to 5/8" thick and 4 1/4" wide, compatible with all mounts w/AMPS hole pattern

- Automotive Mount - Allows you to use the TPX Main Console in a car, truck, SUV etc. Includes mount plate and cigarette lighter adapter
- Replacement Wiring Harness - Only needed if you want to replace a damaged harness or use your TPX Main Console on another motorcycle



	Description	WPS#
<b>ADAPTIV MOUNT MOUNTING SYSTEMS</b>		
A	Handlebar mount 7/8" - 1 1/4"	71-9170
B	Chrome handlebar mount 7/8" - 1 1/4"	71-9171
C	Skinny bar mount for round/oval bar diameter of 5/16" - 9/16"	71-9176
D	Control mount, 2 bolts facing to the back with 1 9/16" or less spacing	71-9172
E	Horizontal control mount, 2 bolts facing up space 1 1/32" - 1 11/32"	71-9175
F	Mirror hole mount (for bikes w/unused mirror mount hole)	71-9173
G	Reservoir mount (for bikes with rectangular reservoir w/2 or more mounting holes)	71-9174
H	Extention arm 2 1/2"	71-9188
I	Extention arm, chrome 2 1/2"	71-9189
J	Plate extension (increases the mounting surface of the AdaptivMount)	71-9190
<b>ACCESSORIES</b>		
K	AdaptivGrip device holder	71-9191
L	Universal mount adapter TPX 2.0/TPX Pro	71-9107
M	Automotive mount TPX 2.0	71-9108
	Automotive mount TPX Pro	71-9192
N	Replacement wiring harness TPX 2.0	71-9105
	Replacement wiring harness TPX Pro	71-9193

WINDSHIELDS / FAIRINGS

AUDIO / COMMUNICATION

SEATS / LUGGAGE

BARS / MIRRORS / CONTROLS

EXHAUST

AIR / FUEL SYSTEMS

ENGINE

TRANSMISSION / DRIVELINE

GASKETS / SEALS

ELECTRICAL

LIGHTING

CABLES

BRAKES

OIL FILTERS

SUSPENSION

BODY

WHEELS

TIRES / TIRE ACC.

**BIKE ACC.**

VICTORY / INDIAN

COVERS / LOCKS / TIEDOWNS

CHEMICALS

TOOLS

HELMETS

HELMET ACC.

EYEWEAR

APPAREL / RIDER ACC.

PROMOTIONAL

REFERENCE

INDEX



• RAM utilizes a patented rubber ball and socket design which isolates and dampens shock. This design allows user to mount to just about anything, anywhere on your recreational vehicles.

• Mounts are made of marine grade aluminum with a powder coated finish, stainless steel hardware and Nitrile balls.  
 • Backed by a LIFETIME manufacturer's warranty.

STEP 1



4 STEPS TO CONFIGURING YOUR MOUNTS:

STEP 1

Pick a base



STEP 2

Pick an arm



STEP 3

Pick an adapter



STEP 4

Pick a cradle



Base Descriptions

RAM #

WPS #

	Base Descriptions	RAM #	WPS #
A	2.5" Composite base that connects to a 1" ball, double-sided adhesive PSA stick pad and sealed alcohol prep pad	RAP-B-378U	71-7207
B	2.25" x 0.875" base with 11mm hole provides a universal platform to mount on using a 1" diameter rubber ball	RAM-B-252U	71-7208
C	1" diameter ball and base with an offset 9mm hole	RAM-B-272U	71-7209
D	Motorcycle handlebar base designed to mount on rails that are 0.5" to 1.25" in Diameter and provides a 1" diameter rubber ball to mount from	RAM-B-231ZU	71-7210
E	Connects to a handlebar that is from .5" to 1.25" in diameter or the brake/clutch reservoir clamp. Provides a 1" diameter rubber ball to mount off of	RAM-B-309-7U	71-7212
F	Fork stem mounted motorcycle base that fits .5" to 1.10" diameter holes and provides a 1" diameter rubber ball to mount off of	RAM-B-342U	71-7213
G	Hardware replaces most M8 size bolts and provides a 1" diameter ball to mount from. Comes with the following bolts, M8 x 55 bolt (1.25 thread pitch), M8 x 60 bolt (1.25 thread pitch), M8 x 65 bolt (1.25 thread pitch)	RAM-B-367U	71-7214
H	Steel strap base to fit rails .5" to 3.15" in diameter with a 1" diameter rubber ball to mount off of	RAM-B-231Z-2NUBU	71-7221
I	3.25" Twist lock suction cup base that is connected to the RAM-B-238U diamond base with 1" rubber ball	RAM-B-224-1U	71-7216
J	Fits over your brake/clutch reservoir cover using the existing hardware and comes with the 1" ball offset to mount off of	RAM-B-346U	71-7218
K	M10 x 1.25 Pitch threaded stud connected to a 1" rubber ball	RAM-B-349U	71-7242
L	Stainless steel double u-bolt base connected to a 1.5" diameter ball. The double u-bolt base will accommodate rails from 1" to 1.25" in diameter	RAM-235U	71-7222
M	1.5" Diameter rubber ball connected to a 2.5" universal AMPS hole pattern	RAM-202U	71-7223
N	1.5" Ball quick release track base (track dimensional range .25"-.562")	RAP-383U	71-7224
O	EZ-ON/OFF™ low profile handlebar mount. Attaches with zip ties and will fit on almost any handlebar over .5" in diameter. Needs adapter WPS # 71-7206	RAP-274-1U	71-7225
P	Tough-Claw mount universal clamp w/1" ball, fits rails .625"-1.5" in diameter	RAP-B-400U	71-7026
P	Tough-Claw mount universal clamp w/1" ball, fits rails 1"-2.25" in diameter	RAP-B-401U	71-7033
Q	Medium Tough-Claw w/1" diameter ball	RAP-B-404U	71-7230
R	2"x1.7" Base w/1" ball and AMPs hole pattern to fit Garmin Zumo, Tom Tom Rider & Urban Rider	RAM-B-347U	71-7226
S	Rail base w/stainless U-bolt & 1" ball, fits .5" to 1" rails	RAM-B-231U	71-7211
T	Rail base w/stainless U-bolt & 1" ball, fits .5" to 1" rails (chrome)	RAM-B-231CHU	71-7211C
U	Brake/clutch reservoir base with 1" Ball	RAM-B-309-1U	71-7241
V	Brake/clutch reservoir base w/qty. 2 1" balls	RAM-B-309-2U	71-7240
W	Brake/clutch reservoir base w/qty. 2 1" balls (chrome)	RAM-B-309-2CHU	71-7240C
X	Brake/clutch reservoir cover base w/1" centered ball	RAM-B-345U	71-7229
Y	Rail base w/zinc coated U-bolt, ATV/UTV strap & 1" ball for rails to 3.15" in diameter	RAM-B-231Z-2U	71-7215
Z	U-Bolt handlebar base with 1/4" NPT threaded hole	RAM-B-241U	71-7217
AA	1" Ball adapter for brake/clutch reservoir base	RAM-B-309-3U	71-7243
BB	1/4"-20 x 2 1/4" Threaded stud w/1" ball	RAM-B-273U	71-7244
CC	3/8" Threaded post w/1" ball	RAM-B-236U	71-7246
	M10 x 1.5 Threaded stud w/1" ball	RAM-B-349-1U	71-7252
DD	1" Tough-Ball™ w/1/4"-20 x 1/4" male threaded post	RAP-B-379U-252025U	71-7248
EE	Composite rail base w/1" ball for rails from 3/4" to 1" in diameter	RAP-B-231U	71-7272
FF	Pivot mount w/1" ball, inc. M8 & M10 stud mounts	RAM-B-360U	71-7204
GG	1" ball with V-mount, fits rails 1" - 2.1" in diameter	RAM-B-108BU	71-7227
HH	Torque™ mount w/1" ball, fits rails 3/8" - 5/8" in diameter	RAM-B-408-37-62U	71-7253
II	Torque™ mount w/1" ball, fits rails 3/4" - 1" in diameter	RAM-B-408-75-1U	71-7254
JJ	Torque™ mount w/1" ball, fits rails 1 1/8" - 1 1/2"	RAM-B-408-112-15U	71-7255
KK	Gas tank mount w/1" ball, fits most Honda, Suzuki, KTM, Victory and Yamaha models with 3.5" bolt circle gas cap	RAM-B-410U	71-7231
LL	Gas tank mount w/1" ball, fits most BMW and Kawasaki models with 4" bolt circle gas cap	RAM-B 411U	71-7232

See pictures on next page



STEP 1



- WINDSHIELDS / FAIRINGS
- AUDIO / COMMUNICATION
- SEATS / LUGGAGE
- BAR / MIRRORS / CONTROLS
- EXHAUST
- AIR / FUEL SYSTEMS
- ENGINE
- TRANSMISSION / DRIVELINE
- GASKETS / SEALS
- ELECTRICAL
- LIGHTING
- CABLES
- BRAKES
- OIL FILTERS
- SUSPENSION
- BODY
- WHEELS
- TIRES / TIRE ACC.
- BIKE ACC.**
- VICTORY / INDIAN
- COVERS / LOCKS / TIEDOWNS
- CHEMICALS
- TOOLS
- HELMETS
- HELMET ACC.
- EYEWEAR
- APPAREL / RIDER ACC.
- PROMOTIONAL
- REFERENCE
- INDEX



STEP 2



4 STEPS TO CONFIGURING YOUR MOUNTS:

STEP 1  
Pick a base



STEP 2  
Pick an arm



STEP 3  
Pick an adapter



STEP 4  
Pick a cradle



Arm Descriptions

	ARM DESCRIPTIONS	RAM #	WPS #
A	Short double socket arm for 1" ball, overall length 2.38", socket-to-socket length 2"	RAM-B-201U-AU	71-7262
B	Short double socket arm for 1" ball, overall length 2.38", socket-to-socket length 2" (chrome)	RAM-B-201-ACHU	71-7262C
C	Composite short double socket arm for 1" ball, overall length 2.38", socket-to-socket length 2"	RAP-B-201U-AU	71-7273
D	Standard double socket arm for 1" ball, overall length 3.69", socket-to-socket length 3"	RAM-B-201U	71-7263
E	Standard double socket arm for 1" ball, overall length 3.69", socket-to-socket length 3" (chrome)	RAM-B-201CHU	71-7263C
F	Composite double socket arm for 1" ball, overall length 3.69", socket-to-socket length 3"	RAP-B-201U	71-7274
G	Long double socket arm for 1" ball, overall length 6", socket-to-socket length 5.1875"	RAM-B-201U-C	71-7264
H	Standard double socket arm for 1.5" ball, overall length 4.5", socket-to-socket length 5.625"	RAM-201U	71-7265
I	Camera boom stick w/1.5" ball socket base on bottom and 1" ball socket on top, overall length 14"	RAP-CB-201-14U	71-7266
J	14" Long extension pole for camera boom stick with (2 qty) 1" diameter ball ends, and double socket arm to attach to a camera adapter. overall Length 14"	RAP-BB-230-14-201U	71-7267
K	Double socket swivel arm for 1" bases, overall length 6.25", socket to socket 5.5"	RAP-B-200-2U	71-7275
L	Locking Knob with 1/4"-20 Brass Hole (Replaces existing "wing" style nut)	RAM-KNOB3LU	71-7268
M	Pin-lock security knob and key knob for 1" diameter B size arms	RAP-S-KNOB3U	71-7191

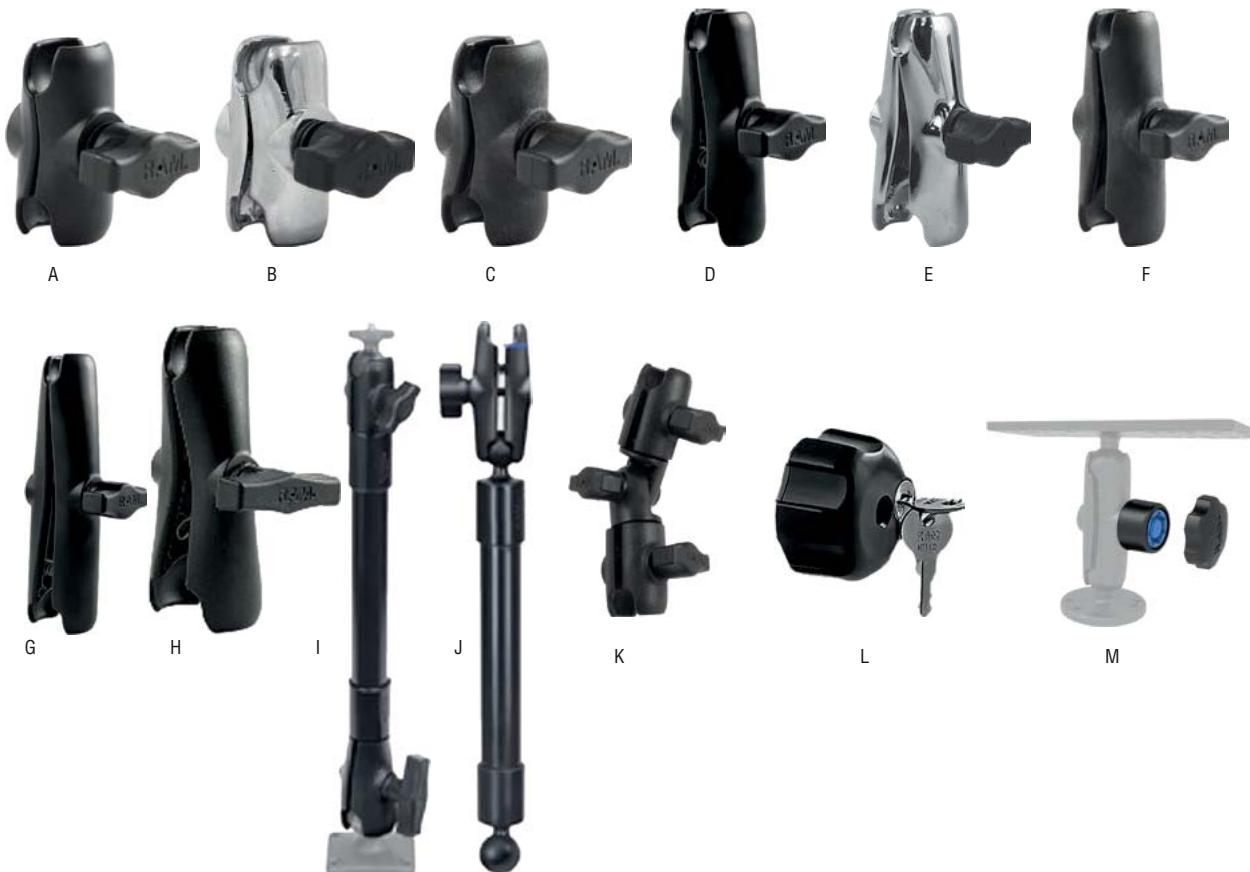

- WINDSHIELDS / FAIRINGS
- AUDIO / COMMUNICATION
- SEATS / LUGGAGE
- BARS / MIRRORS / CONTROLS
- EXHAUST
- AIR / FUEL SYSTEMS
- ENGINE
- TRANSMISSION / DRIVELINE
- GASKETS / SEALS
- ELECTRICAL
- LIGHTING
- CABLES
- BRAKES
- OIL FILTERS
- SUSPENSION
- BODY
- WHEELS
- TIRES / TIRE ACC.
- BIKE ACC.**
- VICTORY / INDIAN
- COVERS / LOCKS / TIEDOWNS
- CHEMICALS
- TOOLS
- HELMETS
- HELMET ACC.
- EYEWEAR
- APPAREL / RIDER ACC.
- PROMOTIONAL
- REFERENCE
- INDEX

STEP 3



4 STEPS TO CONFIGURING YOUR MOUNTS:

STEP 1  
Pick a base



STEP 2  
Pick an arm



STEP 3  
Pick an adapter



STEP 4  
Pick a cradle



	Adapter Descriptions	RAM #	WPS #
A	1" diameter rubber ball connected to a 2.5" universal AMPS hole pattern	RAM-B-202U	71-7205
B	1" diameter rubber ball connected to a 2.43" x 1.31" diamond shaped base. USE THIS BASE WHEN ATTACHING TO GPS CRADLES	RAM-B-238U	71-7206
C	Universal camera and camcorder base, 1" diameter rubber ball, connected to a small round plate with 1/4"-20 camera thread	RAP-B-366U	71-7219
D	1" diameter rubber ball, connected to a 1/4"-20 camera thread	RAM-B-237U	71-7245
E	1" diameter rubber ball, connected to a custom GoPro® adapter. The adapter attaches directly to the under-side of the camera, replacing the factory mounting bracket	RAP-B-202U-GOP1U	71-7247
F	Universal camera and camcorder base, consists of a 1" diameter rubber ball, connected to a 2.5" diameter round plate with 1/4"-20 camera thread	RAM-B-202AU	71-7249
G	Mirror post mount for Harley-Davidson with 1" diameter rubber ball	RAP-B-379-HA1U	71-7250
H	Garmin Virb adapter w/1" ball	RAM-B-202U-GA63U	71-7027

NOTE: When purchasing a RAM Cradle, make sure to purchase the "Required Adapter" to complete the mounting kit



A



B



C



D



E



F



G



H

- WINDSHIELDS / FAIRINGS
- AUDIO / COMMUNICATION
- SEATS / LUGGAGE
- BARS / MIRRORS / CONTROLS
- EXHAUST
- AIR / FUEL SYSTEMS
- ENGINE
- TRANSMISSION / DRIVELINE
- GASKETS / SEALS
- ELECTRICAL
- LIGHTING
- CABLES
- BRAKES
- OIL FILTERS
- SUSPENSION
- BODY
- WHEELS
- TIRES / TIRE ACC.
- BIKE ACC.
- VICTORY / INDIAN
- COVERS / LOCKS / TIEDOWNS
- CHEMICALS
- TOOLS
- HELMETS
- HELMET ACC.
- EYEWEAR
- APPAREL / RIDER ACC.
- PROMOTIONAL
- REFERENCE
- INDEX



STEP 4



4 STEPS TO CONFIGURING YOUR MOUNTS:

STEP 1  
Pick a base



STEP 2  
Pick an arm



STEP 3  
Pick an adapter



STEP 4  
Pick a cradle



NOTE:  
When purchasing a RAM Cradle, an adapter is needed for the back of the cradle to make it usable with the socket arm.

	Cradle Descriptions	Required Adapter	RAM #	WPS #
A	Cradle for the nvi 50/50LM	71-7206	RAM-HOL-GA50U	71-7105
B	Cradle for the nvi 200/205/250/255/260/265T/270	71-7206	RAM-HOL-GA24U	71-7106
C	Cradle for the nvi 200W/205W/250W/255W/260W/265W/265WT/285WT/465T	71-7206	RAM-HOL-GA25U	71-7101
C	Locking cradle for the nvi 200W/205W/250W/255W/260W/265W/265WT/285WT/465T	71-7206	RAM-HOL-GA25LU	71-7107
D	Cradle for the nvi 1300/1310T/1350/1350T/1370T/1390/1390T/2455LT/2455LMT/2475LT/2495LMT	71-7206	RAM-HOL-GA34U	71-7108
E	Cradle for the nvi 1440/1450/1490T	71-7206	RAM-HOL-GA35U	71-7109
F	Cradle for the Astro 320, GPSMAP 62/62s/62sc/62st/62stc	71-7206	RAM-HOL-GA41U	71-7102
G	Cradle for the TomTom ONE XL/XLS	71-7206	RAM-HOL-TO5U	71-7110
H	Designed to hold the Apple iPhone® 5 without case, skin or sleeve	71-7206	RAM-HOL-AP11U	71-7111
I	Designed to hold the Apple iPhone® 4 without case, skin or sleeve and Apple iPhone 4S without case, skin or sleeve	71-7206	RAM-HOL-AP9U	71-7112
J	Weather proof box with clear screen that holds devices up to Width=2.88", Height=5.75", Depth=1.188" inches	71-7205	RAM-HOL-AQ2U	71-7135
K	Weather proof box with clear screen that holds devices up to Width=6", Height=4", Depth=1.75" inches	71-7205	RAM-HOL-AQ6U	71-7136
L	With the introduction of the AQUA BOX™ Pro, you have access to side buttons and full use of the touchscreen. Holds Smart Phones Up To 5.38"(H) X 2.8"(W) X 0.55"(D) (depth will flex). Comes with lanyard, button & belt clip.	71-7206	RAM-HOL-AQ7-2C	71-7137
M	Spring tensioned cradle that holds devices from 2.25" - 3.25" wide and 4.75" - 6.25" tall	71-7206	RAM-HOL-PD3U	71-7132
N	Holds cell phones and electronic devices up to 3.5" wide and 6" tall. The holder comes with (3 sets) of four flexible rubber coated fingers	71-7206	RAM-HOL-UN4U	71-7133
O	X-Grip universal cell phone holder fits devices that are up to 3.25" wide and comes with a 1" diameter rubber ball		RAM-HOL-UN7BU	71-7134
P	X-Grip tablet holder fits devices that are up to 4.5" wide and comes with a 1" diameter rubber ball		RAM-HOL-UN10BU	71-7023
Q	X-Grip medium tablet holder fits with devices that are up to 5.75" wide and comes with a 1" diameter rubber ball		RAM-HOL-UN8BU	71-7024
R	X-Grip large tablet holder fits devices that are up to 8.1" wide, mount not included, order 71-7205 for 1" ball mount		RAM-HOL-UN9U	71-7025
S	Bracket will attach to most hand gun holsters with a belt loop attachment and then connects to 71-7205 or 71-7206 adapter.	71-7205	RAM-HOL-GUN1U	71-7138
T	EZ-Roller™ cradle for SPOT Gen3™		RAM-HOL-SPO4U	71-7113
U	Holder for Garmin NUVI 750/760/770/780		RAM-HOL-GA26U	71-7115
V	Holder for Garmin Rino 610/650/655T		RAM-HOL-GA47U	71-7100
W	Holder for Garmin NUVI 52/54/55/56/58		RAM-HOL-GA55U	71-7104
X	Holder iPhone 6		RAM-HOL-AP18U	71-7116
Y	Holder iPhone 6 Plus		RAM-HOL-AP19U	71-7117
Z	Holder for Garmin Montana 600/650/650T		RAM-HOL-GA46U	71-7118
AA	Cup holder w/cozy with 1" diameter ball		RAM-B-132BU	71-7141
BB	Level Cup™ XL w/cozy with 1" diameter ball, fits cups up to 3.5" wide and 11" tall		RAP-B-417B	71-7142
CC	Replacement X-Grip® post caps (4 qty)		RAP-UN-CAP-4U	71-7190

See pictures on next page

STEP 4



A



B



C



D



E



F



G



H



I



J



K



L



M



N



O



P



Q



R



S



T



U



V



W



X



Y



Z



AA



BB



CC

- WINDSHIELDS / FAIRINGS
- AUDIO / COMMUNICATION
- SEATS / LUGGAGE
- BARS / MIRRORS / CONTROLS
- EXHAUST
- AIR / FUEL SYSTEMS
- ENGINE
- TRANSMISSION / DRIVELINE
- GASKETS / SEALS
- ELECTRICAL
- LIGHTING
- CABLES
- BRAKES
- OIL FILTERS
- SUSPENSION
- BODY
- WHEELS
- TIRES / TIRE ACC.
- BIKE ACC.**
- VICTORY / INDIAN
- COVERS / LOCKS / TIEDOWNS
- CHEMICALS
- TOOLS
- HELMETS
- HELMET ACC.
- EYEWEAR
- APPAREL / RIDER ACC.
- PROMOTIONAL
- REFERENCE
- INDEX



COMPLETE KITS



- WINDSHIELDS / FAIRINGS
- AUDIO / COMMUNICATION
- SEATS / LUGGAGE
- BARS / MIRRORS / CONTROLS
- EXHAUST
- AIR / FUEL SYSTEMS
- ENGINE
- TRANSMISSION / DRIVELINE
- GASKETS / SEALS
- ELECTRICAL
- LIGHTING
- CABLES
- BRAKES
- OIL FILTERS
- SUSPENSION
- BODY
- WHEELS
- TIRES / TIRE ACC.
- BIKE ACC.
- VICTORY / INDIAN
- COVERS / LOCKS / TIEDOWNS
- CHEMICALS
- TOOLS
- HELMETS
- HELMET ACC.
- EYEWEAR
- APPAREL / RIDER ACC.
- PROMOTIONAL
- REFERENCE
- INDEX

	Kit Descriptions	RAM #	WPS #
A	EZ-ON/OFF low profile handlebar mount with universal X-Grip phone holder that holds devices up to 3.25" wide. Attaches with zip ties and will fit on almost any handlebar over .5" in diameter	RAP-274-1-UN7	71-7021
B	Cup holder w/cozy, connected to a double socket arm with 1" diameter rubber ball and comes with hardware for mounting to rails that are .5" to 1.25" in diameter	RAM-B-132R	71-7022
C	Cup holder w/cozy, connected to a Tough Claw mount with 1" diameter rubber ball and comes with hardware for mounting to rails that are .625" to 1.5" in diameter	RAM-B-132-400	71-7034
D	Cup holder w/cozy, reservoir mount	RAM-B-132-309	71-7028
E	Spotlight uses a 1" diameter rubber ball which is connected to an adjusting arm and then a rail base that will fit any bar that is .5" to 1.25" in diameter	RAM-B-152R	71-7016
F	Double socket arm, double u-bolt base that will fit pipes from .5" to 1.25" in diameter and back rest pad for ATV's	RAM-101U-235Z-BR1	71-7010
G	Handlebar mini camera mount	RAM-B-149Z-GOP1	71-7006
H	Tough Claw mount with X-Grip (standard phones), fits rails .625" to 1.5" in diameter	RAM-HOL-UN7-400	71-7035
I	Tough Claw mount with X-Grip (large phones/Phablets), fits rails .625" to 1.5" in diameter	RAM-HOL-UN10-400	71-7038
J	Torque mount with X-Grip (standard phones, short arm), fits rails 3/4" to 1" in diameter	RAM-B-408-75-1-A-UN7	71-7042
K	Torque mount with X-Grip (standard phones, med. arm), fits rails 1 1/8" to 1 1/2" in diameter	RAM-B-408-112-15-UN7	71-7043
L	Torque mount with X-Grip (large phones/Phablets, med. arm), fits rails 3/4" to 1" in diameter	RAM-B-408-75-1-UN10	71-7040
M	Torque mount with X-Grip (large phones/Phablets, med. arm), fits rails 1 1/8" to 1 1/2" in diameter	RAM-B-408-112-15-UN10	71-7041
N	Motorcycle U-bolt mount with X-Grip, fits rails .5" to 1.25" in diameter	RAM-B-174-UN7	71-7008
O	Motorcycle U-bolt mount with X-Grip (for large phones/phablets), fits rails .5" to 1.25" in diameter	RAM-B-149Z-UN10U	71-7139
P	Motorcycle U-bolt mount with X-Grip, fits rails .5" to 1.25" in diameter	RAM-B-149Z-UN7	71-7037
Q	U-bolt universal holder, fits rails .5" to 1.25" in diameter	RAM-B-174-UN4	71-7015
R	U-bolt Mount with 1/4" -20 thread, fits rails .5" to 1.25" in diameter	RAM-B-174-202A	71-7012
S	Hand gun holster handlebar mount, fits rails .5" to 1.25" in diameter	RAM-B-149Z-GUN1	71-7009
T	Brake/clutch reservoir U-bolt mount w/diamond base adapter, fits rails .5" to 1.25" in diameter	RAM-B-174	71-7019
U	Handlebar rail mount w/zinc coated U-bolt base & round base adapter that contains the AMPs hole pattern	RAM-B-149Z-202U	71-7018
V	Brake/clutch reservoir U-bolt mount w/diamond base adapter (chrome), fits rails .5" to 1.25" in diameter	RAM-B-174CH	71-7019C
W	Brake/clutch reservoir U-bolt mount w/round base adapter, AMPs hole pattern, fits rails .5" to 1.25" in diameter	RAM-B-174-202	71-7020
X	Brake/clutch reservoir U-bolt mount w/round base adapter, AMPs hole pattern (chrome), fits rails .5" to 1.25" in diameter	RAM-B-174CH-202	71-7020C
Y	Fork stem mount w/univ. Finger Grip™ phone/radio holder	RAM-B-176-UN4	71-7029
Z	Handlebar rail mount w/stainless steel U-bolt base, fits rails .5" to 1" in diameter ATV/UTV Rail mount	RAM-B-149	71-7030 71-7011
AA	Handlebar rail mount w/stainless steel U-bolt base (chrome), fits rails .5" to 1" in diameter	RAM-B-149CH	71-7030C
BB	Twist Lock suction cup mount, std. double socket arm & 1" ball w/X-Grip std. phone	RAM-B-166-UN7	71-7039
CC	Twist Lock suction cup mount, std. double socket arm & 1" ball w/X-Grip lrg. phone/phablet	RAM-B-166-UN10	71-7044
DD	Twist Lock suction cup mount, short double socket arm & 1" ball w/GoPro® Hero adapter	RAM-B-166-A-GOP1	71-7004
EE	Motorcycle handlebar mount w/8mm bolts	RAM-B-186	71-7003
FF	Fork stem mount w/standard X-Grip (fits devices up to 3.25" wide), fits 12-33mm stem holes	RAM-B-176-A-UN7	71-7036
GG	Fork stem mount w/large X-Grip (fits devices up to 4.25" wide), fits 12-33mm stem holes	RAM-B-176-A-UN10U	71-7045
HH	Fork stem base w/double socket arm and diamond base adapter	RAM-B-176	71-7031
II	Strap clamp roll bar mount w/1" ball & GoPro® Hero adapter, fits rails .5" to 1.25" in diameter	RAM-B-149Z-2-GOP1	71-7002
JJ	Handlebar rail mount, U-bolt, short double socket arm w/1" ball & GoPro® Hero adapter, fits rails .5" to 1.25" in diameter	RAM-B-149Z-A-GOP1	71-7032 37.49

See pictures on next page



COMPLETE KITS



- WINDSHIELDS / FAIRINGS
- AUDIO / COMMUNICATION
- SEATS / LUGGAGE
- BAR / MIRRORS / CONTROLS
- EXHAUST
- AIR / FUEL SYSTEMS
- ENGINE
- TRANSMISSION / DRIVELINE
- GASKETS / SEALS
- ELECTRICAL
- LIGHTING
- CABLES
- BRAKES
- OIL FILTERS
- SUSPENSION
- BODY
- WHEELS
- TIRES / TIRE ACC.
- BIKE ACC.**
- VICTORY / INDIAN
- COVERS / LOCKS / TIEDOWNS
- CHEMICALS
- TOOLS
- HELMETS
- HELMET ACC.
- EYEWEAR
- APPAREL / RIDER ACC.
- PROMOTIONAL
- REFERENCE
- INDEX



## 4G MOUNTS

- Top quality mounting systems
- Use with GPS systems, Smartphones, radar detectors, audio/video equipment and more
- Several different cradles, cases and adapters depending on the application
- High quality aluminum



Description	Color	WPS#
<b>STEM MOUNTS</b>		
A Stem mount kit w/13,16,17,18,19,24mm posts	Black	571-1000
<b>FAIRING MOUNTS</b>		
B Universal Surface mount		571-1023
<b>MIRROR MOUNTS</b>		
C 10mm mirror mount		571-1010
D Harley Davidson mirror mount	Black	571-1012BK
Harley Davidson mirror mount	Chrome	571-1012C
<b>CONTROL MOUNT</b>		
E Universal control Mount		571-1011
<b>HANDLEBAR MOUNTS</b>		
F Handlebar mount 7/8-1"1/4	Black	571-1009BK
G Handlebar mount 7/8-1"1/4	Chrome	571-1009C

- WINDSHIELDS / FAIRINGS
- AUDIO / COMMUNICATION
- SEATS / LUGGAGE
- BARS / MIRRORS / CONTROLS
- EXHAUST
- AIR / FUEL SYSTEMS
- ENGINE
- TRANSMISSION / DRIVELINE
- GASKETS / SEALS
- ELECTRICAL
- LIGHTING
- CABLES
- BRAKES
- OIL FILTERS
- SUSPENSION
- BODY
- WHEELS
- TIRES / TIRE ACC.
- BIKE ACC.**
- VICTORY / INDIAN
- COVERS / LOCKS / TIEDOWNS
- CHEMICALS
- TOOLS
- HELMETS
- HELMET ACC.
- EYEWEAR
- APPAREL / RIDER ACC.
- PROMOTIONAL
- REFERENCE
- INDEX



### ACCESSORIES

- Top quality mounting systems
- Use with GPS systems, Smartphones, radar detectors, audio/video equipment and more
- Several different cradles, cases and adapters depending on the application
- High quality aluminum



Description	Color	WPS#
<b>OPTIONAL SHAFT</b>		
A 1" Shaft with ball		571-1025
B 2" Shaft with ball pivoting	Black	571-1026BK
2" Shaft with ball pivoting	Chrome	571-1026C
C 2" Shaft with ball	Black	571-1027BK
D 2" Shaft with ball	Chrome	571-1027C
E 3" Shaft with ball pivoting	Black	571-1028BK
F 3" Shaft with ball pivoting	Chrome	571-1028C
G 3" Shaft with ball	Black	571-1029BK
H 3" Shaft with ball	Chrome	571-1029C
<b>TOP PLATES</b>		
Garmin Zumo 660 top plate		571-1030
Wide plate w/velcro		571-1031
I Radar detector top plate	Black	571-1032BK
Radar detector top plate	Chrome	571-1032C
J Double top plate kit w/o shaft	Black	571-1033BK
Double top plate kit w/o shaft	Chrome	571-1033C
K 4G Universal top plate		571-1034
L 4G Techmount adapter		571-1035
M 4G Camera adapter		571-1036
N 4G Techmount-GoPro adapter		571-1037
4G Techmount-Ram mount adapter		571-1038

Description	Color	WPS#
<b>ADAPTERS/CRADLES/CASES</b>		
O Universal phone cradle		571-1039
P GPS water resistant case		571-1040
Q Samsung NOTE water resistant case		571-1041
R Unvsl smartphone/mp3 water resistant case		571-1042
S Tech Gripper	Black	571-1060B

- WINDSHIELDS / FAIRINGS
- AUDIO / COMMUNICATION
- SEATS / LUGGAGE
- BARS / MIRRORS / CONTROLS
- EXHAUST
- AIR / FUEL SYSTEMS
- ENGINE
- TRANSMISSION / DRIVELINE
- GASKETS / SEALS
- ELECTRICAL
- LIGHTING
- CABLES
- BRAKES
- OIL FILTERS
- SUSPENSION
- BODY
- WHEELS
- TIRES / TIRE ACC.
- BIKE ACC.**
- VICTORY / INDIAN
- COVERS / LOCKS / TIEDOWNS
- CHEMICALS
- TOOLS
- HELMETS
- HELMET ACC.
- EYEWEAR
- APPAREL / RIDER ACC.
- PROMOTIONAL
- REFERENCE
- INDEX



### CELL PHONE/GPS CHARGER ADAPTER

First and only cell phone and GPS charger adapter. It is a complete ready-to-go system, patented and manufactured by Brookshire innovations LLC in Roseville CA.

- Adapter includes a waterproof fused 15 amp 4' wiring harness with an SAE dual pin connector (works with many popular battery chargers) and a power socket that is compatible with most all 12 volt powered equipment (radar detectors, heated clothing, GPS, cell phone chargers etc.)
- Easy to install and works on any motorcycle, ATV, watercraft, snowmobile or scooter, and carries an unlimited 5 year manufacturers electronics warranty
- Kick Start Finalist winner at the 2009 Dealer Expo
- Dealer display pack includes 12 adapters, point of sale display, header card and poster. Refill pack includes 12 adapters
- Optional chrome plated handlebar mount available; works with Eklipes adapter along with most 1" diameter power sockets

Description	WPS#
A Dealer display pack	71-9120
B Adapter (single)	71-9125



A

### VIPER CHROME SOCKET

- Chrome socket system with a 3'6" long wiring harness and SAE dual pin adapters
- Compatible with most all 12 volt powered equipment that uses a cigarette style plug-in
- Includes the Battery Harness Kit (WPS # 71-9126) and works with the Jump Start Kit (WPS # 71-9127)

Description	WPS #
Chrome Adapter	71-9123



### HANDLEBAR MOUNTING SYSTEMS FOR EKLIPES ADAPTERS

Perfect for mounting the cell phone/GPS charger adapters (WPS #'s 71-9125 / 71-9123) and most 1" diameter power sockets (power socket not included).

Dual Ring Mount:

- Innovative adjustable ring design fits all handlebars up to 1 1/4" in diameter



A

Chrome Riser Mount:

- Attaches to handlebar mounting clamp



B

Description	WPS #
A Dual Ring mount chrome	71-9132
B Dual Ring mount black	71-9132BK
C Riser mount	71-9131



C



### BIG BIKE PARTS

### USB CHARGER

- Waterproof USB charger
- 7/8" & 1" handlebar fitment
- 2.1 amp and 1.0 amp charging ports
- Enough separation to allow for both ports being used simultaneously



Description	WPS#
Dual port USB charger	94-13208





### COBRA CHARGING STATION

- Full feature charging station that includes a 12 volt charging socket and a USB charging port
- On/off switch with LED indicator light
- USB port will charge most any device including iPhone®, iPod®, iPad®, Android phones, MP3/MP4 players and more
- 3'6" long wiring harness and SAE dual pin adapters, includes the Battery Harness Kit (WPS # 71-9126) and works with the Jump Start Kit (WPS # 71-9127)
- Includes a waterproof cap and chrome mount that will fit all handlebars up to 1¼" in diameter



Description	WPS #
Black	71-9133BK
Black w/chrome insert	71-9133BC
Chrome	71-9133

WINDSHIELDS / FAIRINGS  
 AUDIO / COMMUNICATION  
 SEATS / LUGGAGE  
 BARS / MIRRORS / CONTROLS  
 EXHAUST  
 AIR / FUEL SYSTEMS  
 ENGINE  
 TRANSMISSION / DRIVELINE  
 GASKETS / SEALS  
 ELECTRICAL  
 LIGHTING  
 CABLES  
 BRAKES  
 OIL FILTERS  
 SUSPENSION  
 BODY  
 WHEELS  
 TIRES / TIRE ACC.  
**BIKE ACC.**  
 VICTORY / INDIAN  
 COVERS / LOCKS / TIEDOWNS  
 CHEMICALS  
 TOOLS  
 HELMETS  
 HELMET ACC.  
 EYEWEAR  
 APPAREL / RIDER ACC.  
 PROMOTIONAL  
 REFERENCE  
 INDEX

### MULTI-PORT TANK BAG CHARGING STATION

- Includes three 12 volt power sockets, two USB ports and an SAE plug along with a custom tank bag permanent flange mount with a female BMW style plug on one side and an SAE plug on the other side
- Also includes a 2' 10" power line which plugs in perfectly to any Battery Harness and a Male BMW style plug that plugs directly into the included tank bag flange mount



Description	WPS #
Silver	71-9128
Black	71-9128BK

### MULTI-PORT ADAPTER

- Three 12 volt power sockets with two USB ports for charging cell phones, MP3 players, Blue Tooth devices, PDA's and much more
- Plugs into any standard cigarette lighter socket

Description	WPS #
Multi-Port Adapter	71-9129



## LOC-EZY SADDLEBAG FASTENERS

- Saddlebag theft deterrent system
- Secure your saddlebags
- Lock and retaining washers
- Replacement U-clips
- EasyTurn threaded knobs



Description	WPS#
LocEzy Kit '14-Up	980-01061
LocEzy Kit '96-13	980-01060



## FAIRING INSERT REPAIR KIT

- Repairs stripped out OE inserts
- Installation tool included
- Comes with three inserts
- Easy to use



Description	WPS#
Insert Repair Kit	980-01065
9 pk of Inserts	980-01066

- WINDSHIELDS / FAIRINGS
- AUDIO / COMMUNICATION
- SEATS / LUGGAGE
- BARS / MIRRORS / CONTROLS
- EXHAUST
- AIR / FUEL SYSTEMS
- ENGINE
- TRANSMISSION / DRIVELINE
- GASKETS / SEALS
- ELECTRICAL
- LIGHTING
- CABLES
- BRAKES
- OIL FILTERS
- SUSPENSION
- BODY
- WHEELS
- TIRES / TIRE ACC.
- BIKE ACC.
- VICTORY / INDIAN
- COVERS / LOCKS / TIEDOWNS
- CHEMICALS
- TOOLS
- HELMETS
- HELMET ACC.
- EYEWEAR
- APPAREL / RIDER ACC.
- PROMOTIONAL
- REFERENCE
- INDEX



## TOP SHELF ORGANIZER

- 1 year manufacturer's warranty
- Easy to install, takes less than 1 minute
- Keep saddlebags organized
- Use the foam insert to organize items your way



A



B



C



D



E



F



G

	Description	WPS#
A	Saddlebag organizer w/ rubber mat, fits '04-13 models equipped with H-D ABS hard bags	* 980-01000
	Saddlebag organizer w/ rubber mat, fits '14-Up models equipped with H-D ABS hard bags LEFT	980-01005
	Saddlebag organizer w/ rubber mat, fits '14-Up models equipped with H-D ABS hard bags RIGHT	980-01006
	Saddlebag organizer w/ rubber mat, fits '93-03 Right side fiberglass bags	980-01001
	Saddlebag organizer w/ rubber mat, fits '93-03 Left side fiberglass bags	980-01002
B	Saddlebag organizer w/ rubber mat, fits '97-08 Left side leather saddlebag for FLHRC	980-01003
C	Tour Pak organizer w/ rubber mat, fits '93-13 H-D standard Tour Pak (except CVO/SE)	980-01020
<b>ACCESSORIES</b>		
D	Pick and Pluck custom foam insert for 980-01000	980-01030
E	Multi-Fit foam insertkit for glock for 980-01000	‡ 980-01031
	Multi-Fit foam insertkit for glock for 980-01005	980-01033
	Replacement rubber mat for 980-01000	980-01032
F	12V outlet charger	980-01050
G	Battery operated compartment light	980-01056

\*Unit will not fit CVO/Screaming Eagle models with remote electronic locks, iPod docking harness or full length fabric HD liner inserts without cutting / trimming liner walls and replacing pin  
 ‡ Use for: 9mm, .40Cal, 10mm, .45Cal, .380, .357

- WINDSHIELDS / FAIRINGS
- AUDIO / COMMUNICATION
- SEATS / LUGGAGE
- BARS / MIRRORS / CONTROLS
- EXHAUST
- AIR / FUEL SYSTEMS
- ENGINE
- TRANSMISSION / DRIVELINE
- GASKETS / SEALS
- ELECTRICAL
- LIGHTING
- CABLES
- BRAKES
- OIL FILTERS
- SUSPENSION
- BODY
- WHEELS
- TIRES / TIRE ACC.
- BIKE ACC.**
- VICTORY / INDIAN
- COVERS / LOCKS / TIEDOWNS
- CHEMICALS
- TOOLS
- HELMETS
- HELMET ACC.
- EYEWEAR
- APPAREL / RIDER ACC.
- PROMOTIONAL
- REFERENCE
- INDEX

HARD BAGGER

# ALUMINUM LOWER FAIRING DOORS

- Fit 2014-Up Twin Cooled lower fairings, Black Finish Cast Aluminum Dual Door System with stamped steel lift/removal hinge function. (NO TOOL Installation!)
- Quarter-Turn Keyless secure open/shut door operation, Keyed lock/ Keys included for additional security
- Die Cut foam vibration gasket included for O.E.M. fit/function of the doors
- Optional Modular Cast Aluminum Free

Floating Adjustable Bottle/Cup Holder (NO TOOLS Installation/Removal)

- Optional "Challenge Coin" (1.75") Secure Docking System (2pcs Mount Kit) for seamless simple secure coin mounting for proud representation of your Branch, Group or Organization!

Description	WPS#
A Locking Lower Door Single	980-01070
B Locking Lower Door Set of Two	980-01071
C Lower Door Cup Holder	980-01072
D Lower Door Challenge Coin Holder Chrome	980-01073
E Lower Door Challenge Coin Holder Black	980-01074



A



A



D



B



C



E



## FAIRING VENT TRIM & SCREEN

- Improve the look of the new vented Harley batwing fairing
- Customize your look with one or the other, or get them both for a complete chrome conversion
- Chrome fairing vent trim easily replaces the OEM black rubberized vent trim for a custom appearance
- Combine it with the chromed stainless steel honeycomb screen to keep road bugs and grime out of your cockpit
- The honeycomb screen can be mounted with the existing OEM vent trim
- Sold separately or together as a package
- Designed for the 2014-Up batwing fairing vent

	Description	WPS#
A	Honeycomb fairing airway shroud	94-91309
B	Chrome fairing vent trim	94-91308
C	Chrome fairing vent trim with shroud	94-91308WS



## SPOT LIGHT VISORS

- Chrome
- Made in the USA!
- Sold in pairs



Description	WPS#
4 1/2" Spot Light Visors	94-12290



- WINDSHIELDS / FAIRINGS
- AUDIO / COMMUNICATION
- SEATS / LUGGAGE
- BAR / MIRRORS / CONTROLS
- EXHAUST
- AIR / FUEL SYSTEMS
- ENGINE
- TRANSMISSION / DRIVELINE
- GASKETS / SEALS
- ELECTRICAL
- LIGHTING
- CABLES
- BRAKES
- OIL FILTERS
- SUSPENSION
- BODY
- WHEELS
- TIRES / TIRE ACC.
- BIKE ACC.**
- VICTORY / INDIAN
- COVERS / LOCKS / TIEDOWNS
- CHEMICALS
- TOOLS
- HELMETS
- HELMET ACC.
- EYEWEAR
- APPAREL / RIDER ACC.
- PROMOTIONAL
- REFERENCE
- INDEX



## DRESS UP KITS FOR TOURING MODELS

### Kit includes the following components:

- Derby cover for all Twin Cams '99-16 (Except FLHTCUL and FLHTKL)
- Ignition cover for all Twin Cams '99-17
- Heel shift eliminator spacer for '86-Up FLH/FLST
- Bag latch inserts for all Touring models '14-17
- Front axle nut covers for Touring models '08-Up
- Dipstick cap for '07-Up Touring and '06-Up Dyna models
- Knurled toe peg
- Available in raw, black, polished, red, gold and blue finishes.

Application	Finish	WPS#
'14-15 Touring Models	Raw	825-02400
	Black	825-02401
	Polished	825-02402
	Gold	825-02403
	Red	825-02404
	Blue	825-02405







**FUEL SLING WITH BOTTLE**

Tired of running out of fuel with nothing left but your legs to get you where you need to go? NMC's new fuel sling holds an extra quarter gallon of fuel to give you that extra boost in desperate riding situations. The 33 fl.oz. fuel bottle will give you an average of 10 miles extra riding time, and 10 less miles you have to walk or ditch your bike on the side of the road. The fuel sling is hand made out of high grade American leather, will fit just about any application with easy adjustable straps, brass hardware, and quick snaps on top and bottom so you can slide the bottle out quickly and get back on the road. The aluminum bottle is included with the sling and has a 1" opening so that it's easy to fill at the pump. If you want to have extra security, get two of them.

Description	WPS #
Fuel Sling	811-30210



**HAMMER HANGER**

Ever been on a long ride and realized you brought all the tools you need except your hammer? You tried really hard, but you were trying to save all the space you could for your ride. Here at Nash, we came up with the perfect solution. Introducing the Hammer Hanger! Made from high quality leather hand stitched right here in our shop. The hammer hanger can mount anywhere you need using the 3/4" strap system. The sling is made for larger hammers 16 oz or bigger.



Description	WPS #
Hammer Hanger	811-30121



**KEY KEEPER**

Never get caught without your keys again. This brand spankin' new Nash Key Keeper attaches to your belt with a snap to keep your keys handy.

Description	WPS #
Key Keeper	811-30130

- WINDSHIELDS / FAIRINGS
- AUDIO / COMMUNICATION
- SEATS / LUGGAGE
- BARS / MIRRORS / CONTROLS
- EXHAUST
- AIR / FUEL SYSTEMS
- ENGINE
- TRANSMISSION / DRIVELINE
- GASKETS / SEALS
- ELECTRICAL
- LIGHTING
- CABLES
- BRAKES
- OIL FILTERS
- SUSPENSION
- BODY
- WHEELS
- TIRES / TIRE ACC.
- BIKE ACC.**
- VICTORY / INDIAN
- COVERS / LOCKS / TIEDOWNS
- CHEMICALS
- TOOLS
- HELMETS
- HELMET ACC.
- EYEWEAR
- APPAREL / RIDER ACC.
- PROMOTIONAL
- REFERENCE
- INDEX

WINDSHIELDS / FAIRINGS  
 AUDIO / COMMUNICATION  
 SEATS / LUGGAGE  
 BARS / MIRRORS / CONTROLS  
 EXHAUST  
 AIR / FUEL SYSTEMS  
 ENGINE  
 TRANSMISSION / DRIVELINE  
 GASKETS / SEALS  
 ELECTRICAL  
 LIGHTING  
 CABLES  
 BRAKES  
 OIL FILTERS  
 SUSPENSION  
 BODY  
 WHEELS  
 TIRES / TIRE ACC.  
**BIKE ACC.**  
 VICTORY / INDIAN  
 COVERS / LOCKS / TIEDOWNS  
 CHEMICALS  
 TOOLS  
 HELMETS  
 HELMET ACC.  
 EYEWEAR  
 APPAREL / RIDER ACC.  
 PROMOTIONAL  
 REFERENCE  
 INDEX



## FLAG HOLDER KITS

Chrome aluminum bracket and flag holder kits fit most 72-Up Big Twin and Sportster models. Mounts on top of the rear seat tab with stock screw, or under the trunk or almost anywhere else. Available with single or dual flags. Flags measure 4" x 6"

Description	WPS#
A USA /POW-MIA Flags with Trunk Tab Mount	820-70402
B USA Flag with Seat Screw Mount	820-70405
C Replacement Flag 6"x4" with 11" Pole	820-70406



## HANDLEBAR CLOCK

Application	WPS#
Fits 7/8" & 1" handlebars	820-2340



## SUPER GLOW H-BAR CLOCKS

- Luminescent material glows 10x brighter than traditional glow material
- Uses high-quality Quartz movement by Seiko Percision
- Fits handlebars 7/8" - 1 1/4" diameter
- Includes mounting hardware and spacers for a secure fit

Description	WPS#
Black	12-6746BK
Chrome	12-6746CH



# The Pro Pad



- The "original" stainless steel motorcycle flag mount
- Made of solid, polished 303 stainless steel
- No more worries about rust, tarnish or peeling chrome
- Made in the USA!

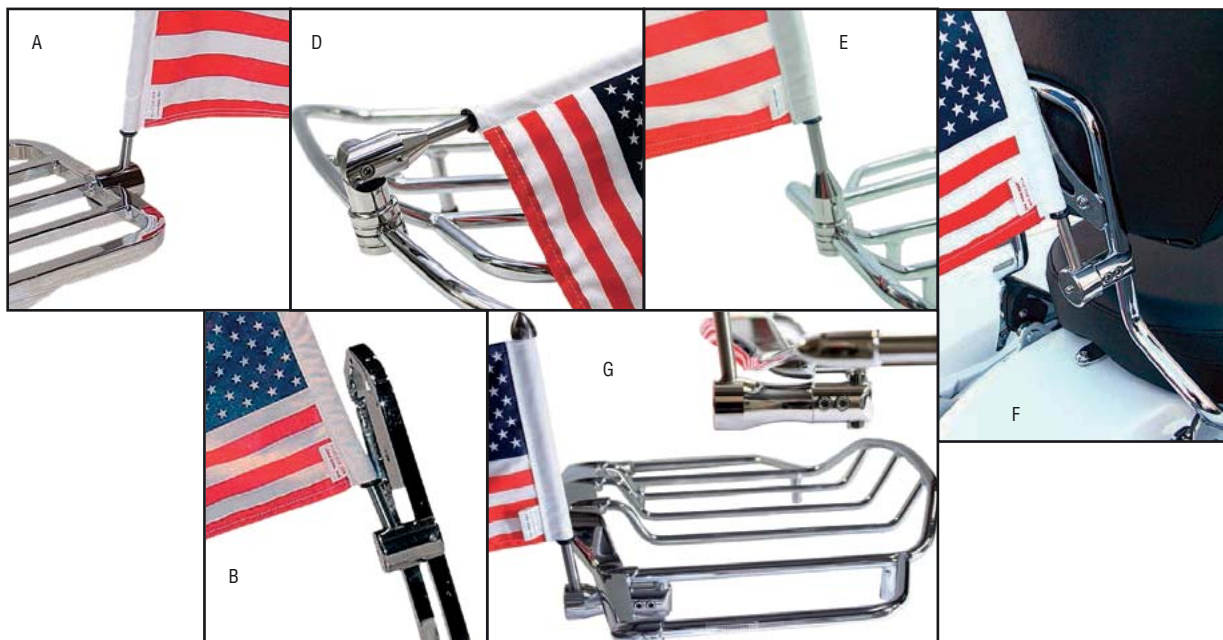

	Description	WPS#
A	USA 6" x 9" flag and mount for square luggage rack	816-0030
B	USA 6" x 9" flag and mount for square sissy bar	816-0031
C	USA 6" x 9" flag and mount for 1/2" round bar	816-0032
D	USA 6" x 9" flag w/ folding mount for 1/2" round bar	816-0033
E	USA 6" x 9" flag and fixed mount for 5/8" round bar	816-0034
F	USA 6" x 9" flag and mount for 5/8" round bar	816-0035
G	USA 6" x 9" flag and mount for H-D Air Wing tour pak rack	816-0036



H & J



I & K

	Description	WPS#
<b>REPLACEMENT PARTS</b>		
	13" stainless steel pole	816-0044
H	6" x 9" USA flag	816-0037
I	6" x 9" POW-MIA flag	816-0038
J	10" x 15" USA flag	816-0039
K	10" x 15" POW-MIA flag	816-0040

- WINDSHIELDS / FAIRINGS
- AUDIO / COMMUNICATION
- SEATS / LUGGAGE
- BARS / MIRRORS / CONTROLS
- EXHAUST
- AIR / FUEL SYSTEMS
- ENGINE
- TRANSMISSION / DRIVELINE
- GASKETS / SEALS
- ELECTRICAL
- LIGHTING
- CABLES
- BRAKES
- OIL FILTERS
- SUSPENSION
- BODY
- WHEELS
- TIRES / TIRE ACC.
- BIKE ACC.**
- VICTORY / INDIAN
- COVERS / LOCKS / TIEDOWNS
- CHEMICALS
- TOOLS
- HELMETS
- HELMET ACC.
- EYEWEAR
- APPAREL / RIDER ACC.
- PROMOTIONAL
- REFERENCE
- INDEX

WINDSHIELDS / FAIRINGS  
 AUDIO / COMMUNICATION  
 SEATS / LUGGAGE  
 BARS / MIRRORS / CONTROLS  
 EXHAUST  
 AIR / FUEL SYSTEMS  
 ENGINE  
 TRANSMISSION / DRIVELINE  
 GASKETS / SEALS  
 ELECTRICAL  
 LIGHTING  
 CABLES  
 BRAKES  
 OIL FILTERS  
 SUSPENSION  
 BODY  
 WHEELS  
 TIRES / TIRE ACC.  
**BIKE ACC.**  
 VICTORY / INDIAN  
 COVERS / LOCKS / TIEDOWNS  
 CHEMICALS  
 TOOLS  
 HELMETS  
 HELMET ACC.  
 EYEWEAR  
 APPAREL / RIDER ACC.  
 PROMOTIONAL  
 REFERENCE  
 INDEX



### LICENSE PLATE BRACKET KIT

- All mounting hardware included
- Includes rubber spacers to isolate license plate vibration
- Give your bike a new look

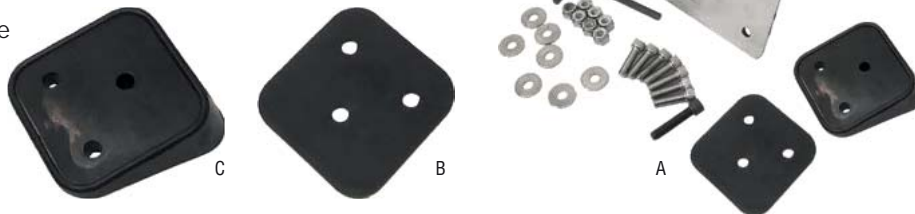

Description	Application	WPS#
A Chrome fender mount	'55-Up H-D models (except FLT, FXST, and FXDWG)	820-0384
B Rubber mounting gasket Flat style		820-0385
C Rubber mounting gasket Wedge style		820-0386

### LICENSE PLATE MOUNTING BRACKET

- Chrome
- Adjustable, so you can fit almost any license plate
- Fits '55-Up Sportster and Big Twin models (except FXDWG and FXST)

Description	WPS#
A Three-hole OEM style mounting bracket	820-2675
B Two-hole OEM style mounting bracket	820-2676

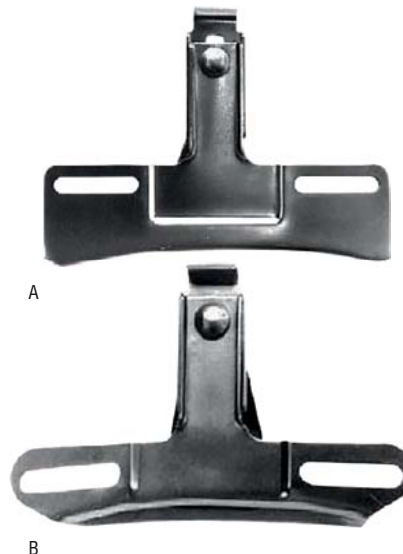

### LICENSE PLATE FRAME

- Handcrafted from 6061 Billet Aluminum
- Perfect piece to finish off your Darkside Edition!
- Darkside License plate holder is available in our Contrast Cut Black or Show Chrome finishes
- Made in the USA



Description	WPS#
Darkside Black	810-0802
Darkside Chrome	810-0801



### LICENSE PLATE FRAMES

Description	Black	Chrome
Frame only	60-1305	60-1310
Frame w/4 amber reflectors	60-1306	60-1311
Frame w/4 red reflectors	60-1307	60-1312
Frame w/4 blue reflectors	60-1308	60-1313
Frame w/4 green reflectors	60-1309	60-1314





### MINI REGISTRATION TUBES

Conveniently stores your registration behind your license plate holder. Adjustable brackets mount to the rear of most stock license plate assemblies. The hardware mounts through the front of the license frame. The end caps on the tube are sealed with o-rings to insure a water-tight seal. The length of the tube is 4.5". The Tube is constructed of polished Stainless Steel. The brackets are machined from 6061-T6 Billet Aluminum, then polished and chrome plated. Includes all necessary mounting hardware.

Application	Description	WPS#
Universal	Upright Style	812-02075
	Laydown Style	812-02076



### STASH TUBE



- Chrome Billet, Ball-milled stash tube kit safely keeps registration and important documents clean and dry
- 10" L x 2.2" Dia
- Inserts to fit 1", 1.125", 1.25" & 1.5" frame tubes

Description	WPS#
Stash tube kit, 10" L x 2.2" Dia	820-2550



- WINDSHIELDS / FAIRINGS
- AUDIO / COMMUNICATION
- SEATS / LUGGAGE
- BAR / MIRRORS / CONTROLS
- EXHAUST
- AIR / FUEL SYSTEMS
- ENGINE
- TRANSMISSION / DRIVELINE
- GASKETS / SEALS
- ELECTRICAL
- LIGHTING
- CABLES
- BRAKES
- OIL FILTERS
- SUSPENSION
- BODY
- WHEELS
- TIRES / TIRE ACC.
- BIKE ACC.**
- VICTORY / INDIAN
- COVERS / LOCKS / TIEDOWNS
- CHEMICALS
- TOOLS
- HELMETS
- HELMET ACC.
- EYEWEAR
- APPAREL / RIDER ACC.
- PROMOTIONAL
- REFERENCE
- INDEX

WINDSHIELDS / FAIRINGS  
 AUDIO / COMMUNICATION  
 SEATS / LUGGAGE  
 BARS / MIRRORS / CONTROLS  
 EXHAUST  
 AIR / FUEL SYSTEMS  
 ENGINE  
 TRANSMISSION / DRIVELINE  
 GASKETS / SEALS  
 ELECTRICAL  
 LIGHTING  
 CABLES  
 BRAKES  
 OIL FILTERS  
 SUSPENSION  
 BODY  
 WHEELS  
 TIRES / TIRE ACC.  
**BIKE ACC.**  
 VICTORY / INDIAN  
 COVERS / LOCKS / TIEDOWNS  
 CHEMICALS  
 TOOLS  
 HELMETS  
 HELMET ACC.  
 EYEWEAR  
 APPAREL / RIDER ACC.  
 PROMOTIONAL  
 REFERENCE  
 INDEX



## REFLECTORS

- 2 ½" Round reflectors DOT approved, available in red or amber
- 5mm stud or adhesive mounting option
- Made in the U.S.A., SOLD EACH



Description	Amber	Red
Stud Mount	<b>60-1333A</b>	<b>60-1333R</b>
Adhesive Mount	<b>60-1334A</b>	<b>60-1334R</b>

## MINI-REFLECTORS

- Inexpensive
- Great impulse counter item
- 4 pc comes with attractive clam-shell packaging



	4 PC	150 PC	40 PC
Amber	<b>60-1405</b>		<b>60-1330</b>
Red	<b>60-1406</b>	<b>60-1344</b>	<b>60-1340</b>
Blue	<b>60-1407</b>	<b>60-1345</b>	<b>60-1331</b>
Green	<b>60-1408</b>		<b>60-1332</b>



## CHROME LICENSE PLATE FRAME HARDWARE

- Dress up your license plate frame with our Chrome Hardware



**WPS#**  
**57-10000**



## NYLON LICENSE PLATE BOLTS/NUTS

- Bag of 50 black nylon thumb screws and 50 black nylon locknuts for license plates
- Will not rust or corrode
- No tools required, install or remove with fingers
- Locking nut will not vibrate loose

WPS #	
<b>020-00155</b>	50/pk
<b>020-00154</b>	4/pk



## INSPECTION STICKER PLATE

- Used by states that require inspection stickers be placed in a visible area
- 6" tall, 6 ½" wide, attaches behind license plate
- Electroplated black finish



**WPS #**  
**60-1315**

# INSPECTION PLATES



- CNC machined billet aluminum tag plates come in chrome or black finish
- 1/2" center or side mounting hole, 2-3/4" square for sticker
- Texas/Maryland plates are 3-1/2" X 2-3/8"
- On non-removeable type plates the hardware is covered by sticker preventing theft without destroying the sticker
- Made in USA



Description	WPS#
<b>NON-REMOVEABLE INSPECTION PLATE</b>	
Fits 1 1/8" Frame Tubes	<b>850-05005</b>
Fits 1 1/4" Frame Tubes	<b>850-05006</b>
Fits Sportster Models	<b>850-05012</b>
Fits Dyna Models	<b>850-05013</b>



Description	WPS#
<b>INSPECTION TAG PLATES SIDE MOUNT</b>	
Ball Milled Chrome	<b>850-05000</b>
Ball Milled Black	<b>850-05007</b>
Triple Ball Milled Chrome	<b>850-05001</b>
Triple Ball Milled Black	<b>850-05008</b>
Triple Curve Milled Chrome	<b>850-05002</b>
Triple Curve Milled Black	<b>850-05009</b>

Description	WPS#
<b>INSPECTION TAG PLATES CENTER MOUNT</b>	
Ball Milled Chrome	<b>850-05004</b>
Ball Milled Black	<b>850-05010</b>
<b>INSPECTION TAG PLATES TEXAS/MARYLAND</b>	
Ball Milled Chrome	<b>850-05003</b>
Ball Milled Black	<b>850-05011</b>

- WINDSHIELDS / FAIRINGS
- AUDIO / COMMUNICATION
- SEATS / LUGGAGE
- BARS / MIRRORS / CONTROLS
- EXHAUST
- AIR / FUEL SYSTEMS
- ENGINE
- TRANSMISSION / DRIVELINE
- GASKETS / SEALS
- ELECTRICAL
- LIGHTING
- CABLES
- BRAKES
- OIL FILTERS
- SUSPENSION
- BODY
- WHEELS
- TIRES / TIRE ACC.
- BIKE ACC.**
- VICTORY / INDIAN
- COVERS / LOCKS / TIEDOWNS
- CHEMICALS
- TOOLS
- HELMETS
- HELMET ACC.
- EYEWEAR
- APPAREL / RIDER ACC.
- PROMOTIONAL
- REFERENCE
- INDEX



**BIG TWIN BUILDER SETS**



- The perfect combination of Allen screws, Acorn nuts and Washers for Big Twin Motor and Transmission
- Polished chrome plated

**Fasteners included in kit:**

- timing plug
- oil pump
- side covers
- clutch and chain cover
- top front and rear motor mount
- lifter base
- point cover
- header mount
- inner primary to casing
- rocker box
- cylinder base
- motor case
- transmission cover



Application	Year	WPS#
Touring Models	'09-Up All models	<b>830-1000</b>
	'07-08 All models	<b>830-1004</b>
	'99-06 All TC models	<b>830-1010</b>
	'96-98 All EVO models	<b>830-1009</b>
Softtail Models	'07-Up All models (except listed below)	<b>830-1003</b>
	'08-12 FXCW and FXCWC models	<b>830-1001</b>
	'00-06 All TC models	<b>830-1006</b>
	'96-98 All EVO models	<b>830-1007</b>
Dyna Models	'07-Up All models	<b>830-1002</b>
	'06 All models	<b>830-1005</b>
	'99-05 All TC models	<b>830-1011</b>
	'96-98 All EVO models	<b>830-1008</b>

**BIG TWIN CAM & PRIMARY SETS**

- Polished chrome plated
- Made in the USA



Application	Year	WPS#
<b>CAM AND PRIMARY COVER SETS</b>		
Touring	'07-Up All models	<b>830-1014</b>
	'99-06 All models	<b>830-1017</b>
	'87-98 All models	<b>830-1066</b>
Softtail	'07-Up All models (except listed below)	<b>830-1013</b>
	'08-12 FXCW and FXCWC	<b>830-1012</b>
	'00-06 All models	<b>830-1016</b>
	'87-99 All models	<b>830-1020</b>
Dyna	'06-Up All models	<b>830-1015</b>
	'99-05 All models	<b>830-1018</b>
	'91-98 All models	<b>830-1019</b>
FXR	'87-98 All models	<b>830-1066</b>



<b>PRIMARY, CLUTCH AND CHAIN COVER SETS</b>		
Touring	'07-Up All models	<b>830-1022</b>
	'99-06 All models	* <b>830-1021</b>
Softtail	'07-Up All models	<b>830-1023</b>
	'00-06 All models	* <b>830-1067</b>
Dyna	'06-Up All models	<b>830-1023</b>
	'99-05 All models	* <b>830-1067</b>

\*Primary cover only



**HARDWARE ASSORTMENT TRAYS**

- Made in the USA!
- Available in Coarse and Fine threads



Description	WPS#
Chrome plated socket head screws coarse thread	<b>830-1122</b>
Chrome plated socket head screws fine thread	<b>830-1123</b>
Chrome plated nylon insert locknuts	<b>830-1121</b>







562-5021C



562-5021D



562-2312C



## FAIRING MOUNT V-STREAM WINDSCREENS

Fairing-mount VStream Windscreens are designed specifically for each make and model to ensure optimum performance and perfect fit using the OEM mounting hardware.

Description	Year	Material	Height	WPS#
<b>VICTORY</b>				
Cross Country/Tour/8-Ball	'10-17	Poly, FMR, Clear	12.25"	<b>562-5021C</b>
		Poly, FMR, Light Tint	10.5"	<b>562-5021S</b>
		Poly, FMR, Dark Tint	8.3"	<b>562-5021D</b>
Magnum	'15-17	Poly, FMR, Clear	12.25"	<b>562-5021C</b>
		Poly, FMR, Light Tint	10.5"	<b>562-5021S</b>
		Poly, FMR, Dark Tint	8.3"	<b>562-5021D</b>

## SWITCHBLADE<sup>®</sup> WINDSHIELDS

**ON AND OFF IN LESS THAN FIVE SECONDS... WITHOUT TOOLS!**

- The SwitchBlade<sup>®</sup> Quick Release Mount System gives you the flexibility to mount any of four sizes of SwitchBlade Windshields... or none at all!
- SwitchBlade Mount Kits (sold separately) are engineered directly on each model bike to ensure perfect fit and function

Application	Year	Mount Kit	2-UP Clear	Chopped Clear	Tint	Shorty Clear	Tint
<b>VICTORY</b>							
Kingpin (all), Hammer (all)	'04-15	<b>562-21201</b>	<b>562-2219C</b>	<b>562-2319C</b>	<b>562-2319S</b>	<b>562-2419C</b>	<b>562-2419S</b>
Vegas (all), Jackpot (all)	'03-15	<b>562-21212</b>	<b>562-2212C</b>	<b>562-2312C</b>	<b>562-2312S</b>	<b>562-2412C</b>	<b>562-2412S</b>



## WINDSHIELDS

- Made from durable High Impact Acrylic in light or dark tint
- Beautifully finished hardware available in chrome or black
- 9" Height from headlight cutout to top

Application	Year	Light Tint	Light Tint Black Hardware	Dark Tint	Dark Tint Black Hardware
<b>VICTORY</b>					
Boardwalk	'13-14	<b>562-27000</b>	<b>562-27000B</b>	<b>562-27001</b>	<b>562-27001B</b>
Gunner	'14-17	<b>562-27000</b>	<b>562-27000B</b>	<b>562-27001</b>	<b>562-27001B</b>
Hammer	'05-17	<b>562-27006</b>	<b>562-27006B</b>	<b>562-27007</b>	<b>562-27007B</b>
High-Ball	'12-15	<b>562-27000</b>	<b>562-27000B</b>	<b>562-27001</b>	<b>562-27001B</b>
Jackpot	'06-14	<b>562-27000</b>	<b>562-27000B</b>	<b>562-27001</b>	<b>562-27001B</b>
Judge	'13-14	<b>562-27000</b>	<b>562-27000B</b>	<b>562-27001</b>	<b>562-27001B</b>
Kingpin	'04-12	<b>562-27006</b>	<b>562-27006B</b>	<b>562-27007</b>	<b>562-27007B</b>
Vegas	'03-16	<b>562-27000</b>	<b>562-27000B</b>	<b>562-27001</b>	<b>562-27001B</b>

- WINDSHIELDS / FAIRINGS
- AUDIO / COMMUNICATION
- SEATS / LUGGAGE
- BAR / MIRRORS / CONTROLS
- EXHAUST
- AIR / FUEL SYSTEMS
- ENGINE
- TRANSMISSION / DRIVELINE
- GASKETS / SEALS
- ELECTRICAL
- LIGHTING
- CABLES
- BRAKES
- OIL FILTERS
- SUSPENSION
- BODY
- WHEELS
- TIRES / TIRE ACC.
- BIKE ACC.
- VICTORY / INDIAN**
- COVERS / LOCKS / TIEDOWNS
- CHEMICALS
- TOOLS
- HELMETS
- HELMET ACC.
- EYEWEAR
- APPAREL / RIDER ACC.
- PROMOTIONAL
- REFERENCE
- INDEX



562-20119



## WINDSHIELDS FOR INDIAN SCOUT

- Quick release windshields for Indian Scout
- Mounting kit sold separately

Description	WPS#
<b>INDIAN SCOUT</b>	
Switchblade Chopped Tint	<b>562-2314S</b>
Switchblade Chopped Clear	<b>562-2314C</b>
Switchblade Shorty Tint	<b>562-2414S</b>
Switchblade Shorty Clear	<b>562-2414C</b>
Switchblade 2-UP Clear	<b>562-2214C</b>
Spartan 18.5"	<b>562-20106</b>
Spartan 16.25"	<b>562-20107</b>
Wave QR	<b>562-20119</b>
Mount Kit	<b>562-21186</b>

## Quick Release Windshields with Quantum™ Performance!



**2-Up®**



**Chopped™**



**Shorty®**



## HAND DEFLECTORS

- Hand Deflectors are an economical, easy-to-install solution for keeping your hands warm and dry
- Coupled with a windshield, Hand Deflectors protect your entire upper body from cold wind and rain
- Mounts easily and securely to bike's mirror mounts, yet allows plenty of room for brake/clutch lever movement
- Made from High Impact Acrylic, with mounting hardware in chromed steel and black powder coated steel

Application	Year	WPS #
<b>VICTORY</b>		
V92C	'99-03	<b>562-30407</b>
V92SC	'00-02	<b>562-30407</b>
V92TC	'02-05	<b>562-30407</b>
Vegas	'03-07	<b>562-30407</b>
Kingpin	'04-07	<b>562-30407</b>
Hammer	'05-07	<b>562-30407</b>
Jackpot	'06-07	<b>562-30407</b>



\* May require adjustment of the right switch assembly to provide adequate cable clearance.



### INDIAN SCOUT FENDER TRIM

- Cast in the traditional method by hand not simply stamped sheet metal
- An economical way to add shine and a custom touch
- Available in a two piece kit or front tip only

Indian	Year	Front & Rear Tip	Front Tip Only
Scout	'15-17	562-30151	562-30152



### PALADIN SOLO FENDER RACK

- Stainless steel
- Easy installation
- Hardware included
- It's a quick and simple job that pays back big style points
- Available in brilliant chrome or powder coated gloss black
- Dimensions: length 14.00" width 7.25"

Application	Chrome	Black
'15-18 Indian Scout (except Bobber)	562-21188	562-21189



### SADDLE BAGS FOR INDIAN SCOUT

- Easy-to-use, quarter-turn fasteners for no-tool removal of the saddlebags from the mount frames in just seconds!
- A keyed, push-button lock is recessed into the lid
- Lids are hinged in the front and swing forward for easy access to the interior
- Tight-fitting seals conform to the shape of the lid to keep the elements out
- Mount Kits are custom engineered for each motorcycle to exact specifications and are guaranteed to fit
- Bags are painted gloss black and ready to mount or custom paint to match your bike

Indian	Year	Smoothback	Mount kit (black)
Scout (except Bobber)	'15-18	562-40101	562-4085B

- WINDSHIELDS / FAIRINGS
- AUDIO / COMMUNICATION
- SEATS / LUGGAGE
- BARS / MIRRORS / CONTROLS
- EXHAUST
- AIR / FUEL SYSTEMS
- ENGINE
- TRANSMISSION / DRIVELINE
- GASKETS / SEALS
- ELECTRICAL
- LIGHTING
- CABLES
- BRAKES
- OIL FILTERS
- SUSPENSION
- BODY
- WHEELS
- TIRES / TIRE ACC.
- BIKE ACC.
- VICTORY / INDIAN**
- COVERS / LOCKS / TIEDOWNS
- CHEMICALS
- TOOLS
- HELMETS
- HELMET ACC.
- EYEWEAR
- APPAREL / RIDER ACC.
- PROMOTIONAL
- REFERENCE
- INDEX



## PALADIN QUICKSET BACKREST AND LUGGAGE RACK

- QuickSet™ design allows removal in under five seconds – without tools!
- Minimal docking hardware – almost invisible when backrest is removed
- Key-lockable design for maximum security
- Chromed steel sideplates, uprights and luggage rack with stainless steel working parts



Description	WPS #
Paladin Backrest	562-30500
Paladin Luggage Rack	562-30501

## QUICKSET MOUNT KIT FOR INDIAN SCOUT

WPS#
562-30522



- WINDSHIELDS / FAIRINGS
- AUDIO / COMMUNICATION
- SEATS / LUGGAGE
- BARS / MIRRORS / CONTROLS
- EXHAUST
- AIR / FUEL SYSTEMS
- ENGINE
- TRANSMISSION / DRIVELINE
- GASKETS / SEALS
- ELECTRICAL
- LIGHTING
- CABLES
- BRAKES
- OIL FILTERS
- SUSPENSION
- BODY
- WHEELS
- TIRES / TIRE ACC.
- BIKE ACC.
- VICTORY / INDIAN**
- COVERS / LOCKS / TIEDOWNS
- CHEMICALS
- TOOLS
- HELMETS
- HELMET ACC.
- EYEWEAR
- APPAREL / RIDER ACC.
- PROMOTIONAL
- REFERENCE
- INDEX



**BRASS BALLS**  
CYCLES

WINDSHIELDS / FAIRINGS  
AUDIO / COMMUNICATION  
SEATS / LUGGAGE  
BARS / MIRRORS / CONTROLS  
EXHAUST  
AIR / FUEL SYSTEMS  
ENGINE  
TRANSMISSION / DRIVELINE  
GASKETS / SEALS  
ELECTRICAL  
LIGHTING  
CABLES  
BRAKES  
OIL FILTERS  
SUSPENSION  
BODY  
WHEELS  
TIRES / TIRE ACC.  
BIKE ACC.  
VICTORY / INDIAN  
COVERS / LOCKS / TIEDOWNS  
CHEMICALS  
TOOLS  
HELMETS  
HELMET ACC.  
EYEWEAR  
APPAREL / RIDER ACC.  
PROMOTIONAL  
REFERENCE  
INDEX



**INDIAN GRIPS** **NEW**

Your hands engage with your bike on a more personal and tactile level than the rest of your body. They control your bike. Shouldn't your grips be amazing? Like the leather wrapped steering wheel of a premium automobile, our uniquely designed, precision crafted and hand stitched leather wrapped grips deliver an experience like no other.

First they are CNC machined from billet aircraft grade aluminum with a recessed knurled surface to ensure the leather will not slide or twist. The leather is laser cut to shape then the pattern embossed. Next the leather is dyed & airbrushed. Finally the grips & leather have bonding agent applied. The leather glued and skillfully hand stitched around the grip.

	Description	Black/Tan	Natural/Tan
<b>INDIAN</b>			
A	Scout models	<b>826-01087</b>	<b>826-01086</b>
B	Chieftain models	-	<b>826-01088</b>



**KNURLED SCOUT GRIPS** **NEW**

More Grip and No Slip. These classically styled Moto grips have perfect knurling to ensure great grip without tearing up your hands or gloves. Slight raised arc to fit perfectly in the palm of your hand.

Description	Finish	WPS#
Knurled Grips	Natural	<b>826-01075</b>

**AIR GEL GRIPS**

- The new GEL grips are a very ergonomic grip
- Feature the softest rubber that Avon has used in a street bike grip
- The soft rubber has a unique dimple texture and tacky feel that helps reduce unwanted road and engine vibrations
- The new style grip is complimented by stylish, billet aluminum, triple chrome plated or black anodized end caps and collars



Description	Black	Chrome
<b>INDIAN MODELS (EXCEPT SCOUT)</b>		
Air Gel	<b>40-4232B</b>	<b>40-4232C</b>

**CONTOUR GRIPS**



"Contoured for your hands, custom for your bike!"

- Manufactured in the USA with Kraton rubber and feature a very soft serrated texture to help hang on to your bike
- Finished off with only the best 6061 billet aluminum end caps and collars
- Sold in pairs



Description	Black	Chrome
<b>INDIAN MODELS (EXCEPT SCOUT)</b>		
Custom Contour	<b>40-4231B</b>	<b>40-4231C</b>
<b>ACCESSORIES</b>		
Throttle Boss	<b>40-4391BK*</b>	<b>40-4391C*</b>



## AIR CUSHIONED GRIPS

### "Air Ride For Your Hands!"

- The Avon Air Cushion Anodized grips feel great and are very functional too
- Manufactured in the USA with a special core bar that creates air pockets inside the grip body
- Dampen vibrations, help eliminate the tingle in your hands and soften the overall feel of the ride
- The soft serrated texture on the grip surface helps you hold on to your bike
- 6061 billet aluminum end caps and collars
- Sold in pairs



Description	Black	Chrome
<b>INDIAN MODELS (EXCEPT SCOUT)</b>		
Air Cushioned	<b>40-4230B</b>	<b>40-4230C</b>
<b>ACCESSORIES</b>		
Throttle Boss	<b>40-4390BK*</b>	<b>40-4390C*</b>

## MEMORY FOAM GRIPS FOR INDIAN

- The softest, most durable, chemical resistant grip on the market today
- Vibration dampening grip
- Chrome and black anodized
- The grips are finished off with only the best - 6061 billet aluminum end caps and collars
- Dimensions: Inside length = 5.500" OD = 1.50"
- Sold in pairs



Description	Black	Chrome
<b>INDIAN</b>		
A All models (Except Scout)	<b>40-4233B</b>	<b>40-4233C</b>
B Scout models	<b>40-4234B</b>	<b>40-4234C</b>

## MEMORY FOAM GRIPS FOR VICTORY

Description	Black	Chrome
<b>VICTORY</b>		
All models (except Vision)	<b>40-4416BK</b>	<b>40-4416C</b>



Complete with interchangeable throttle cams



- WINDSHIELDS / FAIRINGS
- AUDIO / COMMUNICATION
- SEATS / LUGGAGE
- BAR / MIRRORS / CONTROLS
- EXHAUST
- AIR / FUEL SYSTEMS
- ENGINE
- TRANSMISSION / DRIVELINE
- GASKETS / SEALS
- ELECTRICAL
- LIGHTING
- CABLES
- BRAKES
- OIL FILTERS
- SUSPENSION
- BODY
- WHEELS
- TIRES / TIRE ACC.
- BIKE ACC.
- VICTORY / INDIAN
- COVERS / LOCKS / TIEDOWNS
- CHEMICALS
- TOOLS
- HELMETS
- HELMET ACC.
- EYEWEAR
- APPAREL / RIDER ACC.
- PROMOTIONAL
- REFERENCE
- INDEX



## CUSTOM CONTOUR GRIPS FOR VICTORY

"Contoured for your hands, custom for your bike!"

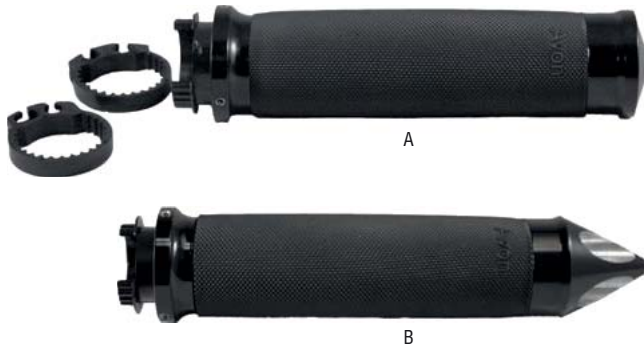

- Manufactured in the USA with Kraton rubber and featuring a very soft serrated texture to help hang on to your bike
- Finished off with only the best, 6061 billet aluminum end caps and collars
- Also available in heated version
- Heated grips have 4 heat settings indicated by LED lights and include a switch
- Inside length 5.50", OD 1.46"
- For 1" bars, sold in pairs

Description	Black	Chrome
<b>VICTORY MODELS (EXCEPT VISION)</b>		
A Custom	<b>40-4400BK</b>	<b>40-4400C</b>
Custom Heated	<b>40-4400HBK</b>	<b>40-4400HC</b>
B Custom Spike	<b>40-4401BK</b>	<b>40-4401C</b>
Custom Spike Heated	<b>40-4401HBK</b>	<b>40-4401HC</b>

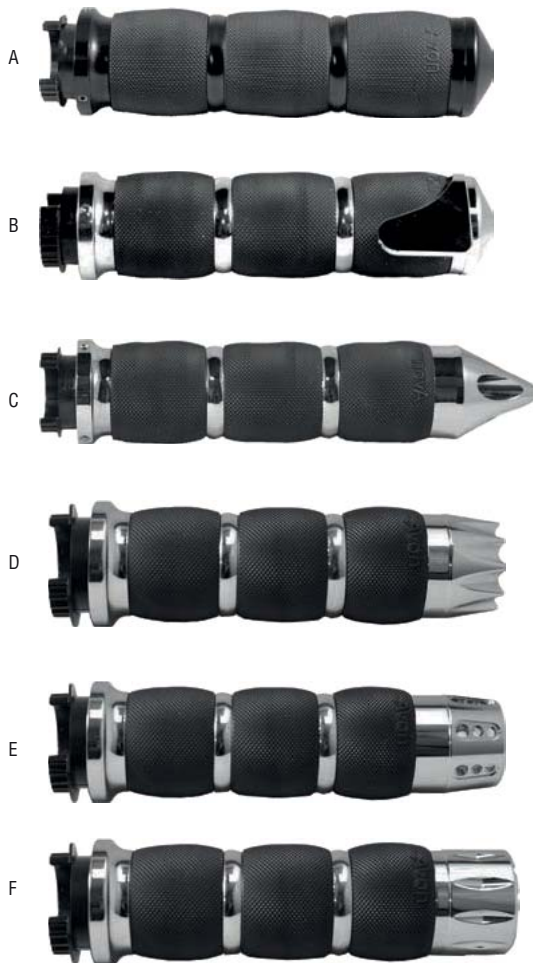

## AIR CUSHIONED GRIPS FOR VICTORY "Air Ride For Your Hands!"

- The Avon Air Cushion feel great and are very functional too
- Manufactured in the USA with a special core bar that creates air pockets inside the grip body
- Dampen vibrations, help eliminate the tingle in your hands and soften the overall feel of the ride
- The soft serrated texture on the grip surface helps you hold on to your bike with no-slip confidence
- The grips are finished off with only the best 6061 billet aluminum end caps and collars
- Also available in heated version
- Heated grips have 4 heat settings indicated by LED lights and include a switch
- Inside length 5.50", OD 1.585"
- For 1" bars, sold in pairs

Description	Black	Chrome
<b>VICTORY MODELS (EXCEPT VISION)</b>		
A Air Cushioned	<b>40-4410BK</b>	<b>40-4410C</b>
Air Cushioned Heated	<b>40-4410HBK</b>	<b>40-4410HC</b>
B Air Cushioned w/Throttle Boss	<b>40-4415BK</b>	<b>40-4415C</b>
Air Cushioned Heated w/Throttle Boss	<b>40-4415HBK</b>	<b>40-4415HC</b>
C Air Cushioned Spike	<b>40-4411BK</b>	<b>40-4411C</b>
Air Cushioned Spike Heated	<b>40-4411HBK</b>	<b>40-4411HC</b>
D Air Cushioned Excaliber	<b>40-4370BK</b>	<b>40-4370C</b>
E Air Cushioned Gatlin	<b>40-4371BK</b>	<b>40-4371C</b>
F Air Cushioned Rival	<b>40-4372BK</b>	<b>40-4372C</b>

### ACCESSORIES

Throttle Boss (not for use with Spiked, Excaliber, Gatlin or Rival grips)	<b>40-4390BK</b>	<b>40-4390C</b>
---	------------------	-----------------

- WINDSHIELDS / FAIRINGS
- AUDIO / COMMUNICATION
- SEATS / LUGGAGE
- BAR / MIRRORS / CONTROLS
- EXHAUST
- AIR / FUEL SYSTEMS
- ENGINE
- TRANSMISSION / DRIVELINE
- GASKETS / SEALS
- ELECTRICAL
- LIGHTING
- CABLES
- BRAKES
- OIL FILTERS
- SUSPENSION
- BODY
- WHEELS
- TIRES / TIRE ACC.
- BIKE ACC.
- VICTORY / INDIAN**
- COVERS / LOCKS / TIEDOWNS
- CHEMICALS
- TOOLS
- HELMETS
- HELMET ACC.
- EYEWEAR
- APPAREL / RIDER ACC.
- PROMOTIONAL
- REFERENCE
- INDEX



Feel the POWER of FREEDOM

## SLIP-ON EXHAUST FOR INDIAN SCOUT

- Freedom Performance slip-ons deliver the perfect sound and performance for Indian Motorcycles
- With exceptional engineering, superior manufacturing, stylish finishes and end tips, you'll get the best in quality and performance that your money can buy
- No matter which slip-ons you choose, you'll get increased power and a unique crisp throttle response
- Made in the U.S.A.!
- **Not legal for use in California on pollution controlled vehicles - Check local laws before installing**



### 4" RACING

Application	Year	Chrome/ Chrome Tip	Chrome/Blk Tip	Black/Blk Tip
Scout	'14-18	82-800065	82-800066	82-800071



### 4" EAGLE

Application	Year	Chrome/ Chrome Tip	Chrome/Blk Tip	Black/Blk Tip
Scout	'14-18	82-800069	82-800070	82-800073



### 4" LIBERTY

Application	Year	Chrome/ Chrome Tip	Chrome/Blk Tip	Black/Blk Tip
Scout	'14-18	82-800067	82-800068	82-800072

- WINDSHIELDS / FAIRINGS
- AUDIO / COMMUNICATION
- SEATS / LUGGAGE
- BARS / MIRRORS / CONTROLS
- EXHAUST
- AIR / FUEL SYSTEMS
- ENGINE
- TRANSMISSION / DRIVELINE
- GASKETS / SEALS
- ELECTRICAL
- LIGHTING
- CABLES
- BRAKES
- OIL FILTERS
- SUSPENSION
- BODY
- WHEELS
- TIRES / TIRE ACC.
- BIKE ACC.
- VICTORY / INDIAN
- COVERS / LOCKS / TIEDOWNS
- CHEMICALS
- TOOLS
- HELMETS
- HELMET ACC.
- EYEWEAR
- APPAREL / RIDER ACC.
- PROMOTIONAL
- REFERENCE
- INDEX





Feel the POWER of FREEDOM

- Exclusive Performance collector for Maximum Horsepower plus torque and Billet end caps
- 1-piece full length heat shields prevent chipping, rust and peeling between sections
- Large 2.5" 16 gauge heavy duty 220 degree blue proof shields available in chrome or black hi temp finish
- Complete with mounting hardware and brackets
- Unmatched sound & performance
- **Not legal for use in California on pollution controlled vehicles - Check local laws before installing**



## SCOUT RADICAL RADIUS EXHAUST



Application	Year	Chrome	Chrome/Blk Tip	Black
Scout	'14-18	82-800074	82-800075	82-800076



## SCOUT COMBAT SHORTY 2-INTO-1



Application	Year	Chrome	Chrome/Blk Tip	Black/ Sculpted Tip	Pitch Black	Black/Chr Tip
Scout	'14-18	82-800080	82-800081	82-800082	82-800085	82-800086



## SCOUT TURNOUT 2-INTO-1



Application	Year	Chrome	Chrome/Blk Tip	Black/ Sculpted Tip	Pitch Black	Black/Chr Tip
Scout	'14-18	82-800077	82-800078	82-800079	82-800083	82-800084

- WINDSHIELDS / FAIRINGS
- AUDIO / COMMUNICATION
- SEATS / LUGGAGE
- BARS / MIRRORS / CONTROLS
- EXHAUST
- AIR / FUEL SYSTEMS
- ENGINE
- TRANSMISSION / DRIVELINE
- GASKETS / SEALS
- ELECTRICAL
- LIGHTING
- CABLES
- BRAKES
- OIL FILTERS
- SUSPENSION
- BODY
- WHEELS
- TIRES / TIRE ACC.
- BIKE ACC.
- VICTORY / INDIAN**
- COVERS / LOCKS / TIEDOWNS
- CHEMICALS
- TOOLS
- HELMETS
- HELMET ACC.
- EYEWEAR
- APPAREL / RIDER ACC.
- PROMOTIONAL
- REFERENCE
- INDEX



Feel the POWER of FREEDOM

## SLIP-ON EXHAUST FOR INDIAN VINTAGE, CLASSIC & CHIEFTAIN

- Freedom Performance slip-ons deliver the perfect sound and performance for Indian Motorcycles
- With exceptional engineering, superior manufacturing, stylish finishes and end tips, you'll get the best in quality and performance that your money can buy
- No matter which slip-ons you choose, you'll get increased power and a unique crisp throttle response
- For the best power match up available, take a look at the Freedom standard true duals, sold separately
- Made in the U.S.A.!
- **Not legal for use in California on pollution controlled vehicles - Check local laws before installing**



### 4" RACING

Application	Year	Chrome/Chrome Tip	Chrome/Blk Tip	Black/Blk Tip
Classic, Vintage, and Darkhorse	'14-18	82-800025	82-800026	82-800027
Chieftain and Roadmaster	'14-18	82-800038	82-800039	82-800040



### 4" EAGLE

Application	Year	Chrome/Chrome Tip	Chrome/Blk Tip	Black/Blk Tip
Classic, Vintage, and Darkhorse	'14-18	82-800031	82-800032	82-800033
Chieftain and Roadmaster	'14-18	82-800044	82-800045	82-800046



### 4" LIBERTY

Application	Year	Chrome/Chrome Tip	Chrome/Blk Tip	Black/Blk Tip
Classic, Vintage, and Darkhorse	'14-18	82-800028	82-800029	82-800030
Chieftain, Roadmaster	'14-18	82-800041	82-800042	82-800043

- WINDSHIELDS / FAIRINGS
- AUDIO / COMMUNICATION
- SEATS / LUGGAGE
- BAR / MIRRORS / CONTROLS
- EXHAUST
- AIR / FUEL SYSTEMS
- ENGINE
- TRANSMISSION / DRIVELINE
- GASKETS / SEALS
- ELECTRICAL
- LIGHTING
- CABLES
- BRAKES
- OIL FILTERS
- SUSPENSION
- BODY
- WHEELS
- TIRES / TIRE ACC.
- BIKE ACC.
- VICTORY / INDIAN**
- COVERS / LOCKS / TIEDOWNS
- CHEMICALS
- TOOLS
- HELMETS
- HELMET ACC.
- EYEWEAR
- APPAREL / RIDER ACC.
- PROMOTIONAL
- REFERENCE
- INDEX



## SLIP-ON EXHAUST FOR INDIAN VINTAGE, CLASSIC & CHIEFTAIN

- Freedom Performance slip-ons deliver the perfect sound and performance for Indian Motorcycles
- With exceptional engineering, superior manufacturing, stylish finishes and end tips, you'll get the best in quality and performance that your money can buy
- No matter which slip-ons you choose, you'll get increased power and a unique crisp throttle response
- For the best power match up available, take a look at the Freedom standard true duals, sold separately
- Made in the U.S.A.!
- **Not legal for use in California on pollution controlled vehicles - Check local laws before installing**



### 4.5" AMERICAN OUTLAW

Application	Year	Chrome/ Chrome Tip	Chrome/Blk Tip	Black/Blk Tip
Classic, Vintage, and Darkhorse	'14-18	<b>82-800049</b>	<b>82-800050</b>	<b>82-800057</b>
Chieftain and Roadmaster	'14-18	<b>82-800053</b>	<b>82-800054</b>	<b>82-800059</b>



### 4.5" COMBAT

Application	Year	Chrome/ Chrome Tip	Chrome/Blk Tip	Black/Blk Tip
Classic, Vintage, and Darkhorse	'14-18	<b>82-800051</b>	<b>82-800052</b>	<b>82-800058</b>
Chieftain and Roadmaster	'14-18	<b>82-800055</b>	<b>82-800056</b>	<b>82-800060</b>

- WINDSHIELDS / FAIRINGS
- AUDIO / COMMUNICATION
- SEATS / LUGGAGE
- BARS / MIRRORS / CONTROLS
- EXHAUST
- AIR / FUEL SYSTEMS
- ENGINE
- TRANSMISSION / DRIVELINE
- GASKETS / SEALS
- ELECTRICAL
- LIGHTING
- CABLES
- BRAKES
- OIL FILTERS
- SUSPENSION
- BODY
- WHEELS
- TIRES / TIRE ACC.
- BIKE ACC.
- VICTORY / INDIAN**
- COVERS / LOCKS / TIEDOWNS
- CHEMICALS
- TOOLS
- HELMETS
- HELMET ACC.
- EYEWEAR
- APPAREL / RIDER ACC.
- PROMOTIONAL
- REFERENCE
- INDEX



Feel the POWER of FREEDOM

## EXHAUST HEADERS FOR INDIAN CHIEF MODELS

- Reduces heat by 30%
- Independent right & left side 1¾" headpipes
- 2 1/8" 220° heavy duty 16 gauge full coverage heat shields
- Compatible with many major manufacturers slip-ons
- Complete with mounting hardware and brackets
- Unbeatable performance
- Made in the U.S.A
- **Not legal for use in California on pollution controlled vehicles - Check local laws before installing**



### TRUE DUAL HEADERS

Application	Year	Chrome	Black
All models (except Scout)	'14-18	<b>82-800034</b>	<b>82-800035</b>



### TRUE DUAL HEADERS WITH SHARKTAILS

Application	Year	Description	Chrome	Black
Classic, Vintage and Darkhorse	'14-18	Chrome full system w/ 2.5" OD Mufflers	<b>82-800036</b>	<b>82-800037</b>
Chieftain and Roadmaster	'14-18	Chrome full system w/ 2.5" OD Mufflers	<b>82-800047</b>	<b>82-800048</b>

## COMPLETE EXHAUST FOR INDIAN CHIEF MODELS

### DUAL SYSTEMS w/2½" M-16 MUFFLERS

- Performance system with full range torque and optimal horsepower
- 220° one-piece 16 gauge heavy duty heat shields
- Removable baffles
- O2 ports & plugs provided if needed
- Offered in chrome or black hi-temp finish
- Complete with mounting hardware and brackets
- **Not legal for use in California on pollution controlled vehicles - Check local laws before installing**



Application	Year	Chrome w/ Black End Caps
Indian Chief Deluxe/Roadmaster/Standard/Vintage	'09-12	<b>82-80014</b>

### SHARKTAIL SYSTEMS

- The worlds only 3-step Sharktail performance exhaust system with triple stepped headers for anti-reversion, full range torque and optimal horsepower
- Exclusive full-length, 1-piece 220° heavy duty 16 gauge heat shields
- Removable performance baffles
- O2 ports & plugs provided for early models
- Complete with mounting hardware and brackets
- Stylish Sharktail tips
- **Not legal for use in California on pollution controlled vehicles - Check local laws before installing**



Application	Year	Description	WPS #
Indian Chief Deluxe/Roadmaster/Standard/Vintage	'09-12	Chrome w/2½" Mufflers	<b>82-80011</b>

- WINDSHIELDS / FAIRINGS
- AUDIO / COMMUNICATION
- SEATS / LUGGAGE
- BARS / MIRRORS / CONTROLS
- EXHAUST
- AIR / FUEL SYSTEMS
- ENGINE
- TRANSMISSION / DRIVELINE
- GASKETS / SEALS
- ELECTRICAL
- LIGHTING
- CABLES
- BRAKES
- OIL FILTERS
- SUSPENSION
- BODY
- WHEELS
- TIRES / TIRE ACC.
- BIKE ACC.
- VICTORY / INDIAN
- COVERS / LOCKS / TIEDOWNS
- CHEMICALS
- TOOLS
- HELMETS
- HELMET ACC.
- EYEWEAR
- APPAREL / RIDER ACC.
- PROMOTIONAL
- REFERENCE
- INDEX

# COMPLETE EXHAUST FOR INDIAN CHIEF MODELS



## DUAL SYSTEMS w/4" RACING MUFFLERS

- Exclusive triple stepped headers for anti-reversion, full range torque and optimal horsepower
- 1-piece full length heat shields prevent chipping, rust and peeling between sections
- 16 gauge heavy duty 220° blue proof shields available in chrome or black hi-temp finish
- Removable baffles
- O2 ports & plugs provided for early models
- Complete with mounting hardware and brackets
- Unmatched sound & performance
- **Not legal for use in California on pollution controlled vehicles - Check local laws before installing**



Application	Year	Description	WPS #	Quiet Baffle
Indian Chief Deluxe/Roadmaster/Standard/Vintage	'09-12	Chrome	<b>82-80001</b>	<b>82-09003</b>
	'09-12	Chrome/Black End Caps	<b>82-80003</b>	
	'09-12	Black	<b>82-80002</b>	

## 2-INTO-1 EXHAUST



- Designed for max torque and increased horsepower
- Drop 24lbs of weight-10lbs compared to stock at 34lbs
- Available in raw brush finish or ceramic black
- Includes stainless steel heat shield
- All TIG welds done by hand
- Accepts stock O2 sensors



Application	Year	Stainless	Black
Indian Scout	'15-18	<b>93-9000S</b>	<b>93-9000B</b>
Victory Octane	'17	<b>93-9000S</b>	<b>93-9000B</b>

- WINDSHIELDS / FAIRINGS
- AUDIO / COMMUNICATION
- SEATS / LUGGAGE
- BARS / MIRRORS / CONTROLS
- EXHAUST
- AIR / FUEL SYSTEMS
- ENGINE
- TRANSMISSION / DRIVELINE
- GASKETS / SEALS
- ELECTRICAL
- LIGHTING
- CABLES
- BRAKES
- OIL FILTERS
- SUSPENSION
- BODY
- WHEELS
- TIRES / TIRE ACC.
- BIKE ACC.
- VICTORY / INDIAN**
- COVERS / LOCKS / TIEDOWNS
- CHEMICALS
- TOOLS
- HELMETS
- HELMET ACC.
- EYEWEAR
- APPAREL / RIDER ACC.
- PROMOTIONAL
- REFERENCE
- INDEX



## FUSION FUEL CONTROLLER

- Uses factory connectors for easy installation
- USB powered from computer (9 volt adapter is no longer needed for programming)
- 2 position map switching function built in (map switch not included)
- Gear input (allows for map adjustment based on gear and speed)
- Analog input (allows user to install any 0-5 volt sensor and build an adjustment table based on its input such as boost or temperature)
- With gear position input connected the Fusion is capable of allowing each cylinder to be mapped individually and for each gear (for example: on a 4 cylinder bike with a six speed transmission there could be up to 24 separate fuel tables).
- Unit has a -100/+250% fuel change range
- 10 throttle position columns
- Enhanced "accel pump" utility (increased adjustment and sensitivity ranges)
- Can use Power Commander maps
- Self tuning available with the optional Dynatune Autotune controller, see AIR/FUEL section



Notes:

- 1 - Includes single channel O2 Optimizer
- 3 - Includes dual channel O2 Optimizer
- 4 - Optional oxygen sensor eliminator required for California and some overseas models, 2 eliminators required - call Dynojet, part #76423005
- 5 - Optional oxygen sensor eliminator required for some overseas models, 2 eliminators required - call Dynojet, part #76423008

- 6 - Optional oxygen sensor eliminator required for California "C" models, 2 eliminators required for California "Retro" models - call Dynojet, part #76423005
- 7 - Requires additional Dynojet hardware for Quickshifter to function - call Dynojet
- 9 - European models require O2 optimizer for closed loop control
- 11 - Optional oxygen eliminator available for California and European models - call Dynojet, part #76423007
- 12 - Includes ignition adjustment

Not legal for use in California on pollution controlled vehicles, race use only in California - waiver available

Application	Year	WPS#
<b>VICTORY</b>		
Octane	'16-17	<b>133-2194</b>
100" models	'08-11	<b>133-2195</b>
106" models	'09-15	<b>133-2196</b>
	'16-17	<b>133-2193</b>
Vision	'09-15	<b>133-2197</b>
	'16-17	<b>133-2192</b>
Victory Crossroads/Crosscountry	'11-15	<b>133-2198</b>

Application	Year	WPS#
<b>INDIAN</b>		
Chief	'14-18	<b>133-2040</b>
Scout	'15-18	<b>133-2041</b>
Scout Sixty	'17-18	<b>133-2042</b>



## Z-FI FUEL CONTROLLER

Bazzaz has developed an in-line unit that precisely controls fuel delivery to optimize engine performance. It is a plug and play unit that piggy-backs onto the stock ECU. Each unit comes with an application specific harness that utilizes OEM connectors for simple installation, and comes pre-programmed for either the stock exhaust or a slip-on. The Z-Fi also features a USB interface with easy to use software, allowing tuning modifications by the end user that can be done at the bike or at a PC being that the system can be powered using the USB connection. The Z-Fi is the first piggyback system on the market that can run up to 8 injectors independently. Bazzaz uses the latest in semi conductor technology creating a control unit that runs on less power, is more efficient, and process faster to make your bike perform better. This all translates into ease of tuning, and significantly better throttle response and performance on applications that utilize 8 injectors like the modern day sportbikes. The Z-Fi can be tuned to perfection using the Z-AFM self mapping module.

- Supplied with application specific harness for easy Plug and Play installation – no cutting into OEM wires
- Pre-programmed with 2 maps, one for stock and one for a slip-on exhaust
- Comes with easy to use software and USB cable making tuning a snap
- Runs up to 8 injectors independently
- TPS Calibration, to account for slight variations between bikes
- Self mapping capability with purchase of optional Z-AFM Kit
- Optional handlebar mounted MAP switch available separately (WPS # 277-A868)



Not legal for use in California on pollution controlled vehicles, race use only in California - waiver available

Application	Year	WPS#
<b>VICTORY</b>		
All models	'12-17	<b>277-F185</b>
<b>ACCESSORIES</b>		
Map Select Switch		<b>277-A868</b>



## ELECTRONIC JET KIT



### “INSTALL AND RIDE, EFI MADE EASY.”

The EJK (Electronic Jet Kit) evolved out of the need to address the ever-increasing complexity of factory fuel injection. For the newcomer to the market or professionals wanting an easier method for tuning fuel injection, the EJK is a customizable solution for the shop that wants to take control of their tuning needs.

- No computer needed
- No dyno required
- Quick "plug and play" installation, initial settings are all preset based on make/model
- Full range tunability, does not interfere with stock ECU
- Simple push button adjustment interface
- 2 year warranty

The GEN 3 is a piggy-back EFI controller because it does not replace the stock ECU, but rather monitors the signals to the injectors and makes fuel adjustments based on the mode settings. The GEN 3 has a push button interface allowing access up to 6 different modes to allow for quick fine tuning by the end user without needing a computer. The GEN 3 also is nitrous oxide compatible, and allows the user to add fuel thru the stock fuel injection when using nitrous oxide.

The GEN 3.5 EFI controller is an extension to the GEN 3 controller. The GEN 3.5 controller has the ability to add or pull fuel within each available fueling zone. The GEN 3.5 is NOT compatible with nitrous oxide systems.

Not legal for use in California on pollution controlled vehicles, race use only in California - waiver available

Application	Year	WPS#	Version
<b>INDIAN</b>			
Chief	'09-13	<b>912-0365</b>	3
	'14-18	<b>912-0436</b> *	3
Chieftain	'14-18	<b>912-0436</b> *	3
Roadmaster	'15-18	<b>912-0436</b> *	3
Scout/Scout Sixty	'15-18	<b>912-0446</b> *	3
Springfield	'16-18	<b>912-0436</b> *	3

Application	Year	WPS#	Version
<b>VICTORY</b>			
All models	'00-07	<b>912-0279</b>	3
	'08-15	<b>912-0420</b> *	3
All models exc. Octane	'16-17	<b>912-0448</b> *	3
Octane	'17	<b>912-0462</b> *	3

## FUEL TUNER



The AFR+ brings together two technologies within one system to make it the most powerful, user-friendly tuning device on the market. AFR+ combines an EFI controller with a wideband O2 sensor and AFR gauge to provide a user instant fuel trimming ability and feedback about their vehicle's state of tune.

- Maximizes power and fuel economy
- Plug and play installation
- On the fly tuning, no dyno required
- Works with all ECU downloads and all brands of aftermarket ECU controllers
- Does not interfere with stock ECU operation
- Includes air/fuel ratio gauge (2 1/8" diameter), wideband controller and Bosch O2 sensor (gauge mount and O2 sensor bung not included)

The AFR+ can handle all of your fueling needs or compliment ECU downloads and already installed EFI controllers. The AFR gauge allows you to know exactly how well your tune-up is performing. The EFI fueling allows you to control any necessary fine tuning without spending more money or valuable time.

- Harley Davidson AFR gauge is chrome w/grey face/orange needle, Indian and Victory AFR gauge is chrome w/white face/orange needle, all others are black w/black face/orange needle. Gauge can be exchanged direct with Dobeck if another color is wanted.
- 1 Year warranty, will not void any OEM factory warranties

Not legal for use in California on pollution controlled vehicles, race use only in California - waiver available

Application	Year	WPS#
<b>INDIAN</b>		
Chief	'09-13	<b>131-12023</b>
	'14-18	<b>131-12024</b>
Chieftan	'14-18	<b>131-12024</b>
Roadmaster	'15-18	<b>131-12024</b>
Scout/Scout Sixty	'15-18	<b>131-12025</b>
Springfield	'16-18	<b>131-12024</b>



Harley Davidson Only

Application	Year	WPS#
<b>VICTORY</b>		
All models exc. Octane	'00-07	<b>131-12013</b>
	'08-15	<b>131-12014</b>
	'16-17	<b>131-12021</b>
Octane	'17-18	<b>131-12026</b>

- WINDSHIELDS / FAIRINGS
- AUDIO / COMMUNICATION
- SEATS / LUGGAGE
- BARS / MIRRORS / CONTROLS
- EXHAUST
- AIR / FUEL SYSTEMS
- ENGINE
- TRANSMISSION / DRIVELINE
- GASKETS / SEALS
- ELECTRICAL
- LIGHTING
- CABLES
- BRAKES
- OIL FILTERS
- SUSPENSION
- BODY
- WHEELS
- TIRES / TIRE ACC.
- BIKE ACC.
- VICTORY / INDIAN
- COVERS / LOCKS / TIEDOWNS
- CHEMICALS
- TOOLS
- HELMETS
- HELMET ACC.
- EYEWEAR
- APPAREL / RIDER ACC.
- PROMOTIONAL
- REFERENCE
- INDEX



**ACCELERATION TUNER**



- WINDSHIELDS / FAIRINGS
- AUDIO / COMMUNICATION
- SEATS / LUGGAGE
- BARS / MIRRORS / CONTROLS
- EXHAUST
- AIR / FUEL SYSTEMS
- ENGINE
- TRANSMISSION / DRIVELINE
- GASKETS / SEALS
- ELECTRICAL
- LIGHTING
- CABLES
- BRAKES
- OIL FILTERS
- SUSPENSION
- BODY
- WHEELS
- TIRES / TIRE ACC.
- BIKE ACC.
- VICTORY / INDIAN**
- COVERS / LOCKS / TIEDOWNS
- CHEMICALS
- TOOLS
- HELMETS
- HELMET ACC.
- EYEWEAR
- APPAREL / RIDER ACC.
- PROMOTIONAL
- REFERENCE
- INDEX

CCT is an acronym for “Consecutive Cycle Tuning”. We use CCT to describe our fuel tuning process, which is the measuring of consecutive cycles of power, with unique amounts of fuel to determine which fuel amount provides the best acceleration.

The process, in many ways, is identical to the acceleration measuring procedure used in today’s most popular tuning dynamometers, such as, those made by Dynojet and other companies. The important thing to remember is the time between consecutive cycles of power and between fuel adjustments on a dynamometer are measured in minutes and is based on one style of load or acceleration simulation at any given time, while the Tier 1 Tuners innovative +CCT Acceleration Optimizer technology has a time between consecutive cycles of power and tuning of fuel that is measured in milliseconds and is based on Real Time/Real Life constant feedback.

The Tier 1 Tuners +CCT Acceleration Optimizer can now provide your motorcycle with Real Time fuel adjustments that will optimize acceleration and compensate for the constantly changing Real Life conditions, (i.e. 1up/2up, head winds, tailwinds, uphill, down hills, etc.) which substantially affects the performance mode operations of your motorcycle throughout your normal daily driving.

The +CCT’s patented technology adds a “Closed Loop” control system to your bikes fuel injection system. Almost all motorcycle fuel injection systems in use today are using “open loop” control systems when they are being driven in a performance manner. “Open loop” refers to a control system that does not have feedback to adapt to conditions outside of its current programming, while a “closed loop” control system functions by its ability to take feedback from an engine sensor. For example, the oxygen sensors common on many of today’s motorcycles use this type of system in cruise, but not in power mode.

The +CCT Acceleration Optimizer unit will add a “closed loop” control system to your current fuel injection system while it is in performance mode. The +CCT Acceleration Optimizer adjusts fuel while receiving feedback from the engine’s acceleration in Real Time/Real Life. The fuel is changed to whatever is needed to optimize the engine’s acceleration while in performance mode.

Tier1Tuners +CCT Acceleration Optimizer can provide up to 95% optimization under Real Time/Real Life performance acceleration.

Most motorcycles today that use an “open loop” control system during power mode operation are typically about 70% optimized (because of various Real Time/Real Life road conditions). When optimizing the fuel map to 70%, a 30% margin is created to maintain good drivability over the full range of acceleration rates found in real life performance driving. The +CCT Acceleration Optimizer’s “closed loop” functionality cuts this margin of error from 30% to only 5% thus giving you up to 95% optimization under Real Time/Real Life performance.

Tier1Tuners new +CCT Acceleration Optimizer is a standalone performance product. It requires no other modifications to deliver its performance potential. The +CCT Acceleration Optimizer derives its benefit from its Real Time/Real Life “closed loop” functionality, not from making a better or different open loop fuel map.



- Real Time Fuel Adjustments
- Up To 95% Optimization Under Real Life Acceleration
- Works On Stock Or Currently Mapped Bikes
- Made In The U.S.A

Application	Year	WPS#
<b>INDIAN</b>		
INDIAN 111CI	13-17	<b>134-30010</b>
SCOUT	15-17	<b>134-30011</b>
<b>VICTORY</b>		
OCTANE	15-17	<b>134-30011</b>
100CI 106CI W/O2 SEN.	08-17	<b>134-30012</b>





# HIGH FLOW REPLACEMENT AIR FILTERS



- Designed to provide increased performance
- Pleated media provides a large filtration area offering long service intervals
- Multi-Layers of woven cotton gauze media offers excellent filtration
- Fits directly into OEM Airbox with application specific sealing bead to ensure a precise fit
- Fuel management modifications are not normally required for increased performance
- Made in the USA for over 40 years
- Washable & reusable, pre-oiled and ready to ride!

Application	Year	Ref. #	WPS#
<b>INDIAN</b>			
Chief all models	'14-16	PL-1814	<b>721814</b>
Chieftain	'14-16	PL-1814	<b>721814</b>
Roadmaster	'15-16	PL-1814	<b>721814</b>
Scout/Scout Sixty	'15-16	PL-1115	<b>721115</b>
Springfield	'16	PL-1814	<b>721814</b>
<b>VICTORY</b>			
Boardwalk	'12-14	PL-1608	<b>721608</b>
Classic Cruiser	'03	PL-1500	<b>721500</b>
Deluxe Cruiser	'02	PL-1500	<b>721500</b>
Gunner	'15-16	PL-1608	<b>721608</b>
Hammer	'05-07	PL-1500	<b>721500</b>
	'08	PL-1608	<b>721608</b>
	'09-14	PL-1608	<b>721608</b>
Hammer 8-Ball	'10-15	PL-1608	<b>721608</b>
Hammer S	'07	PL-1500	<b>721500</b>
	'08-16	PL-1608	<b>721608</b>
High-Ball	'11-16	PL-1608	<b>721608</b>
Jackpot	'14	PL-1608	<b>721608</b>
Judge	'13-15	PL-1608	<b>721608</b>
Kingpin	'04-07	PL-1500	<b>721500</b>
	'08-11	PL-1608	<b>721608</b>

Application	Year	Ref. #	WPS#
<b>VICTORY (CONT'D...)</b>			
Kingpin 8 Ball	'08-11	PL-1608	<b>721608</b>
Kingpin Low	'09-10	PL-1608	<b>721608</b>
Kingpin Tour	'07	PL-1500	<b>721500</b>
	'08-10	PL-1608	<b>721608</b>
Ness Signature Series Jackpot	'06-07	PL-1500	<b>721500</b>
Ness Signature Series Kingpin/Vegas	'05	PL-1500	<b>721500</b>
Standard Cruiser	'02	PL-1500	<b>721500</b>
Touring Cruiser	'02-05	PL-1500	<b>721500</b>
	'06	PL-1500	<b>721500</b>
V92C	'98-01	PL-1598	<b>721598</b>
V92C Deluxe	'01	PL-1500	<b>721500</b>
V92SC	'00-01	PL-1500	<b>721500</b>
Vegas	'03-07	PL-1500	<b>721500</b>
	'08-16	PL-1608	<b>721608</b>
Vegas 8-Ball	'06-07	PL-1500	<b>721500</b>
	'08-16	PL-1608	<b>721608</b>
Vegas Jackpot	'06-07	PL-1500	<b>721500</b>
	'08	PL-1608	<b>721608</b>
	'09-13	PL-1608	<b>721608</b>
Vegas Low	'08-10	PL-1608	<b>721608</b>



- WINDSHIELDS / FAIRINGS
- AUDIO / COMMUNICATION
- SEATS / LUGGAGE
- BARS / MIRRORS / CONTROLS
- EXHAUST
- AIR / FUEL SYSTEMS
- ENGINE
- TRANSMISSION / DRIVELINE
- GASKETS / SEALS
- ELECTRICAL
- LIGHTING
- CABLES
- BRAKES
- OIL FILTERS
- SUSPENSION
- BODY
- WHEELS
- TIRES / TIRE ACC.
- BIKE ACC.
- VICTORY / INDIAN**
- COVERS / LOCKS / TIEDOWNS
- CHEMICALS
- TOOLS
- HELMETS
- HELMET ACC.
- EYEWEAR
- APPAREL / RIDER ACC.
- PROMOTIONAL
- REFERENCE
- INDEX



## SEALS & GASKETS FOR VICTORY

- Genuine James Gaskets uses state of the art materials and production methods to make the best gaskets available
- Gaskets are Foamet® foam covered metal w/sealing bead
- Made in the U.S.A.
- Gaskets/seals listed fit all Victory models '99-up

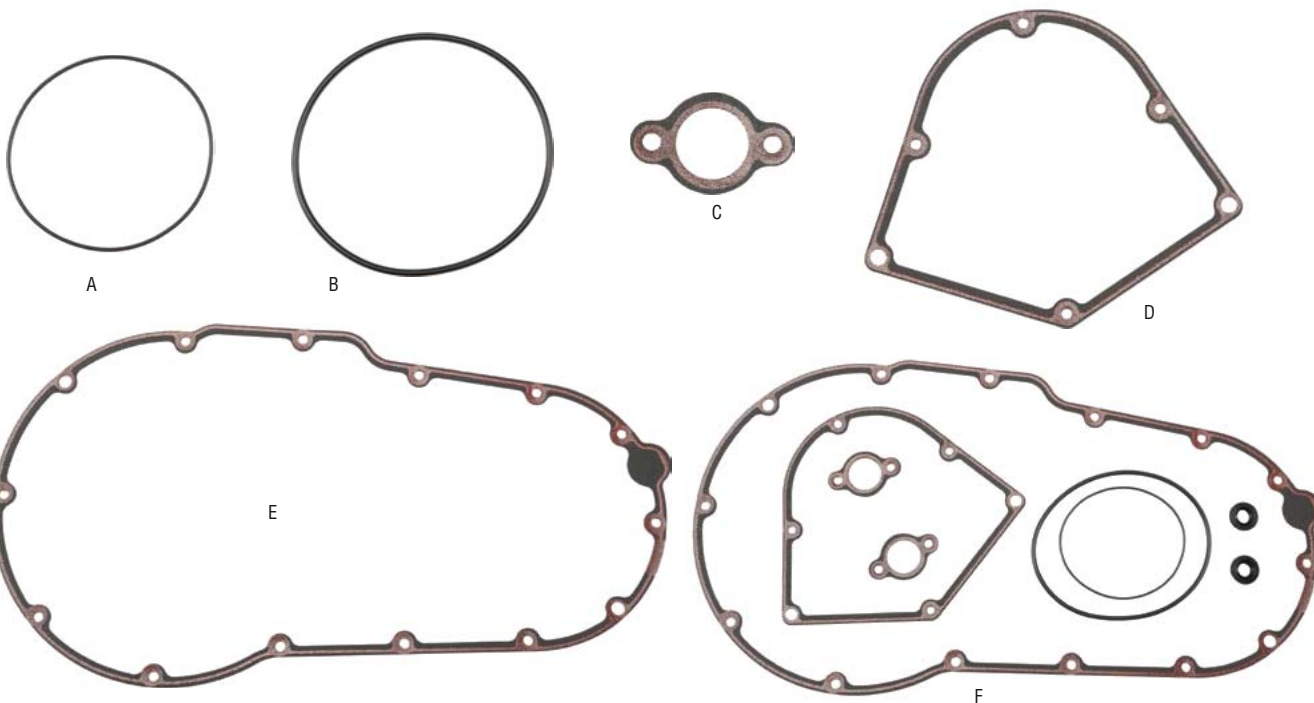

	Description		WPS#
A	Derby cover o-ring	5/pk	<b>681-7000</b>
B	Derby cover cap plate gasket	5/pk	<b>681-7001</b>
C	Chain tensioner gasket	2/pk	<b>681-7002</b>

	Description		WPS#
D	Cam cover	each	<b>681-7003</b>
E	Primary cover gasket	each	<b>681-7004</b>
F	Primary/cam gasket & seal kit	each	<b>681-7005</b>



## SCOUT HEAD GASKETS **NEW**

MLS (Multi Layer Steel) head gaskets for Indian Scout models. Gasket thickness is .027"

Application	WPS#
Scout Models '16-Up 99mm Heads	<b>68-10185</b>
Scout Models '16-Up 102mm Heads	<b>68-10186</b>



# BATTERIES



cc	Application	Year	Battery	Fire Power		YUASA	
				Sealed AGM @	Sealed AGM Factory Activated	YTZ AGM/GRT Sealed & *CX non-sealed Heavy Duty	GYZ Sealed AGM Factory Activated
<b>INDIAN</b>							
1819	Chief Classic/Vintage, Chieftan	'14-16	YTX20HL-BS	49-2301		49-1972	
1638	Chief	'02-03	YTX24HL-BS	49-2291	49-2240	49-1989	
1442	Scout/Spirit	'02-03	YTX20H-BS	49-2300		49-1973	49-1937
	All Models	'99-01	YTX20H-BS	49-2300		49-1973	49-1937
1133	Scout	'15-16	YTX14AH-BS	49-2281	49-2250	49-1960	
<b>VICTORY</b>							
All	All	'98-16	YTX20L-BS	49-2301	49-2252	49-1972	



## LED PASSING LAMP BULB NEW

LED upgrade for Indian Chief and Roadmaster models with passing lamps. Low amp draw. 6000k color temperature, 750 Lumens (80W visually bright). Sold as a set of two.



Description	WPS#
LED Passing Lamp Bulb Kit Indian Chief/Roadmaster H11	226-0080



- WINDSHIELDS / FAIRINGS
- AUDIO / COMMUNICATION
- SEATS / LUGGAGE
- BAR / MIRRORS / CONTROLS
- EXHAUST
- AIR / FUEL SYSTEMS
- ENGINE
- TRANSMISSION / DRIVELINE
- GASKETS / SEALS
- ELECTRICAL
- LIGHTING
- CABLES
- BRAKES
- OIL FILTERS
- SUSPENSION
- BODY
- WHEELS
- TIRES / TIRE ACC.
- BIKE ACC.
- VICTORY / INDIAN
- COVERS / LOCKS / TIEDOWNS
- CHEMICALS
- TOOLS
- HELMETS
- HELMET ACC.
- EYEWEAR
- APPAREL / RIDER ACC.
- PROMOTIONAL
- REFERENCE
- INDEX



## STARTER MOTORS



- New (not rebuilt) starter motors
- Direct OEM replacement
- 1 year limited warranty against factory defects

Application	Year	Silver	Black
<b>VICTORY</b>			
Boardwalk/Judge	'13-17	<b>26-00139</b>	<b>26-00164</b>
Cruiser all models	'00-06	<b>26-00139</b>	<b>26-00164</b>
Cross Country/Cross Roads	'10-13	<b>26-00139</b>	<b>26-00164</b>
Cross Country/Touring	'14-17	<b>26-00139</b>	<b>26-00164</b>
Gunner	'15-17	<b>26-00139</b>	<b>26-00164</b>
Hammer all models	'05-13	<b>26-00139</b>	<b>26-00164</b>
Highball	'12-17	<b>26-00139</b>	<b>26-00164</b>

Application	Year	Silver	Black
<b>VICTORY (CONT'D...)</b>			
Jackpot all models	'06-13	<b>26-00139</b>	<b>26-00164</b>
Kingpin all models	'04-12	<b>26-00139</b>	<b>26-00164</b>
Magnum	'15-17	<b>26-00139</b>	<b>26-00164</b>
Special Edition	All	<b>26-00139</b>	<b>26-00164</b>
Vegas all models	'03-13	<b>26-00139</b>	<b>26-00164</b>
Vegas Jackpot	'06-08	<b>26-00139</b>	<b>26-00164</b>
Vision	'08-17	<b>26-00139</b>	<b>26-00164</b>



## REGULATORS



- All parts are new and built to OEM specifications
- 1 year warranty on all parts
- High quality cost effective replacement for OEM parts

Application	Year	WPS#
<b>INDIAN</b>		
Chief/Chieftan	'14-18	<b>27-10570</b>
Roadmaster	'15-18	<b>27-10570</b>
<b>VICTORY</b>		
Boardwalk	'13-15	<b>27-10569</b>
Cross Country all models	'10-17	<b>27-10568</b>
Cross Roads all models	'10-14	<b>27-10568</b>
Gunner	'15-17	<b>27-10569</b>
Hammer/Hammer Sport	'05-07	<b>27-10560</b>
Hammer all models	'08-15	<b>27-10569</b>
Hard-Ball	'12-13	<b>27-10568</b>
Highball	'12-17	<b>27-10569</b>
Jackpot all models	'08-15	<b>27-10569</b>
Judge	'13-15	<b>27-10569</b>

Application	Year	WPS#
<b>VICTORY (CONT'D...)</b>		
Kingpin all models	'04-05	<b>27-10562</b>
	'06-07	<b>27-10560</b>
	'08-11	<b>27-10569</b>
Magnum	'15-17	<b>27-10568</b>
Vegas all models	'03-04	<b>27-10562</b>
	'05	<b>27-10562</b>
	'06-07	<b>27-10560</b>
	'08-17	<b>27-10569</b>
Vision all models	'08-17	<b>27-10568</b>
V92	'03-06	<b>27-10562</b>
V92C All models	'99-01	<b>27-10559H</b>
	'02	<b>27-10567</b>



## 12V GENERATOR

Cycle Electric Inc. makes generators to fit Indian Chiefs in 6V and 12V configuration. These generators offer a higher than stock output and are therefore equipped with a built in regulator, except 273-1454 which must be used with a high output regulator. They fit in the stock mounting clamp and use the stock 1/2" straight bore pulley.



Indian	WPS#
12V Generator for Indian Chief	<b>273-1454</b>
12V Generator w/built in Regulator for Indian Chief	<b>273-1455</b>
6V Generator w/built in Regulator for Indian Chief	<b>273-1458</b>



## SPARK PLUGS

• Spark plugs sold individually, to receive box order listed box quantity



**Sold each**

Application	Year	Standard	Box Qty	Iridium	Box Qty	Application	Year	Standard	Box Qty	Iridium	Box Qty
<b>INDIAN</b>						<b>VICTORY (CONT'D...)</b>					
Chief	'99-01	2-BPR6ES	4	2-BPR6EIX	4	Cross Roads 8-Ball	'14	2-DCPR6E	10		
Scout	'01	2-BPR6ES	4	2-BPR6EIX	4	Gunner	'15-17	2-DCPR6E	10		
	'02-03	2-BPR6ES	4	2-BPR6EIX	4	Hammer	'05-07	2-CPR6EB-9	10		
	'15-18	2-MR7F	10				'08-11	2-DCPR6E	10		
Spirit	'01	2-BPR6ES	4	2-BPR6EIX	4	Hammer 8-Ball	'10-15	2-DCPR6E	10		
	'02-03	2-BPR6ES	4	2-BPR6EIX	4	Hammer S	'07	2-CPR6EB-9	10		
Chief	'02-03	2-BPR5ES	4	2-BPR5EIX	4		'08-12	2-DCPR6E	10		
Chief Blackhawk	'11	2-BCPR6ES	4				'16-17	2-DCPR6E	10		
Chief Blackhawk Dark	'11	2-BCPR6ES	4			Hard-Ball	'12-13	2-DCPR6E	10		
Chief Bomber	'10	2-BCPR6ES	4			High-Ball	'13-17	2-DCPR6E	10		
Chief Classic	'10-11	2-BCPR6ES	4			Judge	'13-14	2-DCPR6E	10		
	'12-13	2-BKR6ES	4			Kingpin	'04-07	2-CPR6EB-9	10		
Chief Dark Horse	'10-11	2-BCPR6ES	4				'08-12	2-DCPR6E	10		
	'12-13	2-BKR6ES	4			Kingpin 8-Ball	'08-13	2-DCPR6E	10		
Chief Deluxe	'09	2-BCPR6ES	4			Kingpin Low	'09	2-DCPR6E	10		
Chief Roadmaster	'09-11	2-BCPR6ES	4			Kingpin Tour	'07	2-CPR6EB-9	10		
Chief Standard	'09	2-BCPR6ES	4				'08-09	2-DCPR6E	10		
Chief Vintage	'09-11	2-BCPR6ES	4			Magnum	'15-17	2-DCPR6E	10		
	'12-13	2-BKR6ES	4			Magnum X-1	'17	2-DCPR6E	10		
Chief Classic	'14-18	2-DCPR8E	10	2-DCPR8EIX	4	Ness Cross Country LE	'14	2-DCPR6E	10		
Chief Vintage	'14-18	2-DCPR8E	10	2-DCPR8EIX	4	Octane	'17	2-MR7F			
Chieftain	'14-18	2-DCPR8E	10	2-DCPR8EIX	4	Touring Cruiser	'03	2-CR7EB	10	2-CR7EIX	4
Chief Dark Horse	'16-18	2-DCPR8E	10	2-DCPR8EIX	4		'04-06	2-CPR6EB-9	10		
Roadmaster	'15-18	2-DCPR8E	10	2-DCPR8EIX	4	Vegas	'03	2-CR7EB	10	2-CR7EIX	4
<b>VICTORY</b>							'04-07	2-CPR6EB-9	10		
Arlen Ness Jackpot	'06-07	2-CPR6EB-9	10				'08-12	2-DCPR6E	10		
	'08	2-DCPR6E	10				'16-17	2-DCPR6E	10		
Arlen Ness Vision	'09-10	2-DCPR6E	10			Vegas 8-Ball	'05-07	2-CPR6EB-9	10		
	'11-13	2-DCPR6E	10				'08-17	2-DCPR6E	10		
Boardwalk	'13-14	2-DCPR6E	10			Vegas Jackpot	'06-07	2-CPR6EB-9	10		
Classic Cruiser	'03	2-CR7EB	10	2-CR7EIX	4		'08-14	2-DCPR6E	10		
Cory Ness Cross Country	'11-13	2-DCPR6E	10			Vegas Low	'08-09	2-DCPR6E	10		
Cory Ness Jackpot	'08-10	2-DCPR6E	10			Vision 8-Ball	'10-11	2-DCPR6E	10		
Cross Country	'10-17	2-DCPR6E	10			Vision Street	'08-09	2-DCPR6E	10		
Cross Country 8-Ball	'14-17	2-DCPR6E	10			Vision Street Premium	'08-09	2-DCPR6E	10		
Cross Country Tour	'12-17	2-DCPR6E	10			Vision Tour	'08-17	2-DCPR6E	10		
Cross Roads	'10-13	2-DCPR6E	10			Vision Tour 10th Anniv.	'09	2-DCPR6E	10		
Cross Roads Classic	'14	2-DCPR6E	10			Vision Tour Comfort	'08-09	2-DCPR6E	10		
Cross Roads Classic LE	'12-13	2-DCPR6E	10			Vision Tour Premium	'08-09	2-DCPR6E	10		
						Zach Ness Vegas	'11-12	2-DCPR6E	10		
						Zac Ness Cross Country	'13	2-DCPR6E	10		

- WINDSHIELDS / FAIRINGS
- AUDIO / COMMUNICATION
- SEATS / LUGGAGE
- BARS / MIRRORS / CONTROLS
- EXHAUST
- AIR / FUEL SYSTEMS
- ENGINE
- TRANSMISSION / DRIVELINE
- GASKETS / SEALS
- ELECTRICAL
- LIGHTING
- CABLES
- BRAKES
- OIL FILTERS
- SUSPENSION
- BODY
- WHEELS
- TIRES / TIRE ACC.
- BIKE ACC.
- VICTORY / INDIAN
- COVERS / LOCKS / TIEDOWNS
- CHEMICALS
- TOOLS
- HELMETS
- HELMET ACC.
- EYEWEAR
- APPAREL / RIDER ACC.
- PROMOTIONAL
- REFERENCE
- INDEX

# EBC

## FRONT BRAKE APPLICATIONS



USA made, they range has a highly refined copper alloy including extra expensive ingredients to further enhance lifetime and silence the brakes during operation.



**Black Coded:** Street Sport/Touring with Aramid fibre composite, the most popular pad for street use.

**V series:** Heavy duty organic/copper sintered material gives the feel of an organic pad with the wear characteristics of a sintered pad. Great for larger touring bikes, offers stable braking with minimal pad/rotor wear and lower brake dusting of wheels.

**Double-H:** High friction superbike/race sintered formula. Double-H sintered pads offer the maximum brake effect and a lifetime approximately double that of any organic pad. Add "H" to end of part number.

Application	Year	Front Standard	Front V-Series	Front Hi-Perf.	Front Extreme Pro
<b>INDIAN</b>					
Chief / Spirit / Scout	'02-08	15-216/3	15-216/3V	15-216/3H	
Chief all models w/Brembo calipers	'09-13 *	15-95	15-95V	15-95H	
Chieftan/Chief all models w/Nissin calipers	'14-18 *			15-347H	
Roadmaster	'15-18			15-347H	
Scout/Scout 60	'17-18	15-209/2	15-209/2V	15-209/2H	
<b>VICTORY</b>					
Victory V92C (All models single front rotor)	'98-03	15-244	15-244V	15-244H	15-244EP
Victory V92SC	'00-03 *	15-244	15-244V	15-244H	15-244EP
Boardwalk	'13-14			15-347H	
Cross Country	'10-14 *			15-347H	15-347EP
Cross Roads	'10-14 *			15-347H	15-347EP
Cross Touring	'13-14 *			15-347H	
Ness Signature Series	'05-07	15-244	15-244V	15-244H	15-244EP
Hammer	'05-07 *	15-244	15-244V	15-244H	15-244EP
Hammer	'08-11 *			15-347H	15-347EP
Hammer 8 Ball	'10-14 *			15-347H	15-347EP
Hammer S	'07 *	15-244	15-244V	15-244H	15-244EP
Hammer S	'08-12 *			15-347H	15-347EP
Hard Ball	'12-13 *			15-347H	15-347EP
High Ball	'14			15-347H	
Jackpot	'10-14			15-347H	15-347EP
Cory Ness Jackpot	'08-10			15-347H	15-347EP
Judge	'12-13	15-244	15-244V	15-244H	15-244EP
King Pin	'04-07	15-244	15-244V	15-244H	15-244EP
King Pin	'08-12			15-347H	15-347EP
King Pin Tour	'04-07	15-244	15-244V	15-244H	15-244EP
Kingpin Tour	'08-09			15-347H	15-347EP
Kingpin 8-Ball	'08-11			15-347H	15-347EP
Kingpin-Low	'09			15-347H	15-347EP
Vegas	'03-07	15-244	15-244V	15-244H	15-244EP
Vegas	'08-12			15-347H	15-347EP
Vegas 8-Ball	'05-07	15-244	15-244V	15-244H	15-244EP
Vegas 8-Ball	'08-14			15-347H	15-347EP
Vegas Jackpot	'06-07	15-244	15-244V	15-244H	15-244EP
Vegas Jackpot	'08-12			15-347H	15-347EP
Zach Nes Vegas	'11			15-347H	15-347EP
Vegas Low	'08-09			15-347H	15-347EP
Vision 8 Ball	'10-11 *			15-261H	15-261EP
Vision Street	'08-09 *			15-261H	15-261EP
Vision Tour (All models)	'08-14 *			15-261H	15-261EP
Arlen Ness Victory Vision	'10-12 *			15-261H	15-261EP

# REAR BRAKE APPLICATIONS



USA made, they range has a highly refined copper alloy including extra expensive ingredients to further enhance lifetime and silence the brakes during operation.

**Black Coded:** Street Sport/Touring with Aramid fibre composite, the most popular pad for street use.

**V series:** Heavy duty organic/copper sintered material gives the feel of an organic pad with the wear characteristics of a sintered pad. Great for larger touring bikes, offers stable braking with minimal pad/rotor wear and lower brake dusting of wheels.

**Double-H:** High friction superbike/race sintered formula. Double-H sintered pads offer the maximum brake effect and a lifetime approximately double that of any organic pad. Add "H" to end of part number.

Application	Year	Rear Standard	Rear V-Series	Rear Hi-Perf.
<b>INDIAN</b>				
Chief/Spirit/Scout	'02-08	15-216/3	15-216/3V	15-216/3H
Chief/Bomber/Dark Horse	'09-13	15-18	15-18V	15-18H
Chieftan/Chief Classic/Vintage w/nissan calipers	'14-18	15-196	15-196V	15-196H
Roadmaster & Scout (except Scout 60)	'15-18	15-377		
<b>VICTORY</b>				
Arlen Ness Victory Vision	'10-12	15-196	15-196V	15-196H
Boardwalk	'13-14	15-196	15-196V	15-196H
Cory Ness Jackpot	'08-10	15-196	15-196V	15-196H
Cory Ness Victory Cross Country	'11-12	15-196	15-196V	15-196H
Cross Country	'10-12	15-196	15-196V	15-196H
Cross Roads	'10-14	15-196	15-196V	15-196H
Cross Touring	'13-14	15-196	15-196V	15-196H
Hammer	'05-07	15-209/2	15-209/2V	15-209/2H
Hammer	'08-11	15-196	15-196V	15-196H
Hammer 8 Ball	'10-12	15-196	15-196V	15-196H
Hammer S	'07	15-209/2	15-209/2V	15-209/2H
Hammer S	'08-12	15-196	15-196V	15-196H
Hard Ball	'12-13	15-196	15-196V	15-196H
High Ball	'14	15-196	15-196V	15-196H
Jackpot	'10-14	15-196	15-196V	15-196H
Judge	'12-14	15-196	15-196V	15-196H
King Pin	'04-07	15-209/2	15-209/2V	15-209/2H
King Pin	'08-12	15-196	15-196V	15-196H
King Pin Tour	'04-07	15-209/2	15-209/2V	15-209/2H
Kingpin 8-Ball	'08-11	15-196	15-196V	15-196H
Kingpin Tour	'08-09	15-196	15-196V	15-196H
Kingpin-Low	'09	15-196	15-196V	15-196H
Ness Signature Series	'05-07	15-209/2	15-209/2V	15-209/2H
V92C (All models single front rotor)	'98-03	15-209/2	15-209/2V	15-209/2H
V92SC	'00-03	15-209/2	15-209/2V	15-209/2H
Vegas	'03-07	15-209/2	15-209/2V	15-209/2H
Vegas	'08-12	15-196	15-196V	15-196H
Vegas 8-Ball	'05-07	15-209/2	15-209/2V	15-209/2H
Vegas 8-Ball	'08-14	15-196	15-196V	15-196H
Vegas Jackpot	'06-07	15-209/2	15-209/2V	15-209/2H
Vegas Jackpot	'08-12	15-196	15-196V	15-196H
Vegas Low	'08-09	15-196	15-196V	15-196H
Vision 8 Ball	'10-11	15-196	15-196V	15-196H
Vision Street	'08-09	15-196	15-196V	15-196H
Vision Tour (All models)	'08-14	15-196	15-196V	15-196H
Zach Ness Vegas	'11	15-196	15-196V	15-196H

- WINDSHIELDS / FAIRINGS
- AUDIO / COMMUNICATION
- SEATS / LUGGAGE
- BAR / MIRRORS / CONTROLS
- EXHAUST
- AIR / FUEL SYSTEMS
- ENGINE
- TRANSMISSION / DRIVELINE
- GASKETS / SEALS
- ELECTRICAL
- LIGHTING
- CABLES
- BRAKES
- OIL FILTERS
- SUSPENSION
- BODY
- WHEELS
- TIRES / TIRE ACC.
- BIKE ACC.
- VICTORY / INDIAN
- COVERS / LOCKS / TIEDOWNS
- CHEMICALS
- TOOLS
- HELMETS
- HELMET ACC.
- EYEWEAR
- APPAREL / RIDER ACC.
- PROMOTIONAL
- REFERENCE
- INDEX



# HIGH PERFORMANCE BRAKE PADS

- All Braking® brake pads are asbestos and nickel free
- Other brake companies stress friction over other performance factors — Braking® uses an organic base material for outstanding friction along with a soft, non-aggressive metal that allows the pad to glide on the disc, providing better control
- All Braking® brake pads are compatible with cast iron, stainless steel and Carbiron® materials and, when used with Braking® rotors, provide the greatest control and braking power available



### • SM1 SEMI-METALLIC PADS

- Perfect alternative to OE replacement
- Deliver dependable, rugged performance certain to satisfy the most demanding sport riders, commuters and touring enthusiasts
- Superior performance in wet or dry conditions
- SM pads are fade-free, noise-free and dust-free
- Smoothness, consistency and responsiveness from the lowest to highest possible temperature
- Gentle on all rotors

### • SPORT COMPOUND CM55/56 SINTERED METAL PADS

- Upgrade from stock
- CM55/56 sportbike pads are a sintered mixture designed to give power and longevity
- CM55/56 pads offer strong power, stability and improved brake modulation and feel

Application	Year	FRONT		REAR	
		Semi Metallic	Sintered Sport	Sintered Hi Perf	Semi Metallic
<b>VICTORY</b>					
V92SC Victory	'00-01 *	<b>31-784S</b>	<b>31-784</b>	<b>31-784C</b>	<b>31-780S</b>
8 Ball	'05-07	<b>31-784S</b>	<b>31-784</b>	<b>31-784C</b>	<b>31-780S</b>
Arlen Ness	'08		<b>31-906</b>		<b>31-716S</b>
	'04-07	<b>31-784S</b>	<b>31-784</b>	<b>31-784C</b>	<b>31-780S</b>
Hammer	'08		<b>31-906</b>		<b>31-716S</b>
	'05-07 *	<b>31-784S</b>	<b>31-784</b>	<b>31-784C</b>	<b>31-780S</b>
Hammer S	'08 *		<b>31-906</b>		<b>31-716S</b>
	'07 *	<b>31-784S</b>	<b>31-784</b>	<b>31-784C</b>	<b>31-780S</b>
Jackpot	'08 *		<b>31-906</b>		<b>31-716S</b>
	'06-07	<b>31-784S</b>	<b>31-784</b>	<b>31-784C</b>	<b>31-780S</b>
Kingpin	'08		<b>31-906</b>		<b>31-716S</b>
	'04-07	<b>31-784S</b>	<b>31-784</b>	<b>31-784C</b>	<b>31-780S</b>
Kingpin Tour	'08		<b>31-906</b>		<b>31-716S</b>
	'07	<b>31-784S</b>	<b>31-784</b>	<b>31-784C</b>	<b>31-780S</b>
Kingpin 8 Ball	'08		<b>31-906</b>		<b>31-716S</b>
	'03-07	<b>31-784S</b>	<b>31-784</b>	<b>31-784C</b>	<b>31-780S</b>
Vegas	'08		<b>31-906</b>		<b>31-716S</b>
	'08		<b>31-906</b>		<b>31-716S</b>
Vegas Low	'08		<b>31-906</b>		<b>31-716S</b>
Touring Cruiser	'03-05 *	<b>31-784S</b>	<b>31-784</b>	<b>31-784C</b>	<b>31-780S</b>
Vision (all)	'08		<b>31-906</b>		<b>31-716S</b>

\* Two sets are required for this application

- WINDSHIELDS / FAIRINGS
- AUDIO / COMMUNICATION
- SEATS / LUGGAGE
- BAR / MIRRORS / CONTROLS
- EXHAUST
- AIR / FUEL SYSTEMS
- ENGINE
- TRANSMISSION / DRIVELINE
- GASKETS / SEALS
- ELECTRICAL
- LIGHTING
- CABLES
- BRAKES
- OIL FILTERS
- SUSPENSION
- BODY
- WHEELS
- TIRES / TIRE ACC.
- BIKE ACC.
- VICTORY / INDIAN
- COVERS / LOCKS / TIEDOWNS
- CHEMICALS
- TOOLS
- HELMETS
- HELMET ACC.
- EYEWEAR
- APPAREL / RIDER ACC.
- PROMOTIONAL
- REFERENCE
- INDEX





## OIL FILTERS

- Provides unbeatable performance and exceptional value, Hiflo filters are the best-selling brand of aftermarket filters for motorcycles worldwide
- To achieve our high quality and to ensure the consistency of our products, we use only premium raw materials from well known manufacturers
- Every oil filter goes through 16 individual quality control checks before it is ready to leave the factory. The whole manufacturing process, including the checking of raw materials and individual filter testing, is regularly audited and verified independently

Application	Year	Black
<b>INDIAN</b>		
Scout	'15-18	<b>550-0199</b>
Chief (all models)	'15-18	<b>550-0175</b>
Chieftain	'15-18	<b>550-0175</b>
Roadmaster	'15-18	<b>550-0175</b>

Application	Year	Black
<b>VICTORY</b>		
Boardwalk	'13-14	<b>550-0198</b>
Cross Country	'10-17	<b>550-0198</b>
Cross Roads/Classic	'10-14	<b>550-0198</b>
Gunner	'16	<b>550-0198</b>
Hammer	'09-17	<b>550-0198</b>
Hard-ball	'13	<b>550-0198</b>
Highball	'11-17	<b>550-0198</b>
Jackpot	'06-17	<b>550-0198</b>

Application	Year	Black
<b>VICTORY (CONT'D...)</b>		
Judge	'13-17	<b>550-0198</b>
Kingpin	'11-13	<b>550-0198</b>
Kingpin 8 Ball	'11	<b>550-0198</b>
Kingpin 8 Ball/Low/Tour	'03-10	<b>550-0198</b>
Magnum	'16-17	<b>550-0198</b>
Touring Cruiser	'03-06	<b>550-0198</b>
Vegas All	'03-17	<b>550-0198</b>
Vision All	'08-17	<b>550-0198</b>



## OIL FILTERS

- State of the art canister construction eliminates leakage or high pressure blowout
- Fram uses only the finest filtering media to keep oil clean and prevent excessive wear



CC	Application	Year	Standard	Chrome
<b>INDIAN</b>				
1000	Scout Sixty	'16-18	<b>14-6017</b>	
1130	Scout	'15-18	<b>14-6017</b>	
1442	Chief	'99-01	<b>14-6022</b>	<b>14-6065B</b>
	Scout	'01-03	<b>14-6022</b>	<b>14-6065B</b>
	Spirit	'01-03	<b>14-6022</b>	<b>14-6065B</b>
1638	Chief	'02-03	<b>14-6022</b>	<b>14-6065B</b>
1811	Chief	'14-18	<b>14-6017</b>	
	Chief Dark Horse	'16-18	<b>14-6017</b>	
	Roadmaster	'15-18	<b>14-6017</b>	
<b>VICTORY</b>				
1179	Octane	'17	<b>14-6017</b>	
1507	8-Ball	'05	<b>14-6017</b>	
	Classic Cruiser	'03	<b>14-6017</b>	
	Kingpin	'04-05	<b>14-6017</b>	
	Touring Cruiser	'03-05	<b>14-6017</b>	
	V92C	'98-99	<b>14-6017</b>	
	V92C, V92SC	'00-01	<b>14-6017</b>	
	V92C, V92TC	'02	<b>14-6017</b>	
	Vegas	'03-05	<b>14-6017</b>	

CC	Application	Year	Standard	Chrome
<b>VICTORY (CONT'D...)</b>				
1634	Hammer, S	'05-10	<b>14-6017</b>	
	King Pin 8-Ball	'10	<b>14-6017</b>	
	Kingpin, Deluxe, Tour	'06-10	<b>14-6017</b>	
	Touring Cruiser	'06-08	<b>14-6017</b>	
	Vegas Low, 8-Ball	'08-10	<b>14-6017</b>	
	Vegas, 8-Ball, Jackpot	'06-08	<b>14-6017</b>	
	Vegas, Jackpot	'10	<b>14-6017</b>	
1731	Boardwalk	'13-14	<b>14-6017</b>	
	Cross Country	'11-17	<b>14-6017</b>	
	Cross Roads	'11-14	<b>14-6017</b>	
	Hammer, S	'09-17	<b>14-6017</b>	
	Hardball	'13	<b>14-6017</b>	
	Highball	'12-17	<b>14-6017</b>	
	Jackpot	'08-12	<b>14-6017</b>	
	Judge	'13	<b>14-6017</b>	
	King Pin 8-Ball	'11	<b>14-6017</b>	
	Kingpin, Deluxe, Tour	'11-12	<b>14-6017</b>	
	Magnum	'15-17	<b>14-6017</b>	
	Vegas, 8-Ball, Jackpot	'08-17	<b>14-6017</b>	
	Vision (all models)	'08-17	<b>14-6017</b>	

WINDSHIELDS / FAIRINGS  
 AUDIO / COMMUNICATION  
 SEATS / LUGGAGE  
 BARS / MIRRORS / CONTROLS  
 EXHAUST  
 AIR / FUEL SYSTEMS  
 ENGINE  
 TRANSMISSION / DRIVELINE  
 GASKETS / SEALS  
 ELECTRICAL  
 LIGHTING  
 CABLES  
 BRAKES  
 OIL FILTERS  
 SUSPENSION  
 BODY  
 WHEELS  
 TIRES / TIRE ACC.  
 BIKE ACC.  
 VICTORY / INDIAN  
 COVERS / LOCKS / TIEDOWNS  
 CHEMICALS  
 TOOLS  
 HELMETS  
 HELMET ACC.  
 EYEWEAR  
 APPAREL / RIDER ACC.  
 PROMOTIONAL  
 REFERENCE  
 INDEX



## OIL FILTERS

Quality oil filters manufactured by one of the largest manufacturers and suppliers of motorcycle filters.

Today's motorcycles require a high performance oil filter with a high oil flow capacity in order to withstand high heat and pressures. EMGO oil filters meet or exceed these requirements.



Application	Year	Standard
<b>INDIAN</b>		
Scout	'15-18	<b>56-8821</b>
<b>VICTORY</b>		
All models	'03-17	<b>56-8826</b>



## OIL FILTERS

Built to withstand racing conditions, K&N delivers a high-quality oil filter which is built with a synthetic media specifically designed to withstand the high concentrates of synthetic racing oils. A large filter media provides high-flow rates and outstanding oil filtration to keep your motor running clean and smooth. K&N oil filters deliver performance and confidence!



cc	Model	Year	Black	Chrome
<b>VICTORY</b>				
1507	Classic Cruiser	'03	<b>56-0198</b>	
	Deluxe Cruiser	'02	<b>56-0198</b>	
	Standard Cruiser	'02	<b>56-0198</b>	
	Touring Cruiser	'02-06	<b>56-0198</b>	
	V92C/C Deluxe/SC	'99-01	<b>56-0303</b>	<b>56-0303C</b>
1634	Hammer/S	'05-10	<b>56-0198</b>	
	Kingpin all models	'03-11	<b>56-0198</b>	
	Vegas all models	'05-11	<b>56-0198</b>	
	Vision all models	'08-10	<b>56-0198</b>	

cc	Model	Year	Black
<b>VICTORY (CONT'D...)</b>			
1731	Cross Country all models	'10-17	<b>56-0198</b>
	Cross Roads	'10-14	<b>56-0198</b>
	Gunner	'15-17	<b>56-0198</b>
	Hammer all models	'09-17	<b>56-0198</b>
	Hard-Ball	'11-13	<b>56-0198</b>
	High-Ball	'11-17	<b>56-0198</b>
	Jackpot Cory Ness	'09-10	<b>56-0198</b>
	Judge	'13-14	<b>56-0198</b>
	Kingpin	'12-13	<b>56-0198</b>
	Magnum	'15-17	<b>56-0198</b>
	Vegas all models	'09-17	<b>56-0198</b>
	Vision all models	'08-17	<b>56-0198</b>



## FLO® REUSABLE OIL FILTERS

- Reusable filters made from type 304 stainless steel micronic filter cloth
- Rare earth magnet is attached to the top of the element for pre-filtering the oil
- Sophisticated bypass system is engineered for greater oil filtration and proper bypass pressures
- Anodized aluminum housing looks great and helps dissipate heat



Application	Year	Natural
<b>INDIAN</b>		
Chief/Chieftan	'14-18	<b>56-7101</b>
Roadmaster	'16-18	<b>56-7101</b>
Scout	'15-18	<b>56-7101</b>

Application	Year	Natural
<b>VICTORY</b>		
Boardwalk	'13-15	<b>56-7101</b>
Cross Roads/ Cross Country	'10-17	<b>56-7101</b>
Cruiser	'99-05	<b>56-7101</b>
Gunner	'15-17	<b>56-7101</b>
Hammer	'05-17	<b>56-7101</b>
Highball	'11-17	<b>56-7101</b>

Application	Year	Natural
<b>VICTORY (CONT'D...)</b>		
Jackpot	'06-15	<b>56-7101</b>
Judge	'13-17	<b>56-7101</b>
Kingpin	'04-12	<b>56-7101</b>
Magnum	'15-17	<b>56-7101</b>
Touring/Cruiser	'02-07	<b>56-7101</b>
Vegas	'03-17	<b>56-7101</b>
Vision	'08-17	<b>56-7101</b>



### FOX SERIES AIR SUSPENSION FOR INDIAN



- FOX shock absorber
- Goodyear® air spring sleeves
- Compressor w/vent solenoid
- 6061-T6 billet aluminum construction
- Black or chrome handlebar mounted inflation switch (shock is always black)
- Engineered for Indian Chief, Chieftain and Roadmaster models
- Even deflated fender won't touch tire
- Made & tested in USA

Application	Year	Black	Chrome
Indian Touring	'14-18	<b>850-02011</b>	<b>850-02012</b>

### FOX SERIES AIR SUSPENSION FOR VICTORY



- FOX shock absorber
- Goodyear® air spring sleeves
- Compressor w/vent solenoid
- 6061-T6 billet aluminum construction
- Black or chrome handlebar mounted inflation switch (shock is always black)
- Touring version engineered for Victory Baggers, Vision and Cross Country Tour
- Even deflated fender won't touch tire
- Made & tested in USA

Application	Year	Black	Chrome
Victory Touring	'10-17	<b>850-02007</b>	<b>850-02008</b>
Victory Cruiser	'03-17	<b>850-02009</b>	<b>850-02010</b>

- WINDSHIELDS / FAIRINGS
- AUDIO / COMMUNICATION
- SEATS / LUGGAGE
- BARS / MIRRORS / CONTROLS
- EXHAUST
- AIR / FUEL SYSTEMS
- ENGINE
- TRANSMISSION / DRIVELINE
- GASKETS / SEALS
- ELECTRICAL
- LIGHTING
- CABLES
- BRAKES
- OIL FILTERS
- SUSPENSION
- BODY
- WHEELS
- TIRES / TIRE ACC.
- BIKE ACC.
- VICTORY / INDIAN**
- COVERS / LOCKS / TIEDOWNS
- CHEMICALS
- TOOLS
- HELMETS
- HELMET ACC.
- EYEWEAR
- APPAREL / RIDER ACC.
- PROMOTIONAL
- REFERENCE
- INDEX



## STEERING HEAD BEARINGS

- Comes with upper and lower bearings with races and lower seal
- All kits come with tapered roller bearings



Application	Year	WPS#
<b>INDIAN</b>		
Scout	'15-18	<b>22-2060</b>
Chief Classic/Vintage	'14-18	<b>22-2060</b>
Chieftan	'14-18	<b>22-2060</b>
Roadmaster	'15-18	<b>22-2060</b>
<b>VICTORY</b>		
Boardwalk	'13-14	<b>22-2060</b>
Classic Cruiser	'03	<b>22-2032</b>
Cross Country 8 Ball	'15-17	<b>22-2060</b>
Cross Country/Touring	'14-17	<b>22-2060</b>
Cross Country/Cross Roads	'10-13	<b>22-2060</b>
Deluxe Cruiser	'01-02	<b>22-2032</b>
Deluxe Touring Cruiser	'02	<b>22-2032</b>
Gunner	'15-17	<b>22-2060</b>
Hammer	'05-08	<b>22-2004</b>
	'09-13	<b>22-2060</b>
Hammer 8 Ball	'14-17	<b>22-2060</b>

Application	Year	WPS#
<b>VICTORY (CONT'D...)</b>		
Highball	'12-17	<b>22-2060</b>
Jackpot	'06-07	<b>22-2004</b>
	'08-17	<b>22-2060</b>
Judge	'13-17	<b>22-2060</b>
Kingpin	'04-08	<b>22-2004</b>
	'09-12	<b>22-2060</b>
Magnum	'15-17	<b>22-2060</b>
Special Edition	'00	<b>22-2032</b>
Sport Cruiser	'00-01	<b>22-2032</b>
Standard Cruiser	'99-02	<b>22-2032</b>
Touring Cruiser	'02-06	<b>22-2032</b>
Vegas	'03-05	<b>22-2004</b>
Vegas 8 Ball	'06-07	<b>22-2004</b>
	'08-17	<b>22-2060</b>
Vision	'08-17	<b>22-2060</b>

## WHEEL BEARING AND SEAL KITS

- Contains all of the bearings and seals required to re-fit a wheel
- Wheel bearings typically fail from water and dirt contamination. The All Balls wheel bearing was developed in partnership with KML Bearing and is designed for the difficult operating environment of the Power Sport industry
- Premium EMQ quality, hi-speed-bearing featuring low drag, double lip rubber seals which provide superior exclusion of water, dirt and to improved grease retention
- Type TC Nitrile Elastomer wheel seals are specifically designed to keep out water and dirt
- The rubber coated outside diameter creates an optimum seal at the hub
- Steel garter spring guarantees constant pressure on the axle shaft over the life of the seal



Application	Year	Front	Rear
<b>VICTORY</b>			
Boardwalk	'13-14	<b>22-51382</b>	<b>22-51382</b>
Classic Cruiser	'03	<b>22-51379</b>	<b>22-51379</b>
	'10	<b>22-51382</b>	<b>22-51382</b>
Cross Country/Cross Roads	'10-13	<b>22-51382</b>	<b>22-51382</b>
Cross Country/Touring	'14-17	<b>22-51382</b>	<b>22-51382</b>
Cross Roads 8 Ball/Classic	'14	<b>22-51382</b>	<b>22-51382</b>
Deluxe Cruiser	'01-02	<b>22-51379</b>	<b>22-51379</b>
Gunner	'15-17	<b>22-51382</b>	<b>22-51382</b>
Hammer	'05-13	<b>22-51382</b>	<b>22-51382</b>
Hammer 8 Ball	'14-17	<b>22-51382</b>	<b>22-51382</b>
Highball	'12-17	<b>22-51382</b>	<b>22-51382</b>

Application	Year	Front	Rear
<b>VICTORY (CONT'D...)</b>			
Jackpot	'06-17	<b>22-51382</b>	<b>22-51382</b>
Judge	'13-17	<b>22-51382</b>	<b>22-51382</b>
Kingpin	'04-12	<b>22-51382</b>	<b>22-51382</b>
Special Edition	'00	<b>22-51379</b>	<b>22-51379</b>
Sport Cruiser	'00-01	<b>22-51379</b>	<b>22-51379</b>
Standard Cruiser	'99-02	<b>22-51379</b>	<b>22-51379</b>
Touring Cruiser	'02-06	<b>22-51379</b>	<b>22-51379</b>
Vegas/8 Ball	'03-05	<b>22-51382</b>	<b>22-51382</b>
Vision	'08-17	<b>22-51382</b>	<b>22-51382</b>

## FORK/DUST SEAL WIPER KITS



- Patented fork seal features a balanced 3 lip design that evenly distributes the pressure reducing operating temperature, wear and friction.
- Custom Elastomer Fork Seals have been tested to outlast OEM fork seals. Extends typical seal life by 3 to 5 times over OEM seals.

- Stiction (friction) measures from 1/3 to 1/2 less than OEM seals for smoother fork action.
- Lower Stiction, Longer Life! It doesn't get any better than this!
- Plus, the only complete line of dust wipers! Wipers should be replaced with the fork seals to assure peak performance.

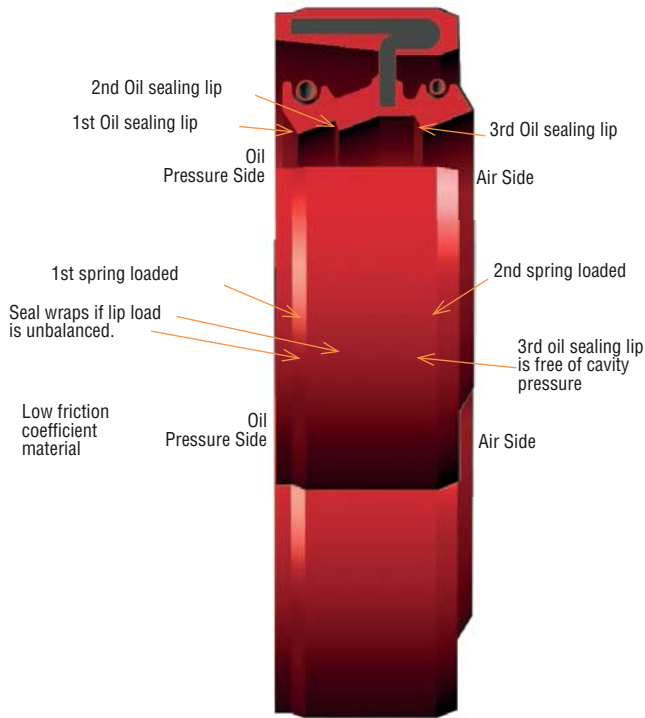

Functions smoothly during repetitive jumping. Seal life is 540,000 strokes, equal to 100 hours of continuous 28.8' jumps. Seal life exceeds current seals by 496,800 strokes (8 hours of continuous 28.8 foot jumps).

Application	Year	Fork Seal Kit	Fork & Dust Seal Kit
<b>VICTORY</b>			
Boardwalk	'13-14	<b>22-55123</b>	<b>22-56137</b>
Classic Cruiser	'03	<b>22-55135</b>	<b>22-56149</b>
Deluxe Cruiser	'01-02	<b>22-55135</b>	<b>22-56149</b>
Deluxe Touring Cruiser	'02	<b>22-55135</b>	<b>22-56149</b>
Gunner	'15-17	<b>22-55123</b>	<b>22-56137</b>
Hammer	'05-08	<b>22-55120</b>	<b>22-56133</b>
Highball	'12-17	<b>22-55123</b>	<b>22-56137</b>
Jackpot	'06-17	<b>22-55123</b>	<b>22-56137</b>
Judge	'13-17	<b>22-55123</b>	<b>22-56137</b>
Kingpin	'04-08	<b>22-55120</b>	<b>22-56133</b>
Standard Cruiser	'99-02	<b>22-55135</b>	<b>22-56149</b>
Touring Cruiser	'02-06	<b>22-55135</b>	<b>22-56149</b>
Vegas	'03-05	<b>22-55123</b>	<b>22-56137</b>
Vegas 8 Ball	'06-17	<b>22-55123</b>	<b>22-56137</b>
Vision	'08	<b>22-55135</b>	<b>22-56149</b>



- WINDSHIELDS / FAIRINGS
- AUDIO / COMMUNICATION
- SEATS / LUGGAGE
- BAR / MIRRORS / CONTROLS
- EXHAUST
- AIR / FUEL SYSTEMS
- ENGINE
- TRANSMISSION / DRIVELINE
- GASKETS / SEALS
- ELECTRICAL
- LIGHTING
- CABLES
- BRAKES
- OIL FILTERS
- SUSPENSION
- BODY
- WHEELS
- TIRES / TIRE ACC.
- BIKE ACC.
- VICTORY / INDIAN**
- COVERS / LOCKS / TIEDOWNS
- CHEMICALS
- TOOLS
- HELMETS
- HELMET ACC.
- EYEWEAR
- APPAREL / RIDER ACC.
- PROMOTIONAL
- REFERENCE
- INDEX

**LINDBY  
CUSTOM, INC.**

**ENGINE GUARDS**

- Triple chrome plated
- 1¼" outside diameter
- Easily installed with simple hand tools
- Comes with all necessary hardware and instructions

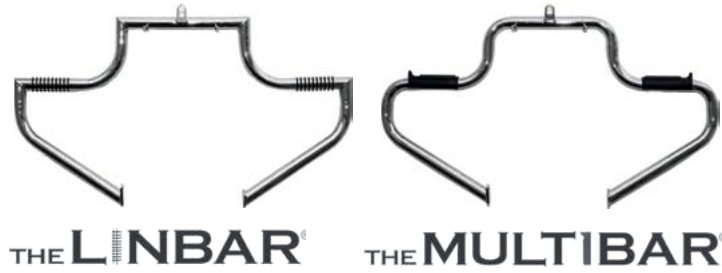

Application	Year	Finish	Linbar	Multibar
<b>INDIAN</b>				
Cheftain/Classic/Vintage	'14-18	Chrome	<b>830-5021</b>	
<b>VICTORY</b>				
V92C	'98-01	Chrome	<b>830-6059</b>	
Kingpin/Vegas	'03-05	Chrome	<b>830-6060</b>	
8 Ball/Hammer/Jackpot/Kingpin/Vegas	'06-15	Chrome	<b>830-6061</b>	<b>830-6108</b>
		Gloss Black		<b>830-6108BK</b>
Cross Country/Cross Roads/Hardball/Magnum	'14-17	Chrome	<b>830-6062</b>	<b>830-6109</b>
<b>BAR REPLACEMENT PARTS</b>				
Linbar	O-ring kit	20 pc	<b>830-6004</b>	
Linbar	Wide O-ring dress up kit	10 pc	<b>830-6009</b>	
Multibar	Rubber pads	2 pc	<b>830-6008</b>	

**CLAMP-ON PEGS**

- Triple Chrome plated with high quality replaceable rubber accents.
- These high quality billet aluminum clamp-on foot pegs will fit any engine guard with specified O.D. (includes Set of 2 Pegs /Left & Right)
- Looks great on the LINBAR, UNIBAR, MULTIBAR or any highway bar



CLAMP-ON PEGS	Bar Size	Finish	WPS#
Wide O-Ring	1½"	Chrome	<b>830-6000</b>
		Black	<b>830-6000BK</b>
3 Wide O-Rings	1¼"	Chrome	<b>830-6002</b>
		Black	<b>830-6002BK</b>
8 O-Rings	1¼"	Chrome	<b>830-6001</b>
		Black	<b>830-6001BK</b>
Rubber Strips	1¼"	Chrome	<b>830-6003</b>
		Black	<b>830-6003BK</b>

<b>PEG REPLACEMENT PARTS</b>		
O-Ring set 6 pc	830-6002/BK	<b>830-6006</b>
O-Ring set 16 pc	830-6001/BK	<b>830-6005</b>
Rubber strip set 8 pc	830-6003/BK	<b>830-6007</b>

**CUSTOM VICTORY WHEELS**



Set your Victory apart from the crowd with a set of our custom billet wheels! Available in three distinct designs to complement the style you are going for. They come in black anodized finish with machined details or high gloss triple chrome finish. All wheels are CNC machined from forged aluminum for superior strength and durability. Our wheels fit all current Victory models and are designed to accept stock rotors and pulleys.

Manufactured and tested in the USA



Flow Black

Flow Chrome

Luck Black

Luck Chrome

Revolver Black

Revolver Chrome

Application	Finish	Size	Flow	Luck	Revolver
Ness/Victory Front All Single Disc	Chrome	18x3.5	<b>576-03001</b>	<b>576-03003</b>	<b>576-03005</b>
		21x3.5	<b>576-03007</b>	<b>576-03009</b>	<b>576-03011</b>
		23x3.5	<b>576-03013</b>	<b>576-03015</b>	<b>576-03017</b>
	Black	18x3.5	<b>576-03000</b>	<b>576-03002</b>	<b>576-03004</b>
		21x3.5	<b>576-03006</b>	<b>576-03008</b>	<b>576-03010</b>
		23x3.5	<b>576-03012</b>	<b>576-03014</b>	<b>576-03016</b>
Victory Front All Dual Disc (Non-ABS)	Chrome	18x3.5	<b>576-03019</b>	<b>576-03021</b>	<b>576-03023</b>
		21x3.5	<b>576-03025</b>	<b>576-03027</b>	<b>576-03029</b>
		23x3.5	<b>576-03031</b>	<b>576-03033</b>	<b>576-03035</b>
	Black	18x3.5	<b>576-03018</b>	<b>576-03020</b>	<b>576-03022</b>
		21x3.5	<b>576-03024</b>	<b>576-03026</b>	<b>576-03028</b>
		23x3.5	<b>576-03030</b>	<b>576-03032</b>	<b>576-03034</b>
Victory Vision/Cross Country Front 10-17 with ABS	Chrome	18x3.5	<b>576-03037</b>	<b>576-03039</b>	<b>576-03041</b>
		21x3.5	<b>576-03043</b>	<b>576-03045</b>	<b>576-03047</b>
		23x3.5	<b>576-03049</b>	<b>576-03051</b>	<b>576-03053</b>
	Black	18x3.5	<b>576-03036</b>	<b>576-03038</b>	<b>576-03040</b>
		21x3.5	<b>576-03042</b>	<b>576-03044</b>	<b>576-03046</b>
		23x3.5	<b>576-03048</b>	<b>576-03050</b>	<b>576-03052</b>
Victory All Models with 18x8.5 Rear	Chrome	18x8.5	<b>576-03055</b>	<b>576-03057</b>	<b>576-03059</b>
	Black	18x8.5	<b>576-03054</b>	<b>576-03056</b>	<b>576-03058</b>
Victory Vegas/8Ball/Kingpin Rear	Chrome	18x5.5	<b>576-03067</b>	<b>576-03069</b>	<b>576-03071</b>
	Black	18x5.5	<b>576-03066</b>	<b>576-03068</b>	<b>576-03070</b>
Victory Vision Rear without ABS	Chrome	18x5.5	<b>576-03061</b>	<b>576-03063</b>	<b>576-03065</b>
	Black	18x5.5	<b>576-03060</b>	<b>576-03062</b>	<b>576-03064</b>
Victory Vision Rear with 11-17 ABS	Chrome	18x5.5	<b>576-03073</b>	<b>576-03075</b>	<b>576-03077</b>
	Black	18x5.5	<b>576-03072</b>	<b>576-03074</b>	<b>576-03076</b>

- WINDSHIELDS / FAIRINGS
- AUDIO / COMMUNICATION
- SEATS / LUGGAGE
- BAR / MIRRORS / CONTROLS
- EXHAUST
- AIR / FUEL SYSTEMS
- ENGINE
- TRANSMISSION / DRIVELINE
- GASKETS / SEALS
- ELECTRICAL
- LIGHTING
- CABLES
- BRAKES
- OIL FILTERS
- SUSPENSION
- BODY
- WHEELS
- TIRES / TIRE ACC.
- BIKE ACC.
- VICTORY / INDIAN**
- COVERS / LOCKS / TIEDOWNS
- CHEMICALS
- TOOLS
- HELMETS
- HELMET ACC.
- EYEWEAR
- APPAREL / RIDER ACC.
- PROMOTIONAL
- REFERENCE
- INDEX



## SPEEDWAY SHELTER

- Speed-Way Shelters fit virtually all Standard, Sport and Touring Motorcycles
- Very fast assembly less than 30 minutes
- Waterproof material. Durable Polyester Fabric with 700mm Polyurethane Coating and Fully Taped Seams for waterproofing
- Includes a 48 lamp LED Bright Light with 3 operating functions. Helpful for night parking or general night access.
- Built-In Locking Hardware allows the SPEED-WAY Shelter to be locked in the lowered position.
- Provides full coverage protection from Sun, Rain, Snow, Dust, Kids, Toys, etc.
- Works great outside or even inside the garage
- Two Large Side Windows offering full ventilation & full closure window covers
- Easy to Use – Simple hand-lift retractable function for covering & uncovering your bike
- Your SPEED-WAY Shelter allows you to park and cover your bike with hot pipes
- Powder coated steel tube structure for rust protection
- Optional Heavy Duty diamond plate rubber floors available to provide moisture control, and protect floors from oil and gas



Description	WPS#
Sport/Std. Shelter	279-0001
Replacement Cover	279-0003
Touring Shelter	279-0002
Replacement Cover	279-0004
Trike Shelter	279-0010
Sport/Std. Floor	279-0006
Touring Floor	279-0007
Trike Floor	279-0011
LED Light	279-0009



- WINDSHIELDS / FAIRINGS
- AUDIO / COMMUNICATION
- SEATS / LUGGAGE
- BAR / MIRRORS / CONTROLS
- EXHAUST
- AIR / FUEL SYSTEMS
- ENGINE
- TRANSMISSION / DRIVELINE
- GASKETS / SEALS
- ELECTRICAL
- LIGHTING
- CABLES
- BRAKES
- OIL FILTERS
- SUSPENSION
- BODY
- WHEELS
- TIRES / TIRE ACC.
- BIKE ACC.
- VICTORY / INDIAN
- COVERS / LOCKS / TIEDOWNS**
- CHEMICALS
- TOOLS
- HELMETS
- HELMET ACC.
- EYEWEAR
- APPAREL / RIDER ACC.
- PROMOTIONAL
- REFERENCE
- INDEX



# CYCLE COVERS



## DEFENDER 2000

- The Ultimate World Class Cover
- All seams are electronically heat sealed making the cover 100% waterproof
- Made from Full-strength UV-treated "Tri-Max"® polyester
- Silver heat Resistant lower panels
- Soft windshield liner helps protect against scratching and hazing
- Exclusive "Perma-Venting"® system prevents condensation build-up and allows constant air circulation
- Snug elastic bottom with one-inch grommets at center and front wheel
- Packed in its own tough compression bag, for the ultimate in compact storage
- Lifetime "No Hassle" warranty
- Available in Black
- Sizes to fit every model (Also fits Honda Gold Wings)
- All XXL sizes include a Free optional antenna grommet kit



Description	WPS#
Medium	270-2001
Large	270-2002
X- Large	270-2003
XX- Large	270-2004



## FALCON DEFENDER 400 & 500

- Made from a medium weight top quality UV-treated "Tri-Max"® polyester
- All seams are electronically heat sealed making the cover 100% waterproof
- Packed in free compression bag for the ultimate in compact storage
- Silver heat resistant lower panels
- Soft windshield liner helps protect against scratching and hazing
- "Perma-Venting"® system prevents condensation build-up and allows constant air circulation
- Snug elastic bottom with one-inch grommets at center and front wheel
- Five-year "No Hassle" warranty
- Available in Black (400) & Grey (500)



Description	400	500
	Black	Grey
Medium	270-2010	270-2005
Large	270-2011	270-2006
X- Large	270-2012	270-2007
XX- Large	270-2013	270-2008

- WINDSHIELDS / FAIRINGS
- AUDIO / COMMUNICATION
- SEATS / LUGGAGE
- BARS / MIRRORS / CONTROLS
- EXHAUST
- AIR / FUEL SYSTEMS
- ENGINE
- TRANSMISSION / DRIVELINE
- GASKETS / SEALS
- ELECTRICAL
- LIGHTING
- CABLES
- BRAKES
- OIL FILTERS
- SUSPENSION
- BODY
- WHEELS
- TIRES / TIRE ACC.
- BIKE ACC.
- VICTORY / INDIAN
- COVERS / LOCKS / TIEDOWNS
- CHEMICALS
- TOOLS
- HELMETS
- HELMET ACC.
- EYEWEAR
- APPAREL / RIDER ACC.
- PROMOTIONAL
- REFERENCE
- INDEX

- WINDSHIELDS / FAIRINGS
- AUDIO / COMMUNICATION
- SEATS / LUGGAGE
- BARS / MIRRORS / CONTROLS
- EXHAUST
- AIR / FUEL SYSTEMS
- ENGINE
- TRANSMISSION / DRIVELINE
- GASKETS / SEALS
- ELECTRICAL
- LIGHTING
- CABLES
- BRAKES
- OIL FILTERS
- SUSPENSION
- BODY
- WHEELS
- TIRES / TIRE ACC.
- BIKE ACC.
- VICTORY / INDIAN
- COVERS / LOCKS / TIEDOWNS**
- CHEMICALS
- TOOLS
- HELMETS
- HELMET ACC.
- EYEWEAR
- APPAREL / RIDER ACC.
- PROMOTIONAL
- REFERENCE
- INDEX



## CYCLE COVERS

### DELUXE ALL-SEASON COVER

- Made from a water resistant\* light weight UV-treated "Tri-Max®" polyester
- Ventilation system minimizes condensation build-up and allows constant air circulation
- Packed in free compression bag for the ultimate in compact storage
- Snug elastic bottom with one-inch grommets at center and front wheel
- Soft windshield liner helps protect against scratching and hazing
- Silver heat resistant lower panels
- Ideal for light/mild outdoor weather conditions and traveling
- Use for temporary storage or in open carports or similar structures
- Cover is not intended for trailering
- 2 year "No Hassle" warranty
- Colors Navy/Silver, Burgundy/Silver, Black/Silver and Black / Hi-Visibility Yellow
- Sizes to fit every model M / L / XL / XXL
- Not waterproof



Description	WPS#	Description	WPS#
<b>MEDIUM - SEE CHART</b>		<b>X-LARGE - SEE CHART</b>	
Burgundy	270-2020	Burgundy	270-2027
Navy	270-2035	Navy	270-2028
Hi-Viz Yellow	270-2021	Hi-Viz Yellow	270-2029
Black	270-2022	Black	270-2030
<b>LARGE - SEE CHART</b>		<b>XX-LARGE - SEE CHART</b>	
Burgundy	270-2023	Burgundy	270-2031
Navy	270-2024	Navy	270-2032
Hi-Viz Yellow	270-2025	Hi-Viz Yellow	270-2033
Black	270-2026	Black	270-2034



### DC-505 DUST COVER

- Protect your bike from dust and spills when garaged
- Made from a new water resistant and breathable non scratch material
- Easy fit to comfortably cover your bike
- Folds easily for storage
- Available in gray
- For indoor use only
- 1 year "No hassle" warranty

Description	WPS#
Large - see chart	270-2050
X-Large - see chart	270-2051
XX-Large - see chart	270-2052



### FITMENT CHART

Medium:  
Fits 125-600cc - Standard without windshield or accessories, and sportbikes.

Large:  
Fits 250-600cc - Standard with windshield and accessories, and sportbikes.  
Fits 650-1100cc - Standard without windshield and accessories, and sportbikes.

X- Large:  
Fits 650-1100cc - Standard and touring bikes with windshield and accessories.

XX-Large:  
Fits 1200-1800cc - Standard and touring bikes with windshield and accessories.

## CYCLE COVERS



### ECONOMY COVER TO FIT EVERY SIZE BIKE



### ECONO COVER

- Made from durable soft PVC
- All seams are heat welded making this cover 100% waterproof
- Fully ventilated using our exclusive "Cool-Vent" System
- Front, and Middle grommets for safety tie-down
- 1 year "No Hassle" warranty



Description	WPS#
<b>BLACK</b>	
Large - fits up to 1200cc	<b>270-2045</b>
X-Large - fits up to 1400cc	<b>270-2046</b>
XX-Large - fits up to 1800cc	<b>270-2047</b>
<b>SILVER</b>	
Large - fits up to 1200cc	<b>270-2041</b>
X-Large - fits up to 1400cc	<b>270-2042</b>
XX-Large - fits up to 1800cc	<b>270-2040</b>



### UV2000 COVER

- Specially treated "UV Protected" nylon Blocks out 99%+ of sun's harmful UV rays and protects against all natural elements
- All seams electronically heat sealed to be completely 100% waterproof. Snug elastic bottom allows for snug fit on all shapes
- Sewn in elastic bungees for universal mounting
- Packed in its own waist pack when folded, it's small enough to fit in almost any storage compartment 1 year "No Hassle" warranty
- Sizes M / L / XL to fit every bike

Description	WPS#
Medium - fits sportbikes 500cc to 800cc	<b>270-2070</b>
Large - fits sportbikes to 1100cc	<b>270-2071</b>
X-Large - fits full dress touring to 1800cc	<b>270-2072</b>

### TRIKE FULL COVER



- This cover is guaranteed to be 100% waterproof
- Made from a medium weight top quality UV-treated "Tri-Max" polyester
- Silver, heat resistant lower panels
- All seams are electronically heat sealed making the cover 100% waterproof
- Soft windshield liner helps protect against scratching and hazing
- A 50" rear zipper allows easy entry to the trunk compartment without having to remove the cover
- Snug elastic bottom with one-inch grommets at center and front wheel
- Packed into its own attractive matching compression carry all
- Five-year "No Hassle" warranty
- Universal fits most trikes

Description	WPS#
Standard Trike - up to 58 wide.	<b>270-2055</b>
XL Trike - up to 65 wide.	<b>270-2056</b>

- WINDSHIELDS / FAIRINGS
- AUDIO / COMMUNICATION
- SEATS / LUGGAGE
- BARS / MIRRORS / CONTROLS
- EXHAUST
- AIR / FUEL SYSTEMS
- ENGINE
- TRANSMISSION / DRIVELINE
- GASKETS / SEALS
- ELECTRICAL
- LIGHTING
- CABLES
- BRAKES
- OIL FILTERS
- SUSPENSION
- BODY
- WHEELS
- TIRES / TIRE ACC.
- BIKE ACC.
- VICTORY / INDIAN
- COVERS / LOCKS / TIEDOWNS**
- CHEMICALS
- TOOLS
- HELMETS
- HELMET ACC.
- EYEWEAR
- APPAREL / RIDER ACC.
- PROMOTIONAL
- REFERENCE
- INDEX



## DELUXE MOTORCYCLE COVER

- Elastic cord with barrel lock allows rider to attach non-marring plastic hook under cover without kneeling on the ground or reaching under the bike
- Two reinforced 30mm grommets to put a cable lock through the front wheel and two in the center for more lock options
- Rain-resistant polyester construction for protection and durability
- Built-in ventilation to prevent condensation
- New hook-and-loop tabs allow the upper vent to stay open, keeping bike cooler on hot days
- Aluminized polyester lower section protects cover on warm pipes
- Custom fit elastic bottom
- Cover includes carrying bag
- Full 12 month warranty



Size	Fits	Black/Silver	Blue/Silver
L	Up to 1100cc sport bikes	27-6028	27-6025
XL	Larger touring models	27-6029	27-6026

## DAY MOTORCYCLE COVER

- Takes up less room in your saddlebags
- Easy to put on and take off for everyday use
- Elastic straps hook to footpegs to secure cover
- Rain-resistant rip-stop nylon construction for protection and durability
- Custom fit elastic bottom
- Cover includes carrying bag
- Full 12 month warranty



Size	Fits	WPS#
L	Up to 1100cc sport bikes	27-6030
XL	Larger touring models	27-6031

## MOTORCYCLE COVERS

Applications on the following pages



### WEATHERALL PLUS

- Features 4 built in alarm sleeves (n/a with medium cruiser and trike covers) for use with up to 2 secure alarm systems
- Waterproof heavyweight polyester construction
- Moisture guard venting system to eliminate condensation
- Flannel liner to protect windshields on large and extra large covers
- Scorch-resistant aluminized lower panels
- Elastic corded bottom hem for a snug fit
- Stuff bag for travel storage
- For 130db secure alarm use 27-6350



### WEATHERALL

- Economically priced
- Urethane coated polyester construction
- Moisture guard venting system
- Flannel windshield liner on large and extra large covers
- Aluminized lowers with an elastic corded hem
- Also available in Urban Camo for sportbikes and scooters



### WEATHERALL PLUS EZ-ZIP

- Heavy duty polyester material for long lasting durability
- ClimaShield Plus fabric coatings ensure water repellency, UV stability and retard the growth of mildew
- Aluminized panels to guard against hot engine and pipes
- EZ On and EZ Off zipper make installation/removal of cover hassle free
- Windshield liner protects windshield from scratching
- Shock cord hem and sewn-in grommets for added security



### ULTRALITE PLUS

- Water repellent rip-stop polyester
- Better tear and abrasion resistance than standard ultralite cover
- Sewn-in storage bag
- Full perimeter elastic cord with locking grommets
- Gray/Silver color

### ULTRALITE

- Water-repellent, lightweight polyester
- Shock cord hem and locking grommets
- Storage bag
- Available in blue, gray, khaki and yellow



### SCOOTER COVER

- Lightweight, urethane coated polyester
- Heat shields allow for immediate use after riding
- Grommets allow use of a cable lock (not included)
- Limited lifetime warranty

[See page 895 for list of part numbers and for applications](#)

WINDSHIELDS / FAIRINGS

AUDIO / COMMUNICATION

SEATS / LUGGAGE

BARS / MIRRORS / CONTROLS

EXHAUST

AIR / FUEL SYSTEMS

ENGINE

TRANSMISSION / DRIVELINE

GASKETS / SEALS

ELECTRICAL

LIGHTING

CABLES

BRAKES

OIL FILTERS

SUSPENSION

BODY

WHEELS

TIRES / TIRE ACC.

BIKE ACC.

VICTORY / INDIAN

COVERS / LOCKS / TIEDOWNS

CHEMICALS

TOOLS

HELMETS

HELMET ACC.

EYEWEAR

APPAREL / RIDER ACC.

PROMOTIONAL

REFERENCE

INDEX



## MOTORCYCLE COVERS

Applications on the following pages

### STREET/CHOPPER DUST COVER

- Soft cotton fabric with “napped” interior for superior scratch prevention
- Breathable fabric allows moisture to escape
- Lockable with reinforced grommets
- Shock cord in hem ensures a snug fit



### LEGEND TRAVELER COVER

- Covers the top half of your bike
- Tough, lightweight synthetic fabric for strength and durability
- Breathable and water repellent
- Covers fairing, seat, and rear trunk
- Elastic cord ensures a snug fit
- Compact design folds easily into tank bag or trunk



### GUARDIAN COVER COMPRESSION BAG

- Compresses your heavy duty cover for maximum packability
- Uses cinch straps and compression pockets to squeeze the cover to its minimum size



See page 895 for list of part numbers and for applications

## MOTORCYCLE COVERS



Size	Description	WPS #	Size	Description	WPS #
<b>WEATHERALL PLUS</b>			<b>ULTRALITE</b>		
Scooter	Large Scooters (up to 250cc)	27-6283	MD	Sport Bikes, Sm. Cruisers w/o windshield	27-6280
SP	Sport Bikes	27-6293		Blue	27-6280B
MD	Sm. Cruisers w/o windshield	27-6294	LG	Lg. Cruisers, Sm. Touring, Sport Touring	27-6282
LG	Sm. Cruisers w/ windshield, Sport Touring	27-6295		Blue	27-6282B
XL	Lg. Cruisers, Sm. Touring	27-6296	XL	Large Touring	27-6281
2XL	Touring	27-6297		Blue	27-6281B
3XI	Lg. Touring	27-6298	<b>HI-VIZ</b>		
TR	Trikes	27-6299	MD	Sport Bikes, Sm. Cruisers w/o windshield	27-6270
3XL TR	Large Trikes	27-62991	XL	Large Touring	27-6271
SPD	Spyders All	27-6255	<b>TRAVELER</b>		
CR	Sm./Md. Cruisers, Angled Front	27-6284	HC	Premium Half Cover	27-6278
AT	Adventure Touring	27-6279	SP	Sport Bikes	27-6265
Alarm	Fits All Weatherall Plus	27-6350	XL	Cruiser, Touring	27-6264
<b>WEATHERALL PLUS EZ-ZIP</b>			<b>SCOOTER COVERS</b>		
XL	Lg. Cruisers, Sm. Touring	27-6250	SM	Mopeds 50cc & under	27-6332
2XL	Touring	27-6258	MD	80cc-250cc w/o windshield	27-6331
3XL	Lg. Touring	27-6259	LG	80cc-250cc w/ windshield &/or trunk	27-6330
<b>WEATHERALL</b>			XL	Up to 650cc	27-6333
SP	Sport Bikes	27-6263	<b>INDOOR DUST COVER</b>		
MD	Sm. Cruisers w/o windshield	27-6261	96"	Customs up to 96" long	27-6291
LG	Sm. Cruisers w/ windshield Sport Touring	27-6260	109"	Customs up to 109" long	27-6290
XL	Lg. Cruisers, Sm. Touring	27-6252	124"	Customs/Sm. Cruisers up to 124"	27-6292
2XL	Touring	27-6254	MD	Md., Lg. Cruisers, Small Touring	27-6287
3XL	Lg. Touring	27-6277	LG	Vintage / Sport Models	27-6288
<b>ULTRALITE PLUS</b>			XL	Large Touring	27-6289
MD	Sport Bikes, Sm. Cruisers w/o windshield	27-6225	<b>ACCESORIES</b>		
LG	Lg. Cruisers, Sm. Touring, Sport Touring	27-6226	Alarm for Weatherall Plus covers		27-6350
XL	Large Touring	27-6227	Cover compression bag, Small		27-6231
AT	Adventure Touring	27-6228	Cover compression bag, Large		27-6232

Optional alarm available: Order 27-6350 in addition to cover

## COVERS APPLICATION CHART

Harley Davidson	Weatherall	Weatherall Plus	Weatherall Plus EZ Zip	UltraLite	UltraLite Plus	Traveler
<b>TOURING MODELS</b>						
All models	27-6252	27-6296	27-6250	27-6282	27-6226	27-6264
<b>SOFTAIL MODELS</b>						
All models (except listed below)	27-6260	27-6295 *		27-6282	27-6226	27-6264
FLSTC Heritage Softail Classic	27-6252	27-6296	27-6250	27-6282	27-6226	27-6264
<b>DYNA/FXR MODELS</b>						
All models (except listed below)	27-6260	27-6295 *		27-6282	27-6226	27-6264
FXRT Sport Glide	27-6260	27-6295 *		27-6281	27-6227	27-6264
FXD Dyna Super Glide	27-6261	27-6294 *		27-6280	27-6225	27-6265
FXR Low Rider/FXR Super Glide	27-6261	27-6294 *		27-6280	27-6225	27-6265
<b>SPORTSTER MODELS</b>						
All models	27-6263	27-6293		27-6280	27-6225	27-6265
<b>V-ROD MODELS</b>						
All models	27-6260	27-6295 *		27-6282	27-6226	27-6264

\* For bikes with windshields, sissy bar, and saddlebags use 27-6284

WINDSHIELDS / FAIRINGS  
AUDIO / COMMUNICATION  
SEATS / LUGGAGE  
BARS / MIRRORS / CONTROLS  
EXHAUST  
AIR / FUEL SYSTEMS  
ENGINE  
TRANSMISSION / DRIVELINE  
GASKETS / SEALS  
ELECTRICAL  
LIGHTING  
CABLES  
BRAKES  
OIL FILTERS  
SUSPENSION  
BODY  
WHEELS  
TIRES / TIRE ACC.  
BIKE ACC.  
VICTORY / INDIAN  
COVERS / LOCKS / TIEDOWNS  
CHEMICALS  
TOOLS  
HELMETS  
HELMET ACC.  
EYEWEAR  
APPAREL / RIDER ACC.  
PROMOTIONAL  
REFERENCE  
INDEX

# KRYPTONITE®

## NEW YORK LEGEND CHAIN

- 15mm round chain links made of 3T hardened steel
- Includes New York Padlock with a 16mm hardened steel shackle and high security disc-style cylinder



Size	WPS#
5' long chain	57-98051

## NEW YORK FAHGETTABOUDIT

- Kryptonite's ultimate security locking system - the toughest they make
- Comes with a New York Disc Lock with case hardened 15mm steel shackle
- Six-sided 14mm hexagonal chain links that are made of case-hardened, triple-heat-treated boron manganese steel



Size	WPS#
5' long chain	57-98012

## EVO 4 CHAIN

- 10mm 6 sided chain links made of manganese steel
- High security disc-style cylinder is pick and drill resistant
- Weather resistant nylon sleeve prevents scratches to painted finishes; compact coiling for easy carrying
- Includes 3 stainless steel keys (one with high-intensity LED bulb)

Size	WPS#
5'-3" chain length	57-98021

## NEW YORK CHAIN W/EVOLUTION SERIES 4 DISC LOCK

- 12mm 6 sided chain links made of triple heat-treated boron manganese steel
- Evolution 4 series disc lock included

Size	WPS#
3'-3" long chain	57-98013
5'-6" long chain	57-98014



## NEW YORK NOOSE W/EVOLUTION SERIES 4 DISC LOCK

- 12mm 6 sided chain links made of triple heat-treated boron manganese steel
- Cinch-loop design enables effective lock up with less length of chain
- Evolution 4 series disc lock included

Size	WPS#
4'-3" long chain	57-98016



## SERIES 2 CHAIN

- 9.5mm 4 sided chain links made of manganese steel
- High security disc-style cylinder is pick and drill resistant
- Weather resistant nylon sleeve prevents scratches to painted finishes; compact coiling for easy carrying
- Includes 2 stainless steel keys

Size	WPS#
5' long chain	57-98023





**KRYPTODISC LOCK**

- Will fit all discs with an opening of at least 10mm in diameter and 2-1/2" from outside edge
- New style keys included
- Lifetime key registration and replacement
- Made from the strongest forged steel to resist cutting, sawing, freezing, and chisel attacks
- Includes carrying pouch and belt clip, unless noted



Color	WPS#
Neon Orange	57-9778*
Chrome	57-9720
Yellow	57-9779

\* Pouch not included

**DISC LOCK REMINDER**

- An added safety reminder to prevent riding away while disc lock is still engaged
- Flexible coiled cable loops from your hand grip



WPS#
57-9726

**KRYPTO DISC 5S**

- Dual reinforced high security disc style cylinder
- 5mm pin diameter fits smaller vent holes
- Compact, lightweight and weatherproof
- Includes disc lock reminder cable



Color	WPS#
Yellow	57-9772
Chrome	57-9773

**NEW YORK 3000 MC**

- Extra thick 5/8" kryptonium™
- Steel sleeve in a "crossbar over crossbar" construction
- High security, anti-pick disc style cylinder with double dead bolt lock
- Included lighted key
- 4" x 10 1/4" shackle



WPS#
57-9746

WINDSHIELDS / FAIRINGS

AUDIO / COMMUNICATION

SEATS / LUGGAGE

BARS / MIRRORS / CONTROLS

EXHAUST

AIR / FUEL SYSTEMS

ENGINE

TRANSMISSION / DRIVELINE

GASKETS / SEALS

ELECTRICAL

LIGHTING

CABLES

BRAKES

OIL FILTERS

SUSPENSION

BODY

WHEELS

TIRES / TIRE ACC.

BIKE ACC.

VICTORY / INDIAN

COVERS / LOCKS / TIEDOWNS

CHEMICALS

TOOLS

HELMETS

HELMET ACC.

EYEWEAR

APPAREL / RIDER ACC.

PROMOTIONAL

REFERENCE

INDEX

# KRYPTONITE®

## KRYPTOFLEX KEY CABLE LOCK

- Flexible braided steel strands for increased cut resistance
- Advanced design cylinder provides greater protection from picking
- Lock head rotates 360 degrees for easier handling during lock up and removal
- Weatherproof vinyl skin protects bike surface



Size	WPS#
3/8" diameter x 6' long	57-98041

## HARDWIRE CABLE LOCK

- Flexible braided steel strands for increased cut resistance
- Reinforced lock head construction with the "Talon" lock pin retention system
- High security disc-style cylinder with anti-drill guard and more than a million different key variations
- Lock head rotates 360 degrees for easier handling during lock up and removal
- Weatherproof vinyl skin protects bike surface



Size	WPS#
20mm diameter x 33" long	57-98043
20mm diameter x 6' long	57-98044

## R2 COMBINATION CABLE

- 2.4mm vinyl coated retracting 3' long cable
- Patented 4 digit resettable combination with easy-grip dials
- Recommended for helmet, jacket and accessory lock up



WPS#
57-9718

## KRYPTOFLEX CABLES

- Braided steel cable has a greater density than twisted cable
- Double-looped cable for use with all U-locks and padlocks



Size	WPS#
2½' long	57-9719
4' long	57-9763
7' long	57-9732
30' long	57-9733

## KRYPTOFLEX COMBO CABLE

- Integrated 4 digit re-settable combination lock with indexed number dials for error free setting
- Flexible, braided steel cable for increased cut resistance
- Lock head rotates 360 degrees for easier handling during lock up and removal



Size	WPS#
3/8" diameter x 6' long	57-98045

## COMBO CABLE

- Self-coiling, flexible twisted steel cable
- Integrated 4 digit re-settable locking head
- Protective vinyl cover



Size	WPS#
5/16" diameter x 5' long	57-98046

WINDSHIELDS / FAIRINGS  
AUDIO / COMMUNICATION  
SEATS / LUGGAGE  
BARS / MIRRORS / CONTROLS  
EXHAUST  
AIR / FUEL SYSTEMS  
ENGINE  
TRANSMISSION / DRIVELINE  
GASKETS / SEALS  
ELECTRICAL  
LIGHTING  
CABLES  
BRAKES  
OIL FILTERS  
SUSPENSION  
BODY  
WHEELS  
TIRES / TIRE ACC.  
BIKE ACC.  
VICTORY / INDIAN  
COVERS / LOCKS / TIEDOWNS  
CHEMICALS  
TOOLS  
HELMETS  
HELMET ACC.  
EYEWEAR  
APPAREL / RIDER ACC.  
PROMOTIONAL  
REFERENCE  
INDEX

# KRYPTONITE®



Color	WPS#
Black	57-98002
Red	57-98004
Yellow	57-98003
Orange w/pouch and reminder cable	57-98001

## EVOLUTION SERIES 4 DISC LOCK

- Oval crossbar design with a hardened 5/16" shackle resists cutting and leverage attacks
- Reinforced anti-drill/pull cylinder with more than a million key variations
- 3 keys included, 2 "I" keys and 1 LED lighted key with high intensity bulb and replaceable battery
- Lifetime key registration and replacement service available
- Vinyl coated and weatherproof

## KRYPTOLOK SERIES 2 DISC LOCK

- 1/2" Hardened performance shackle resists cutting and leverage attacks.
- Patented deadbolt locking mechanism for extensive holding power.
- High security, pick and drill resistant disc style cylinder.
- 2 "I" keys included.
- Rotating dust cover protects cylinder.
- Lifetime key registration and replacement service available.
- Vinyl coated and weatherproof



Color	WPS#
Black/Yellow	57-98010

## NEW YORK DISC LOCK

- 1/2" Kryptonium™ steel shackle
- Steel sleeve in a "crossbar over crossbar" construction
- High security, anti-pick disc style cylinder with double dead bolt lock
- Included carrying pouch and disc lock reminder cable



Color	WPS#
Black/Yellow	57-9727

## 70MM ROUND LOCK

- 19mm Armor protected shackle
- Stainless steel, deep welded body
- 5 pin brass cylinder



WPS#
57-9744

## 44MM PADLOCK

- Hardened steel shackle
- Double dead bolt locking mechanism
- Laminated steel padlock with plated steel body



WPS#
57-9716

## CABLE AND PADLOCK

- 5/16" X 6' self coiling cable
- Hardened steel padlock with plastic cover
- Easy to use and carry



WPS#
57-9711

## STRONGHOLD

- Above ground anchor security
- Hardened carbon alloy shackle
- Comes with cement anchor bolts
- 7 1/2" dia. x 1 5/8" tall

WPS#
57-9776



- WINDSHIELDS / FAIRINGS
- AUDIO / COMMUNICATION
- SEATS / LUGGAGE
- BAR / MIRRORS / CONTROLS
- EXHAUST
- AIR / FUEL SYSTEMS
- ENGINE
- TRANSMISSION / DRIVELINE
- GASKETS / SEALS
- ELECTRICAL
- LIGHTING
- CABLES
- BRAKES
- OIL FILTERS
- SUSPENSION
- BODY
- WHEELS
- TIRES / TIRE ACC.
- BIKE ACC.
- VICTORY / INDIAN
- COVERS / LOCKS / TIEDOWNS
- CHEMICALS
- TOOLS
- HELMETS
- HELMET ACC.
- EYEWEAR
- APPAREL / RIDER ACC.
- PROMOTIONAL
- REFERENCE
- INDEX

WINDSHIELDS / FAIRINGS  
 AUDIO / COMMUNICATION  
 SEATS / LUGGAGE  
 BARS / MIRRORS / CONTROLS  
 EXHAUST  
 AIR / FUEL SYSTEMS  
 ENGINE  
 TRANSMISSION / DRIVELINE  
 GASKETS / SEALS  
 ELECTRICAL  
 LIGHTING  
 CABLES  
 BRAKES  
 OIL FILTERS  
 SUSPENSION  
 BODY  
 WHEELS  
 TIRES / TIRE ACC.  
 BIKE ACC.  
 VICTORY / INDIAN  
 COVERS / LOCKS / TIEDOWNS  
 CHEMICALS  
 TOOLS  
 HELMETS  
 HELMET ACC.  
 EYEWEAR  
 APPAREL / RIDER ACC.  
 PROMOTIONAL  
 REFERENCE  
 INDEX

# TOUGH UNDER FIRE



## TRUCK BED U-LOCK

- Provides locking 190° swivel tie down point
- Hardened steel shackle and lock body
- Fits into pick-up truck bed stake hole pockets or onto the stock tie down locations of the following:

Dodge Ram and Dakota '06-up  
 Ford F-Series '02-up  
 GMC/Chevy 1500/2500 '02-up  
 Toyota Tundra '05-up

**WPS#**  
**57-7621**



## PYTHON ADJUSTABLE CABLE LOCK

- Cut resistant 6' long, 3/8" diameter vinyl coated braided steel cable
- Weather Tough aluminum alloy lock, cylinder shutter

Description	WPS#
Python cable lock	57-7640



## QUANTUM ARMORED CABLE LOCK

- 6' long braided steel cable with 1 3/16" O. D. hardened steel sleeve
- Anti-drill lock cylinder
- Vinyl coated cable for scratch resistance

**WPS#**  
**57-7650**



## QUANTUM 20 CABLE LOCK

- 5' long 20mm vinyl coated braided steel cable
- Integrated mini U-lock for enhanced security
- Looped cable end for increased versatility
- Anti-drill lock cylinder

**WPS#**  
**57-7651**



## TITANIUM SERIES PADLOCKS

- Reinforced with titanium
- Hardened steel shackle
- Ideal with looped cables

Description	WPS#
Keyed	57-7662



## QUANTUM CABLE LOCK

- 6' long 15mm vinyl coated braided steel cable
- Anti-drill lock cylinder

**WPS#**  
**57-7652**



## TUFF LINKS

- 3' long hardened chain with attached lock
- Black nylon sleeve protects from scratches



**WPS#**  
**57-7610**

## CABLE AND PADLOCK

- 1/4" X 6' self coiling cable
- 1 9/16" wide laminated steel lock with weather proof cover
- Hardened steel shackle with molded cover

**WPS#**  
**57-7665**





WPS#  
57-7613

### QUANTUM CUFF AND CAB

- 6' long braided steel, vinyl coated cable
- Super strong cuff type lock assembly
- 3" cuff diameter to fit fork tubes, frames, sign posts, and parking meters

### STREET CUFF LOCK

- Hardened chrome plated steel resists cutting or prying
- Compact and lightweight, folds in half for easy storage
- 3" diameter to fit fork legs or frames, can be secured to sign posts, parking meters or another bike
- Push button keyless locking
- Pivoting action combined with 22" length provides lockdown versatility

WPS#  
57-7601



### STREET CUFF HOLSTER

- Full grain leather holster provides storage and easy access for the 57-7601 Street Cuff
- Compact for comfort and convenience
- Heavy duty snap hold securely while riding

WPS#  
57-7605



### MINI U-LOCK

- 14mm U-lock shackle
- Inside measurements 3 11/16" long X 1 7/8" wide
- Hardened shackle resists cutting and sawing
- Vinyl coated to prevent scratches

WPS#  
57-7620



### 2" DISC BRAKE LOCK

- Prevent roll-away theft
- 2" throat depth with a 6.3mm shackle
- Push button locking system with high security lock
- Orange in color

WPS#  
57-7630



### 3" DISC BRAKE LOCK

- Prevent roll-away theft
- 3" throat depth with a 9.5mm" shackle
- Push button locking system with high security lock
- Orange in color
- Carrying case included

WPS#  
57-7631



### STAINLESS STEEL ROUND PADLOCK

- 2 3/4" wide corrosion resistant stainless steel body
- Fully shielded design minimizes shackle exposure and protects against bolt cutter attacks
- 19mm hardened steel shackle for extra cut resistance

WPS#  
57-7663



### LAMINATED STEEL PADLOCK

- 1 3/4" wide laminated steel body
- 4 pin cylinder helps prevent picking
- Dual locking levers and hardened steel shackle for extra pry and cut resistance

WPS#  
57-7664



- WINDSHIELDS / FAIRINGS
- AUDIO / COMMUNICATION
- SEATS / LUGGAGE
- BAR / MIRRORS / CONTROLS
- EXHAUST
- AIR / FUEL SYSTEMS
- ENGINE
- TRANSMISSION / DRIVELINE
- GASKETS / SEALS
- ELECTRICAL
- LIGHTING
- CABLES
- BRAKES
- OIL FILTERS
- SUSPENSION
- BODY
- WHEELS
- TIRES / TIRE ACC.
- BIKE ACC.
- VICTORY / INDIAN
- COVERS / LOCKS / TIEDOWNS
- CHEMICALS
- TOOLS
- HELMETS
- HELMET ACC.
- EYEWEAR
- APPAREL / RIDER ACC.
- PROMOTIONAL
- REFERENCE
- INDEX

- WINDSHIELDS / FAIRINGS
- AUDIO / COMMUNICATION
- SEATS / LUGGAGE
- BARS / MIRRORS / CONTROLS
- EXHAUST
- AIR / FUEL SYSTEMS
- ENGINE
- TRANSMISSION / DRIVELINE
- GASKETS / SEALS
- ELECTRICAL
- LIGHTING
- CABLES
- BRAKES
- OIL FILTERS
- SUSPENSION
- BODY
- WHEELS
- TIRES / TIRE ACC.
- BIKE ACC.
- VICTORY / INDIAN
- COVERS / LOCKS / TIEDOWNS**
- CHEMICALS
- TOOLS
- HELMETS
- HELMET ACC.
- EYEWEAR
- APPAREL / RIDER ACC.
- PROMOTIONAL
- REFERENCE
- INDEX



### X1 DISC LOCK

- Pushdown, 1/4" hardened steel pin
- Ice spray proof body and barrel
- No alarm



Finish	WPS#
Yellow	56-9655

### X2 DISC LOCK

- 1/2" Carbide reinforced double locking pin
- Ice spray proof body and barrel
- No alarm



Finish	WPS#
Yellow	56-9657

### XCH10-120L

- 10mm Hardened-steel loop chain,
- 46" long, chain bag included
- Works with XXA and XZA cable adaptors

Decription	WPS#
XC14	56-9694
XCH10-120L	56-9673



### XZA-150

Cable adaptor Combo, 150cm 12mm loop cable with XZZ Adaptor (lock sold separately) Ideal for locking helmets

- 150 cm flexible steel cable and XZZ lock adaptor
- For use when disc lock is locked on to disc



WPS#
56-9678

### XX15 ADAPTER

WPS#
56-9674

- Chain adaptor for XX15 locks



### XXA-150

Cable adaptor Combo, 150cm 12mm loop cable with XX6 Adaptor (lock sold separately) Ideal for locking helmets

- 150 cm flexible steel cable and XX lock adaptor
- For use when disc lock is locked on to disc



WPS#
56-9679



## XX SERIES ALARM DISC LOCKS

All XX series locks feature a self-arming 120 db lithium powered alarm, shock and motion sensors, maximum security key barrel, ice spray proof body.

### XX6

- Easy to use push-down locking, 1/4" hardened steel pin
- 120 db lithium powered alarm
- Dimensions 3.3" long x 2.3" high

Finish	WPS#
Yellow	56-9661
Stainless Steel	56-9662



### XX10

- XX10 304 stainless steel,
- XX10-Y Hardened steel
- 120 db lithium powered alarm
- 3/8" Carbide reinforced double locking pin
- Dimensions 3.3" long x 2.4" high



Finish	WPS#
Yellow	56-9668
Stainless Steel	56-9663



### XX14

- High nickel content 304 stainless steel construction
- 120 db lithium powered alarm
- 5/8" Carbide reinforced double locking pin
- Dimensions 3.3" long x 2.4" high

WPS#
56-9664



### XX15

- High nickel content 304 stainless steel construction
- 120 db lithium powered alarm
- 5/8" Carbide reinforced double locking pin
- Dimensions 4.13" long x 2.3" high

WPS#
56-9659



## REPLACEMENT BATTERIES

### XBP4

- Replacement battery for the XX locks, XZZ6L locks and XN18

Description	WPS#
CR2 Lithium Battery Pack	56-9648



### XX15 ADAPTER

WPS#
56-9674

- Chain adapter for XX15 locks



## XZZ6L SERIES ALARM DISC LOCKS

XZZ6L series locks are designed to work on scooters and full sized motorcycles and measure 2 3/4" long x 2 1/2" long

### XZZ6L-Y

- Easy to use push-down locking,
- 1/4" hardened steel pin
- 120 db lithium powered alarm
- Yellow finish hardened steel body



WPS#
56-9666



### XZZ6L-SS

- Easy to use push-down locking,
- 1/4" hardened steel pin
- 120 db lithium powered alarm
- Hardened steel body, stainless steel finish



WPS#
56-9667



## XSU LOCKS

- XENA XSU locks pair the highest-quality materials with top-notch design for rugged build-quality that stays highly resistant to the elements through years of use.
- Constructed from high-grade stainless and inert gas-hardened steels,
- XSU69- 16mm Chrome Steel U-Bar
- XSU102- 18mm Chrome Steel U-Bar
- XSU310- 18mm Chrome Steel U-Bar



Description	WPS#
XSU-69	56-9691
XSU-102	56-9692
XSU-310	56-9697

- WINDSHIELDS / FAIRINGS
- AUDIO / COMMUNICATION
- SEATS / LUGGAGE
- BARS / MIRRORS / CONTROLS
- EXHAUST
- AIR / FUEL SYSTEMS
- ENGINE
- TRANSMISSION / DRIVELINE
- GASKETS / SEALS
- ELECTRICAL
- LIGHTING
- CABLES
- BRAKES
- OIL FILTERS
- SUSPENSION
- BODY
- WHEELS
- TIRES / TIRE ACC.
- BIKE ACC.
- VICTORY / INDIAN
- COVERS / LOCKS / TIEDOWNS
- CHEMICALS
- TOOLS
- HELMETS
- HELMET ACC.
- EYEWEAR
- APPAREL / RIDER ACC.
- PROMOTIONAL
- REFERENCE
- INDEX

- WINDSHIELDS / FAIRINGS
- AUDIO / COMMUNICATION
- SEATS / LUGGAGE
- BARS / MIRRORS / CONTROLS
- EXHAUST
- AIR / FUEL SYSTEMS
- ENGINE
- TRANSMISSION / DRIVELINE
- GASKETS / SEALS
- ELECTRICAL
- LIGHTING
- CABLES
- BRAKES
- OIL FILTERS
- SUSPENSION
- BODY
- WHEELS
- TIRES / TIRE ACC.
- BIKE ACC.
- VICTORY / INDIAN
- COVERS / LOCKS / TIEDOWNS**
- CHEMICALS
- TOOLS
- HELMETS
- HELMET ACC.
- EYEWEAR
- APPAREL / RIDER ACC.
- PROMOTIONAL
- REFERENCE
- INDEX



## GORILLA 9000 CYCLE ALARM W/REMOTE TRANSMITTER

- Powerful 120 dB siren
- 2-stage shock sensor
- Internal tilt sensor
- Current sensor
- LED warning light
- Waterproof siren and connectors
- Compatible with the optional 2-way paging system
- Includes: ultra-compact siren, 3-button remote transmitter, wiring harness, LED warning light, cable ties, hook&loop tape, and user manual



Description	WPS#
Cycle Alarm with Remote	57-0037
Optional add-on 2-way paging system	57-0039



## GORILLA 9100 CYCLE ALARM WITH 2-WAY PAGING SYSTEM

- Powerful 120 dB siren
- 2-stage shock sensor
- Internal tilt sensor
- Current sensor
- LED warning light
- Waterproof siren and connectors
- 2-way paging system
- Includes: ultra-compact siren, 2-way pager transmitter, 2-way antenna module, 3-button remote transmitter, wiring harness, LED warning light, cable ties, hook&loop tape, and user manual.



Description	WPS#
Cycle alarm with 2-way paging system	57-0038



## STRAP IT-LOCK IT- SECURE IT = PEACE OF MIND

### Protect Valuables from Smash & Grab Theft

Most theft is see it, grab it, run. Prevent opportunistic theft without the burden of cumbersome chains, cables or locks. Lockstraps are well-constructed, using an eight bound steel cable between double nylon webbing, tough rivets and dual combination carabiner locks. Lockstraps also incorporated a soft tie-extension so no scratching occurs. Lockstraps provide piece of mind, security and unsurpassed quality. Best of all, our Lockstraps will not come loose and "pop" off like typical straps with "S" hooks.



### 2 Combination Locking Carabiners "No Hooks"

- Combination locks to secure your stuff easily
- Keep your Lockstraps locked to your truck so that you don't lose them
- Lock both ends of the Lockstrap so that the hooks never come loose or "pop" off
- Don't have to worry about keeping track of keys

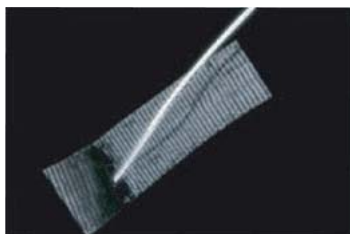

### Full Length Stainless Steel Cable

- Prevent theft
- Adds extra strength and durability
- Peace of mind with heightened security



### Superior Rivets for Super Strength

- Solid industrial strength construction
- 600lb working load capacity 1200lb break strength
- Built to last

### Built in Soft Tie Extensions

- Keeps locks away to prevent scratching
- Perfect for motorcycles, ATV, Water Craft Etc...

Description	WPS#
Locking tiedown	29-0101
24" extension w/carabiner	29-0103
2' Universal cable/lock strap	29-0104

WINDSHIELDS / FAIRINGS

AUDIO / COMMUNICATION

SEATS / LUGGAGE

BARS / MIRRORS / CONTROLS

EXHAUST

AIR / FUEL SYSTEMS

ENGINE

TRANSMISSION / DRIVELINE

GASKETS / SEALS

ELECTRICAL

LIGHTING

CABLES

BRAKES

OIL FILTERS

SUSPENSION

BODY

WHEELS

TIRES / TIRE ACC.

BIKE ACC.

VICTORY / INDIAN

COVERS / LOCKS / TIEDOWNS

CHEMICALS

TOOLS

HELMETS

HELMET ACC.

EYEWEAR

APPAREL / RIDER ACC.

PROMOTIONAL

REFERENCE

INDEX

WINDSHIELDS / FAIRINGS  
 AUDIO / COMMUNICATION  
 SEATS / LUGGAGE  
 BARS / MIRRORS / CONTROLS  
 EXHAUST  
 AIR / FUEL SYSTEMS  
 ENGINE  
 TRANSMISSION / DRIVELINE  
 GASKETS / SEALS  
 ELECTRICAL  
 LIGHTING  
 CABLES  
 BRAKES  
 OIL FILTERS  
 SUSPENSION  
 BODY  
 WHEELS  
 TIRES / TIRE ACC.  
 BIKE ACC.  
 VICTORY / INDIAN  
**COVERS / LOCKS / TIEDOWNS**  
 CHEMICALS  
 TOOLS  
 HELMETS  
 HELMET ACC.  
 EYEWEAR  
 APPAREL / RIDER ACC.  
 PROMOTIONAL  
 REFERENCE  
 INDEX



"Free Logo Printing on ALL 150 pr assorted Powertye tie-downs"

## FAT STRAP RATCHET TIEDOWN WITH LATCH HOOKS

The Fat Strap Ratchet Tie-Down is similar to our 1" Ratchets, but in a wider 1½" configuration. Comes in a standard 6½ ft length with Secure Latch Hooks, which help keep your bike from falling over. Great for those tougher applications where a 1" Ratchet just isn't enough.

- 1½" wide Heavy-Duty Ratchet
- Secure Latch Hooks (vinyl-coated)
- 6,000 lb. test nylon webbing
- Double Security Stitching
- 800 lb. rated assembly
- 6½ ft. length
- Sold in pairs

Color	WPS#
Black	29-1129



**KIT INCLUDES:**  
 4 - 2" 6ft Auto/Axle Strap w/ Secure Twist Hooks & Protective Nylon Sleeve 1 - XL Storage Bag

## 2" X 6' UTV TRAILER KIT

- Super Heavy-Duty 2" Secure-Locking Ratchet with Extra Wide Handle
- Integrated, Adjustable Axle Loop with 12" Protective Nylon Sleeve
- **Heavy-Duty Secure Twist Hooks**
- Durable Extra Security Stitching
- **8,000 lb. Capacity**
- 6ft Length
- 4 Pieces

WPS#
29-3006



**KIT INCLUDES:** 2 Pair 2" BIG DADDY'S Deluxe Ratchet w/ Secure Hooks & Sheepskin Softtye, 1 Tie-Down Storage Bag

## 2" BIG DADDY PREMIUM TRAILER KIT

- 2" wide Heavy-Duty Ratchet w/ Ergonomic Rubber Handle
- Genuine Sheepskin Sleeve
- Black Webbing Soft-Tye sewn-in
- 7,400 lb. test nylon webbing
- Heavy-Duty Secure Hooks (vinyl coated)
- Double Security Stitching
- 2,600 lb. rated assembly
- 6 1/2 ft. length

Color	WPS#
Black	29-3004
Orange	29-3005

## 1 1/2" FAT STRAP TRAILER KIT

- 1 ½" wide Heavy-Duty Ratchet w/ Ergonomic Rubber Handle
- Genuine Sheepskin Sleeve
- Black Soft-Tye sewn-in
- 6,000 lb. test nylon webbing
- Rubber-Coated Latch Hooks (vinyl coated)
- Double Security Stitching
- 1,500 lb. rated assembly
- 6 1/2 ft. length

Color	WPS#
Black	29-3000
Red	29-3001
Blue	29-3002
Orange	29-3003



**KIT INCLUDES:** 2 Pair 1½" FAT STRAP Deluxe Ratchet w/ Latch Hooks & Sheepskin Softtye, 1 Tie-Down Storage Bag



“Free Logo Printing on ALL 150 pr assorted Powertye tie-downs”

### 1½” FAT STRAPS



These heavy duty 1½” tear drop buckles  
 full 1½” wide and 10’ long  
 manufactured using 1000 lb test nylon webbing,  
 double stitched at stress point  
 made in the USA  
 lifetime warranty

Color	WPS#
Black	29-1120
Red	29-1121
Blue	29-1122
Orange	29-1123

### 1½” FAT STRAPS WITH SOFT TIE



Same features as the standard fat straps  
 full 1½” wide x 10’ long  
 lifetime warranty

Color	WPS#
Black	29-1130
Black/Red	29-1131
Black/Blue	29-1132
Black/Orange	29-1133

### WHEEL TIES



Easily adjustable with spring loaded clip  
 strong 1000 lb nylon webbing

Length	WPS#
3’	29-0016
6’	29-0021

## ANGRA

### QUICK DISCONNECT TIEDOWN ANCHOR



1½” dia. stainless steel ring assembles quickly and easily. Detaches from contoured base, leaving no protruding hardware  
 mounts on flat surface  
 1000 lbs straight pull strength and 1000 lbs side pull strength

WPS#
29-1040

- WINDSHIELDS / FAIRINGS
- AUDIO / COMMUNICATION
- SEATS / LUGGAGE
- BARS / MIRRORS / CONTROLS
- EXHAUST
- AIR / FUEL SYSTEMS
- ENGINE
- TRANSMISSION / DRIVELINE
- GASKETS / SEALS
- ELECTRICAL
- LIGHTING
- CABLES
- BRAKES
- OIL FILTERS
- SUSPENSION
- BODY
- WHEELS
- TIRES / TIRE ACC.
- BIKE ACC.
- VICTORY / INDIAN
- COVERS / LOCKS / TIEDOWNS
- CHEMICALS
- TOOLS
- HELMETS
- HELMET ACC.
- EYEWEAR
- APPAREL / RIDER ACC.
- PROMOTIONAL
- REFERENCE
- INDEX

# QUICKLOADER

## QUICK LOADER TIEDOWNS

Quick loader tiedowns are recognized by experienced users as the strongest, most versatile, easiest to use, ratcheting tiedown system available. The last tiedowns you will need



- Automatic recoil
- Longer ratcheting handle
- Longer webbing
- Extended release
- Heavy gauge
- Eat treated galvanized steel



A



B



C



D

Description	WPS#
A Red 1500 lb. 12 ft length	29-0001
B Red 1500 lb. 12 ft length	29-0002
C Red 3000 lb. 15 ft length	29-0003
D Red 4500 lb. 15 ft length	29-0004

# VORTEX<sup>®</sup>

## TIE DOWNS

Heavy duty hook on one end, carabiner clip on the other  
 Trap material features double security stitching with contrasting vortex logos

12" maximum length, 1500 lb capacity, 18" maximum length, 3000 lb capacity

Velcro strap helps keep the loose end of the tie down under control while in use

Ideal for all applications of all kinds



A



B

Description	WPS#
A 1" Tie downs	3-TD111
B 1.5" Tie downs	3-TD122

## SOFT TIES

1.5" wide x 12" long

Double security stitching with contrasting vortex logos

1500 lb capacity

Metal free for ultimate surface protection, ideal for all applications

WPS#
3-TD134



## HANDLEBAR CUFF

Easy to install clips right over handlebars  
 Sturdy, welded metal D-rings provides safe and strong application points for tie downs

1500 lb capacity

Ideal for solid mount handlebars up to 1.5" wide and sportbikes of all kinds

WPS#
3-TD108



- WINDSHIELDS / FAIRINGS
- AUDIO / COMMUNICATION
- SEATS / LUGGAGE
- BAR / MIRRORS / CONTROLS
- EXHAUST
- AIR / FUEL SYSTEMS
- ENGINE
- TRANSMISSION / DRIVELINE
- GASKETS / SEALS
- ELECTRICAL
- LIGHTING
- CABLES
- BRAKES
- OIL FILTERS
- SUSPENSION
- BODY
- WHEELS
- TIRES / TIRE ACC.
- BIKE ACC.
- VICTORY / INDIAN
- COVERS / LOCKS / TIEDOWNS
- CHEMICALS
- TOOLS
- HELMETS
- HELMET ACC.
- EYEWEAR
- APPAREL / RIDER ACC.
- PROMOTIONAL
- REFERENCE
- INDEX



### ULTRA TIEDOWN

patent pending ending heavy-duty carabiner hooks  
 longer 1" x 1.5" aircraft quality nylon straps with 1500 lbs straight tension strength  
 limited lifetime warranty against manufacture defects  
 two popular styles to choose from heavy duty non-slip cam-lock or ratcheting type buckles



Color	WPS#
<b>CAM-LOCK</b>	
Black	29-2043
Blue	29-2044
Red	29-2045
<b>RATCHET</b>	
Black	29-2046
Blue	29-2047
Red	29-2048

### HANDLEBAR HARNESS

Innovative patented design allows for tying both to the front and rear for additional safety and stability  
 Grip webbing will not damage grips or controls  
 padded adjustable center strap allows for use on handlebars 1" to 2" wide



Color	WPS#
Black	29-2055
Blue	29-2056
Red	29-2057

- WINDSHIELDS / FAIRINGS
- AUDIO / COMMUNICATION
- SEATS / LUGGAGE
- BARS / MIRRORS / CONTROLS
- EXHAUST
- AIR / FUEL SYSTEMS
- ENGINE
- TRANSMISSION / DRIVELINE
- GASKETS / SEALS
- ELECTRICAL
- LIGHTING
- CABLES
- BRAKES
- OIL FILTERS
- SUSPENSION
- BODY
- WHEELS
- TIRES / TIRE ACC.
- BIKE ACC.
- VICTORY / INDIAN
- COVERS / LOCKS / TIEDOWNS**
- CHEMICALS
- TOOLS
- HELMETS
- HELMET ACC.
- EYEWEAR
- APPAREL / RIDER ACC.
- PROMOTIONAL
- REFERENCE
- INDEX



## ORIGINAL BAR - HARNESS

eliminates the use of hooks on the motorcycle while transporting  
made from 1/2" and 3/4" lb test nylon webbing

slip nylon cuffs over grips, tug on cross straps and hook into loops  
Cross straps are covered with a sleeve of soft polar fleece to protect the tank from chafing

The patented Bar harness is the safest way to tie down motorcycles securely without using hooks directly on the bike

short fits bars up to 12" wide, standard up to 16" wide and wide up to 20" wide



Not for use on high rise or rubber mounted bars

Size	Fits	Black	Blue	Red
Short	up to 28" wide	<b>28-2037S</b>	<b>28-2039S</b>	<b>28-2038S</b>
Standard	up to 32" wide	<b>28-2037</b>	<b>28-2039</b>	<b>28-2038</b>
X-Wide	up to 34" wide	<b>28-2037W</b>	<b>28-2039W</b>	<b>28-2038W</b>

## BAR - HARNESS II

polycarbonate cups eliminate possible damage to grips  
The cups hold the cross straps out further to better clear a wider variety of fairings

short fits bars up to 12" wide, standard up to 16" wide, X-wide up to 20" wide and XX-wide up to 24" wide

Size	Fits	Black
Short	up to 28 wide	<b>28-2030S</b>
Standard	up to 32 wide	<b>28-2030</b>
X-Wide	up to 36 wide	<b>28-2030X</b>
XX-Wide	up to 40 wide	<b>28-2030XX</b>



## 1" TIEDOWN ASSIST

Use with tiedowns on machines without regular hook access  
loop around frames, handlebars, etc., to avoid hook damage  
long, 1/2" lb test nylon

Color	WPS#	Color	WPS#
<b>1" WIDE</b>		<b>1.5" WIDE</b>	
Black	<b>29-1067</b>	Black	<b>29-1076</b>
Blue	<b>29-1068</b>	Blue	<b>29-1077</b>
Orange	<b>29-1071</b>	Orange	<b>29-1079</b>
Red	<b>29-1070</b>	Red	<b>29-1078</b>



## 1 1/2" TIEDOWN ASSIST WITH SHEEPSKIN COVER

1/2" lb test nylon, 18" long

Sheepskin cover protects against damage  
Black, sold in pairs

Color	WPS#
Black	<b>29-1075</b>



- WINDSHIELDS / FAIRINGS
- AUDIO / COMMUNICATION
- SEATS / LUGGAGE
- BAR / MIRRORS / CONTROLS
- EXHAUST
- AIR / FUEL SYSTEMS
- ENGINE
- TRANSMISSION / DRIVELINE
- GASKETS / SEALS
- ELECTRICAL
- LIGHTING
- CABLES
- BRAKES
- OIL FILTERS
- SUSPENSION
- BODY
- WHEELS
- TIRES / TIRE ACC.
- BIKE ACC.
- VICTORY / INDIAN
- COVERS / LOCKS / TIEDOWNS
- CHEMICALS
- TOOLS
- HELMETS
- HELMET ACC.
- EYEWEAR
- APPAREL / RIDER ACC.
- PROMOTIONAL
- REFERENCE
- INDEX



**UTILITY TRAILER** **NEW**

The K&L Universal Transportation/Utility Trailer is the perfect solution for transporting motorcycles, ATV's, wide UTV's, Golf Carts and more. The unique air bag system raises and lowers the trailer bed to prevent vehicles from high centering.

- Stand & roll design for easy storage
- Automatic lifting deck for loading & unloading
- Built in air compressor for trailer height adjustment and tire inflation
- Adjustable/removable wheel chocks
- Transport up to 3 motorcycles, 2 ATV's or 1 UTV
- Wide base to fit the largest UTV's and golf carts
- Deck dimensions: 103" long x 69" wide
- 2,500 lb capacity

Shipped direct from K & L warehouse in California, **NOT INCLUDED IN OUR FREE FREIGHT PROGRAM**

Description	WPS#
Utility trailer	135-5590



- WINDSHIELDS / FAIRINGS
- AUDIO / COMMUNICATION
- SEATS / LUGGAGE
- BARS / MIRRORS / CONTROLS
- EXHAUST
- AIR / FUEL SYSTEMS
- ENGINE
- TRANSMISSION / DRIVELINE
- GASKETS / SEALS
- ELECTRICAL
- LIGHTING
- CABLES
- BRAKES
- OIL FILTERS
- SUSPENSION
- BODY
- WHEELS
- TIRES / TIRE ACC.
- BIKE ACC.
- VICTORY / INDIAN
- COVERS / LOCKS / TIEDOWNS**
- CHEMICALS
- TOOLS
- HELMETS
- HELMET ACC.
- EYEWEAR
- APPAREL / RIDER ACC.
- PROMOTIONAL
- REFERENCE
- INDEX

# DeadBolt™ TOW AND STOW KITS



Our new TOW & STOW Anti-theft Lock Kit is an all-in-one towing solution. Imagine using one key to lock your hitch and trailer when towing and storing. Security and convenience in one package. Plus, it's a great value. Two models to choose from. Made in USA.



### Model 57-9681 for 1-7/8" & 2" couplers includes:

- TCL1-AS BLOCKHEAD Trailer Coupler Lock for unattended trailers; Fits 1-7/8" & 2" flat lip couplers (3-3/4" max width)
- RC1 Adjustable Trailer Coupler Latch Lock. Adjusts from 1/2" to 2-1/2" opening
- RH3 Receiver Hitch Lock. 5/8" diameter. Fits all Class III and IV hitches
- Two keys

Description	WPS#
Tow & Stow Kit 1-7/8" and 2"	57-9681



### Model 57-9862 for 2" & 2-5/16" couplers includes:

- TCL3-AS BLOCKHEAD Trailer Coupler Lock for unattended trailers; Fits 2" & 2-5/16" flat lip couplers (4-1/2" max width)
- RC1 Adjustable Trailer Coupler Latch Lock. Adjusts from 1/2" to 2-1/2" opening
- RH3 Receiver Hitch Lock. 5/8" diameter. Fits all Class III and IV hitches
- Two Keys

Description	WPS#
Tow & Stow Kit 2" and 2-5/16"	57-9682

WINDSHIELDS / FAIRINGS

AUDIO / COMMUNICATION

SEATS / LUGGAGE

BARS / MIRRORS / CONTROLS

EXHAUST

AIR / FUEL SYSTEMS

ENGINE

TRANSMISSION / DRIVELINE

GASKETS / SEALS

ELECTRICAL

LIGHTING

CABLES

BRAKES

OIL FILTERS

SUSPENSION

BODY

WHEELS

TIRES / TIRE ACC.

BIKE ACC.

VICTORY / INDIAN

COVERS / LOCKS / TIEDOWNS

CHEMICALS

TOOLS

HELMETS

HELMET ACC.

EYEWEAR

APPAREL / RIDER ACC.

PROMOTIONAL

REFERENCE

INDEX



## PIT STOP WHEEL CHOCK

Make your life easier with the Pit Stop/Trailer Stop. Just place it in your garage, and ride your bike right into it - no kickstand required. Now the bike takes up less room in your garage because it sits upright, and you can check the fluids, service it, or use it outside to wash and detail your ride.

When the time comes to trailer your motorcycle, the Pit Stop/Trailer Stop simply snaps into the Trailer Adaptor Kit (290-01002) that mounts to the floor of your trailer, and you're ready to secure your motorcycle for safe transporting. The chock will hold your motorcycle so securely, only one person is needed to load and unload any bike, and only two tie-down straps are required. And you won't damage your sensitive suspension parts because you never need to overtighten your straps. If you are transporting your bike in the back of a pick-up truck, you don't even need our adaptor kit. Just place the chock up against the front of the bed, and simply tie the bike from its mid-point towards the front of the truck bed, and you're good to go.

If your trailer is equipped with E-Track, use the Universal E-Track Adaptor Kit (290-01004) to mount the chock to, which allows you to place your bike anywhere you like along the track, fore and aft, or side to side.

The patented adjustable cradle fits ALL bikes from dirt bikes and sportbikes, to cruisers and heavy touring bikes, and anything in between, up to 3,000 lbs. It will work on front and rear tires from 14" to 22" and 80mm to 230mm. The Pit Stop is also perfect for racers and track day riders, since you can haul your bike to the track in the chock, and then take the Pit Stop out of the trailer and use it as a track stand.

The Scooter Pit Stop/Trailer Stop works with scooters and smaller motorcycles with wheel diameters ranging from 8" to 16" and tire widths from 80mm to 120mm.

The CONDOR® Pit-Stop/Trailer-Stop is made of light weight aluminum, weighing only 30 lbs., and folds down for easy storage.

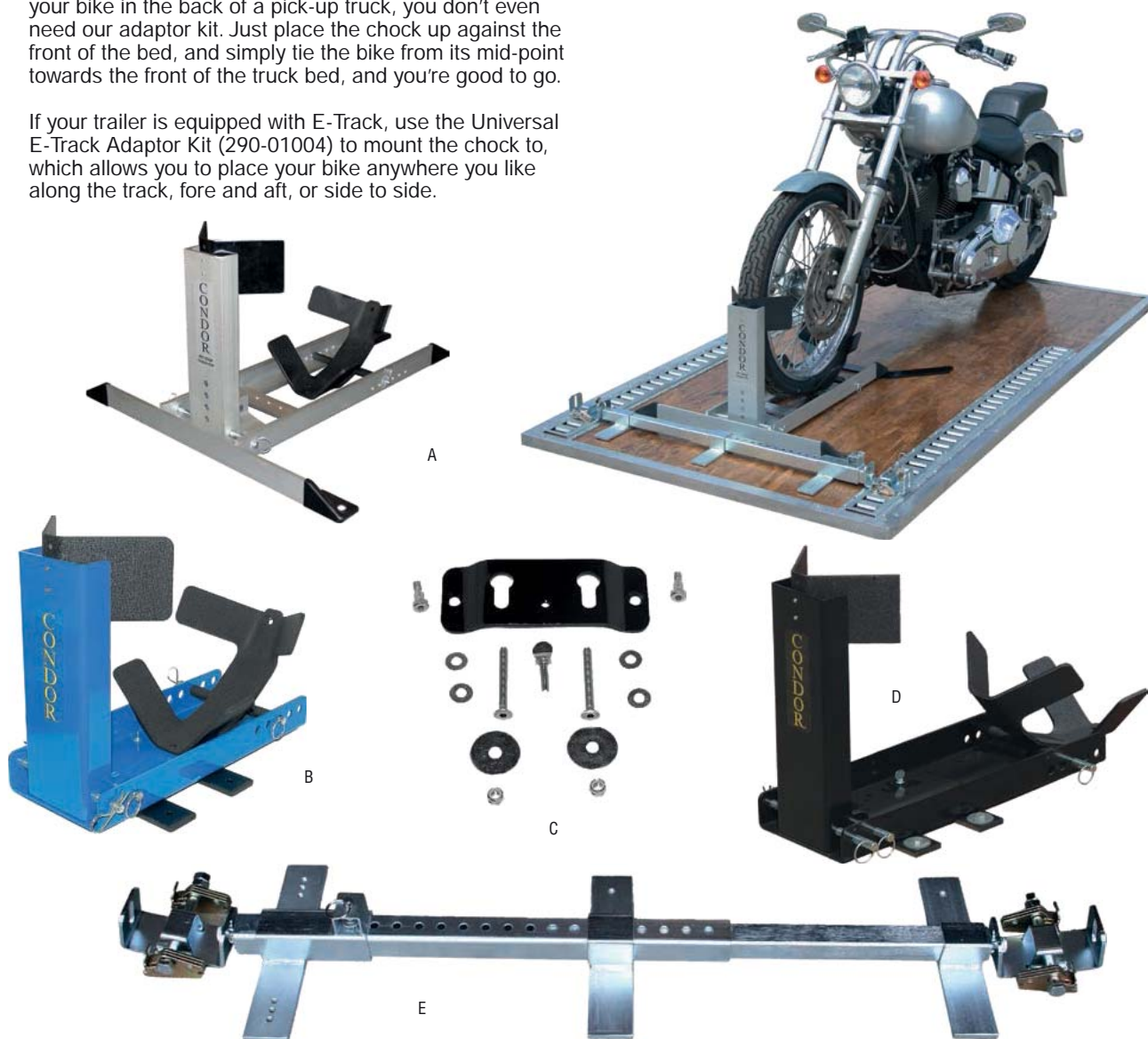

Description	WPS#
A Condor Pit Stop / Trailer Stop	290-01001
B Condor Pit Stop / Trailer Stop for Scooter/Moped/small Sportbike	290-01005
C Condor Trailer Adaptor Kit for Pit Stop	290-01002
D Condor Trailer only Model with Mount Kit	290-01003
E Condor Universal E-Track Adaptor	290-01004



## WHEEL CHOCKS

- Make your flatbed trailer into a motorcycle or ATV hauler
- Made of heavy duty chromed steel
- Easy to mount

Description	WPS#
A 12½" ATV	52-2620*
B 3½"	52-2621
C 5½"	52-2622
<b>REPLACEMENT HARDWARE</b>	
D Kit	52-2625

\* Requires 2 for holding ATV

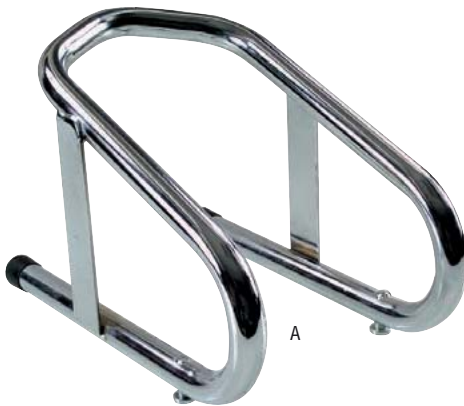

A



B



C



D

## ANCRA

- Designed to fit front tires 3.5" to 5.5" wide
- Features Ancra's patented lock n' load system using high strength aircraft style track for positive attachment to standard truck beds and flat floor trailers
- Manufactured from reinforced and powder coated tubular steel, with a solid base plate and aircraft style fasteners for superior strength and durability
- Installs quickly and easily

Description	WPS#
Wheel Chock	52-2630



- WINDSHIELDS / FAIRINGS
- AUDIO / COMMUNICATION
- SEATS / LUGGAGE
- BARS / MIRRORS / CONTROLS
- EXHAUST
- AIR / FUEL SYSTEMS
- ENGINE
- TRANSMISSION / DRIVELINE
- GASKETS / SEALS
- ELECTRICAL
- LIGHTING
- CABLES
- BRAKES
- OIL FILTERS
- SUSPENSION
- BODY
- WHEELS
- TIRES / TIRE ACC.
- BIKE ACC.
- VICTORY / INDIAN
- COVERS / LOCKS / TIEDOWNS
- CHEMICALS
- TOOLS
- HELMETS
- HELMET ACC.
- EYEWEAR
- APPAREL / RIDER ACC.
- PROMOTIONAL
- REFERENCE
- INDEX



### 3 FT. AERO TRACK KIT

AERO-TRACK is the all new anchoring system from Powertye. It offers a clean, finished look that works great in trailers and truck beds.

- Great for both trailers and truck beds
- Curved profile for easy roll-over
- High-Strength Aluminum Construction
- Sleek, finished look

**Pack includes:**

- 2 X 3ft Aero-Tracks
- 2 X Aero-Track Standard Connectors
- Mounting Hardware (8 pcs - 1" Screw & Nut)

Description	WPS#
3ft. Aero Track Kit	29-3081



### 5 FT. AERO TRACK KIT

This special Heavy Duty Pack comes with TWO 5ft Aero-Tracks, FOUR Aero-Track Heavy Duty Connector Rings and Mounting Hardware.

- Pack includes:
- 2 X 5ft Aero-Tracks
- 4 X Aero-Track Heavy Duty Connectors
- Mounting Hardware (14 pcs - 1 1/4" x 1/4" Metal Bolt + Nut)

Description	WPS#
5 ft. Aero track kit	29-3080



Standard

h-D

### AERO CONNECTORS

- Quick-Release system with Extra-Wide Thumb Grips for easy one-handed mounting
- \*Compatible with all Aero-Track mounting points
- \*1 1/4" Diameter O-Ring
- \*500 lb. Load Rating
- H-D Aero Connectors
- \*Extra-wide release lever for easy adjustment
- \*Compatible with 3ft and 5ft Aero-Track mounting points
- \*1 1/2" Diameter O-Ring
- \*1,000 lb. Load Rating

Description	WPS#
Standard Connectors (4pc.)	29-3083
H-D Connectors (4pc.)	29-3082

- WINDSHIELDS / FAIRINGS
- AUDIO / COMMUNICATION
- SEATS / LUGGAGE
- BARs / MIRRORS / CONTROLS
- EXHAUST
- AIR / FUEL SYSTEMS
- ENGINE
- TRANSMISSION / DRIVELINE
- GASKETS / SEALS
- ELECTRICAL
- LIGHTING
- CABLES
- BRAKES
- OIL FILTERS
- SUSPENSION
- BODY
- WHEELS
- TIRES / TIRE ACC.
- BIKE ACC.
- VICTORY / INDIAN
- COVERS / LOCKS / TIEDOWNS**
- CHEMICALS
- TOOLS
- HELMETS
- HELMET ACC.
- EYEWEAR
- APPAREL / RIDER ACC.
- PROMOTIONAL
- REFERENCE
- INDEX



## E-TRACK KITS

**E-Track** is a heavy-duty modular anchoring system, great for anchoring larger loads like motorcycles and other vehicles.

- Made of High-Strength 12-Gauge Steel
- Silver Zinc-Plated
- Compatible with all E-Track Fittings
- Great for personal or commercial trailers
- 5" wide

This **E-Track Plate** is a great addition for any existing E-Track setup. Offers 2 extra E-Track mounting points wherever you need them!

- Fits Standard and Heavy Duty E-Track Clips
- Sloped Edges for Easy Rollover
- High-Strength Steel Construction

**Kit Includes:**

- 1 x E-Track Floor Plate
- 1 x Optional Rubber Spacer
- 4 x Carriage Bolts, 2" x 3/8"
- 4 x Large Washers, 2 1/2" wide

Our **E-Track Clips w/D-Rings** are perfect for securing everyday cargo into the E-Track system

- 3,000 lbs. Heavy Duty Rating
- Compatible with all E-Track mounting points
- Quick release mechanism allows for easy adjustment

Our **E-Track Heavy Duty O-Ring** is perfect for securing heavier cargo into the E-Track system.

- 6,000 lbs. Heavy Duty Rating
- Compatible with all E-Track mounting points
- Quick release mechanism allows for easy adjustment
- 1 1/2" Diameter O-Ring

**E-Track Rubber End Caps** protect your E-Track ends in style. Fits all Horizontal-style E-Tracks

- Made of durable, high-impact rubber
- Fits Horizontal E-Tracks
- Prevents things getting caught underneath track ends
- Gives your E-Track a clean, professional look

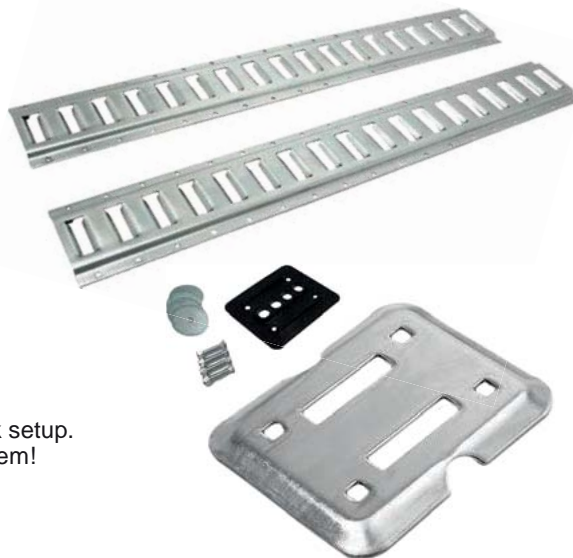

Description	WPS#
58" E-Track pr.	29-3051
36" E-Track pr.	29-3050
Floor Plate ea.	29-3054
D-Ring clips 4pack	29-3052
O-Ring clips 4 pack	29-3053
Rubber end caps pr.	29-3055

- WINDSHIELDS / FAIRINGS
- AUDIO / COMMUNICATION
- SEATS / LUGGAGE
- BAR / MIRRORS / CONTROLS
- EXHAUST
- AIR / FUEL SYSTEMS
- ENGINE
- TRANSMISSION / DRIVELINE
- GASKETS / SEALS
- ELECTRICAL
- LIGHTING
- CABLES
- BRAKES
- OIL FILTERS
- SUSPENSION
- BODY
- WHEELS
- TIRES / TIRE ACC.
- BIKE ACC.
- VICTORY / INDIAN
- COVERS / LOCKS / TIEDOWNS
- CHEMICALS
- TOOLS
- HELMETS
- HELMET ACC.
- EYEWEAR
- APPAREL / RIDER ACC.
- PROMOTIONAL
- REFERENCE
- INDEX

## CARGO NETS



### STANDARD

- Secure gas cans, helmets, packages or any shaped item to your motorcycle, snowmobile or ATV
- Six vinyl coated hooks

15" x 15" Unstretched  
30" x 30" Stretched



Size	Color	WPS#
15x15	Black	28-2000
15x15	Red	28-2001
15x15	Blue	28-2002
15x15	Orange	28-2003

### ADJUSTABLE

- 6 Removable plastic hooks
- To tighten, pull inner cord over additional hook

15" x 15" Unstretched  
36" x 36" Stretched

Size	Color	WPS#
15X15	Black	28-2025
15X15	Red	28-2026
15X15	Blue	28-2027
15X30	Black	28-2028



WINDSHIELDS / FAIRINGS  
AUDIO / COMMUNICATION  
SEATS / LUGGAGE  
BARS / MIRRORS / CONTROLS  
EXHAUST  
AIR / FUEL SYSTEMS  
ENGINE  
TRANSMISSION / DRIVELINE  
GASKETS / SEALS  
ELECTRICAL  
LIGHTING  
CABLES  
BRAKES  
OIL FILTERS  
SUSPENSION  
BODY  
WHEELS  
TIRES / TIRE ACC.  
BIKE ACC.  
VICTORY / INDIAN  
COVERS / LOCKS / TIEDOWNS  
CHEMICALS  
TOOLS  
HELMETS  
HELMET ACC.  
EYEWEAR  
APPAREL / RIDER ACC.  
PROMOTIONAL  
REFERENCE  
INDEX

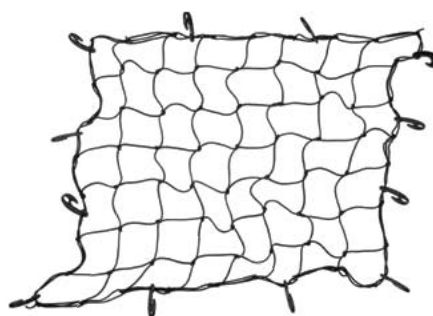

28" x 30" unstretched  
60" x 72" stretched

Color	WPS#
Black	28-2012

### BED NETS

- Vinyl coated hooks to protect surfaces
- Perfect for light duty loads
- No more lost items on the highway
- Secure loose cargo and various items
- Can be used on pick-ups, in vans, and will secure loads on motorcycles, watercraft and snowmobile trailers



Sold in packs of 10 — Order of 1 = 10 cords

### BUNGEE CORDS

- Ideal for securing luggage and equipment to your machine
- Made of strong top quality rubber, covered with double braided woven fibranne thread to withstand the most severe use
- Plastic coated steel hooks eliminate scratching

Description	Cord	WPS#
18"	8mm	29-1026
18"	10mm	29-1035
24"	8mm	29-1027
24"	10mm	29-1037
24" 4-hook	10mm	29-1036
32"	10mm	29-1038

### ADJUSTABLE STEELCORE™

- Polyethylene coated steel I-beam hook
- 2 adjustable lengths to fit any need
- 9.5mm diameter premium quality rubber cord
- Sold each



Length	WPS#
6" to 24"	57-7565
6" to 40"	57-7566

### TWIN WIRE

- Design offers twice the hook strength of comparable cords
- Rounded hook end eliminates risk of scratching
- 9.5mm diameter premium quality rubber cord
- Sold in pairs

Length	WPS#
18"	57-7560
24"	57-7561
32"	57-7562
40"	57-7563





## ENGINE OIL

- Made from severely hydrocracked base oils for the ultimate in purity
- Blended specifically for air cooled V-twin engines
- Superior film strength resists break down and increases service life
- Meets or exceeds all Harley Davidson warranty criteria
- Meets or exceeds API CI-4/SL service rating
- Sold in quarts (12 per case), gallons (6 per case) and 55 gallon drums

Description	WPS #		
20W50	1 qt	12/case	<b>822-1001</b>
	1 gal	6/case	<b>822-1002</b>
	drum	55 gal	<b>822-1003</b>
Oil Drum Pump			<b>27-0190</b>



WPS PAYS 1/2 FREIGHT ON DRUMS OF OIL

## SINGLE WEIGHT ENGINE OIL

- Recommended for pre-Evolution V-twin motorcycles
- Meets or exceeds Harley Davidson warranty criteria
- Made from severely hydrocracked base oils for the ultimate in purity
- Superior film strength resists break down and increases service life
- Meets or exceeds API CI-4/SL service rating
- Sold in quarts (12 per case)

Description	WPS #		
50 wt	1 qt	12/case	<b>822-1011</b>
60 wt	1 qt	12/case	<b>822-1021</b>



## FULL SYNTHETIC ENGINE OIL

- Produced using ultra high grade fully synthetic base oil
- Stable base oil molecules minimize oxidation and pre-mature breakdown
- Engineered specifically as a "multi-fill" lubricant for Harley Davidson engines, transmissions and primaries
- Excellent protection against engine wear and sludge buildup
- Meets or exceeds all Harley Davidson warranty criteria
- Meets or exceeds API CI-4/SL service rating
- Sold in quarts (12 per case) and gallons (6 per case)

Description	WPS #		
20W50 Full Syn.	1 qt	12/case	<b>822-1041</b>
	1 gal	6/case	<b>822-1042</b>



WINDSHIELDS / FAIRINGS  
AUDIO / COMMUNICATION  
SEATS / LUGGAGE  
BARS / MIRRORS / CONTROLS  
EXHAUST  
AIR / FUEL SYSTEMS  
ENGINE  
TRANSMISSION / DRIVELINE  
GASKETS / SEALS  
ELECTRICAL  
LIGHTING  
CABLES  
BRAKES  
OIL FILTERS  
SUSPENSION  
BODY  
WHEELS  
TIRES / TIRE ACC.  
BIKE ACC.  
VICTORY / INDIAN  
COVERS / LOCKS / TIEDOWNS  
CHEMICALS  
TOOLS  
HELMETS  
HELMET ACC.  
EYEWEAR  
APPAREL / RIDER ACC.  
PROMOTIONAL  
REFERENCE  
INDEX



Description			WPS #
85W140	1 qt	12/case	822-1051
80W90	1 qt	12/case	822-1052

### TRANSMISSION OIL

- Developed for use in 4, 5 and 6 Speed Harley Davidson transmissions
- Blended for ultra high film strength offering excellent wear protection and durability
- HardDrive's extreme pressure additive package provides smooth shifting across all RPM ranges
- Meets or exceeds API GL-5 classifications
- Sold in quarts (12 per case)



Description			WPS #
Primary Oil	1 qt	12/case	822-1053

### BIG TWIN PRIMARY OIL

- Developed for use in all '84 and newer Big Twin Harley Davidson motorcycles equipped with a wet type diaphragm spring clutch
- Blended with extreme pressure additives for outstanding film strength, wear protection and durability
- Specifically formulated for high performance primaries
- Sold in quarts (12 per case)



Description			WPS #
Gear & Chaincase Oil	1 qt	12/case	822-1054

### SPORTSTER GEAR/CHAINCASE OIL

- Developed for use in '71 and newer XR and XL models where transmission and primary chain case share a common lubricant
- Blended with extreme pressure additives for smooth shifting throughout the RPM range
- Specifically blended for high performance gear boxes
- Meets or exceeds API GL-5 classification
- Sold in quarts (12 per case)



Description			WPS #
5 wt (repl. Type B)	1 qt	12/case	822-1061
20 wt (repl. Type E)	1 qt	12/case	822-1064

### FORK OIL

- Developed for use in both OEM and aftermarket fork assemblies
- Designed for use in hot or cold climates
- Formulated for consistent damping action and to resist fading or surging
- Meets or exceeds API GL-5 classifications
- Sold in quarts (12 per case)

- WINDSHIELDS / FAIRINGS
- AUDIO / COMMUNICATION
- SEATS / LUGGAGE
- BAR / MIRRORS / CONTROLS
- EXHAUST
- AIR / FUEL SYSTEMS
- ENGINE
- TRANSMISSION / DRIVELINE
- GASKETS / SEALS
- ELECTRICAL
- LIGHTING
- CABLES
- BRAKES
- OIL FILTERS
- SUSPENSION
- BODY
- WHEELS
- TIRES / TIRE ACC.
- BIKE ACC.
- VICTORY / INDIAN
- COVERS / LOCKS / TIEDOWNS
- CHEMICALS**
- TOOLS
- HELMETS
- HELMET ACC.
- EYEWEAR
- APPAREL / RIDER ACC.
- PROMOTIONAL
- REFERENCE
- INDEX



## 4-CYCLE LUBRICATION

### EXS FULL SYNTHETIC ESTER 4T ENGINE OIL

- Synthetic ester infused with Extreme Pressure (anti-wear additives)
- Lowers engine temperatures and increases horsepower
- Longest change intervals
- For air-cooled / liquid-cooled 4T engines with wet clutches

Description	WPS#		
5W40 1 lt 12/case	840-1623		
5W40 4 lt 4/case	840-1624		
10W40 1 lt 12/case	840-1621		
10W40 4 lt 4/case	840-1622		
10W50 1 lt 12/case	840-1626		
10W50 4 lt 4/case	840-1627		
15W50 1 lt 12/case	840-1628		
15W50 4 lt 4/case	840-1629		



### EXP SYNTHETIC ESTER BLEND 4T ENGINE OIL

- Synthetic blend infused with Extreme Pressure (anti-wear additives)
- Lowers engine temperatures and increases horsepower
- Extended change intervals
- For air-cooled / liquid-cooled 4T engines with wet clutches

Description	WPS#		
10W30 1 lt 12/case	840-1610		
10W30 4 lt 4/case	840-1611		
10W40 1 lt 12/case	840-1612		
10W40 4 lt 4/case	840-1613		
10W40 55 gal	840-1620		
15W50 1 lt 12/case	840-1614		
15W50 4 lt 4/case	840-1615		
20W50 1 lt 12/case	840-1616		
20W50 4 lt 4/case	840-1617		



### EXL MINERAL 4T ENGINE OIL

- Petroleum-based formula infused with Extreme Pressure (anti-wear additives)
- Reduces oil consumption
- Long change intervals
- For air-cooled / liquid-cooled 4T engines with wet clutches

Description	WPS#		
10W40 1 lt 12/case	840-1472		
10W40 4 lt 4/case	840-1473		
10W40 55 gal	840-1474		
20W50 1 lt 12/case	840-1492		
20W50 4 lt 4/case	840-1493		
20W50 55 gal	840-1494		
Oil Drum Pump	27-0190		



**WPS PAYS 1/2 FREIGHT ON DRUMS OF OIL**

### SHOP OIL

- Petroleum-based formula
- Reduces oil consumption
- Long change intervals
- For air-cooled / liquid cooled 4T engines with wet clutches

Description	WPS#	
10W-40 55 gal	840-0020	
20W-50 55 gal	840-0021	
20W-50 V-Twin 55 gal	840-0022	
Oil Drum Pump	27-0190	



**WPS PAYS 1/2 FREIGHT ON DRUMS OF OIL**

WINDSHIELDS / FAIRINGS  
AUDIO / COMMUNICATION  
SEATS / LUGGAGE  
BARS / MIRRORS / CONTROLS  
EXHAUST  
AIR / FUEL SYSTEMS  
ENGINE  
TRANSMISSION / DRIVELINE  
GASKETS / SEALS  
ELECTRICAL  
LIGHTING  
CABLES  
BRAKES  
OIL FILTERS  
SUSPENSION  
BODY  
WHEELS  
TIRES / TIRE ACC.  
BIKE ACC.  
VICTORY / INDIAN  
COVERS / LOCKS / TIEDOWNS  
CHEMICALS  
TOOLS  
HELMETS  
HELMET ACC.  
EYEWEAR  
APPAREL / RIDER ACC.  
PROMOTIONAL  
REFERENCE  
INDEX





## BIG TWIN AND V-TWIN LUBRICATION



Description	WPS#
10W-50 1 lt 12/case	<b>840-1480</b>
10W-50 4 lt 4/case	<b>840-14804</b>



Description	WPS#
20W-50 1 lt 12/case	<b>840-1481</b>
20W-50 4 lt 4/case	<b>840-14814</b>



Description	WPS#
20W-50 1 lt 12/case	<b>840-1482</b>
20W-50 4 lt 4/case	<b>840-14824</b>



Description	WPS#
1 lt 12/case	<b>840-1483</b>



Description	WPS #
1 lt 12/case	<b>840-1478</b>



Description	WPS #
1 lt 12/case	<b>840-1479</b>

### V-TWIN SYNTHETIC ENGINE OIL

- Synthetic ester infused with Extreme Pressure (anti-wear additive) for large displacement V-Twin engines
- Lowers engine temperatures and increases horsepower
- Longest change intervals
- For V-Twin, air-cooled / liquid-cooled 4-stroke engines

### V-TWIN SEMI-SYNTHETIC ENGINE OIL

- Synthetic blend infused with Extreme Pressure (anti-wear additives) for large displacement, V-Twin engines
- Lowers engine temperatures and increases horsepower
- Extended change intervals
- For V-Twin, air-cooled / liquid-cooled 4-stroke engines

### V-TWIN MINERAL ENGINE OIL

- Petroleum-based formula infused with Extreme Pressure (anti-wear additives) for large displacement, V-Twin engines
- Reduces oil consumption
- Long change intervals
- For V-Twin, air-cooled / liquid-cooled 4T engines

### BIG TWIN TRANSMISSION OIL

- Formulated for motorcycles with separate transmissions and or final drives
- Wear protection extends gear life
- Quiets gear whine and improves shifting
- For Big Twin, air cooled / liquid cooled transmissions and final drives

### SPORT TRANSMISSION FLUID

- Formulated for the transmission and primary of Sportster® motorcycles
- Wear protection extends transmission life
- Prevents clutch slipping and chatter for consistent engagement
- Distinctive red color for leak detection
- For Sportster® transmissions

### PRIMARY CHAINCASE LUBRICANT

- Formulated for primary chains and wet clutches
- Wear protection extends primary chain life
- Prevents clutch slipping and chatter for consistent engagement
- Distinctive red color for leak detection
- For Big Twin, air-cooled / liquid-cooled primary chaincases

- WINDSHIELDS / FAIRINGS
- AUDIO / COMMUNICATION
- SEATS / LUGGAGE
- BAR / MIRRORS / CONTROLS
- EXHAUST
- AIR / FUEL SYSTEMS
- ENGINE
- TRANSMISSION / DRIVELINE
- GASKETS / SEALS
- ELECTRICAL
- LIGHTING
- CABLES
- BRAKES
- OIL FILTERS
- SUSPENSION
- BODY
- WHEELS
- TIRES / TIRE ACC.
- BIKE ACC.
- VICTORY / INDIAN
- COVERS / LOCKS / TIEDOWNS
- CHEMICALS**
- TOOLS
- HELMETS
- HELMET ACC.
- EYEWEAR
- APPAREL / RIDER ACC.
- PROMOTIONAL
- REFERENCE
- INDEX



## GEAR SAVER TRANSMISSION OIL

- Formulated to protect transmission gears from wear
- Positive clutch engagement for better starts and longer clutch life
- Protects shafts, bearings and gears
- For air-cooled / liquid-cooled 2T / 4T engines with wet clutches

Description			WPS #
75W	1 lt	12/case	840-0406
80W	1 lt	12/case	840-0401
80W	55 gal		840-0402
Oil Drum Pump			27-0190

**WPS PAYS 1/2 FREIGHT ON DRUMS OF OIL**



## THUMPER GEAR SAVER TRANSMISSION OIL

- Formulated for motorcycle racing transmissions
- Maximum clutch performance and smooth shifting
- Wear protection extends clutch life
- For air-cooled / liquid-cooled, 4T engines with wet clutches

Description			WPS #
80W-85	1 lt	12/case	840-0411



## GEAR SAVER HYPOID GEAR OIL

- Formulated for separate transmissions and final drive units
- Smoother shifting and reduced gear whine
- Extreme Pressure additives reduce component wear
- For motorcycles and ATVs (not for wet clutches)

Description			WPS #
<b>FULL SYN</b>			
75w-90	1 lt	12/case	840-0445
75w-140	1 lt	12/case	840-0435
<b>NON SYN</b>			
80w-90	1 lt	12/case	840-0441
85w-140	1 lt	12/case	840-0431



## HIGH PERFORMANCE FORK OIL

- Formulated for front suspension forks
- Reduces fade for smooth operation
- Eliminates stiction and drag, improving fork action
- Anti-wear and anti-foam
- For front forks

Description			WPS #
2.5W	1 lt	12/case	840-1010
5W	1 lt	12/case	840-1011
7W	1 lt	12/case	840-1016
10W	1 lt	12/case	840-1021
15W	1 lt	12/case	840-1031
20W	1 lt	12/case	840-1041
30W	1 lt	12/case	840-1051



## HV-1 RACING SUSPENSION FLUID

- Formulated for rear shock absorbers
- Consistent dampening at elevated temperatures
- Extreme Pressure additives reduce component wear
- For rear shocks

Description			WPS #
3W	1 lt	12/case	840-3201
5W	1 lt	12/case	840-3206
10W	1 lt	12/case	840-3211
15W	1 lt	12/case	840-3216



- WINDSHIELDS / FAIRINGS
- AUDIO / COMMUNICATION
- SEATS / LUGGAGE
- BAR / MIRRORS / CONTROLS
- EXHAUST
- AIR / FUEL SYSTEMS
- ENGINE
- TRANSMISSION / DRIVELINE
- GASKETS / SEALS
- ELECTRICAL
- LIGHTING
- CABLES
- BRAKES
- OIL FILTERS
- SUSPENSION
- BODY
- WHEELS
- TIRES / TIRE ACC.
- BIKE ACC.
- VICTORY / INDIAN
- COVERS / LOCKS / TIEDOWNS
- CHEMICALS
- TOOLS
- HELMETS
- HELMET ACC.
- EYEWEAR
- APPAREL / RIDER ACC.
- PROMOTIONAL
- REFERENCE
- INDEX



WINDSHIELDS / FAIRINGS  
 AUDIO / COMMUNICATION  
 SEATS / LUGGAGE  
 BARS / MIRRORS / CONTROLS  
 EXHAUST  
 AIR / FUEL SYSTEMS  
 ENGINE  
 TRANSMISSION / DRIVELINE  
 GASKETS / SEALS  
 ELECTRICAL  
 LIGHTING  
 CABLES  
 BRAKES  
 OIL FILTERS  
 SUSPENSION  
 BODY  
 WHEELS  
 TIRES / TIRE ACC.  
 BIKE ACC.  
 VICTORY / INDIAN  
 COVERS / LOCKS / TIEDOWNS  
**CHEMICALS**  
 TOOLS  
 HELMETS  
 HELMET ACC.  
 EYEWEAR  
 APPAREL / RIDER ACC.  
 PROMOTIONAL  
 REFERENCE  
 INDEX



Description	WPS#	
175 ml aerosol	24/case	<b>840-0210</b>
400 ml aerosol	12/case	<b>840-0212</b>

### **SUPER CLEAN CHAIN LUBE**

- Designed to resist fling-off (even in high speed applications)
- Protective coating dries white to ensure complete coverage
- Will not fling-off or attract dirt, sand or grit
- Wear and corrosion protection for long chain and sprocket life
- For chain applications, including 'O', 'X' and 'Z' ring units and roller chains



Description	WPS#	
175 ml aerosol	24/case	<b>840-0200</b>
400 ml aerosol	12/case	<b>840-0208</b>

### **BLUE TAC CHAIN LUBE**

- Designed to resist fling-off (even in high speed applications)
- Wear and corrosion protection for long chain and sprocket life
- Dries clear
- Anti-wear and anti-foam
- For chain applications, including 'O', 'X' and 'Z' ring units and roller chains



Description	WPS#	
400 ml aerosol	12/case	<b>840-3800</b>

### **FIBER FILTER OIL**

- Traps microscopic particles to extend engine life
- Will not clog or restrict air flow
- Water-resistant
- For fiber / gauze air filters



Description	WPS #	
400 ml aerosol	12/case	<b>840-2207</b>

### **6 IN 1 MULTI-PURPOSE LUBRICANT**

- All purpose lubricant
- Cleans, lubricates, protects, displaces water, reduces friction, penetrates rust
- Safe on electrical contacts, vinyl, wood and paint

- WINDSHIELDS / FAIRINGS
- AUDIO / COMMUNICATION
- SEATS / LUGGAGE
- BARS / MIRRORS / CONTROLS
- EXHAUST
- AIR / FUEL SYSTEMS
- ENGINE
- TRANSMISSION / DRIVELINE
- GASKETS / SEALS
- ELECTRICAL
- LIGHTING
- CABLES
- BRAKES
- OIL FILTERS
- SUSPENSION
- BODY
- WHEELS
- TIRES / TIRE ACC.
- BIKE ACC.
- VICTORY / INDIAN
- COVERS / LOCKS / TIEDOWNS
- CHEMICALS**
- TOOLS
- HELMETS
- HELMET ACC.
- EYEWEAR
- APPAREL / RIDER ACC.
- PROMOTIONAL
- REFERENCE
- INDEX



## SUPER DOT 4 BRAKE FLUID

- Formulated for hydraulic brake systems
- Mixes with all fluids meeting DOT 3 and DOT 4 specifications
- Boiling point: dry 230°C (446°F), wet 155°C (311°F)
- For brake systems and hydraulic clutches, except systems using mineral base fluids

Description	WPS#
355 ml 12/case	840-2701



## SILICONE DOT-5 BRAKE FLUID

- Formulated for hydraulic brake systems
  - Mixes with all fluids meeting DOT 5 specifications (not compatible with DOT 3 or DOT 4)
  - Boiling point: dry 260°C (500°F), wet 185°C (365°F)
  - Will not damage paint or absorb moisture
- For brake systems and hydraulic clutches, except systems using mineral base fluids

Description	WPS#
355 ml 12/case	840-2500



## WATERPROOF GREASE

- Waterproof grease for all bearing and bushing applications
- Corrosion protection (even in salt water)
- Wear protection extends bearing life
- Will not melt or run
- For bearings and bushings

Description	WPS#
16 oz tub	12/case 840-1100
14 oz cartridge	12/case 840-1101



## ASSEMBLY LUBE

- Molybdenum disulfide formula prevents metal-to-metal contact in extreme pressure conditions
- Prevents galling and seizing
- Provides initial lubrication for newly assembled engine parts
- For final drive spline assemblies

Description	WPS#
10 oz 12/case	840-0800



## FOAM FILTER CLEANER AND DEGREASER

- Designed to clean foam air filters
- Can also be used as an engine degreaser
- Will not discolor metals, paints or finishes
- For foam air filters

Description	WPS#
400 ml aerosol	12/case 840-2100





### FOAM FILTER OIL

- Designed to improve air flow
- Traps microscopic particles to extend engine life
- Waterproof formula prevents clogging when wet
- For foam air filters

Description	WPS#	
1 lt	12/case	840-0601
400 ml aerosol	12/case	840-3802



### BIKE WASH

- Softens and lifts accumulated dirt and grime without rubbing or brushing
- Easily rinses away with water
- Environmentally friendly, contains no volatile or potentially harmful solvents

Description	WPS#	
32 oz	12/case	840-2205

### CHAIN CLEANER

- No residue ensures optimum chain performance
- Fast, economical - safe for 'O', 'X', 'Z' rings and std chains
- Excellent compliment to BEL-RAY chain lubes

Description	WPS#	
400 ml aerosol	12/case	840-0214



### CONTACT CLEANER

- Aerosol spray applicator allows pinpoint use
- No messy clean-up
- Suitable for world wide use

Description	WPS#	
400 ml	12/case	840-0902



### ALL IN ONE FUEL TREATMENT

- Increases octane for more efficient combustion and increased engine power
- Cleans fuel lines and injectors to ensure smooth fuel delivery into the combustion chamber
- Neutralizes all of the harmful effects ethanol has on gasoline
- Keeps fuel fresh during storage
- Simple application to fuel with no complicated measuring or mixing

Description	WPS#	
1 oz	24 bottle display	840-2211
4 oz	12 bottle display	840-2212

- WINDSHIELDS / FAIRINGS
- AUDIO / COMMUNICATION
- SEATS / LUGGAGE
- BAR / MIRRORS / CONTROLS
- EXHAUST
- AIR / FUEL SYSTEMS
- ENGINE
- TRANSMISSION / DRIVELINE
- GASKETS / SEALS
- ELECTRICAL
- LIGHTING
- CABLES
- BRAKES
- OIL FILTERS
- SUSPENSION
- BODY
- WHEELS
- TIRES / TIRE ACC.
- BIKE ACC.
- VICTORY / INDIAN
- COVERS / LOCKS / TIEDOWNS
- CHEMICALS**
- TOOLS
- HELMETS
- HELMET ACC.
- EYEWEAR
- APPAREL / RIDER ACC.
- PROMOTIONAL
- REFERENCE
- INDEX

- WINDSHIELDS / FAIRINGS
- AUDIO / COMMUNICATION
- SEATS / LUGGAGE
- BARS / MIRRORS / CONTROLS
- EXHAUST
- AIR / FUEL SYSTEMS
- ENGINE
- TRANSMISSION / DRIVELINE
- GASKETS / SEALS
- ELECTRICAL
- LIGHTING
- CABLES
- BRAKES
- OIL FILTERS
- SUSPENSION
- BODY
- WHEELS
- TIRES / TIRE ACC.
- BIKE ACC.
- VICTORY / INDIAN
- COVERS / LOCKS / TIEDOWNS
- CHEMICALS**
- TOOLS
- HELMETS
- HELMET ACC.
- EYEWEAR
- APPAREL / RIDER ACC.
- PROMOTIONAL
- REFERENCE
- INDEX

# "Blendzall"

Racing Oils since 1959

## EXCELL - 4 CYCLE

- A premium based multi-viscosity racing oil formulated to protect your engine during the extreme demands of all out competition
- Contains the latest in EP (Extreme Pressure) and anti-friction additives
- High resistance to thermal and foaming break down
- Recommended for all 4-cycle engines, burning alcohol, gasoline and nitro fuels in racing or high performance applications

Description	Oil Weight		WPS#
1 qt	0W/5 kart	12/case	55-0454
1 gal	0W/5 kart	4/case	55-0453
1 qt	10W/30	12/case	55-0483
1 gal	10W/30	4/case	55-0484
1 qt	20W/50	12/case	55-0464
1 gal	20W/50	4/case	55-0463



## FUEL OIL - 4 CYCLE TOP END RACING LUBRICANT

- Blends with gasoline, alcohol, methanol and other racing fuels
- Uniquely formulated to prevent engine galling, seizure and premature wear
- Fuel oil is attracted to heat allowing closer clearances and leaner fuel ratios for more horsepower
- Mix ratio is 1/2 to 3/4 oz per gal depending on type of fuel

Description	WPS#
16 oz 12/case	55-0501
1 gal 4/case	55-0502



## "GOLD LABEL" 2 OR 4 CYCLE

- Combination racing castor/octane booster
- Increased RPMs without carburetor modification
- Blends completely with gasoline or alcohol
- Promotes quick cold weather starting
- Reduces heat build-up in hot weather

Description	WPS#
16 oz 12/case	55-0485
1 gal 4/case	55-0486



Racing Oils since 1959

“Blendzall”



Description	WPS#
32 oz 45W 12/case	55-0465

### RACING CASTOR LUBE - 4 CYCLE

- The ultimate racing lubricant for all 4 stroke engines
- Reduces wear to vital engine parts in all gasoline/ alcohol high performance 4 cycle engines
- Improved ring seal
- Maximum lubrication without exhaust smoke and keeps internal parts like new



Description	WPS#
32 oz 12/case	55-0469

### CONVERSION FLUID

- Flushing fluid for 4 cycle lubrication systems when changing from mineral oil to castor oil or vice-versa
- Compatible with either oil and leaves no residue
- Conversion fluid prevents lumping or congealing of lubricants that do not mix



Description	WPS#
16 oz 12/case	55-0490

### OCTANE BOOSTER

- Increases horsepower by relieving detonation
- Lowers combustion chamber temperatures
- Blends with pump, racing gas and methanol fuels
- Controls condensation in fuel tanks without harmful additives



Description	WPS#
14 oz 12/case	55-0500

### CHAIN LUBE

- Racing chain lubricant with high film strength and the unique ability to cling to metal without washing off
- Protects standard and O-ring chains from wear and corrosion



Description	WPS#
1 qt 12/case	55-0555

### TIRE TRACTION TREATMENT

- Reinstates chemicals into race tires that are lost when tires are heated
- Restores original softness

- WINDSHIELDS / FAIRINGS
- AUDIO / COMMUNICATION
- SEATS / LUGGAGE
- BARS / MIRRORS / CONTROLS
- EXHAUST
- AIR / FUEL SYSTEMS
- ENGINE
- TRANSMISSION / DRIVELINE
- GASKETS / SEALS
- ELECTRICAL
- LIGHTING
- CABLES
- BRAKES
- OIL FILTERS
- SUSPENSION
- BODY
- WHEELS
- TIRES / TIRE ACC.
- BIKE ACC.
- VICTORY / INDIAN
- COVERS / LOCKS / TIEDOWNS
- CHEMICALS**
- TOOLS
- HELMETS
- HELMET ACC.
- EYEWEAR
- APPAREL / RIDER ACC.
- PROMOTIONAL
- REFERENCE
- INDEX



**100% SYNTHETIC**

- 100% synthetic oil specifically formulated for sport bikes
- TriZone technology - designed and tested to provide superior protection for engine, clutch and gearbox
- RS formulation improves clutch power transfer



Description	WPS#	
5W40 1 qt	6/case	<b>83-0446</b>
10W40 1 qt	6/case	<b>83-0448</b>
10W50 1 qt	6/case	<b>83-0444</b>
20W-50 1 qt	6/case	<b>83-0441</b>
5W-40 55 gal		<b>83-0437</b>
10W50 55 gal		<b>83-0435</b>
Oil Drum Pump		<b>27-0190</b>

*WPS PAYS 1/2 FREIGHT ON DRUMS OF OIL*

**SYNTHETIC BLEND**

- Advanced synthetic blend protection for 4-stroke engines
- TriZone technology - designed and tested to provide superior protection for engine, clutch and gearbox
- Exceeds all known manufacturer requirements



Description	WPS#	
10W30 1 qt	6/case	<b>83-0462</b>
10W40 1 qt	6/case	<b>83-0460</b>
10W40 1 gal	3/case	<b>83-0461</b>
10W40 55 gal		<b>83-0463</b>
20W50 1 qt	6/case	<b>83-0458</b>
20W50 1 gal	3/case	<b>83-0465</b>
20W50 55 gal		<b>83-0467</b>
Oil Drum Pump		<b>27-0190</b>

**4-STROKE GO DRUM ENGINE OIL**

- Premium quality 10W40 4-stroke mineral engine oil
- API SG and JASO MA certified
- Exceeds all OEM manufacturers warranty requirements
- Suitable for all new bike setup and service oil changes
- Available in 55 gal drums only



Description	WPS#	
10W40 GO 55 gal		<b>83-0127</b>
20W50 GO 55 gal		<b>83-0128</b>
20W50 55 gal		<b>83-0138</b>
Oil Drum Pump		<b>27-0190</b>

*WPS PAYS 1/2 FREIGHT ON DRUMS OF OIL*

**BRAKE FLUID**

- Exceeds DOT 3/4 specifications
- Improves handling in high braking temperatures
- Reduces brake fade



Description	WPS#	
12 oz	12/case	<b>83-0341</b>

**MTX GEAR OIL**

- Advanced formula designed to stand up to the tough shearing action of gears
- Strong flushing action keeps all components clean and protected
- Saves your clutch by reducing drag and noise for smoother gear changing



Description	WPS#	
80W Synthetic 1 lt	12/case	<b>83-0308</b>

**SRF RACING BRAKE FLUID**

- DOT 3/4 specifications
- High performance product formulated specifically to satisfy the ever increasing stresses placed upon braking systems



Description	WPS#	
1 lt	12/case	<b>83-0345</b>



## 4 CYCLE LUBRICATION



### 4-STROKE V-TWIN SYNTHETIC LUBRICANT

- Recommended for the Harley Davidson Revolution, Twin Cam 88, Evolution XL, Evolution 1340, Pre-Evolution (20W/50 and 25W/60) and Buell engines
- Certified warranty compliant: API-SH/CG-4 service
- Custom formulated for the v-twin air-cooled engines
- Reduces engine temperature and detonation
- High temperature film strength improving anti-wear protection



Description	WPS #
20W50 32 fl. oz. 10/case	842-0050
25W60 1qt 10/case	842-0058

### AMERICAN V-TWIN SYNTHETIC LUBRICANT

- Certified warranty compliant
- Custom formulated for the Harley-Davidson Big Twin models
- Smoother and quieter shifting
- Reduced driveline friction
- Provides protection from shock loading and galling
- Extended bearing and gear life
- Reduced gear and transmission temperatures



Description	WPS #
80W90 32 fl. oz. 10/case	842-0061
75W140 32 fl. oz. 10/case	842-0060

### AMERICAN V-TWIN PRIMARY CASE LUBE

- Works great in all fabric type filters
- Will quickly penetrate and saturate fabric
- Straightens turbulent air, improving engine performance



Description	WPS #
32 fl. oz. 10/case	842-0115

### FORK OIL

- Formulated for Street and MX Bike suspension technology
- Anti-foam and anti-fade additive system reduces friction and cavitation
- Anti-wear seal conditioners help prevent hardening, extend fork seals and bushing life
- Superior control with Zero-drag formula
- Stabilizes viscosity in extreme heat or cold conditions



Description	WPS #
5 W 32 oz 10/case	842-0110
10 W 32 oz 10/case	842-0111
15 W 32 oz 10/case	842-0112



### SYNTHETIC STRAIGHT WEIGHT V-TWIN

- Certified warranty compliant: API-SH/CG-4 service
- Custom formulated for the Harley-Davidson pre-Evolution® engines
- Reduces friction for Less Drag—More Power®
- High temperature film strength improving anti-wear protection
- Reduces engine temperature and detonation

Description	WPS #
50 WT 1 qt 10/case	842-0055
60 WT 1 qt 10/case	842-0056
70 WT 1 qt 10/case	842-0057

- WINDSHIELDS / FAIRINGS
- AUDIO / COMMUNICATION
- SEATS / LUGGAGE
- BARS / MIRRORS / CONTROLS
- EXHAUST
- AIR / FUEL SYSTEMS
- ENGINE
- TRANSMISSION / DRIVELINE
- GASKETS / SEALS
- ELECTRICAL
- LIGHTING
- CABLES
- BRAKES
- OIL FILTERS
- SUSPENSION
- BODY
- WHEELS
- TIRES / TIRE ACC.
- BIKE ACC.
- VICTORY / INDIAN
- COVERS / LOCKS / TIEDOWNS
- CHEMICALS
- TOOLS
- HELMETS
- HELMET ACC.
- EYEWEAR
- APPAREL / RIDER ACC.
- PROMOTIONAL
- REFERENCE
- INDEX

WINDSHIELDS / FAIRINGS  
 AUDIO / COMMUNICATION  
 SEATS / LUGGAGE  
 BARS / MIRRORS / CONTROLS  
 EXHAUST  
 AIR / FUEL SYSTEMS  
 ENGINE  
 TRANSMISSION / DRIVELINE  
 GASKETS / SEALS  
 ELECTRICAL  
 LIGHTING  
 CABLES  
 BRAKES  
 OIL FILTERS  
 SUSPENSION  
 BODY  
 WHEELS  
 TIRES / TIRE ACC.  
 BIKE ACC.  
 VICTORY / INDIAN  
 COVERS / LOCKS / TIEDOWNS  
 CHEMICALS  
 TOOLS  
 HELMETS  
 HELMET ACC.  
 EYEWEAR  
 APPAREL / RIDER ACC.  
 PROMOTIONAL  
 REFERENCE  
 INDEX



## CHAIN AND CHAIN CASE LUBE

- Black formula contains graphite
- Dramatically reduces friction
- Provides maximum power and performance in extreme conditions
- Unique formula protects chains and sprockets from wear and breakage



Description	WPS #
12 oz. 10/case	842-0116

## CHAIN LUBE

- EXTRATAC™ penetrates deeply and dries tacky
- Waterproof formula prevents rust and wash off
- Approved for conventional and "O" ring chains
- Extends chain and sprocket life
- Loosens stiff chain links
- Environmentally safe formula



Description	WPS #
15.5 oz. 10/case	842-0119

## NITRO RACING ADDITIVE WITH KOOLINAL

- Oxygenating power additive
- Developed for gasoline, methanol and diesel fuel
- 50% Nitro, 50% Koolinal
- Koolinal is a blending agent that resists detonation and pre-ignition
- Extracts maximum HP from stock and modified engines

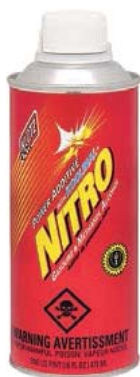

Description	WPS #
16 oz 10/case	842-0130

## HITRATE® RACING GAS CONCENTRATE

- Converts 92 octane pump gasoline to 103-105 octane racing gas
- Unleaded formula
- Provides smoother torque curves for more usable power
- Cost-effective alternative to race gas
- Blends gasoline and ethanol enriched fuels



Description	WPS #
1 gal	842-0054

## OCTANE BOOSTER AND GAS STABILIZER

- Cleans metal surfaces, fouled spark plugs and other small parts
- Non-conductive formula
- Residue free formula quickly cuts through grease, oil, carbon, tar, adhesives and other contaminants
- Excellent for drying out parts in damp humid conditions

Description	WPS #
16 oz 10/case	842-0133
1 gal	842-0134



## CONTACT CLEANER AND DEGREASER SHOP SIZE

- Convenient, fast cleaner and degreaser
- Removes gum, varnish and carbon build-up
- Cleans fouled spark plugs
- Fast evaporation leaves no residue
- Non-conductor, safe for electrical systems
- Displaces moisture and water
- Cleans gasket surfaces



Description	WPS #
20 oz 10/case	842-0146

## FILTER CLEANER

- Improves airflow and performance
- Cleans fabric and foam air filters
- Cleans oil, dust, dirt, and sand from filters
- Rinses clean with water
- Environmentally safe formula

Description	WPS #
16 oz 10/case	842-0120





### FOAM AIR FILTER OIL

- Blocks out moisture, dirt and water
- For waterproof protection

Description	WPS #	
15.25 oz	10/case	842-0140



### FABRIC AIR FILTER OIL

- Works great in all fabric type filters
- Will quickly penetrate and saturate fabric
- Straightens turbulent air, improving engine performance

Description	WPS #	
16 oz	10/case	842-0143



### GASOLINE TREATMENT

- Eliminates water and water related problems
- Improves overall engine efficiency
- Burns cleanly and completely with no ash deposits
- Dissolves gums and varnishes
- MG also revitalizes fuel and stabilizes for extended storage

Description	WPS#		
K-100-G 8oz	12/case	57-4100	
K-100-MG 2.5oz	24/pack	57-4465	
K-100-MG 8oz	12/case	57-4401	
K-100-MG 32oz	12/case	57-4403	

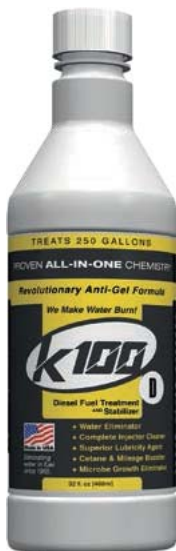

### DIESEL FUEL TREATMENT

- Eliminates water and water-related problems
- Eliminates conditions necessary for microbe growth
- Improves overall engine efficiency
- Dissolves gums and varnishes
- MD revitalizes fuel and stabilizes fuel for long-term storage

Description	WPS#		
K-100-D 8oz	12/case	57-4404	
K-100-D 32oz	4/case	57-4514	
K-100-MD 8oz	12/case	57-4406	

- WINDSHIELDS / FAIRINGS
- AUDIO / COMMUNICATION
- SEATS / LUGGAGE
- BARS / MIRRORS / CONTROLS
- EXHAUST
- AIR / FUEL SYSTEMS
- ENGINE
- TRANSMISSION / DRIVELINE
- GASKETS / SEALS
- ELECTRICAL
- LIGHTING
- CABLES
- BRAKES
- OIL FILTERS
- SUSPENSION
- BODY
- WHEELS
- TIRES / TIRE ACC.
- BIKE ACC.
- VICTORY / INDIAN
- COVERS / LOCKS / TIEDOWNS
- CHEMICALS**
- TOOLS
- HELMETS
- HELMET ACC.
- EYEWEAR
- APPAREL / RIDER ACC.
- PROMOTIONAL
- REFERENCE
- INDEX



## ENGINE OIL

- Formulated with the highest quality base oils
- Made with exclusive additives
- Lowers engine oil temperatures
- Longer engine oil life
- Extends engine component life
- Reduces engine noise, helps prevent leaks
- Meets JASO specifications



Description	WPS #
10W40 1 qt 6/case	58-5240
20W50 1 qt 6/case	58-5241
50 W 1 qt 6/case	58-5242
70 W 1 qt 6/case	58-5243

## SYNTHETIC ENGINE OIL

- Formulated from the highest quality synthetics
- Made with exclusive additives
- Lowers engine oil temperatures
- Longer engine oil life
- Extends engine component life
- Reduces engine noise, helps prevent leaks
- Meets JASO specifications
- Moly engine oil is not for use in wet clutch applications

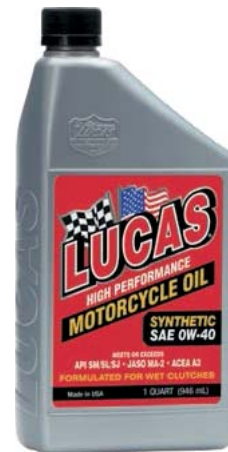

Description	WPS #
0W40 Full Syn. 1 qt 6/case	58-5220
5W20 Full Syn. 1 qt 6/case	58-5227
5W30 Full Syn. 1 qt 6/case	58-5229
10W30 Full Syn. 1 qt 6/case	58-5221
10W40 Moly 1 qt 6/case	58-5222
10W40 Semi Syn. 1 qt 6/case	58-5235
10W40 Full Syn. 1 qt 6/case	58-5226
10W50 Full Syn. 1 qt 6/case	58-5223
20W50 Full Syn. 1 qt 6/case	58-5224
50 W Full Syn V-Twin 1 qt 6/case	58-5225

## PRIMARY CHAIN CASE OIL

- Smooth clutch action, less slippage
- Extends chain and sprocket life
- Delivers cooler and quieter operation
- Designed for heavy duty, high performance application
- Meets or exceeds all OEM requirements



Description	WPS#
1 qt 6/case	58-5203

## V-TWIN GEAR AND TRANSMISSION OIL

- Formulated for cool quiet performance
- Minimum wear and minimum drag
- Withstands high power and high temperature
- Designed especially for V-Twins, high performance or heavy duty
- Meets or exceeds all OEM requirements



Description	WPS#
75W/140 1 qt 6/case	58-5202

## HEAVY DUTY GEAR OIL

- Designed for racers
- Contains special anti-wear and lubricity agents
- Helps control heat
- Excellent for high performance and heavy-duty applications



Description	WPS #
80W90 1 qt 12/case	58-5200
85W140 1 qt 12/case	58-5201

## SYNTHETIC GEAR AND TRANSMISSION OIL

- Designed to cushion gears and resist "squeezing out"
- formulated for high performance and heavy duty applications
- Withstands high temperatures
- Super slick long lasting lubrication



Description	WPS #
75W90 1 qt 12/case	58-5205
75W140 1 qt 12/case	58-5206
80W85 1 qt 12/case	58-5207

## ETHANOL FUEL CONDITIONER

- Developed to prevent corrosion and degeneration of fuels containing ethanol
- Cleans injectors, valve seats and combustion chamber while running
- Works in any alcohol fuel mixes or gasoline
- Great for 2-stroke and 4-stroke engines
- 1 oz treats 5 gallons

Description	WPS #
5.25 oz 24/case	<b>58-5281</b>
16 oz 12/case	<b>58-5280</b>



## FUEL STABILIZER

- Developed to prevent gasoline breakdown during storage
- Safe for all grades of gasoline
- Excellent for 2-stroke and 4-strokes
- 1 oz treats 1 gallon

Description	WPS #
8 oz 12/case	<b>58-5285</b>
1 qt 12/case	<b>58-5286</b>



## FUEL TREATMENT

- Formulated for use in gasoline, diesel and LPG engines
- Known as tune-up in a bottle
- Cleans and lubricates the entire fuel system, pumps, injectors or carburetors
- Neutralizes low sulfur fuel problems
- Increases power and mileage by efficient burning
- 1 oz treats up to 5 gallons of fuel

Description	WPS #
5.25 oz 24/case	<b>58-5288</b>
32 oz 12/case	<b>58-5370</b>



## OCTANE BOOSTER

- A real octane booster
- Safe for use with turbos, oxygen sensors and catalytic converters
- Good in carbureted or injected engines
- Promotes cleaner fuel burn resulting in less exhaust emissions
- Not street legal, for use in 4 stroke engines only
- 15 oz bottle treats up to 25 gallons of fuel

Description	WPS #
2 oz 18/case	<b>58-5290</b>
15 oz 12/case	<b>58-5291</b>



## SYNTHETIC FORK OIL

- Made from the highest quality SYNTHETIC base oils
- Delivers more responsive handling
- Prevents foaming
- Reduces thermal expansion
- Prevents seal hardening
- Prevents static friction and gives great wear protection

Compatible use in all suspensions

Description	WPS #
5 W 16 oz 12/case	<b>58-5250</b>
10 W 16 oz 12/case	<b>58-5251</b>
15 W 16 oz 12/case	<b>58-5252</b>
20 W 16 oz 12/case	<b>58-5253</b>



## CHAIN LUBE

- Designed for deep penetration for the pins and bushings
- Foam facilitates penetration into chain
- Maintains and excellent corrosion inhibitor and water resister
- Provides a film protection to ensure minimum wear and drag
- Suitable for all types of chains
- Minimizes sling off

Description	WPS #
11 oz 12/case	<b>58-5272</b>



## ASSEMBLY LUBE

- Formulated from ZINC, MOLY and other high pressure additives
- Eliminates dry starts
- Perfect for engine building or rebuilding
- Prevents seizing, galling or scuffing
- Compatible with all oils
- Super slick and tacky
- Easy to use

Description	WPS #
4 oz 12/case	<b>58-5265</b>
8 oz 12/case	<b>58-5266</b>



## TOOL BOX BUDDY

- Dissolve rust and corrosion without drying
- Provides a very light film to stop rust for up to one year
- Low odor
- Fortified with anti-seize agents
- Easy to use

Description	WPS #
11 oz 12/case	<b>58-5270</b>



- WINDSHIELDS / FAIRINGS
- AUDIO / COMMUNICATION
- SEATS / LUGGAGE
- BAR / MIRRORS / CONTROLS
- EXHAUST
- AIR / FUEL SYSTEMS
- ENGINE
- TRANSMISSION / DRIVELINE
- GASKETS / SEALS
- ELECTRICAL
- LIGHTING
- CABLES
- BRAKES
- OIL FILTERS
- SUSPENSION
- BODY
- WHEELS
- TIRES / TIRE ACC.
- BIKE ACC.
- VICTORY / INDIAN
- COVERS / LOCKS / TIEDOWNS
- CHEMICALS
- TOOLS
- HELMETS
- HELMET ACC.
- EYEWEAR
- APPAREL / RIDER ACC.
- PROMOTIONAL
- REFERENCE
- INDEX



### AIR TOOL OIL

- Extends air tool life
- Protects under extreme operating temperatures
- Disperses water
- Resists blow out
- Excellent for locks



Description	WPS #
16 oz 12/case	<b>58-5274</b>

### SLICK MIST SPEED WAX

- Premium paint gloss intensifier
- Great for motorcycles, cars, trucks, boats and airplanes
- Shines and protects in one easy application
- Excellent on chrome, glass and vinyl
- Use on wet or dry surfaces
- Quick and easy



Description	WPS #
2 oz 20 pack w/counter display	<b>58-5304</b>
24 oz 12/case	<b>58-5301</b>

### FOAM FILTER OIL

- Easy pour on
- Low solvent
- Low viscosity
- Repels moisture
- Penetrates filter easier to trap dirt and dust
- Improve air flow



Description	WPS#
1qt 12/case	<b>58-5277</b>

### SYNTHETIC BRAKE FLUID

- Designed for all disc and drum brake systems requiring DOT 3/DOT 4 brake fluid
- Safely mixes with DOT 3 brake fluid
- Minimum wet boiling point is 311° F (155° C)
- Meets FMVSS 116 and SAE J1704 specifications

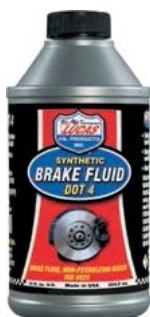

Description	WPS#
12 oz 12/case	<b>58-5320</b>

### GUN OIL

- Protect your guns and equipment with the latest in lubricating technology
- Super slick formula clings well for easier operation and reduced wear
- Heat and water resistant, environmentally friendly
- Neutralizes acids caused by contact with human hands and resists drying during long storage periods



Description	WPS#
2 oz 18/case	<b>58-5350</b>

### HEAVY DUTY GREASE

- Last four times longer than regular grease
- Virtually waterproof
- All temperature stable
- Exceeds Lube for life specifications
- The ultimate grease for high speed bearings



Description	WPS #
1 lb tub 12/case	<b>58-5295</b>
14.5 oz cartridge 10/case	<b>58-5296</b>

### RED 'N' TACKY GREASE

- Formulated with rust and oxidation inhibitors
- Water resistant
- Maintains excellent mechanical stability
- Long storage life
- Fortified with Anti-Seize compounds
- Wide variety of applications



Description	WPS#
1 lb tub 12/case	<b>58-5298</b>
14.5 oz cartridge 30/case	<b>58-5299</b>

### MARINE GREASE

- Heavy duty lithium complex
- Designed to provide maximum lubrication under the most severe conditions
- A true marine trailer wheel bearing and chassis grease
- Long lasting
- Protects in both salt and fresh water
- Extreme friction reducer



Description	WPS#
14 oz 30/case	<b>58-5297</b>

### CONTACT CLEANER

- Formulated with a unique blend of solvents, cleaning agents and propellants
- Removes oil, dirt and moisture
- Non-chlorinated CFC free formula dries quickly and leaves no residue
- Not for use on plastic



Description	WPS#
14 oz 12/case	<b>58-5309</b>

### LUCAS APPLICATOR

- Convenient bottle for tool box, range box and tackle box
- Durable removable metal needle
- Bottle has writable area for identification of contents
- Made in the U.S.A.



Description	WPS#
1 oz	<b>58-5390</b>



## V-TWIN FULL SYNTHETIC ENGINE OIL

- Full synthetic, ester based motorcycle oil specifically formulated for V-Twin engines
- Advanced technology lowers operating temperatures, reduces wear, increases film strength and offers extended protection
- Regenerative polymer system resists mechanical shearing and heat breakdown of the oil offering exceptional viscosity retention in severe climates
- Superior additive package keeps engines clean, protects against sludge and allows for trouble-free operation
- Engineered and approved to be used as multi-compartment oil for H-D V-Twin engines, transmissions and primaries.
- Meets all warranty requirements for Harley- Davison engines and does not void new motorcycle warranties.



Description	WPS#
20W50 1 qt 12/case	78-99920

## V-TWIN MINERAL ENGINE OIL

- High-quality mineral based motorcycle oil specifically formulated for V-Twin engines
- Advanced polymer system resists mechanical shearing and heat breakdown of the oil offering unsurpassed viscosity retention
- Industry leading anti-wear and extreme pressure additives protect critical engine components
- Superior additive package keeps engines clean, protects against sludge and allows for trouble-free operation
- Meets all warranty requirements for Harley- Davison engines and does not void new motorcycle warranties.



Description	WPS#
10W40 1 qt 12/case	78-99910
20W50 1 qt 12/case	78-99911
20W50 1 gal 4/case	78-99912
20W50 5 gal	78-99913
20W50 55 gal	78-99914
25W60 1 qt 12/case	78-99915
Oil Drum Pump	27-0190

## V-TWIN SYNTHETIC BLEND ENGINE OIL

- Semi-synthetic, ester based motorcycle oil specifically formulated for V-Twin engines
- Advanced technology lowers operating temperatures, reduces wear, increases film strength and offers extended protection
- Advanced polymer system resists mechanical shearing and heat breakdown of the oil offering unsurpassed viscosity retention
- Superior additive package keeps engines clean, protects against sludge and allows for trouble-free operation
- Meets all warranty requirements for Harley- Davison engines and does not void new motorcycle warranties.



Description	WPS#
20W50 1 qt 12/case	78-99919

## V-TWIN MINERAL ENGINE OIL

- Recommended for Pre-Evolution® V-Twin engines
- High-quality mineral based motorcycle oil specifically formulated for V-Twin engines
- Shear stable formula offers good protection against mechanical breakdown
- Industry leading anti-wear and extreme pressure additives protect critical engine components
- Superior additive package keeps engines clean, protects against sludge and allows for trouble-free operation
- Meets all warranty requirements for Harley- Davison engines and does not void new motorcycle warranties.



Description	WPS#
50WT 1 qt 12/case	78-99916
60WT 1 qt 12/case	78-99917
70WT 1 qt 12/case	78-99918

WPS PAYS 1/2 FREIGHT ON DRUMS OF OIL

- WINDSHIELDS / FAIRINGS
- AUDIO / COMMUNICATION
- SEATS / LUGGAGE
- BARS / MIRRORS / CONTROLS
- EXHAUST
- AIR / FUEL SYSTEMS
- ENGINE
- TRANSMISSION / DRIVELINE
- GASKETS / SEALS
- ELECTRICAL
- LIGHTING
- CABLES
- BRAKES
- OIL FILTERS
- SUSPENSION
- BODY
- WHEELS
- TIRES / TIRE ACC.
- BIKE ACC.
- VICTORY / INDIAN
- COVERS / LOCKS / TIEDOWNS
- CHEMICALS**
- TOOLS
- HELMETS
- HELMET ACC.
- EYEWEAR
- APPAREL / RIDER ACC.
- PROMOTIONAL
- REFERENCE
- INDEX



## V-TWIN HEAVY DUTY TRANSMISSION / GEAR OIL

- Heavy duty formula offers extended performance in severe operating conditions
- Ultra high film strength gear oil provides excellent protection against shock loads, wear and increases fluid durability
- Unsurpassed extreme pressure additives and surface active chemistry allow smooth shifting under peak loads and RPMs
- Recommended for use in 4-, 5- and 6-speed high performance gear boxes
- Meets and exceeds all known OEM requirements and API GL-5 specifications



Description	WPS#
85W140 1qt 12/case	78-99921

## V-TWIN SYNTHETIC PRIMARY OIL

- Full Synthetic Formula Offers Long-Term Protection
- Developed & Tested in H-DR Gear & Chain cases
- Clutch-saver Wet Clutch Formula
- Designed for use in '84 and newer models with wet diaphragm spring clutches
- Meets and exceeds all known OEM requirements



Description	WPS#
1qt 12/case	78-99928

## V-TWIN SPORTSTER GEAR / CHAIN CASE OIL

- Formulated for high-performance transmissions and primary chain cases
- Recommended for use in 1971 and newer XR and XL H-D motorcycles
- Unsurpassed extreme pressure additives and surface active chemistry allow smooth shifting under peak loads and RPMs
- High film strength provides excellent wear protection and durability



Description	WPS#
1 qt 12/case	78-99923

## V-TWIN TRANSMISSION / GEAR OIL

- High film strength gear oil provides excellent protection against shock loads, wear and increases fluid durability
- Unsurpassed extreme pressure additives and surface active chemistry allow smooth shifting under peak loads and RPMs
- High performance formula offers extended performance in high-stress operating conditions
- Recommended for use in 4-, 5- and 6-speed high performance gear boxes
- Meets and exceeds all known OEM requirements and API GL-5 specifications



Description	WPS#
80W90 1qt 12/case	78-99922

## V-TWIN PRIMARY OIL

- Designed for use in all 1984 and later models with wet diaphragm spring clutches
- Formulated specifically for high-performance primaries
- Advanced additives reduce clutch and fluid drag while lubricating gears, sprockets, chains and all critical primary case components
- Superior film strength for greater protection against shock loads



Description	WPS#
1 qt 12/case	78-99924

## V-TWIN FORK OIL

- V-Twin Fork Oil with Lubricinol reduces stiction and provides uniform fork action over a wide temperature range
- Regenerative synthetic polymer system resists viscosity loss offering ultra-smooth, consistent suspension operation
- High viscosity index (VI) fluid contains special additives to condition seals, control foaming, oxidation, rust & corrosion
- 5WT (Type B); 10WT (Type E); 20WT (Type H/D)



Description	WPS#
5WT 1 qt 12/case	78-99925
10WT 1 qt 12/case	78-99926
20WT 1 qt 12/case	78-99927





## HYPOID SYNTHETIC GEAR OIL

- 100% synthetic gear oil is formulated for Hypoid gears on shaft drive and motorcycles with clutch lubricant separate from transmission
- Greatly enhances shifting in twin cylinder motorcycles such as BMW® and Harley Davidson®
- Anti-foaming, rust and corrosion resistant
- Exceeds API GL-5 specs



Description	WPS#
75W90 1 lt 12/case	78-9900

## RACING SHOCK FLUID

- Formulated to prevent foaming and seal hardening
- Reduced friction and increased rust and corrosion protection
- Viscosity index of 385+ for light and 394+ for medium weight fluid
- Will work in steel or aluminum bodied suspension components



Description	WPS#
3WT 1qt 12/case	78-98301
3WT 5 gal	78-98302
Light 1 qt 12/case	78-9930
Light 5 gal	78-9938
Medium 1 qt 12/case	78-9931
Medium 5 gal	78-9939
Heavy 1 qt 12/case	78-9936
Heavy 5 gal	78-9937
Pump for 5 gal pail	78-9829

## RACING FORK FLUID

- Zero drag fluid is the latest in anti-frictional fork oil
- Contains rust and corrosion inhibitors with anti-foam and oxidation stabilizers
- May be used in standard or cartridge forks



Description	WPS#
5W 1 lt 12/case	78-9925
5W 5 gal	78-9916
7W 1 lt 12/case	78-9926
7W 5 gal	78-9920
10W 1 lt 12/case	78-9927
10W 5 gal	78-9921
15W 1 lt 12/case	78-9929
Pump for 5 gal pail	78-9829

## SUSPENSION CLEAN

- Quickly removes suspension fluid and grease
- Professional formula is fast drying - leaves no residue
- Displaces moisture
- Will not harm O-rings or seals
- Specifically formulated for the Powersports Industry



Description	WPS#
16.1 oz 12/case	78-9946

## CHAIN WAX

- For street, road racing, dual sport, off road and control cables
- Eliminates "fling-off" and seals lubricant to chain
- Special paraffin base creates a waxy film that protects metal from rust and corrosion
- O-ring safe



Description	WPS#
7.4 oz 20/case	78-9934
17.3 oz 12/case	78-9935

- WINDSHIELDS / FAIRINGS
- AUDIO / COMMUNICATION
- SEATS / LUGGAGE
- BAR / MIRRORS / CONTROLS
- EXHAUST
- AIR / FUEL SYSTEMS
- ENGINE
- TRANSMISSION / DRIVELINE
- GASKETS / SEALS
- ELECTRICAL
- LIGHTING
- CABLES
- BRAKES
- OIL FILTERS
- SUSPENSION
- BODY
- WHEELS
- TIRES / TIRE ACC.
- BIKE ACC.
- VICTORY / INDIAN
- COVERS / LOCKS / TIEDOWNS
- CHEMICALS
- TOOLS
- HELMETS
- HELMET ACC.
- EYEWEAR
- APPAREL / RIDER ACC.
- PROMOTIONAL
- REFERENCE
- INDEX



## CHAIN WAX ULTIMATE CHAIN CARE KIT COMBO 3-PACK

- Includes Clean-Up 15.5 oz., MPPL 14.5 oz. & CHAIN WAX 13.5 oz.
- Extends chain and sprocket life
- Increases horsepower and torque to the rear wheel
- Safe for all sealed and non sealed chain
- For Street and Off-Road use

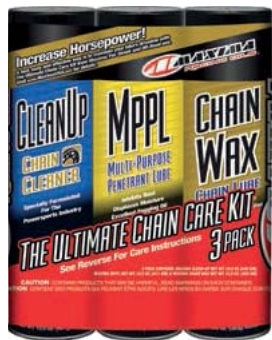

Description	WPS#
17.1/14.5/17.3 oz 4/case	78-9949

## 100% SYNTHETIC CHAIN GUARD

- 100% synthetic chain lube
- Clear formula resists fling off
- Safe for sealed and non sealed chain
- Allows lube to penetrate critical inner pins & rollers protecting them from friction and temperatures



Description	WPS#
7.4 oz 20/case	78-9932
17.3 oz 12/case	78-9933

## FAB-1 FABRIC & FOAM FILTER SPRAY

- Use on fabric or foam filters
- Fast penetrating
- Dust proof and water proof
- Effective polymer and co-polymer system
- Increases filter efficiency

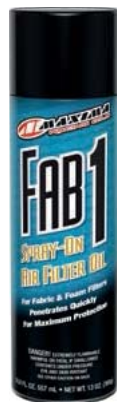

Description	WPS#
18.8 fl oz 12/case	78-9928

## MPPL

- Multi purpose penetrating lube
- Excellent fogging oil
- Displaces moisture to inhibit rust
- Frees corroded parts



Description	WPS#
14.5 oz 12/case	78-9945

## SYN CHAIN GUARD ULTIMATE CHAIN CARE KIT COMBO 3-PACK

- Includes Clean-Up 15.5 oz., MPPL 14.5 oz. & Chain Gaurd 14 oz.
- Extends chain and sprocket life
- Increases horsepower and torque to the rear wheel
- Safe for sealed and non sealed chain
- For Street and Off-Road use

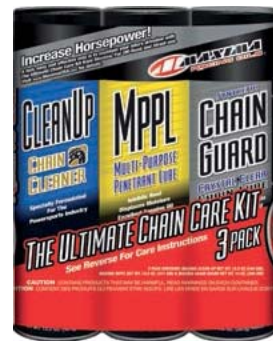

Description	WPS#
17.1/14.5/18.1 oz 4/case	78-9957

## ASSEMBLY LUBE

- 2X Zinc activates at both high and low temperature
- Prevents metal-to-metal contact
- Gives excellent rust and corrosion protection
- Protects against wear on initial break in
- Mixes with petroleum and synthetic oils

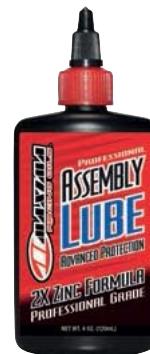

Description	WPS#
4 oz 12/case	78-9970

## CLEAN UP DEGREASER & CHAIN CLEANER

- Excellent chain cleaner and degreaser
- Removes caking and build-up on chain and sprockets
- Won't harm sealed or non sealed chain
- Easily washes off with water



Description	WPS#
17.1 oz 12/case	78-9942

## SPEED WAX

- All-in-one detailer cleans, shines and protects
- Fast, easy and effective
- Carnuba wax formula
- Brilliant, long lasting shine in seconds



Description	WPS#
17.8 oz. 12/case	78-9973



### CITRUS CONTACT/ BRAKE CLEANER

- Environmentally safe with a citrus scent
- Dries quickly and leaves no surface film or residue
- Quickly removes grease, oil and adhesives while displacing moisture
- Safe for painted and most plastic surfaces



Description	WPS#
17.5 oz. Aerosol	12/case <b>78-9941</b>

### SC1 SILICONE SPRAY

- Restores factory shine to plastic, fiberglass and painted surfaces
- Prevents mud and dirt from adhering to plastic



Description	WPS#
12 oz	12/case <b>78-9944</b>

### AIR FILTER MAINTENANCE CARE KIT COMBO 2-PACK

- Includes large can air filter cleaner 15.5 Fl oz
- Includes large can FAB-1 spray on air filter oil 13 fl oz
- Provides ultimate protection for your engine
- Championship winning formulas
- Unsurpassed protection against the passage of dirt, dust and water



Description	WPS#
Cleaner/Fab 1	17.1 fl oz/18.8 fl oz <b>78-9947</b>

### AIR FILTER CLEANER

- Voted best air filter cleaner by Dirt Rider magazine
- For use on Motorcycles and ATVs
- Excellent foam and fabric air filter cleaner that washes out with water
- Highly effective emulsion formula contains no caustic chemicals
- Removes heavy filter oils, grease and other contaminants



Description	WPS#
17.1 oz aerosol	12/case <b>78-9940</b>
64oz	6/case <b>78-9976</b>

### HI-TEST OCTANE BOOSTER

- All organic, containing no metal (lead, manganese or phosphorus)
- Readily mixed with gasoline, alcohol and nitro mixtures
- Raises octane level to stop knocking and pinging
- Increases horsepower in 2-cycle and 4-cycle engines



Description	WPS#
16 oz.	12/case <b>78-9950</b>

### FUEL STORAGE STABILIZER

- Prevents the deterioration of fuel and stops the formation of gum and varnish
- Eliminates the need to drain or dispose of fuel over long storage periods
- Works with both gasoline and diesel fuels
- 1 oz per gal protects system from corrosion due to the use of ethanol based fuels



Description	WPS#
8 oz.	12/case <b>78-9971</b>
1 qt	12/case <b>78-9972</b>

- WINDSHIELDS / FAIRINGS
- AUDIO / COMMUNICATION
- SEATS / LUGGAGE
- BAR / MIRRORS / CONTROLS
- EXHAUST
- AIR / FUEL SYSTEMS
- ENGINE
- TRANSMISSION / DRIVELINE
- GASKETS / SEALS
- ELECTRICAL
- LIGHTING
- CABLES
- BRAKES
- OIL FILTERS
- SUSPENSION
- BODY
- WHEELS
- TIRES / TIRE ACC.
- BIKE ACC.
- VICTORY / INDIAN
- COVERS / LOCKS / TIEDOWNS
- CHEMICALS**
- TOOLS
- HELMETS
- HELMET ACC.
- EYEWEAR
- APPAREL / RIDER ACC.
- PROMOTIONAL
- REFERENCE
- INDEX



## BRAKE FLUID

- Available in DOT 4, DOT 4 Racing and DOT 5
- Advanced Glycol blends with the latest additives and an anti-vapor lock formula
- DOT Racing grade has a 600° minimum boiling point that assures fade free performance
- DOT 5 Silicone brake fluid will not harm painted surface or plastic



Description		WPS #
DOT 4	12 oz 12/case	<b>78-9967</b>
DOT 4 Racing	12 oz 24/case	<b>78-9966</b>
DOT 5 Supreme Silicone	11 oz 12/case	<b>78-9968</b>

## WATERPROOF GREASE

- Excellent resistance to water wash-out
- Smooth texture is ideal for sealing air filters
- Hi-temp formula approved for use in disc brake applications

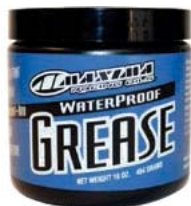

Description	WPS#
16 oz. 12/case	<b>78-9948</b>

## FUEL DE-ICER

- Eliminates moisture in fuel system
- Guards against rust and corrosion
- Safe for all gasoline; race or pump gas



Description	WPS#
8 oz 12/case	<b>78-9953</b>

## BIO WASH

- Biodegradable all-purpose cleaner
- Powerfull cleaning action on dirt, grime and oil based deposits
- Gentle enough for daily use on painted surfaces, plastic, chrome, anodizing, rubber and carbon fiber
- Micro chemistry protects aluminum, magnesium and other alloys



Description	WPS#
32 oz. 12/case	<b>78-9975</b>





**TWIN 20W50 MOTOR OIL** **NEW**

- Specially formulated, high performance, 100% triple synthetic motorcycle oil with ESTER
- Engineered to handle and protect against high temperatures found in big air-cooled Twins
- Molecular polar bonding technology enables oil to cling to metal parts, providing a protective film to help reduce wear at start-up
- Exceeds requirements for Twins with separate clutches and primary cases found on Harley-Davidson® models
- Designed to provide outstanding grip on wet clutches to prevent slippage
- High levels of ZDDP extreme pressure additives, combined with anti-oxidant and anti-foam properties
- Recommended for use in H-D Milwaukee 8®, Twin-Cam®, Evolution®, Sportster® engines and primary case.

Description	WPS#
1qt 12/case	82-2004



**TWIN 75W90 GEAR OIL** **NEW**

- An exceptionally high performance 100% synthetic transmission oil with ESTER
- Engineered for use in 4-speed, 5-speed and 6-speed transmissions
- API GL-5 rated, extreme pressure lubricant for helical or straight cut gears
- Ideally made to handle the high shock loads in Big Twin transmissions
- Molecular bonding technology enables the oil to cling to metal parts under extreme conditions
- Provides a protective film that extends the life of gears and bearings while reducing drag

Description	WPS#
1qt 12/case	82-2111



**TWIN PRIMARY OIL** **NEW**

- Engineered for use in Big Twin primary drives with wet clutches
- Provides outstanding grip for wet clutches to help prevent slippage and chatter
- Features a protective film that reduces wear and extends the life of bearings, chains and sprockets

Description	WPS#
1qt 12/case	82-2112



**TWIN GEAR AND CHAINCASE OIL** **NEW**

- Engineered to handle the combined duties of protecting the primary drive and transmission on Sportsters
- Formulated to reduce drag and provide quieter and smoother shifting while providing outstanding grip for wet clutches, helping prevent slippage and chatter
- Exceptionally high performance 100% triple synthetic oil with ESTER

Description	WPS#
1qt 12/case	82-2110

- WINDSHIELDS / FAIRINGS
- AUDIO / COMMUNICATION
- SEATS / LUGGAGE
- BARS / MIRRORS / CONTROLS
- EXHAUST
- AIR / FUEL SYSTEMS
- ENGINE
- TRANSMISSION / DRIVELINE
- GASKETS / SEALS
- ELECTRICAL
- LIGHTING
- CABLES
- BRAKES
- OIL FILTERS
- SUSPENSION
- BODY
- WHEELS
- TIRES / TIRE ACC.
- BIKE ACC.
- VICTORY / INDIAN
- COVERS / LOCKS / TIEDOWNS
- CHEMICALS**
- TOOLS
- HELMETS
- HELMET ACC.
- EYEWEAR
- APPAREL / RIDER ACC.
- PROMOTIONAL
- REFERENCE
- INDEX

# MOTUL

## 300 V 4T

- 100% Synthetic Double Ester
- Designed for highly modified engines
- Electrochemical bonding to metal parts
- Up to 5x higher film strength
- 0% shear loss on Bosch ASTM D6278 test



Description	WPS #
5W30 1 lt 12/case	<b>82-2032</b>
5W40 1 lt 12/case	<b>82-2034</b>
5W40 4 lt 4/case	<b>82-2035</b>
10W40 1 lt 12/case	<b>82-2039</b>
10W40 4 lt 4/case	<b>82-2042</b>
10W40 55 gal	<b>82-2044</b>
15W50 1 lt 12/case	<b>82-2040</b>
15W50 4 lt 4/case	<b>82-2041</b>
15W50 55 gal	<b>82-2043</b>
Oil Drum Pump	<b>27-0190</b>

**WPS PAYS 1/2 FREIGHT ON DRUMS OF OIL**

## 5100 4T

- Synthetic Blend with Ester
- Electrochemical bonding to metal parts
- Both cost effective and performance in mind
- Standards: API SJ, JASO-MA



Description	WPS#
5W30 ATV 1 qt 12/case	<b>82-2098</b>
10W30 1 lt 12/case	<b>82-2099</b>
10W40 1 qt 12/case	<b>82-2090</b>
10W40 1 gal 4/case	<b>82-2091</b>
10W40 55 gal	<b>82-2092</b>
10W50 1 lt 12/case	<b>82-2094</b>
10W50 4 lt 4/case	<b>82-2093</b>
15W50 1 qt 12/case	<b>82-2095</b>
15W50 1 gal 4/case	<b>82-2096</b>
15W50 55 gal	<b>82-2097</b>
Oil Drum Pump	<b>27-0190</b>

**WPS PAYS 1/2 FREIGHT ON DRUMS OF OIL**

## E-TECH 100

- 100% Synthetic Ester/PAO
- Formulated with performance and cite in mind
- Excellent for wet clutches, gear boxes and cams
- Electrochemical bonding to metal parts
- Good for off road applications
- Standards: API SJ, JASO-MA



Description	WPS #
10W40 1 qt 12/case	<b>82-2005</b>

## 7100 4T

- 100% Synthetic Ester
- Formulated for catalytic converters and O2 sensors
- Electrochemical bonding to metal parts
- Meets US V-twin requirements for use in all 3 compartments (20w50 only)
- Standards: API SJ, JASO-MA



Description	WPS#
5W40 1 lt 12/case	<b>82-2058</b>
5W40 4 lt 4/case	<b>82-2059</b>
10W40 1 lt 12/case	<b>82-2051</b>
10W40 4 lt 4/case	<b>82-2052</b>
10W50 1 lt 12/case	<b>82-2057</b>
10W60 1 lt 12/case	<b>82-2054</b>
10W60 4 lt 4/case	<b>82-2055</b>
20W50 1 lt 12/case	<b>82-2050</b>
20W50 4 lt 4/case	<b>82-2053</b>

## 3000 4T

- Petroleum blend
- Perfect blend of base oil and additives
- Excellent for street or offroad
- Standards: API SJ, JASO-MA



Description	WPS #
10W40 1 qt 12/case	<b>82-2014</b>
10W40 1 gal 4/case	<b>82-2015</b>
10W40 55 gal	<b>82-2016</b>
20W50 1 qt 12/case	<b>82-2020</b>
20W50 1 gal 4/case	<b>82-2021</b>
Oil Drum Pump	<b>27-0190</b>

**WPS PAYS 1/2 FREIGHT ON DRUMS OF OIL**

## TWIN SYN

- Synthetic Blend
- Specially designed for V-Twin cruisers
- Provides maximum protection, reduced wear and smoother operations
- Additive package designed for all three compartments (engine, wet clutch, gearbox)
- Standards: API SJ, JASO-MA



Description	WPS#
20W50 1 qt 12/case	<b>82-2003</b>



WINDSHIELDS / FAIRINGS  
 AUDIO / COMMUNICATION  
 SEATS / LUGGAGE  
 BARS / MIRRORS / CONTROLS  
 EXHAUST  
 AIR / FUEL SYSTEMS  
 ENGINE  
 TRANSMISSION / DRIVELINE  
 GASKETS / SEALS  
 ELECTRICAL  
 LIGHTING  
 CABLES  
 BRAKES  
 OIL FILTERS  
 SUSPENSION  
 BODY  
 WHEELS  
 TIRES / TIRE ACC.  
 BIKE ACC.  
 VICTORY / INDIAN  
 COVERS / LOCKS / TIEDOWNS  
**CHEMICALS**  
 TOOLS  
 HELMETS  
 HELMET ACC.  
 EYEWEAR  
 APPAREL / RIDER ACC.  
 PROMOTIONAL  
 REFERENCE  
 INDEX

### GEAR 300

- 100% Synthetic Ester
- Formulated with extreme pressure, anti-wear, anti-corrosion and anti-foaming additives
- Specifically designed for gear boxes without a wet clutch or hypoid rear axles
- Standards: API GL-4 and GL-5



Description	WPS #	
75W90 1 lt 12/case	82-2107	

### FORK OIL FACTORY LINE

- 100% Synthetic
- Excellent for conventional and upside down forks
- Anti-friction, anti-foam, anti-corrosion and high viscosity index



Description	WPS#	
Very light 2.5 W 1 lt 6/case	82-2118	
Light 5 W 1 lt 6/case	82-2122	
Light/Med. 7.5-5 W 1 lt 6/case	82-2124	
Medium 10 W 1 lt 6/case	82-2134	

### RBF660 RACING BRAKE FLUID

- 100% Synthetic
- One of the highest dry boiling points on the market
- Mixes with DOT 3 and 4 systems (Not DOT 5)
- Super high boiling points: Dry 617°F, Wet 399°F



Description	WPS#
1/2 lt 12/case	82-2155

### SHOCK OIL FACTORY LINE

- 100% Synthetic hydraulic fluid for racing shock absorbers
- For road and off road
- Very high viscosity index at 400



Description	WPS#	
2.5-20W 1 lt 12/case	82-2141	

### FORK OIL EXPERT

- Semi-Synthetic
- Excellent for conventional and upside down forks
- Anti-friction, anti-foam, anti-corrosion and high viscosity index

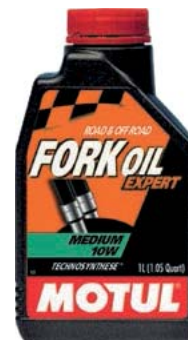

Description	WPS#	
Light 5 W 1 lt 12/case	82-2129	
Medium 10 W 1 lt 12/case	82-2131	
Medium Heavy 15 W 1 lt 12/case	82-2024	
Heavy 20 W 1 lt 12/case	82-2128	

### RBF600 RACING BRAKE FLUID

- 100% Synthetic
- Most popular brake fluid on the market
- Mixes with DOT 3 and 4 systems (Not DOT 5)
- Super high boiling points: Dry 594°F, Wet 421°F



Description	WPS#
1/2 lt 12/case	82-2156

### DOT 5.1 BRAKE FLUID

- 100% Synthetic
- Mixes with DOT 3, 4 and 5.1 systems (Not DOT 5)
- High boiling points: Dry 522°F, Wet 365°F



Description	WPS#
1/2 lt 12/case	82-2151



### CHAIN LUBE FACTORY LINE

- Specifically developed for road racing
- Compatible for o-ring, x-ring and z-ring chain
- Not recommended for off road use
- Milky in color

Description	WPS#
9.3 oz 12/case	82-2213



### CHAIN LUBE ROAD

- Super tacky to resist high speed fling
- Compatible with standard o-ring, x-ring and z-ring chain
- Colorless

Description	WPS#
9.3 oz 12/case	82-2211



### WASH & WAX

- Dry cleaner
- Carnuba wax base
- Protects and makes motorcycle paints plastics shine
- Spray on, wipe off

Description	WPS#
11.4 oz 12/case	82-2220



### CHAIN LUBE PASTE

- Excellent for road and kart use
- Very low rolling resistance for more power
- Compatible with o-ring, x-ring and z-ring chain
- Brush applicator
- White in color

Description	WPS#
5.7 oz 12/case	82-2214



### PERFECT SEAT

- Powerful cleaner and restorer for all vinyl saddles
- Non - slip formula
- UV protection to protect from sun fading

Description	WPS#
8.45 oz 12/case	82-2222



### MOTO WASH

- Powerful cleaner / degreaser
- Safe on all paint, metallic components and plastics
- Leaves a corrosion resistant film

Description	WPS#
1 lt 12/case	82-2227



### ENGINE CLEAN

- Lowers engine wear
- Decreases oil and fuel consumption
- Reduces emission and pollutants
- Reduces deposits, varnishes and other combustion residues from areas such as lifters, piston grooves and rings

Description	WPS#
6.7 oz 12/case	82-2130



- WINDSHIELDS / FAIRINGS
- AUDIO / COMMUNICATION
- SEATS / LUGGAGE
- BARS / MIRRORS / CONTROLS
- EXHAUST
- AIR / FUEL SYSTEMS
- ENGINE
- TRANSMISSION / DRIVELINE
- GASKETS / SEALS
- ELECTRICAL
- LIGHTING
- CABLES
- BRAKES
- OIL FILTERS
- SUSPENSION
- BODY
- WHEELS
- TIRES / TIRE ACC.
- BIKE ACC.
- VICTORY / INDIAN
- COVERS / LOCKS / TIEDOWNS
- CHEMICALS
- TOOLS
- HELMETS
- HELMET ACC.
- EYEWEAR
- APPAREL / RIDER ACC.
- PROMOTIONAL
- REFERENCE
- INDEX





## CHROME & ALUMINUM POLISH

- Cleans, restores and shines all chrome and aluminum

Description	WPS#	
3.38 oz 12/case	82-2224	



## INSECT REMOVER

- Removes splattered insects, organic residues and tar from wind screens, fairing, paint, metal and plastics

Description	WPS#	
13.5 oz 12/case	82-2225	



## SCRATCH REMOVER

- Removes superficial scratches on any painted or varnished surfaces
- Restores gloss shine
- Good on fairings and helmets

Description	WPS#	
3.38 oz 12/case	82-2226	



## HELMET CLEAN

- Cleans the outside of helmets leaving no marks
- Suitable for all helmets

Description	WPS#	
8.45 oz 12/case	82-2230	



## PERFECT LEATHER

- Cleans, nourishes and revives all types of leather
- Protects against external aggressions
- Makes apparel water resistant
- Prolongs the life of leather

Description	WPS#	
8.45 oz 12/case	82-2231	



## HANDS CLEAN

- Cleans hands without water
- Dissolves grease, oil and other stubborn dirt
- Non-aggressive
- Dermatological tested formula
- Does not dry out skin

Description	WPS#	
3.38 oz 12/case	82-2232	



## SHINE & GO

- Clear Coat
- Silicone base
- Restores the beautiful luster of plastics, rubber and paints
- Leaves a protective non - stick film

Description	WPS#	
13 oz 12/case	82-2223	



- WINDSHIELDS / FAIRINGS
- AUDIO / COMMUNICATION
- SEATS / LUGGAGE
- BAR / MIRRORS / CONTROLS
- EXHAUST
- AIR / FUEL SYSTEMS
- ENGINE
- TRANSMISSION / DRIVELINE
- GASKETS / SEALS
- ELECTRICAL
- LIGHTING
- CABLES
- BRAKES
- OIL FILTERS
- SUSPENSION
- BODY
- WHEELS
- TIRES / TIRE ACC.
- BIKE ACC.
- VICTORY / INDIAN
- COVERS / LOCKS / TIEDOWNS
- CHEMICALS
- TOOLS
- HELMETS
- HELMET ACC.
- EYEWEAR
- APPAREL / RIDER ACC.
- PROMOTIONAL
- REFERENCE
- INDEX



## GOLDFIRE 4-STROKE ENGINE OIL

- High performance semi-synthetic blend
- Single or multi cylinder applications
- Formulated with anti-shearing agents and friction modifiers for wet clutch applications
- Meets or exceeds API SG and JASO MA
- Good for motors with wet or dry clutches



Description	WPS#	
10W40 1 lt	6/case	57-0933
10W40 1gal	2/case	57-0934
20W50 1 lt	6/case	57-0951
20W50 1gal	2/case	57-0952

## COMPETITION FORK OIL

- High Viscosity Index formula far exceeds all OEM specifications
- Will not fade or be affected in hot or cold conditions
- Accommodates different rider weights
- Contains anti foam, anti wear agents
- Additives maximize fork seal performance



Description	WPS#	
2.5W Ultra Light .5 lt	6/case	57-0225
5W Extra Light 1 lt	6/case	57-0206
7.5W Light 1 lt	6/case	57-0208
10W Light 1 lt	6/case	57-0211
15W Light Med. .5 lt	6/case	57-0215
1 lt	6/case	57-0216
20W Medium .5 lt	6/case	57-0220
1 lt	6/case	57-0221
30W Heavy .5 lt	6/case	57-0230
1 lt	6/case	57-0231

## FOG BLOCKER

- Specifically formulated to prevent fogging under the most extreme environments
- Increase safety through increased visibility

Size	WPS#	
4 oz pump	12/case	57-0254



## SILVERFIRE 4-STROKE ENGINE OIL

- Meets or exceeds API SG, JASO MA
- Low coefficient of friction increases power and engine efficiency
- Shear stable viscosity improver protects against viscosity breakdown
- Keeps engine clean and protects against varnish and sludge formation
- Good for motors with wet or dry clutches



Description	WPS#	
10W40 1 lt	6/case	57-0935
10W40 1gal	2/case	57-0936
20W50 1 lt	6/case	57-0954

## FABRIC AIR FILTER OIL

- Improves performance of all gauze-type filters
- Filters airborne debris while repelling water
- Formulated dye lets you see need for service
- Super tacky
- Red in color for ease coverage

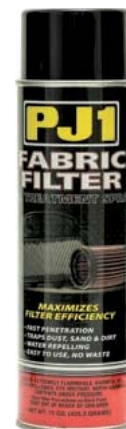

Description	Size	WPS#	
Fabric Air Filter Oil	15 oz aerosol	6/case	57-0420
Fabric Filter Care Kit (Cleaner and Oil)	13oz cleaner 15oz oil	3/case	57-1524

## CLEANERS & DEGREASERS



Description	Size	WPS#	
Super Cleaner	13 oz aerosol	6/case	57-0320
CALIFORNIA Super Cleaner	13 oz aerosol	6/case	57-0321
Injector/Carb	12 oz	6/case	57-1312
<b>DEGREASER</b>			
Spray & Wash	17 oz aerosol	12/case	57-1520

**PRO-ENVIRO SHOP CHEMICALS**

No Chlorinated Solvents to Destroy the Environment



**CARBURETOR AND CHOKE CLEANER**

- Ideal for quick cleaning of injectors, carburetors, jets and linkage
- High power spray, not harmful to rubber, vinyl or plastic
- May be harmful to painted surfaces

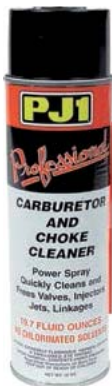

**BRAKE CLEANER**

- Cleans and degreases all brake units
- Evaporates quickly without residue
- Will not harm rubber, plastic or painted surfaces



**CONTACT CLEANER**

- Removes carbon and contaminants from electrical components
- Evaporates quickly without residue
- Will not harm rubber, plastic or painted surfaces



Description	Size	WPS#
Contact Cleaner	19.7 oz aerosol	6/case <b>57-0403</b>
CALIFORNIA Contact Cleaner	19.7 oz aerosol	6/case <b>57-04031</b>
Brake Cleaner	19.7 oz aerosol	6/case <b>57-0402</b>
CALIFORNIA Brake Cleaner	19.7 oz aerosol	6/case <b>57-04021</b>
Carb & choke cleaner	19 oz aerosol	6/case <b>57-0401</b>

**BLACK LABEL CHAIN LUBE**

- Penetrates deep into the chain
- Lubricates pins, rollers, side plates, and sprocket
- Reduces chain stretch and the requirement for frequent adjustments
- Protects chain against the elements



**BLUE LABEL**

- Clear formula won't fly off
- Displaces and repels water
- Reduces chain stretch and the requirement for frequent adjustments
- Lubricates between roller and sprocket
- Preserves O-Rings
- Can also be used on standard chains



Description	Size	WPS#
<b>BLACK LABEL CHAIN LUBE</b>		
Black label	6 oz aerosol	12/case <b>57-0106</b>
Black label	17 oz aerosol	6/case <b>57-0120</b>

Description	Size	WPS#
<b>BLUE LABEL CHAIN LUBE</b>		
Blue Label	5 oz aerosol	12/case <b>57-0108</b>
Blue Label	17 oz aerosol	6/case <b>57-0122</b>

**LUBES**



Description	Size	WPS#
All Purpose Lube	11 oz aerosol	6/case <b>57-0110</b>
Assembly Lube	11 oz aerosol	6/case <b>57-0111</b>
Cable Lube	11 oz aerosol	6/case <b>57-0112</b>

**GAS ENERGIZER OCTANE PLUS**

Description	WPS#
18 oz	6/case <b>57-1316</b>



WINDSHIELDS / FAIRINGS  
 AUDIO / COMMUNICATION  
 SEATS / LUGGAGE  
 BARS / MIRRORS / CONTROLS  
 EXHAUST  
 AIR / FUEL SYSTEMS  
 ENGINE  
 TRANSMISSION / DRIVELINE  
 GASKETS / SEALS  
 ELECTRICAL  
 LIGHTING  
 CABLES  
 BRAKES  
 OIL FILTERS  
 SUSPENSION  
 BODY  
 WHEELS  
 TIRES / TIRE ACC.  
 BIKE ACC.  
 VICTORY / INDIAN  
 COVERS / LOCKS / TIEDOWNS  
**CHEMICALS**  
 TOOLS  
 HELMETS  
 HELMET ACC.  
 EYEWEAR  
 APPAREL / RIDER ACC.  
 PROMOTIONAL  
 REFERENCE  
 INDEX



**PAINTS**  
11 oz aerosol - 6/case

**FAST BLACK GLOSS BLACK ENGINE PAINT**

- Withstands up to 500°F (260°C)

**FAST BLACK SATIN BLACK ENGINE PAINT**

- Withstands up to 500°F (260°C)

**FAST BLACK FLAT BLACK EXHAUST**

- Withstands 1500°F (816°C)

**FAST BLACK EPOXY PORCELAIN GLOSS BLACK**

- Dries to an extremely hard and durable finish

**FAST BLACK WRINKLE FINISH TEXTURE COAT**

- Withstands 350°F (177°C)

- Has wrinkle textured finish

**CLEAR COAT EPOXY**

- Won't yellow



Description	WPS#
Honda red '88-89 •	6/case <b>57-10171</b>
Kawasaki green '88-02	6/case <b>57-10174</b>
Yamaha blue '98-06	6/case <b>57-10191</b>
Primer lt grey	6/case <b>57-10180</b>
Primer white	6/case <b>57-10181</b>
Fast Black Gloss Black engine paint	6/case <b>57-0160</b>
Fast Black, 1500F high temp flat finish	6/case <b>57-0161</b>
Fast Black Satin, black engine paint	6/case <b>57-0162</b>
Fast Black Epoxy, porcelain gloss black	6/case <b>57-0163</b>
Fast Black Wrinkle Finish, texture coat	6/case <b>57-0164</b>
Clear Coat Epoxy	6/case <b>57-0179</b>

- USE 57-10181 primer
- USE 57-10180 primer

**TRACKBITE TRACTION COMPOUND**

- Custom formulated resin that provides controlled traction for competition racing
- A water resistant liquid for track and tire which improves traction on asphalt and concrete surfaces
- It achieves added traction by means of adhesion and does change tire compounds
- NHRA & IHRA approved
- Ideal for drag and other race applications

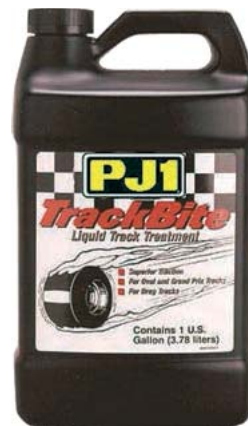

Description	WPS#
1 gal 2/case	<b>57-0140</b>

**WHEELY BAR SPRAY CHALK**

- Has been developed to replace messy shoe polish
- Commonly used on Wheely bar wheels in drag racing
- Effectively helps in determining chassis and clutch adjustments
- Available in white only.



Description	WPS#
10 oz aerosol 6/case	<b>57-0145</b>

## 20W50 MOTOR OIL

- Blended with specific friction modifiers that are compatible with wet-clutches, suitable for JASO MA applications
- Extended drain intervals over other brands due to higher quality basestocks and excellent dispersants
- Designed for the latest Big-Twin motorcycle engines that specify 20W50 motor oil, including Evolution, Twin Cam, and aftermarket engines of similar design
- Superior film strength through the use of ester base stocks for protection and ring seal



Description	WPS#
1 qt 12/case	57-6531
55 gal	57-6537

WPS PAYS 1/2 FREIGHT ON DRUMS OF OIL

## V-TWIN PRIMARY OIL

- Same fluid as our famous MTL gear oil
- This product is for use in the primary chaincase with wet-diaphragm spring clutches.
- Improves clutch operation while reducing wear and temperature
- For 1984-to-present V-Twin American motorcycle engines, including Evolution, Twin Cam, and aftermarket engines of similar design
- Where most synthetics are too slippery for clutch operation, this friction-balanced product is balanced to provide less slip, smoother operation, and helps to apply more power in modified engines



Description	WPS#
1 qt 12/case	57-6522

## FUNNEL

- That funnel that works
- Rotate around to get into those extremely difficult areas
- Works with all fluids

WPS#  
57-6599



## 20W60 MOTOR OIL

- Recommended for V-twins that need more viscosity due to operation in extremely hot climates.
- Popular for Evos and Twin Cam engines with big bore kits, stroker kits or issues with valvetrain noise
- Specifically blended for air-cooled V-Twin engines with traditionally wide clearances like Knuckleheads, Shovelheads and Panheads
- Superior film strength through the use of ester base stocks for protection and ring seal
- Extended drain intervals over other brands due to higher quality base stocks and excellent dispersants



Description	WPS#
1 qt 12/case	57-6532
55 gal	57-6538

WPS PAYS 1/2 FREIGHT ON DRUMS OF OIL

## V-TWIN TRANNY OIL

- This product dampens transmission noise (reducing the notorious shifting clunk found in these gearboxes), dramatically reduces temperature, provides thicker oil films between gear teeth and resists throw-off
- For all aftermarket versions like Baker, JIMS, S&S, etc.
- For all H-D® trans including with Evolution engines, Twin Cam engines, and latest 6-speed Cruise Drive
- Same fluid as our unique Heavy ShockProof® Gear Oil



Description	WPS#
1 qt 12/case	57-6521

## 80W GEAR OIL

- Popular for Sportster V-Twin transmissions
- ShockProof® features microscopic solid medium to provide cushioning between gear teeth, while maintaining lower drag
- Provides consistent shifting and wet-clutch operation



Description	WPS#
1 qt 12/case	57-6520

- WINDSHIELDS / FAIRINGS
- AUDIO / COMMUNICATION
- SEATS / LUGGAGE
- BAR / MIRRORS / CONTROLS
- EXHAUST
- AIR / FUEL SYSTEMS
- ENGINE
- TRANSMISSION / DRIVELINE
- GASKETS / SEALS
- ELECTRICAL
- LIGHTING
- CABLES
- BRAKES
- OIL FILTERS
- SUSPENSION
- BODY
- WHEELS
- TIRES / TIRE ACC.
- BIKE ACC.
- VICTORY / INDIAN
- COVERS / LOCKS / TIEDOWNS
- CHEMICALS**
- TOOLS
- HELMETS
- HELMET ACC.
- EYEWEAR
- APPAREL / RIDER ACC.
- PROMOTIONAL
- REFERENCE
- INDEX



## POWERPACKS

- Complete kit for Big Twins with either 20W50 or 20W60 motor oil
- Includes 5 quarts of Motorcycle Oil, 1 quart of V-Twin Transmission Oil with ShockProof, 1 quart of Primary Chain Case Oil, 1 bottle of Fuel Injection Cleaner for Motorcycles, a sticker kit, a Red Line Oil embroidered hat, and a versatile funnel



Description	WPS#
20W50	57-6560
20W60	57-6561

## SYNTHETIC DOT 4 BRAKE FLUID

- Engineered to maintain viscosity and lubricity at extreme temperatures
- Safeguards against vapor lock and brake fading
- Blends with and meets specifications of DOT 3, DOT 4, DOT 5.1
- 604 degrees Fahrenheit dry, 400 degrees Fahrenheit wet



Description	WPS#
DOT 4 16 oz 6/case	57-6575

## SUSPENSION FLUID

- Superior shear stability over most popular shock oils
- Allows use of lower viscosities
- Far less shock fade, provides lower operating temps for same viscosity when compared to conventional fluids
- Eliminates most foaming and provides excellent seal lubricity
- Anti-wear additives assist in longer shock life
- These products can be mixed together to create intermediate viscosities, customized for a dampener's particular characteristics



Description	WPS#
Likewater 16 oz 12/case	57-6550
2.5W16 oz 12/case	57-6551
5W16 oz 12/case	57-6552
10W16 oz 12/case	57-6553
30W16 oz 12/case	57-6554

## ASSEMBLY LUBE

- Prepares potential wear surface and prevents metal contact before adequate lubrication can be supplied
- Unlike other assembly lubes, Red Line's will not plug filters after initial engine start-up
- Provides 3x greater film strength than conventional black Molybdenum Disulfide greases
- Excellent rust and corrosion inhibitor, allows for long-term storage
- For use on camshafts, lifters, pushrods, piston skirts, main and rod bearings, and bolt threads
- Do not use on exhaust bolts or other high temperature bolts which require an anti-seize
- Recommended and used by top camshaft and drivetrain manufacturers



Description	WPS#
4 oz 12/case	57-6565
12 oz 6/case	57-6566

## FUEL SYSTEM CLEANER

- Concentrated, high-temp detergents clean your carburetors or fuel injectors, fuel lines, tank, intake valves, combustion chambers, fouled plugs
- Improves fuel economy, throttle response, hesitation and stalling
- Compatible with both pump gas and race fuel, pre-mixed or injected two-strokes
- Cleans deposits on intake valves and combustion chambers, lubricates upper cylinder
- Reduces octane demand and regain lost power and improve fuel economy
- Cleans emission control systems (safe for the latest catalytic converters and sensors)



Description	WPS#
4 oz 12/case	57-6545

## 4 CYCLE LUBRICATION



### T4SR MPZ 100% SYNTHETIC ENGINE OIL

- A combination of the best synthetic based oils, shear stable-ring sealing polymers and MPZ additives
- Withstands high temperatures and RPMs without fluid film breakdown
- Provides the ultimate in protection, performance and cleanliness
- Increases horsepower and RPM while improving shifting



Description	WPS#
10W40 1 lt 12/case	<b>88-6070</b>
20W50 1 lt 12/case	<b>88-6071</b>

### T4 PETROLEUM MOTORCYCLE OIL

- Specially formulated for high-performance 4-cycle motorcycles, which place exceptional demands on motor oils
- Provides greater lubrication at higher RPMs and at high operating temperatures
- Resists shearing action of the transmission



Description	WPS#
10W30 1 lt 12/case	<b>88-6051</b>
10W40 1 lt 12/case	<b>88-6054</b>
10W40 55 gal	<b>88-6052</b>
20W50 1 lt 12/case	<b>88-6055</b>
20W50 55 gal	<b>88-6053</b>
Oil Drum Pump	<b>27-0190</b>

### TR-1 MPZ MOTORCYCLE ENGINE OIL

- The ultimate petroleum base high performance oil designed for motorcycles
- Formulated with Torco's exclusive synthetic viscosity improver and race proven MPZ additive
- MPZ provides better cooling, cleaning, ring sealing and wear protection



Description	WPS#
10W40 1 lt 12/case	<b>88-6030</b>
20W50 1 lt 12/case	<b>88-6032</b>
10W40 55 gal	<b>88-6031</b>
Oil Drum Pump	<b>27-0190</b>

### T-4MXR/T-4R SYNTHETIC/PETROLEUM BLEND

- New generation of MPZ racing oil with an unmatched formula of synthetic and petroleum based oils, polymers and performance additives
- Flows freely in a cold engine and maintains a heat resistant oil film when hot
- Reduces piston scuffing, valve train wear and maintains better ring sealing



\* T-4MXR Recommended for Offroad 4-Stroke racing engines

Description	WPS#
10W40 1 lt T-4R 12/case	<b>88-6062</b>
20W50 1 lt T-4R 12/case	<b>88-6063</b>
15W40 1 lt T-4MXR 12/case	<b>88-6064*</b>

**WPS PAYS 1/2 FREIGHT ON DRUMS OF OIL**

### ENGINE OIL

- Formulated using highly stable hydrocracked base stocks and our race proven MPZ additive providing better cooling, cleaning, ring scaling, deposit control and wear protection
- Special additive components maintain viscosity and provide thermal stability under high heat environments found in air-cooled V-twin engines



Description	WPS#
20W50 1 lt 12/case	<b>88-6086</b>
50W 1 lt 12/case	<b>88-6087</b>
60W 1 lt 12/case	<b>88-6089</b>

### TRANS LUBE

- V-Series Trans Lube is a selective blend of synthetic and petroleum-based oils designed to protect all gear face surfaces and bearing compounds
- Race-proven extreme pressure and anti-friction chemistry promotes the highest degree of protection for extended transmission life
- This shear stable formula also provides smooth shifting and prevents the formation of rust and oxidation



Description	WPS#
75W90 1 lt 12/case	<b>88-6195</b>

- WINDSHIELDS / FAIRINGS
- AUDIO / COMMUNICATION
- SEATS / LUGGAGE
- BAR / MIRRORS / CONTROLS
- EXHAUST
- AIR / FUEL SYSTEMS
- ENGINE
- TRANSMISSION / DRIVELINE
- GASKETS / SEALS
- ELECTRICAL
- LIGHTING
- CABLES
- BRAKES
- OIL FILTERS
- SUSPENSION
- BODY
- WHEELS
- TIRES / TIRE ACC.
- BIKE ACC.
- VICTORY / INDIAN
- COVERS / LOCKS / TIEDOWNS
- CHEMICALS
- TOOLS
- HELMETS
- HELMET ACC.
- EYEWEAR
- APPAREL / RIDER ACC.
- PROMOTIONAL
- REFERENCE
- INDEX

WINDSHIELDS / FAIRINGS  
 AUDIO / COMMUNICATION  
 SEATS / LUGGAGE  
 BARS / MIRRORS / CONTROLS  
 EXHAUST  
 AIR / FUEL SYSTEMS  
 ENGINE  
 TRANSMISSION / DRIVELINE  
 GASKETS / SEALS  
 ELECTRICAL  
 LIGHTING  
 CABLES  
 BRAKES  
 OIL FILTERS  
 SUSPENSION  
 BODY  
 WHEELS  
 TIRES / TIRE ACC.  
 BIKE ACC.  
 VICTORY / INDIAN  
 COVERS / LOCKS / TIEDOWNS  
**CHEMICALS**  
 TOOLS  
 HELMETS  
 HELMET ACC.  
 EYEWEAR  
 APPAREL / RIDER ACC.  
 PROMOTIONAL  
 REFERENCE  
 INDEX



## PRIMARY CHAINCASE LUBRICANT

- V-Series Primary Chaincase Lubricant is a synthetic and petroleum-based fluid designed to protect all critical drive components found in Harley® and aftermarket primary chaincases
- Selective blend of extreme pressure and anti-friction additives provide the highest degree of protection as well as smooth positive clutch operation



Description	WPS#
1 lt 12/case	<b>88-6191</b>

## RFF RACING FORK FLUID

- Designed to exceed the demands of all cartridge and conventional fork applications
- This high VI synthetic blend formula features the best anti-stiction technology and promotes consistent dampening under the most extreme temperature conditions
- Best protection against foaming, seal swell, oxidation, corrosion, friction and wear



Description	WPS#
5W 1 lt 12/case	<b>88-6100</b>
5W 5 gal	<b>88-6105</b>
7W 1 lt 12/case	<b>88-6101</b>
10W 1 lt 12/case	<b>88-6102</b>
15W 1 lt 12/case	<b>88-6103</b>
20W 1 lt 12/case	<b>88-6104</b>
Pump for 5 gal pail	<b>78-9829</b>

## MGO HYPOID GEAR OIL

- A blend of the finest synthetic and petroleum base oils and polymers with extreme pressure, anti-wear, anti-foam and anti-oxidant additives
- For use when heat, speed and shear are critical factors



Description	WPS#
80W90 1 lt 12/case	<b>88-6181</b>

## RSF RACING SHOCK FLUID

- Viscosity controlled formula for the highest degree of consistency
- Extreme anti-wear, anti-friction, anti-foam and anti-oxidation protection
- Extends seal life



Description	WPS#
Light 1 lt 12/case	<b>88-6141</b>
Light 5 gal	<b>88-6145</b>
Light 55 gal	<b>88-6147</b>
Medium 1 lt 1 2/case	<b>88-6140</b>
Medium 5 gal	<b>88-6144</b>
Medium 55 gal	<b>88-6146</b>
Oil Drum Pump	<b>27-0190</b>

## ACCELERATOR RACE FUEL CONCENTRATE

- A blend of components which transforms the make up of premium pump gas to closely resemble race fuel
- Significantly raises the octane of premium fuel (91 octane): 32 oz To 10 gals = 102 octane, 32 oz to 5 gals of fuel = 105 octane!
- Will not harm sensitive O2 sensors or catalytic converters
- Great for motorcycle, ATV, snowmobile, watercraft and automotive use



Description	WPS#
32 oz 12/case	<b>88-6325</b>





## TITANIUM CHAIN LUBE

- Eliminates "Fling off"
- Formulated with anti-rust chemistry
- Extreme pressure and shear stable formula
- Designed for all standard, O-ring and racing chains

Description	WPS#
5.5 oz 12/case	88-6311
13 oz 12/case	88-6312



## BRAKE/CONTACT CLEANER

- Effectively removes brake fluid, oil and greases
- For use on brakes, electrical components and all metal surfaces
- Quick drying with no residue
- Noncorrosive and nonstaining

Description	WPS#
13 oz 12/case	88-6315



## MOTO-PREP SILICON SPRAY

- Revives dull faded surfaces to dry shiny finish
- Formulated for use on plastic, painted, fiberglass and metal surfaces providing a long lasting shine
- Highly recommended for the underside

Description	WPS#
19 oz 12/case	88-6306



## MPZ SPRAY LUBE

- Same qualities as the MPZ engine assembly lube in the convenience of an aerosol spray
- Heat proof, wear proof, rust proof
- Unique high tech multi purpose lubricant that stays put and won't let go

Description	WPS#
5.4 oz 12/case	88-6305



## MPZ ENGINE ASSEMBLY LUBE

- Friction proof, wear proof, corrosion proof, water proof
- Excellent lube for engine assembly. Use on wrist pins, bearings, bushings and gears

Description	WPS#
4oz tube 12/case	88-6300



## MPZ CAM LUBE

- Recommended as a pre-lube for engine assembly
- For coating cams, rocker arms, valves and springs
- Same formula as engine assembly lube in a thicker viscosity

Description	WPS#
1oz tube 12/case	88-6308



## WATERPROOF GREASE

- Lithium complex grease offers excellent lubricating properties
- Race proven formula is designed to protect against shock loading, extreme pressure and water washout

Description	WPS#
8oz tube 12/case	88-6307

- WINDSHIELDS / FAIRINGS
- AUDIO / COMMUNICATION
- SEATS / LUGGAGE
- BARS / MIRRORS / CONTROLS
- EXHAUST
- AIR / FUEL SYSTEMS
- ENGINE
- TRANSMISSION / DRIVELINE
- GASKETS / SEALS
- ELECTRICAL
- LIGHTING
- CABLES
- BRAKES
- OIL FILTERS
- SUSPENSION
- BODY
- WHEELS
- TIRES / TIRE ACC.
- BIKE ACC.
- VICTORY / INDIAN
- COVERS / LOCKS / TIEDOWNS
- CHEMICALS
- TOOLS
- HELMETS
- HELMET ACC.
- EYEWEAR
- APPAREL / RIDER ACC.
- PROMOTIONAL
- REFERENCE
- INDEX



## BIG BIKE WASH

- Hog Wash Brand Big Bike Wash has got you covered
- This proprietary formula removes grease, bugs, dirt and road grime
- Leaves a shine better than any of the competitors
- With its spray on, rinse off, no scrub formula you will be out cruising
- Safe for all bike surfaces when used as directed
- Non-corrosive and biodegradable



Description	WPS#	
22oz	12/case	80-0280
1gal	4/case	80-0281

## SWINE SHINE

- Cleans and shines all surfaces SAFELY and QUICKLY without using water
- Good on painted surfaces, windshields, chrome, aluminum, fiberglass rubber and laminated graphics
- No need for scrubbing, rinsing or drying
- This great smelling formula contains no harsh solvents
- Fortified with Polyseal Protection
- Give your bike a deep rich shine that protects from UV damage
- Protects against acid rain, and water spotting
- Its high lubricating agents encapsulate dirt and grime for easy removal



Description	WPS#	
4oz	12/case	80-0282
22oz	12/case	80-0283

## WINDSHIELD CLEANER & PROTECTANT

- High tech blend of surfactant cleaners and polymers
- Cleans and protects your windshields in one easy step
- Advanced polymers repels rain, prevent bugs from sticking and eliminate fingerprints
- Leaves a finish unequaled by other products
- Prevents fogging and safely cleans without scratching
- Safe for all windshield surfaces including polycarbonate and Lexan®



Description	WPS#	
4oz	12/case	80-0286

## MATTE FINISH CLEANER & PROTECTANT

- Cleans all matte, denim and carbon fiber surfaces SAFELY and QUICKLY
- No water needed, no scrubbing, rinsing or drying!
- Contains no harsh solvents
- Fortified with Polyseal, shields surfaces from UV damage
- Protects against acid rain, water spotting and fingerprints
- Just spray on, wipe, and you're done
- Good for all painted surfaces, anodizes, powder coated, chrome, aluminum, fiberglass, plastic, rubber and windshields



Description	WPS#	
8oz	12/case	80-0287



## MELT MAGIC BURN REMOVER

- A fast and easy answer to removing unsightly burn marks
- Caused by rubber and plastic that has been melted onto exhaust pipes and motors from boots or rain gear
- Safely and effectively removes debris without damaging bike surfaces or chrome pipes



Description	WPS#
4oz 12/case	80-0290

## METAL POLISH

- Thick no-run formula that stays where you want it
- Cleans, polishes and preserves most metal surfaces
- Good for chrome, aluminum, brass, nickel, stainless steel, bronze, copper, magnesium, platinum
- Contains white jewelers rouge that makes billet aluminum shine like chrome
- Not for use on clear coated or anodized surfaces



Description	WPS#
8oz 12/case	80-0291

## BLACK BACK

- Advanced silicone product that is the perfect finishing touch
- A great melon scented spray quickly brightens, protects and restores
- Good for paint, plastics, vinyl and rubber
- Contains no ozone depleters or chlorinated solvents
- Prevents dirt from adhering to treated surfaces



Description	WPS#
12oz 12/case	80-0292

## PIG GREASE

- Retards rust, repels moisture, lubricates and penetrates rust on any metal
- Harmless to paint, plastics, rubber or fabric
- Does not contain silicones
- Good for motorcycle, automotive, boat and marine equipment
- Ideal for sporting goods or household items
- Dries out wet ignition systems and motors, stops battery corrosion, and loosens rusty bolts
- Use on fishing tackle, guns, tools or any metal item where lubrication or rust and corrosion protection is needed



Description	WPS#
11oz 12/case	80-0293

## MICROFIBER DETAILING CLOTHS

- 16" x 16"
- Non-electrostatic, super absorbent, hypoallergenic, lint free and non-abrasive
- Reusable and machine washable

Description	WPS#
2 Pack 12/case	80-0299



- WINDSHIELDS / FAIRINGS
- AUDIO / COMMUNICATION
- SEATS / LUGGAGE
- BARS / MIRRORS / CONTROLS
- EXHAUST
- AIR / FUEL SYSTEMS
- ENGINE
- TRANSMISSION / DRIVELINE
- GASKETS / SEALS
- ELECTRICAL
- LIGHTING
- CABLES
- BRAKES
- OIL FILTERS
- SUSPENSION
- BODY
- WHEELS
- TIRES / TIRE ACC.
- BIKE ACC.
- VICTORY / INDIAN
- COVERS / LOCKS / TIEDOWNS
- CHEMICALS
- TOOLS
- HELMETS
- HELMET ACC.
- EYEWEAR
- APPAREL / RIDER ACC.
- PROMOTIONAL
- REFERENCE
- INDEX

- WINDSHIELDS / FAIRINGS
- AUDIO / COMMUNICATION
- SEATS / LUGGAGE
- BARS / MIRRORS / CONTROLS
- EXHAUST
- AIR / FUEL SYSTEMS
- ENGINE
- TRANSMISSION / DRIVELINE
- GASKETS / SEALS
- ELECTRICAL
- LIGHTING
- CABLES
- BRAKES
- OIL FILTERS
- SUSPENSION
- BODY
- WHEELS
- TIRES / TIRE ACC.
- BIKE ACC.
- VICTORY / INDIAN
- COVERS / LOCKS / TIEDOWNS
- CHEMICALS**
- TOOLS
- HELMETS
- HELMET ACC.
- EYEWEAR
- APPAREL / RIDER ACC.
- PROMOTIONAL
- REFERENCE
- INDEX



## LEATHER CLEANER & PROTECTANT

- A one step advanced formula for cleaning, restoration and protection
- When dry it leaves a transparent, non-slippery, and water repellent gloss coating
- Beautifies and restores surfaces
- UV protection ingredients helps to prevent drying, cracking and fading



Description	WPS#	
4oz	12/case	80-0284
22oz	12/case	80-0285

## COMPLETE FUEL TREATMENT

- Reduces problems caused by ethanol and non ethanol fuels
- Removes water from fuel
- Increases horsepower
- Stabilizes fuel for up to 36 months
- 1 oz treats up to 10 gallons of fuel, boosts octane up to 4 points

Description	WPS#	
1oz	80-0296	



Description	WPS#	
4oz	80-0297	





## STREET BIKE CLEANING AND DETAIL KIT

- Attractively packaged in a retail quality box
- A great gift idea

**Kit contains:**

- 1-32 oz bottle of Street Bike Wash
- 1-14 oz can of Spray Cleaner and Polish
- 1-8 oz bottle of Metal Polish
- 1-2 pack of Micro-fiber detailing cloths

Description	WPS#
Cleaning and detail kit	12/case <b>80-0240</b>

## DETAILING KITS

**Quick Detailing Kit contains:**

- 1-14 oz can of Spray Cleaner and Polish
- 1-2 pack of Micro-fiber detailing cloths



Description	WPS#
Quick Detailing Kit	8/case <b>80-0224</b>
Roadside Detailing Kit	6/case <b>80-0225</b>

**Roadside Detailing Kit contains:**

- 1-5 oz can of Spray Cleaner and Polish
- 1 Micro-fiber detailing cloth



## CLEANER AND POLISH

- Formulated to remove road grime, dirt, grease and bugs on contact
- This roadside detailer with its spray on, wipe-off formula requires no water and leaves a showroom shine
- Protects against sun and ozone damage, safe for all surfaces

Description	WPS#
5oz	12/case <b>80-0218</b>
14oz	12/case <b>80-0219</b>

- WINDSHIELDS / FAIRINGS
- AUDIO / COMMUNICATION
- SEATS / LUGGAGE
- BAR / MIRRORS / CONTROLS
- EXHAUST
- AIR / FUEL SYSTEMS
- ENGINE
- TRANSMISSION / DRIVELINE
- GASKETS / SEALS
- ELECTRICAL
- LIGHTING
- CABLES
- BRAKES
- OIL FILTERS
- SUSPENSION
- BODY
- WHEELS
- TIRES / TIRE ACC.
- BIKE ACC.
- VICTORY / INDIAN
- COVERS / LOCKS / TIEDOWNS
- CHEMICALS
- TOOLS
- HELMETS
- HELMET ACC.
- EYEWEAR
- APPAREL / RIDER ACC.
- PROMOTIONAL
- REFERENCE
- INDEX

- WINDSHIELDS / FAIRINGS
- AUDIO / COMMUNICATION
- SEATS / LUGGAGE
- BAR / MIRRORS / CONTROLS
- EXHAUST
- AIR / FUEL SYSTEMS
- ENGINE
- TRANSMISSION / DRIVELINE
- GASKETS / SEALS
- ELECTRICAL
- LIGHTING
- CABLES
- BRAKES
- OIL FILTERS
- SUSPENSION
- BODY
- WHEELS
- TIRES / TIRE ACC.
- BIKE ACC.
- VICTORY / INDIAN
- COVERS / LOCKS / TIEDOWNS
- CHEMICALS
- TOOLS
- HELMETS
- HELMET ACC.
- EYEWEAR
- APPAREL / RIDER ACC.
- PROMOTIONAL
- REFERENCE
- INDEX



## STREET WASH

- Premium street bike wash has got you covered with a secret formula that removes grease, dirt and road grime better than any other competition
- Non-corrosive, biodegradable and safe for all surfaces



Description	WPS#
32 oz 12/case	80-0211
1 gal 4/case	80-0212

## BLACK STREAK REMOVER

- No-scrub, spray on, wipe off formula
- Quickly and easily removes those hard to clean black streaks
- Spray on soiled area and wipe clean with a clean wet cloth or sponge
- Works great on fiberglass, aluminum and all painted surfaces



Description	WPS#
32oz 12/case	80-0270
1 gal 4/case	80-0271

## TOPKOTE

- Topkote finishing spray is an advanced silicone product that is finishing tough
- Quickly treats plastics, vinyl, rubber and more
- Helps prevent mud and dirt from sticking to treated surfaces



Description	WPS#
12 oz 12/case	80-0221

## LP-33 PENETRATING LUBRICANT

- Retards rust, drives out moisture
- Lubricates and penetrates rust on any metal
- Wont harm paint, plastics, rubber or fabric
- Contains no silicones



Description	WPS#
11oz 12/case	80-0258

## CYCLE WASH

- Cycle Wash is a surfactant based formula that lifts dirt from the surface and leaves a shine unequaled by any other cleaner
- Safe for all of today's high tech metal or plastic offroad motorcycle surfaces
- Non-corrosive and biodegradable



Description	WPS#
32 oz 12/case	80-0200
1 gal 4/case	80-0201
5 gal pail	80-0203

## RDX RUBBER & ADHESIVE REMOVER

- RDX is an environmentally friendly cleaner
- Removes adhesive residue, rubber, soils and grease



Description	WPS#
15 oz 12/case	80-0233

## CONTACT CLEANER

- Concentrated blend of solvents removes grease, grime, brake fluid and other contaminants from brake components
- Evaporates instantly and completely, leaving no residue to hinder performance
- VOC compliant



Description	WPS#
14oz 12/case	80-0230



- WINDSHIELDS / FAIRINGS
- AUDIO / COMMUNICATION
- SEATS / LUGGAGE
- BAR / MIRRORS / CONTROLS
- EXHAUST
- AIR / FUEL SYSTEMS
- ENGINE
- TRANSMISSION / DRIVELINE
- GASKETS / SEALS
- ELECTRICAL
- LIGHTING
- CABLES
- BRAKES
- OIL FILTERS
- SUSPENSION
- BODY
- WHEELS
- TIRES / TIRE ACC.
- BIKE ACC.
- VICTORY / INDIAN
- COVERS / LOCKS / TIEDOWNS
- CHEMICALS**
- TOOLS
- HELMETS
- HELMET ACC.
- EYEWEAR
- APPAREL / RIDER ACC.
- PROMOTIONAL
- REFERENCE
- INDEX

## POLY WAX

- Provides long lasting protection from dirt, road salts, detergents and oxidation
- Easy to use formula delivers a deep, wet-looking high-gloss shine
- No white residue of traditional waxing
- Provides months of protection in one easy step



Description	WPS#
8oz 12/case	80-0259

## METAL POLISH

- Cleans, polishes and preserves most metal surfaces
- Works great on chrome, aluminum, brass, nickel, stainless steel, bronze, copper, magnesium, platinum and more



Description	WPS#
8 oz 12/case	80-0223

## PAINT POLISH

- Swirl mark reducer and gloss enhancing polish
- Restores full gloss after compounding or to remove fine scratches, swirl marks or light oxidation
- Apply by hand or machine
- Contains no silicone, fillers or waxes and is clearcoat safe



Description	WPS#
8oz 12/case	80-0260

## MICRO FIBER DETAILING CLOTHS

- Detailing cloths feature a soft surface that is ideal for high quality cleaning and detailing
- Can absorb up to seven times their weight in water
- Perfect for use in drying or polishing any reflective surface



Description	WPS#
2 per pack 12/case	80-0220

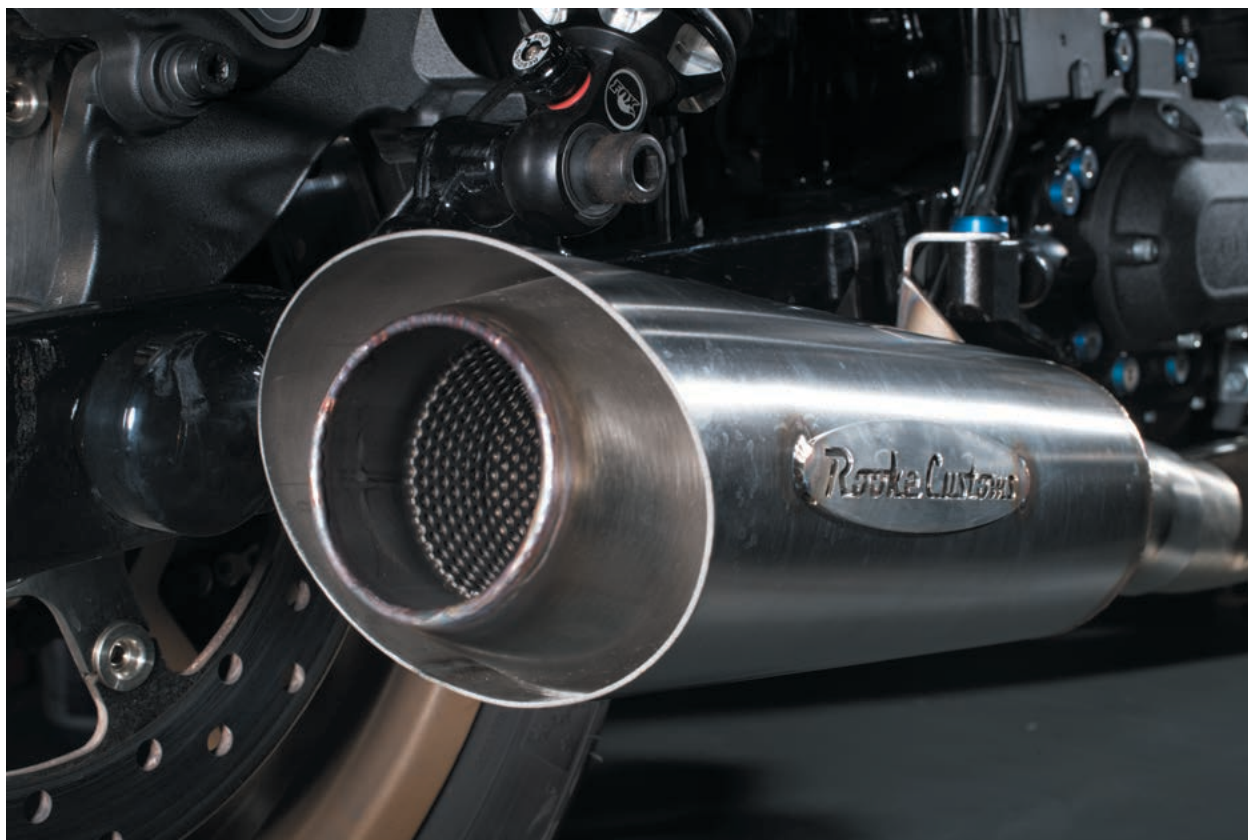



## POLISHING STRIPS

- Great for polishing aluminum, stainless steel, brass, copper, magnesium and most any other bare metal surface
- Long strips allow you to polish 360° around tubing so you don't miss a spot
- Narrow strips include 14 strips (½" x 16")
- Combo strips include 4 narrow strips, 3 medium strips (¾" x 20"), and 6 wide strips (1¼" x 26")



Description	WPS#
Narrow strips	58-9150
Combo strips	58-9151

## LUSTER PAD

- Great for polishing aluminum, stainless steel, brass, copper, magnesium and most any other bare metal surface
- Pad measures ¾" x 5"



Description	WPS#
Luster Pad	58-9155

## LUSTER COMBO KITS

- Kit A includes 8 oz. Luster Seal, 8 oz. chrome polish and 8 oz. metal polish
- Kit B includes Luster Pad, narrow polishing strips, 8 oz. Luster Seal and 8 oz. Instant Detailer

Description	WPS#
Kit A	58-9156
Kit B	58-9157



## PAINT POLISH

- Clean, polish and protect paint, plastic and fiberglass in one easy step
- Deep shine formula removes minor swirl marks, scratches and blemishes
- Leaves a UV protective coating for a deep glossy shine
- Contains Carnauba



Description	WPS#
16 oz	58-9159

## DEEP 6 WAX

- Easy to use premium industrial strength cream cleaner wax
- Non-abrasive formula leaves a durable, brilliant clear shine with optimum protection from the elements



Description	WPS#
16 oz	58-9160

WINDSHIELDS / FAIRINGS  
AUDIO / COMMUNICATION  
SEATS / LUGGAGE  
BARS / MIRRORS / CONTROLS  
EXHAUST  
AIR / FUEL SYSTEMS  
ENGINE  
TRANSMISSION / DRIVELINE  
GASKETS / SEALS  
ELECTRICAL  
LIGHTING  
CABLES  
BRAKES  
OIL FILTERS  
SUSPENSION  
BODY  
WHEELS  
TIRES / TIRE ACC.  
BIKE ACC.  
VICTORY / INDIAN  
COVERS / LOCKS / TIEDOWNS  
CHEMICALS  
TOOLS  
HELMETS  
HELMET ACC.  
EYEWEAR  
APPAREL / RIDER ACC.  
PROMOTIONAL  
REFERENCE  
INDEX





## LUSTER SEAL

- Polishes, seals and protects paint, chrome, gold plate, clear coat, brass, aluminum, stainless steel and most any other bare metal surfaces
- Seals in shine and seals out pollution and oxidation for up to 6 months



Description	WPS#
8 oz	58-9162

## CHROME POLISH

- Non-abrasive polish and super protectant
- Specially formulated to bring a brilliant shine to chrome and other fine metal finishes



Description	WPS#
8 oz	58-9161

## DETAILER

- Easily lifts dust, bugs, tree sap, light road film, water spots and bird droppings from paint, chrome, fiberglass, plastic and glass
- Formulated to clean without scratching leaving a smooth, slick, deep shine and a water repellent coating



Description	WPS#
22 oz	58-9165

## SATIN MAGIC

- Long lasting dressing that provides a satin sheen on rubber, vinyl and plastic surfaces
- Protects from harmful UV rays that can cause surfaces to dry out and crack



Description	WPS#
24 oz	58-9158

## LEATHER LIFE

- Protects leather from cracking and premature aging
- Provides essential oils and lubrication that leather needs to remain soft and supple



Description	WPS#
8 oz	58-9163

## DRY LUBE

- Designed to lubricate O, X and Z-ring chains
- Dry Lube keeps your chain, rim and spokes clean and will help your chain and sprockets to last longer
- Does not turn into a sticky abrasive like most other chain lubes
- Excellent flow properties for optimum lubrication between to roller and outer sleeve
- One can of Dry Lube can replace 2 to 3 cans of standard adhesive chain lube



Description	WPS#
5 oz	12/case 58-9170
13.5 oz	12/case 58-9171

- WINDSHIELDS / FAIRINGS
- AUDIO / COMMUNICATION
- SEATS / LUGGAGE
- BAR / MIRRORS / CONTROLS
- EXHAUST
- AIR / FUEL SYSTEMS
- ENGINE
- TRANSMISSION / DRIVELINE
- GASKETS / SEALS
- ELECTRICAL
- LIGHTING
- CABLES
- BRAKES
- OIL FILTERS
- SUSPENSION
- BODY
- WHEELS
- TIRES / TIRE ACC.
- BIKE ACC.
- VICTORY / INDIAN
- COVERS / LOCKS / TIEDOWNS
- CHEMICALS
- TOOLS
- HELMETS
- HELMET ACC.
- EYEWEAR
- APPAREL / RIDER ACC.
- PROMOTIONAL
- REFERENCE
- INDEX



### ENGINE CLEANER

- Original - Restores dull or faded rubber, tires, trim, vinyl, paint, chrome and other surfaces



Description	WPS#
Original 9 oz aerosol 12/case	83-1015

### SIMICHROME POLISH

- Effectively cleans & brilliantly polishes tool and die molds and extrusion dyes
- Used with confidence when polishing the most delicate, precision equipment
- Yields unequaled smooth finish on steel die interiors
- Outstanding agent for purging plastic injection and molding equipment
- A unique, non-toxic and non-corrosive compound
- Provides lustrous finish for all fabricated products



Description	WPS#
1.76 oz tube 12/case	27-4825

## ThreeBond

### PLASTIC REPAIR KIT

Designed for dealerships, custom fabrication, garage/repair shops, salvage yards and the "do-it-yourselfers". Includes instructions, slow-curing glue, PP/PE Primer, accelerator, glue remover, 6 pieces of sandpaper, fibercloth 30" x 1.5" and applicator stick. Mini kit contains enough product for one to two repairs. The shop kit will do 4 to 5 repairs. Not recommended for fiberglass repairs.



Description	WPS#
Shop kit	59-9106



### WINDSHIELD CLEANER & POLISH

- For polishing and cleaning plastic



Description	WPS#
8 oz 12/case	56-6550



### PROTECT ALL

Dealers — This easy to use cleaner and polish keeps showroom display machines looking their very best.

- Cleans, polishes, protects
- Gives extra protection against harmful sun, ozone and smog



Description	WPS#
6 oz aerosol 12/case	27-4805
13.5 oz aerosol 12/case	27-4806



### PLASTIC CLEANER, PROTECTANT AND POLISH

- Meets aircraft industry's high standards
- The most effective product you can buy for cleaning, polishing and protecting plastic
- Use on plastic, fiberglass, Kevlar, carbon fiber, acrylic paint, chrome and aluminum
- Seals surface pores with a micro thin layer of glossy protective wax
- Resistant to debris, oil, scratches and reduces fading and yellowing
- Anti-static properties repel dust and lint
- Spray it on — Wipe it off



Size	Description	WPS#
7 oz	12/case	27-4837
13 oz	12/case	27-4839



### Plastic Renew™ PLASTIC RESTORING KIT

- Restores color and shine to dull and faded plastic
- Will not build up or discolor plastic
- Permanent; will not come off with normal washing

Description	WPS#
8oz Kit	27-4842





## ORIGINAL BIKE SPIRITS

- “Roadside Detailer” Cleans Road Grime, Grease & Bugs Without Water
- Polishes Paint & Chrome
- Repels Water
- Anti-Static Properties
- Reduce Dust Buildup
- 50-State VOC Compliant

Description	WPS#
5 oz 12/case	58-7710
14 oz 12/case	58-7700



## FUEL SYSTEM SUPREME

- Fuel system and carbon deposit cleaner
- Improves fuel efficiency and drivability
- Reduces engine ping and knock, helps reduce emissions
- Use as regular maintenance every 3,000 miles
- For gasoline engines only

Description	WPS#
8 oz 12/case	58-7706



## CHAIN LUBE

- Contains P.T.F.E. and moly for superior lubrication
- Fast drying no sling-off formula
- Dyeless, won't stain white paint
- Repels dirt and water
- Superb rust protection
- For use on o-ring and standard chains
- 50-State VOC compliant

Description	WPS#
13 oz 12/case	58-7713



## CHAIN LUBE WITH GRAPHITE

- White graphite technology for superior lubricity
- Compatible with o-ring and conventional chains
- Quick drying to a white tacky lubricating film
- No sling-off formula minimizes attraction of grit, sand and dirt
- Resists wash-off
- 50-State VOC compliant

Description	WPS#
13 oz 12/case	58-7704



## BRAKE CLEANER

- Non-Chlorinated
- Removes grease, oil, road grime, brake fluid and chain lube overspray
- Instant evaporation
- 58-7701 CAN NOT BE SOLD IN CALIFORNIA OR UTAH
- 58-7702 Low VOC is 50 state/CARB compliant

Description	WPS#
14 oz 12/case	58-7701
14 oz low VOC 12/case	58-7702



## CARBURETOR CLEANER

- Cleans carburetors, chokes and throttle bodies
- High pressure blast spray
- Helps eliminate stalling and rough idling
- Cleans inside and out
- 50-State VOC compliant

Description	WPS#
12 oz 12/case	58-7705



- WINDSHIELDS / FAIRINGS
- AUDIO / COMMUNICATION
- SEATS / LUGGAGE
- BARS / MIRRORS / CONTROLS
- EXHAUST
- AIR / FUEL SYSTEMS
- ENGINE
- TRANSMISSION / DRIVELINE
- GASKETS / SEALS
- ELECTRICAL
- LIGHTING
- CABLES
- BRAKES
- OIL FILTERS
- SUSPENSION
- BODY
- WHEELS
- TIRES / TIRE ACC.
- BIKE ACC.
- VICTORY / INDIAN
- COVERS / LOCKS / TIEDOWNS
- CHEMICALS
- TOOLS
- HELMETS
- HELMET ACC.
- EYEWEAR
- APPAREL / RIDER ACC.
- PROMOTIONAL
- REFERENCE
- INDEX



## TOTAL CYCLE CLEANER

Rider Magazine called it "the Revolution for the Saturday morning wash" and no wonder! A clean bike in 15 minutes with no muss and no fuss.

- Spray on, hose off formula
- More riding time, less cleaning time
- Factory approved and supplied to leading bike manufacturers
- All surface safe

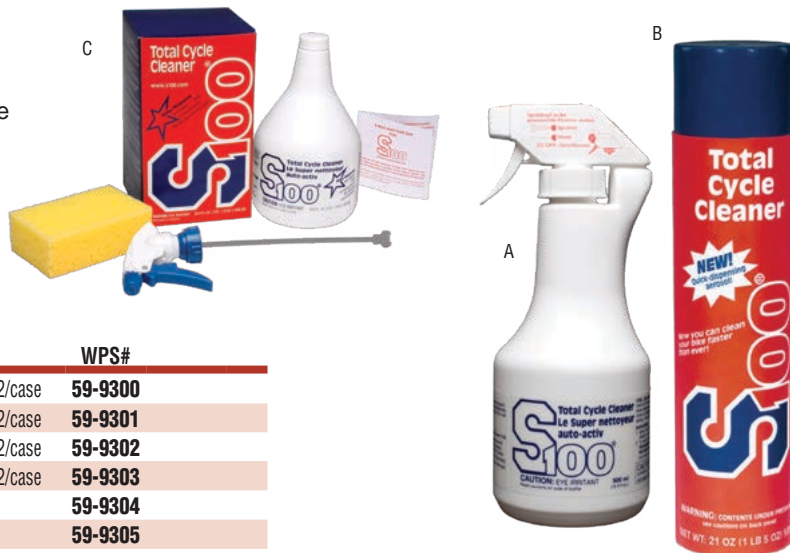

Description		WPS#
A 500 ml bottle with sprayer	12/case	59-9300
B 21 oz aerosol	12/case	59-9301
C Deluxe set with sprayer, sponge and booklet	12/case	59-9302
1 liter refill for deluxe set	12/case	59-9303
5 liter canister		59-9304
100 liter drum		59-9305

## ACCESSORIES

### SPRAYER FOR 5 LITER CANISTER INCLUDES:

- Heavy duty spray head and cap
- 6 foot hose eases cleaner application
- Perfect for bike prep, shop use



WPS#  
**59-9330**

### DRUM PUMP FOR 100 LITER DRUM INCLUDES:

- Thread adapter
- Pumps approximately
- 1 pint/stroke



WPS#  
**59-9331**

## SHINE ENHANCING CLEANSER

- Removes water spots and small swirl marks
- Clear coat safe
- Preps bike for the perfect wax job



Description WPS#  
11.8 oz 12/case **59-9307**

## CARNAUBA PASTE WAX

- The ultimate in depth of shine
- Easy on, easy off formula
- Does not contain cleaners or abrasives
- Non-powdering; won't stain rubber or plastics



Description WPS#  
6.2 oz 12/case **59-9306**



## DETAIL + WAX

- Clean and shine in one easy step
- Incredible water-repellent shine
- Contains Carnauba
- Helps resist damaging UV rays

Description	WPS#
10 oz aerosol 12/case	59-9311

## SPECIAL SURFACES CLEANER

- Spray on, wipe off streak-free plastics cleaner
- Removes bugs, rains spots, road film
- Use on helmets, visors, fairings, instruments etc.
- Safe for all types of plastics



Description	WPS#
10 oz 12/case	59-9314

## WHEEL CLEANER

- Removes the toughest brake dust
- Non-acid, non-lye based formula
- Safe for all wheels and coatings, even anodized
- Unique gel formulation clings for better cleaning



Description	WPS#
500 ml	59-9308

## ENGINE BRIGHTENER

- Makes engines look "factory new" again
- Easy spray-on formulation
- High temperature stable
- Detergent resistant



Description	WPS#
4.5 oz aerosol 12/case	59-9312

## CORROSION PROTECTANT

- Keeps metals corrosion-free during riding season
- Easy spray on formulation
- Salt spray tested at Daytona
- Perfect for winter lay-up



Description	WPS#
7.4 oz aerosol 12/case	59-9309

## FINISH RESTORER

- Quickly shines up tarnished metals
- Use on chrome, aluminum, stainless
- Buffs out easily
- No ammonia odor



Description	WPS#
3.5 oz	59-9310

- WINDSHIELDS / FAIRINGS
- AUDIO / COMMUNICATION
- SEATS / LUGGAGE
- BARS / MIRRORS / CONTROLS
- EXHAUST
- AIR / FUEL SYSTEMS
- ENGINE
- TRANSMISSION / DRIVELINE
- GASKETS / SEALS
- ELECTRICAL
- LIGHTING
- CABLES
- BRAKES
- OIL FILTERS
- SUSPENSION
- BODY
- WHEELS
- TIRES / TIRE ACC.
- BIKE ACC.
- VICTORY / INDIAN
- COVERS / LOCKS / TIEDOWNS
- CHEMICALS
- TOOLS
- HELMETS
- HELMET ACC.
- EYEWEAR
- APPAREL / RIDER ACC.
- PROMOTIONAL
- REFERENCE
- INDEX



### CYCLE CARE GIFT SET

- 5 S100 Products in handy organizer: Total Cycle Cleaner, Detail and Wax, Finish Restorer, Corrosion Protectant, sponge and a drying towel
- The ideal holiday gift
- Perfect new bike delivery item



Description	WPS#
Gift Set	4/case 59-9315

### POLISHING SOAP

- Easiest polish on the market
- Applies like a soap; wipe on, hose off
- Shines up aluminum, chrome, stainless
- Unique water-based formula



Description	WPS#
10.6 oz	12/case 59-9313

### DETAILING SET

- Ultra soft cloth for dusting, polishing etc.
- USP grade swabs (25 qty) bend 90°
- Clean areas where dirt and corrosion hide



Description	WPS#
Detailing set	59-9320
50 swab replacement set	59-9321

### DRYING TOWEL

- Out dries natural chamois
- Won't get brittle when dry
- Lint free, mildew resistant
- Handy storage pouch for saddlebag



Description	WPS#
Towel	12/case 59-9322

WINDSHIELDS / FAIRINGS  
 AUDIO / COMMUNICATION  
 SEATS / LUGGAGE  
 BARS / MIRRORS / CONTROLS  
 EXHAUST  
 AIR / FUEL SYSTEMS  
 ENGINE  
 TRANSMISSION / DRIVELINE  
 GASKETS / SEALS  
 ELECTRICAL  
 LIGHTING  
 CABLES  
 BRAKES  
 OIL FILTERS  
 SUSPENSION  
 BODY  
 WHEELS  
 TIRES / TIRE ACC.  
 BIKE ACC.  
 VICTORY / INDIAN  
 COVERS / LOCKS / TIEDOWNS  
 CHEMICALS  
 TOOLS  
 HELMETS  
 HELMET ACC.  
 EYEWEAR  
 APPAREL / RIDER ACC.  
 PROMOTIONAL  
 REFERENCE  
 INDEX



### CHAIN CLEANER WITH 360° BRUSH

- Quickly loosens grit and old chain lube from chains, wheels and frames
- Highly effective patented 360° brush included (also available separately)
- Safe on all chains/bodywork etc.
- Contains kerosene (as recommended by leading chain manufacturers)

Made in Canada



Description	WPS#
16 oz aerosol w/360° brush	12/case <b>58-7800</b>
360° brush only	<b>58-7820</b>
360° brush only POP jar w/25 brushes	<b>58-7821</b>

### PLASTIX CLEANER

- Powerful foaming action emulsifies and lifts out contaminants, cleans, polishes and protects
- Ideal for plastics, acrylics, Lexan, plexiglas, fiberglass, painted surfaces, finished metals and most hard surfaces
- Non-scratching water based formula offers anti-static UV protection and is water repellant and bug resistant
- Premium polishing cloth included in the cap



Description	WPS#
18 oz aerosol	12/case <b>58-7810</b>

### CHAIN WAX

- PTFE Teflon infused synthetic no-fling formula which virtually eliminates all friction
- Goes on clean, stays clean and will not attract dirt or road grime
- Keeps chain and sprockets clean and protected
- Safe for all types of powersports chains



Description	WPS#
14.8 oz	12/case <b>58-7801</b>



- WINDSHIELDS / FAIRINGS
- AUDIO / COMMUNICATION
- SEATS / LUGGAGE
- BARS / MIRRORS / CONTROLS
- EXHAUST
- AIR / FUEL SYSTEMS
- ENGINE
- TRANSMISSION / DRIVELINE
- GASKETS / SEALS
- ELECTRICAL
- LIGHTING
- CABLES
- BRAKES
- OIL FILTERS
- SUSPENSION
- BODY
- WHEELS
- TIRES / TIRE ACC.
- BIKE ACC.
- VICTORY / INDIAN
- COVERS / LOCKS / TIEDOWNS
- CHEMICALS**
- TOOLS
- HELMETS
- HELMET ACC.
- EYEWEAR
- APPAREL / RIDER ACC.
- PROMOTIONAL
- REFERENCE
- INDEX



## CHAIN LUBE NEW

Unique protection that performs

Our BananaSlip Chain Lube has been specifically formulated to perform exceptionally well under intense use in all weather conditions, while providing long lasting protection. Upon application it penetrates deep into all parts of the chain to give optimum coverage. BananaSlip Chain Lube contains a unique combination of properties in order to reduce frictional losses while leaving an anti-fling wet film with a slippery banana-flavored scent to protect against even the harshest environments.



Uses for BananaSlip Chain Lube:

- High performance motorcycles
- Street, track or race riding
- Regular application of chain oil
- Aggressive or fast riding
- Frequent gear changes and quick-shifting
- 500ML

WPS#

**59-2810**

## PRIMESHINE NEW CHAIN CLEANER

- Perfectly removes all grease, oil and dirt build up
- Added chain protection
- Highly effective and easy to use
- Suitable for standard O, X and Z-Ring chains
- Reduces friction
- Brilliant for all road, off road and race chains
- 500ML



WPS#

**59-2812**

## CHAIN WAX NEW

Hard wearing, anti-fling Chain Wax

BananaSlip anti-fling PTFE Chain Wax is perfect for motorcycle and motorsport chains that will experience prolonged cycles and high impact environmental conditions.



Our unique formulation penetrates deep into the links of the chain before drying externally to leave a protective layer against water and dirt.

By producing an ultra-long lasting wax, BananaSlip keeps the joints of the chain well lubricated and reduces frictional losses between the chain and the sprocket up to twice as long as traditional chain oils. As a result, BananaSlip Chain Wax not only lubricates and protects but also enhances performance and the life of moving components.

Uses for BananaSlip Chain Wax:

- Touring, Sports Touring
- Off-road riding
- Commuting & motorway
- Mixed riding style
- 500ML

WPS#

**59-2811**

## PRIMESHINE NEW BRAKE CLEANER

- High powered nozzle blasts away dirt and grime
- Removes all brake dust, oil and grease
- Fast drying action with no residue
- Protects all seals and rubber components
- Perfect for brakes and clutches
- 500ML



WPS#

**59-2815**

- WINDSHIELDS / FAIRINGS
- AUDIO / COMMUNICATION
- SEATS / LUGGAGE
- BAR / MIRRORS / CONTROLS
- EXHAUST
- AIR / FUEL SYSTEMS
- ENGINE
- TRANSMISSION / DRIVELINE
- GASKETS / SEALS
- ELECTRICAL
- LIGHTING
- CABLES
- BRAKES
- OIL FILTERS
- SUSPENSION
- BODY
- WHEELS
- TIRES / TIRE ACC.
- BIKE ACC.
- VICTORY / INDIAN
- COVERS / LOCKS / TIEDOWNS
- CHEMICALS**
- TOOLS
- HELMETS
- HELMET ACC.
- EYEWEAR
- APPAREL / RIDER ACC.
- PROMOTIONAL
- REFERENCE
- INDEX





**PRIMESHINE CARB CLEANER**



- Cleans and lubricates
- High powered formula for easy cleaning
- Perfectly formulated for cleaning and lubricating carburetors and injectors
- Effectively removes all particles, varnishes, and contaminants for perfect runability
- 500ML

WPS#

**59-2814**



**PRIMESHINE TT78 MULTI-USE SPRAY**



- Motorcycle dedicated Multi-Use spray
- Effectively degreases and cleans in one step
- Perfect for high gloss finishes on engines and paint
- Lubricates stiff components
- Effectively prevents rust development
- High water repellent properties
- Perfect for general maintenance and cleaning
- 500ML

WPS#

**59-2816**



**PRIMESHINE BODYWORK FOAM CLEANER**



- One spray instant foam cleaner and polish
- Quick, easy and highly effective all in one cleaner
- No water needed, so no water marks!
- Perfect for Bodywork, Chrome, Painted & Plastic parts
- Leaves a highly polished, waxed surface
- Great for indoor cleaning
- 500ML

WPS#

**59-2813**

WINDSHIELDS / FAIRINGS  
AUDIO / COMMUNICATION  
SEATS / LUGGAGE  
BARS / MIRRORS / CONTROLS  
EXHAUST  
AIR / FUEL SYSTEMS  
ENGINE  
TRANSMISSION / DRIVELINE  
GASKETS / SEALS  
ELECTRICAL  
LIGHTING  
CABLES  
BRAKES  
OIL FILTERS  
SUSPENSION  
BODY  
WHEELS  
TIRES / TIRE ACC.  
BIKE ACC.  
VICTORY / INDIAN  
COVERS / LOCKS / TIEDOWNS  
**CHEMICALS**  
TOOLS  
HELMETS  
HELMET ACC.  
EYEWEAR  
APPAREL / RIDER ACC.  
PROMOTIONAL  
REFERENCE  
INDEX



## WIZARDS MIST-N-SHINE

### PROFESSIONAL DETAILER

- Adds a show-winning gloss and slickness to any vehicle
- Brightens all paint, clear coat, fiberglass and chrome
- Perfect to use between complete wax applications
- Great for spot cleaning to remove dust, bugs, fingerprints, etc
- Safe for show chrome and Lexan
- Hides swirls
- Will not scratch or streak, even in direct sun
- Anti-static
- Contains no wax, solvents or silicone - body shop recommended



Description	WPS#
8oz	57-6314
22oz 12/case	57-6315
1 gal	57-6315G

## WIZARDS MYSTIC SPRAY AND WAX

### SLICK FINISH DETAILER

- Slick Nano Technology Protection
- Best in class spray wax-detailer-dry wash
- Instant bonding to paint, chrome, glass, fiberglass or any hard surface
- Relentless water beading wash after wash
- Extremely slick protective finish, adding gloss, depth and clarity with each application
- VOC compliant, contains no petroleum solvents or abrasives
- Pleasing fragrance



Description	WPS#
22oz 12/case	57-6300

## WIZARDS WIPE DOWN

### MATTE PAINT DETAILER

- Safe for all paint systems
- Quickly cleans matte finishes: suede, denim, satin primer, powder coat and all flat clears
- Adds no gloss or protection
- Contains no wax, solvents or silicone
- Removes dust, fingerprints, road grime and oily residue without adding gloss
- Removes streaks and smears from overuse of waxes, glazes, etc.
- Removes oily residue after buffing



Description	WPS#
22oz 12/case	57-6316
1gal	57-6316G

## BIKE WASH

### COMPLETE BIKE CLEANER

- Safe for paint, chrome, and plastics
- Foams away road grime, oil, grease, brake dust, and more
- Strong enough to degrease engines and wheels
- Ease rinse formula cleans without spotting
- Biodegradable, ph controlled, no caustic soda, acids or bleach



Description	WPS#
22oz 12/case	57-6313
1 gal	57-6313G

WINDSHIELDS / FAIRINGS  
AUDIO / COMMUNICATION  
SEATS / LUGGAGE  
BARS / MIRRORS / CONTROLS  
EXHAUST  
AIR / FUEL SYSTEMS  
ENGINE  
TRANSMISSION / DRIVELINE  
GASKETS / SEALS  
ELECTRICAL  
LIGHTING  
CABLES  
BRAKES  
OIL FILTERS  
SUSPENSION  
BODY  
WHEELS  
TIRES / TIRE ACC.  
BIKE ACC.  
VICTORY / INDIAN  
COVERS / LOCKS / TIEDOWNS  
CHEMICALS  
TOOLS  
HELMETS  
HELMET ACC.  
EYEWEAR  
APPAREL / RIDER ACC.  
PROMOTIONAL  
REFERENCE  
INDEX



## BUG RELEASE ALL SURFACE BUG REMOVER

- Quickly removes bugs and bug residue
- Neutralizes acidic bug proteins so they can be easily washed away
- Safe for all motorcycle surfaces: paint, chrome, plastics, fiberglass, and Lexan
- Non-toxic and biodegradable
- Use as a presoak or spot cleaner

Description	WPS#
8oz	<b>57-6311</b>
22oz 12/case	<b>57-6312</b>
1 gal	<b>57-6340</b>



## WHEEL/TIRE CLEANER

- Safe on all factory & custom wheels - polished aluminum, roughcast, uncoated, anodized, chrome, clear coated and PVD
- Removes stubborn road grime, grease and brake dust without staining or etching wheels
- Cleans tires - great for black walls, whitewalls and raised white letters
- Non-caustic, non-acid, biodegradable

Description	WPS#
22oz 12/case	<b>57-6322</b>
1 gal	<b>57-6322G</b>



## COOL KIT

- Mist-N-Shine® Professional Detailer 22 oz.
- Bug Release™ Bug Remover 22 oz.
- Bike Wash Bike Cleaner 22 oz.
- Shine Master™ Polish 8 oz.
- Mist-N-Shine™ 8 oz. Saddlebag Size
- Multi-Fiber™ Cloth 16" x 24"
- FREE Wizards® hat
- Packed into a soft-sided cooler
- MAKES A GREAT GIFT!

WPS#
<b>57-6318</b>



## SADDLE PACK

- 1 – 2 oz. Mist-N-Shine®
- 1 – 2 oz. Bug Release™
- 1 – 2 oz. Bike Wash
- 1 – 2 oz. Vinyl Shine™
- Microfiber Detailing Cloth 16" x 16"
- MAKES A GREAT GIFT!
- Perfect size for your Saddle Bag

WPS#
<b>57-6317</b>

- WINDSHIELDS / FAIRINGS
- AUDIO / COMMUNICATION
- SEATS / LUGGAGE
- BAR / MIRRORS / CONTROLS
- EXHAUST
- AIR / FUEL SYSTEMS
- ENGINE
- TRANSMISSION / DRIVELINE
- GASKETS / SEALS
- ELECTRICAL
- LIGHTING
- CABLES
- BRAKES
- OIL FILTERS
- SUSPENSION
- BODY
- WHEELS
- TIRES / TIRE ACC.
- BIKE ACC.
- VICTORY / INDIAN
- COVERS / LOCKS / TIEDOWNS
- CHEMICALS
- TOOLS
- HELMETS
- HELMET ACC.
- EYEWEAR
- APPAREL / RIDER ACC.
- PROMOTIONAL
- REFERENCE
- INDEX

- WINDSHIELDS / FAIRINGS
- AUDIO / COMMUNICATION
- SEATS / LUGGAGE
- BAR / MIRRORS / CONTROLS
- EXHAUST
- AIR / FUEL SYSTEMS
- ENGINE
- TRANSMISSION / DRIVELINE
- GASKETS / SEALS
- ELECTRICAL
- LIGHTING
- CABLES
- BRAKES
- OIL FILTERS
- SUSPENSION
- BODY
- WHEELS
- TIRES / TIRE ACC.
- BIKE ACC.
- VICTORY / INDIAN
- COVERS / LOCKS / TIEDOWNS
- CHEMICALS
- TOOLS
- HELMETS
- HELMET ACC.
- EYEWEAR
- APPAREL / RIDER ACC.
- PROMOTIONAL
- REFERENCE
- INDEX



## WASH CONCENTRATE

- Rich thick foam
- Easy cleaning
- Streak free rinsing
- Retains gloss and protection
- Safe for all surfaces



Description	WPS#
16 oz	57-6223

## SCRATCH REMOVER SCRATCH REMOVER & PRE-WAX CLEANER

- Levels minor scratches & swirls
- Removes light fading & blemishes
- Excellent pre-wax cleaner
- Safe on all paint, clears, & most plastics
- Hand or buffer application
- Safe alternative to harsh rubbing compounds



Description	WPS#
8oz	57-6310

## SHINE MASTER NEW

- Easy on, easy off
- Use as a wax replacement, swirl mark remover or finishing glaze by hand or machine
- No free silicone or wax
- No streaks or smears
- Awesome gloss



Description	WPS#
16oz	57-6324

## CRYSTAL CLEAR

### PLASTIC CLEANER AND POLISH

- Restores windshield clarity
- Removes hairline scratches and hazing
- Safe for clear plastics, Plexiglas and Lexan
- No harsh abrasives or hydrocarbon solvents



Description	WPS#
8oz	57-6304

## BLACK RENEW

### ALL COLOR EXTERIOR TRIM TREATMENT

- Works on all colors of exterior trim
- Instantly removes embedded wax and compound from textured body side moldings
- Cleans and renews faded trim
- Concentrated cream outlasts sprays
- No airborne silicone contaminants



Description	WPS#
8oz	57-6320

## METAL RENEW

### ALL METAL LIQUID POLISH

- Fast cut, high gloss
- Easier to apply and remove
- Brightens and renews aluminum, stainless steel and dull chrome\*
- For show chrome use Mist-N-Shine®
- Creamy emulsion does not require constant shaking
- Use by hand or with Metal Buffs Kit



Description	WPS#
8oz	57-6307



## LEATHER CARE PLUS

- Preserves and protects all fine leather, naugahyde and vinyl surfaces
- Contains moisturizers and lanolin oils
- Concentrated cream forms a penetrating leather lotion
- Use on auto, apparel, luggage and furniture



Description	WPS#
8oz	57-6341

## MYSTIC CLAY SMOOTHS ROUGH SURFACES

- Makes paint very smooth
- Removes all surface contaminants: brake dust, paint over spray, tree sap
- Safe on all paint/clears, metals, fiberglass and glass
- Made in the USA
- Will not harden over time
- Will not damage the finish



Description	WPS#
120 grams	57-6301

## METAL BUFFS KIT

- Fast, easy, power polishing, four types of Metal Buffs
- Use with Wizards® Metal Renew™ for fast polishing
- 4 unique sizes and shapes of buffs
- 1/4" shank fits most electric and air drills



Description	WPS#
Kit	57-6319

## POWER SEAL ALL METAL SEALER

- Environmental shield for all polished metals
- Provides an acrylic barrier to stop air and moisture corrosion
- Super seals and protects against rust and corrosion
- Provides easy, high gloss maintenance as a micro polish



Description	WPS#
8oz	57-6308

## METAL POLISH THE MAGIC IS IN THE CLOTH™

- Fast cutting, highest gloss possible
- Brightens and protects all metals: aluminum, chrome\*, stainless, brass, copper, nickel
- For show chrome use Mist-N-Shine®
- Removes tarnish corrosion, oxidation, brake dust, and tar



Description	WPS#
3oz	57-6305

## DETAIL CLOTHS

- High Performance, Super Absorbent
- Best choice for use with Mist-N-Shine® and Wipe Down™
- Guaranteed to absorb faster than any terry towel, cotton cloth or paper towel
- Will not lint, streak, or scratch surfaces
- Can be washed by hand or machine hundreds of times with no performance loss



Description	WPS#
Multi-Fiber blue cloth 23"x16"	57-6302
Microfiber gray cloth 16"x16"	57-6303

- WINDSHIELDS / FAIRINGS
- AUDIO / COMMUNICATION
- SEATS / LUGGAGE
- BAR / MIRRORS / CONTROLS
- EXHAUST
- AIR / FUEL SYSTEMS
- ENGINE
- TRANSMISSION / DRIVELINE
- GASKETS / SEALS
- ELECTRICAL
- LIGHTING
- CABLES
- BRAKES
- OIL FILTERS
- SUSPENSION
- BODY
- WHEELS
- TIRES / TIRE ACC.
- BIKE ACC.
- VICTORY / INDIAN
- COVERS / LOCKS / TIEDOWNS
- CHEMICALS
- TOOLS
- HELMETS
- HELMET ACC.
- EYEWEAR
- APPAREL / RIDER ACC.
- PROMOTIONAL
- REFERENCE
- INDEX

- WINDSHIELDS / FAIRINGS
- AUDIO / COMMUNICATION
- SEATS / LUGGAGE
- BAR / MIRRORS / CONTROLS
- EXHAUST
- AIR / FUEL SYSTEMS
- ENGINE
- TRANSMISSION / DRIVELINE
- GASKETS / SEALS
- ELECTRICAL
- LIGHTING
- CABLES
- BRAKES
- OIL FILTERS
- SUSPENSION
- BODY
- WHEELS
- TIRES / TIRE ACC.
- BIKE ACC.
- VICTORY / INDIAN
- COVERS / LOCKS / TIEDOWNS
- CHEMICALS**
- TOOLS
- HELMETS
- HELMET ACC.
- EYEWEAR
- APPAREL / RIDER ACC.
- PROMOTIONAL
- REFERENCE
- INDEX



## BIKER LEATHER CARE

- Cleans and Conditions leather and vinyl with no build up
- Revitalizes dull, dry, faded leathers
- Will not rub off on hands or clothing
- Protects against UV damage
- Inhibits mold and mildew
- Increases strength and flexibility
- No more smelly leathers!

	Description	WPS#
A	Leather infusion wash 16oz	57-6205
B	Leather infusion rinse 16oz	57-6206
C	Biker wash 16oz spray	57-6201
D	Biker water repellent 8oz	57-6204
E	Biker finish 8oz	57-6202



A



B



C



D



E



F



## FUEL CATALYST YOU EITHER HAVE FITCH OR YOU NEED IT!



- Insure fuel quality during storage
- Increase gasoline octane or diesel cetane
- Improve engine performance (horsepower and torque)
- Improve fuel economy
- Reduce emissions - green house gases
- Reduce engine maintenance
- Improve oil burner efficiency

- One application good for 250,000 miles or 5000 operating hours
- Sold two capsules per display card
- One capsule is good for up to a 10 gal tank

Description	WPS#
2/pak	57-1290



## STA-BIL<sup>®</sup> ETHANOL TREATMENT

- A new formula designed to prevent corrosion from moisture and ethanol induced water attraction
- Best ethanol problem fighter with more than four times the fuel system cleaner than regular STA-BIL
- Contains twice the corrosion preventer than STA-BIL, as well as two non-alcohol water removers
- Designed for use with every fill up in all 2-4 stroke marine engines running gasoline, gas-oil mixtures, and ethanol blends
- Can also be used as a safe storage treatment in snowmobiles, motorcycles, motor homes, and all outdoor power equipment including lawn mowers and tractors
- 8 oz treats up to 80 gals and  
32 oz treats up to 320 gals

Description	WPS#
8 oz	57-1109
32 oz	57-1130

## GAS STABILIZER

- Prevents gum, varnish, rust and corrosion in the fuel system and combustion chamber
- Keeps stored gas fresh indefinitely
- For use in all 2-cycle and 4-cycle engines
- Recommended by 20 top engine manufacturers
- 4 oz treats 10 gals
- 8 oz treats 20 gals
- 32 oz treats 80 gals
- 1 gal treats 320 gals

Description	WPS#
4 oz	24/case 57-1104
10 oz	12/case 57-1108
1 qt	12/case 57-1132
1 gal	4/case 57-1128



## FOGGING OIL

- Protects internal engine parts during storage
- Prevents corrosion of surfaces inside engine
- For all 2-cycle & 4-cycle engines

Description	WPS#
12 oz	6/case 57-1110



## “ISO-HEET” FUEL SYSTEM ANTI-FREEZE

- Prevents gum, varnish, rust and corrosion in the fuel system and combustion chamber
- Keeps stored gas fresh indefinitely
- For use in all 2-cycle and 4-cycle engines
- Recommended by 20 top engine manufacturers
- 4 oz treats 10 gals
- 8 oz treats 20 gals
- 32 oz treats 80 gals
- 1 gal treats 320 gals

Description	WPS#
12 oz	24/case 27-1006



- WINDSHIELDS / FAIRINGS
- AUDIO / COMMUNICATION
- SEATS / LUGGAGE
- BARS / MIRRORS / CONTROLS
- EXHAUST
- AIR / FUEL SYSTEMS
- ENGINE
- TRANSMISSION / DRIVELINE
- GASKETS / SEALS
- ELECTRICAL
- LIGHTING
- CABLES
- BRAKES
- OIL FILTERS
- SUSPENSION
- BODY
- WHEELS
- TIRES / TIRE ACC.
- BIKE ACC.
- VICTORY / INDIAN
- COVERS / LOCKS / TIEDOWNS
- CHEMICALS
- TOOLS
- HELMETS
- HELMET ACC.
- EYEWEAR
- APPAREL / RIDER ACC.
- PROMOTIONAL
- REFERENCE
- INDEX



## XTREME CLEAN

- Engineered to remove the toughest dirt, grime and greasy stains
- Formulated to clean vinyl, fiberglass, plastic, rubber, metal carpets and more

Description	WPS#
22 oz 12/case	57-1162



## BIKE GUARD DETAILER

- Cleans and adds shine to all fiberglass, metal, chrome and painted surfaces
- Removes bug debris, grime, grease, dirt and water spots
- Protective polymers repel UV rays

Description	WPS#
22 oz 12/case	57-1163



## MATTE FINISH DETAILER

- Silicone and wax free alkaline neutral formula cleans all matte, denim, satin and all other non-glossy finishes and surfaces
- Removes road grime, fingerprints, grease, bug deposits and more
- PTFE polymers leave a protective, invisible, non-glossy, non-sticky barrier to repel damaging UV rays and dirt
- Formulated for use on all metal, fiberglass, plastic, wrapped and printed surfaces, helmets, fuel tanks, chrome, bags and more

Description	WPS#
22 oz 12/case	57-1164



## WATERSPOT REMOVER

- Instantly removes stubborn waterspots
- Works on fiberglass, metal and painted surfaces
- Spray on, wipe off formula, non toxic and non abrasive

Description	WPS#
22 oz 12/case	57-1160



## ULTIMATE LUBRICATING FLUID

- Contains Cerflon® for unsurpassed lubrication and Lanolin to coat surfaces and repel dirt and water
- Forms a micro-thin film that seals the treated surface for long-lasting lubrication and protection against corrosion
- Cerflon® nanoparticles bond to treated surfaces for long-lasting lubricity of all metal moving parts
- Dielectric formula is ideal for forming a barrier against moisture and corrosion on battery terminals, junction blocks and wiring
- Deep-penetrates to loosen frozen bolts; displaces moisture; prevents further corrosion of rusted surfaces

Description	WPS#
11.75 oz aerosol 12/case	57-1180
22 oz Spray bottle 6/case	57-1181

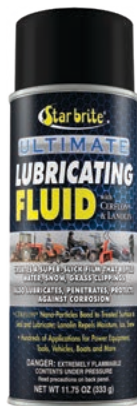

## CORROSION BLOCKER

- Provides an invisible, long lasting, non-sticky barrier to corrosion
- Protects engines, wiring terminals, metal hardware and more
- Safe for all metal surfaces, displaces moisture and provides a non-conductive dielectric coating

Description	WPS#
22 oz 12/case	57-1161



WINDSHIELDS / FAIRINGS  
AUDIO / COMMUNICATION  
SEATS / LUGGAGE  
BARS / MIRRORS / CONTROLS  
EXHAUST  
AIR / FUEL SYSTEMS  
ENGINE  
TRANSMISSION / DRIVELINE  
GASKETS / SEALS  
ELECTRICAL  
LIGHTING  
CABLES  
BRAKES  
OIL FILTERS  
SUSPENSION  
BODY  
WHEELS  
TIRES / TIRE ACC.  
BIKE ACC.  
VICTORY / INDIAN  
COVERS / LOCKS / TIEDOWNS  
CHEMICALS  
TOOLS  
HELMETS  
HELMET ACC.  
EYEWEAR  
APPAREL / RIDER ACC.  
PROMOTIONAL  
REFERENCE  
INDEX





### CLEANER DISPLAY

Countertop display includes 6 bottles each of the following:

- Bike Guard Detailer (WPS# 57-1163)
- Matte Finish Detailer (WPS# 56-1164)
- Waterspot Remover (WPS# 56-1160)
- Xtreme Clean (WPS# 56-1162)

**Description**

Display with product

### SYNTHETIC ENGINE COOLANT



- Utilizes Star Brite's revolutionary PCT additive package which is designed to maintain an engine's optimum operating temperature in order to develop maximum horsepower
- Allows engines to quickly reach and maintain proper temperature and reduce operating temperatures faster than other coolants
- Formulated to meet or exceed all OEM and appropriate ASTM standards
- Non-toxic propylene glycol formula, does not contain nitrates, amines, phosphates, silicates, borates or other ingredients that can clog radiators
- Formulated to seal pinhole leaks and fissures
- Ready to use, protects against freezing down to -26°F and boil-over to 265° F

**Description WPS#**

64 oz 4/case **57-1155**



### LIQUID ELECTRICAL TAPE

- Forms a protective, waterproof, UV resistant dielectric coating
- Prevents corrosion on wires and terminals
- Flexible and fire resistant
- Patented UL® tested fast drying formula
- Dries to the touch in 10 minutes, fully cures in 24 hours

Description		Black	Red
1 oz	12/case	<b>57-1176</b>	<b>57-1178</b>
4 oz	12/case	<b>57-1170</b>	<b>57-1177</b>

- WINDSHIELDS / FAIRINGS
- AUDIO / COMMUNICATION
- SEATS / LUGGAGE
- BAR / MIRRORS / CONTROLS
- EXHAUST
- AIR / FUEL SYSTEMS
- ENGINE
- TRANSMISSION / DRIVELINE
- GASKETS / SEALS
- ELECTRICAL
- LIGHTING
- CABLES
- BRAKES
- OIL FILTERS
- SUSPENSION
- BODY
- WHEELS
- TIRES / TIRE ACC.
- BIKE ACC.
- VICTORY / INDIAN
- COVERS / LOCKS / TIEDOWNS
- CHEMICALS**
- TOOLS
- HELMETS
- HELMET ACC.
- EYEWEAR
- APPAREL / RIDER ACC.
- PROMOTIONAL
- REFERENCE
- INDEX



## PRO STAR HIGH PERFORMANCE GREASE

- High-tech formulation significantly outperforms traditional greases
- Provides unsurpassed protection against wear, corrosion and heat
- Highly resistant to water washout
- Environmentally responsible formula is bio-renewable and biodegradable
- Fits most standard grease guns



Description	WPS#
14 oz 10/case	57-1168

## WHEEL BEARING GREASE

- Excellent corrosion protection from salt water and atmospheric chemicals
- Water insoluble formula resists water wash out
- Highly recommended for all marine applications, trailer wheel bearings and most all other applications a high quality grease is needed
- Fits most standard grease guns



Description	WPS#
14 oz 10/case	57-1167

## WHITE LITHIUM GREASE

- Ideal for use marine, powersport and automotive applications
- Can be used to lubricate plastic components
- Helps prevent corrosion
- Fits most standard grease guns



Description	WPS#
14 oz 10/case	57-1169

## LITHIUM GREASE

- Ideal for powersports, marine, automotive and general shop lubrication
- Excellent adhesion for maximum protection, provides effective moisture protection
- Fits most standard grease guns



Description	WPS#
14 oz 10/case	57-1166

## GREASE GUNS

- Available in lever and pistol style
- Ideal for most all lubrication tasks
- Corrosion resistant finish
- Fits standard zerk fittings
- Accepts all 14 oz grease cartridges
- Flexible extension hoses available separately

Description	WPS#
A Lever style	57-1171
B Pistol style	57-1172
C 12" Extension hose w/nozzle	57-1173
D 18" Extension hose no nozzle	57-1174

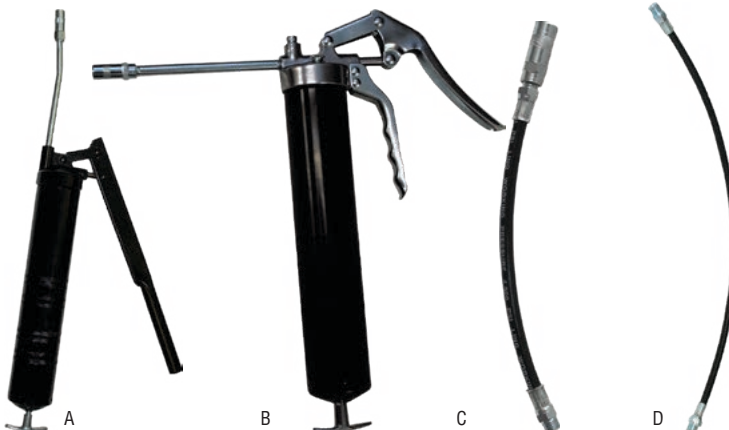



## STARTING FLUID

- Helps with starting in all types of engines
- Saves battery draw in extremely cold weather

Description	WPS#
11 oz 12/case	59-9083

## CARBURETOR CLEANER

- Removes carbon, gum, and varnish deposits
- Safe for oxygen sensors
- California compliant

Description	WPS#
12 oz 12/case	59-9084



## BRAKE CLEANER (CALIFORNIA)

- Economical
- Fast drying
- Non-chlorinated
- Low VOC
- California compliant

Description	WPS#
13 oz 12/case	59-9081



## GASKET SEALER

### UNLIMITED USES

Because of its special composition, Gasgacinch has many more uses than just a gasket sealer. Due to the flexible bonding powers of Gasgacinch, it can also be used for the following:

- Grip belt dressing
- Preventing rim leaks on new and used tubeless tires
- Tire boot patches
- Head gasket seal

GASGACINCH CONTAINS NO HEAT RETAINING METAL POWDERS SOLIDS ARE OF HEAT RESISTING FORMULA COMPOUNDS



Description	WPS#
4 oz 24/case	59-9090
8 oz 12/case	59-9091

## STEEL REINFORCED EPOXY PUTTY

- Dries steel-hard in 15 minutes
- Ready to drill and tap in 1 hour
- Easy to use - no waste
- 500° Temperature resistant
- 3-year shelf life
- Sets up under water
- Impervious to chemicals
- Permanently bonds to aluminum, brass, copper, steel, PVC, fiberglass, plastics and much more



## QuikSteel

### PERMANENT REPAIRS TO:

- |                  |                     |
|------------------|---------------------|
| GAS TANKS        | GASKETS             |
| RADIATORS        | STRIPPED BOLT HOLES |
| ENGINE CASES     | MIRROR MOUNTINGS    |
| INTAKE MANIFOLDS | PLASTIC BODY PARTS  |
| BATTERY CASES    | EXHAUST SYSTEMS     |

Description	WPS#
Display Card	59-9171
Counter Box 12/box	59-9170

- WINDSHIELDS / FAIRINGS
- AUDIO / COMMUNICATION
- SEATS / LUGGAGE
- BARS / MIRRORS / CONTROLS
- EXHAUST
- AIR / FUEL SYSTEMS
- ENGINE
- TRANSMISSION / DRIVELINE
- GASKETS / SEALS
- ELECTRICAL
- LIGHTING
- CABLES
- BRAKES
- OIL FILTERS
- SUSPENSION
- BODY
- WHEELS
- TIRES / TIRE ACC.
- BIKE ACC.
- VICTORY / INDIAN
- COVERS / LOCKS / TIEDOWNS
- CHEMICALS
- TOOLS
- HELMETS
- HELMET ACC.
- EYEWEAR
- APPAREL / RIDER ACC.
- PROMOTIONAL
- REFERENCE
- INDEX



## PETROCHEM CABLE CARE KIT

PREVENTS THROTTLE FREEZE OR HANG UP

The easy way to lubricate the cables on your motorcycle. Lubricates completely in five seconds! The CABLE LUBER power injects Petrochem CABLE LIFE into the cable with no spill-over or mess. Just attach the CABLE LUBER to either end of the cable, insert the snorkel and press the button. The cable will be cleaned out while being recharged with fresh lubricant. Cables need not be removed from the machine. Aids in preventing throttle from freezing in the open position. Good to -70°F. Lubricates and rust proofs.



Cable Care Kit includes 1 6 1/4 oz Cable Life and 1 Cable Luber

Description	WPS#
Cable Care Kit	27-4800
Cable Life 6 1/4 oz can 24/case	27-4801
Cable Luber	27-4802



### CABLE LUBER

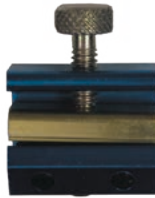

- Injects lubricants into cable with a minimum of mess
- Makes cables work as good as new
- Inexpensive

Description	WPS#
cable luber	57-8182
cable lube	57-0002



### CABLE LUBER



WPS#  
27-4820

## WD-40

- Prevents rust and corrosion
- Lubricates and will not gum up, even in freezing temperatures
- Penetrates rusted parts and frees them
- Displaces moisture on chains or electric parts
- Excellent for shop use



Description	WPS#
8 oz aerosol California Compliant 12/case	27-1125
11 oz aerosol California Compliant 12/case	27-1126
1 gal refill California Compliant 4/case	27-1127
Spray applicator (empty)	27-1122

## TRI-FLOW

### PENETRATING LUBRICANT

Light viscosity and high penetration. Resists water washout and the need for constant reapplication. Can carry heavy stress loads. Cleans and protects against dirt and build-up. Displaces moisture, prevents icing and inhibits the formation of rust and other corrosive build-ups. Sold Each.

Description	WPS#
2 oz Drip 12/case	27-4761
4 oz 12/case	27-4750
6 oz 12/case	27-4760
12 oz 6/case	27-4751
1 gal 4/case	27-4752
6.25 oz grease	27-4766



### CABLE LUBE



Description	WPS#
11 oz 6/case	57-0112



## ENZYME FUEL TREATMENT

### CURES AND PREVENTS ETHANOL FUEL PROBLEMS

Unique enzyme formula prevents phase separation and fuel gelling by breaking down water and sludge to sub-micron size particles allowing it to be safely burned away during normal engine operation, eliminating ethanol fuel problems.



Description	WPS#
1 oz single 24/case w/counter display	57-1150
1 oz 2/pk qty 12/2pk per case	57-1142
8 oz 6/case	57-1140
8 oz 12/case (High Concentrate)	57-1147
8 oz Diesel Treatment 6/case	57-1146
8 oz 6 pack w/counter display	57-1141
8 oz 24 pack w/counter display	57-1151
8 oz 48 pack w/floor display	57-1143
8 oz 96 pack w/floor display	57-1144
16 oz 12/case (High Concentrate)	57-1145
32 oz 12/case (High Concentrate)	57-1149
1 gal (High Concentrate)	57-1148

- Safe for all 2 and 4 cycle engines
- Stabilizes fuel for up to 2 years
- Rejuvenates old fuel
- Removes carbon and varnish
- Improves fuel economy
- Cannot be overdosed
- 8 oz bottle treats up to 48 gallons of gasoline
- 8 oz high concentrate bottle treats up to 128 gallons
- 16 oz bottle (highly concentrated) treats up to 256 gallons of gasolines
- 8 oz diesel formula treats up to 128 gallons of diesel

## DIESEL DR. COMPLETE

- Removes water from fuel
- Cleans and lubricates
- Prevents gelling to -40 degrees
- Reduces smoking
- Prevents algae growth
- Increases fuel mileage
- Boosts Certane and horsepower

Description	WPS#
4 oz 12/case	80-0244
16 oz 10/case	80-0245
1 gal 4/case	80-0246



## COMPLETE FUEL SYSTEM CLEANER

- Advanced combustion detergent
- Cleans injectors, carburetors and intake valves
- Removes carbon
- Improves air/fuel induction system
- Reduces exhaust emissions
- Improves fuel mileage

Description	WPS#
1 oz 24/case	80-0237
4 oz 12/case	80-0238



## ETHANOL EQUALIZER

- Stops all ethanol fuel problems
- Removes water from fuel
- Increases fuel mileage
- Increases horsepower
- Stabilizes fuel
- Boosts octane
- EPA registered



Description	WPS #
4 oz 12/case	80-0234
1 oz 24/case	80-0235
16 oz 10/case	80-0236
32oz 8/case	80-0242
1 gallon 4/case	80-0243



## WATER CELL

- Stops water problems by trapping it inside the Sta-Dri Water Cell before it enters your fuel system
- Weighted bag stays at bottom of tank
- Protective cylinder extends bag life

WPS#
57-1280



WINDSHIELDS / FAIRINGS  
 AUDIO / COMMUNICATION  
 SEATS / LUGGAGE  
 BARS / MIRRORS / CONTROLS  
 EXHAUST  
 AIR / FUEL SYSTEMS  
 ENGINE  
 TRANSMISSION / DRIVELINE  
 GASKETS / SEALS  
 ELECTRICAL  
 LIGHTING  
 CABLES  
 BRAKES  
 OIL FILTERS  
 SUSPENSION  
 BODY  
 WHEELS  
 TIRES / TIRE ACC.  
 BIKE ACC.  
 VICTORY / INDIAN  
 COVERS / LOCKS / TIEDOWNS  
 CHEMICALS  
 TOOLS  
 HELMETS  
 HELMET ACC.  
 EYEWEAR  
 APPAREL / RIDER ACC.  
 PROMOTIONAL  
 REFERENCE  
 INDEX



## METAL RESCUE™ RUST REMOVER BATH

- De-rust your motorcycle/ATV gas tank and all vehicle parts in one easy step!
- No messy creams or acids
- Safe, water-based formula is designed to remove rust from iron and steel
- Metal Rescue is non-toxic, easy to dispose of, biodegradable and re-usable
- Metal Rescue™ will not harm, paint, seals, gaskets, plastic, rubber, and is safe on bare skin
- Works well in all rust-removal applications such as chrome, wheels, mirrors, handle bars, kick stands
- For optimal results in fuel tank de-rusting, fill tank to its entirety with Metal Rescue™



Description	WPS#
1 quart bottle	27-4852
14 oz concentrate (makes 1 gallon)	27-4853
5 gal bucket	27-4851



## DRY COAT™ RUST PREVENTATIVE SPRAY

- Rust protection for your powersports vehicle during indoor storage or restoration projects.
- Safe, water-based formula prevents rust on iron and steel
- Quick and easy spray application
- Unique, non-sticky formula dries to the touch-not attracting dirt or dust
- Forms barrier coating to protect metal from rust formation
- Provides rust protection for up to 1 year of indoor storage
- Easily removed for paint or powder coat application



Description	WPS#
16 oz bottle	27-4862



## WORLD'S BEST CHROME POLISH™

### CHROME POLISH

- Removes blue, yellow and gold discoloration as well as rust and fingerprints
- Fine powder formula will not scratch chrome
- For use on chrome and stainless steel surfaces only
- Sold in a 12 pack, includes display box
- For best results, use with Blue-Job® Pipe Wipes™



### PIPE WIPES™

- 9½" x 4½" microfiber cloth
- Ideal for use with Blue-Job® chrome polish
- Sold in a 36 pack, includes display box

Description	WPS#
Chrome Polish	58-9300
Pipe Wipes	58-9305

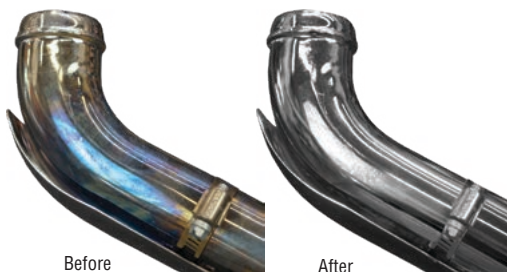

Before

After



WINDSHIELDS / FAIRINGS  
AUDIO / COMMUNICATION  
SEATS / LUGGAGE  
BARS / MIRRORS / CONTROLS  
EXHAUST  
AIR / FUEL SYSTEMS  
ENGINE  
TRANSMISSION / DRIVELINE  
GASKETS / SEALS  
ELECTRICAL  
LIGHTING  
CABLES  
BRAKES  
OIL FILTERS  
SUSPENSION  
BODY  
WHEELS  
TIRES / TIRE ACC.  
BIKE ACC.  
VICTORY / INDIAN  
COVERS / LOCKS / TIEDOWNS  
CHEMICALS  
TOOLS  
HELMETS  
HELMET ACC.  
EYEWEAR  
APPAREL / RIDER ACC.  
PROMOTIONAL  
REFERENCE  
INDEX

**COMBO PACK™**

Contains 1 pint Fuel Tank Liner, 1 pint Tank Prep A, 1/2 pint Tank Prep B. Enough for complete treatment of average size tanks. Shrink wrapped for convenience.

**TANK-PREP™**

Contains 1 pint Prep A, 1/2 pint Prep B. Prep A is a concentrated cleaner that dissolves rust and etches the tank surface. Prep B is a final rinse and conditioner to prepare the tank for KREEM liner.

**FUEL TANK LINER**

1 pint. Sold each. Produces a "tank within a tank", a tough lining that protects from rust and corrosion.

Approximately 1 pint is required per three gals of tank capacity.

**TANK-MASK**

Contains 1/2 pint of protective coating to be used on the outside painted surface of fuel tank while using Kreem tank liner. Washes off easily with soap and water.



	Description	WPS#
A	Combo Pack	27-4732
B	Tank Prep	27-4734
C	Fuel Tank Liner	27-4730
	Tank Mask	27-4735



**RECHARGER  
FILTER CARE SERVICE KIT**

A six-step maintenance system designed to recharge your K&N Filtercharger® Air Filter. Completely restores air flow efficiency so your Filtercharger® performs like new!

**KIT "A" CONTAINS:**

- 1 - 12 oz. Air Filter Cleaner Spray Bottle
- 1 - 8 oz. Squeeze Oil and Service Decal



**KIT "B" CONTAINS:**

- 1 - 12 oz. Air Filter Cleaner Spray Bottle
- 1 - 6.5 oz. Air Filter Oil Aerosol



	Size	WPS#
A	12/case	62-1514
B	12/case	62-1515

Size	WPS#
6.5 oz 12/case	62-1506
12 oz 12/case	62-1512
1 gal	62-1513

**AIR FILTER OIL**

Specially formulated to work in combination with the cotton fabric in K&N air filter elements providing a superior air filtration system. When used as directed, it quickly penetrates the filter pleats where it remains suspended in the cotton fabric. Saturation is maintained until the element is eventually cleaned with K&N Air Filter Cleaner and Degreaser.



Size	WPS#
12 oz 12/case	62-1530
32 oz 12/case	62-1532
1 gal 4/case	62-1531
5 gal Bucket	62-1533

**AIR FILTER CLEANER AND DEGREASER**

Formulated to clean K&N (cotton fabric type) air cleaners and air filter elements. K&N Cleaner and Degreaser works to dissolve oily dirt build-up and can be washed away with water. It is biodegradable and safe on paint, chrome, aluminum, plastic, rubber and vinyl.

**SEALING GREASE**

Provides an airtight fit around sealing surfaces on all types of air filter elements. It resists heat and will not melt and run off. K&N Sealing Grease is not to be used on clamp-on filter elements.

Size	WPS#
6 oz 12/case	62-1509

WINDSHIELDS / FAIRINGS  
AUDIO / COMMUNICATION  
SEATS / LUGGAGE  
BARS / MIRRORS / CONTROLS  
EXHAUST  
AIR / FUEL SYSTEMS  
ENGINE  
TRANSMISSION / DRIVELINE  
GASKETS / SEALS  
ELECTRICAL  
LIGHTING  
CABLES  
BRAKES  
OIL FILTERS  
SUSPENSION  
BODY  
WHEELS  
TIRES / TIRE ACC.  
BIKE ACC.  
VICTORY / INDIAN  
COVERS / LOCKS / TIEDOWNS  
CHEMICALS  
TOOLS  
HELMETS  
HELMET ACC.  
EYEWEAR  
APPAREL / RIDER ACC.  
PROMOTIONAL  
REFERENCE  
INDEX

# ThreeBond

## ADHESIVES AND THREAD LOCK

**A Low Strength Thread Lock #1342:** Perfect for small screws and bolts with applications that require a force of only 10-20% greater than used for tightening.



**B Medium-Strength Bearing and Stud Thread Lock #1333:** Retains high-strength properties for bearings and studs. Apply heat to soften for easier removal.



**C Medium-Strength Hi-Temperature Thread Lock #1360:** Incorporates anaerobic locking agents, and a heat-resistant element for sealing engine and exhaust parts.



**D Hi-Strength Thread Lock #1303:** For various threads, bolts and joints which must remain secure.



**E Liquid gasket #1184:** Excellent padding properties make this semi-drying sealer perfect for joint surfaces with large clearance. The synthetic rubber absorbs vibrations and impacts without failure, especially when coolants are involved.



**F Silicone liquid gasket #1211:** Silicone rubber. Perfect for sealing complex 3-point surfaces. 100% effective for temperature ranges of -60° to 250° C.



**G Synthetic Rubber Adhesive #1521:** Rubber-based contact cement for flexible hold to bond rubber, plastic, vinyl, metal, leather, wood, ceramic etc. Sets up in 5-10 min. Waterproof.



**H Super Glue #1742-B:** Attains practical use strength in seconds. No evaporative elements and no shrinkage to weaken bonding. Excellent for nonporous materials.

**I RTV Sealant (grey):** For sealing against oil and coolant leaks. Highly resistant to heat and cold. OEM specified for use on Motorcycles, ATV, UTV and Snowmobiles.



**J Gasket-Maker (black):** High viscosity, high performance, high heat. OEM specified, non-slumping paste highly resistant to oils, chemicals and coolant. Effective in vibrating conditions, containing strong adhesion properties.



**K Liquid Gasket (grey)** Solventless silicone sag type. Use in case to case Where NO GASKET is used.

**L Formed-In-Place (dark grey)** Engine RTV, formulated as a high performance temperature vulcanized silicone.



	Description	MFG.	Packaged	WPS#
<b>THREAD LOCK</b>				
A	Low Strength-Frequent repair	1342	10 ml 6/case	59-9110
A	Low Strength-Frequent repair	1342	50 ml 12/case	59-9115
B	Medium Bearing & Stud	1333	10 ml 6/case	59-9111
B	Medium Bearing & Stud	1333	50 ml 12/case	59-9116
C	Medium Hi Temperature	1360	10 ml 6/case	59-9112
C	Medium Hi Temperature	1360	50 ml 12/case	59-9117
D	Hi-Strength	1303	10 ml 6/case	59-9113
D	Hi-Strength	1303	50 ml 12/case	59-9118
<b>LIQUID GASKET</b>				
E	Liquid Gasket	1184	3.5 oz 12/case	59-9108
F	Silicone Liquid Gasket	1211	3.5 oz 12/case	59-9101
<b>GLUE AND ADHESIVE</b>				
G	Synthetic Rubber Adhesive	1521	5.3 oz 12/case	59-9119
H	Super Glue	1742B	2 gm 24/Case	59-9120
I	RTV Sealant (grey)	1200GAU3Z	3.8oz 12/case	59-9102
J	Gasket-Maker (black)	1207B	3.5 oz 12/case	59-9109
K	Liquid Gasket	1215	250 gm 6/case	59-9124
L	Formed-in-place	1217H	5.0 oz 6/case	59-9125





## HIGH TACK™ GASKET SEALANT

- Fast drying, all purpose sealant dries to a tacky, non-brittle film
- Resists gasoline, oil, antifreeze, diesel, kerosene, propane and butane
- Temperature range -65° F to 500° F

Description	WPS#
4 oz brush top can	59-9189
4 oz aerosol	59-9190



## MOTOSEAL™

- Solvent-based bond fully seals within 20 minutes
- Resists gasoline and other damaging fluids
- Flexible bond that is highly effective on irregular and uneven joint surfaces
- Ideal for use on frequently disassembled engines

Description	WPS#
2.7 oz tube	6/case 59-9183



## ULTRA BLACK HI-TEMP RTV SILICONE

- Fast-curing formula, sensor safe, low odor, noncorrosive
- Meets performance specs of OE silicone gaskets
- Retains high flexibility, oil resistance properties
- Temperature range -65°F to 550°F intermittent

Description	WPS#
Ultra Black 3.35 oz	12/case 59-9219



## COPPER SPRAY-A-GASKET®

- Fast drying, metallic copper sealant helps dissipate heat, prevents gasket burnout, and improves heat transfer
- Fills minor surface irregularities, seals instantly
- Temperature range -50° F to 500° F, resists all types of automotive fluids, especially gasoline

Description	WPS#
9 oz aerosol	12/case 59-9194



## HIGH TEMP RTV SILICONE

- Recommended for valve covers, oil pans, timing covers, thermostat housings and transmission covers
- Temperature range -75° to 650°F

Description	WPS#
3 oz tube	12/case 59-9185



## BLUE RTV SILICONE

- Recommended for valve covers, oil pans, timing covers, thermostat housings and transmission covers
- Temperature range -65° to 500°F

Description	WPS#
3 oz tube	12/case 59-9184



## RIGHT STUFF™ POWERBEAD™ GASKET MAKER

- Elastomeric rubber gasket rubber gasket technology is blowout resistant and out performs pre-cut gaskets
- Protects against leaks caused by vibration and thermal expansion, sensor safe
- Temperature range -75° F to 450° F continuous, 500° F intermittent
- 7.5 oz size in a PowerBead™ pressurized can

Description	WPS#
7.5 oz can	6/case 59-9193
3 oz can	6/case 59-9203



## ULTRA COPPER® SILICONE GASKET SEALANT

- The most advanced RTV silicone gasket available
- Three times more oil resistant than conventional silicones, eight times more flexible than cut gaskets
- Temperature range -65° F to 700° F

Description	WPS#
3 oz tube	12/case 59-9192



WINDSHIELDS / FAIRINGS
AUDIO / COMMUNICATION
SEATS / LUGGAGE
BAR / MIRRORS / CONTROLS
EXHAUST
AIR / FUEL SYSTEMS
ENGINE
TRANSMISSION / DRIVELINE
GASKETS / SEALS
ELECTRICAL
LIGHTING
CABLES
BRAKES
OIL FILTERS
SUSPENSION
BODY
WHEELS
TIRES / TIRE ACC.
BIKE ACC.
VICTORY / INDIAN
COVERS / LOCKS / TIEDOWNS
CHEMICALS
TOOLS
HELMETS
HELMET ACC.
EYEWEAR
APPAREL / RIDER ACC.
PROMOTIONAL
REFERENCE
INDEX



## GASKET REMOVER

- Quickly removes solvent based gasket adhesives and sealants, even baked on gaskets
- Eliminates scraping and potential damage to flanged surfaces
- Prepares surfaces for new gaskets
- Not for use with silicone sealants



Description	WPS#
4 oz aerosol 6/case	59-9195

## ANAEROBIC GASKET MAKER

- Non-corrosive gasket material designed for use on aluminum, iron and steel flanged mating surfaces
- Fills gaps up to .015" and cures to a solvent resistant that will not tear or decay during service
- Allows for easy disassembly, old gasket material can be removed with a putty knife
- Great for split crank cases, water pumps, chain cases and transmission cases



Description	WPS#
50 ml tube 6/case	59-9191

## WEATHER STRIP ADHESIVE

- A superior adhesive ideal for many applications including rubber, metal, auto or van carpeting and fabric-backed vinyl upholstery and automotive gaskets
- Allows for repositioning parts after contact is made
- Withstands extreme temperatures is waterproof and resists gasoline, kerosene, antifreeze and most solvents
- Also works great as a grip glue



Description	WPS#
2 oz tube 12./case	59-9180

## ANTI-SEIZE LUBRICANT

- A highly refined blend of aluminum, copper and graphite lubricants
- Prevents galling, corrosion and seizing
- Great for spark plugs, cylinder head bolts and exhaust bolts
- Temperature range -60° F to 1600° F



Description	WPS#
1 oz tube 12/case	59-9196
4 oz bottle 12/case	59-9197

## COLD WELD BONDING COMPOUND

- A 15 minute, two-part adhesive and filler system that hardens like steel
- It can be drilled, sanded, painted and filed
- Resists most automotive, shop and cleaning fluids
- Withstands temperatures to 300° F



Description	WPS#
Two 1 oz tubes 12/case	59-9200

## GENERAL PURPOSE EPOXY

- Versatile, easy to use, general purpose epoxy
- Works for ceramic, chrome, fabric, fiberglass, glass, hard plastic, rubber and metal
- Resists most liquids.
- Convenient 2-part dispensing syringe
- Fills gaps and bonds trim
- Crystal clear appearance
- Resists temperatures up to 180° F.



Description	WPS#
General purpose .84 fl oz 12/case	59-9223

WINDSHIELDS / FAIRINGS  
AUDIO / COMMUNICATION  
SEATS / LUGGAGE  
BARS / MIRRORS / CONTROLS  
EXHAUST  
AIR / FUEL SYSTEMS  
ENGINE  
TRANSMISSION / DRIVELINE  
GASKETS / SEALS  
ELECTRICAL  
LIGHTING  
CABLES  
BRAKES  
OIL FILTERS  
SUSPENSION  
BODY  
WHEELS  
TIRES / TIRE ACC.  
BIKE ACC.  
VICTORY / INDIAN  
COVERS / LOCKS / TIEDOWNS  
CHEMICALS  
TOOLS  
HELMETS  
HELMET ACC.  
EYEWEAR  
APPAREL / RIDER ACC.  
PROMOTIONAL  
REFERENCE  
INDEX



## DIELECTRIC GREASE

- Protects electrical connections and wiring from salt, dirt and corrosion
- Prevents voltage leakage around any electrical connection
- Keeps spark plugs from fusing to boots



Description	WPS#
3 oz tube 12/case	59-9199

## VALVE GRINDING COMPOUND

- Aids in valve grinding and seating operations
- Can be used for lapping and grinding chromium
- Mixes with water to form an easy to use paste



Description	WPS#
3 oz tube 12/case	59-9198

## PENETRATING THREADLOCKER

- Low viscosity thread locking liquid which always it to wick down the threads of assembled fasteners
- This allows preventive maintenance procedures to be greatly simplified
- Recommended for fasteners from #2 to 1/2 inch



Description	WPS#
Green Threadlocker 6ml	6/case 59-9216
Green Threadlocker 36ml	6/case 59-9217

## MULTI-METAL EPOXY

- Versatile, easy-to-use, multi-metal epoxy adhesive is two-part adhesive and filler
- Eliminates the need for welding or brazing
- Sets in four minutes with no clamping needed
- Fills gaps and will not shrink
- When cured, can be drilled, sanded, threaded or filed
- Resistant to water and solvents
- Temperature range -60°F to 300°F (-51°C to 149°C)
- Permanent strength up to 4500 PSI



Description	WPS#
Multi-Metal .84 fl oz	12/case 59-9224

## FUEL TANK REPAIR KIT

- Permanent repair
- Easy-to-use complete kit
- Repairs all types of metal tanks



Description	WPS#
Kit	6/case 59-9181

## HIGH TEMPERATURE THREAD SEALANT

- Locks and seals threaded fittings, great for fuel, cooling and hydraulic fittings
- Resists leakage, vibration loosening and moisture
- Won't shred or wear like thread sealing tape
- Temperature range -65° F to 400° F



Description	WPS#
6 ml tube	12/case 59-9187
50 ml tube	6/case 59-9188

- WINDSHIELDS / FAIRINGS
- AUDIO / COMMUNICATION
- SEATS / LUGGAGE
- BARS / MIRRORS / CONTROLS
- EXHAUST
- AIR / FUEL SYSTEMS
- ENGINE
- TRANSMISSION / DRIVELINE
- GASKETS / SEALS
- ELECTRICAL
- LIGHTING
- CABLES
- BRAKES
- OIL FILTERS
- SUSPENSION
- BODY
- WHEELS
- TIRES / TIRE ACC.
- BIKE ACC.
- VICTORY / INDIAN
- COVERS / LOCKS / TIEDOWNS
- CHEMICALS
- TOOLS
- HELMETS
- HELMET ACC.
- EYEWEAR
- APPAREL / RIDER ACC.
- PROMOTIONAL
- REFERENCE
- INDEX



## GEL THREADLOCKER

- Gel formula provides "liquid-reliability" without drips, globs, mess or waste
- Available in blue (medium strength) and red (high strength) formulas in a 5 gram tube and 10 gram twist applicator



Description	WPS#
Blue Threadlocker 5gr	6/case <b>59-9172</b>
Blue Threadlocker 10gr	6/case <b>59-9173</b>
Red Threadlocker 5gr	6/case <b>59-9174</b>
Red Threadlocker 10gr	6/case <b>59-9175</b>

## LIQUID THREADLOCKER

- Liquid formula is the standard in the industry, give the protection of security with out the use of lock washers or lock nuts.
- Available in blue (medium strength) and red (high strength) formulas in convenient sizes.



Description	WPS#
Blue Threadlocker 6ml	6/case <b>59-9212</b>
Blue Threadlocker 36ml	6/case <b>59-9213</b>
Red Threadlocker 6ml	6/case <b>59-9214</b>
Red Threadlocker 36ml	6/case <b>59-9215</b>

## ENGINE ASSEMBLY LUBE

- Gives proper lubrication of metal mating surfaces prior to starting a new or rebuilt engine
- Adheres to component surfaces to prevent scuffing and galling during initial start-up
- This high quality formulation meets or exceeds OEM performance specs for engine assembly lubricants



Description	WPS#
Engine Assy. Lube 4oz	12/case <b>59-9218</b>

## DECAL AND ADHESIVE REMOVER

- Fast-acting formula quickly removes adhesive residue, decals, bumper & window stickers, tape, tar, sap, bugs, grease, and other sticky substances
- Contains no acetone and is safe for use on virtually any surface including windows, auto body paint, bumpers, vinyl, leather, fabric, metal, plastic, and wood
- Safe for indoor use, great for removing dirt bike graphics



Description	WPS#
5 oz Aerosol	12/case <b>59-9176</b>

## LIQUID ELECTRICAL TAPE

- Weatherproof protectant for wiring and electrical connections
- Goes on as a liquid and dries to a vinyl polymer that resists dirt, dust, chemicals and moisture
- Brush top applicator allows coverage without gaps and enables access to tight spaces that roll tape and shrink tubing can't get to



Description	WPS#
4 oz Bottle	6/case <b>59-9178</b>

## GREZ OFF™ DEGREASER

- A biodegradable, water based, heavy-duty degreaser that effectively removes grease and dirt
- Works as well as traditional solvents, is non-flammable and VOC compliant in all 50 states



Description	WPS#
32 oz bottle	12/case <b>59-9179</b>



## BLACK NITRILE GLOVES

- 100% synthetic rubber that provides superior resistance to a wide range of solvents and hazardous chemicals
- They feature textured fingers that provide a secure grip on dirty parts and tools.
- These powder-free 5 mil thick gloves provide increased durability and protection and are suitable for users with latex sensitivity

Description	WPS#
L 10/case	59-9211L
XL 10/case	59-9211X



## HAND CLEANER

- Biodegradable, waterless, petroleum solvent free hand cleaner
- Contains no harsh chemicals, mineral oils or ammonia
- Citrus cleaning power with fine pumice, fortified with lanolin, glycerin, and other skin conditioners

Description	WPS#
1 gal bottle w/pump	4/case 59-9202



## HAND WIPES

- Removes the toughest grease, tar, grime, ink, paints, sealants, adhesives and other difficult soils
- Each pre-moistened wipe has a textured surface on one side that is ideal for cleaning heavy-duty soils from hands, tools and work areas

Description	WPS#
25 ct tube	8/case 59-9206

- WINDSHIELDS / FAIRINGS
- AUDIO / COMMUNICATION
- SEATS / LUGGAGE
- BARS / MIRRORS / CONTROLS
- EXHAUST
- AIR / FUEL SYSTEMS
- ENGINE
- TRANSMISSION / DRIVELINE
- GASKETS / SEALS
- ELECTRICAL
- LIGHTING
- CABLES
- BRAKES
- OIL FILTERS
- SUSPENSION
- BODY
- WHEELS
- TIRES / TIRE ACC.
- BIKE ACC.
- VICTORY / INDIAN
- COVERS / LOCKS / TIEDOWNS
- CHEMICALS**
- TOOLS
- HELMETS
- HELMET ACC.
- EYEWEAR
- APPAREL / RIDER ACC.
- PROMOTIONAL
- REFERENCE
- INDEX



# SERIAL DIAGNOSTIC SYSTEM



Professional diagnostic tool for Harley Davidson & Buell workshops and tuning centers. Diagnoses electronic fuel injection module (EFI) and others (Security modules, ABS, etc.) through the diagnostic connector. The system consists of a communication interface with Harley-Davidson adapter, USB cable for connection to your Laptop (PC) and software (SOLD SEPARATELY) compatible with Windows XP, Vista, 7, 8 and 10. A wireless Bluetooth version of the interface is also available. An adapter for CAN-BUS models is included. The system performs the following functions and more. Software for Indian and Victory is also available.

## OVERVIEW OF CONTROL UNITS THAT CAN BE DIAGNOSED ON HARLEY DAVIDSONS

- Ignition Module
- EFI (Electronic Fuel Injection Module) - All models
- TSSM (Turn Signal Security Module)..... Key FOB with button
- HFSM (Hands Free Security Module)..... Key FOB without button
- BCM (Body Control Module).....Key FOB without button
- Gauges (Speedo, Tach and Instrument Module) - All models
- ABS Module (Delphi + CAN models) - All models
- Radio and Audio all models
- Thunder MAX EFI
- Read and Clear Diagnostic Trouble Codes.....All models
- Read Identification data (part numbers, VIN number).....All models
- Monitoring real-time data (throttle position, temperature, oxygen sensors, turn signals etc.)
- Test actuators (injectors, coils, main relay, fuel pump, idle, turn signals, tachometer, lamps etc.)
- Buell diagnostics are incorporated in Harley-Davidson diagnostics
- Unit of measure selection metric/standard
- Communication interface is CAN ready (models with 6-pin connector)



## MOTORCYCLE REPORT

Search for and identify all embedded control units, read fault code memory + generate and print a diagnostic report with odometer reading

## TOOLBOX (special functions that can be performed)

- Module replacement -TSM, TSSM, HFSM, BCM,
- ABS Service (Bleeding and configuration, Delphi + CAN models) - All models
- ACR (Automatic compression release during starting)
- Cruise Control, Exhaust actuator, EITMS..... enable/disable
- Side Stand Switch Configuration - All Models
- Intake Solenoid Valve Configuration on CAN Models
- Radio customization-region code and speaker configuration, radio pairing
- J&M Audio Configuration
- ABS Telltale Configuration on CAN Models
- Idle speed adjustment 800 - 1200 rpm (models with Delphi Electronic Fuel Injection Module)
- TSSM Customization..... PIN read/change, Auto arming disable/enable etc.
- HFSM Customization..... Key FOB assignment/ replacement, Auto arming disable/enable, PIN read/change, Side car and Service Mode (disable/enable)
- BCM Customization..... Key FOB assignment/ replacement, Auto arming disable/enable, PIN read/change, Lights configuration, keyless ignition
- Disarming (HFSM/ BCM module).....PIN read/FOB assignment on armed bike (for BCM modules a CAN disarming cable is needed)
- Buell TPS adjustment
- Datalogging
- ABS Module (embedded/ not embedded)
- Speedo module pairing
- Wheel size adjustment (Speedo calibration)
- Odometer unit setting



## OVERVIEW OF CONTROL UNITS THAT CAN BE DIAGNOSED ON INDIAN AND VICTORY

- Indian - 2014 - 2017
- Victory - 2008 - 2017
- Engine control module
- ABS control module
- Gauge (Speedo, Tacho ...) module
- Vehicle control module
- Radio control module
- Read Vehicle information
- Read and Clear
- Diagnostic Trouble Codes
- Monitoring Real-Time data

## MOTORCYCLE REPORT

Search for and identify all embedded control units, read fault code memory + generate and print a diagnostic report.

	Description	WPS#
A	USB Serial Interface (w/Case)	867-02000
B	USB Serial Interface (w/Case) Bluetooth	867-02001
C	Diagnostic Software for Harley Davidson	867-02002
	Diagnostic Software for Indian/Victory	867-02004
D	Voltmeter Module	867-02020
E	CAN Disarming Cable	867-02021
	Replacement Interface to Bike Cable 4-Pin	867-02010
	Replacement Interface to Bike Cable 6-Pin	867-02011
	Replacement Computer to Interface Cable	867-02012

**PARALLEL DIAGNOSTIC SYSTEM**

Parallel diagnostics are designed for measuring input and output signals from the electronic fuel injection module (EFI) and other modules. Measurements can be made on running engines. The system consists of a wiring harness adapter and breakout box. The breakout box is inserted between EFI module and motorcycle's wiring harness so that the system continues to function as normal. Monitoring points for all connector pins of the EFI module are clearly arranged on the breakout box. It is possible to measure signals and waveforms from all systems and actuators. Disconnecting the ECU from the breakout box allows quick and reliable check of the integrity of the wiring harness in respect to continuity, and leakage currents. Universal connector kit includes common adapters (73 connectors) for non destructive diagnostic operations on the wiring harness.



A

Description	WPS#
A Breakout Box	<b>867-02022</b>
B 36 Pin Delphi EFI Adapter	<b>867-02023</b>
C 73 Pin Delphi EFI Adapter	<b>867-02024</b>
D 35 Pin Magnetti and Bosch EFI Adapter	<b>867-02025</b>
E 12/4 Pin Security Module Adapter	<b>867-02026</b>
F 18/18 Pin CAN BUS Delphi EFI Adapter	<b>867-02027</b>
G 36/48 Pin BCM Module Adapter	<b>867-02028</b>
H Universal Connector Kit	<b>867-02040</b>



B



C



D



E



F



G



H

- WINDSHIELDS / FAIRINGS
- AUDIO / COMMUNICATION
- SEATS / LUGGAGE
- BAR / MIRRORS / CONTROLS
- EXHAUST
- AIR / FUEL SYSTEMS
- ENGINE
- TRANSMISSION / DRIVELINE
- GASKETS / SEALS
- ELECTRICAL
- LIGHTING
- CABLES
- BRAKES
- OIL FILTERS
- SUSPENSION
- BODY
- WHEELS
- TIRES / TIRE ACC.
- BIKE ACC.
- VICTORY / INDIAN
- COVERS / LOCKS / TIEDOWNS
- CHEMICALS
- TOOLS**
- HELMETS
- HELMET ACC.
- EYEWEAR
- APPAREL / RIDER ACC.
- PROMOTIONAL
- REFERENCE
- INDEX



## DIAGNOSTIC SCAN TOOLS

### A. TWIN SCAN II ABS PLUS KIT

- Includes Twin Scan II ABS
- WEGO IIID Interface
- Two Bosch LSU 4.2 wide-band oxygen sensors
- Two 18 x 1.5 mm weld nuts, two 18 x 1.5 mm hex socket plugs
- USB cable and software on CDROM



### B. TWIN SCAN 3 ABS PLUS KIT

- Includes Twin Scan 3 ABS
- WEGO IIID Interface
- Two Bosch LSU 4.2 wide-band oxygen sensors
- Two 18 x 1.5 mm weld nuts, two 18 x 1.5 mm hex socket plugs
- USB cable and software on CDROM



### C. TWIN SCAN COMPLETE KIT

- Includes both Twin Scan II ABS and Twin Scan 3 ABS units
- WEGO IIID Interface
- Two Bosch LSU 4.2 wide-band oxygen sensors
- Two 18 x 1.5 mm weld nuts, two 18 x 1.5 mm hex socket plugs
- USB cable, probe kit, and software on CDROM



- WINDSHIELDS / FAIRINGS
- AUDIO / COMMUNICATION
- SEATS / LUGGAGE
- BARS / MIRRORS / CONTROLS
- EXHAUST
- AIR / FUEL SYSTEMS
- ENGINE
- TRANSMISSION / DRIVELINE
- GASKETS / SEALS
- ELECTRICAL
- LIGHTING
- CABLES
- BRAKES
- OIL FILTERS
- SUSPENSION
- BODY
- WHEELS
- TIRES / TIRE ACC.
- BIKE ACC.
- VICTORY / INDIAN
- COVERS / LOCKS / TIEDOWNS
- CHEMICALS
- TOOLS**
- HELMETS
- HELMET ACC.
- EYEWEAR
- APPAREL / RIDER ACC.
- PROMOTIONAL
- REFERENCE
- INDEX



# DIAGNOSTIC SCAN TOOLS



- WINDSHIELDS / FAIRINGS
- AUDIO / COMMUNICATION
- SEATS / LUGGAGE
- BARS / MIRRORS / CONTROLS
- EXHAUST
- AIR / FUEL SYSTEMS
- ENGINE
- TRANSMISSION / DRIVELINE
- GASKETS / SEALS
- ELECTRICAL
- LIGHTING
- CABLES
- BRAKES
- OIL FILTERS
- SUSPENSION
- BODY
- WHEELS
- TIRES / TIRE ACC.
- BIKE ACC.
- VICTORY / INDIAN
- COVERS / LOCKS / TIEDOWNS
- CHEMICALS
- TOOLS
- HELMETS
- HELMET ACC.
- EYEWEAR
- APPAREL / RIDER ACC.
- PROMOTIONAL
- REFERENCE
- INDEX



D

### D. TWIN SCAN II ABS

- Compatible with 2003-2006 carbureted models with new 12 pin ignition module
- Anti-Skid brake system (ABS) brake bleeding functions for 2008-2013 Touring models
- Support for 2006-2013 closed loop fuel injection systems
- Real time display of engine data on instrument panel type display
- Uses laptop PC for display, includes Windows software

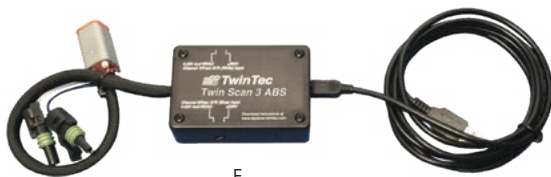

E

### E. TWIN SCAN 3 ABS

- Anti-Skid brake system (ABS) brake bleeding functions for 2008-2013 Touring models
- Real time display of engine data on instrument panel type display
- Includes two analog inputs with 0-20V or +200V range
- Features two channel scopemeter capability for waveform display
- Analog inputs can also be used for air/fuel ratio
- Uses laptop PC for display, includes Windows software

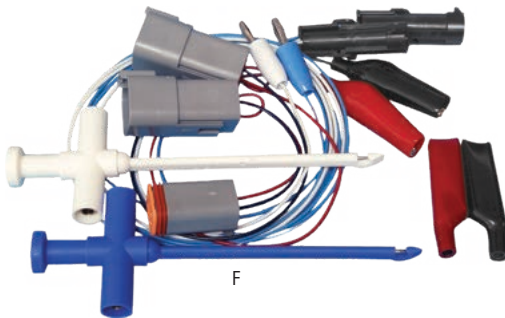

F

### F. TWIN SCAN 3 PROBE KIT

- For scopemeter feature
- Two insulation piercing probes
- 12 volt power adapter



G

### G. TWIN SCAN WEGO UPGRADE KIT

- For customers with any Twin Scan II or 3 version
- Includes WEGO IID Interface
- Two Bosch LSU 4.2 wide-band oxygen sensors, two 18 x 1.5 mm weld nuts, and two 18 x 1.5 mm hex socket plugs
- \*Compatible with 2001-2014 HD fuel injected models using the Delphi system (including V-Rod) with J1850 data bus.
- Not compatible with 2011-2014 Softail and 2012-2014 Dyna models with CAN data bus



H



I



J

	Application	WPS#
A	'01-15 fuel injected models and '03-06 Carbureted models	<b>132-7024</b> *
B	'11-15 Softail, '12-15 Dyna, '14-15 XL and Touring models with CAN data bus	<b>132-7026</b>
C	Twin Scan Complete Kit	<b>132-7031</b>
D	'01-15 fuel injected models and '03-06 Carbureted models	<b>132-7022</b> *
E	'11-15 Softail and '12-15 Dyna models with CAN data bus	<b>132-7023</b>
F	Twin Scan 3 ABS Probe Kit	<b>132-7027</b>
G	Twin Scan Wego Upgrade Kit	<b>132-7028</b>
	Single channel Wego 3 system wide band w/ harness and software	<b>132-7058</b>

#### REPLACEMENT PARTS

H	O2 sensor for Wego3 and Twin Scan 3	<b>132-7059</b>
I	Weld nut for O2 sensor	<b>132-7061</b>
J	Hex plug for O2 sensor weld nut	<b>132-7063</b>

\*Compatible with 2001-2013 HD fuel injected models using the Delphi system (including V-Rod) with J1850 data bus.  
Not compatible with 2011-2014 Softail and 2012-2014 Dyna models with CAN data bus



### 1/4" 6 POINT SOCKET SETS

- Chrome vanadium alloy steel for strength and durability
- Recessed edges with openings designed to reduce fastener rounding
- Polished nickel chrome plated finish
- Lifetime warranty
- SAE socket sets include: 5/32", 3/16", 7/32", 1/4", 9/32", 5/16", 11/32", 3/8", 7/16" and 1/2" sockets
- Metric socket sets include: 4 mm, 5 mm, 6 mm, 7 mm, 8 mm, 9 mm, 10 mm, 11 mm, 12 mm and 13 mm sockets

Description	Shallow	Deep
1/4" SAE socket set	<b>117-1067</b>	<b>117-1069</b>
1/4" Metric socket set	<b>117-1068</b>	<b>117-1070</b>



SAE Shallow



Metric Deep

### 3/8" 6 POINT SOCKET SETS

- Chrome vanadium alloy steel for strength and durability
- Recessed edges with openings designed to reduce fastener rounding
- Polished nickel chrome plated finish
- Lifetime warranty
- SAE shallow socket sets include: 1/4", 5/16", 3/8", 7/16", 1/2", 9/16", 5/8", 11/16", 3/4" and 13/16" sockets
- SAE deep socket sets include: 3/8", 7/16", 1/2", 9/16", 5/8", 11/16", 3/4", 13/16", 7/8" and 15/16" sockets
- Metric socket sets include: 10 mm, 11 mm, 12 mm, 13 mm, 14 mm, 15 mm, 16 mm, 17 mm, 18 mm and 19 mm sockets

Description	Shallow	Deep
3/8" SAE socket set	<b>117-1104</b>	<b>117-1106</b>
3/8" Metric socket set	<b>117-1105</b>	<b>117-1107</b>



SAE Shallow



Metric Shallow

### 1/2" 6 POINT SOCKET SETS

- Chrome vanadium alloy steel for strength and durability
- Recessed edges with openings designed to reduce fastener rounding
- Polished nickel chrome plated finish
- Lifetime warranty
- SAE shallow socket sets include: 1/2", 9/16", 5/8", 11/16", 3/4", 13/16", 7/8", 15/16" and 1" sockets
- SAE deep socket sets include: 1/2", 9/16", 5/8", 11/16", 3/4", 13/16", 7/8", and 15/16" sockets
- Metric shallow socket sets include: 12 mm, 13 mm, 14 mm, 15 mm, 16 mm, 17 mm, 18 mm, 19 mm and 22 mm sockets
- Metric deep socket sets include: 12 mm, 13 mm, 14 mm, 15 mm, 16 mm, 17 mm, 18 mm and 19 mm sockets

Description	Shallow	Deep
1/2" SAE socket set	<b>117-1058</b>	<b>117-1060</b>
1/2" Metric socket set	<b>117-1059</b>	<b>117-1061</b>



SAE Shallow



Metric Shallow



### QUICK RELEASE RATCHETS

- Chrome vanadium construction for strength and durability
- Larger gear teeth for higher torque capabilities and added strength
- Quick release feature for fast and easy socket changes
- Polished nickel chrome plated finish
- Lifetime warranty

Description	WPS#
1/4" Ratchet	117-1066
3/8" Ratchet	117-1073
1/2" Ratchet	117-1055



### TORQUE WRENCHES

- High grade spring steel torque mechanism
- Patented torque adjusting lock/unlock collar
- Includes heavy duty storage case

Description	WPS#
1/4" Torque wrench, 25 - 250 in/lbs	117-1100
3/8" Torque wrench, 10 - 100 ft/lbs	117-1101
1/2" Torque wrench, 25 - 250 ft/lbs	117-1102



### SOCKET EXTENSION SETS

- Chrome vanadium alloy steel for strength and durability
- Polished nickel chrome plated finish
- Available in standard and wobble versions, sold in sets
- Lifetime warranty

Description	Standard	Wobble
1/4" Drive, 2"/3"/6" set	117-1071	
3/8" Drive, 1 3/4"/3"/8" set	117-1075	117-1076
1/2" Drive, 3"/5"/10" set	117-1057	117-1054



### SOCKET U-JOINT AND ADAPTER SETS

- Chrome vanadium construction for strength and durability
- Polished nickel chrome plated finish
- U-joint set includes 1/4", 3/8" and 1/2" sizes
- Adapter set includes 1/4" to 3/8", 3/8" to 1/4", 3/8" to 1/2" and 1/2" to 3/8" adapters
- Lifetime warranty

Description	WPS#
U-joint set	117-1050
Adapter set	117-1051

- WINDSHIELDS / FAIRINGS
- AUDIO / COMMUNICATION
- SEATS / LUGGAGE
- BAR / MIRRORS / CONTROLS
- EXHAUST
- AIR / FUEL SYSTEMS
- ENGINE
- TRANSMISSION / DRIVELINE
- GASKETS / SEALS
- ELECTRICAL
- LIGHTING
- CABLES
- BRAKES
- OIL FILTERS
- SUSPENSION
- BODY
- WHEELS
- TIRES / TIRE ACC.
- BIKE ACC.
- VICTORY / INDIAN
- COVERS / LOCKS / TIEDOWNS
- CHEMICALS
- TOOLS**
- HELMETS
- HELMET ACC.
- EYEWEAR
- APPAREL / RIDER ACC.
- PROMOTIONAL
- REFERENCE
- INDEX

- WINDSHIELDS / FAIRINGS
- AUDIO / COMMUNICATION
- SEATS / LUGGAGE
- BARS / MIRRORS / CONTROLS
- EXHAUST
- AIR / FUEL SYSTEMS
- ENGINE
- TRANSMISSION / DRIVELINE
- GASKETS / SEALS
- ELECTRICAL
- LIGHTING
- CABLES
- BRAKES
- OIL FILTERS
- SUSPENSION
- BODY
- WHEELS
- TIRES / TIRE ACC.
- BIKE ACC.
- VICTORY / INDIAN
- COVERS / LOCKS / TIEDOWNS
- CHEMICALS
- TOOLS**
- HELMETS
- HELMET ACC.
- EYEWEAR
- APPAREL / RIDER ACC.
- PROMOTIONAL
- REFERENCE
- INDEX



## HEX AND STAR SOCKET SETS

- Chrome vanadium alloy steel construction for strength and durability
- Hardened alloy steel bits
- Polished nickel chrome plated finish
- Lifetime warranty
- SAE hex socket sets include: 1/8", 9/64", 5/32", 3/16", 7/32", 1/4", 5/16" and 3/8" sockets
- Metric hex socket sets include: 3 mm, 4 mm, 5 mm, 6 mm, 7 mm, 8 mm, 9 mm and 10 mm sockets
- Star socket sets include: T10, T15, T20, T25, T27, T30, T40, T45 and T50 sockets



Description	WPS#
SAE hex socket set, 3/8" drive	117-1081
Metric hex socket set, 3/8" drive	117-1082
Star socket set, 3/8" drive	117-1028

## SPARK PLUG SOCKET SET

- Chrome vanadium alloy steel for strength and durability
- Polished nickel chrome plated finish
- Lifetime warranty
- Set includes: 5/8", 3/4", 13/16", 14 mm and 18 mm spark plug sockets



Description	WPS#
Spark plug socket set	117-1052

## SOCKET RAILS

- Securely holds sockets during storage/transport
- Lifetime warranty

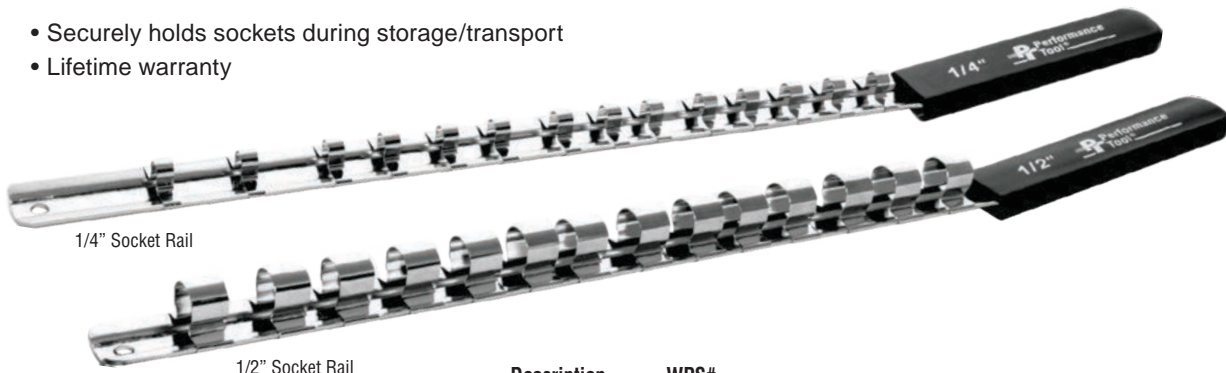

Description	WPS#
1/4" Socket rail	117-1064
3/8" Socket rail	117-1072
1/2" Socket rail	117-1053



SAE Shallow



Metric Deep

### 3/8" IMPACT SOCKET SETS

- Made from drop forged chrome vanadium steel for strength and durability
- Rounded corners for a tighter grip
- Large size laser etching for easy identification
- Lifetime warranty
- SAE shallow socket sets include: 5/16", 3/8", 7/16", 1/2", 9/16", 5/8", 11/16" and 3/4" sockets
- SAE deep socket sets include: 3/8", 7/16", 1/2", 9/16", 5/8", 11/16", 3/4" and 13/16" sockets
- Metric shallow socket sets include: 8 mm, 10 mm, 11 mm, 12 mm, 13 mm, 14 mm, 17 mm, 19 mm
- Metric deep socket sets include: 10 mm, 11 mm, 12 mm, 13 mm, 14 mm, 16 mm, 17 mm, 19 mm

Description	Shallow	Deep
3/8" SAE impact socket set	<b>117-1000</b>	<b>117-1002</b>
3/8" Metric impact socket set	<b>117-1001</b>	<b>117-1003</b>



SAE Shallow



Metric Deep

### 1/2" IMPACT SOCKET SETS

- Made from drop forged chrome vanadium steel for strength and durability
- Rounded corners for a tighter grip
- Large size laser etching for easy identification
- Lifetime warranty
- SAE shallow socket sets include: 7/16", 1/2", 9/16", 5/8", 11/16", 3/4", 13/16", 7/8", 15/16", 1"
- SAE deep socket sets include: 3/8", 7/16", 1/2", 9/16", 5/8", 11/16", 3/4", 13/16", 7/8", 1"
- Metric shallow socket sets include: 10 mm, 13 mm, 14 mm, 15 mm, 16 mm, 17 mm, 18 mm, 19 mm, 21 mm, 22 mm
- Metric deep socket sets include: 10 mm, 12 mm, 13 mm, 14 mm, 15 mm, 16 mm, 17 mm, 18 mm, 19 mm, 21 mm, 22 mm

Description	Shallow	Deep
1/2" SAE impact socket set	<b>117-1004</b>	<b>117-1006</b>
1/2" Metric impact socket set	<b>117-1005</b>	<b>117-1007</b>

### OXYGEN SENSOR SOCKET



- Fits 7/8" hex oxygen sensors
- 3/8" Drive 6 point socket with cutaway portion for wire clearance
- Offset design for confined areas
- Heavy duty alloy steel construction
- Lifetime warranty

Description	WPS#
Oxygen sensor socket	<b>117-1103</b>

WINDSHIELDS / FAIRINGS  
 AUDIO / COMMUNICATION  
 SEATS / LUGGAGE  
 BARS / MIRRORS / CONTROLS  
 EXHAUST  
 AIR / FUEL SYSTEMS  
 ENGINE  
 TRANSMISSION / DRIVELINE  
 GASKETS / SEALS  
 ELECTRICAL  
 LIGHTING  
 CABLES  
 BRAKES  
 OIL FILTERS  
 SUSPENSION  
 BODY  
 WHEELS  
 TIRES / TIRE ACC.  
 BIKE ACC.  
 VICTORY / INDIAN  
 COVERS / LOCKS / TIEDOWNS  
 CHEMICALS  
**TOOLS**  
 HELMETS  
 HELMET ACC.  
 EYEWEAR  
 APPAREL / RIDER ACC.  
 PROMOTIONAL  
 REFERENCE  
 INDEX

WINDSHIELDS / FAIRINGS  
 AUDIO / COMMUNICATION  
 SEATS / LUGGAGE  
 BARS / MIRRORS / CONTROLS  
 EXHAUST  
 AIR / FUEL SYSTEMS  
 ENGINE  
 TRANSMISSION / DRIVELINE  
 GASKETS / SEALS  
 ELECTRICAL  
 LIGHTING  
 CABLES  
 BRAKES  
 OIL FILTERS  
 SUSPENSION  
 BODY  
 WHEELS  
 TIRES / TIRE ACC.  
 BIKE ACC.  
 VICTORY / INDIAN  
 COVERS / LOCKS / TIEDOWNS  
 CHEMICALS  
**TOOLS**  
 HELMETS  
 HELMET ACC.  
 EYEWEAR  
 APPAREL / RIDER ACC.  
 PROMOTIONAL  
 REFERENCE  
 INDEX



## IMPACT EXTENSIONS AND U-JOINTS

- Drop forged chrome vanadium steel for strength and durability
- Lifetime warranty

Description	WPS#
<b>3/8" DRIVE</b>	
3" Extension	117-1021
6" Extension	117-1022
U-Joint	117-1016
<b>1/2" DRIVE</b>	
3" Extension	117-1018
5" Extension	117-1019
10" Extension	117-1020
U-Joint	117-1017



## COMBINATION WRENCH SETS

- Chrome vanadium steel construction
- Polished chrome plated finish
- Includes storage rack
- Lifetime warranty
- SAE set includes: 1/4", 5/16", 3/8", 7/16", 1/2", 9/16", 5/8", 11/16", 3/4", 13/16" and 7/8" wrenches
- Metric set includes: 9 mm, 10 mm, 11 mm, 12 mm, 13 mm, 14 mm, 15 mm, 16 mm, 17 mm, 18 mm and 19 mm wrenches

Description	WPS#
SAE wrench set	117-1025
Metric wrench set	117-1026



## RATCHETING WRENCH SETS

- Drop forge chrome vanadium steel
- 72 Gear teeth for a precise 5° sweep
- Low profile head for access in tight spaces
- Triple chrome plated, fully polished
- Lifetime warranty
- SAE set includes: 1/4", 5/16", 3/8", 7/16", 1/2", 9/16", 5/8", 11/16", 3/4", 13/16", 7/8" and 1" wrenches
- Metric set includes: 8 mm, 9 mm, 10 mm, 11 mm, 12 mm, 13 mm, 14 mm, 15 mm, 16 mm, 17 mm, 18 mm and 19 mm wrenches

Description	WPS#
SAE ratchet wrench set	117-1047
Metric ratchet wrench set	117-1048





### FLARE NUT WRENCH SETS

- Drop forged and hardened chrome alloy steel
- Nickel chrome plated, fully polished
- 15° offset head
- Lifetime warranty
- SAE set includes: 1/4" x 5/16", 3/8" x 7/16", 1/2" x 9/16" and 5/8" x 11/16" wrenches
- Metric set includes: 9 mm x 11 mm, 10 mm x 12 mm, 13 mm x 14 mm and 16 mm, x 18 mm wrenches

Description	WPS#
SAE flare nut wrench set	117-1045
Metric flare nut wrench set	117-1046

### 3/8" DRIVE CROW FOOT WRENCH SETS



Description	WPS#
Crow foot SAE wrench set	117-1062
Crow foot metric wrench set	117-1063

- Drop forged, heat treated alloy steel
- Great for hard to reach fasteners
- Polished chrome plated finish
- Includes storage rail
- Lifetime warranty
- SAE set includes: 3/8", 7/16, 1/2", 9/16", 5/8", 11/16", 3/4" and 7/8" wrenches
- Metric set includes: 10 mm, 11 mm, 13 mm, 14 mm, 15 mm, 17 mm, 18 mm and 22 mm wrenches



### ADJUSTABLE WRENCH SET

- Heat treated alloy steel with polished heads
- Machine knurled thumb adjuster for precision jaw positioning
- Lifetime warranty
- Includes: 6" and 8" adjustable wrenches

Description	WPS#
2 pc adjustable wrench set	117-1039

- WINDSHIELDS / FAIRINGS
- AUDIO / COMMUNICATION
- SEATS / LUGGAGE
- BAR / MIRRORS / CONTROLS
- EXHAUST
- AIR / FUEL SYSTEMS
- ENGINE
- TRANSMISSION / DRIVELINE
- GASKETS / SEALS
- ELECTRICAL
- LIGHTING
- CABLES
- BRAKES
- OIL FILTERS
- SUSPENSION
- BODY
- WHEELS
- TIRES / TIRE ACC.
- BIKE ACC.
- VICTORY / INDIAN
- COVERS / LOCKS / TIEDOWNS
- CHEMICALS
- TOOLS**
- HELMETS
- HELMET ACC.
- EYEWEAR
- APPAREL / RIDER ACC.
- PROMOTIONAL
- REFERENCE
- INDEX



## HEX AND STAR T-HANDLE SETS

- Single piece construction runs thru the handle for greater strength
- Color coded handles for easy identification
- Two drive ends: long end for hard to reach areas, short end for extra torque
- Non-slip molded grips and chrome plated shafts
- Lifetime warranty
- SAE T-handle sets include: 3/32", 1/8", 5/32", 3/16", 1/4", 5/16" and 3/8" keys
- Metric T-handle sets include: 2.5 mm, 3 mm, 4 mm, 5 mm, 6 mm, 8 mm and 10 mm keys
- Star socket sets include: T10, T15, T20, T25, T27, T30 and T40 keys

Description	WPS#
SAE T-handle set	117-1036
Metric T-handle set	117-1037
Star T-handle set	117-1038



SAE Set



Star Set

## HEX KEY SET

- Alloy steel construction
- Ball end hex keys work at angles up to 25°
- Includes plastic holder for easy storage
- Lifetime warranty
- SAE hex keys included: .05", 1/16", 5/64", 3/32", 7/64", 1/8", 9/64", 5/32", 3/16", 7/32", 1/4", 5/16" and 3/8"
- Metric hex keys included: 1.5 mm, 2 mm, 2.5 mm, 3 mm, 4 mm, 5 mm, 6 mm, 8 mm and 10 mm

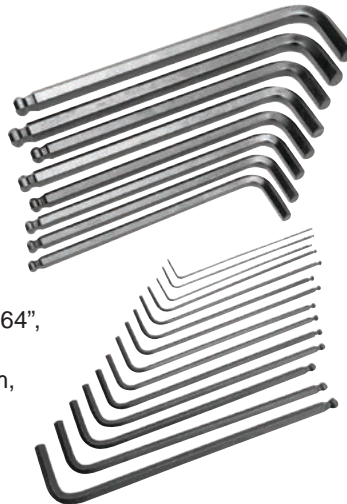

Description	WPS#
SAE/metric ball end hex key set	117-1033

## 4 PC PLIERS SET

- Drop forged chrome vanadium steel
- Induction hardened cutting edges, precision machined jaws
- Non-slip molded grips
- Lifetime warranty
- Includes 1 piece each: 6" slip joint pliers, 6" diagonal cutter pliers, 6" needle nose pliers, 7" linesman pliers



Description	WPS#
4 pc pliers set	117-1065

- WINDSHIELDS / FAIRINGS
- AUDIO / COMMUNICATION
- SEATS / LUGGAGE
- BAR / MIRRORS / CONTROLS
- EXHAUST
- AIR / FUEL SYSTEMS
- ENGINE
- TRANSMISSION / DRIVELINE
- GASKETS / SEALS
- ELECTRICAL
- LIGHTING
- CABLES
- BRAKES
- OIL FILTERS
- SUSPENSION
- BODY
- WHEELS
- TIRES / TIRE ACC.
- BIKE ACC.
- VICTORY / INDIAN
- COVERS / LOCKS / TIEDOWNS
- CHEMICALS
- TOOLS**
- HELMETS
- HELMET ACC.
- EYEWEAR
- APPAREL / RIDER ACC.
- PROMOTIONAL
- REFERENCE
- INDEX





### LOCKING PLIERS SET

- Drop forged steel construction
- Hardened and tempered milled teeth
- Wire cutters and quick release levers
- Lifetime warranty
- Includes: 5", 7" and 10" locking pliers

Description	WPS#
3 pc locking pliers set	117-1027



### 6 PC SCREWDRIVER SET

- Chrome vanadium steel with magnetic tips
- Non-slip molded grips
- Lifetime warranty
- Slotted screwdrivers included: 1/8" x 3", 3/16" x 3" and 1/4" x 4"
- Phillips screwdrivers included: #0 x 2 1/2", #1 x 3", #2 x 4"

Description	WPS#
6 pc screwdriver set	117-1049

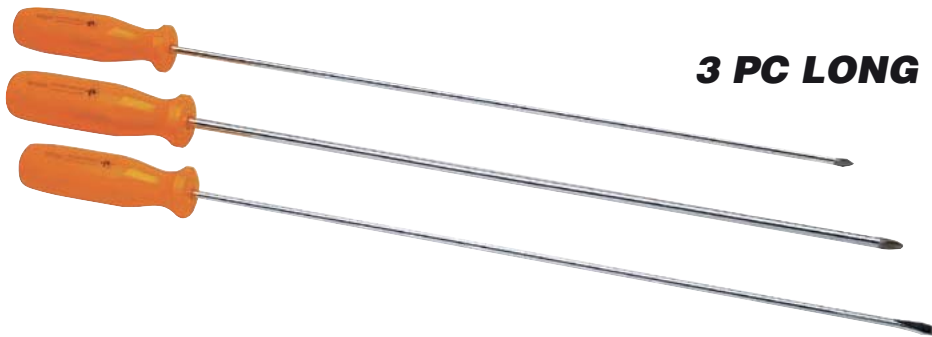

### 3 PC LONG SCREWDRIVER SET

- Chrome vanadium steel shafts with magnetic tips
- High visibility pro style handles, 22 1/2" overall length
- Lifetime warranty

Description	WPS#
3 pc long screwdriver set	117-1097



### 6 IN 1 SCREWDRIVER



- Includes handle, reversible shank and 2 double sided bits
- Chrome vanadium steel bits
- Shank openings serve as 1/4" or 6 mm and 5/16" or 8 mm nut driver
- Bit sizes: Slotted - 3/16" and 1/4", phillips - #1 and #2
- Handle and shank feature ball spring retention for a positive fit
- Lifetime warranty

Description	WPS#
6 in 1 screwdriver	117-1108

- WINDSHIELDS / FAIRINGS
- AUDIO / COMMUNICATION
- SEATS / LUGGAGE
- BAR / MIRRORS / CONTROLS
- EXHAUST
- AIR / FUEL SYSTEMS
- ENGINE
- TRANSMISSION / DRIVELINE
- GASKETS / SEALS
- ELECTRICAL
- LIGHTING
- CABLES
- BRAKES
- OIL FILTERS
- SUSPENSION
- BODY
- WHEELS
- TIRES / TIRE ACC.
- BIKE ACC.
- VICTORY / INDIAN
- COVERS / LOCKS / TIEDOWNS
- CHEMICALS
- TOOLS**
- HELMETS
- HELMET ACC.
- EYEWEAR
- APPAREL / RIDER ACC.
- PROMOTIONAL
- REFERENCE
- INDEX



### 4 PC PRY BAR SET

- Drop forged steel construction
- High visibility molded handles
- Lifetime warranty
- Includes: 8", 12", 18" and 24" pry bars



Description	WPS#
4 pc pry bar set	117-1041

### 5 PC SCRAPER AND HOOK SET

- Durable alloy steel shafts
- Tough plastic handles
- Lifetime warranty
- Includes: 8" and 11" multi-purpose scrapers, 7" hose remover, 9" scratch awl and cotter pin puller



Description	WPS#
5 pc scraper/hook set	117-1042

### 6 PC HOOK AND PICK SET

- Durable alloy steel shafts
- Double injection molded handles
- Includes storage tray
- Lifetime warranty
- Includes: Straight pick, 90° pick, double angle pick, complex pick, combination pick and hook pick



Description	WPS#
6 pc hook and pick set	117-1098

- WINDSHIELDS / FAIRINGS
- AUDIO / COMMUNICATION
- SEATS / LUGGAGE
- BARS / MIRRORS / CONTROLS
- EXHAUST
- AIR / FUEL SYSTEMS
- ENGINE
- TRANSMISSION / DRIVELINE
- GASKETS / SEALS
- ELECTRICAL
- LIGHTING
- CABLES
- BRAKES
- OIL FILTERS
- SUSPENSION
- BODY
- WHEELS
- TIRES / TIRE ACC.
- BIKE ACC.
- VICTORY / INDIAN
- COVERS / LOCKS / TIEDOWNS
- CHEMICALS
- TOOLS**
- HELMETS
- HELMET ACC.
- EYEWEAR
- APPAREL / RIDER ACC.
- PROMOTIONAL
- REFERENCE
- INDEX



### BALL PEIN HAMMERS

- Drop forged high carbon steel head
- Heavy duty fiberglass handle
- Rubber cushion grip
- Lifetime warranty

Description	WPS#
12 oz	117-1008
16 oz	117-1009
24 oz	117-1010
32 oz	117-1011



### DEAD BLOW HAMMERS

- Non-marring soft face
- Lifetime warranty

Description	WPS#
16 oz	117-1013
32 oz	117-1014
48 oz	117-1015



### 4 PC 3 JAW GEAR PULLER SET

- Drop forged heat treated alloy steel
- Chrome plated finish
- Great for removing gears and bearings
- Lifetime warranty
- Includes: 3", 4", 5" and 6" gear pullers

Description	WPS#
4 pc gear puller set	117-1032

- WINDSHIELDS / FAIRINGS
- AUDIO / COMMUNICATION
- SEATS / LUGGAGE
- BAR / MIRRORS / CONTROLS
- EXHAUST
- AIR / FUEL SYSTEMS
- ENGINE
- TRANSMISSION / DRIVELINE
- GASKETS / SEALS
- ELECTRICAL
- LIGHTING
- CABLES
- BRAKES
- OIL FILTERS
- SUSPENSION
- BODY
- WHEELS
- TIRES / TIRE ACC.
- BIKE ACC.
- VICTORY / INDIAN
- COVERS / LOCKS / TIEDOWNS
- CHEMICALS
- TOOLS**
- HELMETS
- HELMET ACC.
- EYEWEAR
- APPAREL / RIDER ACC.
- PROMOTIONAL
- REFERENCE
- INDEX

- WINDSHIELDS / FAIRINGS
- AUDIO / COMMUNICATION
- SEATS / LUGGAGE
- BARS / MIRRORS / CONTROLS
- EXHAUST
- AIR / FUEL SYSTEMS
- ENGINE
- TRANSMISSION / DRIVELINE
- GASKETS / SEALS
- ELECTRICAL
- LIGHTING
- CABLES
- BRAKES
- OIL FILTERS
- SUSPENSION
- BODY
- WHEELS
- TIRES / TIRE ACC.
- BIKE ACC.
- VICTORY / INDIAN
- COVERS / LOCKS / TIEDOWNS
- CHEMICALS
- TOOLS**
- HELMETS
- HELMET ACC.
- EYEWEAR
- APPAREL / RIDER ACC.
- PROMOTIONAL
- REFERENCE
- INDEX



## RIVET GUN

- Precision die cast aluminum body, drop forged steel upper handle
- Ergonomically friendly handle
- For use with 1/8", 3/32", 5/32" and 3/16" steel and aluminum rivets
- Thick cushion-molded vinyl grips
- Lifetime warranty

Description	WPS#
Rivet gun	117-1040



## HEAVY DUTY AIR RIVET GUN

- Works with 3/32", 1/8", 5/32" and 3/16" steel and aluminum rivets
- Capable of over 1500 lbs of pull @ 4 cfm
- Air relief valve prevents overloading

Description	WPS#
Air rivet gun	117-1099



## STUD REMOVER/INSTALLER

- Removes studs from 1/4" to 3/4" in diameter
- Knurled roller uses cam action to grasp stud firmly while minimizing damage
- 1/2" drive ratchet required for use (not included)
- Lifetime warranty

Description	WPS#
Stud remover	117-1094



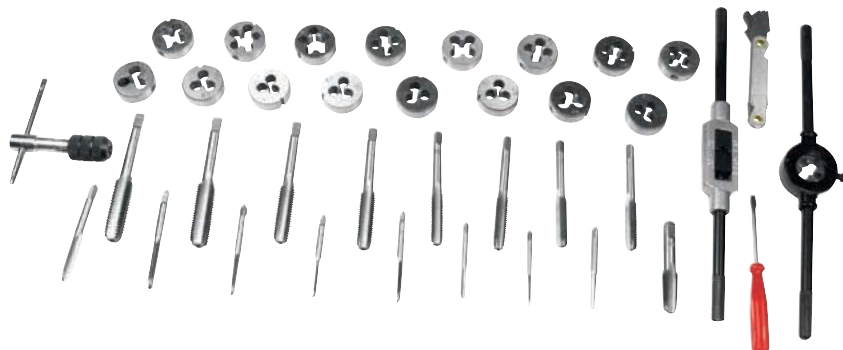

### 40 PC TAP AND DIE SETS

Includes: 17 taps and 17 dies (course/fine thread and NPT), T-handle tap wrench, tap/die holders, screw driver, pitch gauge and storage case.

Description	WPS#
SAE tap and die set	117-1083
Metric tap and die set	117-1084



### 5 PC SCREW EXTRACTOR SET

- Removes damaged screws, broken studs, set screws and pipe fittings
- For screws/bolts/fittings 5/32" thru 3/4"
- Chrome Moly steel construction
- Includes storage case
- Lifetime warranty

Description	WPS#
5 pc screw extractor set	117-1043



### FEELER GAUGE SET

- 26 straight blades
- SAE and metric markings
- Check for clearance on valves, ignition points etc.
- Lifetime warranty
- Includes 26 blades varying in thickness from .0015"/.038 mm to .025"/.635 mm

Description	WPS#
26 Blade feeler gauge set	117-1034

- WINDSHIELDS / FAIRINGS
- AUDIO / COMMUNICATION
- SEATS / LUGGAGE
- BARS / MIRRORS / CONTROLS
- EXHAUST
- AIR / FUEL SYSTEMS
- ENGINE
- TRANSMISSION / DRIVELINE
- GASKETS / SEALS
- ELECTRICAL
- LIGHTING
- CABLES
- BRAKES
- OIL FILTERS
- SUSPENSION
- BODY
- WHEELS
- TIRES / TIRE ACC.
- BIKE ACC.
- VICTORY / INDIAN
- COVERS / LOCKS / TIEDOWNS
- CHEMICALS
- TOOLS**
- HELMETS
- HELMET ACC.
- EYEWEAR
- APPAREL / RIDER ACC.
- PROMOTIONAL
- REFERENCE
- INDEX



- WINDSHIELDS / FAIRINGS
- AUDIO / COMMUNICATION
- SEATS / LUGGAGE
- BARS / MIRRORS / CONTROLS
- EXHAUST
- AIR / FUEL SYSTEMS
- ENGINE
- TRANSMISSION / DRIVELINE
- GASKETS / SEALS
- ELECTRICAL
- LIGHTING
- CABLES
- BRAKES
- OIL FILTERS
- SUSPENSION
- BODY
- WHEELS
- TIRES / TIRE ACC.
- BIKE ACC.
- VICTORY / INDIAN
- COVERS / LOCKS / TIEDOWNS
- CHEMICALS
- TOOLS**
- HELMETS
- HELMET ACC.
- EYEWEAR
- APPAREL / RIDER ACC.
- PROMOTIONAL
- REFERENCE
- INDEX

## SPARK PLUG GAUGE SET

- Round wire gauge blades
- SAE and metric sizes
- Includes electrode adjuster
- Lifetime warranty
- Includes gauge blades to measure from .015"/.40 mm to .040"/1.00 mm



Description	WPS#
Spark plug gauge set	117-1031

## 7 PC CHISEL AND PUNCH SET

- Hardened and tempered high carbon steel construction
- Vinyl covered shank absorbs shock and reduces vibration
- Includes storage pouch
- Lifetime warranty
- Includes: 3/16" x 6" pin punch, 1/8" x 6" and 3/16" x 6" taper punches, 3/8" center punch, 3/8", 1/2" and 5/8" cold chisels



Description	WPS#
Chisel and punch set	117-1091

## 6 PC FILE SET

- Heat treated carbon steel files
- Durable black rubber handles with plastic inserts
- Lifetime warranty
- Includes: 6" mill file, 8" mill file, 6" taper file, 8" half round file and 2 handles



Description	WPS#
File set	117-1087



### DIGITAL MULTI-METER

- AC and DC voltage, current, and resistance measurements, diode and ohms test
- LCD screen, on/off switch and two 32" test leads
- Low battery and over range indicators
- 9 volt battery included

Description	WPS#
Digital multi-meter	117-1080



### DIGITAL CALIPER

- Stainless steel construction
- Measures inside, outside, step and depth
- 0" to 6" range, SAE to metric conversion
- Large easy to read LCD display, zero setting at any position
- Thumb wheel with lock
- Battery included

Description	WPS#
Digital caliper	117-1092



### SELF POWERED TIMING LIGHT

- Designed for use with all gasoline powered engines
- Detachable inductive pickup
- Powered by 2 D cell batteries (not included)

Description	WPS#
Timing light	117-1093

- WINDSHIELDS / FAIRINGS
- AUDIO / COMMUNICATION
- SEATS / LUGGAGE
- BAR / MIRRORS / CONTROLS
- EXHAUST
- AIR / FUEL SYSTEMS
- ENGINE
- TRANSMISSION / DRIVELINE
- GASKETS / SEALS
- ELECTRICAL
- LIGHTING
- CABLES
- BRAKES
- OIL FILTERS
- SUSPENSION
- BODY
- WHEELS
- TIRES / TIRE ACC.
- BIKE ACC.
- VICTORY / INDIAN
- COVERS / LOCKS / TIEDOWNS
- CHEMICALS
- TOOLS**
- HELMETS
- HELMET ACC.
- EYEWEAR
- APPAREL / RIDER ACC.
- PROMOTIONAL
- REFERENCE
- INDEX

- WINDSHIELDS / FAIRINGS
- AUDIO / COMMUNICATION
- SEATS / LUGGAGE
- BARS / MIRRORS / CONTROLS
- EXHAUST
- AIR / FUEL SYSTEMS
- ENGINE
- TRANSMISSION / DRIVELINE
- GASKETS / SEALS
- ELECTRICAL
- LIGHTING
- CABLES
- BRAKES
- OIL FILTERS
- SUSPENSION
- BODY
- WHEELS
- TIRES / TIRE ACC.
- BIKE ACC.
- VICTORY / INDIAN
- COVERS / LOCKS / TIEDOWNS
- CHEMICALS
- TOOLS**
- HELMETS
- HELMET ACC.
- EYEWEAR
- APPAREL / RIDER ACC.
- PROMOTIONAL
- REFERENCE
- INDEX



## IMPACT WRENCHES



- All impacts have strong, durable and lightweight cast aluminum housings
- 3/8" Butterfly impact features a 360° air inlet swivel, and a built in air regulator
- Standard impact wrenches features include push button direction change and a built in air regulator
- Max torque: 3/8" Butterfly - 75 ft/lbs, 3/8" Standard - 120 ft/lbs, 1/2" Standard - 230 ft/lbs
- 1 Year limited warranty

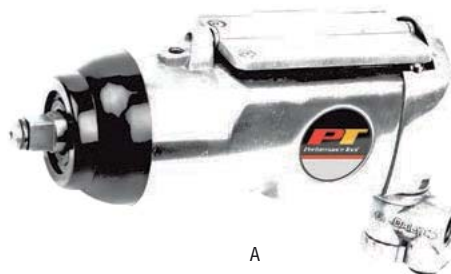

A

Description	WPS#
A 3/8" Butterfly impact	117-1109
B 3/8" Standard impact	117-1110
C 1/2" Standard impact	117-1111



B



C

## ANTI-FATIGUE FLOOR MATS



- Pack includes 12 interlocking 12" x 12" mats with borders, covers 12 square feet
- Durable, lightweight and water resistant 12mm thick EVA foam
- Connect multiple packs for extended floor coverage

Description	WPS#
Floor mats 12/pk	117-1112

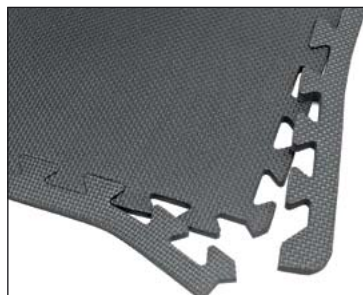



- WINDSHIELDS / FAIRINGS
- AUDIO / COMMUNICATION
- SEATS / LUGGAGE
- BAR / MIRRORS / CONTROLS
- EXHAUST
- AIR / FUEL SYSTEMS
- ENGINE
- TRANSMISSION / DRIVELINE
- GASKETS / SEALS
- ELECTRICAL
- LIGHTING
- CABLES
- BRAKES
- OIL FILTERS
- SUSPENSION
- BODY
- WHEELS
- TIRES / TIRE ACC.
- BIKE ACC.
- VICTORY / INDIAN
- COVERS / LOCKS / TIEDOWNS
- CHEMICALS
- TOOLS**
- HELMETS
- HELMET ACC.
- EYEWEAR
- APPAREL / RIDER ACC.
- PROMOTIONAL
- REFERENCE
- INDEX



### 5 GALLON PORTABLE AIR TANK

- Lightweight and portable
- Handle for easy transport
- On/off outlet valve
- 125 max. psi

Description	WPS#
5 Gallon air tank	117-1023



### 5 GALLON TIRE BEAD SEATING TANK

- Designed to seat tires on the bead of a wheel safe and fast
- Perfect for car, truck, ATV and motorcycle tires
- Heavy duty ball valves on the air inlet and exhaust port
- 5 gallon capacity

Description	WPS#
Tire bead seating tank	117-1024



### NON-AEROSOL LIQUID SPRAY TANK

- Heavy duty steel construction
- Reusable and refillable, 32 oz capacity
- Pressurize with your air compressor
- Not for use with flammable materials or paint

Description	WPS#
32 oz spray tank	117-1012



### 4" ANGLED BLOW GUN

- 4" Long barrel angled at 15°
- Insulated fiberglass reinforced handle
- Brass air flow valve



Description	WPS#
4" Blow gun	117-1079

### MAGNETIC RETRIEVER

- Extends up to 25"
- Heavy duty magnet retrieves objects up to 3 1/2 lbs
- Handy pocket clip
- Lifetime warranty



Description	WPS#
Magnet retriever	117-1029

### TELESCOPING INSPECTION MIRROR

- 2" round mirror with multi-directional swivel
- Chrome plated shaft extends from 11 1/2" to 18"
- Vinyl grip
- Lifetime warranty



Description	WPS#
Inspection mirror	117-1030

### 2 PC RAZOR SCRAPER SET AND RAZOR BLADES

- Ergonomic grips for greater comfort and control
- Mini razor scraper features durable composite construction
- Extended reach scraper gives you increased reach and leverage
- Lifetime warranty on scrapers
- Single edge razor blades fit most all standard razor scrapers
- Razor scraper set includes: Extended reach and mini razor scrapers and 10 razor blades



Description	WPS#
Razor scraper	117-1114
Razor blades, 100/box	117-1090

- WINDSHIELDS / FAIRINGS
- AUDIO / COMMUNICATION
- SEATS / LUGGAGE
- BARS / MIRRORS / CONTROLS
- EXHAUST
- AIR / FUEL SYSTEMS
- ENGINE
- TRANSMISSION / DRIVELINE
- GASKETS / SEALS
- ELECTRICAL
- LIGHTING
- CABLES
- BRAKES
- OIL FILTERS
- SUSPENSION
- BODY
- WHEELS
- TIRES / TIRE ACC.
- BIKE ACC.
- VICTORY / INDIAN
- COVERS / LOCKS / TIEDOWNS
- CHEMICALS
- TOOLS
- HELMETS
- HELMET ACC.
- EYEWEAR
- APPAREL / RIDER ACC.
- PROMOTIONAL
- REFERENCE
- INDEX



### TAPE MEASURES

- Locking blade
- Durable casing stands up to rough treatment
- Lifetime warranty

Description	WPS#
12' tape measure	117-1085
25' Tape measure	117-1086



### SHOP TOWELS

- Soft all cotton weave
- Absorbent, machine washable
- 13 3/4" x 13"
- Sold 25/pack

Description	WPS#
25 pk shop towels	117-1035



### 2 PC VALVE LAPPER SET

- Heavy duty rubber suction cups
- Hardwood handles
- Lifetime warranty
- Lapping compound not included

Description	WPS#
2 pc valve lapper set	117-1095



### PISTON RING COMPRESSOR SET

- Includes 6 sizes of bands for multiple applications
- Fits pistons 2 7/8" (73 mm) thru 4 3/8" (110 mm) in diameter
- Lifetime warranty

Description	WPS#
Piston ring compressor set	117-1096

- WINDSHIELDS / FAIRINGS
- AUDIO / COMMUNICATION
- SEATS / LUGGAGE
- BAR / MIRRORS / CONTROLS
- EXHAUST
- AIR / FUEL SYSTEMS
- ENGINE
- TRANSMISSION / DRIVELINE
- GASKETS / SEALS
- ELECTRICAL
- LIGHTING
- CABLES
- BRAKES
- OIL FILTERS
- SUSPENSION
- BODY
- WHEELS
- TIRES / TIRE ACC.
- BIKE ACC.
- VICTORY / INDIAN
- COVERS / LOCKS / TIEDOWNS
- CHEMICALS
- TOOLS**
- HELMETS
- HELMET ACC.
- EYEWEAR
- APPAREL / RIDER ACC.
- PROMOTIONAL
- REFERENCE
- INDEX

- WINDSHIELDS / FAIRINGS
- AUDIO / COMMUNICATION
- SEATS / LUGGAGE
- BARS / MIRRORS / CONTROLS
- EXHAUST
- AIR / FUEL SYSTEMS
- ENGINE
- TRANSMISSION / DRIVELINE
- GASKETS / SEALS
- ELECTRICAL
- LIGHTING
- CABLES
- BRAKES
- OIL FILTERS
- SUSPENSION
- BODY
- WHEELS
- TIRES / TIRE ACC.
- BIKE ACC.
- VICTORY / INDIAN
- COVERS / LOCKS / TIEDOWNS
- CHEMICALS
- TOOLS**
- HELMETS
- HELMET ACC.
- EYEWEAR
- APPAREL / RIDER ACC.
- PROMOTIONAL
- REFERENCE
- INDEX



## COOLING SYSTEM PRESSURE TEST KIT



- Detects internal engine cooling system leaks
- Quickly reveals external cooling system leaks
- Kit includes hand pump with pressure gauge, 12 adapters to fit most powersport/automotive applications and storage case



Description	WPS#
Pressure test kit	117-1056

## 5 QT FLEX SPOUT DISPENSER

- 5 Quart capacity, 14" flexible metal spout
- Designed for one handed operation
- Thumb operated control valve
- Rolled edge top helps prevent oil spillage
- Lifetime warranty



Description	WPS#
5 qt flex spout dispenser	117-1088

## 120 VOLT LED WORK LIGHT

- 30 Bright white LED's
- Impact, moisture and chemical resistant
- Magnet and dual hooks for hands-free lighting
- Heavy duty switch, 6 ft/18 gauge cord
- UL listed

Description	WPS#
LED work light	117-1077



**ECONOKITS**



**H1**

- Five combination wrenches cover most fasteners, and an eight-inch adjustable wrench handles the rest, including most axle nuts
- Locking pliers, tire gauge, hex and star keys, and much more
- The double-panel 600-denier polyester pouch is designed to last

**WPS#**

**57-00210**



**H2**

- Five combination wrenches, plus a stout 6-in-1 screwdriver, tire gauge, hex and star keys, 2-in-1 spark plug socket, and more
- The rugged pouch, with self-healing zippers, won't let you down

**WPS#**

**57-00211**



**ROADTECH H3**

- We've combined the road-proven EconoKIT H1 with the best of our MiniSet™ for this super charged roadside solution
- Includes our top-grade combination wrenches, adjustable wrench, locking pliers, tire gauge, hex and star keys, screwdriver and more
- But you'll also love the mini ratchet and socket set, making this the last tool kit you'll ever need to buy

**WPS#**

**57-00221**

WINDSHIELDS / FAIRINGS
AUDIO / COMMUNICATION
SEATS / LUGGAGE
BARS / MIRRORS / CONTROLS
EXHAUST
AIR / FUEL SYSTEMS
ENGINE
TRANSMISSION / DRIVELINE
GASKETS / SEALS
ELECTRICAL
LIGHTING
CABLES
BRAKES
OIL FILTERS
SUSPENSION
BODY
WHEELS
TIRES / TIRE ACC.
BIKE ACC.
VICTORY / INDIAN
COVERS / LOCKS / TIEDOWNS
CHEMICALS
<b>TOOLS</b>
HELMETS
HELMET ACC.
EYEWEAR
APPAREL / RIDER ACC.
PROMOTIONAL
REFERENCE
INDEX



### SPEEDKIT FOR HD

- Our new SPEEDKIT tool kit series provides a new standard for capability and compactness
- Developed to cover the most common needs for all Harley-Davidson models except the V-Rod
- With wrenches, nut drivers, star bits, hex keys, screwdriver, pliers, 2-in-1 spark plug socket, and tire pressure gauge
- Everything fits into a rugged pouch that measures only 7" x 2" x 2"



WPS#

57-00229

### ROADTECH TEARDROP

- The RoadTech tool kit series combines road-proven EconoKIT content with a mini ratchet and socket set
- RoadTech Teardrop packs virtually everything from the RoadTech H3 into a compact pouch designed to fit genuine and aftermarket teardrop tool boxes
- While the pouch is designed for teardrop boxes, the tool set is equally applicable to all air-cooled models



WPS#

57-00223

- WINDSHIELDS / FAIRINGS
- AUDIO / COMMUNICATION
- SEATS / LUGGAGE
- BARS / MIRRORS / CONTROLS
- EXHAUST
- AIR / FUEL SYSTEMS
- ENGINE
- TRANSMISSION / DRIVELINE
- GASKETS / SEALS
- ELECTRICAL
- LIGHTING
- CABLES
- BRAKES
- OIL FILTERS
- SUSPENSION
- BODY
- WHEELS
- TIRES / TIRE ACC.
- BIKE ACC.
- VICTORY / INDIAN
- COVERS / LOCKS / TIEDOWNS
- CHEMICALS
- TOOLS**
- HELMETS
- HELMET ACC.
- EYEWEAR
- APPAREL / RIDER ACC.
- PROMOTIONAL
- REFERENCE
- INDEX



### HEX-PRO SAE HEX SET

- 180 degree swivel head with extra long handle for accessing hard to reach places
- Kit includes 3/16, 7/32, 1/4, 5/16, and 3/8 inch wrenches
- Pivot design allows for easy rotation around obstructions
- Pivot design allows you to keep the wrench and fastener engaged when access is limited
- Great time saver
- Heat treated alloy tool steel
- Chrome plated finish
- Includes heavy duty folding canvas storage pouch
- Takes up less storage space than a typical hex key set

Description	WPS#
SAE Hex set	57-8419



### STAR-PRO WRENCH SET

- 180 degree swivel head with extra long handle for accessing hard to reach places
- Kit includes T-25, T-27, T-30, T-40, T-45, and T-50 wrenches
- Pivot design allows for easy rotation around obstructions
- Pivot design allows you to keep the wrench and fastener engaged when access is limited
- Great time saver
- Heat treated alloy tool steel
- Chrome plated finish
- Includes heavy duty folding canvas storage pouch
- Takes up less storage space than a typical hex key set

Description	WPS#
Star-Pro wrench set	57-8421



### 90° 1/4" HEX DRIVER

- Precision made of high grade aluminum and stainless steel
- Designed for hard to reach pilot air screws
- Gear driven 1/4" hex, 17.5" long
- Includes five hex drive bits - straight slot, phillips, D-shaped pilot screw bit, 6mm hex jet bit and 1/4" hex to 1/4" drive bit
- Strongest tool of its type on the market
- Max torque is 50" lbs



Description	WPS#
Hex Driver	57-8229
Repl. D-Shaped Bit	57-8242
Repl. Gear set	57-8246

- WINDSHIELDS / FAIRINGS
- AUDIO / COMMUNICATION
- SEATS / LUGGAGE
- BAR / MIRRORS / CONTROLS
- EXHAUST
- AIR / FUEL SYSTEMS
- ENGINE
- TRANSMISSION / DRIVELINE
- GASKETS / SEALS
- ELECTRICAL
- LIGHTING
- CABLES
- BRAKES
- OIL FILTERS
- SUSPENSION
- BODY
- WHEELS
- TIRES / TIRE ACC.
- BIKE ACC.
- VICTORY / INDIAN
- COVERS / LOCKS / TIEDOWNS
- CHEMICALS
- TOOLS**
- HELMETS
- HELMET ACC.
- EYEWEAR
- APPAREL / RIDER ACC.
- PROMOTIONAL
- REFERENCE
- INDEX



## IMPACT DRIVER

- Heavy duty design for general shop use
- Tightens or loosens screw or bolts on impact
- Complete with four bits and metal storage case
- 3/8" square drive



Description	WPS#
Driver	56-4038
<b>REPLACEMENT BITS</b>	
Set of 4, 5/16" hex shank	56-4252



## SOCKET BIT SETS

Motorcycles, ATVs, snowmobiles, and personal watercraft make widespread use of set and cap screws that require hex ("Allen") and Torx® wrenches. Such fasteners are very vulnerable to damage from tools with loose tolerances and/or inferior materials.

Every rider should have a comprehensive set of socket bits for home, pit, or mobile use. Our three new sets are professional tool quality, yet priced to meet any budget. Socket bodies are polished chrome, and bits made of a heat treated chrome vanadium alloy that exceed ANSI standards. Unlike most socket bit sets found elsewhere, all sockets are 3/8" drive so you only need one ratchet or T-handle for all sizes. A reverse laser imprint provides for easy size identification. To help keep your socket drawer organized, each set ships on a rail with handle. Tools are lifetime guaranteed.

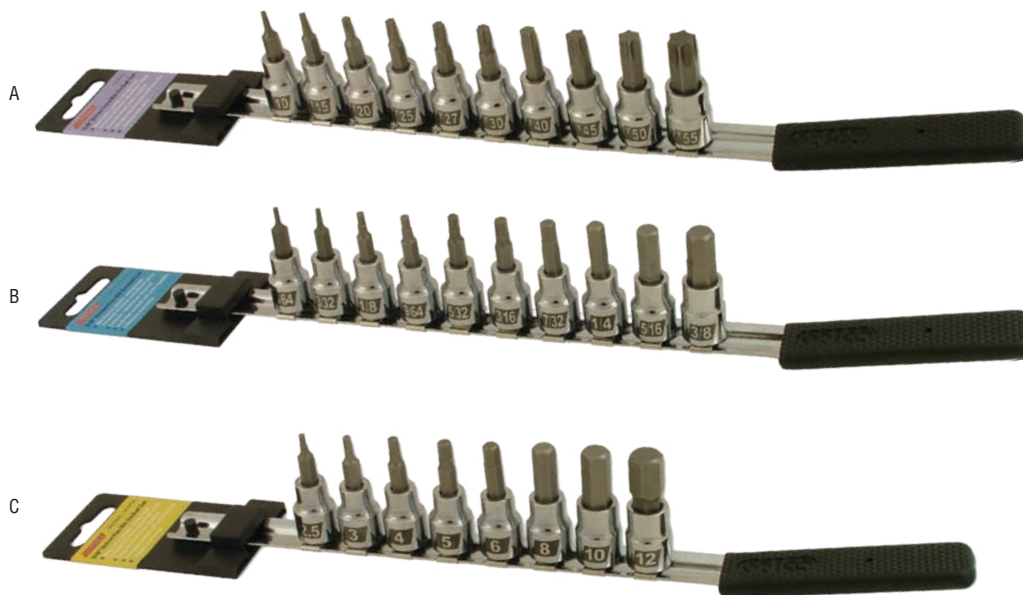

	Description	WPS#
A	10 pc. Torx Bit Set T10,T15,T20,T25,T30,T40,T45,T50,T55	57-0014
B	10 pc. Hex Bit Set-Inch 5/64",3/32",1/8",9/64",5/32",3/16",7/32",1/4",5/16",3/8"	57-0015
C	8pc. Hex Bit Set-Metric 2.5mm,3mm,4mm,5mm,6mm,8mm,10mm,12mm	57-0016

- WINDSHIELDS / FAIRINGS
- AUDIO / COMMUNICATION
- SEATS / LUGGAGE
- BARS / MIRRORS / CONTROLS
- EXHAUST
- AIR / FUEL SYSTEMS
- ENGINE
- TRANSMISSION / DRIVELINE
- GASKETS / SEALS
- ELECTRICAL
- LIGHTING
- CABLES
- BRAKES
- OIL FILTERS
- SUSPENSION
- BODY
- WHEELS
- TIRES / TIRE ACC.
- BIKE ACC.
- VICTORY / INDIAN
- COVERS / LOCKS / TIEDOWNS
- CHEMICALS
- TOOLS**
- HELMETS
- HELMET ACC.
- EYEWEAR
- APPAREL / RIDER ACC.
- PROMOTIONAL
- REFERENCE
- INDEX



## PRO TORQUE WRENCH

CLICK-TYPE MICROMETER TORQUE WRENCH



Description	WPS#
Pro Torque Wrench	57-0634

- Features a quarter-inch reversible ratcheting drive and heat-treated steel construction
- Quickly set torque using a micrometer-style dial and simple locking mechanism
- Adjustable from 6-30Nm



## DEMI TORQUE WRENCH

CLICK-TYPE MICROMETER TORQUE WRENCH

- Features a quarter-inch reversible ratcheting drive and heat-treated steel construction
- Quickly set torque using a micrometer-style dial and simple locking mechanism
- Adjustable from 3-15Nm

Description	WPS#
Demi Torque Wrench	57-0635

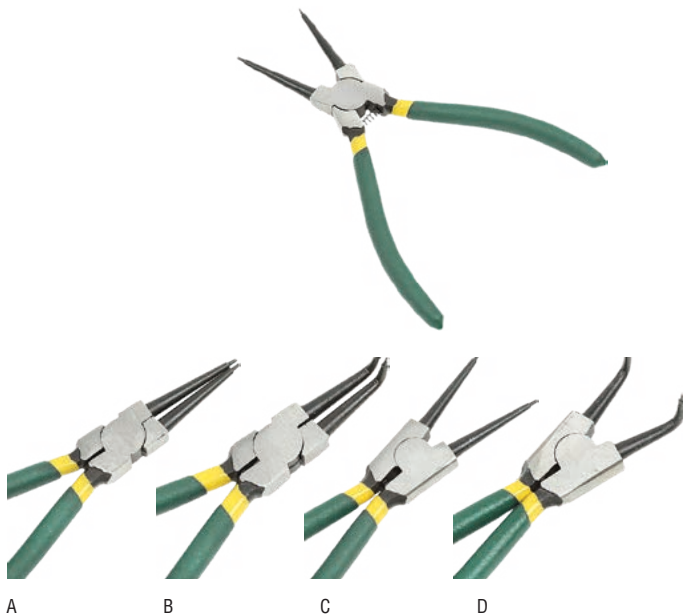
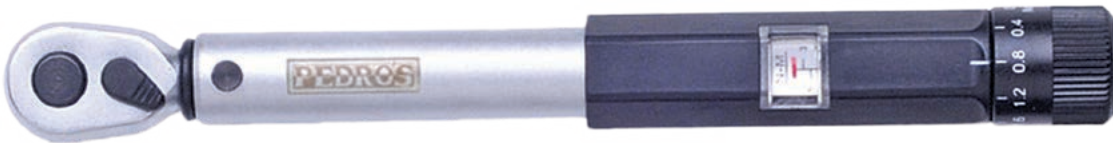

## SNAP RING PLIERS



Pliers for C type snap rings. 4 different pliers available, internal and external, straight and bend head.

Description	WPS#
A Internal straight 185mm length	634-68001
B Internal 90°, 158mm length	634-68002
C External straight, 165mm length	634-68003
D External 90°, 165mm length	634-68004

- WINDSHIELDS / FAIRINGS
- AUDIO / COMMUNICATION
- SEATS / LUGGAGE
- BARS / MIRRORS / CONTROLS
- EXHAUST
- AIR / FUEL SYSTEMS
- ENGINE
- TRANSMISSION / DRIVELINE
- GASKETS / SEALS
- ELECTRICAL
- LIGHTING
- CABLES
- BRAKES
- OIL FILTERS
- SUSPENSION
- BODY
- WHEELS
- TIRES / TIRE ACC.
- BIKE ACC.
- VICTORY / INDIAN
- COVERS / LOCKS / TIEDOWNS
- CHEMICALS
- TOOLS
- HELMETS
- HELMET ACC.
- EYEWEAR
- APPAREL / RIDER ACC.
- PROMOTIONAL
- REFERENCE
- INDEX



## COMBO Y-DRIVE WRENCH

- Innovative dual-use design combines 6 tools into one
- 8 mm, 10 mm and 12 mm hex socket
- 4 mm, 5 mm and 8 mm hex drive
- Padded Y-shape for excellent grip and leverage
- Compact design is ideal for trail tool packs
- Chrome-Vanadium tool steel
- Limited lifetime warranty



Description	WPS#
Y-Drive wrench	57-8547

## DUAL DRIVE L-HANDLES

- Impact resistant ergonomic molded handle reduces hand fatigue
- Use drive side to tighten/loosen fasteners and shaft side for quick installation/removal of fasteners
- Minis are a compact 7 5/8" shaft for tight access & easy transport
- Durable nickel pewter finish
- Lifetime replacement warranty



Description	WPS#
3/8" L-Handle (10" long)	57-8361
1/4" L-Handle (10" long)	57-8363

## 1/4 SPINNER T-HANDLE

- Knurled bearing mounted spinner provides faster and easier removal and installation of nuts and bolts
- Padded grip handle
- Lifetime replacement warranty



Description	WPS#
1/4" spinner T-handle	57-8563
3/8" spinner T-handle	57-8562

- WINDSHIELDS / FAIRINGS
- AUDIO / COMMUNICATION
- SEATS / LUGGAGE
- BARS / MIRRORS / CONTROLS
- EXHAUST
- AIR / FUEL SYSTEMS
- ENGINE
- TRANSMISSION / DRIVELINE
- GASKETS / SEALS
- ELECTRICAL
- LIGHTING
- CABLES
- BRAKES
- OIL FILTERS
- SUSPENSION
- BODY
- WHEELS
- TIRES / TIRE ACC.
- BIKE ACC.
- VICTORY / INDIAN
- COVERS / LOCKS / TIEDOWNS
- CHEMICALS
- TOOLS**
- HELMETS
- HELMET ACC.
- EYEWEAR
- APPAREL / RIDER ACC.
- PROMOTIONAL
- REFERENCE
- INDEX



## TRI-DRIVE MINI T-HANDLES

Use T-handle drive to tighten/loosen fasteners and shaft drive for quick installation/removal of fasteners



- 1/4" drive has a compact 6" drive shaft length
- Compact size for use in tight spaces & easy to carry
- Includes 8mm, 10mm, 12mm and 13mm sockets

- Use with 1/4" drive sockets, hex drives, crow's foot, swivels, etc.
- Chrome-vanadium tool steel shaft and T-Handle
- Durable nickel pewter finish
- Lifetime replacement warranty

Description	WPS#
Mini T-Handle	57-8389

## DUAL DRIVE MINI T-HANDLES



- Use T-Handle drive to tighten/loosen fasteners and shaft drive for quick installation/removal of fasteners
- 1/4" drive has a compact 6 1/2" drive shaft length
- 3/8" drive has a compact 7 3/4" drive shaft length

- For tight access and easy transport
- Use with 1/4" or 3/8" drive sockets, hex drives, swivels, etc.
- Chrome-vanadium tool steel shaft and T-Handle
- Durable nickel pewter finish
- Lifetime replacement warranty

Description	WPS#
1/4" Drive (6 1/2" long)	57-8359
3/8" Drive (7 3/4" long)	57-8360

## 1/4" AND 3/8" DRIVE T-HANDLES



- T-handle socket drivers allow optional ways to use any 1/4" or 3/8" drive attachments such as sockets, hex drives, crow's foot or swivels
- Manufactured from chrome vanadium tool steel with carbon steel T-Handles
- Hard nickel - pewter finish
- Lifetime warranty

Size	WPS#
1/4"	57-8158
3/8"	57-8159
3/8" x 5mm x 6" extension	57-8184

## 1/4" SLIDING "T" DRIVER



- T-handles are extremely useful for all sorts of applications
- At about 7", it can be easily carried on your bike and likely to become a staple in your tool box as well
- Unique sliding "T" feature and a polished chrome finish

Description	WPS#
1/4" sliding T handle	57-00218

- WINDSHIELDS / FAIRINGS
- AUDIO / COMMUNICATION
- SEATS / LUGGAGE
- BAR / MIRRORS / CONTROLS
- EXHAUST
- AIR / FUEL SYSTEMS
- ENGINE
- TRANSMISSION / DRIVELINE
- GASKETS / SEALS
- ELECTRICAL
- LIGHTING
- CABLES
- BRAKES
- OIL FILTERS
- SUSPENSION
- BODY
- WHEELS
- TIRES / TIRE ACC.
- BIKE ACC.
- VICTORY / INDIAN
- COVERS / LOCKS / TIEDOWNS
- CHEMICALS
- TOOLS**
- HELMETS
- HELMET ACC.
- EYEWEAR
- APPAREL / RIDER ACC.
- PROMOTIONAL
- REFERENCE
- INDEX



## DELUXE TOOL POUCH

- Made from heavy duty Cordura™ nylon
- 6 pockets for pliers, screw drivers, etc.
- Zippered compartment for smaller sockets, bolts, spark plugs, etc.
- Velcro® closure keeps pouch rolled up

Color	WPS#
Black	12-1858



Tools not included

## ECONOMY TOOL KIT

- 5" slipjoint pliers
- 3 open end wrenches (8x10mm, 10x12mm, 14x17mm)
- Spark plug wrench (21x24mm)
- Screw driver set (#2 & #3 Phillips, Flat Driver)
- Carrying pouch

Color	WPS#
Black	12-1867



## PRO TORQUE T-HANDLE

- The speed of a 1/4" or 3/8" T-handle driver with the accuracy of a precision torque wrench
- Quickly and accurately torque's those important fasteners
- Constructed of high grade stainless steel and 6061 anodized aluminum
- Choice of measurement range 4 -20 FT\*LBS or 6-27 Newton Meters
- Laser etched markings
- Hardened 3/8 or 1/4 socket end
- No setting of torque, No need for re-calibration
- Calibration certificate specific to each driver insuring exacting accuracy
- As with all torque wrenches, THEY ARE INTENDED FOR TORQUE ONLY they are NOT for loosening
- Includes a padded tool box insert for years of safe storage
- MADE IN THE USA



Description	WPS#
1/4 in Torque T FT* LBS 4lbs to 20lbs	57-0046
1/4 in Torque T N*M 6 to 27 N* M	57-0047
3/8 in Torque T FT* LBS 4lbs to 20lbs	57-0044
3/8 in Torque T N*M 6 to 27 N*M	57-0045

## HAMMER T-HANDLE

- The perfect (go to) T-HANDLE with a huge advantage over any other
- Features include replaceable BRASS and over molded Plastic tips
- Perfect to tap on those expensive parts without damaging them
- Precision machined
- Constructed from High Carbon Steel
- Durable chrome finish
- Replaceable tip kit includes: 1 Brass tip and 1 Plastic tip

Description	WPS#
A Hammer T 1/4 in drive	57-0041
B Hammer T 3/8 in drive	57-0042
C Replaceable Tips 1 brass/ 1 plastic	57-0043





- No Figuring
- No Guessing
- No Mistakes

### PERFECT GAS - OIL MIXTURE

Get a perfect mix every time. Fill your polypropylene Ratio Rite™ to the precalibrated ratio mark and pour into gas. Ratios are from 16:1 to 70:1 for 1, 1½, 2, 2½ gallons. Calibrations also include oz., c.c.'s and pints on the opposite side for transmission oil, fork oil, etc. Total capacity 24 oz.

Description	WPS#
Ratio Rite measuring cup	28-1111
Lid for Ratio Rite cups	28-1115



### DRIP FREE OIL FILTER FUNNEL



- For '85 and up Harley Davidson Evo and Twin Cam models with forward mounted oil filter
- Eliminates the mess of oil filter changes, no more oil all over the front of the engine

WPS #  
57-9996



### FUNNEL PRE-FILTERS



- Water repellant pre-filter prevents moisture from entering fuel tank by catching and holding water
- Also filters out wind-blown sand and dirt as small as .005 in diameter keeping fuel systems clean
- A must when you are at the dunes
- Color red

Size	WPS#
2 quart	28-1019
6 quart	28-1020



### HEAVY DUTY POLYETHYLENE FUNNELS



- Polyethylene plastic remains flexible in all temperatures
- Heavy construction assures a long life
- Funnels incorporate a fine mesh brass screen and a hang tab for easy storage
- Ideal for marine use - It floats!

Size	WPS#
2 quart	28-1009
6 quart	28-1010



### REDLINE FUNNEL



- That funnel that works
- Rotate around to get into those extremely difficult areas
- Works with all fluids

WPS#  
57-6599

- WINDSHIELDS / FAIRINGS
- AUDIO / COMMUNICATION
- SEATS / LUGGAGE
- BAR / MIRRORS / CONTROLS
- EXHAUST
- AIR / FUEL SYSTEMS
- ENGINE
- TRANSMISSION / DRIVELINE
- GASKETS / SEALS
- ELECTRICAL
- LIGHTING
- CABLES
- BRAKES
- OIL FILTERS
- SUSPENSION
- BODY
- WHEELS
- TIRES / TIRE ACC.
- BIKE ACC.
- VICTORY / INDIAN
- COVERS / LOCKS / TIEDOWNS
- CHEMICALS
- TOOLS
- HELMETS
- HELMET ACC.
- EYEWEAR
- APPAREL / RIDER ACC.
- PROMOTIONAL
- REFERENCE
- INDEX

- WINDSHIELDS / FAIRINGS
- AUDIO / COMMUNICATION
- SEATS / LUGGAGE
- BARS / MIRRORS / CONTROLS
- EXHAUST
- AIR / FUEL SYSTEMS
- ENGINE
- TRANSMISSION / DRIVELINE
- GASKETS / SEALS
- ELECTRICAL
- LIGHTING
- CABLES
- BRAKES
- OIL FILTERS
- SUSPENSION
- BODY
- WHEELS
- TIRES / TIRE ACC.
- BIKE ACC.
- VICTORY / INDIAN
- COVERS / LOCKS / TIEDOWNS
- CHEMICALS
- TOOLS**
- HELMETS
- HELMET ACC.
- EYEWEAR
- APPAREL / RIDER ACC.
- PROMOTIONAL
- REFERENCE
- INDEX



## DRAIN PANS AND FUNNELS

- Made from durable, high density polyethylene
- Petroleum resistant
- Easy to use
- Easy to store
- MADE IN AMERICA

Description	WPS#
A 7 1/2 qt triangle drain pan	28-1340
B 9 qt closed top drain pan	28-1341
C 3 pc funnel set	28-1346
D flexible funnel	28-1347



### PRO FUNNEL **NEW**

- Integrated shutoff valve allows precise amount of liquid to be dispensed
- Graduation marks for cubic centimeters, fluid ounces and premix ratio
- One liter capacity
- Easy to understand premix ratio graduations for 32:1, 40:1, 50:1, and 60:1 for 1 to 3 gallons
- Adjustable ball-pivot spout allows easy, spill-free filling
- Top cover keeps dust and dirt out when not in use
- Magnet allows funnel to be stored conveniently on the side of your tool box
- Tip size can be trimmed to fit your application



WPS #  
**57-8560**





- 4.0 peak horsepower (29,000 fpm) motor
- Rugged all steel construction
- 10 foot heavy duty hose
- Heavy duty neoprene blower nozzle
- Proudly made in the USA
- Completely safe for all paint and chrome finishes

## MOTORCYCLE DRYER

The Metro Air Force Blaster motorcycle dryer was specifically designed for cleaning and drying motorcycles with dry, filtered warm air (about 20-25 degrees above ambient temperature). The Metro Air Force Blaster will cut cleaning time by 80%! The Air Force Blaster is the quickest and most efficient method to dry motorcycles thoroughly and eliminate water spots. Five to seven minutes is all it takes to quickly and effectively dry motorcycles.

Description	WPS#
Blaster Dryer	57-8203
<b>ACCESSORIES</b>	
10' extension hose kit with coupler	57-8205
Wall/table mount kit with 10' extension hose	57-8204
Carrying case	57-8206
4 wheel dolly	57-8207



- 8 peak horsepower dryer unit on wheels
- 12 foot cord
- Rugged all steel construction
- Heavy duty neoprene blower nozzle
- 10 foot heavy duty hose
- Air concentrator nozzle
- Air stream tool
- Proudly made in the USA
- The ideal unit for use in motorcycle dealer service departments

## MASTER BLASTER MOTORCYCLE DRYER

The Air Force Master Blaster Motorcycle Dryer features a total of 8 peak horsepower. Two twin fan, 4.0 peak horsepower motors deliver up to 58,500 feet per minute of clean, filtered, warm airflow. Two switches allow users to set the airflow and temperature at 3 different levels. Use either motor (front or rear) independently or both simultaneously for maximum power. Different nozzles enable users to position airflow where desired and eliminate water spots.

Description	WPS#
Master Blaster Dryer	57-8201
<b>ACCESSORIES</b>	
10' extension hose kit	57-8205
30' extension hose kit	57-8209



## SIDEKICK PORTABLE BIKE DRYER

- Powerful 950 watt, 1.3 HP, 120 volt motor
- Weighs just 3 lbs., small enough to fit in most saddlebags
- Includes blower and flare nozzles, 3' 6" stretch hose, shoulder strap and mounting hooks

<b>WPS#</b>
57-8208

- WINDSHIELDS / FAIRINGS
- AUDIO / COMMUNICATION
- SEATS / LUGGAGE
- BAR / MIRRORS / CONTROLS
- EXHAUST
- AIR / FUEL SYSTEMS
- ENGINE
- TRANSMISSION / DRIVELINE
- GASKETS / SEALS
- ELECTRICAL
- LIGHTING
- CABLES
- BRAKES
- OIL FILTERS
- SUSPENSION
- BODY
- WHEELS
- TIRES / TIRE ACC.
- BIKE ACC.
- VICTORY / INDIAN
- COVERS / LOCKS / TIEDOWNS
- CHEMICALS
- TOOLS**
- HELMETS
- HELMET ACC.
- EYEWEAR
- APPAREL / RIDER ACC.
- PROMOTIONAL
- REFERENCE
- INDEX

- WINDSHIELDS / FAIRINGS
- AUDIO / COMMUNICATION
- SEATS / LUGGAGE
- BARS / MIRRORS / CONTROLS
- EXHAUST
- AIR / FUEL SYSTEMS
- ENGINE
- TRANSMISSION / DRIVELINE
- GASKETS / SEALS
- ELECTRICAL
- LIGHTING
- CABLES
- BRAKES
- OIL FILTERS
- SUSPENSION
- BODY
- WHEELS
- TIRES / TIRE ACC.
- BIKE ACC.
- VICTORY / INDIAN
- COVERS / LOCKS / TIEDOWNS
- CHEMICALS
- TOOLS**
- HELMETS
- HELMET ACC.
- EYEWEAR
- APPAREL / RIDER ACC.
- PROMOTIONAL
- REFERENCE
- INDEX



## TIRE STATION

- Combine with your air tank to make the ultimate tire changing station
- Forms a cage around your air tank and protects it from damage
- Works best with 11 gallon air tanks
- Can be used with or without air tank installed
- Durable steel construction
- Long lasting powder coat finish
- The perfect pit accessory



WPS#

57-8477



## ROLLSTAND®

- Allows you to easily clean front and rear tires/rims
- Sealed bearings, powder coated finish
- One person operation, just roll the front or rear tire onto the Rollstand® and place the bike on the sidestand
- Great for tire inspection, chain maintenance and checking air pressure
- Sportbike and Cruiser/Harley Davidson® models available (cruiser works on all motorcycles)



Description

WPS#

Sportbike 25-2020

Cruiser/Harley Davidson® 25-2021

## ARMOR RIM STRIP TAPE

- Ultra tough and durable material protects tubes
- Won't shift or move like rubber rim strips
- Self -adhesive backed for easy no mess installation
- Pre cut hole for valve
- Protects inner tube like no other rim strip

Rim Size

WPS#

18" - 19" 87-10062

21" 87-10061







## MC680 TIRE CHANGER



( MC680 with Strongarm II pictured )

- Specially designed for motorcycle/ATV tire changing
- Affordable solution to shops requiring a powered tire machine
- Available with optional air operated Strongarm II which aids in the mounting and removal of stiff sidewall tires
- One year parts warranty, replacement parts available by special order

Specifications:

Motor: 1.5 H.P.  
 Air Requirements: 115-145 PSI  
 Wheel diameter: 6"-24"  
 Tire width: 2"-10"

Description	WPS #
MC680 Tire Changer	135-9998
MC680 with Strongarm II	137-9997
REPLACEMENT PARTS	
Rim clamp rim protectors/each	135-2781
Bead head protector #1	135-2784
Bead head protector #2	135-2786

FREE FREIGHT IN THE CONTINENTAL U. S. (lift gate fees apply if needed)

Shipped direct from K & L Supply in California



A

## MC205 WHEEL BALANCER

- The K&L MC205 Wheel Balancer incorporates the latest advancements in state of the art motorcycle wheel balancing
- This balancer features a spring loaded "Quick Clamp" wheel-mounting package and offers static (single plane) balancing
- Keypad data entry, in house calibration, and a choice of display modes (gram or ounce) all make this machine technician friendly
- Standard equipment includes: Universal motorcycle clamp, tapered mounting cones, rim width gauge, spanner wrench, and calibration weight
- Accuracy is greatly enhanced with the optional sleeve kit (135-0941)
- BMW/Honda 5-lug wheel adapter available separately (135-6631)

Specifications:

Accuracy: 5g or 0.25oz.  
 Rim Diameter: 10"-24"  
 Power Requirement: 110 Volt 60 Hz 1 Phase  
 Data Entry: Keypad  
 Rim Width: 1.5" - 16"  
 Shipping Weight: 359 lbs  
 Motor: 1/2 H.P.  
 Tire Diameter: Up to 30"



B



C

Description	WPS#
A MC205 Balancer, blue	137-9999
MC205 Balancer, red	137-9990
B Sleeve kit	135-0941
C BMW/Honda wheel adapter	135-6631

FREE FREIGHT IN THE CONTINENTAL U. S. (lift gate fees apply if needed)

Shipped direct from K & L Supply in California

- WINDSHIELDS / FAIRINGS
- AUDIO / COMMUNICATION
- SEATS / LUGGAGE
- BARS / MIRRORS / CONTROLS
- EXHAUST
- AIR / FUEL SYSTEMS
- ENGINE
- TRANSMISSION / DRIVELINE
- GASKETS / SEALS
- ELECTRICAL
- LIGHTING
- CABLES
- BRAKES
- OIL FILTERS
- SUSPENSION
- BODY
- WHEELS
- TIRES / TIRE ACC.
- BIKE ACC.
- VICTORY / INDIAN
- COVERS / LOCKS / TIEDOWNS
- CHEMICALS
- TOOLS**
- HELMETS
- HELMET ACC.
- EYEWEAR
- APPAREL / RIDER ACC.
- PROMOTIONAL
- REFERENCE
- INDEX



## TIRE IRONS

### A. FORGED STEEL

- 8 1/2" long zinc plated tire irons
- One curved end, one straight end
- Reduces marring of alloy rims
- Sold with ten irons on a display card

A



### B. ASSORTED SET

- Skin packed kit includes 8.5", 11" and 16" Motion Pro Tire Irons

B

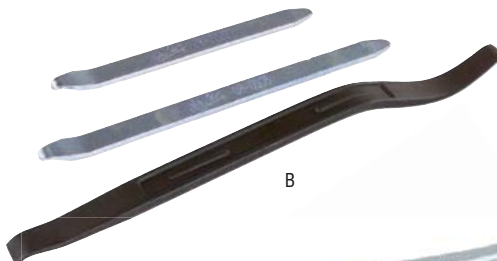

### C/D. SPOON/PAIR

- Unique "spoon" shape on the end of this tire iron makes tire mounting and removal a breeze
- Large curved end fits securely in the hand
- Heavy duty silver zinc plated finish
- Small enough to fit in most fanny packs
- Spoon set includes a handy vinyl carrying pouch

C/D



### E. 8 1/2" FORGED

- Originally designed for professional Six Day Enduro riders
- Hot forged chrome vanadium steel
- 8 1/2" long, lightweight 4 1/2"oz.
- Extremely easy to use

E



### F. 11" PAIR

- Skin packed kit includes 1 pr 11" Tire irons



F

### G. 16" CURVED TIRE IRON/EACH

- Special design for easier tire changing
- Installation end will not abuse tire bead
- Less risk of damaging tube or rim
- Drop forged steel
- Special removal end will force bead down into rim drop center
- An absolute must for manual tire changing
- Measures 16" x 1 x 1 3/4"

G



	Description	Sold	WPS#
A	8 1/2" forged steel	10/cd	57-5503
	8 1/2" forged steel	Each	57-5500
B	Assorted	3/pk	57-8049
C	10" Spoon tire iron	Each	57-8115
D	10" Spoon tire iron	Pair	57-8409
E	8 1/2" Enduro	Pair	57-8051
F	11" tire iron	Pair	57-6210
G	16" forged steel	Each	57-6212

## TIRE IRONS



### A. 8 1/2" STEEL

- Drop forged heat treated steel
- Perfect size for fanny packs



### B. 10" SPOON

- Wide-radiused spoon area to ensure smooth action while preventing accidental tube pinching
- Comfortable rubber-covered handle to prevent slipping



Description	WPS#
A 8 1/2" Steel	57-6225
B 10" Spoon	57-6226

### C. 15" ECONOMY

- Maximum leverage
- 15" long x 1" wide
- Both ends are curved



### D. 16" ECONOMY



Description	WPS#
C 15" Economy	57-6211
D 16" Steel	57-6213



## SAFETY WIRE PLIERS KIT

- 6" wire twisting pliers with return spring mechanism for easy safety wire twisting
- A must have for safety wiring your grips
- Comes with 25' of .032 stainless wire

WPS#
27-0180

## SAFETY WIRE

- T302/304 Stainless steel
- Required by most race organizations
- Great for securing nuts, bolts and grips
- A must have in the shop or tool box
- Made in the U.S.A.



Description	.032"
25' roll	27-0179
1/4 lb spool	27-0176
1 lb can	27-0181



## GRIP CUTTER

- Clean cut every time

WPS#
57-0335

- WINDSHIELDS / FAIRINGS
- AUDIO / COMMUNICATION
- SEATS / LUGGAGE
- BAR / MIRRORS / CONTROLS
- EXHAUST
- AIR / FUEL SYSTEMS
- ENGINE
- TRANSMISSION / DRIVELINE
- GASKETS / SEALS
- ELECTRICAL
- LIGHTING
- CABLES
- BRAKES
- OIL FILTERS
- SUSPENSION
- BODY
- WHEELS
- TIRES / TIRE ACC.
- BIKE ACC.
- VICTORY / INDIAN
- COVERS / LOCKS / TIEDOWNS
- CHEMICALS
- TOOLS**
- HELMETS
- HELMET ACC.
- EYEWEAR
- APPAREL / RIDER ACC.
- PROMOTIONAL
- REFERENCE
- INDEX

- WINDSHIELDS / FAIRINGS
- AUDIO / COMMUNICATION
- SEATS / LUGGAGE
- BARS / MIRRORS / CONTROLS
- EXHAUST
- AIR / FUEL SYSTEMS
- ENGINE
- TRANSMISSION / DRIVELINE
- GASKETS / SEALS
- ELECTRICAL
- LIGHTING
- CABLES
- BRAKES
- OIL FILTERS
- SUSPENSION
- BODY
- WHEELS
- TIRES / TIRE ACC.
- BIKE ACC.
- VICTORY / INDIAN
- COVERS / LOCKS / TIEDOWNS
- CHEMICALS
- TOOLS**
- HELMETS
- HELMET ACC.
- EYEWEAR
- APPAREL / RIDER ACC.
- PROMOTIONAL
- REFERENCE
- INDEX



## TIRE TAMER

- No more skinned knuckles!
- Revolutionary tool holds the bead away from the rim for easy valve stem, rim lock and tube installation



**WPS#**  
**235-9264**



## TIRE VALVE STEM PULLERS

- For removing and installing valve stems on mag wheels, auto and ATV rims
- Available in solid and cable type puller

Model	WPS#
Cable	235-8885
Solid	235-4107



## TIRE BEAD STARTER

- All-in-one safe and effective answer to stubborn to seat street and ATV tires
- Works great on the largest ATV tires and up to 300mm street tires
- The expandable linked straps apply even seating pressure to tire beads without compressed air so it can be used in the shop or "out in the field"

**WPS#**  
**235-9016**





### RIM PROTECTOR

- Protects your wheel from scratches and dings caused by tire changing tools
- Retrieval cords are included for easy use

WPS#

57-0357



### BEAD POPPER

- Designed for breaking the bead on street and off-road motorcycle tires
- Compact and lightweight (only 3.7 oz.) stores easily in your emergency tool pack or tool box
- Can be used with the wheel on or off the motorcycle
- Will not scratch the wheel
- Easier and more convenient than press or lever tools
- Made of a durable high-impact plastic
- Not for use on ATV tires
- Made in the USA

WPS#

57-8439



### WHEEL TRUING STAND

- TS-7M is constructed from heavy gauge steel
- Allows for extremely accurate and reliable wheel truing at an economical price
- For wheels up to 180mm wide and 740mm in diameter
- Uses axle

Description	WPS#
Truing Stand	57-00730
Axle Adaptor	57-00734

- WINDSHIELDS / FAIRINGS
- AUDIO / COMMUNICATION
- SEATS / LUGGAGE
- BARS / MIRRORS / CONTROLS
- EXHAUST
- AIR / FUEL SYSTEMS
- ENGINE
- TRANSMISSION / DRIVELINE
- GASKETS / SEALS
- ELECTRICAL
- LIGHTING
- CABLES
- BRAKES
- OIL FILTERS
- SUSPENSION
- BODY
- WHEELS
- TIRES / TIRE ACC.
- BIKE ACC.
- VICTORY / INDIAN
- COVERS / LOCKS / TIEDOWNS
- CHEMICALS
- TOOLS**
- HELMETS
- HELMET ACC.
- EYEWEAR
- APPAREL / RIDER ACC.
- PROMOTIONAL
- REFERENCE
- INDEX



### MC310 3 IN 1 TRUING STAND

- The three-in-one truing stand from K&L Supply helps you make the most of your workspace. This tool allows you to perform the following:
  - Build and true spoke wheels
  - Check for runout on crankshafts, wheels and fork tubes
  - Balance spoke and mag wheels
- The MC310 features rugged construction throughout with ease of use being given priority.
- Note: Does not include Dial Indicator.

Description	WPS #
MC310 Truing Stand	235-9573
Indicator Arm Assembly	235-9577
Dial indicator w/ Magnet Mount	235-8421



### MC305 WHEEL TRUING & BALANCE STAND

This portable wheel truing stand from K&L Supply works on all motorcycle wheel sizes from 14" to 21" wheels. Wheel can be mounted on adjustable centering cones or ball bearings (using axle) for truing and static balancing of wheels. Frame rails can be adjusted for wide rims/wheels. Lightweight, zinc plated press steel frame.

Economy stand available (includes rollers only).

Description	WPS #
MC305 Truing Stand	235-8621
Economy Truing Stand	235-8255
Optional Balance Shaft w/Tapered Cones	232-2479



- WINDSHIELDS / FAIRINGS
- AUDIO / COMMUNICATION
- SEATS / LUGGAGE
- BARS / MIRRORS / CONTROLS
- EXHAUST
- AIR / FUEL SYSTEMS
- ENGINE
- TRANSMISSION / DRIVELINE
- GASKETS / SEALS
- ELECTRICAL
- LIGHTING
- CABLES
- BRAKES
- OIL FILTERS
- SUSPENSION
- BODY
- WHEELS
- TIRES / TIRE ACC.
- BIKE ACC.
- VICTORY / INDIAN
- COVERS / LOCKS / TIEDOWNS
- CHEMICALS
- TOOLS**
- HELMETS
- HELMET ACC.
- EYEWEAR
- APPAREL / RIDER ACC.
- PROMOTIONAL
- REFERENCE
- INDEX



## ERGO SPOKE WRENCHES



- Unique combination wrench design has 3-sided open end and semi-closed end
- Use open end for quick adjustment of spoke nipples and semi-closed end for those hard to turn nipples that require more torque
- Specially designed ergonomic handle allows larger turning radius and excellent grip and feel
- Polished finish with laser engraved logo and size markings
- Limited life time warranty
- Patent pending

Description	WPS#
Set of 6	57-8526
5.0mm	57-8520
6.0mm	57-8521
6.3mm	57-8522
6.5mm	57-8523
6.8mm	57-8524
7.0mm	57-8525
Spline Drive	57-8580

## SPOKE WRENCH



- Features unique square end openings which grip the spoke nipple on all four sides instead of just two, assuring that the nipple corners are not rounded off during tightening
- With many nipples being made from aluminum or brass, this square tool is important
- Sizes are 6mm and 6.3mm which will fit most Japanese dirt bikes and many street models

Size	WPS#
6mm x 6.3mm	57-8133
6.5mm x 6.8mm	57-8157
5.0mm x 7.0mm	57-8296

- WINDSHIELDS / FAIRINGS
- AUDIO / COMMUNICATION
- SEATS / LUGGAGE
- BAR / MIRRORS / CONTROLS
- EXHAUST
- AIR / FUEL SYSTEMS
- ENGINE
- TRANSMISSION / DRIVELINE
- GASKETS / SEALS
- ELECTRICAL
- LIGHTING
- CABLES
- BRAKES
- OIL FILTERS
- SUSPENSION
- BODY
- WHEELS
- TIRES / TIRE ACC.
- BIKE ACC.
- VICTORY / INDIAN
- COVERS / LOCKS / TIEDOWNS
- CHEMICALS
- TOOLS**
- HELMETS
- HELMET ACC.
- EYEWEAR
- APPAREL / RIDER ACC.
- PROMOTIONAL
- REFERENCE
- INDEX



## PROFESSIONAL TIRE PRESSURE GAUGES

- Liquid glycerin filled gauge gives consistent readings regardless of temperature or elevation
- Pressure range of 0-60 psi for checking sport bike tire
- Liquid filled 2.5 inch dial gauge with protective rubber boot
- Blue anodized 6061 T-6 body with pressure relief valve
- High pressure hose with dual swivels and brass ball type air check



Gauge Holder

Description	WPS#
0-60 psi	57-8402
0-30 psi	57-8258
0-60 psi (Digital)	57-0468
Gauge Holder	57-8475



## TIREPRO DIGITAL TIRE GAUGE

- Ideal for motorcycle and ATV use
- Large display, readings are shown to 0.1 psi levels, with bar, Kpa and Kg-cm2 scales also provided
- Reads up to 99 psi
- An ergonomic shape fits nicely in your hand



WPS#  
57-0012

## TIREPRO GAUGE

- 12" flexible hose makes even hard-to-get-to valves an easy endeavor
- Built-in valve lets you "bleed" down to desired pressure
- Readings are in psi and Kpa (up to 60 psi)
- Dial is protected by a rubber boot



WPS#  
57-0011



## TIRE VALVE REPAIR TOOL

- Inserts & removes valve cores & cores with broken swivels
- Cleans & recuts threads on both inside and outside of valve

WPS#  
85-4106

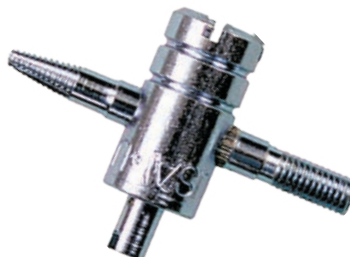





Description	WPS#
Recoil Nylon Air hose 12 ft.	85-5546

## AIR HOSES

Abrasion resistant with permanent "recoil memory". Swivel fittings ensure twist free action. Impervious to paint, solvents, and most chemicals. Withstands up to 200 psi and extends 20 times its stored length. Fitted with 1/4" male couplings at each end. Fittings sold separately.

## AIR LINE FITTINGS

	WPS#
A Male adapter*	85-6153
B Female adapter*	85-6159
C Female coupler*	85-6152

\* Above fittings are not interchangeable with other styles. Whenever ordering these fittings to match existing fittings, check this profile to make sure that you have the same style.



Male Adapter-1/4" male thread screws into blow gun, tire chuck, air wrenches, and many other air tools for quick disconnect when changing air tools on the same hose.



Female Adapter-1/4" female thread screws onto male threads commonly found on extension air hoses. Allows quick disconnect from coupler for use of air hose at another work station.

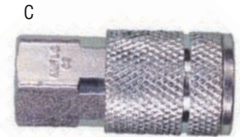

Female Coupler-1/4" female thread screws onto compressor or extension hoses. Coupler automatically shuts off air flow whenever adapters are not inserted.



WPS#
85-5112

## BLOW GUN

This simple, rugged blow gun is reliable and efficient and will provide many years of service. The contoured design is comfortable in the hand. Note the handy hang-up hook. Has 1/4" NPT female thread. Male adapter sold separately.



## TIRE CHUCK

Ball type air chuck fits standard bore valves. Has 1/4" NPT female thread. Male adapter sold separately.

Description	WPS#
A Standard chuck	85-5062
B Chuck w/lock clip	117-1113

## PRO FILL AIR CHUCK

- Pivoting angled head design allows access to difficult to reach tire valves
- Unique design provides added hand clearance between filler and hot brake rotors
- Billet aluminum construction for light weight and precise fit and function
- 1/4" NPT female inlet allows use of common air hose couplings and fittings
- Blue anodized finish with laser engraved Motion Pro logo
- Perfect complement for Motion Pro air gauges
- Patent pending



WPS#
57-8602

## MVP PRO-TECH FOOT PUMP WITH GAUGE

- Equipped with a pressure gauge and durable air hose
- Multi-purpose: Inflates tires, toys, sporting goods and more
- Compact design makes toting and storage easy
- Quick release thumb lock

WPS#
85-6195



WINDSHIELDS / FAIRINGS  
 AUDIO / COMMUNICATION  
 SEATS / LUGGAGE  
 BARS / MIRRORS / CONTROLS  
 EXHAUST  
 AIR / FUEL SYSTEMS  
 ENGINE  
 TRANSMISSION / DRIVELINE  
 GASKETS / SEALS  
 ELECTRICAL  
 LIGHTING  
 CABLES  
 BRAKES  
 OIL FILTERS  
 SUSPENSION  
 BODY  
 WHEELS  
 TIRES / TIRE ACC.  
 BIKE ACC.  
 VICTORY / INDIAN  
 COVERS / LOCKS / TIEDOWNS  
 CHEMICALS  
**TOOLS**  
 HELMETS  
 HELMET ACC.  
 EYEWEAR  
 APPAREL / RIDER ACC.  
 PROMOTIONAL  
 REFERENCE  
 INDEX

Camel



**“SUPER-GRIP” PROBE OR NEEDLE**

A must for every shop. Features a palm fitting handle for much easier installation of repair patches.

	Description	WPS#
A	Probe type	85-5225
B	Needle type	85-5224

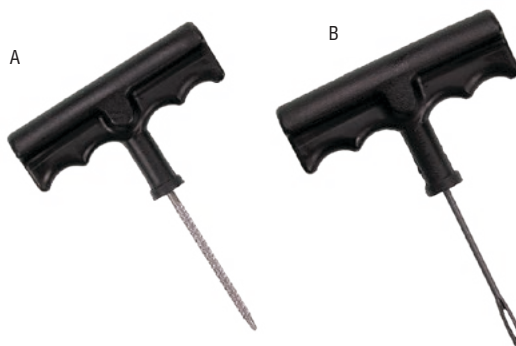

**TIRE REPAIR SUPPLIES**

Packaged to fit Chembond's Tire Service Center.



Description	Qty.	WPS#
Perma Strip Patches	50	85-5179
Sm. Rd. Chembond	40	85-4152
Med. Rd. Chembond	30	85-4153
Universal Cement	1/2 pt.	85-2086
Liquid Buffer	1 qt.	85-2092

**RUBBER REPAIR KIT**

- Repairs inner tubes, tubeless tires, and other soft rubber items
- Kit includes: Four 1<sup>5</sup>/<sub>8</sub>" and two 2<sup>1</sup>/<sub>4</sub>" chembond patches, one small tube of cement, and one buffer



**WPS#**  
85-4130

**TIRE MOUNTING LUBRICANT**

- Makes tire mounting and dismounting easier
- Stops rubber squeaks
- Contains a rust inhibitor
- 8 lb. pail makes 5 gal of lubricant when mixed with water



Description	WPS#
8 pound pail	85-2095
Swab	85-7295

**STITCHING WHEEL**

- Professional Stitcher— Ball-bearing stitcher with hardened steel wheel and hand-fitted wooden handle

**WPS#**  
85-7244



**REPAIR AND INFLATION KITS**



- Three kits to choose from; basic to premium
- Comes in a clear clamshell box to display
- Everything a rider needs to do roadside repairs



**ECONOMY KIT**

Tire plugs, tire reamer, plug installation tool, 12 inch extension hose, Microflate inflator, and three 16g cartridges.

WPS#  
**85-6160**



**AIR CHUCK ELITE**

Air Chuck Elite uses push to inflate technology that allows for rapid tire inflation and it's the lightest CO2 inflator on the market! Backed with a lifetime warranty. Works with both Presta and Schrader valves

WPS#  
**85-6171**



**ATV KIT**

Tire plugs, tire reamer, plug installation tool, 12 inch extension hose, Ultraflate Plus inflator, and three 16g cartridges.

WPS#  
**85-6162**



Description	WPS#
<b>CARTRIDGES</b>	
16 gram non-threaded 2pk	<b>85-6167</b>
16 gram non-threaded 6pk	<b>85-6189</b>
16 gram non-threaded 20pk w/Display	<b>85-1048</b>
16 gram threaded 2pk	<b>85-6178</b>
16 gram threaded 6pk	<b>85-6179</b>
16 gram threaded 20pk w/Display	<b>85-1049</b>
20 gram threaded 2pk	<b>85-6174</b>
20 gram threaded 20pk w/Display	<b>85-1040</b>
25 gram threaded 15pk w/Display	<b>85-1051</b>

WINDSHIELDS / FAIRINGS  
AUDIO / COMMUNICATION  
SEATS / LUGGAGE  
BARS / MIRRORS / CONTROLS  
EXHAUST  
AIR / FUEL SYSTEMS  
ENGINE  
TRANSMISSION / DRIVELINE  
GASKETS / SEALS  
ELECTRICAL  
LIGHTING  
CABLES  
BRAKES  
OIL FILTERS  
SUSPENSION  
BODY  
WHEELS  
TIRES / TIRE ACC.  
BIKE ACC.  
VICTORY / INDIAN  
COVERS / LOCKS / TIEDOWNS  
CHEMICALS  
**TOOLS**  
HELMETS  
HELMET ACC.  
EYEWEAR  
APPAREL / RIDER ACC.  
PROMOTIONAL  
REFERENCE  
INDEX



## OUTBACK'R H13 FOR HARLEY-DAVIDSONS

The Outback'r H13 is a powerhouse of functionality. Included are three hex keys (5/32", 3/16", 1/4"), two Torx keys (T25, T27), slotted and Phillips screwdrivers, a socket driver with 3/8", 7/16", and 1/2" sockets, 10mm box and 9/16" open-end wrenches, plus a spoke wrench. At only 10 ounces and 3.5" long, even chopper riders won't have trouble carrying it.



WPS#

57-0009

## FOLDING HEX/TORX KEY SET FOR H-D

Harley-Davidsons make regular use of hex and Torx fasteners, so we've assembled the most common sizes (5/32", 3/16", 1/4", 5/16", T25, T27, T40) into a compact fold-up unit. Forged from heat-treated chrome vanadium alloy and housed in a tough handle that allows multiple angles of use, even those hard-to-get-to fasteners shouldn't pose any problems.



WPS#

57-0008



## MINI CHAIN PRESS TOOL

- Inexpensive and toolbox sized
- Fits 520, 525 and 530
- Presses on side plates on standard and O-Ring chains

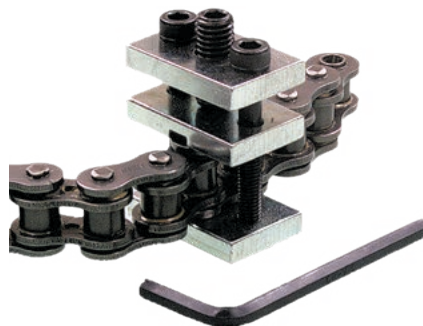

WPS#

57-8070

## CHAIN PRESS TOOL KIT

- Fits #520-#530 standard and O-ring chains



Description	WPS#
Chain Press Tool Kit	57-8066
Press Plates Only	57-8067

- WINDSHIELDS / FAIRINGS
- AUDIO / COMMUNICATION
- SEATS / LUGGAGE
- BARS / MIRRORS / CONTROLS
- EXHAUST
- AIR / FUEL SYSTEMS
- ENGINE
- TRANSMISSION / DRIVELINE
- GASKETS / SEALS
- ELECTRICAL
- LIGHTING
- CABLES
- BRAKES
- OIL FILTERS
- SUSPENSION
- BODY
- WHEELS
- TIRES / TIRE ACC.
- BIKE ACC.
- VICTORY / INDIAN
- COVERS / LOCKS / TIEDOWNS
- CHEMICALS
- TOOLS**
- HELMETS
- HELMET ACC.
- EYEWEAR
- APPAREL / RIDER ACC.
- PROMOTIONAL
- REFERENCE
- INDEX



### MASTER LINK PLIERS

- Designed to simplify installation and removal of clip-type masterlinks
- One tip is shorter and notched to be placed on the pin while the other is longer to easily push the clip

WPS#  
57-8230



### EK PROFESSIONAL CHAIN TOOL

- Machined from a solid billet of hardened steel
- Designed to withstand the rigors of a service department
- Drives out pins and presses master links together

WPS#  
69-9935

### CHAIN•A•PART CHAIN BREAKERS

- Long, hardened-steel punch forces pin all the way out
- So precise it never harms adjacent links
- The secret is Smith Tool's patented clamping cylinder for perfect alignment
- Two models so there is a Chain-A-Part to fit all roller chain series from 420 to 630 chain
- Best buy in roller chain tools in America!
- Packed in a rugged hangable display case with instructions
- Heavy Duty/Shop Quality



Description	WPS#
<b>MODEL A - 520/525/530/630 CHAIN</b>	
Chain Breaker	57-5490
Replacement Punch	57-5491



Description	WPS#
<b>MODEL B - 420/428/520/525/530 CHAIN</b>	
Chain Breaker	57-5495
Replacement Punch	57-5496

- WINDSHIELDS / FAIRINGS
- AUDIO / COMMUNICATION
- SEATS / LUGGAGE
- BAR / MIRRORS / CONTROLS
- EXHAUST
- AIR / FUEL SYSTEMS
- ENGINE
- TRANSMISSION / DRIVELINE
- GASKETS / SEALS
- ELECTRICAL
- LIGHTING
- CABLES
- BRAKES
- OIL FILTERS
- SUSPENSION
- BODY
- WHEELS
- TIRES / TIRE ACC.
- BIKE ACC.
- VICTORY / INDIAN
- COVERS / LOCKS / TIEDOWNS
- CHEMICALS
- TOOLS**
- HELMETS
- HELMET ACC.
- EYEWEAR
- APPAREL / RIDER ACC.
- PROMOTIONAL
- REFERENCE
- INDEX



## T-6 CHAIN TOOL

- Breaks 520 to 530 chain
- Use for pressing on and off 520 and some 525 master link side plates
- Will push link pin completely through link/side plate
- Body forged from high-strength 4130 chrome-moly
- Body and extractor bolts manufactured from billet high-strength 7075 T-6 aluminum
- Replaceable pin is heat treated for strength and wear resistance
- This tool does not rivet master links



Description	WPS#
T-6 Chain Tool	57-8358
Replacement Pin	57-5502
Replacement Spring	57-8001D
Extractor Bolt	57-8358B
Body Bolt	57-8358C

## CHAIN BREAKER

### TOOL COMPARTMENT SIZE

Heat-treated chrome moly body. Extremely compact (4") with folding handle. Fits chain sizes 420, 428, 520, 530 and some 630. Hardened tip completely removes pin. Used in the I.S.D.E. Made in U.S.A.

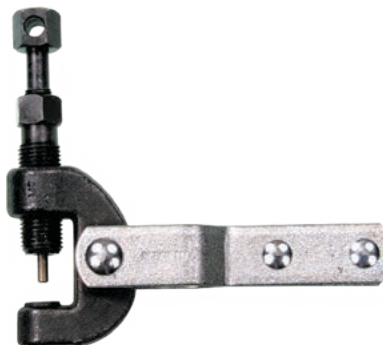

Description	WPS#
Chain Breaker	57-5501
Replacement Tip	57-5502

## CHAIN RIVETING TOOL

This new tool is designed to rivet chain links to form endless chain. Tool may also be used to break chain by pushing pin out. Each tool includes 3 sizes of pins.

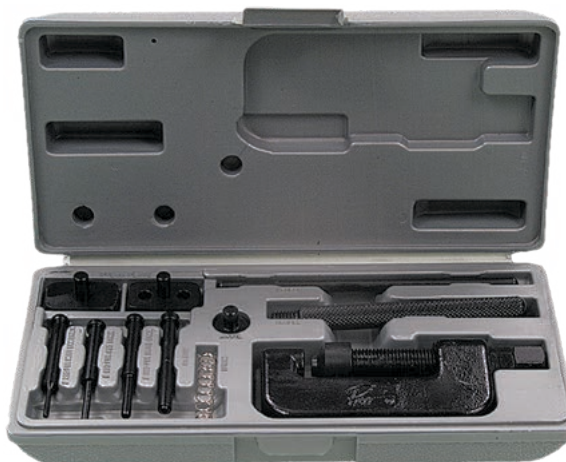

Description	WPS#
Chain Riveting Tool	57-8058
Large Anvil	57-8058D
Replacement tip - 2mm	57-8059
Replacement tip - 3mm	57-8060
Replacement tip - 4mm	57-8061
Replacement Wedge tip	57-8062

## SPROCKET JAMMER



- Prevents rotation of chain and sprockets for easy removal or installation of counter shaft nut
- Can be used to pull rear wheel against chain blocks when tightening rear axle
- CNC billet aluminum construction
- Blue anodize and laser etching for easy identification



WPS#
57-8642



## JUMBO CHAIN TOOL



- Designed to break roller chain up to #630 (Fits all standard & O-ring chain sizes #520 to #630)
- Designed to rivet chain up to #530 (not #630)
- Master link side plate press kit included to press on side plates up to #530 (not #630)
- Screws and attachments are made from 86L20 steel and then heat treated for strength and durability
- Extractor pin is firmly guided by removable guide, ensuring long pin life
- May be bolted to work bench, supported in vise or held by handle
- Bolted to solid surface, air or electric wrenches may be used to break chain
- Recommended for heavy-duty use
- Made in the U.S.A.
- Great for use with the 57-8142 Quad stake rivet kit

Description	WPS#
Jumbo Chain Tool	57-8135
Replacement Pin	57-8035
OPTIONAL RIVET TOOL KIT	
Rivet tool	57-8142



## OPTIONAL QUAD STAKE RIVET TOOL KIT FOR JUMBO CHAIN TOOL

- The perfect compliment to the 57-8135 Jumbo Chain Tool
- Retain that factory quad-stake look
- Safely and properly peens soft-nose-type master link pin tip

WPS#
57-8142

## PBR (PRESS, BREAK, RIVET) CHAIN BREAKER



- Innovative design will Press, Break & Rivet 520, 525, & 530 chains with one convenient tool
- Versatile design will remove chain pins, press master-link plates and rivet hollow nose & soft nose (quad stake) master link pins on O-ring and non O-ring type chains
- Easy to use design allows you to change tool functions by simply moving the position of the anvil block
- Indexing letters on movable anvil and body insures correct tool configuration. Simply line up the letter on the anvil to the letter on the body to get the configuration you need!
- All components conveniently store on tool when not in use
- All steel construction with heat treated components for strength and durability

Description	WPS#
PBR Press	57-8470
Replacement Pin	57-8470C

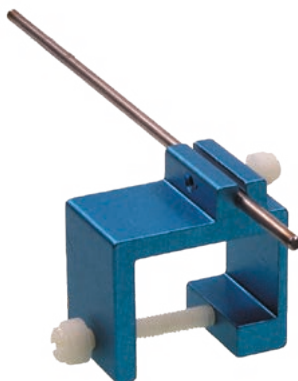

## CHAIN ALIGNMENT TOOL

Tool aids in visual alignment of sprockets allowing accurate wheel alignment when adjusting rear chain. Tool body clamps to rear sprocket with alignment rod pointing directly to front sprocket, simply sight down alignment rod and move rear wheel until sprockets align.

WPS#
57-8048

- WINDSHIELDS / FAIRINGS
- AUDIO / COMMUNICATION
- SEATS / LUGGAGE
- BAR / MIRRORS / CONTROLS
- EXHAUST
- AIR / FUEL SYSTEMS
- ENGINE
- TRANSMISSION / DRIVELINE
- GASKETS / SEALS
- ELECTRICAL
- LIGHTING
- CABLES
- BRAKES
- OIL FILTERS
- SUSPENSION
- BODY
- WHEELS
- TIRES / TIRE ACC.
- BIKE ACC.
- VICTORY / INDIAN
- COVERS / LOCKS / TIEDOWNS
- CHEMICALS
- TOOLS**
- HELMETS
- HELMET ACC.
- EYEWEAR
- APPAREL / RIDER ACC.
- PROMOTIONAL
- REFERENCE
- INDEX



## CHAIN TOOL

- Designed for 520,525,530 and 532 chain sizes
- Handy denim pouch included
- Use tool to push out pins, press plates and rivet links together



**WPS#**

**690-9937**

**REPLACEMENT PIN**

**690-9936**



## CHAIN RIVET TOOL

- Complete chain tool for most 520, 525 and 530 standard and o-ring chains
- Break, press and rivet your chain with one compact tool
- Will rivet hollow nose master links (will not rivet solid soft-nose pins)
- Will push pin completely through link/side plate
- Hardened body, riveting tip and breaker pin for strength and durability
- Removable handle for compact storage
- Perfect for trail/road tool pack if you have a chain with a rivet master link



Description	WPS#
Chain Rivet Tool	57-0467
Replacement Tip 4mm	57-8061
Replacement Wedge Tip	57-8062

## FORK ALIGN TOOL

- Quick and easy to use tool for aligning front forks to ensure they are parallel from top to bottom
- Proper alignment reduces sticking, enhancing fork performance
- Knurled adjustment screws for easy setup
- Reduces seal and bushing wear
- Will work on 27mm - 62mm fork legs and tubes
- Works on forks that are 140mm to 220mm on center
- Patent pending



**WPS#**

**57-8412**

- WINDSHIELDS / FAIRINGS
- AUDIO / COMMUNICATION
- SEATS / LUGGAGE
- BAR / MIRRORS / CONTROLS
- EXHAUST
- AIR / FUEL SYSTEMS
- ENGINE
- TRANSMISSION / DRIVELINE
- GASKETS / SEALS
- ELECTRICAL
- LIGHTING
- CABLES
- BRAKES
- OIL FILTERS
- SUSPENSION
- BODY
- WHEELS
- TIRES / TIRE ACC.
- BIKE ACC.
- VICTORY / INDIAN
- COVERS / LOCKS / TIEDOWNS
- CHEMICALS
- TOOLS**
- HELMETS
- HELMET ACC.
- EYEWEAR
- APPAREL / RIDER ACC.
- PROMOTIONAL
- REFERENCE
- INDEX



**PROFI CAT**  
LASER  
CHAIN ALIGNMENT TOOL



**CHAIN WEAR MEASUREMENT SYSTEM**

- Allows the user to digitally measure chain stretch to help determine if chain replacement is necessary
- This tool can apply up to 625 pounds per square foot (30 kp) of load to the chain for a true wear measurement
- Measurements can be made in inch or metric increments
- Works on all 400 and 500 series chains
- Includes Profi line laser chain/belt alignment tool and storage case

WPS#  
**58-9122**

**PROFI BAT**  
LASER  
BIKE ALIGNMENT TOOL

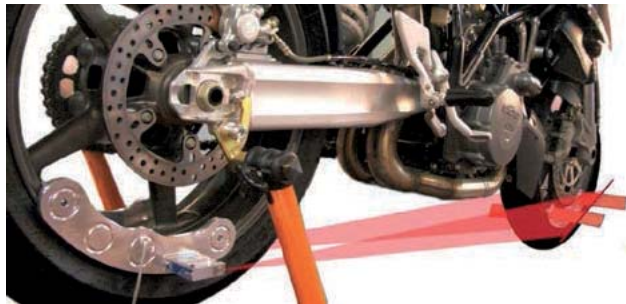

**LASER FRAME ALIGNMENT SYSTEM**

- Accurately determine frame and/or front end damage in a matter of minutes
- Fully portable, stores easily (storage case included)
- Initial measurements are taken off of the rear wheel after being accurately aligned with the Profi Chain/belt alignment tool
- Great aid for insurance and repair estimates, custom bike builders and safety checks
- Offers a new source of shop revenue

Applications	WPS#
Custom V-Twin & Harley Davidson	<b>58-9130</b>
Metric, Sportbike and Scooter	<b>58-9131</b>
Scooter and Sportbike (up to 17" rims)	<b>58-9132</b>

WINDSHIELDS / FAIRINGS  
AUDIO / COMMUNICATION  
SEATS / LUGGAGE  
BARS / MIRRORS / CONTROLS  
EXHAUST  
AIR / FUEL SYSTEMS  
ENGINE  
TRANSMISSION / DRIVELINE  
GASKETS / SEALS  
ELECTRICAL  
LIGHTING  
CABLES  
BRAKES  
OIL FILTERS  
SUSPENSION  
BODY  
WHEELS  
TIRES / TIRE ACC.  
BIKE ACC.  
VICTORY / INDIAN  
COVERS / LOCKS / TIEDOWNS  
CHEMICALS  
**TOOLS**  
HELMETS  
HELMET ACC.  
EYEWEAR  
APPAREL / RIDER ACC.  
PROMOTIONAL  
REFERENCE  
INDEX



## CHAIN MONKEY NEW

Chain Monkey is the world's first tool designed to help you set the tension on your motorcycle's drive chain. The task of tensioning a chain can be a tedious and time consuming task, especially on motorcycles. But not anymore.

By using Chain Monkey, anyone can set their chain tension quickly, easily and with minimal knowledge required. From new riders through to experienced mechanics, Chain Monkey will simplify the task, optimize performance and save you money through its revolutionary, patented design.



Description	WPS#
Chain Monkey	59-2801

## BELT MONKEY NEW

Belt driven motorcycles require the correct drive belt tension to ensure moving components are not over stressed, while providing a smooth and comfortable ride. Achieving the correct tension setting can often take numerous measurements and adjustments while taking up a lot of time.

Belt Monkey has been designed to eliminate the need for countless measurements and adjustments by achieving the correct belt tension first time, every time. Our tool enables riders to tension their belt quickly and with ease.



Description	WPS#
Belt Monkey	59-2802

The simplicity of our product means that you are comfortable maintaining your bike yourself, regardless of experience.



- WINDSHIELDS / FAIRINGS
- AUDIO / COMMUNICATION
- SEATS / LUGGAGE
- BAR / MIRRORS / CONTROLS
- EXHAUST
- AIR / FUEL SYSTEMS
- ENGINE
- TRANSMISSION / DRIVELINE
- GASKETS / SEALS
- ELECTRICAL
- LIGHTING
- CABLES
- BRAKES
- OIL FILTERS
- SUSPENSION
- BODY
- WHEELS
- TIRES / TIRE ACC.
- BIKE ACC.
- VICTORY / INDIAN
- COVERS / LOCKS / TIEDOWNS
- CHEMICALS
- TOOLS**
- HELMETS
- HELMET ACC.
- EYEWEAR
- APPAREL / RIDER ACC.
- PROMOTIONAL
- REFERENCE
- INDEX



### HYDRAULIC BRAKE BLEEDER

- New Brake Bleeder will aid in the bleeding and servicing of hydraulic brakes
- Makes bleeding brakes a one man job
- The unique check valve allows fluid and air to escape while preventing air from re-entering the system

WPS#

57-8143



### MINI BLEEDER

- Combines wrench and bleeder valve into one convenient and compact tool
- Fits most 8mm bleeder nipples
- Bleeds brake systems and hydraulic clutch systems
- Internal check valve for fast easy bleeding
- Anodized billet aluminum handle with chrome moly steel body
- Compact size for tight spaces
- High quality internal seal
- Multi position handle

Description	WPS#
8mm	57-8482
10mm	57-8529
11mm	57-8530
3/8"	57-8543



WPS#

57-8279

### MASTER CYLINDER SNAP-RING PLIERS

- Allows removal of internal snap rings used in hydraulic master cylinders
- Replaces 07914-SA50001 and AKS-316-2010
- Can be used to remove and replace small to medium internal snap rings up to 50mm deep, including those used for transmission gear locating, bearing retention, and seal retention
- Applicable to some fork seal retaining rings



### BRAKE CALIPER PISTON TOOL

WPS#

57-8591

- WINDSHIELDS / FAIRINGS
- AUDIO / COMMUNICATION
- SEATS / LUGGAGE
- BAR / MIRRORS / CONTROLS
- EXHAUST
- AIR / FUEL SYSTEMS
- ENGINE
- TRANSMISSION / DRIVELINE
- GASKETS / SEALS
- ELECTRICAL
- LIGHTING
- CABLES
- BRAKES
- OIL FILTERS
- SUSPENSION
- BODY
- WHEELS
- TIRES / TIRE ACC.
- BIKE ACC.
- VICTORY / INDIAN
- COVERS / LOCKS / TIEDOWNS
- CHEMICALS
- TOOLS**
- HELMETS
- HELMET ACC.
- EYEWEAR
- APPAREL / RIDER ACC.
- PROMOTIONAL
- REFERENCE
- INDEX

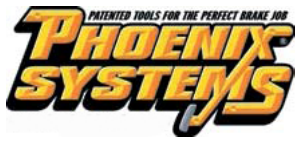

## REVERSE BRAKE BLEEDER

- The tool that makes brake or clutch bleeding fast, precise and easy
- The patented Reverse Bleed Technology is what makes this tool so unique
- Removes more trapped air than any other bleeder
- The only system for those tough ABS units without a scan tool
- Allows you to refill and bleed a complete dry clutch or brake system
- Can be used on the machine or pre bleed on a bench
- The V-5 Bleeder is compatible with DOT 3,4 and 5.1
- The easiest one person tool ever used

Description	WPS#
V-5 Reverse Bleeder Brake & Clutch	57-8217

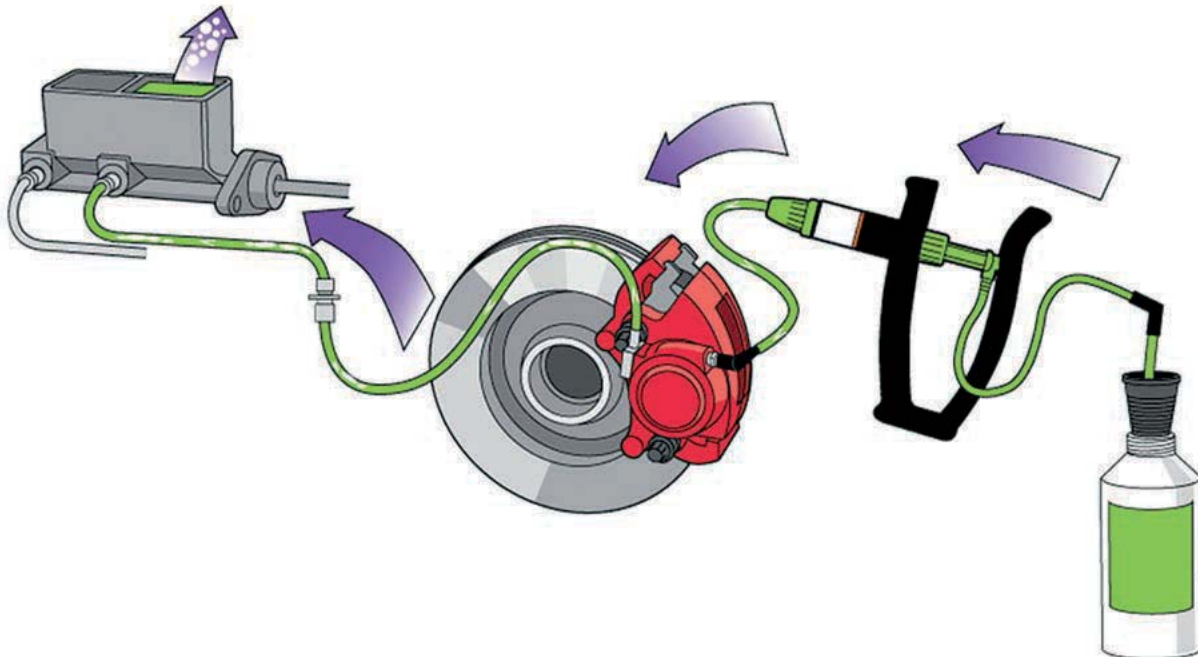



### ADJUSTABLE FORK SEAL DRIVER

WPS#  
235-7998

- Adjustable fork seal driver, fits 38mm to 52mm fork seals.



### SEAL MATE



- Easy way to keep your fork seals clean and debris free
- Extract dirt or debris trapped between fork seal and tube
- Will work on conventional and up-side down forks
- Sold on a card of 12

WPS#	
1 ea	57-8395
12/CD	57-8356



WPS#	Measurements
57-8486	35mm/36mm
57-8487	37mm
57-8488	39mm
57-8489	41mm
57-8490	43mm
57-8491	45mm
57-8492	46mm/47mm
57-8493	48mm
57-8494	49mm/50mm

### RINGER FORK SEAL DRIVER

- Innovative design makes tool easier and safer to use than old fashioned pin aligned drivers
- Anodized aluminum locking ring features knurled finish for secure no-slip grip and positively locks body halves together during use
- No more worrying about part of the tool falling off and damaging the fork leg or hitting your feet
- Perfectly weighted to drive seals
- Body halves are machined from durable carbon steel and feature high quality protective black e-coat with laser engraved markings
- Lifetime warranty
- Patent pending

### WHEEL BEARING REMOVER KITS



Description	WPS#
2 pc. set 3/4"	57-80271
3 pc. set 3/4", 1"	57-8354
4 pc. set 3/4", 1", 25mm	57-8410
REPLACEMENT PARTS	
Large driver rod	57-8260
25mm remover	57-8267
3/4" remover	57-8265
1" remover	57-8381

- Set uses a split collet design to remove radial ball bearings on Harley-Davidson and American V-Twin motorcycles
- 57-8410 kit includes large driver, 3/4", 1" and 25mm collets
- All 2007 Softail models (exc. Springer models) use a 25mm radial ball bearing on the front wheel

- WINDSHIELDS / FAIRINGS
- AUDIO / COMMUNICATION
- SEATS / LUGGAGE
- BARS / MIRRORS / CONTROLS
- EXHAUST
- AIR / FUEL SYSTEMS
- ENGINE
- TRANSMISSION / DRIVELINE
- GASKETS / SEALS
- ELECTRICAL
- LIGHTING
- CABLES
- BRAKES
- OIL FILTERS
- SUSPENSION
- BODY
- WHEELS
- TIRES / TIRE ACC.
- BIKE ACC.
- VICTORY / INDIAN
- COVERS / LOCKS / TIEDOWNS
- CHEMICALS
- TOOLS**
- HELMETS
- HELMET ACC.
- EYEWEAR
- APPAREL / RIDER ACC.
- PROMOTIONAL
- REFERENCE
- INDEX



- WINDSHIELDS / FAIRINGS
- AUDIO / COMMUNICATION
- SEATS / LUGGAGE
- BARS / MIRRORS / CONTROLS
- EXHAUST
- AIR / FUEL SYSTEMS
- ENGINE
- TRANSMISSION / DRIVELINE
- GASKETS / SEALS
- ELECTRICAL
- LIGHTING
- CABLES
- BRAKES
- OIL FILTERS
- SUSPENSION
- BODY
- WHEELS
- TIRES / TIRE ACC.
- BIKE ACC.
- VICTORY / INDIAN
- COVERS / LOCKS / TIEDOWNS
- CHEMICALS
- TOOLS**
- HELMETS
- HELMET ACC.
- EYEWEAR
- APPAREL / RIDER ACC.
- PROMOTIONAL
- REFERENCE
- INDEX

## FORK SEAL BULLET SET

- Protects the fork seal and wiper of inverted forks from damage by the bushing groove during installation
- Saves time by eliminating the need to wrap the fork tube with tape
- Set includes all seven sizes
- Each size is a different color
- Also available separately

Description	WPS#
Set of 7	<b>57-8282</b>
36mm red	<b>57-8283</b>
41mm blue	<b>57-8284</b>
43mm green	<b>57-8285</b>
45mm yellow	<b>57-8286</b>
46mm black	<b>57-8287</b>
47mm white	<b>57-8288</b>
48mm	<b>57-0332</b>



## H-D® FORK SPRING COMPRESSION TOOLS

- Designed to install fork caps on forks with a large amount of spring pre-load
- Will work on most 39mm and 41mm Harley-Davidson forks
- Reduces risk of damage to fork caps during installation

Description	WPS#
39mm/41mm kit	<b>57-8299</b>
39mm kit	<b>57-80300</b>
41mm kit	<b>57-80301</b>
REPLACEMENT PARTS	
Jackscrew	<b>57-80302</b>
39mm adapter	<b>57-80303</b>
41mm adapter	<b>57-80304</b>
39mm fork cap socket	<b>57-8139</b>
41mm fork cap socket	<b>57-80305</b>



## FORK CAP NUT SOCKET FOR H-D®

- Use for removal and installation of the fork cap nut
- Fits most Big Twin, Sportster, and other models w/39mm or 41mm forks
- O-ring insert to help protect the top of the cap

Description	WPS#
39mm forks	<b>57-8139</b>
41mm forks	<b>57-80305</b>



## 36MM AXLE SOCKET



- Facilitates loosening and tightening of hard to reach rear axle nut on H-D® baggers
- Fits 36 mm axle nuts
- Captive swivel extension with ½ inch drive
- Rated for up to 175 foot pounds of torque
- Durable plastic sleeve protects exhaust system
- Lifetime limited warranty

Description	WPS#
Axle Socket 36mm	<b>57-8635</b>





## STEERING STEM TOOL FOR H-D



- Removes and installs tapered roller bearing at base of steering stem
- Fits most Harley Davidson motorcycles with tapered roller bearing at base of steering stem
- Durable black oxide finish with laser engraved logo
- Compact design to fit with steering stops on lower triple clamp
- Removal process requires cutting outer sheet metal cage from tapered roller bearing unit
- Removes bearing without damaging steering stem
- Bearing driver adapter installs new bearing without damage to bearing or steering stem

**WPS #**  
**57-8558**

## FORK SPRING TOOL FOR SPRINGER FORKS



- Assists in the disassembly and assembly of springer-type front forks on Harley-Davidson motorcycles
- Made in the USA

**WPS#**  
**57-8144**

## FORK OIL LEVEL GAUGE



- The perfect tool for checking or adjusting fork oil levels
- Works on any conventional or inverted fork
- Aluminum adjusting ring will measure from 0-300mm
- Syringe has a capacity of approximately 60ml

**WPS#**  
**57-8121**

WINDSHIELDS / FAIRINGS
AUDIO / COMMUNICATION
SEATS / LUGGAGE
BAR / MIRRORS / CONTROLS
EXHAUST
AIR / FUEL SYSTEMS
ENGINE
TRANSMISSION / DRIVELINE
GASKETS / SEALS
ELECTRICAL
LIGHTING
CABLES
BRAKES
OIL FILTERS
SUSPENSION
BODY
WHEELS
TIRES / TIRE ACC.
BIKE ACC.
VICTORY / INDIAN
COVERS / LOCKS / TIEDOWNS
CHEMICALS
<b>TOOLS</b>
HELMETS
HELMET ACC.
EYEWEAR
APPAREL / RIDER ACC.
PROMOTIONAL
REFERENCE
INDEX



- WINDSHIELDS / FAIRINGS
- AUDIO / COMMUNICATION
- SEATS / LUGGAGE
- BARS / MIRRORS / CONTROLS
- EXHAUST
- AIR / FUEL SYSTEMS
- ENGINE
- TRANSMISSION / DRIVELINE
- GASKETS / SEALS
- ELECTRICAL
- LIGHTING
- CABLES
- BRAKES
- OIL FILTERS
- SUSPENSION
- BODY
- WHEELS
- TIRES / TIRE ACC.
- BIKE ACC.
- VICTORY / INDIAN
- COVERS / LOCKS / TIEDOWNS
- CHEMICALS
- TOOLS**
- HELMETS
- HELMET ACC.
- EYEWEAR
- APPAREL / RIDER ACC.
- PROMOTIONAL
- REFERENCE
- INDEX

## STEERING RACE REMOVER

- Makes head tube bearing race removal easy
- Tool is pulled through the steering tube until the flared ends snap in behind the race. A blow on the tool head removes the race
- Tool fits most brands with 35-55 mm bearing races



Description	WPS#
35-38mm	57-00726
25-31mm	57-00727

## STEERING RACE PRESS

- HHP-2M easily and accurately presses steering head tube races, eliminating damaged or misaligned bearing races and helps prevent dented and chipped frames
- Unique design permits quick tool installation and release after races are seated
- Heat-treated bushing (included) provide a precise fit and alignment for most brands



WPS#
57-00725

## STEERING TUBE BEARING INSTALLER

- New safe approach to lower bearing installation
- Unique system utilizes specially designed aluminum inserts to quickly and accurately install nearly any lower bearing
- Includes three specifically shaped aluminum inserts (1", 1 1/8", 1 3/8") and a heat treated, universal setting driver

WPS#
57-00728







## WORK STAND



- Designed to safely and securely hold round or odd shaped components
- 360° rotation of the clamp
- Two models - bench mount and wall mount

Description	WPS#
Bench mount	57-00702
Wall mount	57-00703
Repl. Jaw cover	57-00705



## ALUMINUM VISE INSERT

- Safe way to hold suspension shafts
- Holds from 7mm to 15mm shafts
- Magnetic strips attach to vise jaws for easy, trouble free use

WPS#
57-00716



## PRESSURIZING SHOCK GAUGES



Brand	Description	WPS#
A RydeFX	Needle type w/gauge	53-390300
B Motion Pro	Schrader valve type w/gauge	54-1560
Motion Pro	Needle adapter for Schrader type	54-1561
Motion Pro	Replacement Needle	54-1561RN
RydeFX	20/pack repl. needles	53-390301

- WINDSHIELDS / FAIRINGS
- AUDIO / COMMUNICATION
- SEATS / LUGGAGE
- BARS / MIRRORS / CONTROLS
- EXHAUST
- AIR / FUEL SYSTEMS
- ENGINE
- TRANSMISSION / DRIVELINE
- GASKETS / SEALS
- ELECTRICAL
- LIGHTING
- CABLES
- BRAKES
- OIL FILTERS
- SUSPENSION
- BODY
- WHEELS
- TIRES / TIRE ACC.
- BIKE ACC.
- VICTORY / INDIAN
- COVERS / LOCKS / TIEDOWNS
- CHEMICALS
- TOOLS**
- HELMETS
- HELMET ACC.
- EYEWEAR
- APPAREL / RIDER ACC.
- PROMOTIONAL
- REFERENCE
- INDEX

- WINDSHIELDS / FAIRINGS
- AUDIO / COMMUNICATION
- SEATS / LUGGAGE
- BARS / MIRRORS / CONTROLS
- EXHAUST
- AIR / FUEL SYSTEMS
- ENGINE
- TRANSMISSION / DRIVELINE
- GASKETS / SEALS
- ELECTRICAL
- LIGHTING
- CABLES
- BRAKES
- OIL FILTERS
- SUSPENSION
- BODY
- WHEELS
- TIRES / TIRE ACC.
- BIKE ACC.
- VICTORY / INDIAN
- COVERS / LOCKS / TIEDOWNS
- CHEMICALS
- TOOLS**
- HELMETS
- HELMET ACC.
- EYEWEAR
- APPAREL / RIDER ACC.
- PROMOTIONAL
- REFERENCE
- INDEX



## MOTORCYCLE SHOCK SPRING INSTALLER

- Install shock springs in less than 30 seconds
- Dual shoe will work on right and left hand wound springs
- Heavy duty, shop quality

WPS#

**57-6100**



## SPRING PULLER

Tired of skinned up knuckles? Every mechanic or enthusiast/tuner should have at least one of these.

WPS#

**57-00224**



## SPANNER WRENCH

WPS#

**57-00225**



## JET CLEANING TOOL

- Priceless item to clean carb jets and small holes
- Compact enough to keep in your toolbox.
- Ten pin sizes to clean most common jet sizes



WPS#

**14-0020**



## DELUXE PISTON PIN PULLER



Short skirt adapter for (slipper) pistons

- Interchangeable piston adapters for use on both long skirt and short skirt (slipper) pistons
- Fits all piston pins from 12 mm (1/2") to 24 mm (1")
- Made of 6061 aluminum with non-marring aluminum adapters and durable blue anodized finish
- Patent pending

WPS#

57-8472

## ADJUSTABLE TORQUE WRENCH ADAPTER



- Torque any fastener with a combination wrench or Allen wrench
- Will work with 6mm (1/4") through 19mm (3/4") combination wrenches
- Heat treated steel with black oxide finish
- 3/8" square drive is rated for a maximum torque of 90 ft-lbs.

WPS#

57-8380



## PISTON PIN PULLER



Universal Piston Pin Puller easily removes all sizes of piston pins without any damage to pistons.

WPS#

12-1026



## AUXILIARY TANK

For shop use when tuning with gas tank off bike; takes place of regular gas tank while running machine. Includes 4 feet of 1/4" fuel line and in line petcock. If using with fuel injected bike use a T-fitting and second fuel valve for return fuel.

WPS#

57-8032



## CARBURETOR LEAK DETECTOR

- Check needle and seat holding pressure
- Track down leaking crankshaft seals and imperfections in crankcase surfaces
- This tool should be in every service department



Description

WPS#

30 psi Mikuni 13-2767

100 psi Mikuni 13-2768

WINDSHIELDS / FAIRINGS

AUDIO / COMMUNICATION

SEATS / LUGGAGE

BARS / MIRRORS / CONTROLS

EXHAUST

AIR / FUEL SYSTEMS

ENGINE

TRANSMISSION / DRIVELINE

GASKETS / SEALS

ELECTRICAL

LIGHTING

CABLES

BRAKES

OIL FILTERS

SUSPENSION

BODY

WHEELS

TIRES / TIRE ACC.

BIKE ACC.

VICTORY / INDIAN

COVERS / LOCKS / TIEDOWNS

CHEMICALS

**TOOLS**

HELMETS

HELMET ACC.

EYEWEAR

APPAREL / RIDER ACC.

PROMOTIONAL

REFERENCE

INDEX



## STONE-TYPE GLAZE BREAKER

- Full 2" to 7" range (50.8 - 177.8 mm) Controlled pressure assures positive, adjustable contact through full range
- 3 stones provide more cutting surface and assures quick removal of cylinder glaze
- Adjustable stop-collar permits quick selection of two range settings, from 2" to 4" and from 4" to 7", and serves as safety stop if tool is extracted from cylinder while turning
- Operates with any electric drill
- Easily compressed with one hand to eliminate vertical scratches which might spoil the diamond cross-hatch pattern when removing tool from cylinder
- Furnished with 220 grit stones



Description	WPS#
Glaze Breaker	39-1030
3/PK Repl. Stone 180 Grit	39-1035
3/PK Repl. Stone 280 Grit	39-1038



## ALIGNMENT TOOL

- Used for tappet block and oil pump alignment (2 required)
- 1/4"-20 thread



Description	WPS#
Alignment Tool (ea) Repl. OEM 33443	820-53500



## NYLON FLEXHONE BRUSH

- Ideal for high-performance engine building
- Abrasive impregnated nylon bristles
- Does not enlarge more, but removes microscopic peaks and scuffs left after honing
- Gives a superior plateau finish
- Safe for use in 2-cycle engines
- Designed for plated, cast iron bores
- Full range of bore size available



Description	WPS#
45-57mm	39-6075
57-70mm	39-6076
63-76mm	39-6077
76-89mm	39-6078
89-102mm	39-6079

- WINDSHIELDS / FAIRINGS
- AUDIO / COMMUNICATION
- SEATS / LUGGAGE
- BARS / MIRRORS / CONTROLS
- EXHAUST
- AIR / FUEL SYSTEMS
- ENGINE
- TRANSMISSION / DRIVELINE
- GASKETS / SEALS
- ELECTRICAL
- LIGHTING
- CABLES
- BRAKES
- OIL FILTERS
- SUSPENSION
- BODY
- WHEELS
- TIRES / TIRE ACC.
- BIKE ACC.
- VICTORY / INDIAN
- COVERS / LOCKS / TIEDOWNS
- CHEMICALS
- TOOLS**
- HELMETS
- HELMET ACC.
- EYEWEAR
- APPAREL / RIDER ACC.
- PROMOTIONAL
- REFERENCE
- INDEX



## COMPRESSION TESTER

10, 12, 14 and 18mm screw-in adapters on a 12" flexible hose and air release quick-coupler make this tester fast and easy to use in testing snowmobiles, motorcycles, chain-saws, lawn mowers and outboards.

WPS#

57-8188



## 4-STROKE LEAK DOWN TESTER

- Designed to check the amount of cylinder leakage in a 4-stroke engine
- With an air source of 70 to 160 psi. this system will pressurize the cylinder with 60 psi. of air
- Gauge will register the total percentage of leakage past the rings, head gasket, intake and exhaust valves
- 10, 12, & 14mm spark plug thread hoses, regulator and gauge included
- Speeds up troubleshooting and helps to isolate bad components
- Made in the U.S.A.
- Packed in a convenient carry box, complete with instructions

Description	WPS#
4-Stroke leak down tester	57-8126
Replacement 10mm Hose	57-8126X
Replacement 12mm Hose	57-8126Y
Replacement 14mm Hose	57-8126Z



## CAM INSTALLATION KIT

Includes degree wheel, dial indicator, adjustable magnetic stand, three positive stops (10mm, 12mm, 14mm threads) in a wooden case

WPS#

68-2075

WINDSHIELDS / FAIRINGS  
 AUDIO / COMMUNICATION  
 SEATS / LUGGAGE  
 BARS / MIRRORS / CONTROLS  
 EXHAUST  
 AIR / FUEL SYSTEMS  
 ENGINE  
 TRANSMISSION / DRIVELINE  
 GASKETS / SEALS  
 ELECTRICAL  
 LIGHTING  
 CABLES  
 BRAKES  
 OIL FILTERS  
 SUSPENSION  
 BODY  
 WHEELS  
 TIRES / TIRE ACC.  
 BIKE ACC.  
 VICTORY / INDIAN  
 COVERS / LOCKS / TIEDOWNS  
 CHEMICALS  
**TOOLS**  
 HELMETS  
 HELMET ACC.  
 EYEWEAR  
 APPAREL / RIDER ACC.  
 PROMOTIONAL  
 REFERENCE  
 INDEX



## VALVE SPRING COMPRESSOR

- Heavy-duty construction, economical price
- Comes with 19mm, 23mm, 25mm collars
- Carrying case included

WPS#

57-8011



## STETHOSCOPE

- Helps to diagnose engine and bearing noises
- Comes with extension

WPS#

57-8010



## DEGREE WHEEL

Manufactured from .052" thick with a 6 $\frac{3}{4}$ " outside diameter and a 6mm center hole. The black anodized finish allows for easy to read increments. This degree wheel can be used on all 2 cycle engines to check or setup the port timing or ignition timing. May be used on 4 cycle engines to check or adjust cam timing or ignition timing.



WPS#

57-8092

## VALVE SPRING COMPRESSOR

- Improved quick action design
- Replaces 07757-0010000 and AKS-215-1010 OEM tools
- Accepts Motion Pro adapters as well as OEM adapters 07GME-KT70200, 07JME-KY20100, and 07959-KM30101 for use in "shim under bucket" and small diameter valve spring keeper application
- Both cup-type and ball-type tips are included



WPS#

57-8247

## QUICK-ACTION ADAPTER AND BORE PROTECTOR SET

- The set includes 2 adapters and 3 bore protectors for use with the Quick-Action Valve Spring Compressor
- 23mm bores protector can be used with the Small Multi-Valve Tool in "shim under bucket" applications
- Replaces 2K-07-S04, 07GMW-KT70200, 07GME-KT70100, 07JME-KY20100, 07JMG-KY20100, 07959-KM30101, and 07HMG-MR70002



WPS#

57-8248

- WINDSHIELDS / FAIRINGS
- AUDIO / COMMUNICATION
- SEATS / LUGGAGE
- BAR / MIRRORS / CONTROLS
- EXHAUST
- AIR / FUEL SYSTEMS
- ENGINE
- TRANSMISSION / DRIVELINE
- GASKETS / SEALS
- ELECTRICAL
- LIGHTING
- CABLES
- BRAKES
- OIL FILTERS
- SUSPENSION
- BODY
- WHEELS
- TIRES / TIRE ACC.
- BIKE ACC.
- VICTORY / INDIAN
- COVERS / LOCKS / TIEDOWNS
- CHEMICALS
- TOOLS**
- HELMETS
- HELMET ACC.
- EYEWEAR
- APPAREL / RIDER ACC.
- PROMOTIONAL
- REFERENCE
- INDEX



### OIL FILTER MAGNET

- Easy to install, just attach to base of standard oil filter
- Standard oil filters only trap particles down to 20 microns, leaving the most harmful 5 to 20 micron particles to circulate through your engine
- Powerful six point magnet traps harmful, abrasive hard metal particles down to 1 micron that regular oil filters don't
- No gimmick, these things really work to reduce wear, and significantly increase engine life
- Available in two sizes to fit most spin on and cartridge oil filters
- Makes any oil filter better than a high performance oil filter
- Reusable for up to 5 oil filter changes



Description	WPS#
Fits 23.8mm and 15/16" hole filters	57-10083



### OIL FILTER STRAP WRENCH

- Fits all spin-on type oil filters
- Use with 3/8" drive ratchet handle
- Easily loosens tight filters
- Fits into hard to reach locations
- Can be used to loosen or tighten cylindrical shaped parts

Application	WPS#
Cloth Strap	57-8000



### SNAP RING PLIERS

- Economical pliers that easily work on both inside and outside opening snap rings or clips
- Includes 3 extra sets of tips, 1 additional straight tip and 2 offset or angled tips

WPS#
57-8186

### CLUTCH HOLDING TOOL

Designed to hold clutch baskets, flywheels, gears, sprockets, etc. Jaws open to 5 inches wide. Made of medium carbon steel with hardened jaws. A very useful tool for holding any kind of mechanical work.



WPS#
57-8008

- WINDSHIELDS / FAIRINGS
- AUDIO / COMMUNICATION
- SEATS / LUGGAGE
- BAR / MIRRORS / CONTROLS
- EXHAUST
- AIR / FUEL SYSTEMS
- ENGINE
- TRANSMISSION / DRIVELINE
- GASKETS / SEALS
- ELECTRICAL
- LIGHTING
- CABLES
- BRAKES
- OIL FILTERS
- SUSPENSION
- BODY
- WHEELS
- TIRES / TIRE ACC.
- BIKE ACC.
- VICTORY / INDIAN
- COVERS / LOCKS / TIEDOWNS
- CHEMICALS
- TOOLS**
- HELMETS
- HELMET ACC.
- EYEWEAR
- APPAREL / RIDER ACC.
- PROMOTIONAL
- REFERENCE
- INDEX



## ROCKER BOX COVER WRENCH

- Designed to reach hard to get 3/16 in. allen on the rocker boxes of Big Twin, Sportster & Buell motorcycles
- Features a 3/8" drive for use with torque wrench
- Vinyl cover offers comfort and minimizes chances of damage to finished surfaces



WPS#

57-8220

## H-D® PUSHROD TOOL

- Designed to remove and install the clip on Harley-Davidson collapsible push rod tubes
- Flat portion of tool fits under the cylinder head while cupped end fits over the bell in the tube and then compresses the spring allowing for easy access to the spring cap retainer
- No more cut knuckles & scratched engine parts from using a screwdriver between the fins



WPS#

57-8255

## SIDE CASE COVER PULLER FOR H-D®

- Used to remove the right side-case cover
- Will fit late model Harley-Davidson motorcycles, including all 1970 and later Big Twin models and 1990 and later Sportster models
- Includes bracket, puller bolt and set screws
- Made in the USA



WPS#

57-8153

## TAPPET TOOL FOR H-D®

- For use on big twin (excluding twin cam) with slotted screw tappet oil filter screen cover
- Designed for use with 7/16" combination wrench to allow for maximum rotation without touching engine cases
- O-ring design retains the tool in wrench or socket
- Flange design allows downward force to be applied to tool
- Can be used without removing exhaust pipes on most bikes
- Tappets should be serviced every oil change



WPS#

57-8339

## PRO CLUTCH ADJUSTER TOOL FOR H-D

- For use on all 1998 and later models excluding applications with hydraulic clutches
- Deep socket allows tool to recess into clutch basket and can be driven with 11/16" combination wrench or adjustable wrench
- Through hole allows access with hex wrench to hold clutch adjuster screw while simultaneously tightening the adjuster lock-nut
- Heavy duty tool for shop or home use
- Compact design fits easily in the saddle bag or tool wrap



WPS#

57-8548

WINDSHIELDS / FAIRINGS

AUDIO / COMMUNICATION

SEATS / LUGGAGE

BAR / MIRRORS / CONTROLS

EXHAUST

AIR / FUEL SYSTEMS

ENGINE

TRANSMISSION / DRIVELINE

GASKETS / SEALS

ELECTRICAL

LIGHTING

CABLES

BRAKES

OIL FILTERS

SUSPENSION

BODY

WHEELS

TIRES / TIRE ACC.

BIKE ACC.

VICTORY / INDIAN

COVERS / LOCKS / TIEDOWNS

CHEMICALS

**TOOLS**

HELMETS

HELMET ACC.

EYEWEAR

APPAREL / RIDER ACC.

PROMOTIONAL

REFERENCE

INDEX



**BAKER TOOLS**



**MAINDRIVE GEAR AND BEARING SERVICE KIT**

- This kit is required for removing the old maindrive gear and bearing and installing the new ones
- The designs of these tools are based on the standard Harley tools but adapted to service left side drive 5 & 6 speeds and right side drive 5 & 6 speeds
- The steel components of this service kit are hard chrome plated and polished
- The aluminum components are anodized candy apple red. Includes very detailed tool sequence instruction sheets.



**INNER PRIMARY RACE SERVICE KIT**

- This kit is required for removing and installing the inner primary bearing race
- Big Twin models from late 1984-up
- The inner race must be removed to slide the gearset out of the case
- This tool is based on the standard Harley tool but adapted to service left side drive 5 & 6 speeds and right side drive 5 & 6 speeds



**PULLEY NUT LOCKING TOOL**

- The pulley locking tool is clamped to the pulley as shown and prevents pulley rotation while torquing the 1-7/8" pulley nut to the proper factory spec. of 50ft-lbs + 35 degrees
- Anodized candy apple red, works on 29-34 tooth pulley's



**PULLEY NUT SOCKET**

- The mother of all pulley nut socket wrenches
- Its made from one piece of bar stock and hard chrome plated for a super tough finish
- The throat of our wrench is deeper than other wrenches to enable service work on Right Side Drive 5-Speed and 6-Speed transmissions

Description	Application	WPS #
Maindrive gear and bearing service kit	'87-06 Big Twin (exc. '06 Dyna)	<b>821-1112</b>
Maindrive gear and bearing service kit	'06-up Dyna, '07-up Touring	<b>821-1113</b>
Inner primary race service kit	'87-up Big Twin, all	<b>821-1115</b>
Pulley nut locking tool	'87-06 Big Twin (except '06 Dyna models)	<b>821-1095</b>
Pulley nut socket, 1 7/8" hex	'79-06 5-Speeds	<b>821-1096</b>
Pulley nut socket, 2 1/4" hex	'06-up Dyna, '07-up Touring	<b>821-1097</b>

- WINDSHIELDS / FAIRINGS
- AUDIO / COMMUNICATION
- SEATS / LUGGAGE
- BARS / MIRRORS / CONTROLS
- EXHAUST
- AIR / FUEL SYSTEMS
- ENGINE
- TRANSMISSION / DRIVELINE
- GASKETS / SEALS
- ELECTRICAL
- LIGHTING
- CABLES
- BRAKES
- OIL FILTERS
- SUSPENSION
- BODY
- WHEELS
- TIRES / TIRE ACC.
- BIKE ACC.
- VICTORY / INDIAN
- COVERS / LOCKS / TIEDOWNS
- CHEMICALS
- TOOLS**
- HELMETS
- HELMET ACC.
- EYEWEAR
- APPAREL / RIDER ACC.
- PROMOTIONAL
- REFERENCE
- INDEX

- WINDSHIELDS / FAIRINGS
- AUDIO / COMMUNICATION
- SEATS / LUGGAGE
- BAR / MIRRORS / CONTROLS
- EXHAUST
- AIR / FUEL SYSTEMS
- ENGINE
- TRANSMISSION / DRIVELINE
- GASKETS / SEALS
- ELECTRICAL
- LIGHTING
- CABLES
- BRAKES
- OIL FILTERS
- SUSPENSION
- BODY
- WHEELS
- TIRES / TIRE ACC.
- BIKE ACC.
- VICTORY / INDIAN
- COVERS / LOCKS / TIEDOWNS
- CHEMICALS
- TOOLS**
- HELMETS
- HELMET ACC.
- EYEWEAR
- APPAREL / RIDER ACC.
- PROMOTIONAL
- REFERENCE
- INDEX



## IGNITION POINT TOOL

- Locks ignition points to advance position during tune-ups and work on distributor systems
- Precision machined from the finest quality materials
- For professional and serious home service use
- Packaged individually on skin pack display card

Application	Year	WPS#
Big Twin Models	'70-78	62-2056

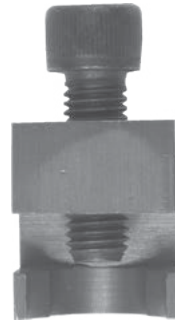

## CRANKSHAFT JAM TOOL

- Allows timing work to be done by locking the crankshaft through the timing mark hole
- Precision machined from the finest quality materials
- For professional and serious home service use
- Packaged individually on skin pack display card

Application	Year	WPS#
Big Twins and Sportster models	'70-Up	62-2057



## CRANKSHAFT TURNING TOOL

- Allows for rotation of the crankshaft during all engine work
- Precision machined from the finest quality materials
- For professional and serious home service use
- Packaged individually on skin pack display card

Application	Year	WPS#
Big Twin models	'70-Up	62-2058



## CLUTCH HUB REMOVING DRIVER

- Removes clutch hub from the transmission main shaft (left hand threads)
- Precision machined from the finest quality materials
- For professional and serious home service use
- Packaged individually on skin pack display card

Application	Year	WPS#
Big Twin models	1930-Up	62-2059





**CLUTCH SPRING TOOL FOR H-D®**

- Fits most Harley-Davidson Big Twin models from '90-07 and all XL 883cc
- XL 1200cc models from 91-01 & all Buell models '95-01
- Sold as a kit
- Replaces H-D OEM number HD-38515A

**WPS#**

**57-8137**

**REAR WHEEL ALIGNMENT TOOL FOR H-D®**

- For use on Softail, Sportster, and Dyna
- Designed to help set rear wheel alignment
- Fast, accurate and easy to use
- Eliminates the need to use a tape measure
- Proper wheel alignment extends chain/sprocket and belt life

**WPS#**

**57-8368**



**BELT TENSION GAUGE**

- Compact design
- Scale for easy reference
- Designed to work with all belt drive models with a 10 lb. specification
- Replaces H-D® OEM #40006-85
- L shaped pad fits all belt sizes

**WPS#**

**57-80350**



WINDSHIELDS / FAIRINGS
AUDIO / COMMUNICATION
SEATS / LUGGAGE
BAR / MIRRORS / CONTROLS
EXHAUST
AIR / FUEL SYSTEMS
ENGINE
TRANSMISSION / DRIVELINE
GASKETS / SEALS
ELECTRICAL
LIGHTING
CABLES
BRAKES
OIL FILTERS
SUSPENSION
BODY
WHEELS
TIRES / TIRE ACC.
BIKE ACC.
VICTORY / INDIAN
COVERS / LOCKS / TIEDOWNS
CHEMICALS
<b>TOOLS</b>
HELMETS
HELMET ACC.
EYEWEAR
APPAREL / RIDER ACC.
PROMOTIONAL
REFERENCE
INDEX

WINDSHIELDS / FAIRINGS  
 AUDIO / COMMUNICATION  
 SEATS / LUGGAGE  
 BARS / MIRRORS / CONTROLS  
 EXHAUST  
 AIR / FUEL SYSTEMS  
 ENGINE  
 TRANSMISSION / DRIVELINE  
 GASKETS / SEALS  
 ELECTRICAL  
 LIGHTING  
 CABLES  
 BRAKES  
 OIL FILTERS  
 SUSPENSION  
 BODY  
 WHEELS  
 TIRES / TIRE ACC.  
 BIKE ACC.  
 VICTORY / INDIAN  
 COVERS / LOCKS / TIEDOWNS  
 CHEMICALS  
**TOOLS**  
 HELMETS  
 HELMET ACC.  
 EYEWEAR  
 APPAREL / RIDER ACC.  
 PROMOTIONAL  
 REFERENCE  
 INDEX



### SAW GUIDE

- Ensures a straight, clean cut on handlebars and tubing from 1" to 1 1/4"
- Simply clamp onto the tube and cut, letting the Saw Guide guide the hacksaw blade
- Built with a non-scratching body and heat-treated steel cutting plates to withstand the rigors of daily shop use



WPS#

57-00715



### ROLL-UP POUCH

A very rugged roll-up pouch constructed of Ballistic nylon, with eighteen pockets of varying width at two heights to accommodate a wide range of contents. Two lower pockets have a mesh cover with a Velcro® closure to hold small or loose items in place. A strip of reflective material is sewn into the back in case you're stuck on the road at night. About 9.5" high by 16" wide when open.



WPS#

57-0023



### MAGNETIC PICK UP TOOL NEW

- Billet aluminum laser etched handle
- Bendable housing retains its shape to access hard to reach areas
- Powerful magnet
- Low profile tip fits in tight spaces
- 18 inches long
- Protective rubber coating won't scratch aluminum or plastic surfaces



WPS#

57-8652

### MAGNETIC FINGER GLOVE

- Holds small metal objects
- Great for starting or removing fasteners in hard to reach places
- 2-way stretch spandex
- Leatherette bottom and fingertip
- Stretch finger panels



Description	Sold	WPS#
Magnetic finger glove	ea	57-10016
Magnetic finger glove	6/card	57-10015



## STEPLESS CLAMP KIT

- Convenient kit includes 80 or 85 pcs of hardware and a convenient fuel line clamp size chart
- 80pc kit includes a Motion Pro Side Jaw Pincer tool
- Warning: not for use with fuel injection systems
- Kit includes following items packed in a convenient storage box:

## STEEL O-CLIPS

- Ideally suited for clamping vinyl or Nitrile fuel line to fittings
- One piece construction assures positive clamping action without damage to the hose
- O-Clip pincer tool is made specifically to install and to remove the clips

Description	Quantity	WPS#
Side jaw pincer tool (for use in limited space)	1	<b>57-12073</b>
Standard pincer tool only	1	<b>12-0240</b>
Stepless clamp kit 8-18mm with pincer tool	80 pc	<b>12-0830</b>
Stepless clamp kit 15-47mm w/o tool	85 pc	<b>57-10065</b>
Stepless clamp 7.8-9.5mm	10/pk	<b>57-20074</b>
Stepless clamp 8.8-10.5mm	10/pk	<b>57-20084</b>
Stepless clamp 9.6-11.3mm	10/pk	<b>57-20081</b>
Stepless clamp 10.3-12.8mm	10/pk	<b>57-20075</b>
Stepless clamp 10.8-13.38mm	10/pk	<b>57-20076</b>
Stepless clamp 12-14.5mm	10/pk	<b>57-20077</b>
Stepless clamp 14.8-18.0mm	10pk	<b>57-20078</b>
Stepless clamp 13.2-15.7mm	10/pk	<b>57-20082</b>
Stepless clamp 17-21mm	10/pk	<b>57-10066</b>
Stepless clamp 21-24mm	10/pk	<b>57-10067</b>
Stepless clamp 24-27mm	10/pk	<b>57-10068</b>
Stepless clamp 27-30mm	10/pk	<b>57-10069</b>
Stepless clamp 30-33mm	10/pk	<b>57-10070</b>
Stepless clamp 33-37mm	10/pk	<b>57-10071</b>
Stepless clamp 37-40mm	5/pk	<b>57-10072</b>
Stepless clamp 41-44mm	5/pk	<b>57-10073</b>
Stepless clamp 44-47mm	5/pk	<b>57-10074</b>
5/16 O-Clips for 3/16 hose	10/pk	<b>12-0250</b>
7/16 O-Clips for 1/4 hose	10/pk	<b>12-0260</b>
1/2 O-Clips for 5/16 hose	10/pk	<b>12-0270</b>
9/16 O-Clips for 3/8 hose	10/pk	<b>12-0280</b>

## STAINLESS STEEL HOSE CLAMPS

- Made of corrosion-resistant stainless steel
- Conventional-type worm drive hose clamps
- 1/4" hex head with screwdriver slot
- Sold in packs of 10

Description	Pack	WPS#
For 1/4"- 5/8" hose	10/pk	<b>12-0022</b>
For 7/16"- 25/32" hose	10/pk	<b>12-0023</b>

## FUEL LINE CLAMPING PLIERS

- Clamps fuel and vacuum lines 1/8" to 3/8"
- Specially designed jaws will not damage internal hose lining

**WPS#**  
**57-8025**



- WINDSHIELDS / FAIRINGS
- AUDIO / COMMUNICATION
- SEATS / LUGGAGE
- BAR / MIRRORS / CONTROLS
- EXHAUST
- AIR / FUEL SYSTEMS
- ENGINE
- TRANSMISSION / DRIVELINE
- GASKETS / SEALS
- ELECTRICAL
- LIGHTING
- CABLES
- BRAKES
- OIL FILTERS
- SUSPENSION
- BODY
- WHEELS
- TIRES / TIRE ACC.
- BIKE ACC.
- VICTORY / INDIAN
- COVERS / LOCKS / TIEDOWNS
- CHEMICALS
- TOOLS**
- HELMETS
- HELMET ACC.
- EYEWEAR
- APPAREL / RIDER ACC.
- PROMOTIONAL
- REFERENCE
- INDEX

- WINDSHIELDS / FAIRINGS
- AUDIO / COMMUNICATION
- SEATS / LUGGAGE
- BARS / MIRRORS / CONTROLS
- EXHAUST
- AIR / FUEL SYSTEMS
- ENGINE
- TRANSMISSION / DRIVELINE
- GASKETS / SEALS
- ELECTRICAL
- LIGHTING
- CABLES
- BRAKES
- OIL FILTERS
- SUSPENSION
- BODY
- WHEELS
- TIRES / TIRE ACC.
- BIKE ACC.
- VICTORY / INDIAN
- COVERS / LOCKS / TIEDOWNS
- CHEMICALS
- TOOLS**
- HELMETS
- HELMET ACC.
- EYEWEAR
- APPAREL / RIDER ACC.
- PROMOTIONAL
- REFERENCE
- INDEX



### THREE WAY PLUG WRENCH

Fits all 10mm, 12mm and 14mm spark plugs.

**WPS#**  
**57-6023**



### IGNITION SYSTEM TESTER

- Test the integrity and strength of your ignition system
- Will test the ignition on most motorcycles, ATV and snowmobiles

**WPS#**  
**57-8122**



### ELECTRICAL TESTER

- 6-12 volt continuity tester
- Insulated mini gator clip and a sharp wire piercing point
- Checks low voltage wiring

**WPS#**  
**41-9542**



### HEAT SHRINK TUBING

ID x Length	Sold	Shrink Ratio	WPS#
3/16" x 1 M	Ea	2 : 1	<b>41-95611</b>
3/16" x 100 M	Roll	2 : 1	<b>41-95631</b>
1/4" x 1 M	Ea	2 : 1	<b>41-95613</b>
1/4" x 100 M	Roll	2 : 1	<b>41-95633</b>
1/2" x 1 M	Ea	2 : 1	<b>41-95615</b>
1/2" 100 M	Roll	2 : 1	<b>41-95635</b>
5/8" x 1 M	Ea	2 : 1	<b>41-95617</b>
5/8" x 100 M	Roll	2 : 1	<b>41-95637</b>
<b>ADHESIVE LINED*</b>			
3/16" x 1.2 M	10/pk	3 : 1	<b>41-95651</b>
1/4" x 1.2 M	10/pk	3 : 1	<b>41-95653</b>
1/2" x 1.2 M	10/pk	3 : 1	<b>41-95655</b>
5/8" x 1.2 M	10/pk	3 : 1	<b>41-95657</b>



\*Adhesive lined heat shrink tubing is ideal for producing a strong, weather tight seal. The inner adhesive wall melts and flows, creating an adhesion layer that ensures a snug fit and seal.

## DELUXE TEAR DOWN TABLE



This steel workbench is great for the home or business. The 14 gauge top has a 3/4" rim to contain liquids and capture leaking fluids when working on hydraulic systems and transmissions. Fluids drain into the removable polyethylene drawer for easy dispensing.

The convenient adjustable lower shelf organizes your tool storage. The drawer features a cylinder key locking system with full-extension ball bearing sliders to keep your valuables safe. Tough powder-coat finish resists rust, chips, and scratches. Made in USA.

- Adjustable working height of 37" to 41"
- Heavy duty 4" casters (2 rigid & 2 locking swivel)
- 14 gauge 48" x 28" table top with 3/4" rim
- Removable 20" x 12" x 6" polyethylene drawer
- Adjustable lower shelf
- Heavy duty 24" x 18" x 5-1/2" locked drawer
- Weight 180 lbs

**To order Handy drop-ship items:**

- 1.) Call toll-free order line and request freight quote
- 2.) Form with freight quote will be faxed to dealer
- 3.) Sign freight quote form and return to WPS order will be placed and drop-shipped
- 4.) These items are not included in free freight policy, freight will be added to billing
- 5.) Dealer will be billed when WPS receives mfg's invoice
- 6.) COD dealers must prepay or use credit card before ordered from mfg. Freight will be billed separately
- 7.) These are special order items and cannot be cancelled



**NOT INCLUDED IN OUR FREE FREIGHT PROGRAM**

F.O.B. Iowa factory. Shipped direct.

Description	WPS #
Tear Down Table	27-1150



## PORTABLE WORKBENCH

- Folds for easy transport and storage
- Perfect for races or the garage
- Features a large work surface (91.5cm x 58.5cm) with specialty slots, holes, and recesses to hold tools, lubes, beverages and whatever you can think of
- Folding steel legs provide a solid base for a toolbox and supplies
- Dolly kit converts the work bench into a two wheeled hand truck

Description	WPS#
Portable workbench	57-00731

- WINDSHIELDS / FAIRINGS
- AUDIO / COMMUNICATION
- SEATS / LUGGAGE
- BARS / MIRRORS / CONTROLS
- EXHAUST
- AIR / FUEL SYSTEMS
- ENGINE
- TRANSMISSION / DRIVELINE
- GASKETS / SEALS
- ELECTRICAL
- LIGHTING
- CABLES
- BRAKES
- OIL FILTERS
- SUSPENSION
- BODY
- WHEELS
- TIRES / TIRE ACC.
- BIKE ACC.
- VICTORY / INDIAN
- COVERS / LOCKS / TIEDOWNS
- CHEMICALS
- TOOLS**
- HELMETS
- HELMET ACC.
- EYEWEAR
- APPAREL / RIDER ACC.
- PROMOTIONAL
- REFERENCE
- INDEX



**BAR STOOL**

- Chrome Plated legs
- Oil-resistant vinyl seat
- Ball bearing seat swivel
- Non-slip rubber feet
- 30" overall height

**MECHANIC SHOP STOOLS**

**MECHANICS BAR STOOLS**

- Heavy duty chrome tool tray
- Ball bearing seat swivel
- 4 Ball bearing casters
- Oil-resistant vinyl seat
- Chrome Plated legs



Description	WPS#
FLY Bar Stool	369-9999
FLY Mechanic Stool	369-9998

Description	WPS#
Sedona Mechanic Stool	570-9998
Hard Drive Mechanic Stool	810-9998



**STAINLESS STEEL  
MAGNETIC PARTS DISH**

- New stainless steel design
- All purpose magnetic dish is ideal for keeping track of loose fasteners and other small parts
- Attaches magnetically to any steel surface
- Measures 5 inches in diameter and is 1 inch deep



Description	WPS#
3 inch	57-8504
5 inch	57-8485
9.5 inch	57-8505

WINDSHIELDS / FAIRINGS  
AUDIO / COMMUNICATION  
SEATS / LUGGAGE  
BARS / MIRRORS / CONTROLS  
EXHAUST  
AIR / FUEL SYSTEMS  
ENGINE  
TRANSMISSION / DRIVELINE  
GASKETS / SEALS  
ELECTRICAL  
LIGHTING  
CABLES  
BRAKES  
OIL FILTERS  
SUSPENSION  
BODY  
WHEELS  
TIRES / TIRE ACC.  
BIKE ACC.  
VICTORY / INDIAN  
COVERS / LOCKS / TIEDOWNS  
CHEMICALS  
TOOLS  
HELMETS  
HELMET ACC.  
EYEWEAR  
APPAREL / RIDER ACC.  
PROMOTIONAL  
REFERENCE  
INDEX





## STRIKER GARAGE LIGHT

- Installation is as easy as screwing in a light bulb
- 3000 lumens 3.8 times the brightness of a 60 watt bulb
- Only draws 25 watts of power
- Motion activated



**Description**    **WPS#**  
LED Garage Light    **05-1073**



## FLEXIT LIGHT

- Ultra thin, flexible, bendable and foldable
- Wrap it around, loop it over, set it down or use the magnets to hold it up
- Silicone construction body

**Description**    **WPS#**  
Flexit Light    **05-1072**



## PROFESSIONAL LIGHT MINE

- Hands free light
- 360 degree magnetic mounting
- LED Lumen tech
- Baseball size

**Description**    **WPS#**  
Pro Light Mine    **05-1071**



## MINI LIGHT MINE

- Hands free design
- 360 degree magnetic mounting
- LED Lumen tech
- Golf ball size

**Description**    **WPS#**  
Mini Light Mine    **05-1070**

- WINDSHIELDS / FAIRINGS
- AUDIO / COMMUNICATION
- SEATS / LUGGAGE
- BAR / MIRRORS / CONTROLS
- EXHAUST
- AIR / FUEL SYSTEMS
- ENGINE
- TRANSMISSION / DRIVELINE
- GASKETS / SEALS
- ELECTRICAL
- LIGHTING
- CABLES
- BRAKES
- OIL FILTERS
- SUSPENSION
- BODY
- WHEELS
- TIRES / TIRE ACC.
- BIKE ACC.
- VICTORY / INDIAN
- COVERS / LOCKS / TIEDOWNS
- CHEMICALS
- TOOLS**
- HELMETS
- HELMET ACC.
- EYEWEAR
- APPAREL / RIDER ACC.
- PROMOTIONAL
- REFERENCE
- INDEX

WINDSHIELDS / FAIRINGS  
 AUDIO / COMMUNICATION  
 SEATS / LUGGAGE  
 BARS / MIRRORS / CONTROLS  
 EXHAUST  
 AIR / FUEL SYSTEMS  
 ENGINE  
 TRANSMISSION / DRIVELINE  
 GASKETS / SEALS  
 ELECTRICAL  
 LIGHTING  
 CABLES  
 BRAKES  
 OIL FILTERS  
 SUSPENSION  
 BODY  
 WHEELS  
 TIRES / TIRE ACC.  
 BIKE ACC.  
 VICTORY / INDIAN  
 COVERS / LOCKS / TIEDOWNS  
 CHEMICALS  
**TOOLS**  
 HELMETS  
 HELMET ACC.  
 EYEWEAR  
 APPAREL / RIDER ACC.  
 PROMOTIONAL  
 REFERENCE  
 INDEX



**ASSORTED SIZE CABLE TIES**

Color	WPS#
<b>ASSORTMENT 30 PACK</b>	
Black	14-0301
Yellow	14-0302
Green	14-0303
Blue	14-0304
Red	14-0305
Grey	14-0306
White	14-0307
Purple	14-0308

**30 Pack:**  
 10 ea. 4"  
 10 ea. 6"  
 10 ea. 8"

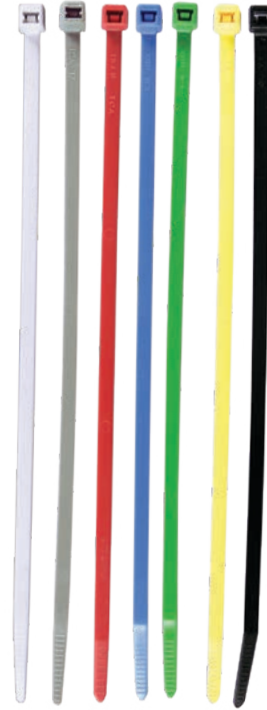

**100 PACK CABLE TIES**

Color	4"	6"	8"
Black	14-0320	14-0321	14-0322
Yellow	14-0323	14-0324	14-0325
Green	14-0326	14-0327	14-0328
Blue	14-0329	14-0330	14-0331
Red	14-0332	14-0333	14-0334
Grey	14-0338	14-0339	14-0340
White	14-0341	14-0342	14-0343
Orange	14-0335	14-0336	14-0337
Purple	14-0344	14-0345	14-0346

**STAINLESS STEEL CABLE TIES**

Description	14"	
5 Pack	14-0315	14-0316
50 Pack	14-0317	14-0318



**HEAVY DUTY REUSABLE CABLE TIES**



Length	WPS#
9"	14-0309
20"	14-0310



**WIRE LOOM**

Description	WPS#
3/8" x 6' Black	27-0172
1/2" x 6' Black	27-0170
3/4" x 6' Black	27-0171



**CABLE TIES**

Secures wires, hoses and other necessary items quickly

Length	Width	WPS#
100/Bag 4"	.100"	12-1141
100/Bag 6"	.140"	12-1136
100/Bag 7"	.187"	12-1142
100/Bag 8"	.300"	12-1143
100/Bag 11"	.187"	12-1144
100/Bag 14"	.300"	12-1139





## INSULATED TERMINAL ASSORTMENT

Contains the most popular types of insulated terminals. Approximately 175 pieces. Packaged in a clear plastic organizer box.

WPS #  
**41-9540**



## QUICK SPLICE

Quick splice wire connector. No stripping required for tap splice, in-line splice or pigtail splice. For use with 14-16-18 gauge wire. Packaged 100 per bag.

WPS#  
**41-9521**

## MULTI-COMPARTMENT ORGANIZERS

- Organize small electrical and carburetor parts inventories
- Makes picking and reordering parts quick and easy
- Keeps parts separated, clean and dust free

	Description	Measurements	WPS#
A	Stowaway organizer 4 Drawer unit (uses 41-9516 as drawers)	(uses 41-9516 as drawers)	<b>41-9518</b>
B	6 Compartment	8-1/4" x 4-1/4" x 1-3/8"	<b>41-9517</b>
C	6 to 18 Compartment	11" x 7-1/4" x 1-3/8"	<b>41-9515</b>
D	4 to 24 Compartment	13-3/4" x 9-1/8" x 2"	<b>41-9516</b>

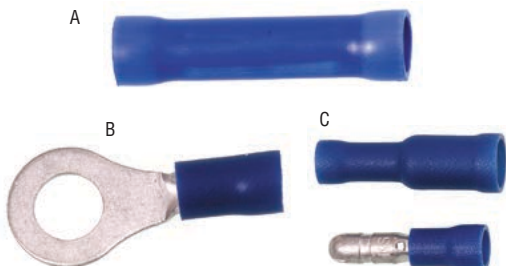
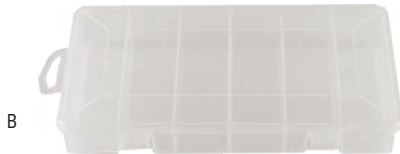

## VINYL INSULATED ELECTRICAL CONNECTIONS

	Description	Size	Color	WPS#
A	Butt connector	22-16 AWG	Red	<b>41-9522</b>
B	Butt connector	16-14 AWG	Blue	<b>41-9523</b>
C	Ring	16-14 AWG	Blue	<b>41-9528</b>
D	Bullet receptacles and adapters	16-14 AWG	Blue	<b>41-9520</b>

# PLANO

- WINDSHIELDS / FAIRINGS
- AUDIO / COMMUNICATION
- SEATS / LUGGAGE
- BAR / MIRRORS / CONTROLS
- EXHAUST
- AIR / FUEL SYSTEMS
- ENGINE
- TRANSMISSION / DRIVELINE
- GASKETS / SEALS
- ELECTRICAL
- LIGHTING
- CABLES
- BRAKES
- OIL FILTERS
- SUSPENSION
- BODY
- WHEELS
- TIRES / TIRE ACC.
- BIKE ACC.
- VICTORY / INDIAN
- COVERS / LOCKS / TIEDOWNS
- CHEMICALS
- TOOLS**
- HELMETS
- HELMET ACC.
- EYEWEAR
- APPAREL / RIDER ACC.
- PROMOTIONAL
- REFERENCE
- INDEX



## ALUMINUM HEAT FOIL TAPE

- High performance acrylic adhesive system
- 3.25 mil thickness with removable paper liner
- -35°F to 300°F temperature range
- Conforms easily to irregular surfaces



Size	WPS#
3" wide x 25'	10-2390
3" wide x 150'	10-2391

## WIRE HARNESS HEAT WRAP

- Easy tear fiberglass cloth has high tensile strength and abrasion resistance
- High temperature up to 250°F (300°F intermittent)
- Flame retardant
- Self extinguishing



Size	WPS#
3/4" wide x 100'	10-2395



## ELECTRICAL TAPE

Top quality PVC electrical tape. UL listed with CSA standards. 3/4" wide x 60' rolls, 10 rolls per package.



Description	WPS#
Sold 10pk	10-2262

## ALUMINUM AND STEEL POP RIVETS

Sold 100 per box

Rivet Diameter	Head Diameter	Grip Range	Aluminum	Steel
			WPS #	WPS #
3/32"	3/16"	1/8" - 1/4"	33-1054	
1/8"	1/4"	3/16" - 1/4"	33-1062	33-1012
1/8"	1/4"	5/16" - 3/8"	33-1063	33-1013
3/16"	3/8"	1/8" - 1/4"	33-1072	33-1006
3/16"	3/8"	1/4" - 3/8"	33-1073	33-1011
3/16"	3/8"	3/8" - 1/2"	33-1074	33-1024
3/16"	3/8"	1/2" - 5/8"	33-1075	33-1025
3/16"	3/8"	5/8" - 3/4"	33-1076	33-1026
3/16"	5/8"	1/4" - 3/8"	33-1083	33-1004
3/16"	5/8"	3/8" - 1/2"	33-1084	33-1007
3/16"	5/8"	1/2" - 5/8"	33-1085	33-1035
3/16"	5/8"	5/8" - 3/4"	33-1086	33-1008

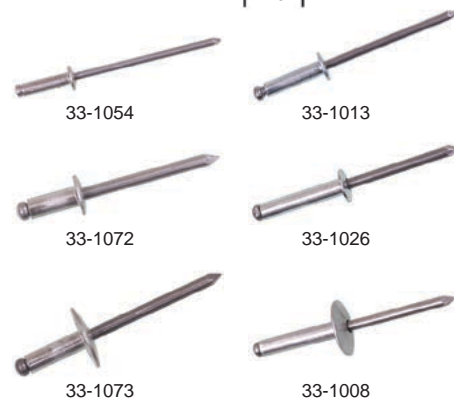

## STEEL BACK-UP WASHERS FOR POP RIVETS

Sold 500 per box

Hole Dia.	Washer Dia.	WPS#
1/8"	3/8"	33-1057
3/16"	1/2"	33-1058





Color	90' Roll	180' Roll
Black	<b>10-2300BK</b>	<b>10-2301BK</b>
Blue	<b>10-2300BL</b>	<b>10-2301BL</b>
Chrome	<b>10-2300C</b>	
Green	<b>10-2300GN</b>	
Orange	<b>10-2300OR</b>	
Red	<b>10-2300R</b>	<b>10-2301R</b>
Silver	<b>10-2300S</b>	<b>10-2301S</b>
White	<b>10-2300W</b>	
Yellow	<b>10-2300Y</b>	

**RACERS TAPE**

- The original multi-purpose poly coated cotton industrial grade duct tape
- Provides air tight seals
- Easy to unwind
- High bonding strength
- Tears straight and easy

**BLACK AND WHITE CHECKERBOARD TAPE**

- Mylar laminated decorative vinyl tape with a release liner
- Available in straight and angled checker designs



Description	WPS#
2" x 45' straight	<b>10-2315</b>

**BLACK REFLECTIVE TAPE**

- Bright white reflection at night
- Blends in with black during the day
- Adds safety while maintaining good looks
- Includes 1 roll each 1/2" x 24" and 1" x 24" w



Description	WPS#
1/2" x 24"/1" x 24"	<b>10-2321</b>

**NON-SKID TAPE**

- Self adhesive tape helps prevent slips and falls
- Great for steps, ramps, running boards and more
- Rubberized version works great for dirt bike applications - will not tear up clothing and boots

Description	WPS#
2" x 10' original Black	<b>10-2310</b>
4" x 10' original Black	<b>10-2311</b>
2" x 7.5' rubberized Clear	<b>10-2312</b>
2" x 7.5' rubberized Black	<b>10-2312BK</b>
4" x 7.5' rubberized Clear	<b>10-2313</b>
4" x 7.5' rubberized Black	<b>10-2313BK</b>



Rubberized Clear

Original Black



**SURFACE GUARD TAPE**

- Clear protective 8 mil thick urethane tape with a release liner
- Protects surfaces prone to scratching, chipping, and weathering
- Great for fenders, hoods, tailgates, frames, and most any other surface
- Attractively packaged for retail sale



Description	WPS#
2" x 10'	<b>10-2330</b>
4" x 10'	<b>10-2331</b>

**BARRICADE TAPE**

- Non-adhesive checkerboard design is great for marking off pit areas
- No more trash cans or folding chairs to save your spot



Description	WPS#
3" x 1000'	<b>10-2320</b>

WINDSHIELDS / FAIRINGS  
 AUDIO / COMMUNICATION  
 SEATS / LUGGAGE  
 BARS / MIRRORS / CONTROLS  
 EXHAUST  
 AIR / FUEL SYSTEMS  
 ENGINE  
 TRANSMISSION / DRIVELINE  
 GASKETS / SEALS  
 ELECTRICAL  
 LIGHTING  
 CABLES  
 BRAKES  
 OIL FILTERS  
 SUSPENSION  
 BODY  
 WHEELS  
 TIRES / TIRE ACC.  
 BIKE ACC.  
 VICTORY / INDIAN  
 COVERS / LOCKS / TIEDOWNS  
 CHEMICALS  
**TOOLS**  
 HELMETS  
 HELMET ACC.  
 EYEWEAR  
 APPAREL / RIDER ACC.  
 PROMOTIONAL  
 REFERENCE  
 INDEX



## X-TREME TAPE

Bluhm Enterprises has another great motor sports accessory (tool). This product was researched and is made for NASA. It is now perfected as a great emergency repair option. Each roll of X-treme tape is a high strength polymer plastic that fuses to itself-NO adhesive, so it is not sensitive to cold, heat, or rain. This is NOT electrical tape!

- 10 foot roll, has 3:1 stretch ratio
- 1" wide 20 mil thick
- Withstands heat up to 500°F(260°C)
- Flexible down to -60°F(-54°C)
- Tensile strength of 600psi
- Insulates up to 400 Volts/Mil
- MADE IN USA!!!



Sold	WPS#
Each	10-2336
Counter top display-18/pk	10-2338



## MECHANIX APRON

- Specially designed for the professional mechanic!
- Offers greater convenience and added protection
- Wrap around design protects clothes better
- Made from 1000 Denier Belcor fabric
- Genuine Velcro® pocket closures and adjustable 1-inch wide neck plus waist straps with buckles
- Machine washable



Color	WPS#
Black	26-9131

- WINDSHIELDS / FAIRINGS
- AUDIO / COMMUNICATION
- SEATS / LUGGAGE
- BAR / MIRRORS / CONTROLS
- EXHAUST
- AIR / FUEL SYSTEMS
- ENGINE
- TRANSMISSION / DRIVELINE
- GASKETS / SEALS
- ELECTRICAL
- LIGHTING
- CABLES
- BRAKES
- OIL FILTERS
- SUSPENSION
- BODY
- WHEELS
- TIRES / TIRE ACC.
- BIKE ACC.
- VICTORY / INDIAN
- COVERS / LOCKS / TIEDOWNS
- CHEMICALS
- TOOLS**
- HELMETS
- HELMET ACC.
- EYEWEAR
- APPAREL / RIDER ACC.
- PROMOTIONAL
- REFERENCE
- INDEX

# HEAT SLEEVE



- Comfortable work sleeve designed for working in uncomfortable areas!
- Heat-resistant and fire-retardant
- 100% woven Kevlar treated with fiber shield to repel fluids such as oil, fuel and water
- 17" long with thumb cut

Color	WPS#
Black	26-9136

# ORIGINAL H.D. POWDER FREE LATEX GLOVE



- Recommended for jobs involving the harshest fluids and chemicals
- Fully textured finish provides excellent grip when handling wet tools and equipment
- Polymer coating on the surface keeps hands comfortable and cool during extended use
- Powder free minimizes the risk of developing latex protein residue related allergies
- 12" cuff length protects wrists and forearms when working in solvent tanks
- Thickness 12 mil. (fingers) 14 mil. (palm) for maximum chemical resistance

50  
Gloves per  
container



Size	WPS#
L	57-1037
X	57-1038

# NITRILE TEXTURED POWDER FREE GLOVE



- Superior puncture, tear and chemical resistance with excellent dexterity
- 100% latex free eliminates potential allergic reactions to latex proteins
- Textured surface provides strong grip for both wet and dry applications
- Thickness...5 mil. (fingers) 5 mil. (palm)

100  
gloves per  
container

Size	WPS#
M	57-1034
L	57-1035
X	57-1036

# GLOVE LINERS



- Insulate hands from vibration
- Prevents blisters and reduces fatigue
- One size larger glove is recommended

Description	M	L	X
Qualifier (fingertipless)	27-1385M	27-1385L	27-1385X
Original (lightweight)	27-1386M	27-1386L	27-1386X
Ultra (waterproof)	27-1387M	27-1387L	27-1387X



Qualifier

Original

Ultra

# METALLIC



- 40% polyester, 20% nylon, 10% cotton, 30% polyester metallic film
- Cuff is 100% cotton
- Durable, yet light weight
- Moisture absorbent and heat reflective



Size	WPS#
Ladies	27-1382
Mens	27-1384

- WINDSHIELDS / FAIRINGS
- AUDIO / COMMUNICATION
- SEATS / LUGGAGE
- BARS / MIRRORS / CONTROLS
- EXHAUST
- AIR / FUEL SYSTEMS
- ENGINE
- TRANSMISSION / DRIVELINE
- GASKETS / SEALS
- ELECTRICAL
- LIGHTING
- CABLES
- BRAKES
- OIL FILTERS
- SUSPENSION
- BODY
- WHEELS
- TIRES / TIRE ACC.
- BIKE ACC.
- VICTORY / INDIAN
- COVERS / LOCKS / TIEDOWNS
- CHEMICALS
- TOOLS
- HELMETS
- HELMET ACC.
- EYEWEAR
- APPAREL / RIDER ACC.
- PROMOTIONAL
- REFERENCE
- INDEX



## ORIGINAL HIGH ABRASION GLOVES

Improved Design. When you need sturdy, you need our redesigned Original Plus Glove. We started by improving traction with a raised pattern to maximize the thumb and finger grip. From there we added a two-way, form-fitting Spandex back and stretch insert panels between the fingers for comfort, and an index finger knuckle reinforcement band for protection. Finally we integrated an improved cuff and thumb fit to provide for easy entry and increased flexibility.



Color	S	M	L	X	XX
Black	26-9134S	26-9134M	26-9134L	26-9134X	26-9134XX

## FAST FIT GLOVE

- Soft, durable, flexible and breathable Clarino™ palm
- Padded two-way stretch spandex top for flexibility and fit
- Easy entry, wide opening elastic cuff with rubber pull tab



Color	S	M	L	X	2X
Black	26-9305S	26-9305M	26-9305L	26-9305X	26-9305XX

## COLD WEATHER GLOVE

- Taslan nylon outer shell shields against wind
- Neoprene knuckle and thumb panels for flexibility and warmth
- Narrower elastic cuff for added comfort
- 3M® C-40 Thinsulate® interior lining is bonded to padded two-way stretch spandex top



Color	S	M	L	X	2X
Black/Grey	26-9135S	26-9135M	26-9135L	26-9135X	26-9135XX

- WINDSHIELDS / FAIRINGS
- AUDIO / COMMUNICATION
- SEATS / LUGGAGE
- BAR / MIRRORS / CONTROLS
- EXHAUST
- AIR / FUEL SYSTEMS
- ENGINE
- TRANSMISSION / DRIVELINE
- GASKETS / SEALS
- ELECTRICAL
- LIGHTING
- CABLES
- BRAKES
- OIL FILTERS
- SUSPENSION
- BODY
- WHEELS
- TIRES / TIRE ACC.
- BIKE ACC.
- VICTORY / INDIAN
- COVERS / LOCKS / TIEDOWNS
- CHEMICALS
- TOOLS**
- HELMETS
- HELMET ACC.
- EYEWEAR
- APPAREL / RIDER ACC.
- PROMOTIONAL
- REFERENCE
- INDEX





### MECHANIX GLOVES

- Protects hands from heat and cold while providing increased grip and finger sensitivity
- Heat-resistant Clarino™ palm and index finger
- Padded 3-ply mesh top, wide elastic wrist band
- Anatomical ¾ closed design
- 0.5 glove has thinner .5mm Clarino™ in palm and fingers for better feel and dexterity
- 0.5 glove is specially treated with a rubber coating to improve strength and grip
- Original Grip glove features a PVC coated palm with new chevron pattern for maximum grip and high dexterity fingertips and 2-ply thumb reduce wear and increase protection



Color	XS	S	M	L	X	2X
A Black	26-9120XS	26-9120S	26-9120M	26-9120L	26-9120X	26-9120XX
B Blue		26-9122S	26-9122M	26-9122L	26-9122X	26-9122XX
C Yellow		26-9123S	26-9123M	26-9123L	26-9123X	26-9123XX
D Red		26-9124S	26-9124M	26-9124L	26-9124X	26-9124XX
E Camo		26-9129S	26-9129M	26-9129L	26-9129X	26-9129XX
F Original Grip		26-9125S	26-9125M	26-9125L	26-9125X	26-9125XX

- WINDSHIELDS / FAIRINGS
- AUDIO / COMMUNICATION
- SEATS / LUGGAGE
- BAR / MIRRORS / CONTROLS
- EXHAUST
- AIR / FUEL SYSTEMS
- ENGINE
- TRANSMISSION / DRIVELINE
- GASKETS / SEALS
- ELECTRICAL
- LIGHTING
- CABLES
- BRAKES
- OIL FILTERS
- SUSPENSION
- BODY
- WHEELS
- TIRES / TIRE ACC.
- BIKE ACC.
- VICTORY / INDIAN
- COVERS / LOCKS / TIEDOWNS
- CHEMICALS
- TOOLS**
- HELMETS
- HELMET ACC.
- EYEWEAR
- APPAREL / RIDER ACC.
- PROMOTIONAL
- REFERENCE
- INDEX



## STANDARD 1200 AIR LIFT

- Revolutionary air bellow design requires no maintenance
- Includes 30" ramp
- 1200 lb. capacity
- 80" long, 24" wide
- Height adjustable from 8" to 39"
- 90-100 psi air source required
- Weighs 322 lbs.

Description	WPS#
<b>LIFTS</b>	
Standard 1200 Black	27-1140BK
Standard 1200 Blue	27-1140BU
Standard 1200 Grey	27-1140G
Standard 1200 Orange	27-1140O
Standard 1200 Red	27-1140R
<b>OPTIONS</b>	
12" Side panels, black	27-1132BK
Snowmobile 10" wings, (pair)	27-1109
Cycle vise	27-1163BK
Scissor lift	27-1137
Tool tray	27-1178
Lift dolly, black	27-1101BK



## AIR AND ELECTRIC LIFTS

### STANDARD LIFT SPECIFICATIONS

HEIGHT	down	7"
	raised	31"
LENGTH	table	80"
	ramp	20"
WIDTH	table	24"
	w/panels	40"
WEIGHT	lift only	304 lbs.
	side panel	105 lbs.
	cycle-vise	36 lbs.
		1000 lbs.
CAPACITY		



Cycle Vise

Description	WPS#
<b>LIFTS</b>	
Electric Lift, Grey	27-1115
Electric Lift, Red	27-1115R
<b>OPTIONS</b>	
Scissor Lift	27-1137
Cycle Vise	27-1163BK
Snowmobile 10" wings, (pair)	27-1109
Tool Tray	27-1178
Piston Seal	27-1111
Lift Dolly, Blk	27-1101BK
12" Panels, Blk (pair) for snowmobiles and extra wide ATVs	27-1132BK

Description	WPS#
<b>REPLACEMENT PARTS</b>	
Wheel Retaining Ring	27-1102
Cast Wheel	27-1103
Cam Roller Bearing	27-1104
Track Roller Bearing	27-1107
Ramp	27-1108
Piston Seal Kit	27-1111
Foot Valve Assembly (Complete)	27-1116
Foot Valve Rebuild Assembly	27-1117
Detent End Clip	27-1118



Lift Dolly

### WHEN ORDERING



F.O.B. Iowa factory. Shipped direct.

**DROP SHIPMENTS ARE NOT INCLUDED IN OUR FREE FREIGHT PROGRAM**

### To order Handy drop-ship items:

- 1.) Call toll-free order line and request freight quote
- 2.) Form with freight quote will be faxed to dealer
- 3.) Sign freight quote form and return to WPS order will be placed and drop-shipped
- 4.) These items are not included in free freight policy, freight will be added to billing
- 5.) Dealer will be billed when WPS receives mfg's invoice
- 6.) COD dealers must prepay or use credit card before ordered from mfg. Freight will be billed separately
- 7.) These are special order items and cannot be cancelled

## S.A.M. 1200 AIR LIFT



- Revolutionary air bellow design requires no maintenance
- Features a drop out panel for easy tire changes
- Includes 30" ramp
- 1200 lb. capacity
- 7' long, 24" wide
- Height adjustable from 8" to 39"
- 90-100 psi air source required
- Weighs 322 lbs.

Description	WPS#
<b>LIFTS</b>	
S.A.M. 1200 Black	<b>27-1141BK</b>
S.A.M. 1200 Blue	<b>27-1141BU</b>
S.A.M. 1200 Grey	<b>27-1141G</b>
S.A.M. 1200 Orange	<b>27-1141O</b>
S.A.M. 1200 Red	<b>27-1141R</b>
<b>OPTIONS</b>	
12" Side panels, black	<b>27-1167BK</b>
13" Front extension, black	<b>27-1166BK</b>
Cycle vise, black	<b>27-1163BK</b>
Tool tray	<b>27-1178</b>



Shown with optional cycle vise

## S.A.M. 2 AIR LIFT

- Longer and wider than other lifts with double drop-down panel design
- 1000 lb. capacity
- 93" long by 28" wide
- Height adjustable from 7.5" to 35"
- 90-120 psi air source required
- Weighs 345 lbs
- Includes 40" long by 28" long ramp, great for lowered bikes

Description	WPS#
<b>LIFTS</b>	
S.A.M. 2 Lift	<b>27-1157</b>
S.A.M. 2 Lift, Blue	<b>27-1157BU</b>
S.A.M. 2 Lift, Orange	<b>27-1157O</b>
S.A.M. 2 Lift, Red	<b>27-1157R</b>
<b>OPTIONS</b>	
10" Side Extensions	<b>27-1158</b>
Cycle Vise, Blk	<b>27-1163BK</b>

**WHEN ORDERING**



F.O.B. Iowa factory. Shipped direct.

**DROP SHIPMENTS ARE NOT INCLUDED IN OUR FREE FREIGHT PROGRAM**

**To order Handy drop-ship items:**

- 1.) Call toll-free order line and request freight quote
- 2.) Form with freight quote will be faxed to dealer
- 3.) Sign freight quote form and return to WPS order will be placed and drop-shipped

- 4.) These items are not included in free freight policy, freight will be added to billing
- 5.) Dealer will be billed when WPS receives mfg's invoice
- 6.) COD dealers must prepay or use credit card before ordered from mfg. Freight will be billed separately
- 7.) These are special order items and cannot be cancelled

- WINDSHIELDS / FAIRINGS
- AUDIO / COMMUNICATION
- SEATS / LUGGAGE
- BAR / MIRRORS / CONTROLS
- EXHAUST
- AIR / FUEL SYSTEMS
- ENGINE
- TRANSMISSION / DRIVELINE
- GASKETS / SEALS
- ELECTRICAL
- LIGHTING
- CABLES
- BRAKES
- OIL FILTERS
- SUSPENSION
- BODY
- WHEELS
- TIRES / TIRE ACC.
- BIKE ACC.
- VICTORY / INDIAN
- COVERS / LOCKS / TIEDOWNS
- CHEMICALS
- TOOLS
- HELMETS
- HELMET ACC.
- EYEWEAR
- APPAREL / RIDER ACC.
- PROMOTIONAL
- REFERENCE
- INDEX

- WINDSHIELDS / FAIRINGS
- AUDIO / COMMUNICATION
- SEATS / LUGGAGE
- BARS / MIRRORS / CONTROLS
- EXHAUST
- AIR / FUEL SYSTEMS
- ENGINE
- TRANSMISSION / DRIVELINE
- GASKETS / SEALS
- ELECTRICAL
- LIGHTING
- CABLES
- BRAKES
- OIL FILTERS
- SUSPENSION
- BODY
- WHEELS
- TIRES / TIRE ACC.
- BIKE ACC.
- VICTORY / INDIAN
- COVERS / LOCKS / TIEDOWNS
- CHEMICALS
- TOOLS**
- HELMETS
- HELMET ACC.
- EYEWEAR
- APPAREL / RIDER ACC.
- PROMOTIONAL
- REFERENCE
- INDEX



## B.O.B. 1500 AIR LIFT



Shown with optional cycle vise

### B.O.B. LIFT SPECIFICATIONS

HEIGHT	down	10"
	raised	40"
LENGTH	table	84"
	ramp	31"
WIDTH	table	28"
	w/panels	40"
WEIGHT	lift only	495 lbs

Description	WPS#
<b>LIFTS</b>	
B.O.B Lift, Grey	27-1161
B.O.B Lift, Orange	27-11610
B.O.B Lift, Red	27-1161R
<b>OPTIONS</b>	
12" Side Panels, Blk	27-1162BK
13" Front Extension, Blk	27-1164BK
Trike Extension	27-1168
Cycle Vise, Blk	27-1163BK
Tool Tray	27-1178

Trike extension kit



The B.O.B. 1500 Air Lift is Handy Industries' newest addition to its line-up of lift products for the powersports market. Handy's B.O.B. 1500 is packed with features: 1,500 lbs. lifting capacity, 40" maximum height, work surface of 84" x 28" (16 sq. ft.!) and a drop out for the tire changers.



F.O.B. Iowa factory. Shipped direct.

**DROP SHIPMENTS ARE NOT INCLUDED IN OUR FREE FREIGHT PROGRAM**

### To order Handy drop-ship items:

- 1.) Call toll-free order line and request freight quote
- 2.) Form with freight quote will be faxed to dealer
- 3.) Sign freight quote form and return to WPS order will be placed and drop-shipped
- 4.) These items are not included in free freight policy, freight will be added to billing
- 5.) Dealer will be billed when WPS receives mfg's invoice
- 6.) COD dealers must prepay or use credit card before ordered from mfg. Freight will be billed separately
- 7.) These are special order items and cannot be cancelled



### MC615R AIR LIFT



Description	WPS#
Black	135-6254
Blue	135-6292
Red	135-6294

[see page](#) for optional accessories.

shipped direct from & warehouse in California.



### MC625R AIR LIFT



One year warranty

Description	WPS#
Black	135-6368
Black/orange	135-6616
Blue	135-6350
Red	135-6355

[see page](#) for optional accessories.

shipped direct from & warehouse in California.



- WINDSHIELDS / FAIRINGS
- AUDIO / COMMUNICATION
- SEATS / LUGGAGE
- BAR / MIRRORS / CONTROLS
- EXHAUST
- AIR / FUEL SYSTEMS
- ENGINE
- TRANSMISSION / DRIVELINE
- GASKETS / SEALS
- ELECTRICAL
- LIGHTING
- CABLES
- BRAKES
- OIL FILTERS
- SUSPENSION
- BODY
- WHEELS
- TIRES / TIRE ACC.
- BIKE ACC.
- VICTORY / INDIAN
- COVERS / LOCKS / TIEDOWNS
- CHEMICALS
- TOOLS**
- HELMETS
- HELMET ACC.
- EYEWEAR
- APPAREL / RIDER ACC.
- PROMOTIONAL
- REFERENCE
- INDEX



**MC500 HYDRAULIC LIFT**



Description	WPS #
Blue	135-4500
Red	135-4502



See page \_\_\_\_\_ for optional accessories.  
 Shipped direct from \_\_\_\_\_ & warehouse in California.

**MC655R HYDRAULIC LIFT**

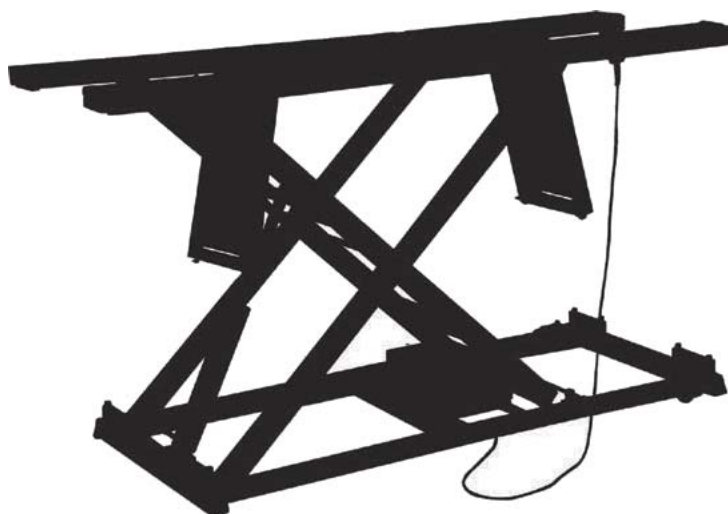

Description	WPS #
Black	135-6629
Black/Orange	135-6617
Blue	135-6568
Red	135-6564

See page \_\_\_\_\_ for optional accessories.  
 Shipped direct from \_\_\_\_\_ & warehouse in California.

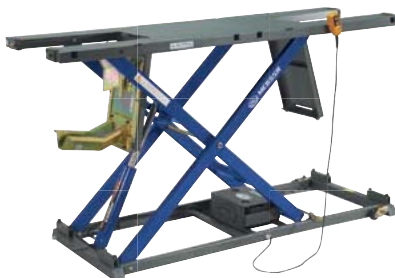

- WINDSHIELDS / FAIRINGS
- AUDIO / COMMUNICATION
- SEATS / LUGGAGE
- BARS / MIRRORS / CONTROLS
- EXHAUST
- AIR / FUEL SYSTEMS
- ENGINE
- TRANSMISSION / DRIVELINE
- GASKETS / SEALS
- ELECTRICAL
- LIGHTING
- CABLES
- BRAKES
- OIL FILTERS
- SUSPENSION
- BODY
- WHEELS
- TIRES / TIRE ACC.
- BIKE ACC.
- VICTORY / INDIAN
- COVERS / LOCKS / TIEDOWNS
- CHEMICALS
- TOOLS**
- HELMETS
- HELMET ACC.
- EYEWEAR
- APPAREL / RIDER ACC.
- PROMOTIONAL
- REFERENCE
- INDEX



LIFT ACCESSORIES



A



B

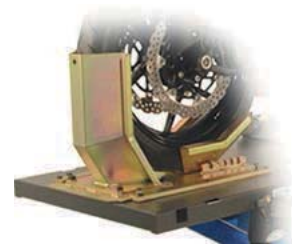

C



D



F



G

Description	MC655R	MC650R	MC625R	MC615R	MC600	MC500R	WPS#
<b>WHEEL VISES/CLAMPS</b>							
MC17 Cycle vise, gray	*	*	*	*	*	*	<b>137-9800</b>
A MC17 Cycle vise, black	*	*	*	*	*	*	<b>137-9801</b>
B Crank style wheel vise	*	*	*	*	*	*	<b>135-9926</b>
C MC10R Deluxe self-locking wheel clamp, includes std. width rocker (for 120mm - 160mm wide tires)	*	*	*	*	*	*	<b>135-4040</b>
Optional narrow rocker kit for MC10R wheel clamp (for 90mm - 110mm wide tires)	*	*	*	*	*	*	<b>135-4041</b>
D Wheel stop	*	*	*	*	*	*	<b>135-6567</b>
<b>SIDE PANELS</b>							
Side panel set, MC500R/MC615R, increases width from 24" to 48", gray				*		*	<b>135-6295</b>
Side panel set, MC500R/MC615R, increases width from 24" to 48", black				*		*	<b>135-6255</b>
Side panel set, MC625R/MC650R/MC655R, increases width to 56.5", includes side panels and std. ramps, gray	*	*	*				<b>135-6552</b>
Side panel set, MC625R/MC650R/MC655R, increases width to 56.5", includes side panels and std. ramps, black	*	*	*				<b>135-6369</b>
Side panel set, MC625R/MC650R/MC655R, increases width to 56.5", includes side panels and long ramps	*	*	*				<b>135-6552L</b>
Wide side panel set, MC625R/MC650R/MC655R, increases width to 69", includes side panels and long ramps, gray	*	*	*				<b>135-6552W</b>
Wide side panel set, MC625R/MC650R/MC655R, increases width to 69", includes side panels and long ramps, black	*	*	*				<b>135-6369W</b>
Trike side panel set, MC625R/MC650R/MC655R, increases width to 56.5", includes side panels and ramps	*	*	*				<b>135-6552T</b>
Trike wide side panel set, MC625R/MC650R/MC655R, increases width to 69", includes side panels and ramps	*	*	*				<b>135-6552TW</b>
Extended ramp, for bikes with low ground clearance - 15" W x 45 3/8" L	*	*	*	*	*	*	<b>135-0306</b>
<b>LIFT EXTENSIONS</b>							
Lift extension kit, adds 30" to the lift	*	*	*	*		*	<b>135-0318</b>
Lift extension kit (front or rear), adds 24" to the deck, 24" x 29.5", grey	*	*					<b>135-6557</b>
Lift extension kit (front or rear), adds 24" to the deck, 24" x 29.5", black	*	*					<b>135-6374</b>
<b>MISCELLANEOUS</b>							
E Nose wheel kit	*	*	*	*		*	<b>135-6770</b>
F Retractable wheels	*	*	*	*		*	<b>135-0321</b>
G CE Approved pedal assembly			*	*			<b>135-6370</b>
Replacement air cylinder seal set MC615R				*			<b>135-7778</b>
Replacement air cylinder seal set MC625R			*				<b>135-7779</b>
* = Fits							

WINDSHIELDS / FAIRINGS  
 AUDIO / COMMUNICATION  
 SEATS / LUGGAGE  
 BARS / MIRRORS / CONTROLS  
 EXHAUST  
 AIR / FUEL SYSTEMS  
 ENGINE  
 TRANSMISSION / DRIVELINE  
 GASKETS / SEALS  
 ELECTRICAL  
 LIGHTING  
 CABLES  
 BRAKES  
 OIL FILTERS  
 SUSPENSION  
 BODY  
 WHEELS  
 TIRES / TIRE ACC.  
 BIKE ACC.  
 VICTORY / INDIAN  
 COVERS / LOCKS / TIEDOWNS  
 CHEMICALS  
 TOOLS  
 HELMETS  
 HELMET ACC.  
 EYEWEAR  
 APPAREL / RIDER ACC.  
 PROMOTIONAL  
 REFERENCE  
 INDEX



**MC450 CENTER JACK**



Description	WPS #
MC450 Center Jack	237-9841

**MC455 FATJACK & MC464 FATJACK DOLLY**



Description	WPS #
MC455 Fat Jack	237-8660
MC464 Fat Jack Dolly	237-9694



- WINDSHIELDS / FAIRINGS
- AUDIO / COMMUNICATION
- SEATS / LUGGAGE
- BAR / MIRRORS / CONTROLS
- EXHAUST
- AIR / FUEL SYSTEMS
- ENGINE
- TRANSMISSION / DRIVELINE
- GASKETS / SEALS
- ELECTRICAL
- LIGHTING
- CABLES
- BRAKES
- OIL FILTERS
- SUSPENSION
- BODY
- WHEELS
- TIRES / TIRE ACC.
- BIKE ACC.
- VICTORY / INDIAN
- COVERS / LOCKS / TIEDOWNS
- CHEMICALS
- TOOLS**
- HELMETS
- HELMET ACC.
- EYEWEAR
- APPAREL / RIDER ACC.
- PROMOTIONAL
- REFERENCE
- INDEX





## MC460 SHOP DOLLY

The MC460 Shop Dolly allows bikes to be easily moved around the shop. The MC460 works with the MC 450 & MC455 center jacks and the MC550 MultiLift.

Description	WPS #
MC460 Shop Dolly	235-9872

**Features include:**

- Adjustable width from 13" to 20" at base
- 12" to 15" Adjustable height
- Four tie down attachment loops
- Swivel neoprene wheels
- Rubber pads on frame rails
- Maximum Weight: 1200 lbs.



- WINDSHIELDS / FAIRINGS
- AUDIO / COMMUNICATION
- SEATS / LUGGAGE
- BAR / MIRRORS / CONTROLS
- EXHAUST
- AIR / FUEL SYSTEMS
- ENGINE
- TRANSMISSION / DRIVELINE
- GASKETS / SEALS
- ELECTRICAL
- LIGHTING
- CABLES
- BRAKES
- OIL FILTERS
- SUSPENSION
- BODY
- WHEELS
- TIRES / TIRE ACC.
- BIKE ACC.
- VICTORY / INDIAN
- COVERS / LOCKS / TIEDOWNS
- CHEMICALS
- TOOLS**
- HELMETS
- HELMET ACC.
- EYEWEAR
- APPAREL / RIDER ACC.
- PROMOTIONAL
- REFERENCE
- INDEX

# CLYMER®

## SHOP MANUALS

- Much cheaper than OEM manuals
- Written in an easy to understand format

Application	Year	WPS#
<b>HARLEY-DAVIDSON</b>		
<b>TWIN CAM MODELS</b>		
Touring	'10-13	<b>27-M253</b>
	'06-09	<b>27-M252</b>
	'99-05	<b>27-M430</b>
Softail	'11-16	<b>27-M251</b>
	'06-10	<b>27-M250</b>
	'00-05	<b>27-M423</b>
Dyna	'12-17	<b>27-M255</b>
	'06-11	<b>27-M254</b>
	'99-05	<b>27-M425</b>
<b>EVO BIG TWIN MODELS</b>		
Touring and FXR	'84-98	<b>27-M422</b>
Softail	'84-99	<b>27-M421</b>
Dyna	'91-98	<b>27-M424</b>
<b>EVO SPORTSTER MODELS</b>		
Sportster	'14-17	<b>27-M256</b>
	'04-13	<b>27-M427</b>
	'86-03	<b>27-M429-5</b>
<b>IRONHEAD MODELS</b>		
Sportster	'59-85	<b>27-M419</b>
<b>SHOVELHEAD MODELS</b>		
Shovelhead	'66-84	<b>27-M420</b>
<b>PANHEAD MODELS</b>		
Panhead	'48-65	<b>27-M418</b>
<b>VRSC MODELS</b>		
V-Rod	'02-14	<b>27-M426</b>

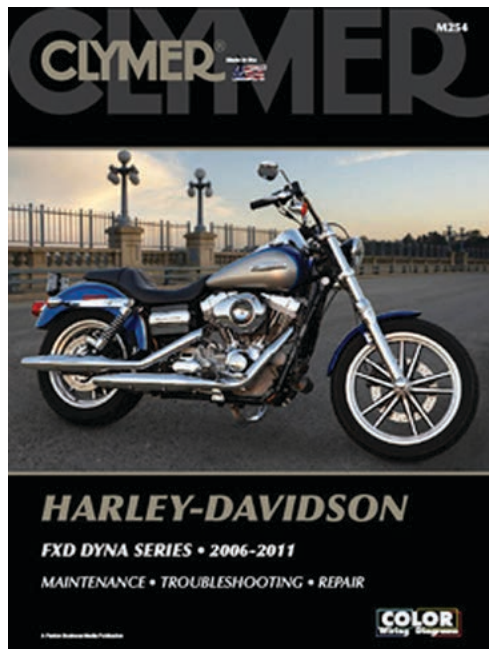

## N.A.D.A.

### MOTORCYCLE / ATV / SNOWMOBILE / PERSONAL WATERCRAFT APPRAISAL GUIDE

*New editions are available for purchase (Jan. - May - Sept.)*

If determining current values for used snowmobiles, motorcycles, ATV's or personal watercraft is part of your business, then you need the best appraisal guide available. Whether you're buying or selling, N.A.D.A. has the information you want. It's complete, up-to-date, and easy to use. Definitely the right choice.

Years	WPS#
1995-Current	<b>27-1098</b>

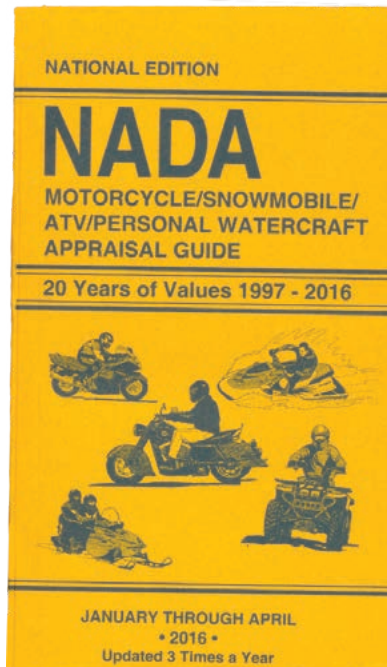

## CATALOG RACKS

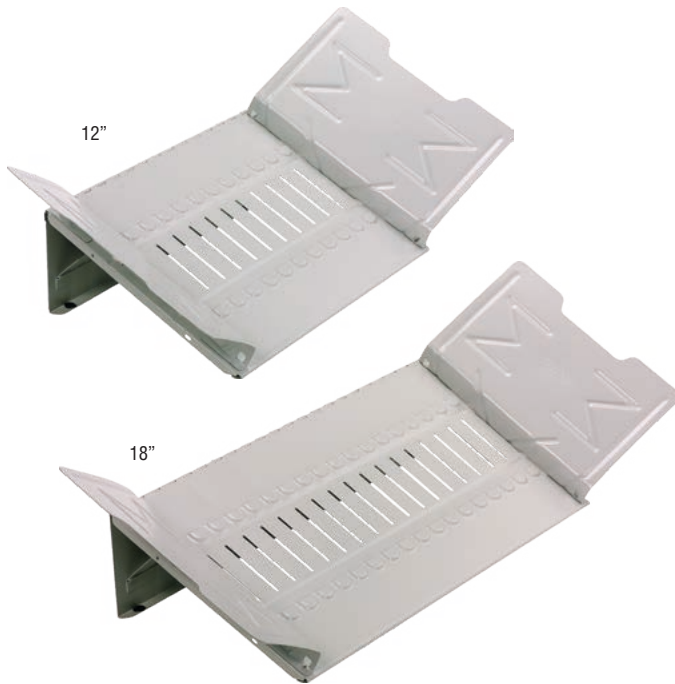

- Hinged for fast and easy set-up
- Desktop racks are angled at 45° for best viewing while seated
- Countertop racks are angled at 30° for best viewing while standing
- Unique tongue and groove system provides easy insertion and removal of sections
- Heavy-gauge steel construction, available in black or gray
- Available accessories include; extension units, turntables, locking bars and index sets
- Sections sold separately below

Filing capacity	Application	Wing to wing Length	WPS#
12"	Desktop	25"	99-4073
18"	Desktop	33"	99-4074
12"	Countertop	25"	99-4075
18"	Countertop	33"	99-4076

## CATALOG RACK SECTIONS

- Designed to securely hold catalogs and other reference materials for placement in catalog racks
- Ring sections are designed for use with punched magazines and loose-leaf materials
- Bar sections are designed for use with un-punched catalogs
- Sections fit easily into any Master® rack with unique tongue and groove system

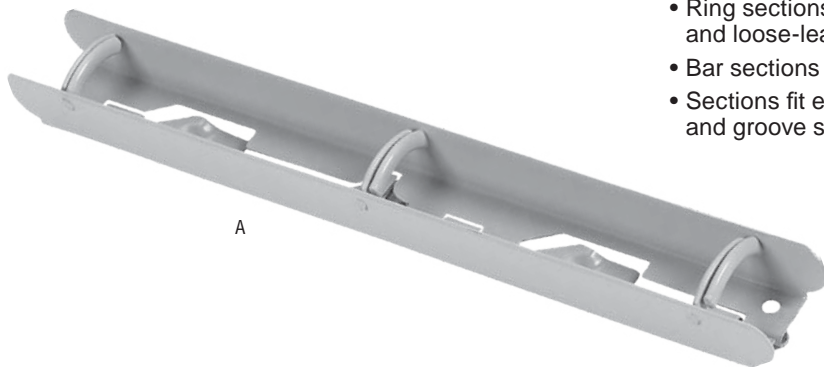

A

Description	WPS#
A Ring section 1" wide	99-4070
B Ring section 2" wide	99-4071

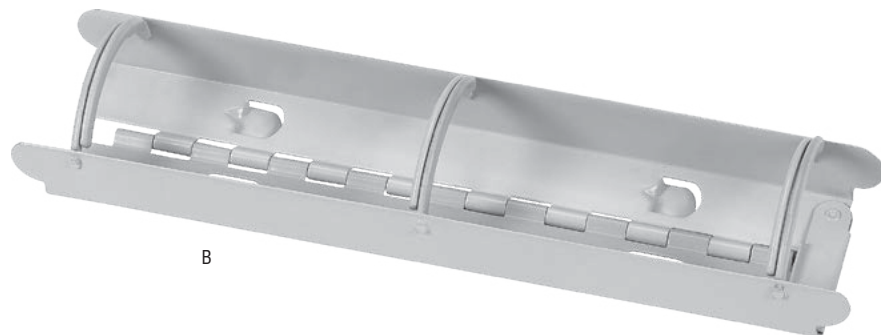

B

- WINDSHIELDS / FAIRINGS
- AUDIO / COMMUNICATION
- SEATS / LUGGAGE
- BAR / MIRRORS / CONTROLS
- EXHAUST
- AIR / FUEL SYSTEMS
- ENGINE
- TRANSMISSION / DRIVELINE
- GASKETS / SEALS
- ELECTRICAL
- LIGHTING
- CABLES
- BRAKES
- OIL FILTERS
- SUSPENSION
- BODY
- WHEELS
- TIRES / TIRE ACC.
- BIKE ACC.
- VICTORY / INDIAN
- COVERS / LOCKS / TIEDOWNS
- CHEMICALS
- TOOLS**
- HELMETS
- HELMET ACC.
- EYEWEAR
- APPAREL / RIDER ACC.
- PROMOTIONAL
- REFERENCE
- INDEX



38



- **STANDARD:** Meets and exceeds DOT approval
- **CONSTRUCTION:** Durable and lightweight fiberglass shell. 2 shell sizes
- **VISION:** 3 snaps allow for the use of a visor and bubble shields
- **COMFORT / LINER:** Coolmax® comfort liner and cheek pads move moisture away from your head and the fabric dries quickly. Removable and washable interior
- **INCLUDED:** Soft fleece helmet bag



A



B



C



D



E



F



G



H

COLOR/GRAPHIC	XS	S	M	L	X	2X
<b>SOLIDS</b>						
A Metal Flake Black	73-8230XS	73-8230S	73-8230M	73-8230L	73-8230X	73-82302X
B Matte Black	73-8231XS	73-8231S	73-8231M	73-8231L	73-8231X	73-82312X
C Metal Flake Rootbeer	73-8232XS	73-8232S	73-8232M	73-8232L	73-8232X	73-82322X
<b>GRAPHICS</b>						
D Winner Red/Black/Orange	73-8236XS	73-8236S	73-8236M	73-8236L	73-8236X	73-82362X
E Matte White Racer	73-8233XS	73-8233S	73-8233M	73-8233L	73-8233X	73-82332X
F Matte Black/White Scallop	73-8234XS	73-8234S	73-8234M	73-8234L	73-8234X	73-82342X
G Gloss Black/Yellow Scallop	73-8235XS	73-8235S	73-8235M	73-8235L	73-8235X	73-82352X
H Wrench Black/Copper	73-8237XS	73-8237S	73-8237M	73-8237L	73-8237X	73-82372X
I Wrench Black/ Vintage White	73-8238XS	73-8238S	73-8238M	73-8238L	73-8238X	73-82382X



A

# 9MM

## HELMET

**STANDARD:** Meets DOT FMVSS 218

**CONSTRUCTION:** Durable and lightweight polymer shell. 4 shell sizes

**COMFORT / LINER:** Coolmax® comfort liner and cheek pads move moisture away from your head and the fabric dries quickly. Removable and washable interior.

**INCLUDED:** Soft fleece helmet bag



B



C

Model/Color	XS	S	M	L	X	2X	3X	4X	5X
<b>SOLIDS</b>									
A Gloss Black	73-8220XS	73-8220S	73-8220M	73-8220L	73-8220X	73-82202X	73-82203X	73-82204X	73-82205X
B Flat Black	73-8221XS	73-8221S	73-8221M	73-8221L	73-8221X	73-82212X	73-82213X	73-82214X	73-82215X
C Ghost/Skull	73-8222XS	73-8222S	73-8222M	73-8222L	73-8222X	73-82222X	73-82223X	73-82224X	73-82225X

For correct helmet sizing see page 1130  
See page 1132-1134 for helmet replacement parts

- WINDSHIELDS / FAIRINGS
- AUDIO / COMMUNICATION
- SEATS / LUGGAGE
- BAR / MIRRORS / CONTROLS
- EXHAUST
- AIR / FUEL SYSTEMS
- ENGINE
- TRANSMISSION / DRIVELINE
- GASKETS / SEALS
- ELECTRICAL
- LIGHTING
- CABLES
- BRAKES
- OIL FILTERS
- SUSPENSION
- BODY
- WHEELS
- TIRES / TIRE ACC.
- BIKE ACC.
- VICTORY / INDIAN
- COVERS / LOCKS / TIEDOWNS
- CHEMICALS
- TOOLS
- HELMETS**
- HELMET ACC.
- EYEWEAR
- APPAREL / RIDER ACC.
- PROMOTIONAL
- REFERENCE
- INDEX



# .357 HALF HELMET

**STANDARD:** Meets DOT FMVSS 218

**CONSTRUCTION:** Durable and lightweight polymer shell. 2 shell sizes.

**VISION:** Tinted drop down inner sun shield with Anti fog coating and durable hard coating for scratch resistance. 100% UVA/B protection up to 400 nanometers

**COMFORT / LINER:** Removable and washable comfort liner and cheek pads.

**ACCESSORIES:** Optional replacement shields available.

- Tint P/N - 73-8851
- Clear P/N – 73-8852
- Yellow P/N – 73-8853
- Silver Mirror P/N – 73-8854



Model/Color	XS	S	M	L	X	2X
<b>SOLID</b>						
A Gloss Black	73-8200XS	73-8200S	73-8200M	73-8200L	73-8200X	73-82002X
B Flat Black	73-8201XS	73-8201S	73-8201M	73-8201L	73-8201X	73-82012X
<b>GRAPHICS</b>						
C Grey Flame	73-8203XS	73-8203S	73-8203M	73-8203L	73-8203X	73-82032X
D Orange Flame	73-8204XS	73-8204S	73-8204M	73-8204L	73-8204X	73-82042X
E Pink Flame	73-8205XS	73-8205S	73-8205M	73-8205L	73-8205X	
F Purple Flame	73-8206XS	73-8206S	73-8206M	73-8206L	73-8206X	73-82062X

For correct helmet sizing see page 1130

See page 1132-1134 for helmet replacement parts

- WINDSHIELDS / FAIRINGS
- AUDIO / COMMUNICATION
- SEATS / LUGGAGE
- BAR / MIRRORS / CONTROLS
- EXHAUST
- AIR / FUEL SYSTEMS
- ENGINE
- TRANSMISSION / DRIVELINE
- GASKETS / SEALS
- ELECTRICAL
- LIGHTING
- CABLES
- BRAKES
- OIL FILTERS
- SUSPENSION
- BODY
- WHEELS
- TIRES / TIRE ACC.
- BIKE ACC.
- VICTORY / INDIAN
- COVERS / LOCKS / TIEDOWNS
- CHEMICALS
- TOOLS
- HELMETS**
- HELMET ACC.
- EYEWEAR
- APPAREL / RIDER ACC.
- PROMOTIONAL
- REFERENCE
- INDEX



**SENTINEL**

Solids Graphic



**STANDARD:** Meets DOT FMVSS 218 and ECE 20.05

**CONSTRUCTION:** Durable and lightweight polycarbonate/ABS shell. Dual density EPS liner – two layers of EPS, one softer one slightly harder, combine to provide a more progressive impact absorption for different levels of impact. 2 shell sizes.

**VISION:** Optically superior clear face shield with anti-fog coating and durable hard coating for scratch resistance. Tinted drop down inner sun shield. 100% UVA/B protection up to 400 nanometers. Shield lock provides piece of mind, shield will remain closed in all conditions. Easy shield changes – quick, secure and tool – less removal and installation.

**COMFORT / LINER:** Qwick - Dry® comfort liner and cheeks pads. Hydrophilic liner absorbs sweat and is perforated to provide plenty of ventilation. Removable and washable interior. Removable chin curtain.

**VENTILATION:** High-Flow ventilation system. 6 adjustable intake vents. 5 exhaust vents. Removable air guide – helps direct airflow upwards across the shield for fog free vision.

**INCLUDED:** Soft fleece helmet bag.

**ACCESSORIES:** Optional tinted shields available.

Mesh Graphic



COLOR/GRAPHIC	XS	S	M	L	X	2X
<b>SOLIDS</b>						
A Matte Black	73-8323XS	73-8323S	73-8323M	73-8323L	73-8323X	73-83232X
<b>MESH GRAPHIC</b>						
B Grey/Red	73-8324XS	73-8324S	73-8324M	73-8324L	73-8324X	73-83242X
C Black/Hi-Vis	73-8325XS	73-8325S	73-8325M	73-8325L	73-8325X	73-83252X
D Teal/Copper	73-8326XS	73-8326S	73-8326M	73-8326L	73-8326X	73-83262X
E Grey/White	73-8327XS	73-8327S	73-8327M	73-8327L	73-8327X	73-83272X

For correct helmet sizing see page 1128

See page 1132-1134 for helmet replacement parts

- WINDSHIELDS / FAIRINGS
- AUDIO / COMMUNICATION
- SEATS / LUGGAGE
- BARS / MIRRORS / CONTROLS
- EXHAUST
- AIR / FUEL SYSTEMS
- ENGINE
- TRANSMISSION / DRIVELINE
- GASKETS / SEALS
- ELECTRICAL
- LIGHTING
- CABLES
- BRAKES
- OIL FILTERS
- SUSPENSION
- BODY
- WHEELS
- TIRES / TIRE ACC.
- BIKE ACC.
- VICTORY / INDIAN
- COVERS / LOCKS / TIEDOWNS
- CHEMICALS
- TOOLS
- HELMETS**
- HELMET ACC.
- EYEWEAR
- APPAREL / RIDER ACC.
- PROMOTIONAL
- REFERENCE
- INDEX



## REVOLT FS

**Bonus tinted shield included!**



C



- **STANDARD:** Meets and exceeds SNELL 2015 / DOT approval
- **CONSTRUCTION:** Durable and lightweight polycarbonate blend shell. Dual density EPS liner – two layers of EPS, one softer one slightly harder, combine to provide a more progressive impact absorption for different levels of impact. 2 shell sizes
- **VISION:** Optically superior clear face shield with anti-fog coating and durable hard coating for scratch resistance. 100% UVA/B protection up to 400 nanometers. Shield lock provides piece of mind, shield will remain closed in all conditions. Easy shield changes – quick, secure and tool – less removal and installation
- **COMFORT / LINER:** Qwick - Dry® comfort liner and cheeks pads. Hydrophilic liner absorbs sweat and is perforated to provide plenty of ventilation. Removable and washable interior. Removable chin curtain
- **VENTILATION:** High-Flow ventilation system. 4 adjustable intake vents. 4 passive intake vents. 6 exhaust vents. Removable air guide – helps direct airflow upwards across the shield for fog free vision
- **INCLUDED:** BONUS tinted shield with Anti fog coating and durable hard coating for scratch resistance. 100% UVA/B protection up to 400 nanometers. Soft fleece helmet bag



A



B



D

	Color / Graphic	XS	S	M	L	X	2X
<b>LIBERATOR</b>							
A	Gloss White/Black	73-8371XS	73-8371S	73-8371M	73-8371L	73-8371X	73-83712X
B	Gloss Blue/Hi-Vis	73-8372XS	73-8372S	73-8372M	73-8372L	73-8372X	73-83722X
C	Matte Brown/Orange	73-8373XS	73-8373S	73-8373M	73-8373L	73-8373X	73-83732X
D	Matte Black/Green	73-8374XS	73-8374S	73-8374M	73-8374L	73-8374X	73-83742X
<b>SOLID</b>							
E	Matte Black	73-8350XS	73-8350S	73-8350M	73-8350L	73-8350X	73-83502X
F	Gloss White	73-8351XS	73-8351S	73-8351M	73-8351L	73-8351X	73-83512X
<b>PATRIOT</b>							
G	Flat Grey/Black	73-8360XS	73-8360S	73-8360M	73-8360L	73-8360X	73-83602X
H	Flat White/Black	73-8361XS	73-8361S	73-8361M	73-8361L	73-8361X	73-83612X
I	Hi-Vis/Black	73-8364XS	73-8364S	73-8364M	73-8364L	73-8364X	73-83642X
J	Red/Black	73-8362XS	73-8362S	73-8362M	73-8362L	73-8362X	73-83622X
<b>INK 'N NEEDLE</b>							
K	Flat Black/Gun	73-8365XS	73-8365S	73-8365M	73-8365L	73-8365X	73-83652X
L	White/Black	73-8366XS	73-8366S	73-8366M	73-8366L	73-8366X	73-83662X



REVOLT FS



**Bonus tinted shield included!**



E



F



G



H



I



J



K



L

See pages 1129 for replacement parts

- WINDSHIELDS / FAIRINGS
- AUDIO / COMMUNICATION
- SEATS / LUGGAGE
- BARS / MIRRORS / CONTROLS
- EXHAUST
- AIR / FUEL SYSTEMS
- ENGINE
- TRANSMISSION / DRIVELINE
- GASKETS / SEALS
- ELECTRICAL
- LIGHTING
- CABLES
- BRAKES
- OIL FILTERS
- SUSPENSION
- BODY
- WHEELS
- TIRES / TIRE ACC.
- BIKE ACC.
- VICTORY / INDIAN
- COVERS / LOCKS / TIEDOWNS
- CHEMICALS
- TOOLS
- HELMETS**
- HELMET ACC.
- EYEWEAR
- APPAREL / RIDER ACC.
- PROMOTIONAL
- REFERENCE
- INDEX



# CONQUEST

**STANDARD:** Meets DOT FMVSS 218 and ECE 22.05

**CONSTRUCTION:** Advanced Composite Spectra® Shell. Spectra® is stronger than steel and 40% stronger than Aramid fiber commonly known as Kevlar®. Dual density EPS liner – two layers of EPS, one softer one slightly harder, combine to provide a more progressive impact absorption for different levels of impact. 3 shells for a precise fit

**VISION:** Optically superior clear face shield with Anti fog coating and durable hard coating for scratch resistance. Tinted drop down inner sun shield. 100% UVA/B protection up to 400 nanometers. Shield lock provides piece of mind, shield will remain closed in all conditions. Easy shield changes – quick, secure and tool – less removal and installation.

**COMFORT / LINER:** Qwick - Dry® comfort liner and cheek pads. Hydrophilic liner absorbs sweat and is perforated to provide plenty of ventilation. Removable and washable interior. Removable chin curtain.

**VENTILATION:** High-Flow ventilation system. 4 adjustable intake vents. 4 exhaust vents. Removable air guide – helps direct airflow upwards across the shield for fog free vision.

**INCLUDED:** Soft fleece helmet bag.

**ACCESSORIES:** Optional tinted and mirrored shields available.



B



Retro Graphic

Mosaic Graphic



A



C



D



E

COLOR/GRAPHIC	XS	S	M	L	X	2X
<b>SOLIDS</b>						
A Flat Black	73-8400XS	73-8400S	73-8400M	73-8400L	73-8400X	73-84002X
<b>RETRO</b>						
B Matte Wht/Blk/Gry	73-8411XS	73-8411S	73-8411M	73-8411L	73-8411X	73-84112X
C Pink/White/Black	73-8419XS	73-8419S	73-8419M	73-8419L	73-8419X	
<b>MOSAIC</b>						
D Flat Black/Grey	73-8420XS	73-8420S	73-8420M	73-8420L	73-8420X	73-84202X
E White/Red/Black	73-8421XS	73-8421S	73-8421M	73-8421L	73-8421X	73-84212X

For correct helmet sizing see page 1128

# TOURIST HELMET

**Bonus tinted shield included!**



H



A B C D



E F G I J K

**STANDARD:** Meets DOT FMVSS 218

**CONSTRUCTION:** Durable and lightweight polymer shell. Removable clip-in jaw piece. 2 shell sizes.

**VISION:** Optically superior clear face shield with Anti fog coating and durable hard coating for scratch resistance. 100% UVA/B protection up to 400 nanometers. Large eye port for improved range of vision. Easy shield and peak changes – quick, secure and tool – less removal and installation.

**COMFORT / LINER:** Coolmax® comfort liner and cheek pads move moisture away from your head and the fabric dries quickly. Removable and washable interior. Removable chin curtain and breath box. Deluxe oversized ear cavities that include integrated speaker pockets for communications systems.

**VENTILATION:** High-Flow ventilation system. 2 adjustable intake vents. 2 passive intake vents. 2 adjustable exhaust vents. 4 passive exhaust vents.

**INCLUDED:** BONUS tinted shield with Anti fog coating and durable hard coating for scratch resistance. 100% UVA/B protection up to 400 nanometers. BONUS peak visor for use without the shield. Soft fleece helmet bag.

**ACCESSORIES:** Optional Anti-Fog Clear Shield, Clear double lens shield, Tinted shield and Mirrored shields available.

	Graphic	XS	S	M	L	X	2X
<b>SOLIDS</b>							
A	Gloss Black	73-8100XS	73-8100S	73-8100M	73-8100L	73-8100X	73-81002X
B	Flat Black	73-8101XS	73-8101S	73-8101M	73-8101L	73-8101X	73-81012X
C	Titanium	73-8102XS	73-8102S	73-8102M	73-8102L	73-8102X	73-81022X
D	Blue	73-8103XS	73-8103S	73-8103M	73-8103L	73-8103X	73-81032X
E	Pearl White	73-8104XS	73-8104S	73-8104M	73-8104L	73-8104X	73-81042X
F	Candy Red	73-8105XS	73-8105S	73-8105M	73-8105L	73-8105X	73-81052X
<b>GRAPHICS</b>							
G	Vista Hi-Viz/Gunmetal	73-8106XS	73-8106S	73-8106M	73-8106L	73-8106X	73-81062X
H	Vista Flat Black/Silver	73-8107XS	73-8107S	73-8107M	73-8107L	73-8107X	73-81072X
I	Cirrus White/Pink	73-8108XS	73-8108S	73-8108M	73-8108L	73-8108X	
J	Cirrus White/Silver	73-8109XS	73-8109S	73-8109M	73-8109L	73-8109X	
K	Cirrus White/Blue	73-8110XS	73-8110S	73-8110M	73-8110L	73-8110X	

See page 1132-1134 for helmet replacement parts

- WINDSHIELDS / FAIRINGS
- AUDIO / COMMUNICATION
- SEATS / LUGGAGE
- BAR / MIRRORS / CONTROLS
- EXHAUST
- AIR / FUEL SYSTEMS
- ENGINE
- TRANSMISSION / DRIVELINE
- GASKETS / SEALS
- ELECTRICAL
- LIGHTING
- CABLES
- BRAKES
- OIL FILTERS
- SUSPENSION
- BODY
- WHEELS
- TIRES / TIRE ACC.
- BIKE ACC.
- VICTORY / INDIAN
- COVERS / LOCKS / TIEDOWNS
- CHEMICALS
- TOOLS
- HELMETS**
- HELMET ACC.
- EYEWEAR
- APPAREL / RIDER ACC.
- PROMOTIONAL
- REFERENCE
- INDEX



**FF-98 FULL FACE STREET HELMET** 

The New FF-98 features GMAX's New quick release face shield mechanism with shield lock and our integrated LED rear light. The ECE rating gives you the assurance that this helmet has been certified by the leader in "world standard" safety equipment testing.

- **ECE and DOT approved**
- SpaSoft DuPont Coolmax® interior keeps you dry and comfortable. Coolmax® wicks moisture away from your body and dries quickly. Charcoal bamboo fiber keeps odor away by eliminating bacterial growth
- Removable, adjustable, washable SpaSoft Coolmax® interior allows for easy cleaning and custom fitting
- New tool-less and quick release face shield mechanism
- Eight intake and exhaust vents
- Integrated multi-function red LED rear light included. (Optional wireless brake light kit available P/N 72-3781)
- Lightweight ABS shell. Large size is only 3.5lbs.
- Drop down sun shade with anti-fog coating
- UV400 100% protection from the anti-scratch, hard coated face shield for a longer lasting clear view
- Shield lock
- Breath deflector and chin curtain included
- Built in speaker pockets
- Intercom compatible



A



B



C



D



E



F



G



H



I



J

Graphic/Color	XS	S	M	L	XL	2X	3X
A Black	72-5110XS	72-5110S	72-5110M	72-5110L	72-5110X	72-51102X	72-51103X
B Matte Black	72-5111XS	72-5111S	72-5111M	72-5111L	72-5111X	72-51112X	72-51113X
C Titanium	72-5113XS	72-5113S	72-5113M	72-5113L	72-5113X	72-51132X	72-51133X
D Apex Black/Red	72-5121XS	72-5121S	72-5121M	72-5121L	72-5121X	72-51212X	72-51213X
E Apex Black/Blue	72-5122XS	72-5122S	72-5122M	72-5122L	72-5122X	72-51222X	72-51223X
F Apex Matte Black/White	72-5123XS	72-5123S	72-5123M	72-5123L	72-5123X	72-51232X	72-51233X
G Apex Matte Black/Dark Silver	72-5124XS	72-5124S	72-5124M	72-5124L	72-5124X	72-51242X	72-51243X
H Apex Black/Hi-Vis Yellow	72-5125XS	72-5125S	72-5125M	72-5125L	72-5125X	72-51252X	72-51253X
I Apex Matte Black/Hi-Vis Green	72-5126XS	72-5126S	72-5126M	72-5126L	72-5126X	72-51262X	72-51263X
J Willow White/Pink	72-5129XS	72-5129S	72-5129M	72-5129L	72-5129X		



**FF-88 FULL FACE STREET HELMET**



From the outset, the FF-88 was designed for the performance enthusiast. With its aerodynamic shape, SpaSoft Coolmax® interior, and lightweight shell, GMAX gives you the perfect helmet for taking on your favorite back road. The ECE rating gives you the assurance that this helmet has been certified by the leader in "world standard" safety equipment testing.

- **ECE and DOT approved**
- SpaSoft DuPont Coolmax® interior keeps you dry and comfortable. Coolmax® wicks moisture away from your body and dries quickly. Charcoal bamboo fiber keeps odors away by eliminating bacterial growth
- Removable, adjustable, washable Spa Soft Coolmax® interior allows for easy cleaning and custom fitting
- GMAX D.E.V.S (dual exhaust venting system) top and rear vents reduce temperature by allowing hot air to escape from the top of the helmet
- Low profile intake and exhaust vents
- Vents securely close to completely seal out the cold
- Lightweight shell – Large size is only 3.3lbs.
- 100% UV400 protection from the anti-scratch, hard coated face shield for a longer lasting clear view
- Breath deflector and chin curtain included



B



A



C



D



E



F



G

Graphic/Color	XS	S	M	L	X	2X	3X
A Gloss Black	72-4769XS	72-4769S	72-4769M	72-4769L	72-4769X	72-47692X	72-47693X
B Precept Black/Red	72-4791XS	72-4791S	72-4791M	72-4791L	72-4791X	72-47912X	72-47913X
C Precept Black/Blue	72-4792XS	72-4792S	72-4792M	72-4792L	72-4792X	72-47922X	72-47923X
D Precept Black/Hi-Vis Yellow	72-4794XS	72-4794S	72-4794M	72-4794L	72-4794X	72-47942X	72-47943X
E Precept White/Black	72-4797XS	72-4797S	72-4797M	72-4797L	72-4797X	72-47972X	72-47973X
F Precept Matte Black	72-4798XS	72-4798S	72-4798M	72-4798L	72-4798X	72-47982X	72-47983X
G Precept Black/Hi-Vis Pink	72-4799XS	72-4799S	72-4799M	72-4799L	72-4799X		

- WINDSHIELDS / FAIRINGS
- AUDIO / COMMUNICATION
- SEATS / LUGGAGE
- BARS / MIRRORS / CONTROLS
- EXHAUST
- AIR / FUEL SYSTEMS
- ENGINE
- TRANSMISSION / DRIVELINE
- GASKETS / SEALS
- ELECTRICAL
- LIGHTING
- CABLES
- BRAKES
- OIL FILTERS
- SUSPENSION
- BODY
- WHEELS
- TIRES / TIRE ACC.
- BIKE ACC.
- VICTORY / INDIAN
- COVERS / LOCKS / TIEDOWNS
- CHEMICALS
- TOOLS
- HELMETS**
- HELMET ACC.
- EYEWEAR
- APPAREL / RIDER ACC.
- PROMOTIONAL
- REFERENCE
- INDEX



# FF-88 FULL FACE STREET HELMET

From the outset, the FF-88 was designed for the performance enthusiast. With its aerodynamic shape, SpaSoft Coolmax® interior, and lightweight shell, GMAX gives you the perfect helmet for taking on your favorite back road. The ECE rating gives you the assurance that this helmet has been certified by the leader in "world standard" safety equipment testing.

- **ECE and DOT approved**
- SpaSoft DuPont Coolmax® interior keeps you dry and comfortable. Coolmax® wicks moisture away from your body and dries quickly. Charcoal bamboo fiber keeps odors away by eliminating bacterial growth
- Removable, adjustable, washable Spa Soft Coolmax® interior allows for easy cleaning and custom fitting
- GMAX D.E.V.S (dual exhaust venting system) top and rear vents reduce temperature by allowing hot air to escape from the top of the helmet
- Low profile intake and exhaust vents
- Vents securely close to completely seal out the cold
- Lightweight shell – Large size is only 3.3lbs.
- 100% UV400 protection from the anti-scratch, hard coated face shield for a longer lasting clear view
- Breath deflector and chin curtain included



A



B



C



D



E



F



G



H



I

Model/Color	XS	S	M	L	X	2X	3X
A Matte Black	72-4770XS	72-4770S	72-4770M	72-4770L	72-4770X	72-47702X	72-47703X
B X-Star White/Red	72-4771XS	72-4771S	72-4771M	72-4771L	72-4771X	72-47712X	72-47713X
C X-Star White/Blue	72-4772XS	72-4772S	72-4772M	72-4772L	72-4772X	72-47722X	72-47723X
D X-Star Matte White/White	72-4777XS	72-4777S	72-4777M	72-4777L	72-4777X	72-47772X	72-47773X
E X-Star Matte Bk/Dk Sil	72-4778XS	72-4778S	72-4778M	72-4778L	72-4778X	72-47782X	72-47783X
F X-Star White/Hi-Vis Yellow	72-4774XS	72-4774S	72-4774M	72-4774L	72-4774X	72-47742X	72-47743X
G X-Star White/Hi-Vis Green	72-4775XS	72-4775S	72-4775M	72-4775L	72-4775X	72-47752X	72-47753X
H Derk Matte Black/Silver	72-4780XS	72-4780S	72-4780M	72-4780L	72-4780X	72-47802X	72-47803X
I Versailles Matte Black/Pink	72-4789XS	72-4789S	72-4789M	72-4789L	72-4789X		

See pages 1135-1144 for replacement parts

# FF-49 STREET HELMET



With its aggressive styling and super light weight, the FF-49 proves that great quality doesn't have to come at a high price. The FF-49 comes with many features you would expect on more expensive helmets. Such as a comfortable Coolmax® interior, 100% UV400 resistant dual pane lens, and effective ventilation system.



D

- DOT approved
- DuPont Coolmax® interior keeps you dry and comfortable. Coolmax® fabric wicks moisture away from your body and dries quickly
- Removable, adjustable, washable Coolmax® interior allows for easy cleaning and custom fitting
- Flow through intake/exhaust venting forehead vents and rear exhausts vents help pull fresh air in & remove hot air through channeled vents
- 100% UV400 protection from the anti-scratch face shield which is hard coated for a longer lasting clear view
- Large eyepoint for improved range of vision
- Light weight- only 3.2 lbs. in medium shell



A

B

C

E

Graphic/Color	XS	S	M	L	X
A Elegance Matte White/Silver	72-5721XS	72-5721S	72-5721M	72-5721L	72-5721X
B Elegance Black/Pink	72-5722XS	72-5722S	72-5722M	72-5722L	72-5722X
C Elegance Matte Black/Purple	72-5723XS	72-5723S	72-5723M	72-5723L	72-5723X
D Yarrow Matte Black/Gold	72-5728XS	72-5728S	72-5728M	72-5728L	72-5728X
E Yarrow White/Pink	72-5729XS	72-5729S	72-5729M	72-5729L	72-5729X

See pages 1135-1144 for replacement parts

- WINDSHIELDS / FAIRINGS
- AUDIO / COMMUNICATION
- SEATS / LUGGAGE
- BARS / MIRRORS / CONTROLS
- EXHAUST
- AIR / FUEL SYSTEMS
- ENGINE
- TRANSMISSION / DRIVELINE
- GASKETS / SEALS
- ELECTRICAL
- LIGHTING
- CABLES
- BRAKES
- OIL FILTERS
- SUSPENSION
- BODY
- WHEELS
- TIRES / TIRE ACC.
- BIKE ACC.
- VICTORY / INDIAN
- COVERS / LOCKS / TIEDOWNS
- CHEMICALS
- TOOLS
- HELMETS
- HELMET ACC.
- EYEWEAR
- APPAREL / RIDER ACC.
- PROMOTIONAL
- REFERENCE
- INDEX

**GMAX FF-49 STREET HELMET**

With its aggressive styling and super light weight, the FF-49 proves that great quality doesn't have to come at a high price. The FF-49 comes with many features you would expect on more expensive helmets. Such as a comfortable Coolmax® interior, 100% UV400 resistant dual pane lens, and effective ventilation system.



	Model/Color	XS	S	M	L	X	2X	3X
A	Gloss Black	72-5700XS	72-5700S	72-5700M	72-5700L	72-5700X	72-57002X	72-57003X
B	Matte Black	72-5701XS	72-5701S	72-5701M	72-5701L	72-5701X	72-57012X	72-57013X
C	White	72-5702XS	72-5702S	72-5702M	72-5702L	72-5702X	72-57022X	72-57023X
D	Titanium	72-5703XS	72-5703S	72-5703M	72-5703L	72-5703X	72-57032X	72-57033X
E	Derk Flat Black/Silver	72-5706XS	72-5706S	72-5706M	72-5706L	72-5706X	72-57062X	72-57063X
F	Rogue White/Red	72-5741XS	72-5741S	72-5741M	72-5741L	72-5741X	72-57412X	72-57413X
G	Rogue Matte White/Blue	72-5742XS	72-5742S	72-5742M	72-5742L	72-5742X	72-57422X	72-57423X
H	Rogue Matte Black/White	72-5743XS	72-5743S	72-5743M	72-5743L	72-5743X	72-57432X	72-57433X
I	Rogue White/Black	72-5744XS	72-5744S	72-5744M	72-5744L	72-5744X	72-57442X	72-57443X
J	Rogue Matte Black/Hi-Viz Green	72-5745XS	72-5745S	72-5745M	72-5745L	72-5745X	72-57452X	72-57453X
K	Rogue Matte Black/Hi-Viz Yellow/Red	72-5749XS	72-5749S	72-5749M	72-5749L	72-5749X	72-57492X	72-57493X

See pages 1135-1144 for replacement parts



# GM-38 FULL FACE STREET HELMET



The GM-38 proves quality that doesn't have to break the bank. With standard features like a quick change shield, snap in chin curtain, and Gmax's D.E.V.S. anti-fog system, the GM-38 is the best bang for your buck in the Gmax line.



- DOT approved
- Large eyeport opening for greater visibility
- Optional outer flip tint sun lens
- Quick change shield
- GMAX reduced noise design; specially designed cheek pads, neck curtain, optimal shield sealing and deluxe venting reduce unwanted noise
- D.E.V.S. GMAX anti-fog system, "Dual Exhaust Venting System" side intake and exhaust vents draw heat and moisture away from the shield area out of the helmet
- Adjustable chin vents direct air upwards across the inside of the shield to help reduce fogging
- Snap in removable chin curtain and breath guard. (Breath guard is optional with motorcycle helmets.)
- Deluxe ear pockets for better fit and speaker installation



Graphic	XXS	XS	S	M	L	XL	2X	3X
A Black	72-5730XXS	72-5730XS	72-5730S	72-5730M	72-5730L	72-5730XL	72-5730XX	72-5730XXX
B Matte Black	72-5738XXS	72-5738XS	72-5738S	72-5738M	72-5738L	72-5738XL	72-5738XX	72-5738XXX
C White	72-5731XXS	72-5731XS	72-5731S	72-5731M	72-5731L	72-5731XL	72-5731XX	72-5731XXX

See pages 1135-1144 for replacement parts

- WINDSHIELDS / FAIRINGS
- AUDIO / COMMUNICATION
- SEATS / LUGGAGE
- BARS / MIRRORS / CONTROLS
- EXHAUST
- AIR / FUEL SYSTEMS
- ENGINE
- TRANSMISSION / DRIVELINE
- GASKETS / SEALS
- ELECTRICAL
- LIGHTING
- CABLES
- BRAKES
- OIL FILTERS
- SUSPENSION
- BODY
- WHEELS
- TIRES / TIRE ACC.
- BIKE ACC.
- VICTORY / INDIAN
- COVERS / LOCKS / TIEDOWNS
- CHEMICALS
- TOOLS
- HELMETS**
- HELMET ACC.
- EYEWEAR
- APPAREL / RIDER ACC.
- PROMOTIONAL
- REFERENCE
- INDEX



**GM-49Y YOUTH FULL FACE STREET HELMET**

Kids know riding is fun and Gmax makes it even more fun with the GM-49Y. With the availability of three interchangeable interior sizes, the helmet can be custom fit to make the child safe and comfortable. Parents will be happy knowing that their little one is protected in a light weight, DOT approved helmet that they will love wearing.

• **DOT approved**

- Light weight- only 3.1 lbs
- One shell can be adjusted to three different sizes so the helmet can grow as your child grows.
- Removable, adjustable interior and cheek pads allow for custom fitting and easy cleaning.
- Snap-in removable chin curtain.
- Flow-thru intake/exhaust venting forehead vents and rear exhaust vents help pull in desired fresh air & remove unwanted hot air thru channeled vents.
- New quick change "Maximum Seal" shields available in single and anti-fog double lens.
- Large eyeport for improved range of vision.



D



[See pages 1135-1144 for replacement parts](#)

- WINDSHIELDS / FAIRINGS
- AUDIO / COMMUNICATION
- SEATS / LUGGAGE
- BARS / MIRRORS / CONTROLS
- EXHAUST
- AIR / FUEL SYSTEMS
- ENGINE
- TRANSMISSION / DRIVELINE
- GASKETS / SEALS
- ELECTRICAL
- LIGHTING
- CABLES
- BRAKES
- OIL FILTERS
- SUSPENSION
- BODY
- WHEELS
- TIRES / TIRE ACC.
- BIKE ACC.
- VICTORY / INDIAN
- COVERS / LOCKS / TIEDOWNS
- CHEMICALS
- TOOLS
- HELMETS**
- HELMET ACC.
- EYEWEAR
- APPAREL / RIDER ACC.
- PROMOTIONAL
- REFERENCE
- INDEX

GM-49Y YOUTH FULL FACE STREET HELMET



A



B



C



E



F



G



H



I



J

	Model/Graphic	YS	YM	YL
A	Gloss Black	72-4940YS	72-4940YM	72-4940YL
B	Alien Black/Red	72-4981YS	72-4981YM	72-4981YL
C	Alien Black/Blue	72-4982YS	72-4982YM	72-4982YL
D	Alien Black/Silver	72-4984YS	72-4984YM	72-4984YL
E	Alien Black/Green	72-4985YS	72-4985YM	72-4985YL
F	Alien Black/Orange	72-4987YS	72-4987YM	72-4987YL
G	Alien Pink/Purple	72-4988YS	72-4988YM	72-4988YL
H	Rogue White/Red	72-4976YS	72-4976YM	72-4976YL
I	Rogue Matte Black/Blue	72-4977YS	72-4977YM	72-4977YL
J	Rogue Matte Hi-Viz/Yellow/Red	72-4978YS	72-4978YM	72-4978YL

- WINDSHIELDS / FAIRINGS
- AUDIO / COMMUNICATION
- SEATS / LUGGAGE
- BARS / MIRRORS / CONTROLS
- EXHAUST
- AIR / FUEL SYSTEMS
- ENGINE
- TRANSMISSION / DRIVELINE
- GASKETS / SEALS
- ELECTRICAL
- LIGHTING
- CABLES
- BRAKES
- OIL FILTERS
- SUSPENSION
- BODY
- WHEELS
- TIRES / TIRE ACC.
- BIKE ACC.
- VICTORY / INDIAN
- COVERS / LOCKS / TIEDOWNS
- CHEMICALS
- TOOLS
- HELMETS**
- HELMET ACC.
- EYEWEAR
- APPAREL / RIDER ACC.
- PROMOTIONAL
- REFERENCE
- INDEX

See pages 1135-1144 for replacement parts



**MD-01 FULL FACE HELMET**



GMAX's New MD-01 Modular is the perfect helmet for cross-country adventures. With eleven vents and a Coolmax liner, you are sure to be comfortable even on the hottest of days. The integrated LED light helps to insure you are seen by traffic. The ECE rating on the MD01 gives you assurance that this helmet has been certified by the leader in "world standard" safety equipment testing.

- ECE and DOT approved
- SpaSoft DuPont Coolmax® interior keeps you dry and comfortable. Coolmax® wicks moisture away from your body and dries quickly. Charcoal bamboo fiber keeps odor away by eliminating bacterial growth
- Removable, adjustable and washable SpaSoft Coolmax® interior allows for easy cleaning and custom fitting
- Drop down sun shade with anti-fog coating
- Integrated multi-function red LED rear light included. (Optional wireless brake light kit available P/N 72-3781)
- Lightweight ABS shell. Large size only 4.1 lbs.
- Easy to use chin bar with push to open mechanism designed for one hand use with gloves
- UV400 100% protection face shield that comes anti-scratch hard coated for a longer lasting clear view
- Breath deflector and chin curtain included
- Built in speaker pockets
- Intercom compatible



H



A

B

C

D



E



F



G

Graphic/Color	XS	S	M	L	X	2X	3X
A Black	72-4710XS	72-4710S	72-4710M	72-4710L	72-4710X	72-47102X	72-47103X
B Matte Black	72-4711XS	72-4711S	72-4711M	72-4711L	72-4711X	72-47112X	72-47113X
C Pearl White	72-4712XS	72-4712S	72-4712M	72-4712L	72-4712X	72-47122X	72-47123X
D Titanium	72-4719XS	72-4719S	72-4719M	72-4719L	72-4719X	72-47192X	72-47193X
E Wine Red	72-4715XS	72-4715S	72-4715M	72-4715L	72-4715X	72-47152X	72-47153X
F PRR Black/Pink	72-4729XS	72-4729S	72-4729M	72-4729L	72-4729X		
G Stealth Matte Black/Hi-Vis Yellow	72-4724XS	72-4724S	72-4724M	72-4724L	72-4724X	72-47242X	72-47243X
H Stealth Matte Black/Silver	72-4722XS	72-4722S	72-4722M	72-4722L	72-4722X	72-47222X	72-47223X

See pages 1135-1144 for replacement parts

**GM-64 MODULAR STREET HELMET**



Gmax's premium modular helmet adds a level of refinement to our helmet line up. With its "Dual Pivot" design, the GM-64 has a very low profile when the chin bar is in the open position making it feel lighter compared to traditional single pivot designs. A metal on metal locking system insures a positive lock for maximum security. The Coolmax® interior keeps you comfortable and dry for those long days in the saddle.



- DOT approved
- "Dual Pivot" modular jaw design allows the flip jaw to rotate further back and sit lower down on the crown of the helmet. This increases the line of sight when in the raised position and it lessens fatigue by maintaining an even distribution of weight.
- Features an all new "Perimeter-Frame-Design" that provides unequaled wind and cold protection.
- The "squeeze & lift" jaw release design is easy to operate with a gloved hand.
- Features a metal to metal jaw closure.
- Quick detach inner sun shield that is UV400 coated.
- State of the Art anti-fog coated, maximum seal single lens shield comes with anti-scratch hard coated outer lens for a longer lasting clear view and is UV400 coated.
- Coolmax® comfort liner and cheek pads wick the moisture away from your body and the fabric dries quickly. This added performance keeps you dry and comfortable.
- Optional 3M reflective decals that can be placed on the helmet for added safety visibility.



Graphic	XS	S	M	L	X	2X	3X
A Black	72-5100XS	72-5100S	72-5100M	72-5100L	72-5100X	72-51002X	72-51003X
B Matte Black	72-5102XS	72-5102S	72-5102M	72-5102L	72-5102X	72-51022X	72-51023X
C Pearl White	72-5101XS	72-5101S	72-5101M	72-5101L	72-5101X	72-51012X	72-51013X
D Wine	72-5105XS	72-5105S	72-5105M	72-5105L	72-5105X	72-51052X	72-51053X
E Titanium	72-5109XS	72-5109S	72-5109M	72-5109L	72-5109X	72-51092X	72-51093X
F Hi-Viz Yellow	72-5104XS	72-5104S	72-5104M	72-5104L	72-5104X	72-51042X	72-51043X
G Derk Matte Black/Silver	72-5108XS	72-5108S	72-5108M	72-5108L	72-5108X	72-51082X	72-51083X

See pages 1135-1144 for replacement parts

- WINDSHIELDS / FAIRINGS
- AUDIO / COMMUNICATION
- SEATS / LUGGAGE
- BAR / MIRRORS / CONTROLS
- EXHAUST
- AIR / FUEL SYSTEMS
- ENGINE
- TRANSMISSION / DRIVELINE
- GASKETS / SEALS
- ELECTRICAL
- LIGHTING
- CABLES
- BRAKES
- OIL FILTERS
- SUSPENSION
- BODY
- WHEELS
- TIRES / TIRE ACC.
- BIKE ACC.
- VICTORY / INDIAN
- COVERS / LOCKS / TIEDOWNS
- CHEMICALS
- TOOLS
- HELMETS**
- HELMET ACC.
- EYEWEAR
- APPAREL / RIDER ACC.
- PROMOTIONAL
- REFERENCE
- INDEX

**GMAX MD-04 MODULAR STREET HELMET**

The MD-04 Modular is the perfect lightweight helmet for cross-country adventures. The MD-04 has all the essentials, including a list of standard GMAX features normally only found on more expensive helmets.

- DOT approved
- DuPont Coolmax® interior keeps you dry and comfortable. Coolmax® wicks moisture away from your body and dries quickly
- Removable, adjustable, washable Coolmax® interior allows for easy cleaning and custom fitting
- GMAX D.E.V.S (dual exhaust venting system) top and rear vents reduce temperature by allowing hot air to escape from the top of the helmet
- Vents close to completely seal out the cold
- Adjustable mouth vent directs air upward across the inside the shield to help reduce fogging
- Lightweight shell. Large size only 4 lbs.
- Easy to use chin bar with push to open mechanism designed for use with gloves
- 100% UV400 protection face shield that comes anti-scratch hard coated for a longer lasting clear view



G



A



B



C



D



E



F

	Graphic	XS	S	M	L	X	2X	3X
A	Black	72-5020XS	72-5020S	72-5020M	72-5020L	72-5020X	72-50202X	72-50203X
B	Matte Black	72-5021XS	72-5021S	72-5021M	72-5021L	72-5021X	72-50212X	72-50213X
C	Pearl White	72-5022XS	72-5022S	72-5022M	72-5022L	72-5022X	72-50222X	72-50223X
D	Metallic Silver	72-5023XS	72-5023S	72-5023M	72-5023L	72-5023X	72-50232X	72-50233X
E	Wine Red	72-5025XS	72-5025S	72-5025M	72-5025L	72-5025X	72-50252X	72-50253X
F	Hi-Viz Yellow/Black	72-5028XS	72-5028S	72-5028M	72-5028L	72-5028X	72-50282X	72-50283X
G	Matte Black/Dark Silver	72-5029XS	72-5029S	72-5029M	72-5029L	72-5029X	72-50292X	72-50293X

See pages 1135-1144 for replacement parts

# OF-77 OPEN FACE HELMET



The OF-77 features the all new SpaSoft Coolmax interior which combines the moisture wicking properties of Coolmax® with the anti-microbial properties of bamboo. The OF-77 is like having two helmets in one. It offers the comfort of an open face helmet with the ability to quickly and easily convert into a full face helmet with the installation of the optional snap-in jaw piece.



A

- **DOT approved**
- New SpaSoft DuPont Coolmax® interior keeps you dry and comfortable. Coolmax® wicks moisture away from your body and dries quickly. Charcoal bamboo fiber keeps odors away by eliminating bacterial growth
- Removable, adjustable, washable Spa Soft Coolmax® interior allows for easy cleaning and custom fitting
- GMAX D.E.V.S (dual exhaust venting system) top and rear vents reduce temperature by allowing hot air to escape from the top of the helmet
- Vents close to completely seal out the cold
- 100% UV400 protection from the anti-scratch hard coated face shield for a longer lasting clear view
- Tinted inner sun shade with anti-fog coating
- Lightweight shell. Large size only 3.2 lbs.
- Optional anti-fog, maximum seal double lens face shield available P/N **72-3547**
- Optional brake light kit available P/N **72-3781**
- Optional snap-in jaw piece with breath guard and chin curtain available P/N **72-3570**



B



C



D



E



F

Graphic/Color	XS	S	M	L	X	2X	3X
A Matte Black	72-4741XS	72-4741S	72-4741M	72-4741L	72-4741X	72-47412X	72-47413X
B Black	72-4740XS	72-4740S	72-4740M	72-4740L	72-4740X	72-47402X	72-47403X
C Titanium	72-4742XS	72-4742S	72-4742M	72-4742L	72-4742X	72-47422X	72-47423X
D Pearl White	72-4744XS	72-4744S	72-4744M	72-4744L	72-4744X	72-47442X	72-47443X
E Candy Red	72-4745XS	72-4745S	72-4745M	72-4745L	72-4745X	72-47452X	72-47453X
F Wine Red	72-4746XS	72-4746S	72-4746M	72-4746L	72-4746X	72-47462X	72-47463X

See pages 1135-1144 for replacement parts

- WINDSHIELDS / FAIRINGS
- AUDIO / COMMUNICATION
- SEATS / LUGGAGE
- BAR / MIRRORS / CONTROLS
- EXHAUST
- AIR / FUEL SYSTEMS
- ENGINE
- TRANSMISSION / DRIVELINE
- GASKETS / SEALS
- ELECTRICAL
- LIGHTING
- CABLES
- BRAKES
- OIL FILTERS
- SUSPENSION
- BODY
- WHEELS
- TIRES / TIRE ACC.
- BIKE ACC.
- VICTORY / INDIAN
- COVERS / LOCKS / TIEDOWNS
- CHEMICALS
- TOOLS
- HELMETS**
- HELMET ACC.
- EYEWEAR
- APPAREL / RIDER ACC.
- PROMOTIONAL
- REFERENCE
- INDEX



**OF-77 OPEN FACE HELMET**



A



B



C



D



E



F



G



H



I



J

Color	XS	S	M	L	X	2X	3X
<b>OF-77 - CLASSIC</b>							
A Matte Black/Orange	72-4755XS	72-4755S	72-4755M	72-4755L	72-4755X	72-47552X	72-47553X
B Matte Black/Silver	72-4754XS	72-4754S	72-4754M	72-4754L	72-4754X	72-47542X	72-47543X
C Matte Black/Pink	72-4757XS	72-4757S	72-4757M	72-4757L	72-4757X		
<b>OF-77 - DERK</b>							
D Derk Matte Black/Silver	72-4758XS	72-4758S	72-4758M	72-4758L	72-4758X	72-47582X	72-47583X
<b>OF-77 - DOWNEY</b>							
E Matte Grey/Silver	72-4761XS	72-4761S	72-4761M	72-4761L	72-4761X	72-47612X	72-47613X
F Matte Grey/Orange	72-4762XS	72-4762S	72-4762M	72-4762L	72-4762X	72-47622X	72-47623X
G Matte Black/Pink	72-4763XS	72-4763S	72-4763M	72-4763L	72-4763X		
<b>OF-77 - ETERNAL</b>							
H Black/Pink	72-4766XS	72-4766S	72-4766M	72-4766L	72-4766X		
I Matte Grey/Teal	72-4767XS	72-4767S	72-4767M	72-4767L	72-4767X		
J Silver/Violet	72-4768XS	72-4768S	72-4768M	72-4768L	72-4768X		

See pages 1135-1144 for replacement parts



# GM-32 OPEN FACE HELMET WITH FLIP DOWN SUN SHIELD



The GM-32 combines the modern convenience of an internal sun visor with the versatility of a three snap visor system. A Coolmax interior and 100% UV400 tinted shield are also included for those extra sunny days.



Shield up



E

Shield down



- DOT approved
- GMAX flow thru intake/exhaust venting that helps pull in desired fresh air and remove unwanted hot air thru channeled vents
- Removable, adjustable, washable Coolmax® interior allows for easy cleaning and custom fitting
- 3 snap removable visor
- Retractable, tinted inner sun shield that is easily raised and lowered by a side mounted lever also with 100% UV400 protection and anti-fog coating
- 100% UV400 resistant shield comes anti-scratch hard coated for a longer lasting clear view
- Vents and inner sun shield are easily controlled with a gloved hand
- Flip-up double lens available P/N **72-0017**
- Flip-up single lens available P/N **72-0015**



A

B

C

D

F

	Color	XS	S	M	L	X	2X	3X
A	Black	72-4920XS	72-4920S	72-4920M	72-4920L	72-4920X	72-49202X	72-49203X
B	Matte Black	72-4921XS	72-4921S	72-4921M	72-4921L	72-4921X	72-49212X	72-49213X
C	Titanium	72-4922XS	72-4922S	72-4922M	72-4922L	72-4922X	72-49222X	72-49223X
D	Blue	72-4923XS	72-4923S	72-4923M	72-4923L	72-4923X	72-49232X	72-49233X
E	Pearl White	72-4924XS	72-4924S	72-4924M	72-4924L	72-4924X	72-49242X	72-49243X
F	Candy Red	72-4925XS	72-4925S	72-4925M	72-4925L	72-4925X	72-49252X	72-49253X

See pages 1135-1144 for replacement parts

- WINDSHIELDS / FAIRINGS
- AUDIO / COMMUNICATION
- SEATS / LUGGAGE
- BARS / MIRRORS / CONTROLS
- EXHAUST
- AIR / FUEL SYSTEMS
- ENGINE
- TRANSMISSION / DRIVELINE
- GASKETS / SEALS
- ELECTRICAL
- LIGHTING
- CABLES
- BRAKES
- OIL FILTERS
- SUSPENSION
- BODY
- WHEELS
- TIRES / TIRE ACC.
- BIKE ACC.
- VICTORY / INDIAN
- COVERS / LOCKS / TIEDOWNS
- CHEMICALS
- TOOLS
- HELMETS
- HELMET ACC.
- EYEWEAR
- APPAREL / RIDER ACC.
- PROMOTIONAL
- REFERENCE
- INDEX



**OF-17 OPEN FACE MOTORCYCLE/SCOOTER HELMET**



The GMAX GM-17 offers many of the features of our premium open face helmets at a price to fit any budget. As with all GMAX helmets, a Coolmax interior is standard as well as a 100% UV400 protective face shield. You also have the option of running it with a sun visor for around town or for those days wind you just want to feel the wind on your face.

- DOT approved
- DuPont Coolmax® interior keeps you dry and comfortable. Coolmax® wicks moisture away from your body and dries quickly
- Removable, adjustable, washable Coolmax® interior allows for easy cleaning and custom fitting
- Industry leading eight vents, including new GMAX® top and rear vents with premium SPC vented EPS and interior engineered for maximum air flow control
- 100% UV400 resistant face shield comes anti-scratched hard coated for a longer lasting clear view
- Speaker pockets for easy communication system installation
- Optional outer flip tint lenses
- Optional sun visor available P/N 72-0841



	Graphic/Color	XS	S	M	L	X	2X	3X
A	Gloss Black	72-4810XS	72-4810S	72-4810M	72-4810L	72-4810X	72-48102X	72-48103X
B	Matte Black	72-4811XS	72-4811S	72-4811M	72-4811L	72-4811X	72-48112X	72-48113X
C	Titanium	72-4812XS	72-4812S	72-4812M	72-4812L	72-4812X	72-48122X	72-48123X
D	Blue	72-4813XS	72-4813S	72-4813M	72-4813L	72-4813X	72-48132X	72-48133X
E	Candy Red Metallic	72-4815XS	72-4815S	72-4815M	72-4815L	72-4815X	72-48152X	72-48153X
F	Dark Silver Metallic	72-4818XS	72-4818S	72-4818M	72-4818L	72-4818X	72-48182X	72-48183X
G	Pearl White Metallic	72-4814XS	72-4814S	72-4814M	72-4814L	72-4814X	72-48142X	72-48143X
H	Wine Red Metallic	72-4816XS	72-4816S	72-4816M	72-4816L	72-4816X	72-48162X	72-48163X

See pages 1135-1144 for replacement parts

# GM-2 OPEN FACE HELMET



The GM-2 is our most traditional 3/4 helmet. The three snap design allows for a variety of shields and visors to be installed. With adult and youth sizes available, the GM-2 is ready for affordable family fun.

- DOT approved
- Deluxe ear pockets for better fit and comfort
- Different shell sizes allow for a full range of adult and youth sizes and a superior fit
- Adjustable forehead vent
- 3-snap visor
- Optional double lens shields available P/N 72-0017
- Optional flip-up shield available P/N 72-0015



H



A



B



C



D



E

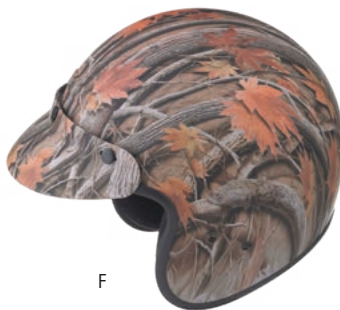

F



G

	Color	Y S/M	Y L/X
<b>YOUTH</b>			
A	Blue	72-5355YS	72-5355YL
B	Black	72-5350YS	72-5350YL
C	Red	72-5352YS	72-5352YL
D	White	72-5351YS	72-5351YL
E	Wine	72-5353YS	72-5353YL
F	Leaf Camo	72-5356YS	72-5356YL
G	ATV Flat Green	72-5358YS	72-5358YL
H	Matte Black	72-5359YS	72-5359YL

	Color	XS	S	M	L	X	2X	3X	4X
<b>ADULT</b>									
A	Blue	72-5355XS	72-5355S	72-5355M	72-5355L	72-5355X	72-5355XX		
B	Black	72-5350XS	72-5350S	72-5350M	72-5350L	72-5350X	72-5350XX	72-5350XXX	72-5350XXXX
C	Red	72-5352XS	72-5352S	72-5352M	72-5352L	72-5352X	72-5352XX		
D	White	72-5351XS	72-5351S	72-5351M	72-5351L	72-5351X	72-5351XX		
E	Wine	72-5353XS	72-5353S	72-5353M	72-5353L	72-5353X	72-5353XX		
F	Leaf Camo	72-5356XS	72-5356S	72-5356M	72-5356L	72-5356X	72-5356XX		
G	ATV Flat Green	72-5358XS	72-5358S	72-5358M	72-5358L	72-5358X	72-5358XX		
H	Matte Black	72-5359XS	72-5359S	72-5359M	72-5359L	72-5359X	72-5359XX		

See pages 1135-1144 for replacement parts

- WINDSHIELDS / FAIRINGS
- AUDIO / COMMUNICATION
- SEATS / LUGGAGE
- BARS / MIRRORS / CONTROLS
- EXHAUST
- AIR / FUEL SYSTEMS
- ENGINE
- TRANSMISSION / DRIVELINE
- GASKETS / SEALS
- ELECTRICAL
- LIGHTING
- CABLES
- BRAKES
- OIL FILTERS
- SUSPENSION
- BODY
- WHEELS
- TIRES / TIRE ACC.
- BIKE ACC.
- VICTORY / INDIAN
- COVERS / LOCKS / TIEDOWNS
- CHEMICALS
- TOOLS
- HELMETS**
- HELMET ACC.
- EYEWEAR
- APPAREL / RIDER ACC.
- PROMOTIONAL
- REFERENCE
- INDEX



## GM-65 FULL DRESS HALF HELMET

The GM-65 Full Dressed is the most feature packed half helmet on the market. From its internal sunshade to its dual density EPS, no other half helmet can compare to the GM-65's long list of standard features.

- **DOT approved**
- DuPont Coolmax® interior keeps you dry and comfortable. Coolmax® wicks moisture away from your body and dries quickly
- Removable Coolmax® interior allows for easy cleaning
- Premium venting reduces heat at the top of the head. Comfort liner, shell and EPS designed for maximum venting
- Helmet comes with two retractable, hard coated 100% UV400 resistant sun shields that are designed for a quick and tool-less removal and replacement. One clear and one dark smoke tinted
- Removable, snap in neck curtain keeps you warm during cool weather riding. Includes pockets for intercom speakers
- "Dual-density EPS technology" allows for a low profile look and fit
- Optional high definition sun shield available. (Must use helmet size specific shield)
- Optional/Replacement shields available



- Tint XS-M P/N: **72-1730**; L-2X P/N: **72-1731**
- Hi-Def Amber XS-M P/N: **72-1732**; L-2X P/N: **72-1733**
- Clear XS-M P/N: **72-1734**; L-2X P/N: **72-1735**
- Yellow XS-M P/N: **72-1736**; L-2X P/N: **72-1737**



Model/Graphic	XS	S	M	L	X	2X
<b>SOLIDS</b>						
A Gloss Black	<b>72-5640XS</b>	<b>72-5640S</b>	<b>72-5640M</b>	<b>72-5640L</b>	<b>72-5640X</b>	<b>72-56402X</b>
B Matte Black	<b>72-5641XS</b>	<b>72-5641S</b>	<b>72-5641M</b>	<b>72-5641L</b>	<b>72-5641X</b>	<b>72-56412X</b>
C Matte White	<b>72-5642XS</b>	<b>72-5642S</b>	<b>72-5642M</b>	<b>72-5642L</b>	<b>72-5642X</b>	<b>72-56422X</b>
<b>GRAPHICS</b>						
D Twin Matte Black/Silver	<b>72-5645XS</b>	<b>72-5645S</b>	<b>72-5645M</b>	<b>72-5645L</b>	<b>72-5645X</b>	<b>72-56452X</b>
E Twin Matte Black/Pink	<b>72-5646XS</b>	<b>72-5646S</b>	<b>72-5646M</b>	<b>72-5646L</b>	<b>72-5646X</b>	

See pages 1135-1144 for replacement parts

# GM-65 NAKED HALF HELMET



The GM-65S Naked is the alter ego to our Full Dress model. For those riders who want a cleaner modern look but do not want give up all of the features of the Full Dress, the naked has you covered.



G

- **DOT Approved**
- DuPont Coolmax® interior keeps you dry and comfortable. Coolmax® wicks moisture away from your body and dries quickly
- Removable, washable Coolmax® interior allows for easy cleaning
- Premium venting reduces heat at the top of the head. Comfort liner, shell, and EPS are designed for maximum ventilation
- Helmet comes with two retractable, hard coated, 100% UV400 resistant sun shields that are designed for a quick and tool-less removal and replacement. One clear and one dark smoke tinted
- Snap in rear neck curtain keeps you warm during cool weather riding. Includes pockets for intercom speakers
- "Dual-density EPS technology" allows for a low profile look and fit
- Optional high definition sun shield available. (Must use helmet size specific shield)
- Optional/Replacement shields available

Tint XS-M P/N: **72-1730**; L-2X P/N: **72-1731**  
 Hi-Def Amber XS-M P/N: **72-1732**; L-2X P/N: **72-1733**  
 Clear XS-M P/N: **72-1734**; L-2X P/N: **72-1735**  
 Yellow XS-M P/N: **72-1736**; L-2X P/N: **72-1737**



Model/Graphic		XS	S	M	L	X	2X
<b>SOLIDS</b>							
A	Gloss Black	72-5630XS	72-5630S	72-5630M	72-5630L	72-5630X	72-56302X
B	Matte Black	72-5631XS	72-5631S	72-5631M	72-5631L	72-5631X	72-56312X
C	Matte White	72-5632XS	72-5632S	72-5632M	72-5632L	72-5632X	72-56322X
<b>GRAPHICS</b>							
D	Devotion Matte Black	72-5667XS	72-5667S	72-5667M	72-5667L	72-5667X	72-56672X
E	Ghost/RIP Matte Black/Silver	72-5636XS	72-5636S	72-5636M	72-5636L	72-5636X	72-56362X
F	PIN Matte Black/Silver	72-5660XS	72-5660S	72-5660M	72-5660L	72-5660X	72-56602X
G	Ritual Matte Black	72-5668XS	72-5668S	72-5668M	72-5668L	72-5668X	72-56682X
H	Rose Matte Black/Silver	72-5637XS	72-5637S	72-5637M	72-5637L	72-5637X	
I	Tormentor Matte Black/Silver	72-5635XS	72-5635S	72-5635M	72-5635L	72-5635X	72-56352X
J	Torque Matte Black/Pink	72-5666XS	72-5666S	72-5666M	72-5666L	72-5666X	
K	Torque Matte Black/Silver	72-5665XS	72-5665S	72-5665M	72-5665L	72-5665X	72-56652X

See pages 1135-1144 for replacement parts

- WINDSHIELDS / FAIRINGS
- AUDIO / COMMUNICATION
- SEATS / LUGGAGE
- BARS / MIRRORS / CONTROLS
- EXHAUST
- AIR / FUEL SYSTEMS
- ENGINE
- TRANSMISSION / DRIVELINE
- GASKETS / SEALS
- ELECTRICAL
- LIGHTING
- CABLES
- BRAKES
- OIL FILTERS
- SUSPENSION
- BODY
- WHEELS
- TIRES / TIRE ACC.
- BIKE ACC.
- VICTORY / INDIAN
- COVERS / LOCKS / TIEDOWNS
- CHEMICALS
- TOOLS
- HELMETS**
- HELMET ACC.
- EYEWEAR
- APPAREL / RIDER ACC.
- PROMOTIONAL
- REFERENCE
- INDEX



**GM-45 HALF HELMET**

The GM-45 is our bare knuckled no frills helmet. We dropped the extras of the GM65 without leaving out what really matters. All of the quality of our premium half helmets in a lightweight low profile package

- DOT approved
- Removable, washable Coolmax® interior allows for easy cleaning
- Comfort liner, shell and EPS designed for maximum venting without reducing the integrity of the helmet



	Color	XS	S	M	L	X	2X
A	Naked Gloss Black	72-6430XS	72-6430S	72-6430M	72-6430L	72-6430X	72-6430XX
B	Naked Matte Black	72-6431XS	72-6431S	72-6431M	72-6431L	72-6431X	72-6431XX

**GM-35 HALF HELMET - FULLY DRESSED**

With its three snap visor, the GM-35 is one of our most versatile helmets. You can choose between a traditional cruiser look with its included sun visor and neck curtain or opt for the naked look by removing both. The three snap gives you the option of installing a variety of shields and visors to suite your personal style and riding conditions.

- DOT approved
- DuPont Coolmax® interior keeps you dry and comfortable. Coolmax® wicks moisture away from your body and dries quickly
- Adjustable forehead vent for increased ventilation
- Removable neck curtain for cold days also has pockets for intercom
- Snap on sun visor allows for a variety of shields and visors to be installed



	Graphic	XS	S	M	L	X	2X	3X
A	Matte Black	72-5421XS	72-5421S	72-5421M	72-5421L	72-5421X	72-5421XX	
B	Black	72-5420XS	72-5420S	72-5420M	72-5420L	72-5420X	72-5420XX	
C	Pearl White	72-5422XS	72-5422S	72-5422M	72-5422L	72-5422X	72-5422XX	
D	Derk Matte Black/Silver	72-5424XS	72-5424S	72-5424M	72-5424L	72-5424X	72-5424XX	72-54243X

See pages 1135-1144 for replacement parts

**EXO-R2000** **NEW**



Featuring Scorpion's TCT® composite shell construction, the lightweight EXO-R2000 was engineered with input from MotoGP™ riders, tested both on the track and the lab. This is our top of the line helmet and includes the Ellip-Tec™ ratchet system that ensures a tight seal around the face shield while the aero-tuned ventilation system enhances airflow throughout the helmet. The aerodynamic shell design minimizes high-speed buffeting, six EPS shell sizes and the Airfit® cheek pad system delivers a customizable snug fit. The EXO-R2000 is also equipped with quick release cheek pad system and an Everclear® no-fog coated face shield. Pinlock® Maxvision® flat shields with tear off posts are also available as an accessory for the track.



- 5 Year warranty
- DOT/Snell Certified
- TCT lightweight composite shell with dual density EPS
- Aero-tuned ventilation
- Everclear® No-fog face shield w/ vent/lock lever and Ellip-Tec™ ratchet system
- Quick release cheek pad system
- Kwikwick® II washable anti-microbial comfort liner
- Kwikfit® cheek pads accommodate eyeglasses and Airfit® inflation system
- Includes a dark smoke face shield



A



B



C



D



E



F



G



H

Graphic/Color	XS	S	M	L	X	2X
A Matte Black	75-1000XS	75-1000S	75-1000M	75-1000L	75-1000X	75-10002X
B White	75-1001XS	75-1001S	75-1001M	75-1001L	75-1001X	75-10012X
C Gloss Black	75-1002XS	75-1002S	75-1002M	75-1002L	75-1002X	75-10022X
D Fortis Black/Neon	75-1007XS	75-1007S	75-1007M	75-1007L	75-1007X	75-10072X
E Fortis Black/Red	75-1006XS	75-1006S	75-1006M	75-1006L	75-1006X	75-10062X
F Fortis White/Orange	75-1005XS	75-1005S	75-1005M	75-1005L	75-1005X	75-10052X
G Ravin Neon	75-1009XS	75-1009S	75-1009M	75-1009L	75-1009X	75-10092X
H Ravin Phantom	75-1008XS	75-1008S	75-1008M	75-1008L	75-1008X	75-10082X
I Tagger Ensenada Black/Orange	75-1010XS	75-1010S	75-1010M	75-1010L	75-1010X	75-10102X

See pages 1135-1144 for replacement parts

- WINDSHIELDS / FAIRINGS
- AUDIO / COMMUNICATION
- SEATS / LUGGAGE
- BARS / MIRRORS / CONTROLS
- EXHAUST
- AIR / FUEL SYSTEMS
- ENGINE
- TRANSMISSION / DRIVELINE
- GASKETS / SEALS
- ELECTRICAL
- LIGHTING
- CABLES
- BRAKES
- OIL FILTERS
- SUSPENSION
- BODY
- WHEELS
- TIRES / TIRE ACC.
- BIKE ACC.
- VICTORY / INDIAN
- COVERS / LOCKS / TIEDOWNS
- CHEMICALS
- TOOLS
- HELMETS**
- HELMET ACC.
- EYEWEAR
- APPAREL / RIDER ACC.
- PROMOTIONAL
- REFERENCE
- INDEX



**NEW** EXO-T1200

Combining MotoGP™ inspired technology with the demands of long-distance riders, the EXO-T1200 is an ideal solution for touring riders who demand premium features in a full-coverage helmet. Starting with an aerodynamic profile for stability at speeds, the VSV™ ventilation system is designed for maximum airflow and is the reason the T-1200 has gained a reputation as the best ventilated helmet on the market. The external shell is made of our proprietary TCT® composite fiber for strength. The interior liner features our Airfit® cheek pad inflation system for custom fit and comfort. The internal Everclear® Speedview® drop-down sun visor is convenient when riding in bright sunlight. For long distance, all day touring, the T-1200 is an excellent choice. Clear face shield included, dark smoke and other face shield options are sold separately. Pinlock® Maxvision® flat shields with tear off posts are also available as an accessory for the track.

- 5 Year warranty
- DOT
- TCT lightweight composite shell with dual density EPS
- 3-Step Everclear® Speedview® drop down sun visor
- Everclear® No-fog face shield with vent/lock lever and Ellip-Tec™ ratchet system
- Quick release cheek pad system
- Communication speaker pockets
- VSV™ (Venturi super vent) ventilation system
- Kwikwick® III washable anti-microbial comfort liner
- Kwikfit® cheek pads accommodate eyeglasses and Airfit® inflation system



Graphic/Color	XS	S	M	L	X	2X
A Matte Black	75-1020XS	75-1020S	75-1020M	75-1020L	75-1020X	75-10202X
B White	75-1021XS	75-1021S	75-1021M	75-1021L	75-1021X	75-10212X
C Gloss Black	75-1022XS	75-1022S	75-1022M	75-1022L	75-1022X	75-10222X
D Alias Neon	75-1029XS	75-1029S	75-1029M	75-1029L	75-1029X	75-10292X
E Alias Phantom	75-1027XS	75-1027S	75-1027M	75-1027L	75-1027X	75-10272X
F Alias Red	75-1028XS	75-1028S	75-1028M	75-1028L	75-1028X	75-10282X
G Freeway Black	75-1030XS	75-1030S	75-1030M	75-1030L	75-1030X	75-10302X
H Freeway White	75-1031XS	75-1031S	75-1031M	75-1031L	75-1031X	75-10312X
I Mainstay Black/Silver	75-1025XS	75-1025S	75-1025M	75-1025L	75-1025X	75-10252X
J Mainstay Neon	75-1026XS	75-1026S	75-1026M	75-1026L	75-1026X	75-10262X
K Mainstay White/Blue	75-1024XS	75-1024S	75-1024M	75-1024L	75-1024X	75-10242X

See pages 1135-1144 for replacement parts



EXO-R710 **NEW**



The Scorpion EXO-R710 combines MotoGP™. Advanced features include the fiber-glass / aramid tri-matrix shell, Ellip-Tec® ratchet system, Everclear® no-fog face shield and quick release cheek pads. this feature packed helmet is equally at home when used for daily commuting, carving in the canyons, or during closed course competitions. it's been called the world's best fiberglass helmet. Clear face shield included, dark smoke face shield sold separately, other shield options available. Pinlock® Maxvision® flat shields with tear off posts are also available as an accessory for the track.



- 5 Year warranty
- DOT/Snell Certified
- Fiberglass/Tri-Matrix shell with dual density EPS
- Everclear® No-fog face shield w/ vent/lock lever and Ellip-Tec™ ratchet system
- Aero-tuned ventilation
- Quick release cheek pad system
- Communication system speaker pockets
- Kwikwick® II washable anti-microbial comfort liner
- Kwikfit® cheek pads accommodate eyeglasses



J



Graphic/Color	XS	S	M	L	X	2X	3X
A Matte Black	75-1040XS	75-1040S	75-1040M	75-1040L	75-1040X	75-10402X	75-10403X
B White	75-1041XS	75-1041S	75-1041M	75-1041L	75-1041X	75-10412X	75-10413X
C Gloss Black	75-1042XS	75-1042S	75-1042M	75-1042L	75-1042X	75-10422X	75-10423X
D Focus Red	75-1051XS	75-1051S	75-1051M	75-1051L	75-1051X	75-10512X	75-10513X
E Focus Silver	75-1050XS	75-1050S	75-1050M	75-1050L	75-1050X	75-10502X	75-10503X
F Fuji Blue	75-1047XS	75-1047S	75-1047M	75-1047L	75-1047X	75-10472X	
G Fuji Neon	75-1048XS	75-1048S	75-1048M	75-1048L	75-1048X	75-10482X	
H Golden State Black/Gold	75-1054XS	75-1054S	75-1054M	75-1054L	75-1054X	75-10542X	75-10543X
I Transect Hi-Vis	75-1046XS	75-1046S	75-1046M	75-1046L	75-1046X	75-10462X	
J Transect Red	75-1044XS	75-1044S	75-1044M	75-1044L	75-1044X	75-10442X	
K Transect Silver	75-1045XS	75-1045S	75-1045M	75-1045L	75-1045X	75-10452X	

See pages 1135-1144 for replacement parts

- WINDSHIELDS / FAIRINGS
- AUDIO / COMMUNICATION
- SEATS / LUGGAGE
- BARS / MIRRORS / CONTROLS
- EXHAUST
- AIR / FUEL SYSTEMS
- ENGINE
- TRANSMISSION / DRIVELINE
- GASKETS / SEALS
- ELECTRICAL
- LIGHTING
- CABLES
- BRAKES
- OIL FILTERS
- SUSPENSION
- BODY
- WHEELS
- TIRES / TIRE ACC.
- BIKE ACC.
- VICTORY / INDIAN
- COVERS / LOCKS / TIEDOWNS
- CHEMICALS
- TOOLS
- HELMETS**
- HELMET ACC.
- EYEWEAR
- APPAREL / RIDER ACC.
- PROMOTIONAL
- REFERENCE
- INDEX



**NEW** EXO-T510

The EXO-T510 is the next evolution of a fully featured road helmet. It now has a new shell with a more aggressive aerodynamic shape, and an improved ventilation system. It's packed with features that riders want like the Ellip-Tec® airtight/watertight face shield system, Airfit® adjustable cheek pads, Speedview® internal drop down sun visor and Everclear® anti-fog coatings. The Scorpion EXO-T510 leaves the competition behind.

- DOT Certified
- Advanced LG® polycarbonate shell
- Aero-tuned ventilation
- Everclear® no-fog Speedview® drop down sunvisor
- Ellip-tec™ ratchet system w/ face shield vent/lock lever
- Communication system speaker pockets
- Kwikwick® II washable anti-microbial comfort liner
- Kwikfit® cheek pads accommodate eyeglasses and Airfit® inflation system



Graphic/Color	XS	S	M	L	X	2X
A Matte Black	75-1060XS	75-1060S	75-1060M	75-1060L	75-1060X	75-10602X
B White	75-1061XS	75-1061S	75-1061M	75-1061L	75-1061X	75-10612X
C Gloss Black	75-1062XS	75-1062S	75-1062M	75-1062L	75-1062X	75-10622X
D Neon	75-1080XS	75-1080S	75-1080M	75-1080L	75-1080X	75-10802X
E Azalea Black/Gold	75-1068XS	75-1068S	75-1068M	75-1068L	75-1068X	75-10682X
F Azalea White/Silver	75-1069XS	75-1069S	75-1069M	75-1069L	75-1069X	75-10692X
G Cipher Black/Gold	75-1064XS	75-1064S	75-1064M	75-1064L	75-1064X	75-10642X
H Cipher Green	75-1066XS	75-1066S	75-1066M	75-1066L	75-1066X	75-10662X
I Cipher White	75-1065XS	75-1065S	75-1065M	75-1065L	75-1065X	75-10652X

See pages 1135-1144 for replacement parts

EXO-T510 **NEW**



The EXO-T510 is the next evolution of a fully featured road helmet. It now has a new shell with a more aggressive aerodynamic shape, and an improved ventilation system. It's packed with features that riders want like the Ellip-Tec® airtight/watertight face shield system, Airfit® adjustable cheek pads, Speedview® internal drop down sun visor and Everclear® anti-fog coatings. The Scorpion EXO-T510 leaves the competition behind.



Graphic/Color	XS	S	M	L	X	2X
J Fury Black/Pink	75-1077XS	75-1077S	75-1077M	75-1077L	75-1077X	75-10772X
K Fury Black/Red	75-1078XS	75-1078S	75-1078M	75-1078L	75-1078X	75-10782X
L Fury White/Silver	75-1079XS	75-1079S	75-1079M	75-1079L	75-1079X	75-10792X
M Nexus Neon/Black	75-1070XS	75-1070S	75-1070M	75-1070L	75-1070X	75-10702X
N Nexus Red/Black	75-1072XS	75-1072S	75-1072M	75-1072L	75-1072X	75-10722X
O Nexus White/Black	75-1071XS	75-1071S	75-1071M	75-1071L	75-1071X	75-10712X
P Tarmac Blue/Black	75-1074XS	75-1074S	75-1074M	75-1074L	75-1074X	75-10742X
Q Tarmac Neon/Black	75-1075XS	75-1075S	75-1075M	75-1075L	75-1075X	75-10752X
R Tarmac Red/Blue	75-1076XS	75-1076S	75-1076M	75-1076L	75-1076X	75-10762X

See pages 1135-1144 for replacement parts

- WINDSHIELDS / FAIRINGS
- AUDIO / COMMUNICATION
- SEATS / LUGGAGE
- BARS / MIRRORS / CONTROLS
- EXHAUST
- AIR / FUEL SYSTEMS
- ENGINE
- TRANSMISSION / DRIVELINE
- GASKETS / SEALS
- ELECTRICAL
- LIGHTING
- CABLES
- BRAKES
- OIL FILTERS
- SUSPENSION
- BODY
- WHEELS
- TIRES / TIRE ACC.
- BIKE ACC.
- VICTORY / INDIAN
- COVERS / LOCKS / TIEDOWNS
- CHEMICALS
- TOOLS
- HELMETS**
- HELMET ACC.
- EYEWEAR
- APPAREL / RIDER ACC.
- PROMOTIONAL
- REFERENCE
- INDEX



**NEW** EXO-R420

The EXO-R420 helmet continues to set a new standard for Scorpion EXO®'s full face street helmets at a very competitive price point. An all new shell is more aerodynamic and smaller resulting in an ultra-lightweight Snell-approved helmet. The ventilation system uses a large top vent and mouth vents engineered to allow more airflow to the rider's head while maintaining low noise levels. The EXO-R420 now features our new Ellip-tec™ II face shield with a latching shield locking mechanism located in the lower center of the shield. This makes the face shield more secure and provides a tighter seal against the gasket. The face shield can easily be removed without tools.

- DOT/Snell Certified
- Ultra-lightweight advanced LG® polycarbonate shell
- Aero-tuned ventilation
- Ellip-tec™ II face shield w/ Everclear® no-fog coating
- Kwikwick® II washable anti-microbial comfort liner
- Kwikfit® cheek pads accommodate eyeglasses
- 3X and 4X sizes are DOT Certified only



Graphic/Color	XS	S	M	L	X	2X	3X	4X
A Gloss Black	75-1120XS	75-1120S	75-1120M	75-1120L	75-1120X	75-11202X	75-11203X	
B Matte Black	75-1121XS	75-1121S	75-1121M	75-1121L	75-1121X	75-11212X	75-11213X	75-11214X
C White	75-1122XS	75-1122S	75-1122M	75-1122L	75-1122X	75-11222X	75-11223X	
D Matte Titanium	75-1123XS	75-1123S	75-1123M	75-1123L	75-1123X	75-11232X	75-11233X	
E Shake Cement Grey	75-1133XS	75-1133S	75-1133M	75-1133L	75-1133X	75-11332X	75-11333X	
F Shake Matte Gold	75-1134XS	75-1134S	75-1134M	75-1134L	75-1134X	75-11342X	75-11343X	
G Shake Matte White	75-1135XS	75-1135S	75-1135M	75-1135L	75-1135X	75-11352X	75-11353X	

See pages 1135-1144 for replacement parts

EXO-R420 **NEW**



The EXO-R420 helmet continues to set a new standard for Scorpion EXO®'s full face street helmets at a very competitive price point. An all new shell is more aerodynamic and smaller resulting in an ultra-lightweight Snell-approved helmet. The ventilation system uses a large top vent and mouth vents engineered to allow more airflow to the rider's head while maintaining low noise levels. The EXO-R420 now features our new Ellip-tec™ II face shield with a latching shield locking mechanism located in the lower center of the shield. this makes the face shield more secure and provides a tighter seal against the gasket. the face shield can easily be removed without tools.



Graphic/Color	XS	S	M	L	X	2X	3X	4X
H Sugarskull Black/Gold	75-1137XS	75-1137S	75-1137M	75-1137L	75-1137X	75-11372X		
I Sugarskull Black/Pink	75-1136XS	75-1136S	75-1136M	75-1136L	75-1136X	75-11362X		
J Techno Matte Phantom	75-1125XS	75-1125S	75-1125M	75-1125L	75-1125X	75-11252X	75-11253X	
K Techno Matte Titanium	75-1126XS	75-1126S	75-1126M	75-1126L	75-1126X	75-11262X	75-11263X	
L Techno White/Red	75-1127XS	75-1127S	75-1127M	75-1127L	75-1127X	75-11272X	75-11273X	
M Tracker Matte Titanium/Black	75-1130XS	75-1130S	75-1130M	75-1130L	75-1130X	75-11302X	75-11303X	
N Tracker Matte White/Neon	75-1132XS	75-1132S	75-1132M	75-1132L	75-1132X	75-11322X	75-11323X	
O Tracker Red/White/Blue	75-1131XS	75-1131S	75-1131M	75-1131L	75-1131X	75-11312X	75-11313X	

See pages 1135-1144 for replacement parts

- WINDSHIELDS / FAIRINGS
- AUDIO / COMMUNICATION
- SEATS / LUGGAGE
- BARS / MIRRORS / CONTROLS
- EXHAUST
- AIR / FUEL SYSTEMS
- ENGINE
- TRANSMISSION / DRIVELINE
- GASKETS / SEALS
- ELECTRICAL
- LIGHTING
- CABLES
- BRAKES
- OIL FILTERS
- SUSPENSION
- BODY
- WHEELS
- TIRES / TIRE ACC.
- BIKE ACC.
- VICTORY / INDIAN
- COVERS / LOCKS / TIEDOWNS
- CHEMICALS
- TOOLS
- HELMETS**
- HELMET ACC.
- EYEWEAR
- APPAREL / RIDER ACC.
- PROMOTIONAL
- REFERENCE
- INDEX



**EXO-R320** **NEW**

A LG® polycarbonate shell and dual density EPS result in a lightweight and safe DOT approved full face helmet. The KwikWick® II liner is moisture wicking, anti-microbial, quick drying and can be easily removed and is machine washable. Aero tuned vents on the top and front of the helmet offer excellent ventilation. The Ellip-Tec® Pinlock® ready face shield can be easily removed without tools.

- DOT Certified
- Advanced LG® polycarbonate shell
- Ellip-Tec® ratchet system
- Pinlock® ready face shield (Inserts sold separately)
- KwikWick® II washable anti-microbial comfort liner
- Aero-Tuned ventilation system
- KwikFit® cheek pads accommodate eyeglasses
- Communication system speaker pockets



J



A



B



C



D



E



F



G



H



I

Graphic/Color	XS	S	M	L	X	2X
A Black	75-1140XS	75-1140S	75-1140M	75-1140L	75-1140X	75-11402X
B Matte Black	75-1141XS	75-1141S	75-1141M	75-1141L	75-1141X	75-11412X
C White	75-1142XS	75-1142S	75-1142M	75-1142L	75-1142X	75-11422X
D Dream Black	75-1149XS	75-1149S	75-1149M	75-1149L	75-1149X	75-11492X
E Dream White	75-1148XS	75-1148S	75-1148M	75-1148L	75-1148X	75-11482X
F Endeavor Black/Orange	75-1154XS	75-1154S	75-1154M	75-1154L	75-1154X	75-11542X
G Endeavor Grey/Silver	75-1153XS	75-1153S	75-1153M	75-1153L	75-1153X	75-11532X
H Endeavor White/Neon	75-1152XS	75-1152S	75-1152M	75-1152L	75-1152X	75-11522X
I Endeavor White/Red	75-1151XS	75-1151S	75-1151M	75-1151L	75-1151X	75-11512X
J Moto Fink Titanium	75-1146XS	75-1146S	75-1146M	75-1146L	75-1146X	75-11462X

**NEW** EXO-GT3000



According to the experts the EXO-GT3000 is in a class by itself in the highly competitive fiberglass modular helmet category. It's impressive list of features starts with the shell that offers light weight combined with an extremely aerodynamic profile. Also included are features such as Scorpion EXO's Airfit® liner inflation system for a customizable fit, drop-down sun visor for different light conditions, and face shield. Additionally, the helmet easily accommodates most bluetooth communications systems including the new BMW systems. Easy one handed operation of the chin bar and face shield, results in ease of opening and a positive lock upon closure. From top to bottom, the EXO-GT3000 provides premium comfort, protection and function.



- DOT Certified
- TCT – Ultra pre-preg lightweight shell
- Aero-tuned ventilation system
- Everclear® no-fog Speedview® drop down sunvisor
- Kwikwick® III washable anti-microbial comfort liner w/ 3D contoured cheek pads
- Kwikfit® cheek pads accommodate eyeglasses and Airfit® inflation system



Graphic/Color	XS	S	M	L	X	2X
A Matte Black	75-1400XS	75-1400S	75-1400M	75-1400L	75-1400X	75-14002X
B Pearl White	75-1401XS	75-1401S	75-1401M	75-1401L	75-1401X	75-14012X
C Hypersilver	75-1402XS	75-1402S	75-1402M	75-1402L	75-1402X	75-14022X
D Black	75-1403XS	75-1403S	75-1403M	75-1403L	75-1403X	75-14032X
E Sync Matte Gray/Orange	75-1405XS	75-1405S	75-1405M	75-1405L	75-1405X	75-14052X
F Sync Matte White/Red/Blue	75-1404XS	75-1404S	75-1404M	75-1404L	75-1404X	75-14042X

See pages 1135-1144 for replacement parts

- WINDSHIELDS / FAIRINGS
- AUDIO / COMMUNICATION
- SEATS / LUGGAGE
- BAR / MIRRORS / CONTROLS
- EXHAUST
- AIR / FUEL SYSTEMS
- ENGINE
- TRANSMISSION / DRIVELINE
- GASKETS / SEALS
- ELECTRICAL
- LIGHTING
- CABLES
- BRAKES
- OIL FILTERS
- SUSPENSION
- BODY
- WHEELS
- TIRES / TIRE ACC.
- BIKE ACC.
- VICTORY / INDIAN
- COVERS / LOCKS / TIEDOWNS
- CHEMICALS
- TOOLS
- HELMETS**
- HELMET ACC.
- EYEWEAR
- APPAREL / RIDER ACC.
- PROMOTIONAL
- REFERENCE
- INDEX



**EXO-GT920** **NEW**

The dynamic EXO-GT920 modular helmet benefits from an aggressively shaped aerodynamic shell made of advanced LG® polycarbonate for light weight and strength, and features a modular chin bar. It is also packed with key features that exceed the demands of discerning riders including unique drop-down sun visor for bright daylight conditions, moisture wicking management and comfort as well as great ventilation to keep you cool on hot days. DOT Certified

- Easy use flip up chin bar
- Ultra-lightweight advanced LG® polycarbonate shell
- Aero-tuned ventilation
- Kwikwick® II washable anti-microbial comfort liner
- Everclear® Speedview® drop down sun visor
- Communication system speaker pockets
- Ellip-tec™ ratchet face shield w/ Everclear® no-fog coating



Graphic/Color	XS	S	M	L	X	2X	3X
A Matte Black	75-1440XS	75-1440S	75-1440M	75-1440L	75-1440X	75-14402X	75-14403X
B White	75-1441XS	75-1441S	75-1441M	75-1441L	75-1441X	75-14412X	75-14413X
C Black	75-1442XS	75-1442S	75-1442M	75-1442L	75-1442X	75-14422X	75-14423X
D Satellite Black/Red	75-1443XS	75-1443S	75-1443M	75-1443L	75-1443X	75-14432X	75-14433X
E Satellite Neon	75-1445XS	75-1445S	75-1445M	75-1445L	75-1445X	75-14452X	75-14453X
F Satellite Silver	75-1444XS	75-1444S	75-1444M	75-1444L	75-1444X	75-14442X	75-14443X
G Shuttle Matte Black/Red	75-1447XS	75-1447S	75-1447M	75-1447L	75-1447X	75-14472X	75-14473X
H Shuttle Matte Neon	75-1446XS	75-1446S	75-1446M	75-1446L	75-1446X	75-14462X	75-14463X
I Shuttle Matte White/Black	75-1448XS	75-1448S	75-1448M	75-1448L	75-1448X	75-14482X	75-14483X

See pages 1135-1144 for replacement parts



**NEW** **COVERT HELMET**



Meant to disrupt the norm, this radical design can be converted to work with any type of bike. We started with a half helmet and added an integrated drop-down sun visor for protection from sunlight. A rear comfort sleeve allows you to convert the helmet to a ¾ open-face and then attach the included front mask and you've got one, aggressive looking full face helmet.

- DOT Certified
- Versatile 3-in-1 road helmet
- Ultra-lightweight advanced LG® polycarbonate shell
- Aero-tuned ventilation
- Kwikwick® II washable anti-microbial comfort liner
- Everclear® Speedview® drop down sun visor



Graphic/Color	XS	S	M	L	X	2X	3X
A Matte Black	75-1600XS	75-1600S	75-1600M	75-1600L	75-1600X	75-16002X	75-16003X
B White	75-1601XS	75-1601S	75-1601M	75-1601L	75-1601X	75-16012X	75-16013X
C Ratrik Phantom	75-1602XS	75-1602S	75-1602M	75-1602L	75-1602X	75-16022X	75-16023X

See pages 1135-1144 for replacement parts

- WINDSHIELDS / FAIRINGS
- AUDIO / COMMUNICATION
- SEATS / LUGGAGE
- BARS / MIRRORS / CONTROLS
- EXHAUST
- AIR / FUEL SYSTEMS
- ENGINE
- TRANSMISSION / DRIVELINE
- GASKETS / SEALS
- ELECTRICAL
- LIGHTING
- CABLES
- BRAKES
- OIL FILTERS
- SUSPENSION
- BODY
- WHEELS
- TIRES / TIRE ACC.
- BIKE ACC.
- VICTORY / INDIAN
- COVERS / LOCKS / TIEDOWNS
- CHEMICALS
- TOOLS
- HELMETS**
- HELMET ACC.
- EYEWEAR
- APPAREL / RIDER ACC.
- PROMOTIONAL
- REFERENCE
- INDEX



**BELFAST HELMET** **NEW**

Full features are now found in a 3/4 helmet. The Belfast design pays homage to the heritage of the classic 3/4 open face helmet melded with contemporary technology such as the drop-down sun visor and Nappa leather liner. The Belfast is a perfect balance of retro style, modern comfort and state-of-the-art technology.

- DOT Certified
- Hand-laid fiberglass shell
- 3 button snaps
- Hand stitched comfort liner with premium Nappa leather accents
- Speedview® drop down sun visor



	Graphic/Color	XS	S	M	L	X	2X	3X
A	Matte Black	75-1610XS	75-1610S	75-1610M	75-1610L	75-1610X	75-16102X	75-16103X
B	Blanco White	75-1611XS	75-1611S	75-1611M	75-1611L	75-1611X	75-16112X	75-16113X
C	Candy Red	75-1612XS	75-1612S	75-1612M	75-1612L	75-1612X	75-16122X	75-16123X
D	Metallic Blue	75-1613XS	75-1613S	75-1613M	75-1613L	75-1613X	75-16132X	75-16133X

See pages 1135-1144 for replacement parts



**CT220 HELMET**



The EXO-CT220 is designed to offer a modern, protective, comfortable and functional product for riders that need more than a traditional open-face helmet. The versatile EXO-CT220 can be configured with a face shield for blocking head winds, or switch the shield for a sun-blocking visor for more of that wind-in-your-face feel. The face shield is specially designed to reduce turbulence inside the helmet by re-directing the air flow under the helmet instead of the interior.



- DOT Certified
- Removable peak visor
- Ultra-lightweight advanced LG® polycarbonate shell
- Aero-tuned ventilation
- Kwikwick® II washable anti-microbial comfort liner
- 3-step Everclear® Speedview® drop down sun visor
- Communication system speaker pockets
- Kwikfit® cheek pads accommodate eyeglasses



Graphic/Color	XS	S	M	L	X	2X	3X
Matte Black	75-1620XS	75-1620S	75-1620M	75-1620L	75-1620X	75-16202X	75-16203X
White	75-1621XS	75-1621S	75-1621M	75-1621L	75-1621X	75-16212X	75-16213X
Black	75-1622XS	75-1622S	75-1622M	75-1622L	75-1622X	75-16222X	75-16223X
Neon	75-1623XS	75-1623S	75-1623M	75-1623L	75-1623X	75-16232X	75-16233X

[See pages 1135-1144 for replacement parts](#)

- WINDSHIELDS / FAIRINGS
- AUDIO / COMMUNICATION
- SEATS / LUGGAGE
- BARS / MIRRORS / CONTROLS
- EXHAUST
- AIR / FUEL SYSTEMS
- ENGINE
- TRANSMISSION / DRIVELINE
- GASKETS / SEALS
- ELECTRICAL
- LIGHTING
- CABLES
- BRAKES
- OIL FILTERS
- SUSPENSION
- BODY
- WHEELS
- TIRES / TIRE ACC.
- BIKE ACC.
- VICTORY / INDIAN
- COVERS / LOCKS / TIEDOWNS
- CHEMICALS
- TOOLS
- HELMETS**
- HELMET ACC.
- EYEWEAR
- APPAREL / RIDER ACC.
- PROMOTIONAL
- REFERENCE
- INDEX



**NEW** EXO-C110

The EXO-C110 is ScorpionEXO®'s next-generation take on the classic half helmet. Combining subtle modern lines with an advanced ventilation system it not only looks cool, but it cools the head during long rides. A dual-density eps liner that extends down to protect the lower rear skull and an improved sun visor mechanism provides premium touches while maintaining the classic half helmet look and fit. Additionally, a unique chin strap retention design prevents it from rolling forward off of your head.

- DOT Certified
- Ultra-lightweight advanced LG® polycarbonate shell
- Aero-tuned ventilation
- Kwikwick® II washable anti-microbial comfort liner
- Speedview® drop down sun visor
- Peak visor included
- Removable ear flaps have pockets for



Graphic/Color	XS	S	M	L	X	2X	3X
A Matte Black	75-1630XS	75-1630S	75-1630M	75-1630L	75-1630X	75-16302X	75-16303X
B White	75-1631XS	75-1631S	75-1631M	75-1631L	75-1631X	75-16312X	
C Black	75-1632XS	75-1632S	75-1632M	75-1632L	75-1632X	75-16322X	75-16323X
D Hypersilver	75-1633XS	75-1633S	75-1633M	75-1633L	75-1633X	75-16332X	
E Pinstripe Gold/Silver	75-1635XS	75-1635S	75-1635M	75-1635L	75-1635X	75-16352X	
F Azalea Black/Gold	75-1636XS	75-1636S	75-1636M	75-1636L	75-1636X	75-16362X	

See pages 1135-1144 for replacement parts

**CAVALRY BLUETOOTH HALF HELMET**  
 (Communication System Is Built Into Half Helmet)

**SENA**

**Bluetooth™ 4.1**



B



A



**HELMET INFORMATION**

- DOT certified
- Composite fiberglass half shell construction
- Weight- 2.2 lbs (34 oz)
- Aerodynamic, low profile removable visor
- Fully integrated seamless speaker design, HD audio speakers built in and built in microphone
- Removable and washable head liner

**COMMUNICATION SYSTEM**

- Four helmets can talk individually or together (Full Duplex)
- Intercom range up to 1/2 mile (open terrain/ line of sight)
- Light weight and ultra slim profile – great for cruiser riders
- Universal Intercom – intercom with other brands
- Built-in FM Radio tuner, 10 station preset with auto scan
- Bluetooth 4.1 (latest 4th generation Bluetooth)
- Talk time: 10 hours – Stand-by 8 days
- Pairing for mobile phone +GPS
- Voice prompts and Audio Booster
- Bluetooth pairing for two mobile phone for music and calls
- Bluetooth headset for Bluetooth GPS instructions and MP3
- Water resistant for use in inclement weather
- Charge-on-the-Fly (can use while charging)
- Firmware upgradeable for free for life (must register the unit)
- Two-year warranty – Peace of mind!

	Color	XS	S	M	L	X	2X
A	Gloss Black	843-01300XS	843-01300S	843-01300M	843-01300L	843-01300X	843-013002X
B	Matte Black	843-01301XS	843-01301S	843-01301M	843-01301L	843-01301X	843-013012X

- WINDSHIELDS / FAIRINGS
- AUDIO / COMMUNICATION
- SEATS / LUGGAGE
- BAR / MIRRORS / CONTROLS
- EXHAUST
- AIR / FUEL SYSTEMS
- ENGINE
- TRANSMISSION / DRIVELINE
- GASKETS / SEALS
- ELECTRICAL
- LIGHTING
- CABLES
- BRAKES
- OIL FILTERS
- SUSPENSION
- BODY
- WHEELS
- TIRES / TIRE ACC.
- BIKE ACC.
- VICTORY / INDIAN
- COVERS / LOCKS / TIEDOWNS
- CHEMICALS
- TOOLS
- HELMETS**
- HELMET ACC.
- EYEWEAR
- APPAREL / RIDER ACC.
- PROMOTIONAL
- REFERENCE
- INDEX

# SENA MOMENTUM BLUETOOTH INTEGRATED FULL-FACE HELMET



Sena has been at the forefront of Bluetooth innovation for the motorcycle industry for years and is breaking new ground with our first of a kind Bluetooth integrated full-face helmet, Momentum. Sena has engineered this helmet from the ground up and for the first time riders will be able to hear our industry-leading technology the way it was meant to be heard, the ideal integration of Sena's technology creates an unrivaled audio experience. Momentum puts our top of the line and proven 20S technology inside a sleek and safe fiberglass shell. This state of the art helmet was created with riders in mind and is pre installed and ready to ride straight out of the box.

## MOMENTUM 8 BLUETOOTH CONNECTIONS

- DOT / ECE 22.05
- Bluetooth 4.1
- Built-in speakers and micro
- Audio multitasking
- Voice command
- Advanced noise control™
- FM radio
- Eight-way group intercom with distance up to 1.6 km (1 mile)
- Remote control
- Composite fiberglass shell
- Quick release UV and scratch resistant visor
- Removable washable breathable quick dry liner
- Stay connected and control FM presets and speed dials via Sena Headset App (for Android or iPhone)



Color	XS	S	M	L	XL	2X
Glossy White	843-01402XS	843-01402S	843-01402M	843-01402L	843-01402XL	843-014022X
Matte Black	843-01403XS	843-01403S	843-01403M	843-01403L	843-01403XL	843-014032X



**MOMENTUM LITE BLUETOOTH INTEGRATED FULL-FACE HELMET**

**SENA**

The Momentum Lite is our entry-level helmet option, for those not seeking all of bells and whistles outside of a quality Bluetooth helmet. Just like the Momentum and Momentum Pro, the Momentum Lite comes with all of the technology pre installed and ready to ride straight out of the box. The same basic features seen in our 10 series headsets.



**MOMENTUM LITE 4 BLUETOOTH CONNECTIONS**

- DOT / ECE 22.05
- Bluetooth 4.1
- 4-way group intercom with distances up to 1.6 km (1 mile)
- Advance noise control™
- FM Radio
- Up to 20 hours talk time
- Composite fiberglass shell
- Quick release UV and scratch resistant visor
- Removable washable breathable quick dry liner
- Stay connected and control FM presets and speed dials via Sena Headset App (for Android or iPhone)



Color	XS	S	M	L	XL	2XL
Glossy White	843-01400XS	843-01400S	843-01400M	843-01400L	843-01400X	843-014002X
Matte Black	843-01401XS	843-01401S	843-01401M	843-01401L	843-01401X	843-014012X

- WINDSHIELDS / FAIRINGS
- AUDIO / COMMUNICATION
- SEATS / LUGGAGE
- BARS / MIRRORS / CONTROLS
- EXHAUST
- AIR / FUEL SYSTEMS
- ENGINE
- TRANSMISSION / DRIVELINE
- GASKETS / SEALS
- ELECTRICAL
- LIGHTING
- CABLES
- BRAKES
- OIL FILTERS
- SUSPENSION
- BODY
- WHEELS
- TIRES / TIRE ACC.
- BIKE ACC.
- VICTORY / INDIAN
- COVERS / LOCKS / TIEDOWNS
- CHEMICALS
- TOOLS
- HELMETS**
- HELMET ACC.
- EYEWEAR
- APPAREL / RIDER ACC.
- PROMOTIONAL
- REFERENCE
- INDEX



REPLACEMENT PARTS FOR STREET HELMETS

- WINDSHIELDS / FAIRINGS
- AUDIO / COMMUNICATION
- SEATS / LUGGAGE
- BARS / MIRRORS / CONTROLS
- EXHAUST
- AIR / FUEL SYSTEMS
- ENGINE
- TRANSMISSION / DRIVELINE
- GASKETS / SEALS
- ELECTRICAL
- LIGHTING
- CABLES
- BRAKES
- OIL FILTERS
- SUSPENSION
- BODY
- WHEELS
- TIRES / TIRE ACC.
- BIKE ACC.
- VICTORY / INDIAN
- COVERS / LOCKS / TIEDOWNS
- CHEMICALS
- TOOLS
- HELMETS
- HELMET ACC.**
- EYEWEAR
- APPAREL / RIDER ACC.
- PROMOTIONAL
- REFERENCE
- INDEX

CONQUEST



		CHEEK PADS			
HELMET SIZE	CHEEK PAD STOCK	OPTIONAL SIZES			
		20mm	25mm	30mm	35mm
XS	30mm	73-88925	73-88921	73-88920	73-88922
S	25mm	73-88925	73-88921	73-88920	73-88922
M	35mm	73-88925	73-88921	73-88920	73-88922
L	30mm	73-88925	73-88921	73-88923	73-88922
XL	25mm	73-88925	73-88924	73-88923	73-88922
XXL	20mm	73-88925	73-88924	73-88923	73-88922

	= Stock Size Replacement
	= Shell and/or EPS Size Breakdown
	Must stay within each group range for
	cheek pads and liners to fit properly

		LINER			
HELMET SIZE	LINER STOCK	OPTIONAL SIZES			
		7mm	9MM	12MM	15mm
XS	12mm		73-88931	73-88930	73-88932
S	9mm		73-88931	73-88930	73-88932
M	15mm		73-88931	73-88933	73-88932
L	12mm		73-88931	73-88933	73-88932
XL	9mm	73-88935	73-88934	73-88933	73-88932
XXL	7mm	73-88935	73-88934	73-88933	73-88932

SENTINEL



		CHEEK PADS					
HELMET SIZE	CHEEK PAD STOCK	OPTIONAL SIZES					
		15mm	20mm	25mm	30mm	35mm	40mm
XS	40mm	73-89019	73-89020	73-89025	73-89030	73-89035	73-89040
S	35mm	73-89019	73-89020	73-89025	73-89030	73-89035	73-89040
M	40mm	73-89019	73-89020	73-89025	73-89030	73-89035	73-89040
L	25mm	73-89019	73-89020	73-89025	73-89030	73-89035	73-89040
XL	20mm	73-89019	73-89020	73-89025	73-89030	73-89035	73-89040
XXL	15mm	73-89019	73-89020	73-89025	73-89030	73-89035	73-89040



		LINER				
HELMET SIZE	LINER STOCK	OPTIONAL SIZES				
		7mm	9mm	12mm	15mm	18mm
XS	18mm	73-89007	73-89009	73-89012	73-89014	73-89016
S	15mm	73-89007	73-89009	73-89012	73-89014	73-89016
M	18mm	73-89007	73-89009	73-89012	73-89014	73-89016
L	12mm	73-89007	73-89009	73-89012	73-89014	73-89016
XL	9mm	73-89008	73-89010	73-89013	73-89015	73-89018
XXL	7mm	73-89008	73-89010	73-89013	73-89015	73-89018



REPLACEMENT PARTS FOR STREET HELMETS



LUXX



		CHEEK PADS					
HELMET SIZE	CHEEK PAD STOCK	OPTIONAL SIZES					
		15mm	20MM	25MM	30MM	35mm	40mm
XS	35mm	73-88855	73-88854	73-88853	73-88852	73-88851	73-88850
S	30mm	73-88855	73-88854	73-88853	73-88852	73-88851	73-88850
M	25mm	73-88855	73-88854	73-88853	73-88852	73-88851	73-88850
L	20mm	73-88855	73-88854	73-88853	73-88852	73-88851	73-88850
XL	20mm	73-88858	73-88857	73-88856			
XXL	15mm	73-88858	73-88857	73-88856			
XXXL	10mm	73-88858	73-88857	73-88856			

	= Stock Size Replacement
	= Shell and/or EPS Size Breakdown
	Must stay within each group range for cheek pads and liners to fit properly

		LINER				
HELMET SIZE	LINER STOCK	OPTIONAL SIZES				
		6mm	9mm	12mm	15mm	18mm
XS	15mm		73-88833	73-88832	73-88831	73-88830
S	12mm		73-88833	73-88832	73-88831	73-88830
M	15mm		73-88838	73-88837	73-88836	73-88835
L	12mm		73-88838	73-88837	73-88836	73-88835
XL	15mm	73-88844	73-88843	73-88842	73-88841	73-88840
XXL	12mm	73-88844	73-88843	73-88842	73-88841	73-88840
XXXL	9mm	73-88844	73-88843	73-88842	73-88841	73-88840

REVOLT



		CHEEK PADS				
HELMET	CHEEK PAD	OPTIONAL SIZES				
		SIZE			STOCK	20mm
XS	40mm			73-88422	73-88421	73-88420
S	35mm			73-88422	73-88421	73-88420
M	30mm			73-88422	73-88421	73-88420
L	30mm	73-88425	73-88424	73-88423		
XL	25mm	73-88425	73-88424	73-88423		
XXL	20mm	73-88425	73-88424	73-88423		



		LINER		
HELMET SIZE	LINER STOCK	OPTIONAL SIZES		
		9mm	12mm	15mm
XS	15mm		73-88431	73-88430
S	12mm		73-88431	73-88430
M	15mm			73-88432
L	15mm	73-88435	73-88434	73-88433
XL	12mm	73-88435	73-88434	73-88433
XXL	9mm	73-88435	73-88434	73-88433

WINDSHIELDS / FAIRINGS

AUDIO / COMMUNICATION

SEATS / LUGGAGE

BAR / MIRRORS / CONTROLS

EXHAUST

AIR / FUEL SYSTEMS

ENGINE

TRANSMISSION / DRIVELINE

GASKETS / SEALS

ELECTRICAL

LIGHTING

CABLES

BRAKES

OIL FILTERS

SUSPENSION

BODY

WHEELS

TIRES / TIRE ACC.

BIKE ACC.

VICTORY / INDIAN

COVERS / LOCKS / TIEDOWNS

CHEMICALS

TOOLS

HELMETS

HELMET ACC.

EYEWEAR

APPAREL / RIDER ACC.

PROMOTIONAL

REFERENCE

INDEX



REPLACEMENT PARTS FOR STREET HELMETS

	= Stock Size Replacement
	= Shell and/or EPS Size Breakdown
	Must stay within each group range for cheek pads and liners to fit properly

TREKKER



CHEEK PADS						
HELMET SIZE	CHEEK PAD STOCK	OPTIONAL SIZES				
		20mm	24mm	26mm	28mm	32mm
XS	32mm		73-39212		73-39214	73-39216
S	28mm		73-39212		73-39214	73-39216
M	24mm		73-39212		73-39214	73-39216
L	26mm	73-39217	73-39218	73-39219		
XL	24mm	73-39217	73-39218	73-39219		
XXL	20mm	73-39217	73-39218	73-39219		

LINER							
HELMET SIZE	LINER STOCK	OPTIONAL SIZES					
		6mm	8mm	10mm	12mm	14mm	18mm
XS	18mm			73-39201	73-39202	73-39203	73-39204
S	14mm			73-39201	73-39202	73-39203	73-39204
M	12mm			73-39201	73-39202	73-39203	73-39204
L	10mm		73-39205	73-39206	73-39207		
XL	10mm		73-39209	73-39210			
XXL	6mm	73-39208					

TOURIST



CHEEK PADS *note all helmet sizes take same cheek pads							
CHEEK PAD STOCK	CHEEK PAD STOCK	OPTIONAL SIZES					
		10mm	15mm	20mm	25mm	30mm	35mm
XS	30mm	73-88626	73-88626	73-88625	73-88624	73-88623	73-88622
S	25mm	73-88626	73-88626	73-88625	73-88624	73-88623	73-88622
M	25mm	73-88626	73-88626	73-88625	73-88624	73-88623	73-88622
L	20mm	73-88626	73-88626	73-88625	73-88624	73-88623	73-88622
XL	20mm	73-88626	73-88626	73-88625	73-88624	73-88623	73-88622
XXL	15mm	73-88626	73-88626	73-88625	73-88624	73-88623	73-88622

LINER						
HELMET SIZE	LINER STOCK	OPTIONAL SIZES				
		9mm	12mm	15mm	18mm	21mm
XS	18mm		73-88614	73-88613	73-88612	73-88611
S	15mm		73-88614	73-88613	73-88612	73-88611
M	18mm	73-88619	73-88618	73-88617	73-88616	73-88615
L	15mm	73-88619	73-88618	73-88617	73-88616	73-88615
XL	15mm	73-88619	73-88618	73-88617	73-88616	73-88615
XXL	12mm	73-88619	73-88618	73-88617	73-88616	73-88615

REPLACEMENT PARTS FOR STREET HELMETS



	= Stock Size Replacement
	= Shell and/or EPS Size Breakdown
	Must stay within each group range for cheek pads and liners to fit properly

.357

LINER					
HELMET SIZE	LINER STOCK	OPTIONAL SIZES			
		4mm	5mm	8mm	10mm
XS	10mm		73-88503	73-88502	73-88501
S	8mm		73-88503	73-88502	73-88501
M	6mm		73-88503	73-88502	73-88501
L	8mm	73-88506	73-88505	73-88504	
XL	6mm	73-88506	73-88505	73-88504	
XXL	4mm	73-88506	73-88505	73-88504	



9MM

LINER					
HELMET SIZE	LINER STOCK	OPTIONAL SIZES			
		3mm	6mm	9mm	12mm
XS	12mm		73-88703	73-88702	73-88701
S	9mm		73-88703	73-88702	73-88701
M	6mm		73-88703	73-88702	73-88701
L	9mm	73-88706	73-88705	73-88704	
XL	6mm	73-88706	73-88705	73-88704	
XXL	3mm	73-88706	73-88705	73-88704	
XXXL	9mm	73-88709	73-88708	73-88707	
XXXXL	6mm	73-88709	73-88708	73-88707	
XXXXXL	3mm	73-88709	73-88708	73-88707	



REPLACEMENT PARTS FOR STREET HELMETS



Grey Flame



Pink Flame



Gloss Black



Flat Black

Description	Model / Size / Color	WPS#
<b>.357</b>		
Shield	Smoke	73-8851
	Clear	73-8852
	Hi-Vis Yellow	73-8853
	Silver Mirror	73-8854
Comfort Liner	XS	73-88501
	S	73-88502
	M	73-88503
	L	73-88504
	X	73-88505
	2XL	73-88506

Description	Model / Size / Color	WPS#
<b>9MM</b>		
Comfort Liner	XS 12mm	73-88701
	S 9mm	73-88702
	M 6mm	73-88703
	L 9mm	73-88704
	XL 6mm	73-88705
	2XL 3mm	73-88706
	3XL	73-88707
	4XL	73-88708
	5XL	73-88709

WINDSHIELDS / FAIRINGS  
AUDIO / COMMUNICATION  
SEATS / LUGGAGE  
BARS / MIRRORS / CONTROLS  
EXHAUST  
AIR / FUEL SYSTEMS  
ENGINE  
TRANSMISSION / DRIVELINE  
GASKETS / SEALS  
ELECTRICAL  
LIGHTING  
CABLES  
BRAKES  
OIL FILTERS  
SUSPENSION  
BODY  
WHEELS  
TIRES / TIRE ACC.  
BIKE ACC.  
VICTORY / INDIAN  
COVERS / LOCKS / TIEDOWNS  
CHEMICALS  
TOOLS  
HELMETS  
HELMET ACC.  
EYEWEAR  
APPAREL / RIDER ACC.  
PROMOTIONAL  
REFERENCE  
INDEX



REPLACEMENT PARTS FOR STREET HELMETS



Description	Model / Size / Color	WPS#
<b>CONQUEST</b>		
Outer Face Shield	Anti-Fog Clear	73-88901
	Anti-Fog Smoke	73-88902
	Gold Mirror	73-88903
	Silver Mirror	73-88904
	Blue Mirror	73-88905
Inner Sun Shield	Dark Smoke	73-88911
	Hi-Def Amber	73-88912
	Silver Mirror	73-88913
Ratchet Plates	Pair with Screws	73-88945
Cheek Pads	30mm-XS	73-88920
	25mm-SM	73-88921
	35mm-MD	73-88922
	30mm-LG	73-88923
	25mm-XL	73-88924
	20mm-2X	73-88925
Comfort Liner	12mm-XS	73-88930
	9mm-S	73-88931
	15mm-MD	73-88932
	12mm-LG	73-88933
Vents	9mm-XL	73-88934
	7mm-2X	73-88935
	Mouth Vent	73-88940
	Top Vent	73-88941
Chin Curtain	Rear/Side Vent Blk 4 PK	73-88942
	Rear/Side Vent Wht 4 PK	73-88943
	Rear/Side Vent Pink 4 PK	73-88944
Breath Deflector	Street	73-88946
	Street	73-88947

Description	Model / Size / Color	WPS#	
<b>LUXX (cont'd...)</b>			
Front Jaw Vents	Red Pair w/ screws	73-88812	
	Blue Pair w/ screws	73-88813	
	White Pair w/ screws	73-88814	
	Grey Camo Pair w/ screws	73-88815	
	Red Camo Pair w/ screws	73-88816	
	Rear Vent White	73-88820	
	Rear Vent Black	73-88821	
	Mouth Vent Titanium	73-88868	
	Mouth Vent Flat Black	73-88869	
	Front Top Vents Titanium L&R 4 pcs w/ screws	73-88880	
	Front Top Vents Green L&R 4 pcs w/ screws	73-88881	
	Front Top Vents Red L&R 4 pcs w/ screws	73-88882	
	Front Top Vents Blue L&R 4 pcs w/ screws	73-88883	
	Front Top Vents White L&R 4 pcs w/ screws	73-88884	
	Front Top Vents Grey Camo L&R 4 pcs w/ screws	73-88885	
Front Top Vents Red Camo L&R 4 pcs w/ screws	73-88886		
Center Vent	Titanium	73-88890	
	Green	73-88891	
	Red	73-88892	
	Blue	73-88893	
	White	73-88894	
	Grey Camo	73-88895	
	Red Camo	73-88896	
	Trim Ring	White XS-LG	73-88860
	White XL-3X	73-88870	
	Black XS-LG	73-88861	
	Black XL-3X	73-88871	
	Red XS-LG	73-88862	
	Red XL-3X	73-88872	
	Blue XS-LG	73-88863	
	Blue XL-3X	73-88873	
Green XS-LG	73-88864		
Green XL-3X	73-88874		
Grey XS-LG	73-88865		
Grey XL-3X	73-88875		



Description	Model / Size / Color	WPS#
<b>LUXX</b>		
Outer Face Shield	Anti-Fog Clear	73-88801
	Anti-Fog Smoke	73-88802
Shield Fasteners	Pair Left and Right	73-88826
Inner Sun Shield	Smoke	73-88806
	Yellow	73-88807
Cheek Pads	Silver Mirror	73-88808
	40mm Optional fits XS-LG	73-88850
Cheek Pads	35mm XS fits XS-LG	73-88851
	30mm SM fits XS-LG	73-88852
	25mm MD fits XS-LG	73-88853
	20mm LG fits XS-LG	73-88854
	15mm Optional fits XS-LG	73-88855
	25mm Optional fits XL-3X	73-88856
Comfort Liner	20mm XL fits XL-3X	73-88857
	15mm 2X fit XL-3X	73-88858
	18mm Optional fits XS-SM	73-88830
	15mm XS fits XS-SM	73-88831
Comfort Liner	12mm SM fits XS-SM	73-88832
	9mm Optional fits XS-SM	73-88833
	18mm Optional fits MD-LG	73-88835
	15mm MD fits MD-LG	73-88836
	12mm LG fits MD-LG	73-88837
	9mm Optional fits MD-LG	73-88838
	18mm Optional fits XL-3X	73-88840
	15mm XL fits XL-3X	73-88841
	12mm 2X fits XL-3X	73-88842
	9mm 3X fits XL-3X	73-88843
Vents	6mm Optional fits XL-3X	73-88844
	Front Jaw Vents Titanium Pair w/ screws	73-88810
	Front Jaw Vents Green Pair w/ screws	73-88811



Description	Model / Size / Color	WPS#	
<b>REVOLT</b>			
Outer Face Shield	Anti-Fog Clear	73-88401	
	Anti-Fog Smoke	73-88402	
Ratchet Plates	Pair	73-88410	
Cheek Pads	XS	73-88420	
	SM	73-88421	
Cheek Pads	MD	73-88422	
	LG	73-88423	
	XL	73-88424	
	2X	73-88425	
	Comfort Liner	XS	73-88430
	Comfort Liner	S	73-88431
MD		73-88432	
LG		73-88433	
XL		73-88434	
2X		73-88435	
Vents		Mouth Vent Gloss Black	73-88441
	Mouth Vent Matte Black	73-88443	
	Mouth Vent Matte White	73-88445	
	Top Vent Set Gloss Black	73-88440	
	Top Vent Set Matte Black	73-88442	
Rear Spoilers	Top Vent Set Matte White	73-88444	
	Spoiler Matte Black	73-88446	
	Spoiler Gloss White	73-88447	
	Spoiler Patriot Grey/Black	73-88448	
	Spoiler Patriot White/Black	73-88449	
	Spoiler Patriot Hi-Viz/Black	73-88450	
Spoiler Patriot Red/Black	73-88451		

REPLACEMENT PARTS FOR STREET HELMETS

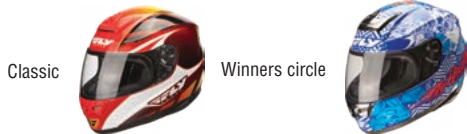

Classic      Winners circle

Description	Model / Size / Color	WPS#
<b>PARADIGM</b>		
Shield	Anti-Fog Clear	73-8800
Fly Chin Curtain		73-8811
Cheek Pads	60mm XS-S	73-8830
	55mm XS-S (XS)	73-8831
	45mm XS-S	73-8833
	45mm M-2X (XL)	73-8838
	40mm M-2X (2X)	73-8839
Liner	20mm XS-S	73-8820
	15mm XS-S (XS)	73-8821
	10mm XS-S (S)	73-8822
	5mm XS-S	73-8823
	5mm M-2X (2X)	73-8828
Vent Kit	Matte Blk	73-8840
	Silver	73-8841
	Classic Blu/Wht	73-8842
	Classic Blk/Grey	73-8843
	Classic Blk/Gold	73-8844
	Classic Red/Wht	73-8845
	Winners Circle Blu/Wht	73-8847
	Winners Circle Blk/Wht	73-8848



Grey/Red      Black/Hi-Vis

Description	Model/Size/Color	WPS#
<b>SENTINEL</b>		
Shield	Smoke	73-89801
	Silver Mirror	73-89802
Internal Shield	Dark Smoke	73-89803
	Clear	73-89804
Cheek Pads	15mm	73-89019
	20mm	73-89020
	25mm	73-89025
	35mm	73-89035
	40mm	73-89040
Comfort Liner	7mm XL-2X	73-89008
	9mm XL-2X	73-89010
	12mm XS-LG	73-89012
	15mm XS-LG	73-89014
	18mm XS-LG	73-89016
	18mm XL-2X	73-89018
Top Center Vent	Gloss Black	73-89805
	Matte Black	73-89806
	Mesh Grey/White	73-89807
Chin Vent	Black	73-89808
	Mesh Grey/Red	73-89809
	Mesh Black/Hi-Vis	73-89810
	Mesh Grey/White	73-89811
Front Side Vents	Black	73-89812



Hi-Vis      Blue      Black

Description	Model / Size / Color	WPS#
<b>TOURIST</b>		
Shield	Single lens Clear Anti-Fog	73-88601
	Single lens Smoke Anti-Fog	73-88602
	Dual lens clear	73-88605
Visor/Peak	Black	73-88640
Comfort Liner	21mm for XS & S	73-88611
	18mm for XS & S	73-88612
	15mm for XS & S	73-88613
	12mm for XS & S	73-88614
	21mm for MD - 2X	73-88615
	18mm for MD - 2X	73-88616
	15mm for MD - 2X	73-88617
	12mm for MD - 2X	73-88618
	9mm for MD - 2X	73-88619
Cheek Pads	35mm	73-88622
	30mm	73-88623
	25mm	73-88624
	20mm	73-88625
	15mm	73-88626
	10mm	73-88627
Replacement Jaw	Black	73-88630
	Flat Black	73-88631
	Titanium	73-88632
	Honda Blue	73-88633
	Pearl White	73-88634
	Candy Red	73-88635
	Hi-Viz Yellow	73-88636
Breath Guard		73-88638
Ratchet Plates	Pair w/screws	73-88644
Vents	Top Front (pair)	73-88645
	Top Rear (pair)	73-88646
Trim Ring	Black	73-88647
Rubber plugs	Used w/o Jaw (pair)	73-88648

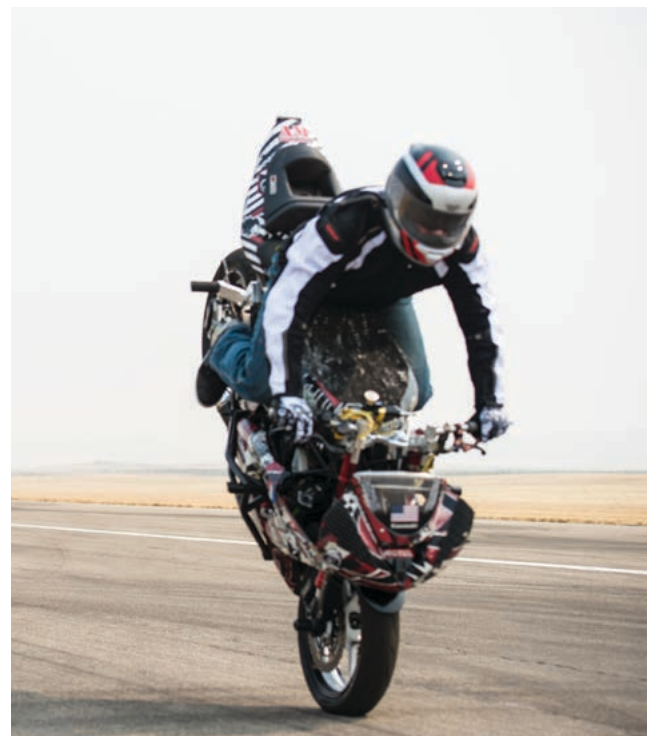

- WINDSHIELDS / FAIRINGS
- AUDIO / COMMUNICATION
- SEATS / LUGGAGE
- BAR / MIRRORS / CONTROLS
- EXHAUST
- AIR / FUEL SYSTEMS
- ENGINE
- TRANSMISSION / DRIVELINE
- GASKETS / SEALS
- ELECTRICAL
- LIGHTING
- CABLES
- BRAKES
- OIL FILTERS
- SUSPENSION
- BODY
- WHEELS
- TIRES / TIRE ACC.
- BIKE ACC.
- VICTORY / INDIAN
- COVERS / LOCKS / TIEDOWNS
- CHEMICALS
- TOOLS
- HELMETS
- HELMET ACC.**
- EYEWEAR
- APPAREL / RIDER ACC.
- PROMOTIONAL
- REFERENCE
- INDEX



REPLACEMENT PARTS FOR STREET HELMETS



Rootbeer Winner Red/Black/Orange Matte White

Description Model / Size / Color WPS#

.38 RETRO		
Cheek Pads	35mm optional for XS-L	73-88670
	30mm for XS-LG(STD in XS)	73-88671
	25mm for XS-LG(STD in SM)	73-88672
	20mm for XS-LG(STD in MD)	73-88673
	15mm for XS-LG(STD in LG)	73-88674
	35mm optional for XL-2X	73-88675
	30mm optional for XL-2X	73-88676
	25mm optional for XL-2X	73-88677
	20mm optional for XL-2X	73-88678
	15mm for XL-2X(STD in XL-2X)	73-88679
Comfort Liner	21mm optional size for XS-SM	73-88650
	18mm for XS-SM (STD in XS)	73-88651
	15mm optional size for XS-SM	73-88652
	12mm for XS-SM (STD in SM)	73-88653
	9mm optional size for XS-SM	73-88654
	15mm optional size for XS-SM	73-88655
	12mm for MD-LG (STD in MD)	73-88656
	9mm for MD-LG (STD in LG)	73-88657
	6mm optional for MD-LG	73-88658
	12mm optional for XL-2X	73-88659
	9mm for XL-2X (STD in XL)	73-88660
	6mm for XL-2X (STD in 2X)	73-88661
	3mm optional for XL-2X	73-88662



REPLACEMENT PARTS FOR STREET HELMETS



Warp White/Red Flash Yellow/Black

Description	Model/Size/Color	WPS#
<b>FF-49</b>		
Shield	Single Lens Clear	72-3410
	Single Lens Smoke	72-3411
	Single Lens Silver Iridium	72-3412
	Single Lens Blue Iridium	72-3413
	Single Lens Red Iridium	72-3414
	Inner Lens Clear	72-3417
	Inner Lens Smoke	72-3418
	Inner Lens Hi-Def Amber	72-3419
	Dual Lens Clear	72-0897
	Dual Lens Smoke	72-0898
	Electric Lens Clear	72-0896
	Electric Lens Tint	72-0899
Ratchet Plates	Adult	72-1717
Cord Kit	Complete Polaris/SD/Yam	72-0073
	Complete for Arctic Cat	72-1243
Liner	XS 15mm	72-3700
	Small 12mm	72-3701
	Medium 15mm	72-3702
	Large 12mm	72-3703
	X-Large 15mm	72-3704
	XX-Large 12mm	72-3705
	XXX-Large 9mm	72-3706
Cheek Pads	XS	72-3710
	Small	72-3711
	Medium	72-3712
	Large	72-3713
	X-Large	72-3714
	XX-Large	72-3715

Description	Model/Size/Color	WPS#
<b>FF-49 (CONT'D...)</b>		
	XXX-Large	72-3716
Bottom Trim Ring	Adult	72-3690
Front Jaw Vent	Adult	72-1644
Nose Guard	Adult	72-1645
Top Front Vents	Adult	72-1647
Breath Guard	Adult	72-3691
Chin Curtain	Cycle	72-3693
	Snow	72-3692
Neck Curtain	Adult	72-3694



Flat Black X-Star White/Hi-Vis Yellow X-Star White/Hi-Vis Green

Description	Model/Size/Color	WPS#
<b>FF-88</b>		
Shield	Single Lens Clear	72-3410
	Single Lens Smoke	72-3411
	Single Lens Silver Iridium	72-3412
	Single Lens Blue Iridium	72-3413
	Single Lens Red Iridium	72-3414
	Dual Lens Clear	72-0897
	Dual Lens Smoke	72-0898
	Electric Lens Clear	72-0896
	Electric Lens Tint	72-0899
Ratchet Plates	w/screws (shield)	72-1717
Vent	Front Jaw	72-3621
Top Vent Complete Assy	Back & Front	72-3622

REPLACEMENT PARTS FOR STREET HELMETS



Description	Model/Size/Color	WPS#
<b>FF-88 (cont'd...)</b>		
Top Front Vent L/R	Matte Blk	72-3760
	White	72-3762
Top Rear Vent	Matte Blk	72-3761
	White	72-3763
Breath Guard	Snow	72-3850
Chin Curtain	Street	72-3851
	Snow	72-3852
Cheek Pads	XS 30mm	72-3855
	S/M 25mm	72-3856
	L/XL 20 mm	72-3857
	2XL 15 mm	72-3858
Comfort Liner	3XL 10 mm	72-3859
	XS 12mm	72-3860
	S 9mm	72-3861
	M 12mm	72-3862
	L 9mm	72-3863
	XL 12mm	72-3864
	2XL 9mm	72-3865
3XL 6mm	72-3866	



White

Description	Model / Size / Color	WPS#
<b>GM-2</b>		
Shield	3 Snap Flip-up, Clear	72-0015
	3 Snap Flip-up, Smoke	72-0016
	Double Lens, Clear	72-0017
Bubble Visor	3 Snap, Blk	72-0013
	Leaf Camo	72-1070
Visor 3 Snap	Smoke	72-0424



Red

Description	Model / Size / Color	WPS#
<b>GM-7/X</b>		
Shield	Double Lens, 3 Snap Flip-up, Clear	72-0017
Side Covers	with 2 screws, Blk	72-0054

APEX Black/Blue



Black



Description	Model/Size/Color	WPS#
<b>FF-98</b>		
Shield	Single Lens Clear	72-3584
	Single Lens Smoke	72-3585
	Single Lens Silver Iridium	72-3586
	Single Lens Blue Iridium	72-3587
	Single Lens Red Iridium	72-3588
	Inner Lens Clear	72-3589
	Inner Lens Smoke	72-3590
	Inner Lens Hi-Def Amber	72-3591
	Shield	Dual Lens Clear
Dual Lens Smoke		72-3593
Electric Lens Clear		72-3594
Electric Lens Smoke		72-3595
Ratchet Plates Shield	left & Right w/screws	72-3579
Lower Shell Trim Ring		72-3580
Breath Guard	Snow	72-3849
Chin Curtain	Street	72-3847
	Snow	72-3848
Front chin vent		72-3569
Top front vent		72-3759
Rear Vent near LED	Left & Right	72-3779
Top rear vent	Matte black	72-3778
LED Brake Light Kit	w/Transmitter	72-3781
LED Replacement Light	Light Only	72-3783
LED Lens Cover	Clear	72-3462
LED Complete Kit	w/Battery case	72-3784
Replacement Battery Case	Batteries not Included	72-3782
Cheek Pads	45mm XS	72-3992XS
	40mm S	72-3992S
	35mm M/L	72-3992L
	30mm XL	72-3992X
	25mm 2XL	72-39922X
	20mm 3XL	72-39923X
Comfort Liner	18mm XS	72-3993XS
	15mm S	72-3993S
	9mm M	72-3993M
	6mm L	72-3993L
	12mm XL	72-3993X
	9mm 2XL	72-39932X
	6mm 3XL	72-39933X

GM-14/X



Description	Model / Size / Color	WPS#
<b>GM-14/X</b>		
Breath Deflector		72-0226
Snaps	for Breath Deflector	72-0412

GM-17 SPC



Description	Model / Size / Color	WPS#	
<b>GM-17 SPC</b>			
Shield	Clear	72-0603	
	Smoke	72-0604	
	Double Lens, Clear	72-1072	
	Double Lens Smoke	72-1073	
	Single Lens Flip Tint Kit	72-1079	
	Double Lens Flip Tint Kit	72-1080	
	Release Arm	72-0678	
	Flip Tint	Flip Tint Only	72-1086
Ratchet Plate	Inner w/ Springs & Screws	72-0605	
Inner Springs	Ratchet plate 2pk	72-0312	
Screws	Inner Ratchet Plate 4pk	72-0606	
Cover Washer & Screw Kit	2pk for Flip Tint	72-1075	
Vent	Top Front Vents - Left/Right	72-0843	
	Top Rear Vent	72-0557	
Visor	Tinted	72-0841	
Liner	18mm, XS	72-0844	
	15mm, S	72-0845	
	12mm, M	72-0846	
	18mm, L	72-0847	
	15mm, X	72-0848	
	12mm, 2X	72-0849	
	9mm, 3X	72-0850	
	Cheek Pads	45mm, XS	72-0851
		40mm, S	72-0852
		35mm, M	72-0853
	30mm, L	72-0854	
	25mm, X	72-0855	
	20mm, 2X-3X	72-0856	

WINDSHIELDS / FAIRINGS  
AUDIO / COMMUNICATION  
SEATS / LUGGAGE  
BARS / MIRRORS / CONTROLS  
EXHAUST  
AIR / FUEL SYSTEMS  
ENGINE  
TRANSMISSION / DRIVELINE  
GASKETS / SEALS  
ELECTRICAL  
LIGHTING  
CABLES  
BRAKES  
OIL FILTERS  
SUSPENSION  
BODY  
WHEELS  
TIRES / TIRE ACC.  
BIKE ACC.  
VICTORY / INDIAN  
COVERS / LOCKS / TIEDOWNS  
CHEMICALS  
TOOLS  
HELMETS  
HELMET ACC.  
EYEWEAR  
APPAREL / RIDER ACC.  
PROMOTIONAL  
REFERENCE  
INDEX



REPLACEMENT PARTS FOR STREET HELMETS



Black



Pearl White



Titanium

Description	Model / Size / Color	WPS#
<b>GM-32</b>		
Inner Shield	Clear	72-3537
	Hi-Def Amber	72-3538
	Yellow	72-3539
	Tinted	72-3546
	30mm (XS) Fits SM Shell	72-1675
Cheek Pads	30mm (MD) Fits MD & LG Shell	72-1670
	25mm (LG & XL) Fits MD & LG Shell	72-1671
	20mm (XXL) Fits MD & LG Shell	72-1672
	15mm (XXXL) Fits MD & LG Shell	72-1673
	10mm Fits MD & LG Shell	72-1674
Comfort Liner	30mm (XS) Fits SM Shell	72-1675
	25mm (SM) Fits SM Shell	72-1676
	20mm Fits SM Shell	72-1677
	15mm Fits SM Shell	72-1678
	15mm for XS	72-1660
Vent	12mm for SM	72-1661
	15mm for MD	72-1662
	12mm for LG	72-1663
	15mm for XL	72-1664
Visor/Peak	12mm for XXL	72-1665
	9mm for XXXL	72-1666
	Top Rear	72-1654
3-snap	72-1652	



Black

Description	Model / Size / Color	WPS#
<b>GM-35</b>		
Bubble Visor,	3-Snap, Smoke	72-0520



GM-38/S

Description	Model / Size / Color	WPS#
<b>GM-38/S</b>		
Shield	Clear	72-0301
	Dark Tint	72-0302
	Silver Iridium	72-0303
	Red Iridium	72-0529
	Double Lens Clear	72-0885
	Double Lens Smoke	72-0886
	DbI Lens Electric W/Holes for flip Tint	72-0889
	Blue Iridium	72-0304
	Red Iridium	72-0529
	Single Lens, Flip Tint Kit	72-1083
	Double Lens, Flip Tint Kit	72-1085
	Single Lens, Clear w/ holes, Flip Tint	72-1082
	Double Lens, Clear w/ holes, Flip Tint	72-1084
Lens	Outer Flip Tint Lens, Smoke	72-1081
Cord Kit	Complete Pol/SD/Yam	72-0073
	Complete for Arctic Cat	72-1243
Screw (28mm)	Flip Tint Kit	72-1096
Screws	Inner Ratchet Plate	72-0311
Release Arm	Shield (set)	72-0678
Ratchet Plate	Inner w/screws	72-0348

Description	Model / Size / Color	WPS#
<b>GM-38/S (cont'd...)</b>		
Springs	Inner Ratchet Plate	72-0312
Vents	Side	72-0337
	Lower front	72-0316
	Bottom front	72-0583
Breath Deflector	Snap In	72-0336
Snaps	Breath Deflector	72-0412

GM-39Y '07



GM-39Y '08



Description	Model / Size / Color	WPS#
<b>GM-39Y / S</b>		
Shield	Single Lens Clear	72-0301
	Single Lens Smoke	72-0302
	Single Lens Silver Iridium	72-0303
	Single Blue Iridium	72-0304
	Single Lens Red Iridium	72-0529
	Dual Lens Clear	72-0885
	Dual Lens Smoke	72-0886
	Electric Clear	72-0888
	DbI Lens Electric W/Holes for flip Tint	72-0889
	Single Lens Flip Tint Kit	72-1083
	Double Lens Flip Tint Kit	72-1085
	Single Lens, Clear w/holes, Flip Tint	72-1082
	Double Lens, Clear w/holes, Flip Tint	72-1084
Cord Kit	Outer Flip Tint Lens Smoke	72-1081
	Complete Polaris/SD/Yam	72-0073
Screw 28mm pair	Complete for Arctic Cat	72-1243
	Flip Tint Kit	72-1096
Breath Guard	Snap-in	72-0534
Snap Kit	Breath Guard	72-0412
Ratchet plates	Inner Set	72-0348
Springs	Ratchet Plate 2/pk	72-0312
Screws	Ratchet Plate 4/pk	72-0311
Vent	Bottom front	72-0583
	30mm '07 and Newer Snap in	72-0900
	25mm '07 and Newer Snap in	72-0901
	20mm '07 and Newer Snap in	72-0902

GM-44S, '08



GM-44S, '09



Description	Model / Size / Color	WPS#
<b>GM-44 / S</b>		
Shield	Clear	72-0541
	Smoke	72-0542
	Silver Iridium	72-0543
	Blue Iridium	72-0544
	Red Iridium	72-0545
	Double Lens, Clear	72-0891
	Double Lens, Smoke	72-0892
	Double Lens, Clear, Electric	72-0894
	DbI Lens Electric w/Holes, Flip Tint Kit, order Flip Tint separately	72-0895
	Single Lens w/holes, Flip Tint	72-1087
	Double Lens w/holes, Flip Tint	72-1089
	Outer Flip Tint Lens Smoke	72-1094
	Hi-Def Outer Flip Tint	72-1095
Cord Kit	Complete Polaris/SD/Yam	72-0073
	Complete for Arctic Cat	72-1243
Screw 28mm pair	Flip Tint Kit	72-1096
Screw	Ratchet Plate 4/pk	72-0554
Cover Washers pair	Flip Tint Kit	72-1097
Ratchet Plate	Set	72-0553
Spring	Ratchet Plate 2/pk	72-0555
Vent	Bottom front	72-0583
Top Vent Set	Black	72-0556
Vent	Center Rear	72-0557
Side Vent Set	Black	72-0558
Cheek Pads	30mm, XS	72-0565



REPLACEMENT PARTS FOR STREET HELMETS



Description	Model / Size / Color	WPS#
<b>GM-44 / S (CONT'D...)</b>		
	25mm, S	72-0566
	25mm, M	72-0567
	20mm, L	72-0568
	15mm, X	72-0569
	10mm, 2X	72-0570
	10mm, 3X	72-0571
	30mm, XS, Gray	72-0658
	25mm, S, Gray	72-0659
	25mm, M, Gray	72-0660
	20mm, L, Gray	72-0661
	15mm, XL, Gray	72-0662
	10mm, 2X, Gray	72-0663
	10mm, 3X, Gray	72-0664
Breath Deflector	Snap-in	72-0551
Chin Curtain	Vented	72-0549
	Non-Vented	72-0550
Washers	2pk for Flip Tint Outer Lens	72-1098
	2pk for Jaw Ratchet Plate	72-1099

GM-48S



Description	Model / Size / Color	WPS#
<b>GM-48 / S</b>		
Shield	Single Lens Clear	72-0301
	Single Lens Smoke	72-0302
	Single Lens Silver Iridium	72-0303
	Single Blue Iridium	72-0304
	Single Lens Red Iridium	72-0529
	Dual Lens Clear	72-0885
	Dual Lens Smoke	72-0886
	Electric Clear	72-0888
	Single Lens Flip Tint Kit	72-1083
	Double Lens Flip Tint Kit	72-1085
	Single Lens, Clear w/holes, Flip Tint	72-1082
	Double Lens, Clear w/holes, Flip Tint	72-1084
	Outer Flip Tint Lens Smoke	72-1081
	Cord Kit	Complete Polaris/SD/Yam
Complete for Arctic Cat		72-1243
Screw 28mm pair	Flip Tint Kit	72-1096
Breath Guard	Snap-in	72-0534
	Snap-in '07 and newer	72-0530
Chin Curtain	Solid	72-0531
	Vented	72-0532
Comfort Liner	21mm, XS, Gray	72-0915
	18mm, S, Gray	72-0916
	15mm, M, Gray	72-0917
	21mm, L, Gray	72-0918
	15mm XL	72-3645
	18mm, XL, Gray	72-0919
	12mm 2X	72-3646
Cheek Pads	15mm, 2X, Gray	72-0920
	9mm 3X	72-3647
	30mm, XS, Gray	72-0921
	25mm, S, Gray	72-0922
	20mm, M, Gray	72-0923
	20mm, L, Gray	72-0924
	15mm, XL, Gray	72-0925
Release Arm	10mm, 2X, Gray	72-0926
	Shield (set)	72-0678
Release kit	7 piece kit	72-3623
Ratchet Plate	Set	72-0348
Spring Set 2 pk	Ratchet Plate 2/pk	72-0312
Screws	Ratchet Plate 4/pk	72-0311
Vent	Bottom front	72-0583
Jaw Vent	Black	72-3621
Top Vent Set	Black	72-0556
Vent	Center Rear	72-0557

Description	Model / Size / Color	WPS#
<b>GM-48 / S (CONT'D...)</b>		
Side Vent Set	Black	72-0558
Interior Vent Plugs	10 piece kit	72-3651
Shell Trim Ring	Black	72-3620
Breath Guard & Chin Curtain		72-3650
Chin Curtain	Solid	72-3652
	Vented	72-3653

Gloss Black



DJ Black/Red



Description	Model / Size / Color	WPS#
<b>GM-49Y</b>		
Shield	Single Lens Clear	72-3410
	Single Lens Smoke	72-3411
	Single Lens Silver Mirror	72-3412
	Single Lens Blue Mirror	72-3413
	Single Lens Red Blue	72-3414
	Electric Clear	72-0896
	Double Lens Clear	72-0897
	Double Lens Smoke	72-0898
Cord Kit	Complete Polaris/SD/Yam	72-0073
	Complete for Arctic Cat	72-1243
Cheek Pads	40mm YS	72-1630
	30mm YM	72-1631
	25mm YL	72-1632
Comfort Liner	YS	72-1635
	YM	72-1636
	YL	72-1637
Chin Curtain	Snow	72-1640
	Street	72-1641
Vents	Front Jaw	72-1644
	Top Front (pair w/screws)	72-1647
Nose Guard	Rubber	72-1645
Ratchet Plate	Pair	72-1646
Trim Ring	Bottom	72-1649
Breath Guard	Snow	72-1650

GM-54



Description	Model / Size / Color	WPS#	
<b>GM-54 / S</b>			
Shield	Single Lens Clear	72-3410	
	Single Lens Smoke	72-3411	
	Single Lens Silver Iridium	72-3412	
	Single Lens Blue Iridium	72-3413	
	Single Lens Red Iridium	72-3414	
	Inner Lens Clear	72-3417	
	Inner Lens Smoke	72-3418	
	Inner Lens Hi-Def Amber	72-3419	
	Dual Lens Clear	72-0897	
	Dual Lens Smoke	72-0898	
	Electric Lens Clear	72-0896	
	Electric Lens Tint	72-0899	
	Cord Kit	Complete Polaris/SD/Yam	72-0073
		Complete for Arctic Cat	72-1243
Ratchet Plates	Shield	72-1717	
Cheek Pads	40mm XS	72-3421	
	35mm S	72-3422	
	30mm M	72-3423	
	25mm L	72-3424	
	20mm X	72-3425	
	15mm 2X	72-3426	
	15mm 3X	72-3420	

WINDSHIELDS / FAIRINGS  
AUDIO / COMMUNICATION  
SEATS / LUGGAGE  
BARS / MIRRORS / CONTROLS  
EXHAUST  
AIR / FUEL SYSTEMS  
ENGINE  
TRANSMISSION / DRIVELINE  
GASKETS / SEALS  
ELECTRICAL  
LIGHTING  
CABLES  
BRAKES  
OIL FILTERS  
SUSPENSION  
BODY  
WHEELS  
TIRES / TIRE ACC.  
BIKE ACC.  
VICTORY / INDIAN  
COVERS / LOCKS / TIEDOWNS  
CHEMICALS  
TOOLS  
HELMETS  
HELMET ACC.  
EYEWEAR  
APPAREL / RIDER ACC.  
PROMOTIONAL  
REFERENCE  
INDEX



REPLACEMENT PARTS FOR STREET HELMETS

- WINDSHIELDS / FAIRINGS
- AUDIO / COMMUNICATION
- SEATS / LUGGAGE
- BARS / MIRRORS / CONTROLS
- EXHAUST
- AIR / FUEL SYSTEMS
- ENGINE
- TRANSMISSION / DRIVELINE
- GASKETS / SEALS
- ELECTRICAL
- LIGHTING
- CABLES
- BRAKES
- OIL FILTERS
- SUSPENSION
- BODY
- WHEELS
- TIRES / TIRE ACC.
- BIKE ACC.
- VICTORY / INDIAN
- COVERS / LOCKS / TIEDOWNS
- CHEMICALS
- TOOLS
- HELMETS
- HELMET ACC.
- EYEWEAR
- APPAREL / RIDER ACC.
- PROMOTIONAL
- REFERENCE
- INDEX

Description	Model / Size / Color	WPS#
<b>GM-54 / S (cont'd...)</b>		
Comfort Liner	XS	72-3431
	S	72-3432
	M	72-3433
	L	72-3434
	X	72-3435
	2X	72-3436
	3X	72-3437
Jaw Ratchet Plate	Set	72-3440
Breath Guard		72-3441
Chin Curtain		72-3442
Neck Curtain		72-3443
Front Jaw Vent		72-3445
Side Jaw Vents	Left & Right	72-3446
Front Top Vent	Open/Close for Motorcycle	72-3447
Front Top Vent	Solid closed for snow	72-3449
Rear Top Vent	Left & Right	72-3448
Rear Vent near LED	Left & Right	72-3555
Inner Side Shield Tracks	Left & Right	72-3452
Inner Center Shield Track		72-3453
Jaw Release Kit	Button/Retainer/Ratchet Arm	72-3454
Inner Jaw Guide		72-3455
LED Replacement Light	Light Only	72-3461
LED Lens Cover	Clear	72-3462
LED Battery Case Kit	with cover & screws	72-3463
LED Complete Kit	Red	72-3464
LED Complete Kit	Pink	72-3465
LED Brake Light Kit	W/Transmitter	72-3467
Lower Shell Trim Ring		72-3466
Lower Jaw Trim Ring		72-3467
Front Corner Trim	Left & Right	72-3468
Inner Jaw Trim Piece		72-3469



GM-55

Description	Model / Size / Color	WPS#
<b>GM-55</b>		
Shield	Smoke XS-M	72-1600
	Smoke L-2X	72-1601
	Hi-Def Yellow XS-M	72-1602
	Hi-Def Yellow L-2X	72-1603
	Clear XS-M	72-1604
	Clear L-2X	72-1605
Comfort Liner	XS	72-1610
	S	72-1611
	M	72-1612
	L	72-1613
	X	72-1614
	2XL	72-1615
Neck Curtain	XS-M	72-1616
	L-2X	72-1617
Ratchet Kit		72-1619
Screw Kit (pr.)		72-1618
Visor/Peak	Black XS-M	72-1620
	Black L - 2X	72-1621
Visor Screws	Black (3pk)	72-1622



GM-58 Red



GM-58 Dragon Black/Yellow



GM-58 Venom Black/Silver

Description	Model / Size / Color	WPS#
<b>GM-58 / S</b>		
Shield	Single Lens Clear	72-0301
	Single Lens Smoke	72-0302
	Single Lens Silver Iridium	72-0303
	Single Blue Iridium	72-0304
	Single Lens Red Iridium	72-0529
Shield	Dual Lens Clear	72-0885

Description	Model / Size / Color	WPS#
<b>GM-58 / S (cont'd...)</b>		
Shield	Dual Lens Smoke	72-0886
	Electric Clear	72-0884
	Dbi Lens Electric W/Holes for flip Tint	72-0889
	Single Lens Flip Tint Kit	72-1083
	Double Lens Flip Tint Kit	72-1085
	Single Lens, Clear w/holes, Flip Tint	72-1082
	Double Lens, Clear w/holes, Flip Tint	72-1084
	Outer Flip Tint Lens Smoke	72-1081
Screw 28mm pair	Flip Tint Kit	72-1096
Cord Kit	Complete	72-0073
	For ARCTIC CAT	72-1243
Release Arm	Shield (set)	72-0678
Breath Guard	Snap-in	72-0733
Ratchet plates	Inner Set	72-0348
Spring Set 2 pk	Ratchet Plate 2/pk	72-0312
Screws	Ratchet Plate 4/pk	72-0311
Side Vent		72-0315
Vent	Bottom front	72-0583



White

Description	Model / Size / Color	WPS#
<b>GM-64 / S</b>		
Shield	Single Lens Clear	72-3600
	Single Lens Smoke	72-3601
	Single Lens Silver Iridium	72-3602
	Single Lens Blue Iridium	72-3603
	Single Lens Red Iridium	72-3604
	Inner Lens Clear	72-3614
	Inner Lens Smoke	72-3615
	Inner Lens Hi-Def Amber	72-3616
	Inner Lens Yellow	72-3617
	Inner Lens Silver Mirror	72-3618
	Dual Lens Clear	72-3608
	Dual Lens Smoke	72-3609
	Electric Lens Clear	72-3610
	Electric Lens Smoke	72-3611
Cord Kit	Complete Polaris/SD/Yam	72-0073
	Complete for Arctic Cat	72-1243
	Electric Cord Clip	72-3654
Ratchet Plates	Shield	72-1717
Top Front Vent L/R	Matte Black	72-3760
	White	72-3762
	Black	72-3622F
Top Rear Vent	Matte Black	72-3761
	White	72-3763
	Black	72-3622R
Front Jaw Vent		72-3621
Top Vent Complete Assy		72-3622
Cheek Pads	40mm XS	72-3631
	35mm SM/MD	72-3632
	25mm LG	72-3633
	25mm XL	72-3634
	20mm 2X	72-3635
	15mm 3X	72-3636
Comfort Liner	XS	72-3641
	S	72-3642
	M	72-3643
	L	72-3644
	X	72-3645
	2X	72-3646
	3X	72-3647
Top Vent	Complete Assembly	72-3622
Jaw Release Kit	7 pieces	72-3623
Inner Jaw Trim Piece	w/Screws	72-3624
Shell Front Corner Trim	W/Jaw Connect Pin	72-3625
Jaw Cam Arms	W/Spacers and Screws	72-3626
Jaw Release Button	3 pcs	72-3627
Breath Guard & Chin Crtn	Snow	72-3650
Cold Weather Plug Kit	10pcs	72-3651
Chin Curtain	Snow	72-3653
Chin Curtain	Street	72-3652

REPLACEMENT PARTS FOR STREET HELMETS



Description	Model / Size / Color	WPS#
<b>GM-65</b>		
Shield	Smoke XS-M	72-1730
	Smoke L-2X	72-1731
	Hi-Def Amber XS-M	72-1732
	Hi-Def Amber L-2X	72-1733
	Clear XS-M	72-1734
	Clear L-2X	72-1735
	Yellow XS-M	72-1736
	Yellow L-2X	72-1737
	Silver XS-M	72-1738
	Silver L-2X	72-1739
Comfort Liner	XS	72-1720
	S	72-1721
	M	72-1722
	L	72-1723
	X	72-1724
	2XL	72-1725
Neck Curtain	XS-M	72-1616
	L-2X	72-1617
Visor/Peak	Black XS-M	72-1620
	Black L - 2X	72-1621
Visor Screws	Black (3pk)	72-1622



Description	Model / Size / Color	WPS#
<b>GM-67</b>		
Shield	Clear Single Lens	72-3540
	Clear Double Lens	72-3547
	Smoke Single Lens	72-3541
	Silver Single Lens	72-3542
	Blue Single Lens	72-3543
	Red Single Lens	72-3544
	Clear Electric Double Lens	72-3548
	Tint Electric Double Lens	72-3548T
	Inner Shield Clear	72-3537
	Inner Shield Hi-Def Amber	72-3538
	Inner Shield Yellow	72-3539
	Inner Shield Tinted	72-3546
Cord Kit	Complete Polaris/SD/Yam	72-0073
	Complete for Arctic Cat	72-1243
	Source cord Electric Shield	72-3655
	Straight coil Electric Shield cord	72-3656
	Coiled Cord Electric Shield	72-3657
Cheek Pads	40 mm, S	72-3526
	35 mm, M	72-3525
	30 mm, L	72-3524
	25 mm, X	72-3523
	20 mm, 2X-3X	72-3522
	15 mm	72-3521
	10 mm	72-3520
Comfort Liner	XS, 15mm	72-3530
	S, 12mm	72-3531
	M, 15mm	72-3532
	L, 12mm	72-3533
	X, 12mm	72-3534
	2X, 9mm	72-3535
	3X, 6mm	72-3536
Top Front Vent L/R		72-3447
Top Rear Vent L/R		72-3448
Rear Vent L/R		72-3555
LED With Case & Rubber		72-3461
LED Cover Red	Replacement cover lens	72-3460
LED Clear Cover Lens	Replacement cover lens	72-3462
Battery Case With Cover		72-3463
LED Complete Kit	Red	72-3464
LED Complete Kit	Pink	72-3465

Description	Model / Size / Color	WPS#
<b>GM-67 (CONT'D...)</b>		
Ratchet Plate With Screws		72-3554
Lower Trim Ring		72-3551
Jaw chin curtain and breath guard	one piece sewn together	72-3550
Jaw set Complete		72-3570
Small Peak Visor	used without outer shield	72-3552
LED Brake Light Kit	w/Transmitter	72-3567



Description	Model / Size / Color	WPS#
<b>GM-68 / S</b>		
Shield	Single Lens Clear	72-0301
	Single Lens Smoke	72-0302
	Single Lens Silver Iridium	72-0303
	Single Lens Blue Iridium	72-0304
	Single Lens Red Iridium	72-0529
	Dual Lens Clear	72-0885
	Dual Lens Smoke	72-0886
	Dbl Lens Electric W/Holes for flip Tint	72-0889
	Single Lens Flip Tint Kit	72-1083
	Double Lens Flip Tint Kit	72-1085
	Single Lens, Clear w/holes, Flip Tint	72-1082
	Double Lens, Clear w/holes, Flip Tint	72-1084
	Outer Flip Tint Lens Smoke	72-1081
Cord Kit	Complete Pol/SD/Yam	72-0073
	Complete Arctic Cat	72-1243
Screw 28mm pair	Flip Tint Kit	72-1096
Cover Washer & Screw Kit	2pk for Flip Kit	72-1075
Release Arm	Shield (set)	72-0678
Breath Guard	Snow	72-0978
Chin Curtain	Motorcycle	72-0977
	Snow	72-0976
Ratchet plates	Inner Set	72-0348
Springs	Ratchet Plate 2/pk	72-0312
Deflector	Front Air w/Screws	72-0980
Screws	LED Lens Cover	72-0955
LED Lens Cover	Red	72-0954
LED Only	No Batteries	72-0953
	With Batteries	72-1990
Top Vent	Crusader Blue w/LED	72-0991
	Crusader Dark Silver w/LED	72-0996
	Crusader Flat Pink w/LED	72-0995
	Crusader Flat Silver w/LED	72-0997
	Crusader w/Red w/LED	72-0952
Top Vent	Dragon Black/Red w/LED	72-1003
	Dragon White/Red w/LED	72-0998
	Flat Black w/LED	72-1004
Top Vent	Max Blue/Sil w/LED	72-0942
	Max Green/Sil w/LED	72-0943
	Max Pink/Sil w/LED	72-0945
	Max Red/Sil w/LED	72-0941
	Max Wht/Blk w/LED	72-0935
	Max Wht/Blk w/LED	72-0946
	Max Wht/Gm w/LED	72-0933
	Max Wht/Pink w/LED	72-0936
	Max Wht/Red w/LED	72-0931
	Max Wht/Yw w/LED	72-0934
	Max Yellow/Sil w/LED	72-0944
Top Vent	Odyssey Wht/Blu w/LED	72-0932
Top Vent	Pearl White	72-0937
Top Vent	Titanium	72-0938
Top Vent	Wizard w/LED	72-0930
Vent	Bottom Front	72-0583
	Top Middle Left Slider	72-0960

WINDSHIELDS / FAIRINGS  
AUDIO / COMMUNICATION  
SEATS / LUGGAGE  
BARS / MIRRORS / CONTROLS  
EXHAUST  
AIR / FUEL SYSTEMS  
ENGINE  
TRANSMISSION / DRIVELINE  
GASKETS / SEALS  
ELECTRICAL  
LIGHTING  
CABLES  
BRAKES  
OIL FILTERS  
SUSPENSION  
BODY  
WHEELS  
TIRES / TIRE ACC.  
BIKE ACC.  
VICTORY / INDIAN  
COVERS / LOCKS / TIEDOWNS  
CHEMICALS  
TOOLS  
HELMETS  
HELMET ACC.  
EYEWEAR  
APPAREL / RIDER ACC.  
PROMOTIONAL  
REFERENCE  
INDEX



REPLACEMENT PARTS FOR STREET HELMETS

- WINDSHIELDS / FAIRINGS
- AUDIO / COMMUNICATION
- SEATS / LUGGAGE
- BARS / MIRRORS / CONTROLS
- EXHAUST
- AIR / FUEL SYSTEMS
- ENGINE
- TRANSMISSION / DRIVELINE
- GASKETS / SEALS
- ELECTRICAL
- LIGHTING
- CABLES
- BRAKES
- OIL FILTERS
- SUSPENSION
- BODY
- WHEELS
- TIRES / TIRE ACC.
- BIKE ACC.
- VICTORY / INDIAN
- COVERS / LOCKS / TIEDOWNS
- CHEMICALS
- TOOLS
- HELMETS
- HELMET ACC.
- EYEWEAR
- APPAREL / RIDER ACC.
- PROMOTIONAL
- REFERENCE
- INDEX

Description	Model / Size / Color	WPS#	
<b>GM-68 / S (CONT'D...)</b>			
Vent	Top Middle Right Slider	72-0961	
	Top Middle Slider	72-0959	
	Top Front	72-0957	
	Top Rear	72-0958	
	Cheek Pads	45mm, XS, Gray	72-0969
		40mm, S, Gray	72-0970
		35mm, M, Gray	72-0971
	30mm, L, Gray	72-0972	
	30mm, X, Gray	72-0973	
	25mm, 2X, Gray	72-0974	
	20mm, 3X, Gray	72-0975	
	Comfort Liner	XS	72-0962
S		72-0963	
M		72-0964	
L		72-0965	
X		72-0966	
2X		72-0967	
	3X	72-0968	



Crusader II White/Red

Description	Model / Size / Color	WPS#	
<b>GM-69 / S</b>			
Shield	Single Lens Clear	72-0301	
	Single Lens Smoke	72-0302	
	Single Lens Silver Iridium	72-0303	
	Single Lens Silver Mirror	72-0303	
	Single Blue Iridium	72-0304	
	Single Lens Red Iridium	72-0529	
	Dual Lens Clear	72-0885	
	Dual Lens Smoke	72-0886	
	Cord Kit	Complete Pol/SD/Yam	72-0073
		Complete Arctic Cat	72-1243
Release Arm	Shield (set)	72-0678	
Breath Guard	Snow	72-0978	
Chin Curtain	Motorcycle	72-0977	
	Snow	72-0976	
Ratchet plates	Inner Set	72-0348	
Springs	Ratchet Plate 2/pk	72-0312	
Deflector	Front Air w/Screws	72-0980	
Top Vent	Gloss Black	72-1100	
	Flat Black	72-1101	
	Pearl White	72-1102	
	Titanium	72-1103	
	Crusader II White/Red	72-1104	
	Crusader II White/Blue	72-1105	
	Crusader II White/Green	72-1106	
	Crusader II White/Pink	72-1107	
	Crusader II White/Yellow	72-1108	
	Crusader II White/Purple	72-1109	
Crusader II Dk. Silver/Ti	72-1110		
Crusader II Wht/Dk. Sil	72-1111		
	Flat Black/Red	72-3720	
	Flat Black/D.Silver	72-3721	
	Black/Hi-Vis Green	72-3722	
	Black/Hi-Vis Orange	72-3723	
Top Front Vent Cover	L/R (PAIR)	72-1112	
Cheek Pads	45mm	72-1113	
	40mm, XS	72-1114	
	35mm, S/M	72-1115	
	30mm, L/X	72-1116	
	25mm, 2X	72-1117	
	20mm, 3X	72-1118	

Description	Model / Size / Color	WPS#
<b>GM-69 / S (CONT'D...)</b>		
Comfort Liner	XS	72-0962
	S	72-0963
	M	72-0964
	L	72-0965
	X	72-0966
	2X	72-0967
	3X	72-0968



Solid Flat Black



Graphic Firestarter Black/Red

Description	Model / Size / Color	WPS#
<b>GM-78 / S</b>		
Shield	Single Lens Clear	72-3410
	Single Lens Smoke	72-3411
	Single Lens Silver Mirror	72-3412
	Single Lens Blue Mirror	72-3413
	Single Lens Red Blue	72-3414
	Electric Clear	72-0896
	Double Lens Clear	72-0897
	Double Lens Smoke	72-0898
	Inner Shield Hi-Def Amber	72-1710
	Inner Shield Smoke/Tint	72-1711
Cord Kit	Inner Shield Yellow	72-1712
	Complete Polaris/SD/Yam	72-0073
	Complete for Arctic Cat	72-1243
Cheek Pads	35mm XS	72-1681
	30mm SM & MD	72-1682
	25mm LG	72-1683
	20mm XL	72-1684
	15mm 2X	72-1685
Comfort Liner	10mm 3X	72-1686
	XS	72-1691
	SM	72-1692
	MD	72-1693
	LG	72-1694
	XL	72-1695
	2X	72-1696
	3X	72-1697
Neck Curtain		72-1702
Nose Guard	Black Rubber	72-1703
Chin Curtain	Street	72-1704
	Snow	72-1705
Breath Guard	Snow	72-1716
Ratchet Plates	Pair w/screws	72-1717
Front Jaw Vent		72-3445
Front Top Vent	Open/Close for Motorcycle	72-3447
Front Top Vent	Solid closed for snow	72-3449
Rear Top Vent		72-3448
Rear Vent near LED	Left & Right	72-3555
Inner Side Shield Tracks		72-3452
Inner Center Shield Track		72-3453
LED Lens Cover	Black. Replaces Light	72-3460
LED Replacement Light		72-3461
LED Lens Cover	Clear	72-3462
LED Battery Case Kit		72-3463
LED Complete Kit	Red	72-3464
LED Complete Kit	Pink	72-3465

REPLACEMENT PARTS FOR STREET HELMETS



Matte Black



Blue



Wine Red

Description	Model / Size / Color	WPS#
<b>OF-17</b>		
Shield	Clear	<b>72-0603</b>
	Smoke	<b>72-0604</b>
	Double Lens, Clear	<b>72-1072</b>
	Double Lens Smoke	<b>72-1073</b>
	Single Lens Flip Tint Kit	<b>72-1079</b>
	Double Lens Flip Tint Kit	<b>72-1080</b>
	Release Arm	<b>72-0678</b>
Flip Tint	Flip Tint Only	<b>72-1086</b>
Ratchet Plate	Inner w/ Springs & Screws	<b>72-0605</b>
Inner Springs	Ratchet plate 2pk	<b>72-0312</b>
Screws	Inner Ratchet Plate 4pk	<b>72-0606</b>
Cover Washer & Screw Kit	2pk for Flip Tint	<b>72-1075</b>
Top Front Vents	Top Front Vents - Left/Right	<b>72-3890</b>
Trim Ring	Bottom of shell	<b>72-3970</b>
Visor	Tinted	<b>72-0841</b>
Comfort Liner	XS 18mm	<b>72-3988XS</b>
	S 15mm	<b>72-3988S</b>
	M 12mm	<b>72-3988M</b>
	L 18mm	<b>72-3988L</b>
	XL 15mm	<b>72-3988X</b>
	2X 12mm	<b>72-39882X</b>
	3X 9mm	<b>72-39883X</b>
Cheek Pads	XS 45mm	<b>72-3987XS</b>
	S 40mm	<b>72-3987S</b>
	M 35mm	<b>72-3987M</b>
	L 30mm	<b>72-3987L</b>
	XL 25mm	<b>72-3987X</b>
	2X 20mm	<b>72-39872X</b>
	3X 20mm	<b>72-39873X</b>



Solid Candy Red



Classic Flat Black



Butterfly Flat Blk/Blu

Description	Model / Size / Color	WPS#
<b>OF-77</b>		
Shield	Clear Single Lens	<b>72-3540</b>
	Clear Double Lens	<b>72-3547</b>
	Tinted Double Lens	<b>72-3547T</b>
	Smoke Single Lens	<b>72-3541</b>
	Silver Single Lens	<b>72-3542</b>
	Blue Single Lens	<b>72-3543</b>
	Red Single Lens	<b>72-3544</b>
	Clear Electric Double Lens Kit	<b>72-3548</b>
	Tinted Electric Double Lens Kit	<b>72-3548T</b>
	Inner Shield Clear	<b>72-3770</b>
	Inner Shield Hi-Def Amber	<b>72-3773</b>
	Inner Shield Yellow	<b>72-3772</b>
	Inner Shield Tinted	<b>72-3771</b>
Cheek Pads	35 mm, XS	<b>72-3790</b>
	30 mm, S/M	<b>72-3791</b>

Description	Model / Size / Color	WPS#
<b>OF-77 (cont'd...)</b>		
Cheek Pads	25 mm, L	<b>72-3792</b>
	15 mm, XL	<b>72-3793</b>
	10 mm, XXL,XXXL	<b>72-3794</b>
Comfort Liner	XS/S 15mm	<b>72-3795</b>
	M,L,XL 12mm	<b>72-3796</b>
	XXL 9mm	<b>72-3797</b>
	XXXL, 6mm	<b>72-3798</b>
Top Front Vent L/R	Gloss Black	<b>72-3775</b>
Top Front Vent L/R	Matte Black	<b>72-3776</b>
Top Rear Vent L/R	Gloss Black	<b>72-3777</b>
Top Rear Vent L/R	Matte Black	<b>72-3778</b>
Rear Vent	Left & Right	<b>72-3779</b>
LED Cover Red	Replacement cover lens	<b>72-3460</b>
LED Cover Clear	Replacement cover lens	<b>72-3462</b>
Ratchet Plate	w/Screws (shield)	<b>72-3554</b>
Jaw chin curtain and breath guard	One piece sewn together	<b>72-3550</b>
Jaw set Complete	Removable Jaw	<b>72-3570</b>
Lower Trim Ring	Replacement part, Black	<b>72-3780</b>
LED Brake Light Kit	w/Transmitter	<b>72-3781</b>
LED Battery Case	Uses CR2032 Batteries	<b>72-3782</b>
Replacement LED Light		<b>72-3783</b>
LED Complete Kit Red		<b>72-3784</b>



Pearl White



PRR Black/Pink



Stealth Matte Black/Hi-Vis

Description	Model / Size / Color	WPS#
<b>MD-01</b>		
Shield	Single Lens Clear	<b>72-3600</b>
	Single Lens Smoke	<b>72-3601</b>
	Single Lens Silver Iridium	<b>72-3602</b>
	Single Lens Blue Iridium	<b>72-3603</b>
	Single Lens Red Iridium	<b>72-3604</b>
	Inner Lens Clear	<b>72-3581</b>
	Inner Lens Smoke	<b>72-3582</b>
	Inner Lens Hi-Def Amber	<b>72-3583</b>
	Dual Lens Clear	<b>72-3608</b>
	Dual Lens Smoke	<b>72-3609</b>
	Electric Lens Clear	<b>72-3610</b>
	Electric Lens Tint	<b>72-3611</b>
Cord Kit	Complete Polaris/SD/Yam	<b>72-0073</b>
	Complete for Arctic Cat	<b>72-3654</b>
Ratchet Plates	Shield	<b>72-1717</b>
Cheek Pads	45mm XS/S	<b>72-3990S</b>
	35mm M/L	<b>72-3990L</b>
	30mm XL	<b>72-3990X</b>
	25mm 2XL	<b>72-39902X</b>
	20mm 3XL	<b>72-39903X</b>
Comfort Liner	XS 18mm	<b>72-3991XS</b>
	S 12mm	<b>72-3991S</b>
	M 12mm	<b>72-3991M</b>
	L 6mm	<b>72-3991L</b>
	X 12mm	<b>72-3991X</b>
	2X 9mm	<b>72-39912X</b>
	3X 6mm	<b>72-39913X</b>
Jaw Ratchet Plate	Set	<b>72-3571</b>
Jaw Screws w/washers	set	<b>72-3572</b>
Breath Guard		<b>72-3441</b>
Chin Curtain	Street	<b>72-3845</b>

WINDSHIELDS / FAIRINGS  
AUDIO / COMMUNICATION  
SEATS / LUGGAGE  
BARS / MIRRORS / CONTROLS  
EXHAUST  
AIR / FUEL SYSTEMS  
ENGINE  
TRANSMISSION / DRIVELINE  
GASKETS / SEALS  
ELECTRICAL  
LIGHTING  
CABLES  
BRAKES  
OIL FILTERS  
SUSPENSION  
BODY  
WHEELS  
TIRES / TIRE ACC.  
BIKE ACC.  
VICTORY / INDIAN  
COVERS / LOCKS / TIEDOWNS  
CHEMICALS  
TOOLS  
HELMETS  
HELMET ACC.  
EYEWEAR  
APPAREL / RIDER ACC.  
PROMOTIONAL  
REFERENCE  
INDEX



REPLACEMENT PARTS FOR STREET HELMETS

Description	Model / Size / Color	WPS#
<b>MD-01 (cont'd...)</b>		
Chin Curtain	Snow	72-3846
Front Jaw Vent		72-3569
Front Top Vents	Left & Right	72-3759
Rear Top Vent	Left & Right	72-3573
Rear Vent near LED	Left & Right	72-3779
Jaw Release Kit	Button/Retainer/Ratchet Arm	72-3574
Inner Jaw Guide	Left & Right	72-3575
LED Brake Light Kit	w/Transmitter	72-3781
LED Replacement Light	Light Only	72-3783
LED Lens Cover	Clear	72-3462
LED Complete Kit	w/Battery case	72-3784
Replacement Battery Case	Batteries not Included	72-3782
Lower Shell Trim Ring		72-3576
Front Corner Trim	Left & Right	72-3577
Inner Jaw Trim Piece		72-3578



Black

Hi-Vis

Description	Model / Size / Color	WPS#
<b>MD-04</b>		
Shield	Clear	72-0541
	Smoke	72-0542
	Silver Iridium	72-0543
	Blue Iridium	72-0544
	Red Iridium	72-0545
	Double Lens, Clear	72-0891
	Double Lens, Smoke	72-0892
	Double Lens, Clear, Electric	72-0894

Description	Model / Size / Color	WPS#
<b>MD-04 (cont'd...)</b>		
Shield	Dbl Lens Electric w/Holes, Flip Tint Kit, order Flip Tint separately	72-0895
	Single Lens w/holes, Flip Tint	72-1087
	Double Lens w/holes, Flip Tint	72-1089
	Outer Flip Tint Lens Smoke	72-1094
	Hi-Def Outer Flip Tint	72-1095
Cord Kit	Complete Polaris/SD/Yam	72-0073
	Complete for Arctic Cat	72-1243
Screw 28mm pair	Flip Tint Kit	72-1096
Screws	Ratchet Plate 4/pk (shield)	72-0554
Cover Washers pair	Flip Tint Kit	72-1097
Ratchet Plate	w/screws and springs (shield)	72-0553
Spring	Ratchet Plate 2/pk (Shield)	72-0555
Vent	Front Jaw w/Screws	72-1644
Ratchet Plate	Jaw Piece Ratchet Plate L/R	72-0559
Jaw Trim	Inner Jaw Piece Cover	72-3891
Jaw Release kit	Open Bar W/2 Screws & Springs	72-0560
Jaw Trim	Left And Right Side Jaw Retainer	72-1090
Top Vents Front	Left & Right New 2016	72-3890
Cheek Pads	XS 30Mm	72-3871
	S 25Mm	72-3872
	M 20Mm	72-3873
	L 20Mm	72-3874
	XI 15Mm	72-3875
	XXL 10Mm	72-3876
	XXXL 10Mm	72-3877
Comfort Liner	XS 21Mm	72-3881
	S 18Mm	72-3882
	M 15Mm	72-3883
	L 21Mm	72-3884
	XL 18Mm	72-3885
	XXL 15Mm	72-3886
	XXXL 12Mm	72-3887
Trim Ring	Shell bottom	72-1091
Chin Curtain	Street (vented)	72-0549
	Snow (solid)	72-0550
Breath Guard	Snap-In Breath Guard	72-0551
Snaps	Breath Guard/Chin Curtain Snaps (10)	72-0552

REPLACEMENT PARTS FOR STREET HELMETS



Matte Black



Description	Model / Size / Color	WPS#
<b>BELFAST</b>		
Sun Visor	Dark Smoke	75-01013
Storage accessories	Soft carry bag	75-01192



Back

White

Ratnick Phantom

Description	Model / Size / Color	WPS#
<b>COVERT</b>		
Neck Roll	XS	75-01030
	S	75-01031
	M	75-01032
	L	75-01033

Description	Model / Size / Color	WPS#
<b>COVERT (cont'd...)</b>		
Neck Roll	XL	75-01034
	2X	75-01035
	3X	75-01036
Neck Cover	L	75-01037
	XL	75-01038
Sun Visor	Clear	75-01040
	Smoke	75-01041
	Gold	75-01042
	Silver	75-01043
Face Mask		75-01044
Kwickwick II Liner	XS	75-02070
	S	75-02071
	M	75-02072
	L	75-02073
	XL	75-02074
	2X	75-02075
	3X	75-02076
Storage accessories	Soft carry bag	75-01192
	Valise premium bag	75-01195



REPLACEMENT PARTS FOR STREET HELMETS



Description	Model / Size / Color	WPS#
<b>EXO-C110</b>		
Sun Visor	Clear	75-01060
	Dark Smoke	75-01061
	Light Smoke	75-01062
	Amber	75-01063
	Blue	75-01064
	Silver	75-01065
	Ruby	75-01066
	Black	75-01069
Kwickwick II Liner	XS	75-02090
	S	75-02091
	M	75-02092
	L	75-02093
	XL	75-02094
	2X	75-02095
Storage accessories	Soft carry bag	75-01191



Description	Model / Size / Color	WPS#
<b>EXO-CT220</b>		
Sun Visor	Clear	75-01050
	Dark Smoke	75-01051
	Light Smoke	75-01052
	Amber	75-01053
Faceshields	Clear	75-01055
	Dark Smoke	75-01056
	Light Smoke	75-01057
Peak Visor	Black	75-01058
	Matte Black	75-01059
Kwickwick II Liner	XS	75-02080
	S	75-02081
	M	75-02082
	L	75-02083
	XL	75-02084
	2X	75-02085
	3X	75-02086
Storage accessories	Soft carry bag	75-01192
	Valise premium bag	75-01195



Description	Model / Size / Color	WPS#
<b>EXO-GT3000</b>		
Faceshields	Clear	75-01004
	Smoke	75-01005
Sun Visor	Smoke	75-01012
Aero Skirt	All Sizes	75-01025
Kwickwick III Liner	XS	75-02050



Description	Model / Size / Color	WPS#
<b>EXO-GT3000 (CONT'D...)</b>		
Kwickwick III Liner	S	75-02051
	M	75-02052
	L	75-02053
	XL	75-02054
	2X	75-02055
Facesheid	Silver Mirror	75-01138
Facesheids	Gold Mirror	75-01135
Facesheid MaxVision	Clear Pinlock	75-01136
	Soft carry bag	75-01193
	Faceshield bag	75-01190
	Valise premium bag	75-01195



Description	Model / Size / Color	WPS#
<b>EXO-GT-920</b>		
Faceshields	Clear	75-01004
	Smoke	75-01005
Sun Visor	Smoke	75-01012
Aero Skirt	One Size	75-01026
Kwickwick II Liner	XS	75-02060
	S	75-02061
	M	75-02062
	L	75-02063
	XL	75-02064
	2X	75-02065
	3X	75-02066
Kwickwick II Cheek pads only	XS	75-02240
	S	75-02241
	M	75-02242
	L	75-02243
	X	75-02244
	2X	75-02245
	Silver Mirror	75-01138
	Gold Mirror	75-01135
Facesheid MaxVision	Clear pinlock	75-01136
Storage accessories	Soft carry bag	75-01192
	Faceshield bag	75-01190
	Valise premium bag	75-01195

WINDSHIELDS / FAIRINGS  
AUDIO / COMMUNICATION  
SEATS / LUGGAGE  
BARS / MIRRORS / CONTROLS  
EXHAUST  
AIR / FUEL SYSTEMS  
ENGINE  
TRANSMISSION / DRIVELINE  
GASKETS / SEALS  
ELECTRICAL  
LIGHTING  
CABLES  
BRAKES  
OIL FILTERS  
SUSPENSION  
BODY  
WHEELS  
TIRES / TIRE ACC.  
BIKE ACC.  
VICTORY / INDIAN  
COVERS / LOCKS / TIEDOWNS  
CHEMICALS  
TOOLS  
HELMETS  
HELMET ACC.  
EYEWEAR  
APPAREL / RIDER ACC.  
PROMOTIONAL  
REFERENCE  
INDEX

REPLACEMENT PARTS FOR STREET HELMETS



Tagger  
Ensenada  
Black/  
Orange



Raven  
Neon



Endeavor  
White/Red



Moto Fink  
Titanium



Description	Model/Size/Color	WPS#
<b>EXO-R2000</b>		
Faceshields	Clear	75-01000
	Smoke	75-01001
	Silver Mirror	75-01002
	Gold Mirror	75-01003
Race shield	Clear	75-01007
	Smoke	75-01008
Pinlock Insert	Clear	75-01009
Tear-offs	10PK tear off	75-01010
Aero Skirt	All sizes	75-01020
Kwikwick II Liner Set	XS	75-02000
	S	75-02001
	M	75-02002
	L	75-02003
	XL	75-02004
Kwidkwick II Cheek pads only	2X	75-02005
	XS	75-02200
	S	75-02201
	M	75-02202
	L	75-02203
Dual pane shields	XL	75-02204
	2X	75-02205
		75-01132
Electric Shields		75-01133
Storage accessories	Faceshield bag	75-01190
	Soft carry bag	75-01193
	Valise Premium Bag	75-01195

Description	Model / Size / Color	WPS#	
<b>EXO-R420</b>			
Faceshields	Clear	75-01070	
	Dark Smoke	75-01071	
	Silver Mirror	75-01072	
	Gold Mirror	75-01073	
	Pinlock Maxvision	MaxVision pinlock	75-01074
	Pinlock	Pinlock	75-01075
	Kwickwick Liner	XS	75-02140
S		75-02141	
M		75-02142	
L		75-02143	
XL		75-02144	
2X		75-02145	
Cheekpads	3X	75-02145	
	XS	75-02150	
	S	75-02151	
	M	75-02152	
	L	75-02153	
Storage accessories	XL	75-02154	
	2X	75-02155	
	3X	75-02155	
	Soft carry bag	75-01192	
Storage accessories	Faceshield bag	75-01190	
	Valise premium bag	75-01195	

Moto Fink  
Titanium



Dream  
White



Focus Red



Fuji Blue



Description	Model / Size / Color	WPS#
<b>EXO-R320</b>		
Faceshields	Clear	75-01000
	Smoke	75-01001
	Silver Mirror	75-01002
	Gold Mirror	75-01003
Pinlock shield	Clear	75-02168
	Smoke	75-02169
Pinlock Max shield	Clear	75-01009
Pinlock Max shield	10Pk tear off	75-01010
Aero Skirt		75-01024
Kwickwick II Liner	XS	75-02160
	S	75-02161
	M	75-02162
	L	75-02163
	XL	75-02164
	2X	75-02165
Dual Shield		75-01132
Electric Shield		75-01133
Breathbox		75-01131
Storage accessories	Soft carry bag	75-01192
	Faceshield bag	75-01190
	Valise premium bag	75-01195

Description	Model / Size / Color	WPS#
<b>EXO-R710</b>		
Faceshields	Clear	75-01000
	Smoke	75-01001
	Silver Mirror	75-01002
	Gold Mirror	75-01003
Aero Skirt	All Sizes	75-01022
Kwickwick II Liner Set	XS	75-02020
	S	75-02021
	M	75-02022
	L	75-02023
	XL	75-02024
	2X	75-02025
Dual pane shield	3X	75-02026
		75-01132
Electric shield		75-01133
Storage Accessories	Soft carry bag	75-01192
Storage accessories	Faceshield bag	75-01190
	Valise premium bag	75-01195





REPLACEMENT PARTS FOR STREET HELMETS



Mainstay  
Black/  
Silver



Freeway  
White



Fury Black/  
Pink



Cipher  
Green



Description	Model / Size / Color	WPS#
<b>EXO-T1200</b>		
Faceshield	Clear	75-01000
	Smoke	75-01001
	Silver Mirror	75-01002
	Gold Mirror	75-01003
Sun Visor	Smoke	75-01011
Aero Skirt	All sizes	75-01021
Kwickwick III Liner Set	XS	75-02010
	S	75-02011
	M	75-02012
	L	75-02013
	XS	75-02014
	2X	75-02015
Dual pane shields		75-01132
Electric Shields		75-01133
Storage accessories	Soft carry bag	75-01193
	Faceshield bag	75-01190
	Valise Premium Bag	75-01195

Description	Model / Size / Color	WPS#
<b>EXO-T510</b>		
Faceshields	Clear	75-01000
	Smoke	75-01001
	Silver Mirror	75-01002
	Gold Mirror	75-01003
	Smoke	75-01011
Aero Skirt	All Sizes	75-01023
Kwickwick II Liner Set	XS	75-02030
	S	75-02031
	M	75-02032
	L	75-02033
	XL	75-02034
	2X	75-02035
Dual pane shield		75-01132
Electric Shield		75-01133
Storage accessories	Soft carry bag	75-01192
	Faceshield bag	75-01190
	Valise premium bag	75-01195



REPLACEMENT PARTS FOR STREET HELMETS **SENA**

Gloss Black



Description	Model/Size/Color	WPS#
<b>CALVALRY</b>		
Liner	XS	843-01310XS
	S	843-01310S
	M	843-01310M
	L	843-01310L
	XL	843-01310X
	2X	843-013102X
Ear pads		843-01311
Ear plates		843-01312
Peak/Visor	Gloss Blk	843-01313
	Matte Blk	843-01314
Helmet pouch		843-01315

WINDSHIELDS / FAIRINGS  
AUDIO / COMMUNICATION  
SEATS / LUGGAGE  
BARS / MIRRORS / CONTROLS  
EXHAUST  
AIR / FUEL SYSTEMS  
ENGINE  
TRANSMISSION / DRIVELINE  
GASKETS / SEALS  
ELECTRICAL  
LIGHTING  
CABLES  
BRAKES  
OIL FILTERS  
SUSPENSION  
BODY  
WHEELS  
TIRES / TIRE ACC.  
BIKE ACC.  
VICTORY / INDIAN  
COVERS / LOCKS / TIEDOWNS  
CHEMICALS  
TOOLS  
HELMETS  
HELMET ACC.  
EYEWEAR  
APPAREL / RIDER ACC.  
PROMOTIONAL  
REFERENCE  
INDEX



## L.E.D. WIRELESS BRAKE LIGHT KIT

- The L.E.D. wireless brake light kit offers a visual enhancement to the rear of your helmet when the braking circuit is engaged on your motorcycle or snowmobile
- Wireless design
- Multifunction L.E.D. displays the brake function
- No modification needed to your GMAX helmet. Integrated design
- L.E.D. design is not only bright, but also delivers long battery life
- Transmitter powered by your machines 12v power supply, while the LED light is powered by two AAA batteries
- Not D.O.T. approved
- Quick and Easy installation
- This unit is not intended to replace your factory installed rear brake light on your motorcycle or snowmobile. It is the responsibility of the purchaser to check your state and local regulations before the use of this product
- NOTE: Polaris CFI models will require a CFI adapter for proper installation, WPS# 54-0499

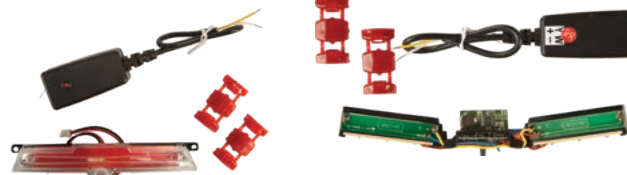

Description	WPS #
L.E.D. Brake Light Kit GM 27/68	72-3568
L.E.D. Brake Light Kit GM 54/67*/78	72-3567



## UNIVERSAL HELMET LIGHT

- Motion activated
- Auto off feature
- Weather resistant
- Ultra-bright L.E.D.'s



WPS#
12-6781
12-6781D



## HELMET LOCKS

- Clamps securely to any 7/8" round tube bar with one way mounting screws
- Helmet rings lock in place with solid tubular lock

Description	WPS#
Chrome helmet lock for 7/8" round bar	27-9005
Chrome helmet lock Universal mount	27-9088
Black helmet lock for 7/8" round bar	27-9006
Black helmet lock Universal mount	27-9087



# HYDRON™ MXL

## ARMOR CLAD & FOG FREE FLIP-UP SHIELDS



### FEATURES RATCHET HINGE

Full-flip shield mounted to a leather grain non-glare peak. Aerodynamic styling gives a clean uncluttered look plus excellent riding characteristics. Designed for maximum safety and convenience. The molded G.E. Lexan polycarbonate fog free shield is treated with Hydron II.

- Armor Clad shields have a hard scratch resistant coating
- Fog Free shields keep your field of vision clear

Description	WPS#
Clear Armor Clad	27-10251
Smoke Armor Clad	27-10271
Hi-visibility Armor Clad	27-10281
Clear Fog Free	27-1025
Smoke Fog Free	27-1027
Clear Uncoated	27-1028
Smoke uncoated	27-1029

Exceeds Z87.1 and VESC-8



## 3 SNAP BUBBLE VISORS

Description	WPS#
Bubble, Black	72-0013



## 3 SNAP FLIP-SHIELD

Description	WPS#
3 Snap shield, Clear	72-0015
3 Snap shield, Smoke	72-0016
Double lens anti-fog, Clear	72-0017



## HYPER SHIELD VISOR INSERT



- Offers absolute fog-free riding in the worst of weather conditions
- InVision® gasket system provides for an easy one-time installation
- Made from the highest quality 20 mil optical grade polycarbonate
- Works with pinned and non-pin locked visors

Description	Smoke
Arai	27-1043

WINDSHIELDS / FAIRINGS  
AUDIO / COMMUNICATION  
SEATS / LUGGAGE  
BARS / MIRRORS / CONTROLS  
EXHAUST  
AIR / FUEL SYSTEMS  
ENGINE  
TRANSMISSION / DRIVELINE  
GASKETS / SEALS  
ELECTRICAL  
LIGHTING  
CABLES  
BRAKES  
OIL FILTERS  
SUSPENSION  
BODY  
WHEELS  
TIRES / TIRE ACC.  
BIKE ACC.  
VICTORY / INDIAN  
COVERS / LOCKS / TIEDOWNS  
CHEMICALS  
TOOLS  
HELMETS  
HELMET ACC.  
EYEWEAR  
APPAREL / RIDER ACC.  
PROMOTIONAL  
REFERENCE  
INDEX



## ANTI-FOG CLEANER

REPELS DUST AND PREVENTS FOGGING ON:

- Goggles
- Helmet / face shields
- Eyeglasses - plastic or glass lenses
- Sunglasses
- Diving masks
- Boat windshields
- Gun scopes
- Camera lenses
- Mirrors



EASY TO USE ENVIRONMENTALLY FRIENDLY NON-TOXIC

Description	WPS#
½ oz. Pump Spray (Display Card)	38-2011
2 oz. Pump Spray Bottle	38-2014
No Fog Cloth (Sold Each)	38-2021
No Fog Cloth (24/Cartron)	38-2022
Counter Display Includes: 9 - ½ oz. Bottles 12 - 2 oz. Bottles 48 - No Fog Cloths	38-2025



## NO-FOG CLOTH

- Reusable 6" x 6" cloth
- Cleans and defogs all goggles, face shields and glasses
- Packed in 3" x 4-1/2" zip lock packet

Description	WPS#
No-Fog Cloth	51-2801
Dealer display box	51-2802

(Not recommended for use on fog-free coated lenses)



Helmet FRESH

## HELMET FRESH

- Helmet Fresh attacks the bacteria and mildew that causes odor
- Nonflammable, nontoxic, noncorrosive and non allergenic
- Clear formula leaves no stain
- Ideal for motorcyclists, snowmobilers and bicyclists
- Keep helmet smelling fresh and clean
- Pump spray into a dry helmet, rub in and let dry for 30 minutes
- Use Helmet Cleaner to thoroughly clean the helmet liner

Description	WPS#
Helmet Fresh Pump Spray 4 oz. 24/case	27-4830
Helmet Cleaner Pump Spray 4 oz. 24/case	27-4831





### HELMET BAG

- Full fleece liner to protect the helmet's paint
- Upper mesh venting allows helmet to dry
- Generous side pockets for additional storage
- Plastic bottom to keep helmet separated from the elements

**WPS#**  
28-5139



### POLAR FLEECE HELMET BAGS

- Fits any helmet style and size
- Soft polar fleece material
- Heavy nylon cord with barrel lock closure
- Protect your costly investment

Color	WPS#
Black	76-0015



### HELMET CLASP

**WPS#**  
27-1083



### ECHO HELMET QUICK RELEASE

- Installs in seconds
- No special tools needed
- Stronger than "D" rings
- Easily released, even with gloves
- Fully adjustable



Color	WPS#
Blue	27-1084B
Green	27-1084G
Red	27-1084R
White	27-1084W
Yellow	27-1084Y
Black	27-1084
Hot Pink	27-1084H

- WINDSHIELDS / FAIRINGS
- AUDIO / COMMUNICATION
- SEATS / LUGGAGE
- BARS / MIRRORS / CONTROLS
- EXHAUST
- AIR / FUEL SYSTEMS
- ENGINE
- TRANSMISSION / DRIVELINE
- GASKETS / SEALS
- ELECTRICAL
- LIGHTING
- CABLES
- BRAKES
- OIL FILTERS
- SUSPENSION
- BODY
- WHEELS
- TIRES / TIRE ACC.
- BIKE ACC.
- VICTORY / INDIAN
- COVERS / LOCKS / TIEDOWNS
- CHEMICALS
- TOOLS
- HELMETS
- HELMET ACC.
- EYEWEAR
- APPAREL / RIDER ACC.
- PROMOTIONAL
- REFERENCE
- INDEX



Since 1996, Bobster® has specialized in designing performance eyewear for active lifestyles and extreme activities. We have built our reputation on durable, functional sunglasses and goggles that stand up to any challenge. Every Bobster® eyewear comes standard with the following features:

- Backed by a No Hassle Lifetime Warranty
- 100% UVA/UVB protection
- Polycarbonate shatter resistant lenses
- Adheres to the American National Standards Institute's Z80.3 standards and specifications

**EYEWEAR CATEGORIES**

<b>Convertible</b>	<b>1150-1154</b>	<b>Convertibles switch easily from glasses to goggles and back, eliminating the need for multiple pairs of eyewear</b>
<b>Photochromic</b>	<b>1154-1156</b>	<b>Photochromic lenses automatically adjust so you can wear your glasses from morning to night</b>
<b>Interchangeable</b>	<b>1157</b>	<b>Interchangeable models feature quick change lenses to suit your riding conditions</b>
<b>Goggles</b>	<b>1158-1160</b>	<b>Strap system makes riding even in the windiest conditions a breeze</b>
<b>Over the Glass</b>	<b>1161</b>	<b>Built to comfortably fit over your prescription glasses</b>
<b>Sunglasses with Foam</b>	<b>1162-1164</b>	<b>Foam inserts are great for restricting wind and dust penetration to eyes when needed</b>
<b>Sunglasses</b>	<b>1165-1166</b>	<b>A stylish, functional piece that works on the bike or off</b>
<b>Women</b>	<b>1167</b>	<b>Fashionable, functional for riding and a comfortable fit</b>

**ICON REFERENCE**



PRESCRIPTION READY



OVER THE GLASS



RAPID INTERLOCK SYSTEM (R.I.S.)



COVERT® FOAM



PHOTOCHROMIC



ANSI Z87.1 CERTIFIED



CE APPROVED



POLARIZED



BALLISTIC CERTIFIED



EN166 APPROVED



FLOATS IN WATER



GREAT FOR SMALLER FACES



ANSI Z87.1-2010+ APPROVED

## LOW RIDER II

Get down with this wrap around eyewear that rides stylishly over the eyes while providing ultimate peripheral vision. Three sets of polycarbonate lenses allow a smooth transition from day riding to evening and night rides. The rugged black matte frame ensures a snug fit, while cushioned by soft open cell foam that absorbs perspiration and keeps out wind and debris.



### Features

- Temple to Temple: 132mm
- Grilamid TR90 Frame
- Open Cell Foam
- Frame size: Medium
- 100% UV protection
- Impact resistant Polycarbonate lenses

### Accessories Included

- 3 Sets of Lenses: Anti-fog Smoked, Amber & Clear
- Removable Goggle Strap
- Microfiber Cloth
- Carry Case

### Frame WPS#

Black 26-4885

## RAPTOR II

Get wrapped up in these classic pieces of eyewear with an aggressively sculpted frames made of Grilamid TR90 in a black matte finish. Three sets of shatter resistant polycarbonate interchangeable lenses include anti-fog smoked, amber and clear lenses. Two sets of removable foam aid in the reduction of wind blasts and prevention of fogging. Finally, the detachable, adjustable strap gives the maximum amount of options for the multiple functions of this pair of eyewear.



### Features

- Temple to Temple: 129mm
- Grilamid TR90 Frame
- RX Ready
- Frame size: Small/Medium
- 100% UV protection
- Impact resistant Polycarbonate lenses

### Accessories Included

- 3 Sets of Lenses: Anti-Fog Smoked, Clear & Amber
- Removable Strap
- 2 Sets of Removable Foam
- Microfiber Cloth
- Carry Case

### Frame WPS#

Black 26-4836

## ROAD HOG II

Regulate the road with this adaptable eyewear that is both convertible and interchangeable. Ideal for use any time of day or night and in any environment, this eyewear features four different sets of interchangeable polycarbonate lenses as well as a detachable, adjustable strap for quick conversion from sunglass to goggle. Two sets of removable foam are included; producing one pair of eyewear that can be worn 24 different ways.



### Features

- Temple to Temple: 133mm
- Grilamid TR90 Frame
- RX Ready



### Accessories Included

- 4 Sets of Lenses: Dual Grade Reflective, Anti-fog Smoked, Amber & Clear
- Removable Goggle Strap
- 2 Sets of Removable Foam
- Microfiber Cloth
- Carry Case

### Frame WPS#

Black 26-4775



WINDSHIELDS / FAIRINGS

AUDIO / COMMUNICATION

SEATS / LUGGAGE

BARS / MIRRORS / CONTROLS

EXHAUST

AIR / FUEL SYSTEMS

ENGINE

TRANSMISSION / DRIVELINE

GASKETS / SEALS

ELECTRICAL

LIGHTING

CABLES

BRAKES

OIL FILTERS

SUSPENSION

BODY

WHEELS

TIRES / TIRE ACC.

BIKE ACC.

VICTORY / INDIAN

COVERS / LOCKS / TIEDOWNS

CHEMICALS

TOOLS

HELMETS

HELMET ACC.

EYEWEAR

APPAREL / RIDER ACC.

PROMOTIONAL

REFERENCE

INDEX

BOBSTER

CONVERTIBLE

## SPEKTRAX

The Spektrax is ideal for riders requiring prescription lenses, this eyewear converts smoothly from sunglass to goggle with the included detachable strap. The removable RX insert fits securely between the shatter-resistant polycarbonate lens and the anti-impact frame which is lined with open cell foam. Excellent peripheral vision is produced from the curved, single-lens geometry. For continued activity through the day and night, the three lens options of anti-fog smoked, amber and clear are included, along with a durable carrying case and microfiber cleaning cloth.

## Features

- Temple to Temple: 147mm
- Polycarbonate Anti-Impact Frame
- Open Cell Foam
- RX Ready with Removable Insert
- Frame size: Large
- 100% UV protection
- Impact resistant Polycarbonate lenses



## Accessories Included

- 3 Sets of Lenses: Anti-fog Smoked, Amber & Clear
- Removable Goggle Strap
- Removable RX Insert
- Microfiber Cloth
- Carry Case



## Frame WPS#

Black	26-4785
-------	---------

## SPORT AND STREET INTERCHANGEABLE

This rugged and reliable convertible eyewear converts from sunglass to goggle, allowing adaptation to any environment. Designed for maximum versatility for those with an active lifestyle, it features three sets of interchangeable lenses and closed cell memory foam around the interior frame for protection and comfort. A perforated frame provides regulated air entry to prevent fogging during rigorous activity.

## Features

- Temple to Temple: 145mm
- Polycarbonate Frame
- Closed Cell Foam
- RX Ready
- Frame size: Medium/Large
- 100% UV protection
- Impact resistant Polycarbonate lenses



## Accessories Included

- 3 Sets of Lenses: Anti-fog Smoked, Amber & Clear
- Removable Goggle Strap
- Microfiber Cloth
- Carry Case



## Frame WPS#

Black	26-4780
-------	---------

## SPORT AND STREET II

Ride smooth with this sleeker, more aerodynamic frame that converts from sunglass to goggle, adapting to essentially any environment or user requirements. For those with an active lifestyle, it features three sets of interchangeable lenses, each lined with closed cell memory foam to maximize comfort and increase durability.

## Features

- Temple to Temple: 145mm
- Polycarbonate Frame
- Closed Cell Foam
- RX Ready
- Frame size: Medium/Large
- 100% UV protection
- Impact resistant Polycarbonate lenses



## Accessories Included

- 3 Sets of Lenses: Anti-fog Smoked, Amber & Clear
- Removable Goggle Strap
- Retainer Strap
- Microfiber Cloth
- Carry Case



## Frame WPS#

Black	26-4781
-------	---------



## TRIDENT

The Trident is one unique sunglass, not only with its styling but also in its functions. This eyewear comes with a polarized smoked lenses plus 2 additional lenses (clear & amber) in order to interchange them according to the weather and lighting conditions. The smoked polarized lenses also come with a hydrophobic lens coating which prevents water for remaining on lenses and makes the lenses easier to clean. A removable closed cell foam and goggle strap are also included with the Trident. A cleaning cloth and carry case are included to easy storage and transport of this eyewear.



## Features

- **POLARIZED** Lens with Hydrophobic Coating
- Temple to Temple: 130mm
- Grilamid TR90 Frame
- Frame size: Medium/Large
- 100% UV protection
- Impact resistant Polycarbonate lenses
- R.I.S. technology
- Removable Covert™ foam
- Polyamide frame



## Accessories Included

- 3 Sets of Lenses: Polarized Smoked, Amber & Clear
- Removable Goggle Strap
- Removable Closed Cell Foam
- Microfiber Cloth
- Carry Case

## Frame WPS#

Black 26-4703

## GUNNER

The Gunner merges fashion with functionality by combining the most desired aspects and features of any eyewear available. The wrap-around Grilamid TR90 frame can be worn either with smooth temples as a sunglass or with a detachable, adjustable strap as a goggle. Vented removable closed cell foam prevents lens fogging and keeps wind and debris from distorting vision. Photochromic lenses that change with altering light allow for greater clarity, while rubber nose pieces create a lightweight, comfortable set of eyewear that allow you to truly enjoy the outdoor excursion of your choice. For night riding the Gunner comes with a set of clear lenses.



## Features

- **PHOTOCHROMIC** Lenses (V.L.T. 47%-15%)
- Temple to Temple: 131mm
- Grilamid TR90 Frame
- RX Ready
- Frame size: Medium
- 100% UV protection
- Impact resistant Polycarbonate lenses
- Polyamide frame
- R.I.S. technology



## Accessories Included

- 2 Sets of Lenses: Photochromic & Clear
- Removable Goggle Strap
- Removable Closed Cell Foam
- Microfiber Cloth
- Carry Case

## Frame WPS#

Black 26-4765

## ROAD MASTER

Dominate the road with this convertible photochromic eyewear. The adjustable strap allows easy conversion from sunglass to goggle, while the photochromic polycarbonate lenses lighten when indoors and darken when exposed to sunlight. Removable closed cell foam adds comfort for extended periods of wear while protecting the eyes from dust and debris.



## Features

- **PHOTOCHROMIC** Lenses (V.L.T. 33%-19%)
- Temple to Temple: 138mm
- Polycarbonate Anti-Impact Frame
- RX Ready
- Frame size: Medium
- 100% UV protection
- Impact resistant Polycarbonate lenses



## Accessories Included

- Removable Goggle Strap
- Removable Closed Cell Foam
- Microfiber Cloth
- Carry Case

## Frame WPS#

Black 26-4770

Note: Generally, photochromic lenses do not darken behind windshields due to the UV protection inherent in the glass.

WINDSHIELDS / FAIRINGS

AUDIO / COMMUNICATION

SEATS / LUGGAGE

BARS / MIRRORS / CONTROLS

EXHAUST

AIR / FUEL SYSTEMS

ENGINE

TRANSMISSION / DRIVELINE

GASKETS / SEALS

ELECTRICAL

LIGHTING

CABLES

BRAKES

OIL FILTERS

SUSPENSION

BODY

WHEELS

TIRES / TIRE ACC.

BIKE ACC.

VICTORY / INDIAN

COVERS / LOCKS / TIEDOWNS

CHEMICALS

TOOLS

HELMETS

HELMET ACC.

EYEWEAR

APPAREL / RIDER ACC.

PROMOTIONAL

REFERENCE

INDEX

# BOBSTER CONVERTIBLE

## RENEGADE

Take the surprise out of the elements with the Renegade: its comfortable, polycarbonate frame is equipped with photochromic lenses that adjust from a light to medium tint, ensuring optimum visibility under any lighting condition. The Renegade transforms effortlessly from sunglass to goggle and comes equipped with a removable closed cell foam insert which seals easily to your face to protect your eyes from dust and wind. A microfiber cleaning cloth and carry case are included.

### Features

- **PHOTOCHROMIC** Lenses (V.L.T. 83%-28%)
- Temple to Temple: 133mm
- Polycarbonate Frame
- Frame size: Medium
- 100% UV protection
- Impact resistant Polycarbonate lenses

### Accessories Included

- Removable Goggle Strap
- Removable Closed Cell Foam
- Microfiber Cloth
- Carry Case

Frame	WPS#
Black	26-4702



## DECODER 2

The Decoder 2 has both style and function with its light changing lenses and the ability to convert from a sunglass to a goggle. The temples easily release with our R.I.S. technology and quickly become a goggle with the included strap. The other unique feature is the closed cell foam, when attached the Decoder 2 is a full frame sunglass but quickly remove it and it becomes a half frame sunglass. The anti-fog lenses lighten or darken in changing lighting conditions. So many variations in ways to wear all in one piece of eyewear!

### Features

- **PHOTOCHROMIC** lenses
  - Anti-fog, 100% UV Protection
  - Polycarbonate lenses
- ### Accessories Included
- Removable Goggle Strap
  - Removable Closed-cell Foam
  - Microfiber Cloth
  - Carry Case

Frame	WPS#
Matte Black	26-4898



# PHOTOCHROMIC

## FAT BOY

The Fat Boy photochromic sunglasses feature the latest in transitional lens technology. They are precision designed to automatically adjust to temperature and the amount of ultraviolet (UV) light that reaches the lens. Featuring anti-fog, polycarbonate lenses, the Fat Boy boasts increased comfort and protection with closed-cell foam padding around the eyes. With an aggressive, stylish thermoplastic frame, the Fat Boy offers stability and versatility with an edge.

### Features

- Anti-Fog **PHOTOCHROMIC** Lenses (V.L.T. 87%- 35%)
- Temple to Temple: 135mm
- Polycarbonate Frame
- Anti-Fog Photochromic Lenses
- Closed Cell Foam
- RX Ready
- Frame size: Medium
- 100% UV Protection
- Impact Resistant Polycarbonate Lenses

### Accessories Included

- Microfiber Pouch

Frame	WPS#
Black	26-4700



Note: Generally, photochromic lenses do not darken behind windshields due to the UV protection inherent in the glass.

FUEL

The Fuel goggle comes with lenses that get darker in the sunlight and a neoprene foam lined with fleece for additional comfort. The lenses are photochromic starting with a light tint (85% V.L.T.) and transform to a medium gray (25% V.L.T.) in bright UV light. The polycarbonate lenses are shatter resistant and come with an anti-fog coating. The Fuel also comes with a microfiber pouch for easy transport.



Features

- Anti-Fog PHOTOCHROMIC Lenses (V.L.T. 85%-25%) (Yellow V.L.T. 72%-19%)
- Temple to Temple: 135mm
- Polyurethane Frame
- Adjustable Goggle Strap
- Neoprene Foam with Fleece
- RX Ready
- Frame size: Medium
- 100% UV Protection
- Impact Resistant Polycarbonate Lenses



Accessories Included

- Microfiber Pouch

Lens	WPS#
Clear	26-4724
Yellow	26-4725

HOOLOGAN

The Hooligan is a sleek and stylish sunglass with photochromic lenses that allow you to use them in all lighting conditions. The frames wrap around the face and has a slight "cup" on the edges of the frame to minimize wind disruptions without the need for foam. The lenses are photochromic starting with a light tint (85% transmission) and transform to a medium grey (25% transmission) in bright light. The Hooligan also comes with a microfiber pouch for easy transport.



Features

- PHOTOCHROMIC Lenses (85% V.L.T.- 26% V.L.T.)
- Temple to Temple: 130mm
- Grilamid TR90 Frame
- Rubber "cup" on Frame Edges around Eyes
- RX Ready
- Frame size: Medium
- 100% UV Protection
- Impact Resistant Polycarbonate Lenses



Accessories Included

- Microfiber Pouch

Frame	WPS#
Black	26-4805

IGNITER

The Igniter is a compact goggle with photochromic lenses so they can be used in all lighting conditions. The closed cell foam helps to create a wind free environment to eliminate eye tearing. The lenses are photochromic starting with a light tint (85% transmission rate) and transform to a medium gray (25% transmission rate) in bright UV light. The polycarbonate lenses are shatter resistant and come with an anti-fog coating. The Igniter also comes with a microfiber pouch for easy transport.



Features

- Anti-Fog PHOTOCHROMIC Lenses (V.L.T. 85%-25%)
- Length: 133mm
- Rubber Frame
- Adjustable Goggle Strap
- Floats in Water
- Closed Cell Foam
- RX Ready
- Frame size: Small/Medium
- 100% UV Protection
- Impact Resistant Polycarbonate Lenses



Accessories Included

- Microfiber Pouch

Frame	WPS#
Black	26-4812

- WINDSHIELDS / FAIRINGS
- AUDIO / COMMUNICATION
- SEATS / LUGGAGE
- BARS / MIRRORS / CONTROLS
- EXHAUST
- AIR / FUEL SYSTEMS
- ENGINE
- TRANSMISSION / DRIVELINE
- GASKETS / SEALS
- ELECTRICAL
- LIGHTING
- CABLES
- BRAKES
- OIL FILTERS
- SUSPENSION
- BODY
- WHEELS
- TIRES / TIRE ACC.
- BIKE ACC.
- VICTORY / INDIAN
- COVERS / LOCKS / TIEDOWNS
- CHEMICALS
- TOOLS
- HELMETS
- HELMET ACC.
- EYEWEAR
- APPAREL / RIDER ACC.
- PROMOTIONAL
- REFERENCE
- INDEX

**BOBSTER****PHOTOCHROMIC****INVADER**

The Invader is for the practical, yet style conscience person. The wrap around frame is made of flexible, durable Grilamid TR90 and the fleece lined open cell foam keep the wind and debris out of your eyes. Continuous wearing of this piece of eyewear from day into night is due to the photochromic lenses, which adjust to UV light. The lenses are shatter-resistant polycarbonate and optically correct so there is no distortion. The Invader comes with a carry case and microfiber cleaning cloth.

**Features**

- **PHOTOCHROMIC** Polycarbonate Lenses (V.L.T. 47% - 15% )
- Temple to Temple: 125mm
- Grilamid TR90 Frame
- Fleece-lined Open Cell Foam
- Frame size: Medium
- 100% UV Protection
- Impact Resistant Polycarbonate Lenses

**Accessories Included**

- Cleaning Cloth
- Carry Case

**Frame Lens WPS#**

Black	Grey	<b>26-4995</b>
-------	------	----------------

**RUKUS**

The Rukus combines function and style into one seamless sunglass. Not only does it have removeable closed cell foam, but it also has anti-fog photochromic lenses. These features allow use in your everyday life or while you're participating in your favorite sport. The Rukus also comes with a carry case and microfiber cleaning cloth to keep these sunglasses in the best shape possible.

**Features**

- Anti-Fog **PHOTOCHROMIC** Lenses (83% V.L.T.- 28% V.L.T.)
- Temple to Temple: 130mm
- Grilamid TR90 Frame
- RX Ready
- Frame size: Medium
- 100% UV Protection
- Impact Resistant Polycarbonate Lenses

**Accessories Included**

- Removable Closed Cell Foam
- Microfiber Cloth
- Carry Case

**Frame WPS#**

Black	<b>26-4865</b>
-------	----------------

**FLUX**

The all new Flux goggles features a low profile frame and anti-fog photochromic lenses, which darken in the sunlight. Dual layer neoprene and open cell foam create a durable, yet effective seal to keep wind and debris from affecting your vision. The photochromic lenses start out almost clear (V.L.T. 85%) and go to a light smoked (V.L.T. 32%) while in bright sunlight. The Flux also comes with a microfiber pouch for easy cleaning and transport.

**Features**

- Dual layer- Neoprene & Open Cell Foam
- Anti-fog, 100% UV Protection Lens
- **PHOTOCHROMIC** Polycarbonate

**Accessories Included**

- Microfiber Pouch

**Frame WPS#**

Black	<b>26-4887</b>
-------	----------------



## BUGEYE II

The Bugeye II is the ideal goggle for maximum flexibility and comfort. The molded plastic frame adjusts to head shape, allowing for excellent peripheral vision. The soft foam liner ensures comfort by molding to fit facial contours. The shatter-resistant, polycarbonate lenses protect against 100% UVA and UVB ultraviolet rays.



## Features

- Length: 155mm
- Polymer Elastomer Frame
- Open Cell Foam
- RX Ready
- Frame size: Small/Medium
- 100% UV protection
- Impact resistant Polycarbonate lenses

## Accessories Included

- 3 Sets of Lenses: Anti-fog Smoked, Clear & Amber
- Microfiber Cloth
- Carry Case

Frame	WPS#
Black	26-4745

## CRUISER II

The Cruiser II's versatility makes it the goggle of choice for the true adventurer. The Cruiser II includes a flexible and sturdy Grilamid frame with ventilation ports to minimize internal fog buildup. The Cruiser II also includes a protective carrying case and a cleaning cloth.



## Features

- Length: 142mm
- Polymer Elastomer Frame
- Open Cell Foam
- RX Ready
- Frame size: Large
- 100% UV protection
- Impact resistant Polycarbonate lenses

## Accessories Included

- 3 Sets of Lenses: Anti-fog Smoked, Clear & Amber
- Microfiber Cloth
- Carry Case

Frame	WPS#
Black	26-4760

## ENFORCER

The Enforcer is one tough looking eyewear. The single shield lens wraps around the face with the frame has a lip at the top to protect against wind and debris. Three lenses (anti-fog smoked, clear and amber) are included so that lenses can be changed according to the current lighting conditions. The Enforcer comes with a cleaning cloth and carry case.



## Features

- Temple to Temple: 140mm
- Polycarbonate Frame
- Single Lens Design
- Frame size: Medium/Large
- 100% UV protection
- Impact resistant Polycarbonate lenses

## Accessories Included

- 3 Sets of Lenses: Anti-fog Smoked, Clear & Amber
- Microfiber Cloth
- Carry Case

Frame	WPS#
Black	26-4705

WINDSHIELDS / FAIRINGS

AUDIO / COMMUNICATION

SEATS / LUGGAGE

BARS / MIRRORS / CONTROLS

EXHAUST

AIR / FUEL SYSTEMS

ENGINE

TRANSMISSION / DRIVELINE

GASKETS / SEALS

ELECTRICAL

LIGHTING

CABLES

BRAKES

OIL FILTERS

SUSPENSION

BODY

WHEELS

TIRES / TIRE ACC.

BIKE ACC.

VICTORY / INDIAN

COVERS / LOCKS / TIEDOWNS

CHEMICALS

TOOLS

HELMETS

HELMET ACC.

EYEWEAR

APPAREL / RIDER ACC.

PROMOTIONAL

REFERENCE

INDEX

## PILOT

The Pilot showcases a combination of retro and modern styling with its sleek aviator styled black frame and leather-like cushioned padding. It also comes with interchangeable polycarbonate lenses that offers the ability to easily switch between smoked and clear lenses to accommodate an all-day ride in a variety of lighting conditions.

## Features

- Polycarbonate Frame
- Leather Padded Foam
- 100% UV Protection
- Anti Fog Lenses
- Impact Resistant Polycarbonate Lenses

## Accessories Included

- Interchangeable lenses, Smoked and Clear
- XL Microfiber Pouch

Frame	WPS#
Black	26-5073



## BUGEYE

This extreme sport eyewear includes open cell sweat absorbing foam around the frame for ultimate protection. A vented, flexible plastic frame encloses polycarbonate lenses and is low profile enough to fit under a helmet.

## Features

- Length: 156mm
- Flexible Molded Plastic Frame
- Adjustable Goggle Strap
- Open Cell Foam
- RX Ready
- Frame size: Medium/Large
- 100% UV protection
- Impact resistant Polycarbonate lenses

## Accessories Included

- Microfiber Cloth

Lens	Black Frame
Smoke	26-4740
Amber	26-4741
Clear	26-4742
Smoke Reflective	26-4744



## CROSSFIRE

The Crossfire Folding goggle is the perfect solution for any rider who needs quality, affordability and practicality. Its small size makes this goggle perfect to take anywhere you go. It is stored in a mini storage pouch which is small enough to be held in your pocket. This goggle comes standard with the durable and flexible Grilamid TR-90 frame and 100% UVA/UVB protected anti-fog gray polycarbonate lenses. The soft adjustable strap is barely noticeable and will keep your goggle snug over your eyes.

## Features

- Temple to Temple: 135mm
- Polymer Elastomer Frame
- Anti-Fog Lenses
- Adjustable Goggle Strap
- Open Cell Foam
- Frame size: Small
- 100% UV protection
- Impact resistant Polycarbonate lenses

## Accessories Included

- Microfiber Cloth
- Mini Carry Case

Lens	WPS#
Smoke	26-4915
Clear	26-4916
Amber	26-4919



Folded

## CRUISER

The Cruiser goggle is stylish and ideal for riding, sky-diving and any other activities requiring eye protection. Open cell foam adds comfort and creates a sealed fit in order to keep out wind. Ventilation slits on each side of the frame and an anti-fog coating prevent the lenses from fogging to ensure visual clarity.



## Features

- Length: 129mm
- Polymer Elastomer Frame
- Anti-Fog Lenses
- Adjustable Goggle Strap
- Open Cell Foam
- RX Ready
- Frame size: Medium/Large
- 100% UV protection
- Impact resistant
- Polycarbonate lenses

## Accessories Included

- Microfiber Pouch

Lens	WPS#
Smoke	26-4750
Amber	26-4751
Clear	26-4752
Smoke Reflective	26-4753

## ROAD RUNNER

The Road Runner is great for those people looking for a goggle to fit smaller faces or even children. The frames are flexible and have closed cell foam to block wind and debris, while ventilation slits on the side of the frame help prevent lens fogging. A microfiber pouch is also included for easy transport.



## Features

- Length: 118mm
- Rubber Frame
- Adjustable Goggle Strap
- Neoprene Foam
- Great for smaller faces and/or children
- RX Ready
- Frame size: X-Small/Small
- 100% UV protection
- Impact resistant
- Polycarbonate lenses

## Accessories Included

- Microfiber Pouch

Frame	WPS#
Black	26-4912

## PISTON

The aerodynamic Piston provides ultimate comfort and flair with exceptional functionality. Ventilation slits on the top, bottom, and sides of the frame prevent lens fogging. The shatter resistant polycarbonate lenses are optically correct to eliminate distortion. The adjustable strap and flexible frame material create a versatile fit while open cell foam cushions the face and absorbs sweat. Included with the goggle is a microfiber pouch that also functions as a cleaning cloth.



## Features

- Length: 143mm
- Flexible Rubber Frame
- Adjustable Goggle Strap
- Open Cell Foam
- RX Ready
- Frame size: Small/Medium
- 100% UV protection
- Impact resistant
- Polycarbonate lenses

## Accessories Included

- Microfiber Pouch

Lens	WPS
Clear	26-4940
Smoke	26-4941
Smoke reflective	26-4942
Amber	26-4943

WINDSHIELDS / FAIRINGS

AUDIO / COMMUNICATION

SEATS / LUGGAGE

BARS / MIRRORS / CONTROLS

EXHAUST

AIR / FUEL SYSTEMS

ENGINE

TRANSMISSION / DRIVELINE

GASKETS / SEALS

ELECTRICAL

LIGHTING

CABLES

BRAKES

OIL FILTERS

SUSPENSION

BODY

WHEELS

TIRES / TIRE ACC.

BIKE ACC.

VICTORY / INDIAN

COVERS / LOCKS / TIEDOWNS

CHEMICALS

TOOLS

HELMETS

HELMET ACC.

EYEWEAR

APPAREL / RIDER ACC.

PROMOTIONAL

REFERENCE

INDEX

BOBSTER

## GOGGLES

## TOURING II

## Features

- Temple to Temple: 125mm
- Polymer Elastomer Frame
- Anti-Fog Lenses
- Adjustable Goggle Strap
- Open Cell Foam
- RX Ready
- Frame size: Large
- 100% UV Protection
- Impact Resistant Polycarbonate Lenses

## Accessories Included

- Microfiber Pouch

Lens	WPS#
Smoke	26-4790
Clear	26-4792

Test the limits while on the road with these durable and flexible goggles, which allow continuous clarity and comfort. Made of polymer elastomer material, the frame is shock-resistant, non-allergenic and lightweight. Airflow is regulated through vented slots on the frame front which prevent fogging. Open cell foam absorbs sweat and retains vision clarity by excluding dust and debris.



## WRAP AROUND

The Wrap Around is a comfortable and very effective goggle. It features a single piece of shatter resistant polycarbonate lens designed to maximize peripheral vision and protection while minimizing bulk. The wrap around foam controls airflow and minimizes fogging. The Wrap Around has an adjustable strap, flexible wrap around lens, and soft foam lining.

## Features

- Length: 153mm
- Frameless Design
- Adjustable Goggle Strap
- Neoprene Foam
- Frame size: Fits most
- 100% UV protection
- Impact resistant Polycarbonate lenses

## Accessories Included

- Microfiber Pouch

Lens	Black Frame
Smoke	26-4795
Clear	26-4796
Amber	26-4797
Yellow	26-4798



## BALA

The Bala goggles are ANSI Z87 safety certified providing peace of mind knowing your eyes are protected, allowing you to enjoy extreme activities. Anti-fog lenses ensure visual clarity while the foam padding provides comfort for all day use. The straps swivel hinges allow use and comfort with a helmet or without. The Bala comes with a microfiber pouch for storage and cleaning.

## Features

- Length 145mm
- Polyester Elastomer
- Closed Cell Foam
- Frame size: Fits most
- 100% UV protection
- Impact resistant Polycarbonate lenses

## Accessories Included

- Microfiber Pouch

Lens	WPS #
Smoked	26-4017
Clear	26-4018
Yellow	26-4019





**CONDOR - OTG**

Prevent the hassle of carrying around multiple sets of eyewear with this single pair of over the glass eyewear. These glasses fit over most prescription glasses and the polycarbonate lenses are coated with anti fog to ensure visual clarity



- Features**
- Temple to Temple: 143mm
  - Polycarbonate Frame
  - Anti-Fog Lenses
  - Fits Over Prescription Glasses
  - Frame size: Medium
  - 100% UV Protection
  - Impact Resistant Polycarbonate Lenses

**Accessories Included**

- Microfiber Pouch

Size	Lens	WPS#
Small	Smoke	26-4895
Medium	Smoke	26-4832
Large	Smoke	26-4894

The Night Hawk is the ideal solution for the rider who requires prescription glasses. The goggle fits over most RX glasses and comes with a single anti-fog lens. The flexible polyurethane frame has double layer foam (neoprene and open cell) for added comfort and to seal out wind and dust. The scratch resistant, polycarbonate lens offers 100% UVA/UVB protection. This eyewear comes with a cleaning cloth and carry pouch.



- Features**
- Length: 163mm
  - Polyurethane Frame
  - Anti-Fog Smoked Lens
  - Adjustable Goggle Strap
  - Double Layer Neoprene Foam
  - Fits Over Prescription Glasses
  - Frame size: Large
  - 100% UV Protection
  - Impact Resistant Polycarbonate Lenses

**Accessories Included**

- Carry Case
- Microfiber Cloth

Lens	WPS#
Smoked	26-4930
Clear	26-4721
Photochromic	26-5025

**PHOENIX - OTG**

The Phoenix is the ultimate in goggles. It features a unique side groove which allows the goggles to be worn over glasses (OTG) and has 2 layers of high performance foam to create a seal around the eyes. The Phoenix comes with 3 sets (smoke, amber and clear) of anti-fog coated lenses, allowing the rider to switch out the lenses according to ambient light conditions. Comes with a carry pouch and cleaning cloth.



- Features**
- Length: 160mm
  - Polyurethane Frame
  - Neoprene Foam
  - Fits Over Prescription Glasses
  - Frame size: Medium
  - 100% UV protection
  - Impact resistant Polycarbonate lenses

**Accessories Included**

- 3 Sets of Lenses: Anti-Fog Smoked, Clear & Amber
- Carry Case
- Microfiber Cloth

Frame	WPS#
Black	26-4965

- WINDSHIELDS / FAIRINGS
- AUDIO / COMMUNICATION
- SEATS / LUGGAGE
- BARS / MIRRORS / CONTROLS
- EXHAUST
- AIR / FUEL SYSTEMS
- ENGINE
- TRANSMISSION / DRIVELINE
- GASKETS / SEALS
- ELECTRICAL
- LIGHTING
- CABLES
- BRAKES
- OIL FILTERS
- SUSPENSION
- BODY
- WHEELS
- TIRES / TIRE ACC.
- BIKE ACC.
- VICTORY / INDIAN
- COVERS / LOCKS / TIEDOWNS
- CHEMICALS
- TOOLS
- HELMETS
- HELMET ACC.
- EYEWEAR**
- APPAREL / RIDER ACC.
- PROMOTIONAL
- REFERENCE
- INDEX

**SUNGLASS WITH FOAM****DESPERADO**

The Desperado's wrap style is perfect to keep the elements from interfering with your riding experience. Closed cell foam on the frame virtually eliminates tearing of the eyes. Large lenses offer great peripheral vision and also have small slits in the corners for venting.

**Features**

- CE Approved
- They Float!
- Closed-cell Foam
- Frame size: Large
- 100% UV Protection
- Polycarbonate Frame
- Impact Resistant Polycarbonate Lenses

**Accessories Included**

- Microfiber Pouch

Lens	WPS#
Smoke	26-4944
Clear	26-4945
Yellow	26-4946

**FOAMERZ**

Cushion with comfort with these wrap around sunglasses that stay put and fit easily under a helmet, providing all the benefits of a goggle in a sunglass style. This polycarbonate, lightweight frame holds curved arms that hug the head while anti-fog, polycarbonate lenses protect the eyes. A durable carrying case is included as well for convenient transport and protection.

**Features**

- Temple to Temple: 133mm
- Polycarbonate Frame
- Anti-Fog Lenses
- Closed Cell Foam
- Frame size: Medium/Large
- 100% UV Protection
- Impact Resistant Polycarbonate Lenses

**Accessories Included**

- Carry Case

Lens	WPS#
Smoke	26-4710
Clear	26-4711
Amber	26-4712

**FOAMERZ II**

An updated version of our extremely popular Foamerz, these wrap around sunglasses are available in smoked, clear or amber anti-fog polycarbonate lenses. Closed cell foam allows ventilation while providing a cushioned lining to protect the eyes from wind and dust while flying down the road. The flexible, polycarbonate frame wraps securely around the face while rubber strips at the tip of each temple keeps the eyewear in place. For effortless transport, a microfiber pouch is also included.

**Features**

- Temple to Temple: 126mm
- Polycarbonate Frame
- Anti-Fog Lenses
- Closed Cell Foam
- They Float!
- ANSI Z87.1-2003 Approved
- Frame size: Medium
- 100% UV Protection
- Impact Resistant Polycarbonate Lenses

**Accessories Included**

- Microfiber Pouch

Lens	WPS#
Smoke	26-4713
Amber	26-4714
Clear	26-4715



SUNGLASSES WITH FOAM



GXR

The GXR series feature wrap around polycarbonate frames and includes a detachable strap, allowing use as a sunglass with the extra security of knowing they will remain in place. The anti-fog polycarbonate lenses are available in smoked, amber or clear while cell foam adjusts to facial contours allowing the optimal amount of air flow.



- Features
- Temple to Temple: 125mm
  - Polycarbonate Frame
  - Anti-Fog Lenses
  - Closed Cell Foam
  - RX Ready
  - They Float!
  - Frame size: Medium
  - 100% UV Protection
  - Impact Resistant Polycarbonate Lenses
- Accessories Included
- Removable Strap
  - Microfiber pouch



Lens	WPS#
Smoke	26-4905
Amber	26-4906
Clear	26-4907
Smoke Blue mirror	26-4893

SHIELD II

The Shield II offers a “frameless” construction. The temples feature a unique inset logo panel and hold the one-piece lenses in place comfortably and securely. The lenses themselves are precision crafted of shatter resistant polycarbonate, and feature a contoured foam lining around the perimeter of the lens.



- Features
- Temple to Temple: 133mm
  - Frameless Design
  - Closed Cell Foam
  - Frame size: Medium
  - 100% UV Protection
  - Impact Resistant Polycarbonate Lenses
- Accessories Included
- Microfiber Pouch



Lens	WPS#
Smoke	26-4820
Clear	26-4821
Amber	26-4822
Yellow	26-4823

WINDSHIELDS / FAIRINGS

AUDIO / COMMUNICATION

SEATS / LUGGAGE

BAR / MIRRORS / CONTROLS

EXHAUST

AIR / FUEL SYSTEMS

ENGINE

TRANSMISSION / DRIVELINE

GASKETS / SEALS

ELECTRICAL

LIGHTING

CABLES

BRAKES

OIL FILTERS

SUSPENSION

BODY

WHEELS

TIRES / TIRE ACC.

BIKE ACC.

VICTORY / INDIAN

COVERS / LOCKS / TIEDOWNS

CHEMICALS

TOOLS

HELMETS

HELMET ACC.

EYEWEAR

APPAREL / RIDER ACC.

PROMOTIONAL

REFERENCE

INDEX

**BOBSTER****SUNGLASSES WITH FOAM****CHAMBER**

The Chamber sunglasses offer function and style in one. It features removable closed cell foam and anti-fog lenses that provide 100% UV protection. With the nose bridge being narrow and deeper than most other glasses these are great for those looking for "asian fit" glasses. The lenses also sit higher on the face to avoid the bottom of the lenses resting on your cheeks. Overall these are one great piece of eyewear everyone will appreciate.

## Features

- Removable Closed-cell Foam
  - Anti-fog, 100% UV Protection
  - Polycarbonate lenses
- Accessories Included
- Microfiber pouch



Frame	Lens	WPS#
Black	Smoked	<b>26-4888</b>
Black	Clear Reflective	<b>26-4889</b>
Black	Yellow	<b>26-4890</b>

**FAT BOY**

Fast and Furious, the Fat Boy sunglasses feature one of our best fitting frames with closed cell foam improving comfort and prevents wind or debris from impairing vision. Smoked lenses with blue mirror coating. Anti-fog, polycarbonate lenses ensuring your lenses will not shatter if impacted at high speeds. A microfiber pouch is included for easy cleaning and transport.

## Features

- Closed-cell Foam
  - Anti-fog, Blue Mirror Coating lens with 100% UV Protection
  - RX ready
- Accessories Included
- Microfiber pouch



Frame	Lens	WPS#
Black	Smoked blue mirror	<b>26-4891</b>



## AXL

The AXL keeps you rolling down the road with wrap around lenses in 3 colors: Clear, Smoke, and Amber. The dual material construction of the frame alleviates discomfort and provides flexibility which reduces pinching.



### Features

- Polycarbonate Frame
- Frame size: Medium/Large
- 100% UV Protection
- Impact Resistant Polycarbonate Lenses

Accessories Included

- Microfiber Pouch

Lens	WPS#
Smoke	<b>26-4991</b>
Clear	<b>26-4992</b>
Yellow	<b>26-4993</b>

## CHARGER

The Charger features ANSI Z87 certified, anti fog, polycarbonate lenses and clean wrap around lines: it's an excellent choice for safety AND style. The durable, high-gloss, black nylon frame fits securely and comfortably, even on smaller faces. The Charger comes with a microfiber pouch for easy transport and cleaning. Available with smoked or clear lenses.



### Features

- Temple to Temple: 132mm
- Nylon Frame with 9 Base Curve
- Anti-Fog Lenses
- ANSI Z87.1-2003 Approved
- Frame size: Small/Medium
- 100% UV Protection
- Impact Resistant Polycarbonate Lenses

Accessories Included

- Microfiber Pouch

Lens	WPS#
Smoke	<b>26-4860</b>
Clear	<b>26-4861</b>
Rose	<b>26-4896</b>

## CAPONE

The Capone features a masculine square-shaped frame design with a luxurious soft touch finish. Its polycarbonate lenses are shatter resistant with an anti-fog coating. The Capone is lightweight and has a low base curved frame that comfortably fit most faces.



### Features

- Anti-Fog Lenses
  - 100% UV Protection
  - Impact Resistant Polycarbonate Lenses
  - Matte Black TR-90 Frame
- Accessories Included
- Microfiber Pouch

Lens	WPS#
Smoked	<b>26-5074</b>

WINDSHIELDS / FAIRINGS

AUDIO / COMMUNICATION

SEATS / LUGGAGE

BARS / MIRRORS / CONTROLS

EXHAUST

AIR / FUEL SYSTEMS

ENGINE

TRANSMISSION / DRIVELINE

GASKETS / SEALS

ELECTRICAL

LIGHTING

CABLES

BRAKES

OIL FILTERS

SUSPENSION

BODY

WHEELS

TIRES / TIRE ACC.

BIKE ACC.

VICTORY / INDIAN

COVERS / LOCKS / TIEDOWNS

CHEMICALS

TOOLS

HELMETS

HELMET ACC.

EYEWEAR

APPAREL / RIDER ACC.

PROMOTIONAL

REFERENCE

INDEX

## PARAGON

## Features

- Frame Size: Large
- Polycarbonate Frame
- Polycarbonate impact resistant lenses
- 100% UV protection

## Accessories Included

- Microfiber pouch

Frame	Lens	WPS#
Matte Black	Red mirror	26-5023
Crystal Clear	Blue mirror	26-5024
Matte Black	Smoked	26-4886



## RYVAL II

The Ryval's sleek half frame suits all faces, and features an adjustable nose piece to ensure a perfectly customized fit. Keep the look of a normal sunglass while getting all the functionality of performance eyewear with the low profile foam and ANSI Z87 safety rating. The polycarbonate lenses are anti-fog coated to ensure visual clarity. The Ryval turns heads with the subtle look in a matte finish and is complete with all the accessories including removable foam, low profile retainer strap, and more!

## Features

- Frame size: Small/Medium
- Grilamid TR90 Frame
- Adjustable Nose Piece
- 100% UV Protection
- Impact Resistant Polycarbonate Lenses
- ANSI Z87.1-2010+ Approved
- OSHA Complaint

## Accessories Included

- Microfiber Pouch
- Removable Foam
- Carry Case

Frame	Lens	WPS#
Black	Smoked	26-4983
Black	Clear	26-4892



## VIRTUE

Virtue is one killer looking sunglass. The frame is durable and functional offering rubber temples and nose pieces. The matte black frame wraps slightly around the face and the smoked lenses have a special coating to keep smudges and water off your lenses for clear vision. The shatter resistant polycarbonate lenses also have an anti-fog coating to ensure visual clarity. The Virtue comes with a microfiber pouch and zipper carrying case.

## Features

- Super hydrophobic/oleophobic lens coating
- 100% UV Protection
- Anti-fog, smoked lens

## Accessories Included

- Microfiber Pouch
- Removable Foam
- Microfiber pouch
- Carry case

Frame	WPS#
Matte Black	26-4897



**SCARLET**

The Scarlet is a sunglass built specifically for women riders who want it all...style and function in one. The black, lightweight frame is lined with foam to reduce wind blasts. The lenses are anti-fog to ensure visual clarity at all times. On the temples is a subtle flower design to add a hint of femininity, but the Z87 certification ensures the toughness of this eyewear.



**Features**

- Frame Size: Small-Women's
- Grilamid TR90
- Anti-Fog Lenses
- Neoprene & Open Cell Foam
- ANSI Z87.1-2010 + Approved
- RX Ready
- 100% UV Protection
- Impact Resistant Polycarbonate Lenses



**Accessories Included**

- Microfiber Pouch

Frame	Lens	WPS#
Tortoise Olive	Smoke	26-4975



**AVA**

The AVA combines great functionality with fashionable good looks...and is designed just for women.



**Features**

- Polycarbonate lens
- Grilamid TR90 Frame
- RX Ready
- Frame size: Medium
- 100% UV Protection
- Impact Resistant Polycarbonate Lenses
- R.I.S. Technology
- Removable Covert™ Foam

**Accessories Included**

- Goggle Strap
- Microfiber Pouch
- Carry Case
- Removable Covert Foam

	Frame	Lens Color	WPS#
A	Black	Smoke	26-4726
B	Black Pearl	Smoke	26-4732



WINDSHIELDS / FAIRINGS

AUDIO / COMMUNICATION

SEATS / LUGGAGE

BAR / MIRRORS / CONTROLS

EXHAUST

AIR / FUEL SYSTEMS

ENGINE

TRANSMISSION / DRIVELINE

GASKETS / SEALS

ELECTRICAL

LIGHTING

CABLES

BRAKES

OIL FILTERS

SUSPENSION

BODY

WHEELS

TIRES / TIRE ACC.

BIKE ACC.

VICTORY / INDIAN

COVERS / LOCKS / TIEDOWNS

CHEMICALS

TOOLS

HELMETS

HELMET ACC.

**EYEWEAR**

APPAREL / RIDER ACC.

PROMOTIONAL

REFERENCE

INDEX



**THROWBACK SHADES BY**

**MINTY**

Step into the past with this classic throwback sunglass that features stylish oversized frames with metal accents. Polycarbonate lenses provide 100% UV & shatter resistant protection. Available in five color ways and a variety of lens options.



**NVS**

Hit the road with an iconic sunglass that will take you from ordinary to extraordinary. With a rounded frame, this classic pair comes in four different color ways and a variety of lens options.



**TRENDSETTER**

This throwback style eyewear showcases a combination of class and style reminiscent of the 1960's. Mixing the old with the new, we have created a retro and modern sunglass with a small square frame that comes in four different color ways and a variety of lens options.



**WINNA**

This pair of vintage shades is a must have piece featuring a mix of both classic and trendy styling. This eyewear is not only comfortable to wear, but boasts a design that highlights any lifestyle. Polycarbonate lenses provide 100% UV & shatter resistant protection. Available in five colorways and a variety of lens options



Description	WPS #
<b>MINTY SUNGLASSES</b>	
A Matte black frame w/ smoked lens	26-5011
B Tortoise frame w/ smoked lens	26-5012
C Matte gray frame w/ smoked blue lens	26-5013
D Clear frame w/ smoked crimson lens	26-5014
E Blue and orange frame w/ smoked yello lens	26-5015
<b>NVS SUNGLASSES</b>	
F Gloss black w/ smoked lens	26-5016
G Matte white w/ smoked reflective lens	26-5017
H Black gradient w/ smoked crimson lens	26-5018
I Matte gunmetal w/ smoked cyan mirror lens	26-5019

Description	WPS #
<b>TRENDSETTER SUNGLASSES</b>	
J Black gradient w/ smoked purple lens	26-5064
K Tortoise and black frame w/ brown lens	26-5065
L Mint frame w/ smoke lens	26-5066
M Wine frame w/ smoked purple lens	26-5067
<b>WINNA SUNGLASSES</b>	
N Matte black frame w/ smoked green lens	26-5068
O Tortoise frame w/ smoked green lens	26-5069
P Steel blue frame w/ smoke purple lens	26-5070
Q Black gradient w/ smoked lens	26-5071
R Matte olive w/ smoked lens	26-5072



**SUNGLASSES**



ZANheadgear now offers the same great quality you've come to expect from our headwear in a line of sunglasses designed specifically for riders. The frames are available either with or without foam, and the comfortable wrap styling blocks wind on the road. The 100% polycarbonate frames and lenses offer 100% UV protection and are shatter resistant. 18 piece pre-packs only.



**SUNGLASSES WITH FOAM**

	Lens	WPS#
A Arizona	Smoked	<b>26-5000S</b>
	Clear	<b>26-5000C</b>
	Yellow	<b>26-5000Y</b>
B California	Smoked	<b>26-5001S</b>
	Clear	<b>26-5001C</b>
C Colorado	Smoked	<b>26-5002S</b>
	Clear	<b>26-5002C</b>
D Hawaii	Smoked	<b>26-5004S</b>
	Clear	<b>26-5004C</b>
E New York	Smoked	<b>26-5007S</b>
	Clear	<b>26-5007C</b>
F Texas	Smoked	<b>26-5009S</b>
	Clear	<b>26-5009C</b>
G Seattle black frame	Clear	<b>26-5078</b>
H Seattle black and pink frame	Smoked	<b>26-5079</b>
I Seattle pink frame	Smoked	<b>26-5080</b>

**SUNGLASSES WITHOUT FOAM**

Description	Lens	WPS#
A Florida	Smoked	<b>26-5003S</b>
	Clear	<b>26-5003C</b>
	Yellow	<b>26-5003Y</b>
B Boise black frame	Smoked	<b>26-5075</b>
C Boise crystal brown frame	Smoked	<b>26-5076</b>
D Boise crystal purple	Smoked	<b>26-5077</b>
E Iowa	Smoked	<b>26-5005S</b>
	Clear	<b>26-5005C</b>
F New Jersey	Smoked	<b>26-5006S</b>
	Clear	<b>26-5006C</b>
G South Dakota	Smoked	<b>26-5008S</b>
	Clear	<b>26-5008C</b>
H Utah	Smoked	<b>26-5010S</b>
	Clear	<b>26-5010C</b>

**DISPLAY PRE-PACKS**

I Mixed Foam		<b>26-5020</b>
J All Foam Styles		<b>26-5021</b>
K No Foam Styles		<b>26-5022</b>
L Zan Women Sunglasses	6 pc pre-pack	<b>26-5215</b>

I  
**26-5020**  
Spinner - Mixed

**PRE-PACK INCLUDES**

- Holds 18pcs Mixed
- 9 SKUs w/ Foam
- 9 SKUs without Foam
- 14"W x 24.5"H

J  
**26-5021**  
Spinner - With Foam

**PRE-PACK INCLUDES**

- Holds 18pcs with Foam
- Mixed Lens Colors
- 14"W x 24.5"H

K  
**26-5022**  
Spinner - Without Foam

**PRE-PACK INCLUDES**

- Holds 18pcs without Foam
- Mixed Lens Colors
- 14"W x 24.5"H



WINDSHIELDS / FAIRINGS  
AUDIO / COMMUNICATION  
SEATS / LUGGAGE  
BARS / MIRRORS / CONTROLS  
EXHAUST  
AIR / FUEL SYSTEMS  
ENGINE  
TRANSMISSION / DRIVELINE  
GASKETS / SEALS  
ELECTRICAL  
LIGHTING  
CABLES  
BRAKES  
OIL FILTERS  
SUSPENSION  
BODY  
WHEELS  
TIRES / TIRE ACC.  
BIKE ACC.  
VICTORY / INDIAN  
COVERS / LOCKS / TIEDOWNS  
CHEMICALS  
TOOLS  
HELMETS  
HELMET ACC.  
**EYEWEAR**  
APPAREL / RIDER ACC.  
PROMOTIONAL  
REFERENCE  
INDEX



**SUNGLASSES**

- 100% UV Protection
- Includes soft poly bag and hard case for cleaning and storing
- Lifetime warranty against manufacturing defects and workmanship



Description	Lens	WPS #
A Crow Blue/ White	Black/ Red	<b>460-98703</b>
B Crow Red/ White	Sky Blue	<b>460-98704</b>
C Crow Black/ Orange	Red/ Orange	<b>460-98705</b>
D Jack	Polarized Chrome Smoke	<b>460-98702</b>
E Jameson	Polarized Smoke	<b>460-98701</b>
F Jim White	Polarized Revo Blue/ Yellow	<b>460-98708</b>
G Jim Black	Polarized Revo Blue/ Yellow	<b>460-98709</b>
H Johnnie Black	Polarized Chrome Smoke	<b>460-98707</b>



**LEADER**

Built for competition, the SCOTT Leader is lightweight and comfortable during athletic activity. Easy-change lenses come in a variety of shades to handle the light in any location or condition.

- Easy Change Lens System
- Scott Fusion Frame Construction
- 100% UV Protection
- Light Sensitive Lens
- Scott Opti View



Frame	Lens	WPS#
A Black	Brown	<b>51-5400</b>
B Grey	Silver Ion	<b>51-5401</b>
C White	LS Yellow	<b>51-5402</b>
D Grey	Silver Ion w/ Extra Clear Lens	<b>51-5403</b>



WINDSHIELDS / FAIRINGS  
AUDIO / COMMUNICATION  
SEATS / LUGGAGE  
BARS / MIRRORS / CONTROLS  
EXHAUST  
AIR / FUEL SYSTEMS  
ENGINE  
TRANSMISSION / DRIVELINE  
GASKETS / SEALS  
ELECTRICAL  
LIGHTING  
CABLES  
BRAKES  
OIL FILTERS  
SUSPENSION  
BODY  
WHEELS  
TIRES / TIRE ACC.  
BIKE ACC.  
VICTORY / INDIAN  
COVERS / LOCKS / TIEDOWNS  
CHEMICALS  
TOOLS  
HELMETS  
HELMET ACC.  
EYEWEAR  
APPAREL / RIDER ACC.  
PROMOTIONAL  
REFERENCE  
INDEX

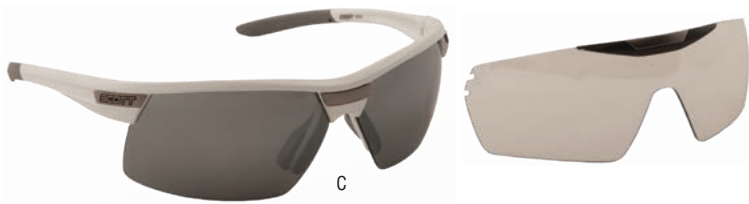

**SPRINT**

If speed is your credo, SCOTT Sprint will not let you down. Built with a lightweight, yet durable frame that offers a secure fit, this sunglass guarantees superior performance and comfort.

- Easy Change Lens System
- Scott Fusion Frame Construction
- 100% UV Protection
- Light Sensitive Lens
- Polarized Lens
- Scott Opti View

Frame	Lens	WPS#
A Black	LS Grey	51-5404
B Black	Brown	51-5405
C White	Silver Ion w/ Extra Clear Lens	51-5406

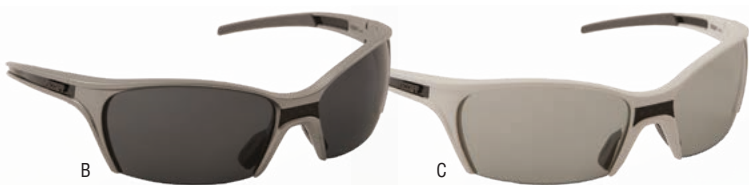

**ENDO**

Clean design and superior functional features are the trademarks of SCOTT Endo. For all the nature lovers looking for a versatile, dynamic and complete sunglass

- Scott Fusion Frame Construction
- 100% UV Protection
- Polarized Lens
- Scott Opti View

Frame	Lens	WPS#
A Black	Brown	51-5407
B Grey	Grey Polarized	51-5408
C White Carbon	LS Gray	51-5409



**LEAP**

The new multi-functional sport shield of choice that fits your face like a glove. SCOTT Leap redefines the standards of comfort and performance, guaranteeing an unobstructed field of vision and the highest quality of materials.

- Scott Fusion Frame Construction
- 100% UV Protection
- Scott Opti View

Frame	Lens	WPS#
A Matte Blue	Blue Ion	51-5410
B Matte Black	Blue Ion	51-5411
C Black	Clear	51-5412



WINDSHIELDS / FAIRINGS  
 AUDIO / COMMUNICATION  
 SEATS / LUGGAGE  
 BARS / MIRRORS / CONTROLS  
 EXHAUST  
 AIR / FUEL SYSTEMS  
 ENGINE  
 TRANSMISSION / DRIVELINE  
 GASKETS / SEALS  
 ELECTRICAL  
 LIGHTING  
 CABLES  
 BRAKES  
 OIL FILTERS  
 SUSPENSION  
 BODY  
 WHEELS  
 TIRES / TIRE ACC.  
 BIKE ACC.  
 VICTORY / INDIAN  
 COVERS / LOCKS / TIEDOWNS  
 CHEMICALS  
 TOOLS  
 HELMETS  
 HELMET ACC.  
**EYEWEAR**  
 APPAREL / RIDER ACC.  
 PROMOTIONAL  
 REFERENCE  
 INDEX

**BLINDSIDE**



- Acetate front and temples with custom core wire
- CR39 lens
- 5 barrel stainless steel hinge
- 100% UV protection
- Medium fit

	Frame	Lens	WPS#
A	Shiny Black	Smoke	<b>720-2500</b>
B	Matte Black	Blue	<b>720-2501</b>
C	Shiny Tortoise	Brown	<b>720-2502</b>
D	Shiny Khaki	Golden	<b>720-2503</b>



**CHANNEL**



- Lightweight injected TR90 Frame
- 6 Base polycarbonate lens
- Integrated cam hinge
- 100% UV protection
- Medium fit

	Frame	Lens	WPS#
A	Matte Black	Smoke	<b>720-2510</b>
B	Matte Deep Sea	G15 Green	<b>720-2511</b>
C	Matte Grey	Silver Ion	<b>720-2512</b>
D	Matte Deep Navy	Blue Ion	<b>720-2513</b>



**METHOD**



- Lightweight injected TR90 Frame
- 6 base polycarbonate lens
- Integrated hinge
- 100% UV protected
- Medium fit

	Frame	Lens	WPS#
A	Matte Black	Smoke	<b>720-2540</b>
B	Matte Coffee	Brown	<b>720-2541</b>
C	Matte Grey	Silver Ion	<b>720-2542</b>
D	Matte Redwood	Sky Blue Ion	<b>720-2543</b>





**MONARCH** **NEW**

- 6 base polycarbonate lens
- Injected molded grilamid frame
- 5 barrel stainless steel hinge
- 100% UV protected
- Medium fit

	Frame	Lens	WPS#
A	Matte Black	Grey	720-2550
B	Matte Tortoise	G15 Green	720-2551
C	Jet	Grey Polar	720-2552
D	Matte Deep Navy	Blue Ion	720-2553



**COUNT** **NEW**

- 6 base polycarbonate
- injection molded grilamid frame
- 5 barrel stainless steel hinge
- 100% UV protection
- Medium fit

	Frame	Lens	WPS#
A	Matte Black	Grey	720-2520
B	Matte Black	Blue	720-2521
C	Matte Grey	Grey	720-2522
D	Matte Tortoise	G15 Green	720-2523
E	Matte H2O Magnet Grey	Silver Ion	720-2524
F	Matte H2O Black	Grey	720-2525
G	Matte H2O Black	Green Ion	720-2526
H	Matte H2O Black	Blue Ion	720-2527



**MANSFIELD**

- Grilamid Frame Material
- 4 Base Polycarbonate Shield Lens
- 5 Barrel Stainless Steel Hinge
- 100% UV Protection
- Made in Italy
- Large Fit Size



	Frame	Lens	WPS#
A	Palm Springs Pool	Bronze	720-2173
B	Lime	Grey	720-2234

- WINDSHIELDS / FAIRINGS
- AUDIO / COMMUNICATION
- SEATS / LUGGAGE
- BARS / MIRRORS / CONTROLS
- EXHAUST
- AIR / FUEL SYSTEMS
- ENGINE
- TRANSMISSION / DRIVELINE
- GASKETS / SEALS
- ELECTRICAL
- LIGHTING
- CABLES
- BRAKES
- OIL FILTERS
- SUSPENSION
- BODY
- WHEELS
- TIRES / TIRE ACC.
- BIKE ACC.
- VICTORY / INDIAN
- COVERS / LOCKS / TIEDOWNS
- CHEMICALS
- TOOLS
- HELMETS
- HELMET ACC.
- EYEWEAR**
- APPAREL / RIDER ACC.
- PROMOTIONAL
- REFERENCE
- INDEX

- WINDSHIELDS / FAIRINGS
- AUDIO / COMMUNICATION
- SEATS / LUGGAGE
- BARS / MIRRORS / CONTROLS
- EXHAUST
- AIR / FUEL SYSTEMS
- ENGINE
- TRANSMISSION / DRIVELINE
- GASKETS / SEALS
- ELECTRICAL
- LIGHTING
- CABLES
- BRAKES
- OIL FILTERS
- SUSPENSION
- BODY
- WHEELS
- TIRES / TIRE ACC.
- BIKE ACC.
- VICTORY / INDIAN
- COVERS / LOCKS / TIEDOWNS
- CHEMICALS
- TOOLS
- HELMETS
- HELMET ACC.
- EYEWEAR**
- APPAREL / RIDER ACC.
- PROMOTIONAL
- REFERENCE
- INDEX



### JAM

- Grilamid Frame Material
- 6 Base Polycarbonate Lens
- 5 Barrel Stainless Steel Hinge
- 100% UV Protection
- **Large Fit Size**



	Frame	Lens	WPS#
A	Matte Black	Sky Blue Ion	720-2339
B	Jet	Grey	720-1832
C	Owen Wright	Green Ionized	720-1999
D	Matte Cement	Silver Ion	720-2340
E	Polished Walnut	Brown	720-2341

### REMIX

- Grilamid Frame Material
- 4 Base Polycarbonate Shield Lens
- 5 Barrel Stainless Steel Hinge
- 100% UV Protection
- Made in Italy
- **Large Fit Size**



	Frame	Lens	WPS#
A	Owen Wright	Red Ionized	720-2169
B	Matte Black	Sky Blue Ion	720-2230
C	Jet	Grey	720-2112

### REGAL

- Acetate Frame Material
- 6 Base CR-39 Lens
- Wire Core Temples
- Spring Hinge
- 100% UV Protection
- **Large Fit Size**



	Frame	Lens	WPS#
A	Matte Blue	Blue ion	720-2232
B	Grey Matter	Grey	720-2233



**MARQUIS**

- Grilamid Frame Material
- 6 Base Polycarbonate Lens
- 5 Barrel Stainless Steel Hinge
- 100% UV Protection
- Made in Italy
- Large Fit Size



	Frame	Lens	WPS#
A	Matte Black	Performance Polar	720-2251
B	Matte Tortoise	Performance Polar	720-2253
C	Grey Matter	Sky Blue Ion	720-2255
D	Jade	Grey Gradient	720-2256



**VICEROY**

- Acetate frame material
- 6 Base CR-39 lens
- Wire Core temples
- 5 spring hinge
- 100% UV protection
- Medium Fit Size



	Frame	Lens	WPS#
A	Retro Tortoise	Performance Polar	720-2077
B	Black Gold	Gold Ion	720-2048
C	Black Mint	Grey	720-2153
D	Palm Springs Pattern	Grey	720-2152



**B CLASS**

- Lightweight metal frame
- 6 Base Polycarbonate lens
- Stainless steel hinge
- 100% UV protection
- Medium Fit Size



	Frame	Lens	WPS#
A	Matte Black	Silver Ion	720-2610
B	Matte Gold	Gold Ion	720-2619

- WINDSHIELDS / FAIRINGS
- AUDIO / COMMUNICATION
- SEATS / LUGGAGE
- BARS / MIRRORS / CONTROLS
- EXHAUST
- AIR / FUEL SYSTEMS
- ENGINE
- TRANSMISSION / DRIVELINE
- GASKETS / SEALS
- ELECTRICAL
- LIGHTING
- CABLES
- BRAKES
- OIL FILTERS
- SUSPENSION
- BODY
- WHEELS
- TIRES / TIRE ACC.
- BIKE ACC.
- VICTORY / INDIAN
- COVERS / LOCKS / TIEDOWNS
- CHEMICALS
- TOOLS
- HELMETS
- HELMET ACC.
- EYEWEAR**
- APPAREL / RIDER ACC.
- PROMOTIONAL
- REFERENCE
- INDEX

- WINDSHIELDS / FAIRINGS
- AUDIO / COMMUNICATION
- SEATS / LUGGAGE
- BARS / MIRRORS / CONTROLS
- EXHAUST
- AIR / FUEL SYSTEMS
- ENGINE
- TRANSMISSION / DRIVELINE
- GASKETS / SEALS
- ELECTRICAL
- LIGHTING
- CABLES
- BRAKES
- OIL FILTERS
- SUSPENSION
- BODY
- WHEELS
- TIRES / TIRE ACC.
- BIKE ACC.
- VICTORY / INDIAN
- COVERS / LOCKS / TIEDOWNS
- CHEMICALS
- TOOLS
- HELMETS
- HELMET ACC.
- EYEWEAR**
- APPAREL / RIDER ACC.
- PROMOTIONAL
- REFERENCE
- INDEX



## STATUS

- Lightweight metal frame
- 6 Base Polycarbonate lens
- Stainless steel hinge
- 100% UV protection
- **Medium Fit Size**



	Frame	Lens	WPS#
A	Matte Black	Grey	720-2602
B	Matte Silver	Blue Ion	720-2647
C	Rose Gold	Rose Gold Ion	720-2680
D	Shiny Silver	Silver Ion	720-2645



## EXPERIENCE 2

- Grilamid Frame Material
- 6 Base Polycarbonate Lens
- 5 Barrel Stainless Steel Hinge
- 100% UV Protection
- Made In Italy
- **Medium Fit Size**



	Frame	Lens	WPS#
A	Jet Purple	Purple Ion	720-1881
B	Clear	Green Ionized	720-1882
C	Matte Black	Red Ion	720-2019
D	Jet Blue	Blue Ion	720-2051
E	Grey Matter	Sky Blue Ion	720-2211



## DS2

- Grilamid frame material
- 4 base Polycarbonate shield lens
- 5 barrel stainless steel hinge
- Rubber nose pad and temple inlays
- 100% UV protection
- **Large Fit Size**



	Frame	Lens	WPS#
A	Matte Black	Grey	720-2348
B	Grey Matter	Sky Blue Ion	720-2350







### EXIT ROW

- Acetate frame
- 6 base nylon lens
- 3 barrel stainless steel hinge
- 100% UV protection
- Medium Fit Size



Frame	Lens	WPS#
A	Matte Tortoise Bronze	720-6005
B	Jet Black Grey	720-6001
C	Matte Black/ Green Green Ion	720-6002
D	Dolphin Grey Grey	720-6035



### DOMO

- Grilamid frame material
- Multi-base polycarbonate shield lens
- 5 Barrel stainless steel hinge
- 100% UV protection
- Made in Italy
- Large Fit Size



Frame	Lens	WPS#
A	Jet Lime Grey	720-1493
B	Palm Springs Pool Grey	720-2070
C	Neo Geo Grey	720-2296



### DOUBLE DOS

- Grilamid Frame Material
- 8 Base Polycarbonate Lens
- Integrated Cam Hinge
- Rubber Nose Pads and Temple Tips
- 100% UV Protection
- Medium Fit Size



Frame	Lens	WPS#
A	Jet Red Ionized	720-2194
	Performance Polar	720-2236
B	Matte Tortoise Bronze	720-2192
	Performance Polar	720-2193
C	Jet Grey	720-2190
	Performance Polar	720-2191
D	Matte Black Ansi Grey	720-2239
	Blue ion	720-2237
E	Performance Polar	720-2238
	H2O Matte Crystal Grey Ion	720-2374
	H2O Matte Black Plasma Ion	720-2326



D. ANSI GREY

D. BLUE ION



E. GREY ION

E. PLASMA ION

- WINDSHIELDS / FAIRINGS
- AUDIO / COMMUNICATION
- SEATS / LUGGAGE
- BARS / MIRRORS / CONTROLS
- EXHAUST
- AIR / FUEL SYSTEMS
- ENGINE
- TRANSMISSION / DRIVELINE
- GASKETS / SEALS
- ELECTRICAL
- LIGHTING
- CABLES
- BRAKES
- OIL FILTERS
- SUSPENSION
- BODY
- WHEELS
- TIRES / TIRE ACC.
- BIKE ACC.
- VICTORY / INDIAN
- COVERS / LOCKS / TIEDOWNS
- CHEMICALS
- TOOLS
- HELMETS
- HELMET ACC.
- EYEWEAR**
- APPAREL / RIDER ACC.
- PROMOTIONAL
- REFERENCE
- INDEX

- WINDSHIELDS / FAIRINGS
- AUDIO / COMMUNICATION
- SEATS / LUGGAGE
- BARS / MIRRORS / CONTROLS
- EXHAUST
- AIR / FUEL SYSTEMS
- ENGINE
- TRANSMISSION / DRIVELINE
- GASKETS / SEALS
- ELECTRICAL
- LIGHTING
- CABLES
- BRAKES
- OIL FILTERS
- SUSPENSION
- BODY
- WHEELS
- TIRES / TIRE ACC.
- BIKE ACC.
- VICTORY / INDIAN
- COVERS / LOCKS / TIEDOWNS
- CHEMICALS
- TOOLS
- HELMETS
- HELMET ACC.
- EYEWEAR**
- APPAREL / RIDER ACC.
- PROMOTIONAL
- REFERENCE
- INDEX



## REVERB

- 6 Base Polycarbonate Lens
- Lightweight injected TR90 Frame
- 5 Barrel Stainless Hinge
- Rubber Nose Pad and Temple Tip Inserts
- 100% UV Protection
- Large Fit



Frame	Lens	WPS#
A Gunmetal Marble	Green G15	720-9681
B Polished Walnut	Grey	720-9641
C Matte Utility Green	Grey	720-9600
D Matte Black	Grey	720-9603



## WORMSER

- Grilamid frame material
- 6 Base curve polycarbonate lens
- 5 Barrel stainless steel hinge
- 100% UV protection
- **Medium Fit Size**



Frame	Lens	WPS#
A Matte Grey	Green Ion	720-1825
B Teal	Green Ion	720-2072
C Matte Black	Rose Gold	720-2227
	Red Ion	720-2229
D Plasma	Plasma Ion	720-2228



## HEX SUNGLASSES

- 6 base polycarbonate lens
- Lightweight injected TR90 frame
- 5 barrel stainless steel hinge
- Added goggle bracket design
- 100% UV protection
- Large fit size



Frame	Lens	WPS#
A Matte Utility Green	Red Ion	720-9700
B Shiny Black	Silver	720-9709
C Matte Black	Green Ion	720-9745
D Matte Black	Grey	720-9703





WINDSHIELDS / FAIRINGS

AUDIO / COMMUNICATION

SEATS / LUGGAGE

BAR / MIRRORS / CONTROLS

EXHAUST

AIR / FUEL SYSTEMS

ENGINE

TRANSMISSION / DRIVELINE

GASKETS / SEALS

ELECTRICAL

LIGHTING

CABLES

BRAKES

OIL FILTERS

SUSPENSION

BODY

WHEELS

TIRES / TIRE ACC.

BIKE ACC.

VICTORY / INDIAN

COVERS / LOCKS / TIEDOWNS

CHEMICALS

TOOLS

HELMETS

HELMET ACC.

EYEWEAR

APPAREL / RIDER ACC.

PROMOTIONAL

REFERENCE

INDEX



## ROADBLOCK

- H2O models include Performance Polarized lens
- 6 base polycarbonate lens
- Lightweight injected TR90 frame
- 5 barrel stainless steel hinge
- Rubber nose pad and temple inserts
- 100% UV protection
- Medium Fit Size



	Frame	Lens	WPS#
A	Matte Magnet H2O	Red Ion Polar	720-9543
B	Matte Black H2O	Silver Ion Polar	720-9549
C	Matte Black H2O	Grey Polar	720-9512
D	Copper Marble	Silver Ion	720-8624
E	Matte Blue Smoke	Silver Ion	720-8665
F	Matte Black	Grey	720-8603
G	Matte Tortoise	Brown	720-8625

## PASSPORT

- Acetate frame
- 6 base nylon lens
- 3 barrel stainless steel hinge
- 100% UV protection
- Medium Fit Size



	Frame	Lens	WPS#
A	Jet Black	Grey	720-6102
B	Matte Black Blue	Sky Blue Ion	720-6106
C	Matte Black	Silver Ion	720-6110
D	Matte Black	Purple Ion	720-6119
E	Matte Magnet Grey	Red Ion	720-6109
F	Shiny Tortoise	Green	720-6113



## VANTAGE

- Grilamid Frame Material
- 8 Base Polycarbonate Lens
- 5 Barrel Stainless Steel Hinge
- 100% UV Protection
- Medium Fit Size



Frame	Lens	WPS#
A Jet	Grey	720-1803
B Matte Stealth	Grey	720-1857
C Jet Red	Red Ion Performance Polar	720-2223
D Matte H2O	Performance Polar	720-2270
	Green Ion	720-2269
	Blue Ion	720-2271
E Matte Rosewood H2O	Smoke Performance Polar	720-2272



## FAME

- Grilamid frame material
- 6 Base curve polycarbonate lens
- 5 Barrel stainless steel hinge
- 100% UV protection
- Made in Italy
- Large Fit Size

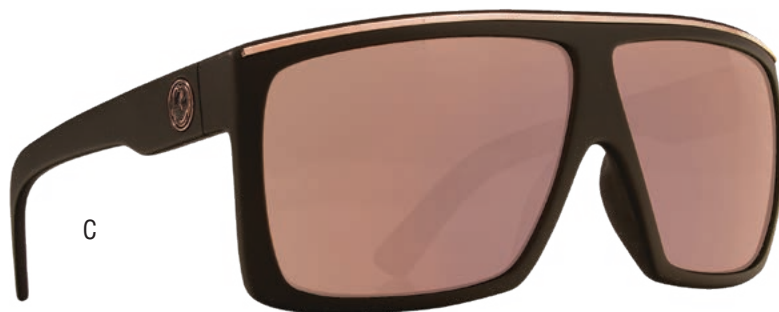

Frame	Lens	WPS#
A Palm Springs Pool	Grey	720-2073
B Palms Springs Pattern	Grey	720-2158
C Matte	Rose Gold	720-2213
D Matte Blue	Sky Blue Ion	720-2215
E Matte Black	Silver Ion	720-2322
F Neo Geo	Grey	720-2297
G H2O Matte Black	Grey	720-2371
H H2O Matte Black	Blue Ion	720-2373
I H2O Matte Black	Plasma Ion	720-2372



# FLOATING AND SAFETY EYEWEAR



- Bomber Eyewear is the industry leader in floating sunglasses and safety glasses
- With Bomber's patented foam technology, they are the only manufacturer who uses high quality, non-toxic EVA foam
- The foam also provides a non-slip grip (keeping glasses in place on your face) and reduces eye tearing in windy conditions
- Safety glasses feature OSHA approved safety lenses which offer

- extreme impact resistance of polycarbonate, meets ANSI Z87+ standards, and are virtually unbreakable
- All Bomber eyewear protects from 100% of harmful UVA and UVB rays exceeding ANSI Z80.3 UV requirements helping to prevent damage to eyes and aging of skin
- Select glasses feature polarized glare blocking which blocks reflected light rays providing truer, distortion-free clarity and contrast- a must for any water enthusiast

## POLARIZED



Description	Frame Color	Lens Color	WPS#
<b>POLARIZED FLOATING</b>			
A Pipe Bomb	Matte Black	Red Mirror	<b>519-0015</b>
B Beer Bomb	2 Tone Smoke	Green Mirror	<b>519-0017</b>
C Boogie Bomb	Matte Black	Smoke	<b>519-0019</b>
D Stink-Bomb	Gloss White	Smoke	<b>519-0065</b>

Description	Frame Color	Lens Color	WPS#
<b>POLARIZED FLOATING (cont'd...)</b>			
E Stink Bomb	Tortoise	Smoke	<b>519-0066</b>
F Gomer Bomb	Matte Black	Smoke	<b>519-0025</b>
G Irie Bomb	Gloss White	Smoke	<b>519-0054</b>

## FLOATING



Description	Frame Color	Lens Color	WPS#
<b>FLOATING</b>			
A K-Bomb Youth	Matte Black	Mirror	<b>519-0121</b>
B Jaco Bomb	Tortoise	Polycarbonate Amber	<b>519-0016</b>
C Boogie Bomb	2 Tone Smoke	Red Mirror	<b>519-0018</b>
D Sugar Bomb	Gloss Black	Smoke	<b>519-0100</b>
E Gomer Bomb	Matte Black	Green Mirror	<b>519-0029</b>
F Gomer Bomb	Matte Black	Red Mirror	<b>519-0022</b>

Description	Frame Color	Lens Color	WPS#
<b>FLOATING (cont'd...)</b>			
G Gomer Bomb	Gloss White	Red Mirror	<b>519-0026</b>
H Gomer Bomb	Matte Black	Blue Mirror	<b>519-0023</b>
I Gomer Bomb	2 Tone Smoke	Red Mirror	<b>519-0027</b>
J Gomer Bomb	Gloss White	Blue Mirror	<b>519-0024</b>
K Irie Bomb	Matte Tortoise	Yellow Mirror	<b>519-0055</b>
L Irie Bomb	Matt Black	Red Mirror	<b>519-0052</b>
M Irie Bomb	Crystal smk	Green Mirror	<b>519-0056</b>

- WINDSHIELDS / FAIRINGS
- AUDIO / COMMUNICATION
- SEATS / LUGGAGE
- BAR / MIRRORS / CONTROLS
- EXHAUST
- AIR / FUEL SYSTEMS
- ENGINE
- TRANSMISSION / DRIVELINE
- GASKETS / SEALS
- ELECTRICAL
- LIGHTING
- CABLES
- BRAKES
- OIL FILTERS
- SUSPENSION
- BODY
- WHEELS
- TIRES / TIRE ACC.
- BIKE ACC.
- VICTORY / INDIAN
- COVERS / LOCKS / TIEDOWNS
- CHEMICALS
- TOOLS
- HELMETS
- HELMET ACC.
- EYEWEAR**
- APPAREL / RIDER ACC.
- PROMOTIONAL
- REFERENCE
- INDEX



**FLOATING AND SAFETY EYEWEAR**

**SAFETY FLOATING**



A



B



C



D



E



F

Description	Frame Color	Lens Color	WPS#
<b>SAFETY FLOATING</b>			
A Pipe Bomb	Matte Black	Smoke	<b>519-0014</b>
B Stink Bomb	Matte Black	Smoke	<b>519-0060</b>
C A-Bomb	Lt. Blue	Lt. Blue	<b>519-0013</b>

Description	Frame Color	Lens Color	WPS#
<b>SAFETY FLOATING (CONT'D...)</b>			
D Z-Bomb	Smoke	Smoke	<b>519-0030</b>
E Z-Bomb	Smoke	Mirror	<b>519-0031</b>
F H-Bomb	Smoke	Mirror	<b>519-0140</b>

**DISPLAYS**

display programs available, see your rep for details



Description	WPS#
Sidekick (free w/ purchase of 18pr of Bombers)	<b>519-0002</b>



- WINDSHIELDS / FAIRINGS
- AUDIO / COMMUNICATION
- SEATS / LUGGAGE
- BAR / MIRRORS / CONTROLS
- EXHAUST
- AIR / FUEL SYSTEMS
- ENGINE
- TRANSMISSION / DRIVELINE
- GASKETS / SEALS
- ELECTRICAL
- LIGHTING
- CABLES
- BRAKES
- OIL FILTERS
- SUSPENSION
- BODY
- WHEELS
- TIRES / TIRE ACC.
- BIKE ACC.
- VICTORY / INDIAN
- COVERS / LOCKS / TIEDOWNS
- CHEMICALS
- TOOLS
- HELMETS
- HELMET ACC.
- EYEWEAR**
- APPAREL / RIDER ACC.
- PROMOTIONAL
- REFERENCE
- INDEX



### RED BARON GOGGLE

If the features you are looking for  
 include  
 • Adjustable vents  
 • Adjustable band  
 • Adjustable lens position  
 • Tinted non-scratch lens

Description	WPS#
Standard	56-9501
Anti fog	56-95012



### ROADHAWK GOGGLE

Goggle features an acrylic non-scratch one piece tinted lens and air vents

WPS#
56-95011



### BANDITO GOGGLE

• anti-fog lens  
 • Lens meets all general requirements, providing protection against UVB and ultraviolet rays  
 • Large, adjustable strap will fit over under helmets  
 • Easy to replace lenses allow rider to change colors

Lens color	WPS#
Clear	56-95013
Amber	56-95014
Smoke	56-95015
REPLACEMENT LENS	
Clear	56-95016
Amber	56-95017
Smoke	56-95018

- WINDSHIELDS / FAIRINGS
- AUDIO / COMMUNICATION
- SEATS / LUGGAGE
- BARS / MIRRORS / CONTROLS
- EXHAUST
- AIR / FUEL SYSTEMS
- ENGINE
- TRANSMISSION / DRIVELINE
- GASKETS / SEALS
- ELECTRICAL
- LIGHTING
- CABLES
- BRAKES
- OIL FILTERS
- SUSPENSION
- BODY
- WHEELS
- TIRES / TIRE ACC.
- BIKE ACC.
- VICTORY / INDIAN
- COVERS / LOCKS / TIEDOWNS
- CHEMICALS
- TOOLS
- HELMETS
- HELMET ACC.
- EYEWEAR**
- APPAREL / RIDER ACC.
- PROMOTIONAL
- REFERENCE
- INDEX

# HIGHWAY 21 GUNNER JACKET

**YKK** *Little Parts. Big Difference.* **HYDRAGUARD**

**CE**  
PROTECTION

hooting for perfection, the Gunner acket was built with exibility and protection necessary for attacking the roads without hesitation. he Gunner s arsenal of features keeps you e uipped and protected on the front lines with both style and performance. hen con dence and comfort are a re uirement, there is no other option. Battle on.

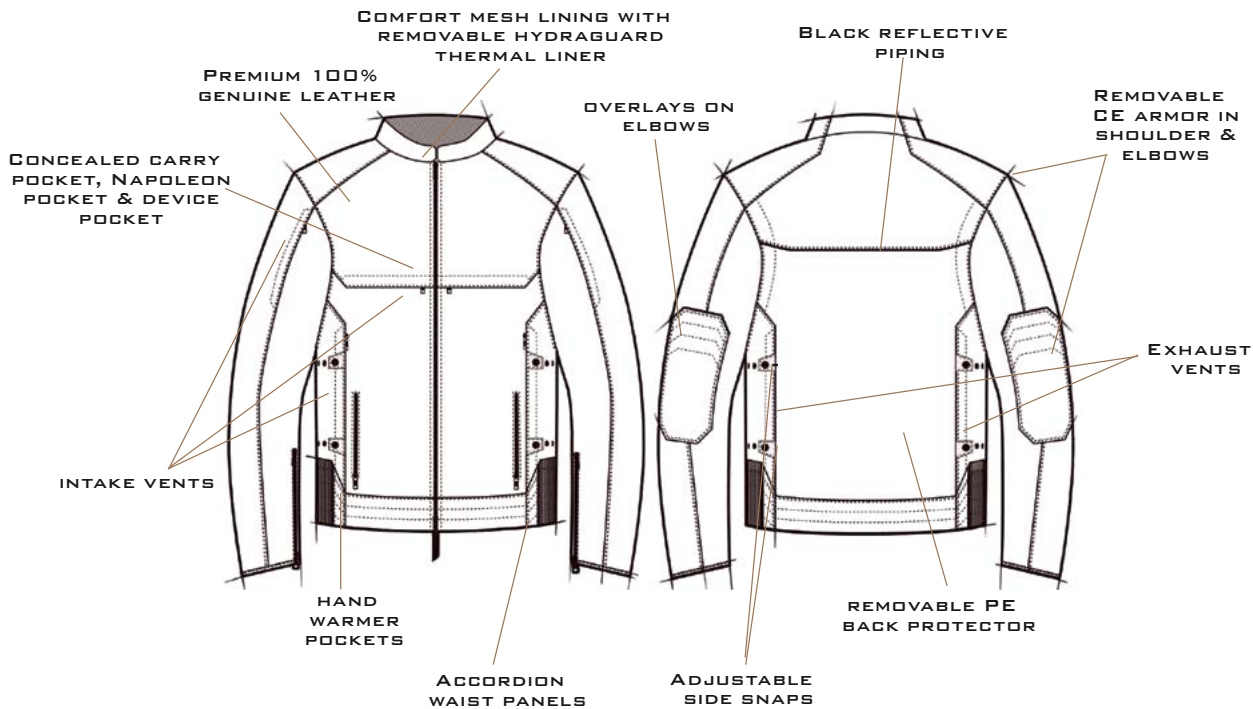

Size	Black	Vintage Gunmetal
S	489-1014S	489-1015S
M	489-1014M	489-1015M
L	489-1014L	489-1015L
X	489-1014X	489-1015X
2X	489-10142X	489-10152X
3X	489-10143X	489-10153X
4X	489-10144X	489-10154X

- WINDSHIELDS / FAIRINGS
- AUDIO / COMMUNICATION
- SEATS / LUGGAGE
- BARS / MIRRORS / CONTROLS
- EXHAUST
- AIR / FUEL SYSTEMS
- ENGINE
- TRANSMISSION / DRIVELINE
- GASKETS / SEALS
- ELECTRICAL
- LIGHTING
- CABLES
- BRAKES
- OIL FILTERS
- SUSPENSION
- BODY
- WHEELS
- TIRES / TIRE ACC.
- BIKE ACC.
- VICTORY / INDIAN
- COVERS / LOCKS / TIEDOWNS
- CHEMICALS
- TOOLS
- HELMETS
- HELMET ACC.
- EYEWEAR
- APPAREL / RIDER ACC.
- PROMOTIONAL
- REFERENCE
- INDEX



GASSER JACKET HIGHWAY 21

**YKK**  
Little Paris. Big Difference.

**HYDRAGUARD**

**CE**  
PROTECTION

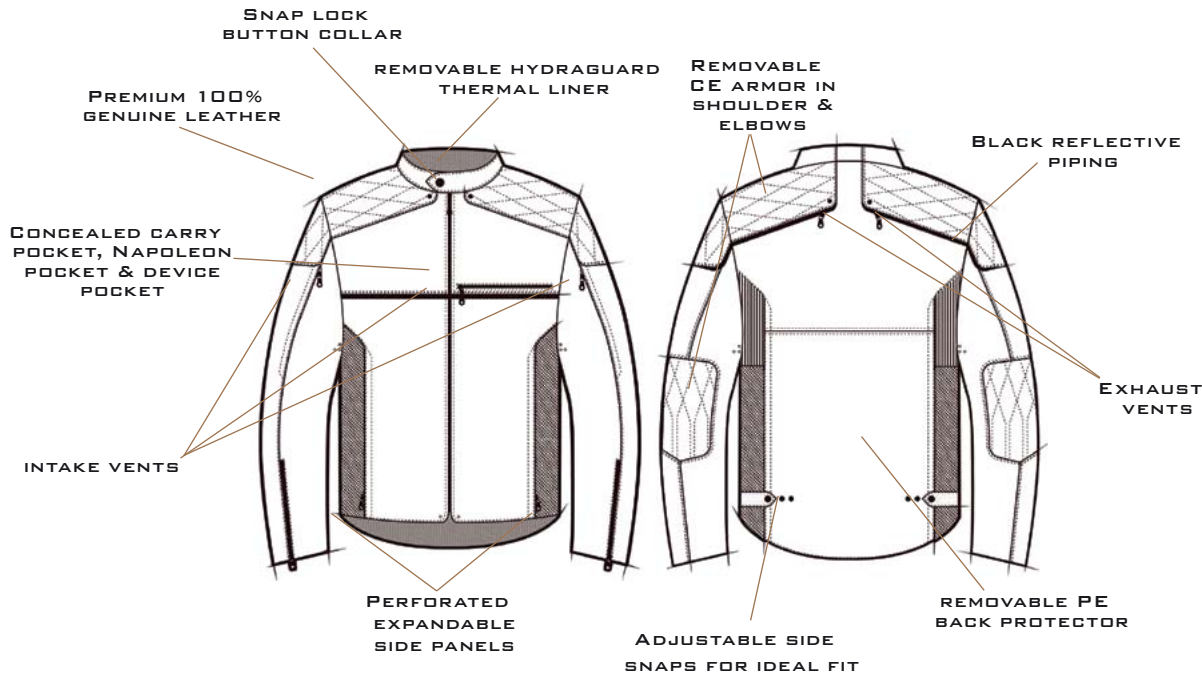

Vintage Brown



Black

Size	Black	Vintage Brown
S	489-1010S	489-1011S
M	489-1010M	489-1011M
L	489-1010L	489-1011L
X	489-1010X	489-1011X
2X	489-10102X	489-10112X
3X	489-10103X	489-10113X
4X	489-10104X	489-10114X

- WINDSHIELDS / FAIRINGS
- AUDIO / COMMUNICATION
- SEATS / LUGGAGE
- BAR / MIRRORS / CONTROLS
- EXHAUST
- AIR / FUEL SYSTEMS
- ENGINE
- TRANSMISSION / DRIVELINE
- GASKETS / SEALS
- ELECTRICAL
- LIGHTING
- CABLES
- BRAKES
- OIL FILTERS
- SUSPENSION
- BODY
- WHEELS
- TIRES / TIRE ACC.
- BIKE ACC.
- VICTORY / INDIAN
- COVERS / LOCKS / TIEDOWNS
- CHEMICALS
- TOOLS
- HELMETS
- HELMET ACC.
- EYEWEAR
- APPAREL / RIDER ACC.
- PROMOTIONAL
- REFERENCE
- INDEX

# HIGHWAY 21 PRIMER JACKET



**YKK**  
Little Parts. Big Difference.

**CE**  
PROTECTION

Here at Highway 21 we believe the early days of America are nostalgic. So, we decided to emboss that reminiscent sentiment into the very grain of our designs. Our Primer jacket has a timeless vintage style that will take your mind and wallet back to an era of simplicity. If you're looking for a classic style that never ages and won't break the bank, then it's time to try on the Highway 21 Primer jacket.

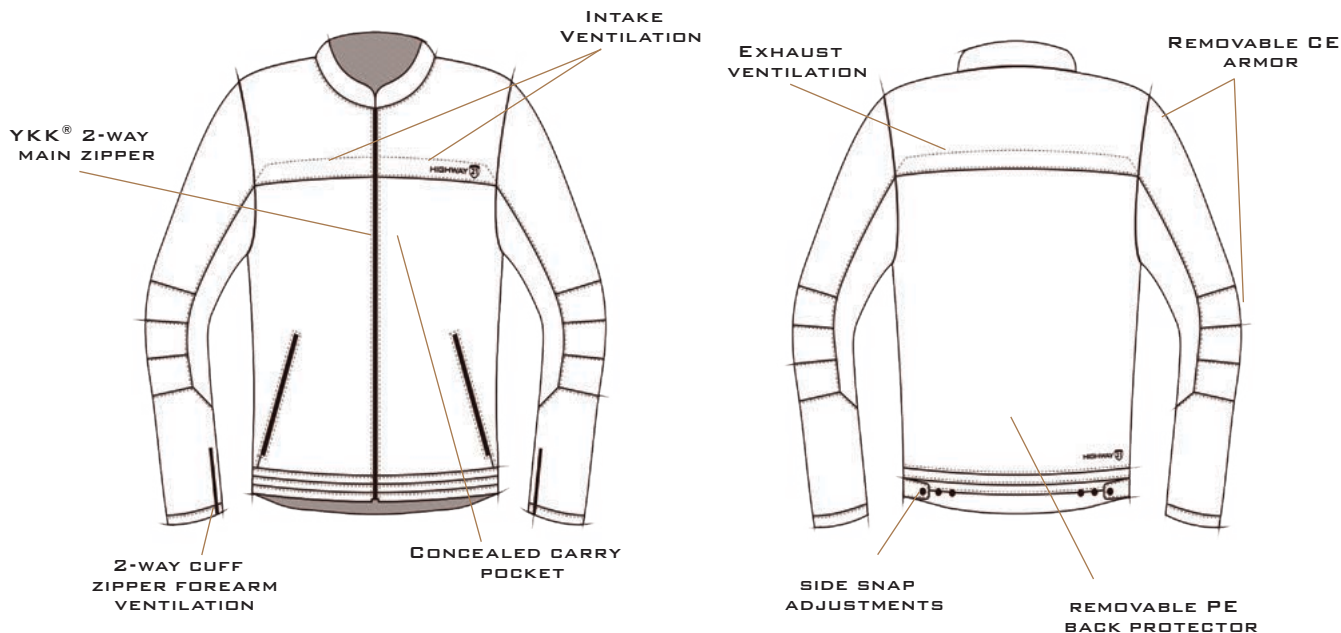

Size	Black	Vintage Brown
S	489-1017S	489-1018S
M	489-1017M	489-1018M
L	489-1017L	489-1018L
X	489-1017X	489-1018X
2X	489-10172X	489-10182X
3X	489-10173X	489-10183X
4X	489-10174X	489-10184X

GEARHEAD JACKET HIGHWAY 21



Bringing together technical ability and strength, the Gearhead jacket was developed with the inner mechanic in mind. Hard work is in our blood, and the results are a reflection of what we are willing to sacrifice to get there. Whether you're changing oil, rebuilding an engine, or just pounding pavement, the Gearhead jacket is always the right fix.

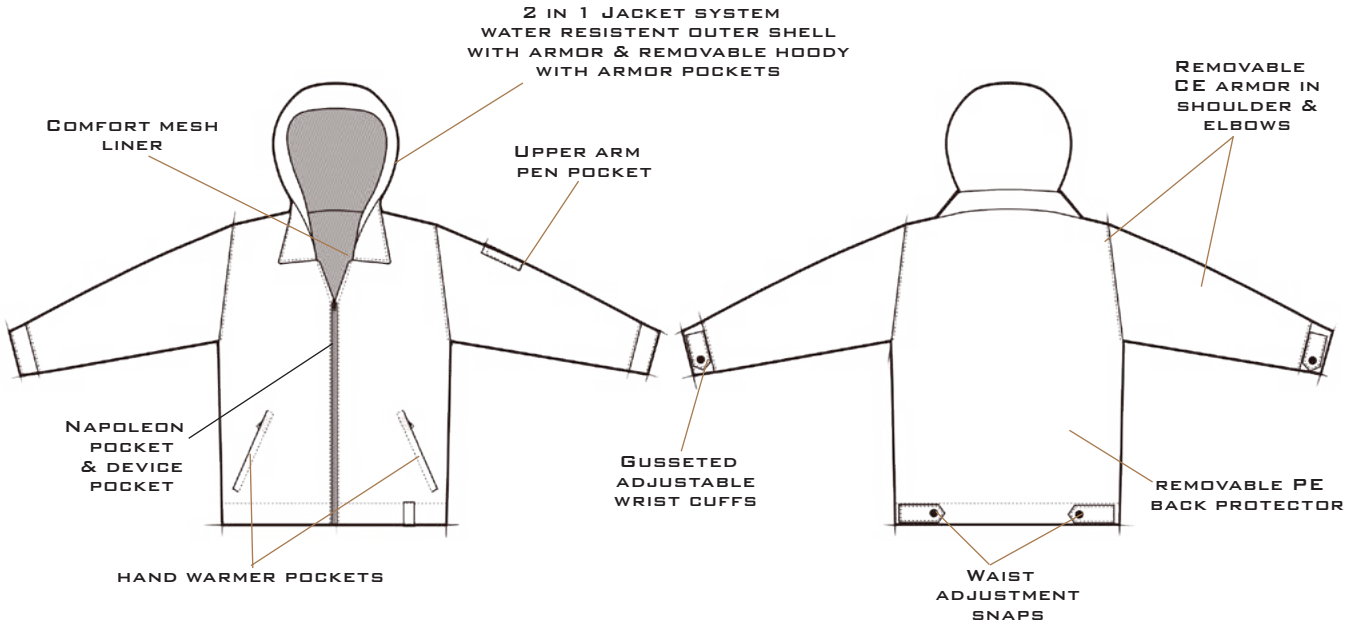

Brown



Black

Size	Black	Brown
S	489-1101S	489-1102S
M	489-1101M	489-1102M
L	489-1101L	489-1102L
X	489-1101X	489-1102X
2X	489-11012X	489-11022X
3X	489-11013X	489-11023X
4X	489-11014X	489-11024X

- WINDSHIELDS / FAIRINGS
- AUDIO / COMMUNICATION
- SEATS / LUGGAGE
- BARS / MIRRORS / CONTROLS
- EXHAUST
- AIR / FUEL SYSTEMS
- ENGINE
- TRANSMISSION / DRIVELINE
- GASKETS / SEALS
- ELECTRICAL
- LIGHTING
- CABLES
- BRAKES
- OIL FILTERS
- SUSPENSION
- BODY
- WHEELS
- TIRES / TIRE ACC.
- BIKE ACC.
- VICTORY / INDIAN
- COVERS / LOCKS / TIEDOWNS
- CHEMICALS
- TOOLS
- HELMETS
- HELMET ACC.
- EYEWEAR
- APPAREL / RIDER ACC.
- PROMOTIONAL
- REFERENCE
- INDEX

# HIGHWAY 21 TURBINE MESH JACKET



Riding seasons can be limited by weather; don't let summer be one of them. The Turbine jacket was created to escape the days when the sun is overbearing and the pavement is melting your tires. The full bore air mesh and protection creates a perfect combination of comfort and safety. Maximize your warm weather riding by slipping into a Turbine

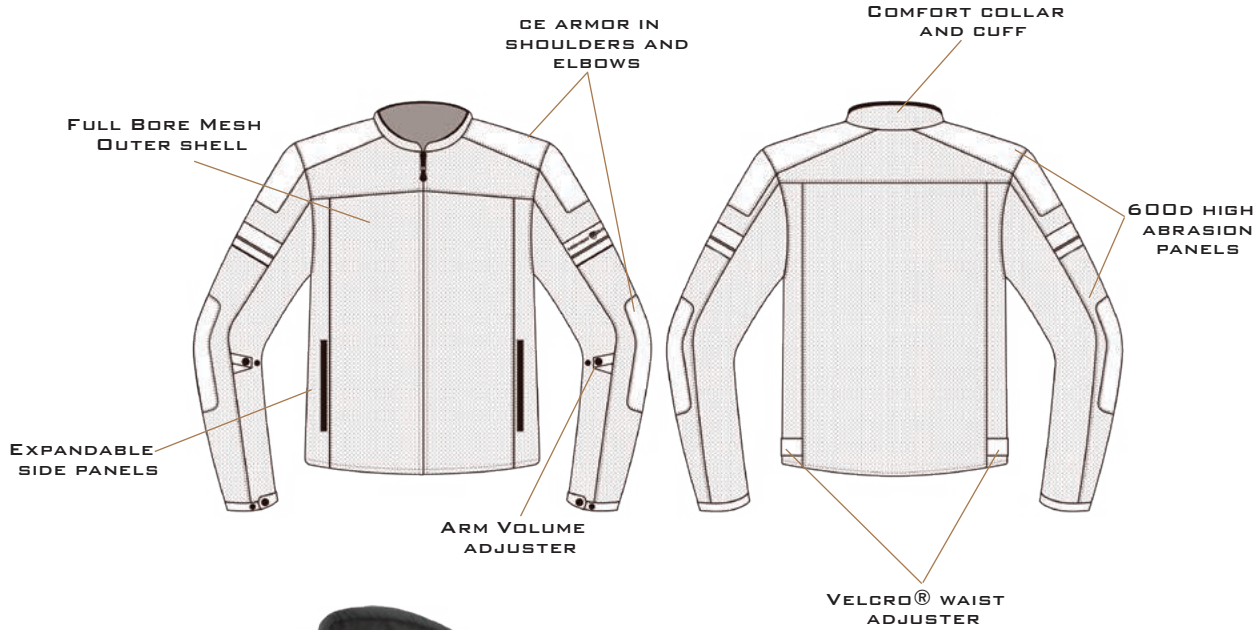

Size	Black
S	489-1141S
M	489-1141M
L	489-1141L
X	489-1141X
2X	489-11412X
3X	489-11413X
4X	489-11414X

- WINDSHIELDS / FAIRINGS
- AUDIO / COMMUNICATION
- SEATS / LUGGAGE
- BARS / MIRRORS / CONTROLS
- EXHAUST
- AIR / FUEL SYSTEMS
- ENGINE
- TRANSMISSION / DRIVELINE
- GASKETS / SEALS
- ELECTRICAL
- LIGHTING
- CABLES
- BRAKES
- OIL FILTERS
- SUSPENSION
- BODY
- WHEELS
- TIRES / TIRE ACC.
- BIKE ACC.
- VICTORY / INDIAN
- COVERS / LOCKS / TIEDOWNS
- CHEMICALS
- TOOLS
- HELMETS
- HELMET ACC.
- EYEWEAR
- APPAREL / RIDER ACC.**
- PROMOTIONAL
- REFERENCE
- INDEX



LADIES AIRA JACKET **HIGHWAY 21**

Escape the days when the sun is overbearing and the pavement is melting your tires. The Aira jacket is designed to evade the summer heat. The mesh and CE-protection creates the perfect combination of comfort and safety. Ride into the next era with your new Aira.

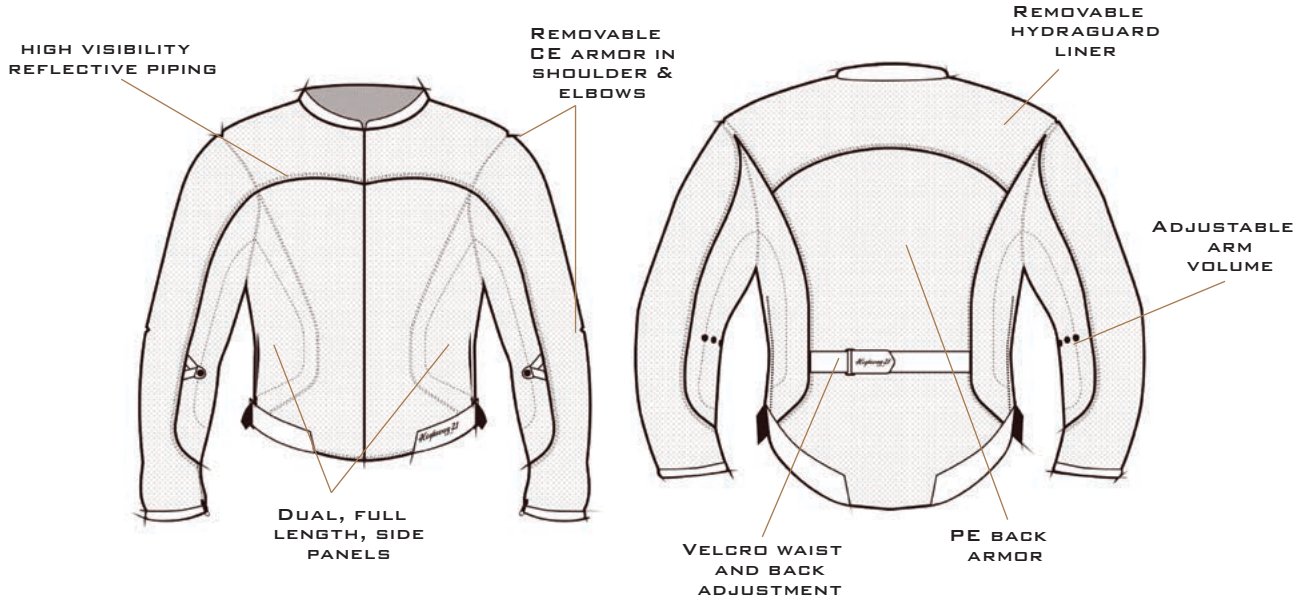

**Size Black**

XS	489-1401XS
S	489-1401S
M	489-1401M
L	489-1401L
X	489-1401X
2X	489-14012X
3X	489-14013X

**REPLACEMENT ARMOR**

Non-CE Shoulder Pad (Qty 1)	477-0001
Non-CE Elbow Pad (Qty 1)	477-0002
Non-CE back pad	477-0003

- WINDSHIELDS / FAIRINGS
- AUDIO / COMMUNICATION
- SEATS / LUGGAGE
- BARS / MIRRORS / CONTROLS
- EXHAUST
- AIR / FUEL SYSTEMS
- ENGINE
- TRANSMISSION / DRIVELINE
- GASKETS / SEALS
- ELECTRICAL
- LIGHTING
- CABLES
- BRAKES
- OIL FILTERS
- SUSPENSION
- BODY
- WHEELS
- TIRES / TIRE ACC.
- BIKE ACC.
- VICTORY / INDIAN
- COVERS / LOCKS / TIEDOWNS
- CHEMICALS
- TOOLS
- HELMETS
- HELMET ACC.
- EYEWEAR
- APPAREL / RIDER ACC.
- PROMOTIONAL
- REFERENCE
- INDEX

# HIGHWAY 21 INDUSTRY HOODY



Despite the fact that they don't offer the protections we need while we're pounding the pavement, sometimes hoodies are just what we're in the mood for. In order to keep the good ol' days close to our heart, and keep injuries part of the past, we created the heavyweight of the hoodie class. Designed to be as comfortable as your favorite hoody, but safe enough for the ride, the Industry Hoody has never been more ready for the road.

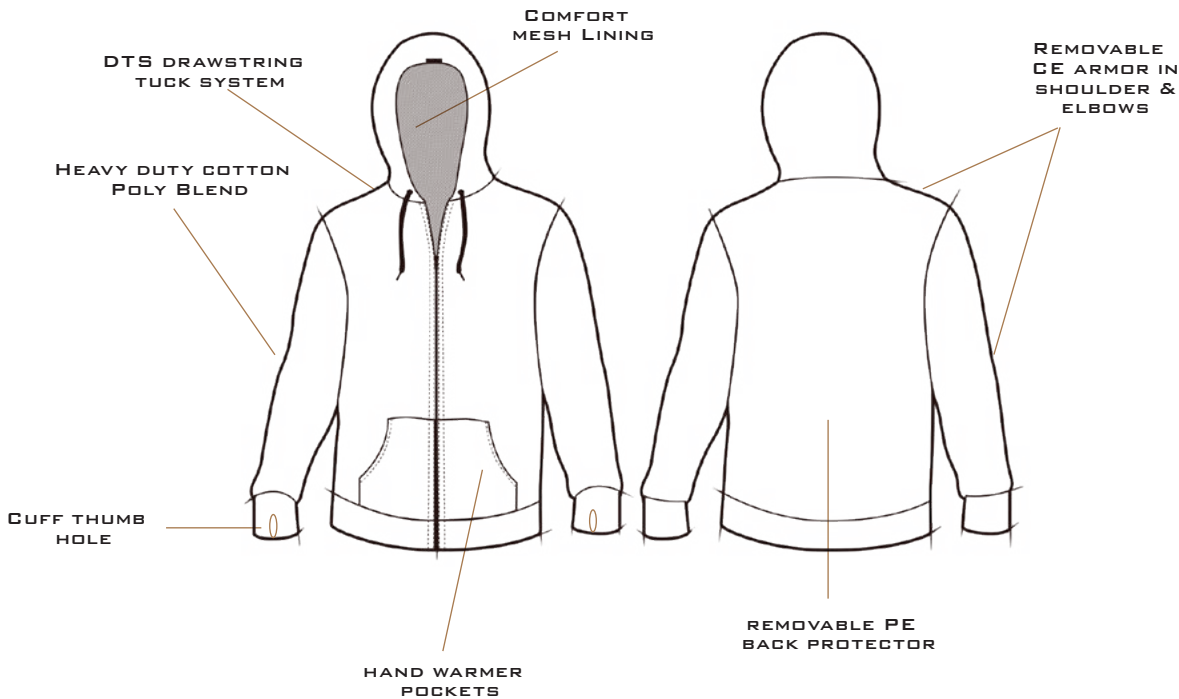

Size	Corporate	Graphic
S	489-1170S	489-1171S
M	489-1170M	489-1171M
L	489-1170L	489-1171L
X	489-1170X	489-1171X
2X	489-11702X	489-11712X
3X	489-11703X	489-11713X
4X	489-11704X	489-11714X



PROTECTION



# MARKSMAN RIDING FLANNEL HIGHWAY 21

When cruising the open road, you don't always have a direction or destination; that's just part of a biker's life. With the streets forever changing, you must be prepared. Look for protection with the Marksman flannel jacket. A jacket as rugged as your grandfather, yet tailored with a classic innovative design that won't let you down. Stay protected, be stylish. Hit your mark

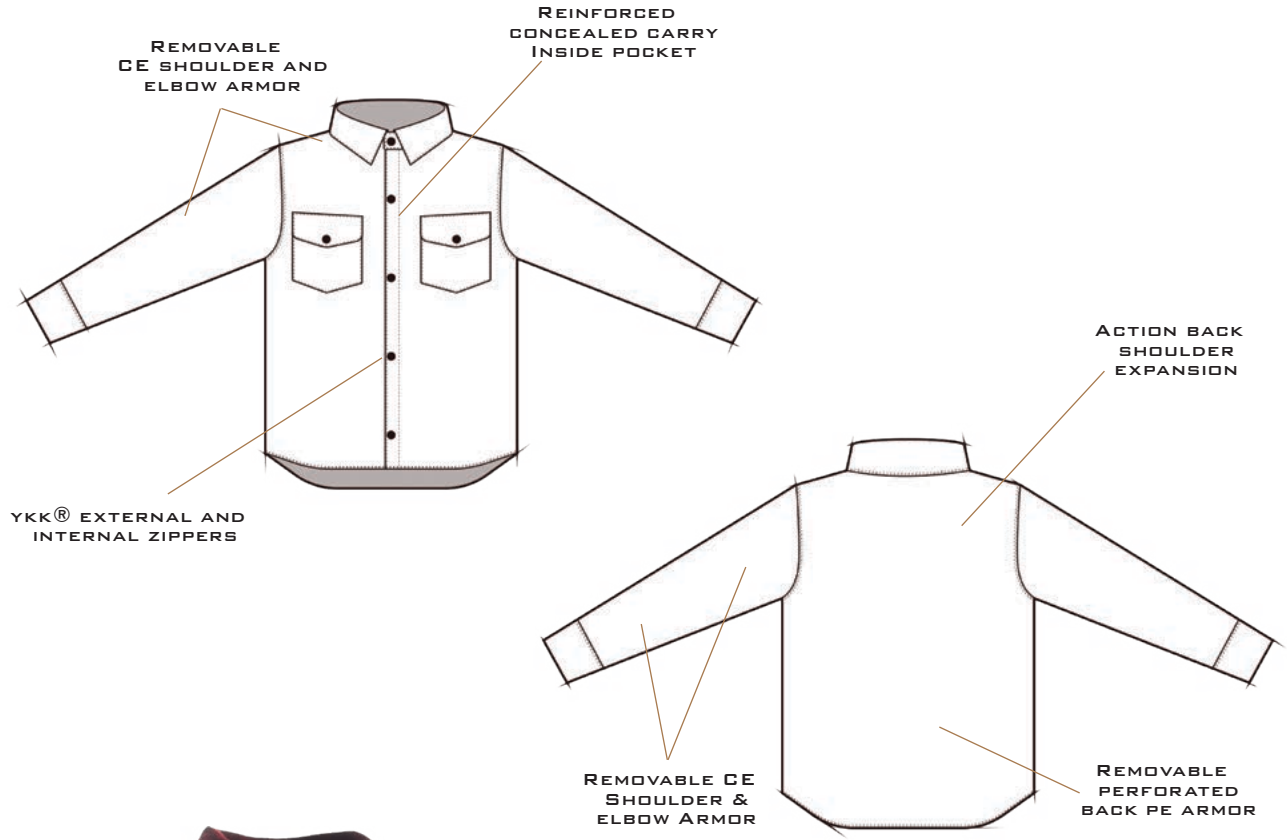

Black/Red



Black/Grey

Size	Blk/Red	Blk/Grey
S	489-1180S	489-1181S
M	489-1180M	489-1181M
L	489-1180L	489-1181L
X	489-1180X	489-1181X
2X	489-11802X	489-11812X
3X	489-11803X	489-11813X
4X	489-11804X	489-11814X

- WINDSHIELDS / FAIRINGS
- AUDIO / COMMUNICATION
- SEATS / LUGGAGE
- BARS / MIRRORS / CONTROLS
- EXHAUST
- AIR / FUEL SYSTEMS
- ENGINE
- TRANSMISSION / DRIVELINE
- GASKETS / SEALS
- ELECTRICAL
- LIGHTING
- CABLES
- BRAKES
- OIL FILTERS
- SUSPENSION
- BODY
- WHEELS
- TIRES / TIRE ACC.
- BIKE ACC.
- VICTORY / INDIAN
- COVERS / LOCKS / TIEDOWNS
- CHEMICALS
- TOOLS
- HELMETS
- HELMET ACC.
- EYEWEAR
- APPAREL / RIDER ACC.
- PROMOTIONAL
- REFERENCE
- INDEX

# HIGHWAY 21 IRON SIGHTS DENIM VEST



**YKK**  
Little Parts. Big Difference

Dating back to the early 1970s, the vintage denim vest is one of America's most iconic pieces of motorcycle apparel. We kept this tried and true original platform with the Highway 21 Iron Sights Denim Vest and simply added a modern twist of functionality. Put on your vest and don your badges with this timeless style.

## TRADITIONAL COLLAR

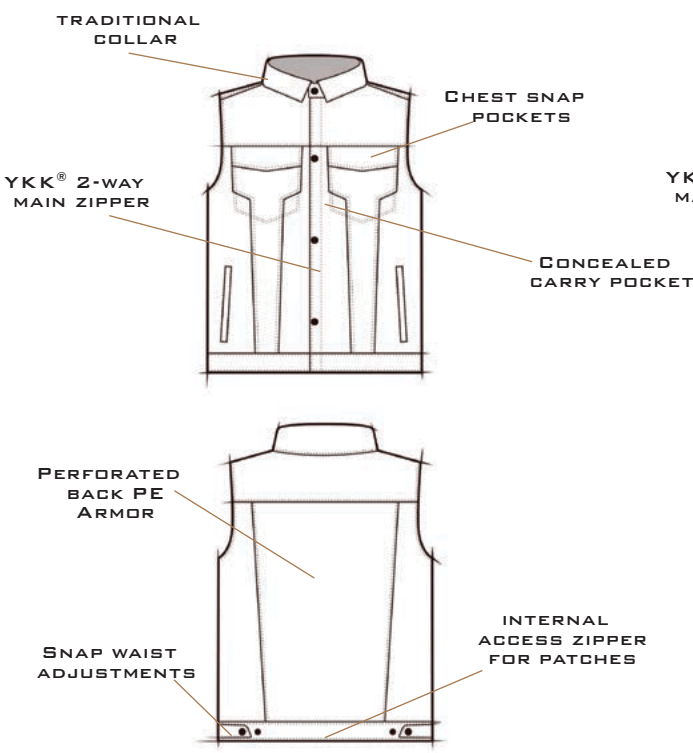

## CLUB COLLAR

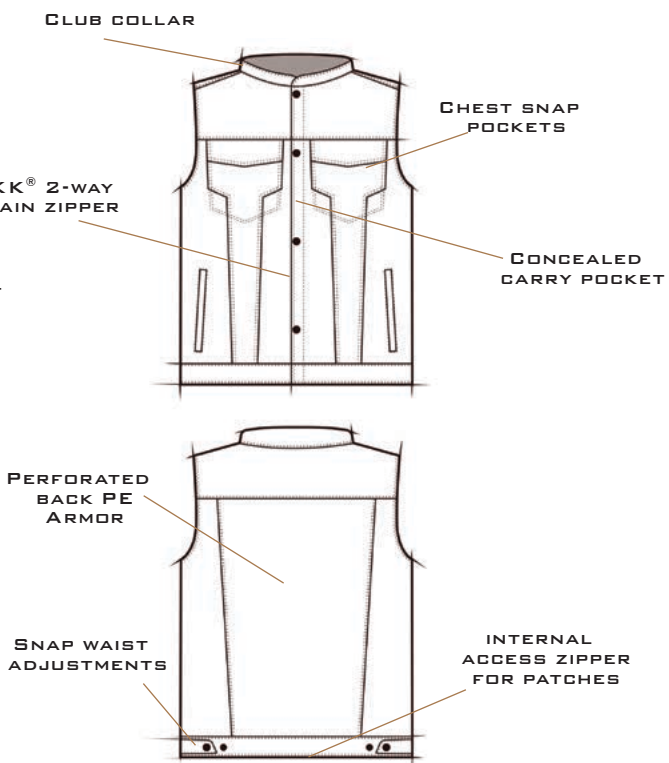

Size	Black	Blue
S	489-1075S	489-1076S
M	489-1075M	489-1076M
L	489-1075L	489-1076L
X	489-1075X	489-1076X
2X	489-10752X	489-10762X
3X	489-10753X	489-10763X
4X	489-10754X	489-10764X

Size	Black	Blue
S	489-1078S	489-1079S
M	489-1078M	489-1079M
L	489-1078L	489-1079L
X	489-1078X	489-1079X
2X	489-10782X	489-10792X
3X	489-10783X	489-10793X
4X	489-10784X	489-10794X





MAGNUM VEST HIGHWAY 21

The Magnum vest packs a huge punch and makes an impact at every stop light. Its fit and features do all the talking. With 100% genuine leather, concealed carry pocket, and such bold styling, this silent threat is one not to be reckoned with. If you're looking for the largest caliber in core protection, the Magnum has your back.

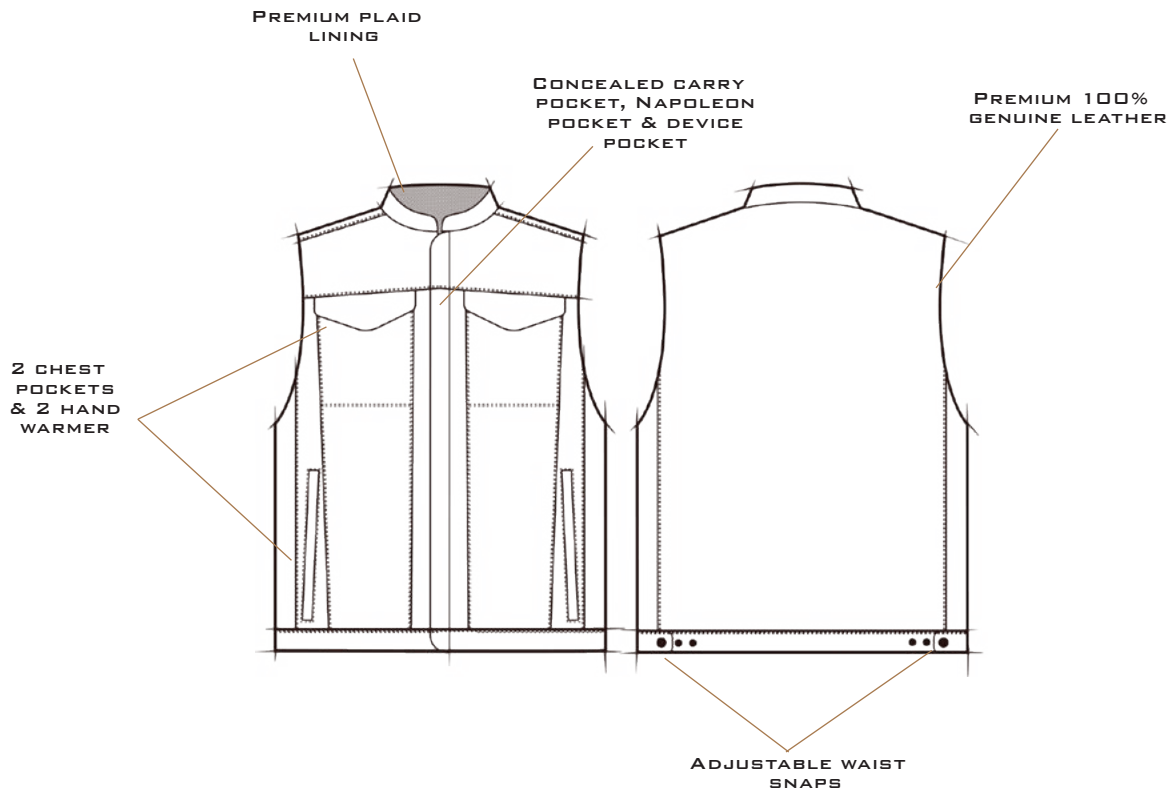

Size	Black
S	489-1071S
M	489-1071M
L	489-1071L
X	489-1071X
2X	489-10712X
3X	489-10713X
4X	489-10714X

- WINDSHIELDS / FAIRINGS
- AUDIO / COMMUNICATION
- SEATS / LUGGAGE
- BARS / MIRRORS / CONTROLS
- EXHAUST
- AIR / FUEL SYSTEMS
- ENGINE
- TRANSMISSION / DRIVELINE
- GASKETS / SEALS
- ELECTRICAL
- LIGHTING
- CABLES
- BRAKES
- OIL FILTERS
- SUSPENSION
- BODY
- WHEELS
- TIRES / TIRE ACC.
- BIKE ACC.
- VICTORY / INDIAN
- COVERS / LOCKS / TIEDOWNS
- CHEMICALS
- TOOLS
- HELMETS
- HELMET ACC.
- EYEWEAR
- APPAREL / RIDER ACC.
- PROMOTIONAL
- REFERENCE
- INDEX

# HIGHWAY 21 BLOCKADE VEST



**YKK**  
Little Parts. Big Difference.

The Blockade vest takes on a new angle with core protection. In this case offense is the best defense; so prepare for the streets like a swat team prepares for their next take down. This tac vest is fully suited in premium leather, adjustable side straps, and a style that ensures you won't be tread on. Put on the Blockade vest, kick down the door and burn down the pavement.

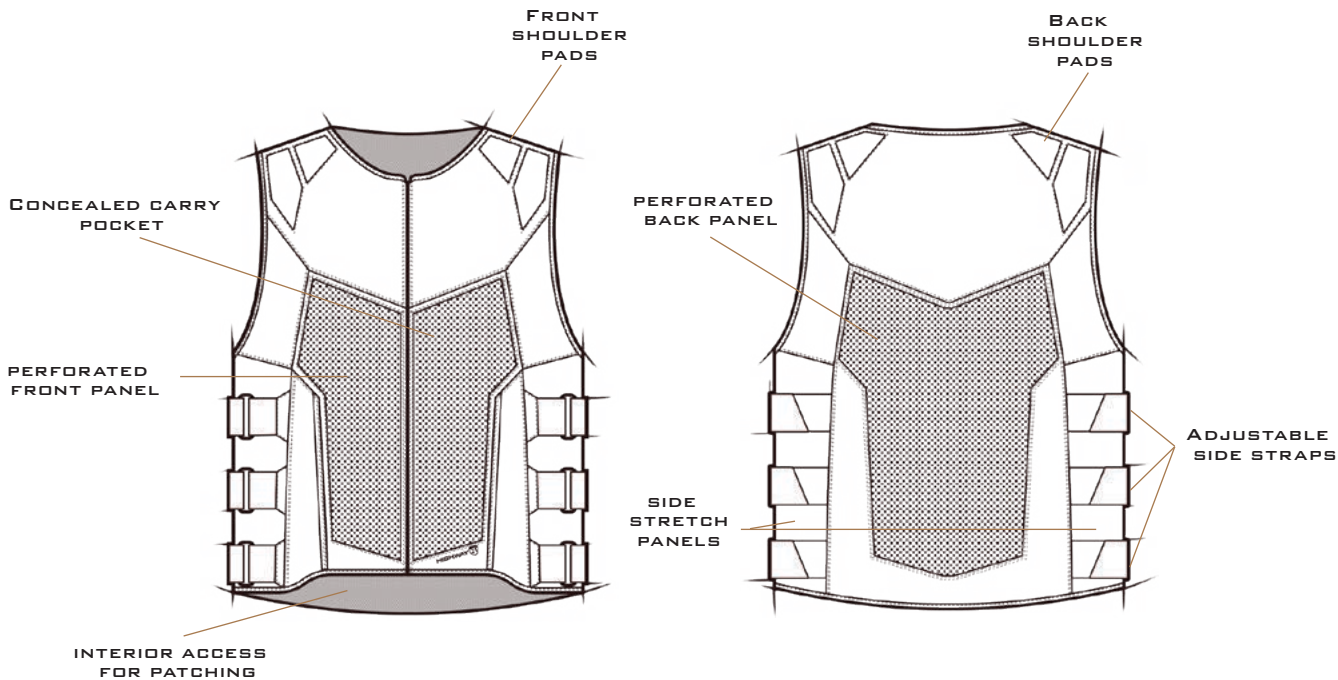

Size	Black
S	489-1080S
M	489-1080M
L	489-1080L
X	489-1080X
2X	489-10802X
3X	489-10803X
4X	489-10804X



12 GAUGE VEST **HIGHWAY 21**

The 12-Gauge vest was built to adapt and overcome everyday obstacles. The 6-point side panel adjustment system allows for multiple set-ups, guaranteeing the perfect fit. Its concealed carry pocket and drop tail add to the 12-Gauge's functionality, while its 100% genuine leather and YKK® zippers ensures the vest will last a lifetime.

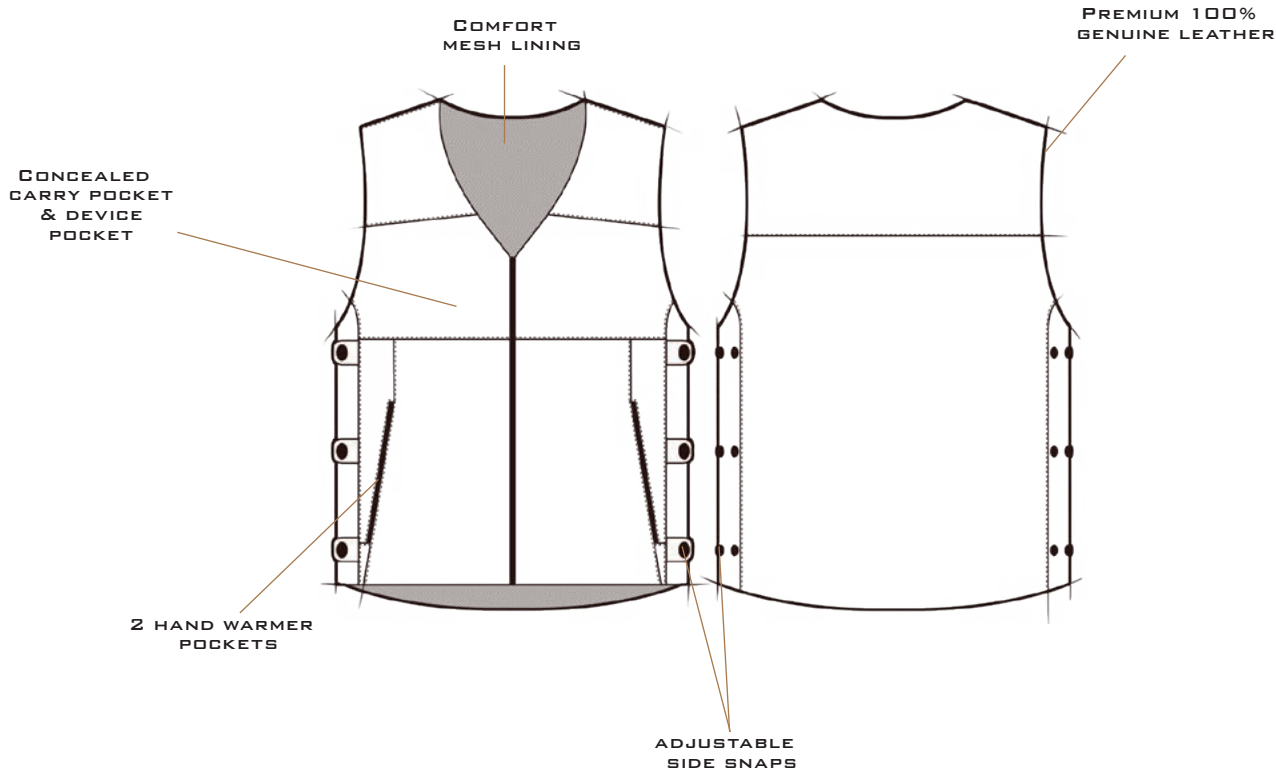

Size	Black
S	489-1072S
M	489-1072M
L	489-1072L
X	489-1072X
2X	489-10722X
3X	489-10723X
4X	489-10724X

- WINDSHIELDS / FAIRINGS
- AUDIO / COMMUNICATION
- SEATS / LUGGAGE
- BARS / MIRRORS / CONTROLS
- EXHAUST
- AIR / FUEL SYSTEMS
- ENGINE
- TRANSMISSION / DRIVELINE
- GASKETS / SEALS
- ELECTRICAL
- LIGHTING
- CABLES
- BRAKES
- OIL FILTERS
- SUSPENSION
- BODY
- WHEELS
- TIRES / TIRE ACC.
- BIKE ACC.
- VICTORY / INDIAN
- COVERS / LOCKS / TIEDOWNS
- CHEMICALS
- TOOLS
- HELMETS
- HELMET ACC.
- EYEWEAR
- APPAREL / RIDER ACC.
- PROMOTIONAL
- REFERENCE
- INDEX

# HIGHWAY 21 SIX SHOOTER VEST



The Six Shooter vest is as traditional as its name. Since the 19th century horsemen spent most of their time on the range, the vest or “office in the saddle” was invented to create storage and added warmth to these lengthy and tough trips. Determined not to leave its roots, we built a vest that looks as good as the original but meets all 20th century standards.

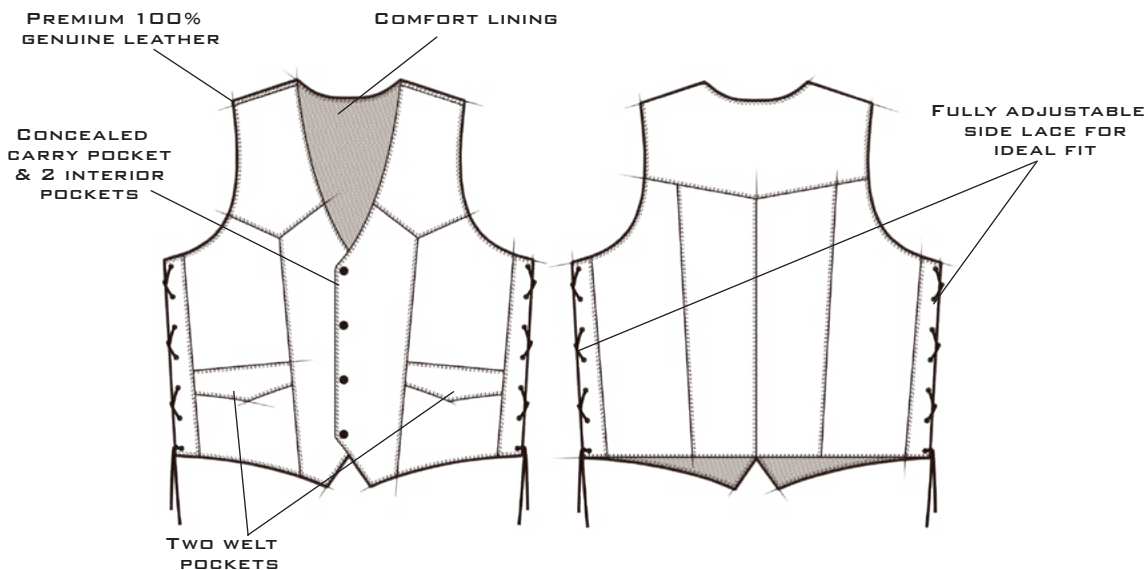

Size	Black
S	489-1070S
M	489-1070M
L	489-1070L
X	489-1070X
2X	489-10702X
3X	489-10703X
4X	489-10704X

- WINDSHIELDS / FAIRINGS
- AUDIO / COMMUNICATION
- SEATS / LUGGAGE
- BAR / MIRRORS / CONTROLS
- EXHAUST
- AIR / FUEL SYSTEMS
- ENGINE
- TRANSMISSION / DRIVELINE
- GASKETS / SEALS
- ELECTRICAL
- LIGHTING
- CABLES
- BRAKES
- OIL FILTERS
- SUSPENSION
- BODY
- WHEELS
- TIRES / TIRE ACC.
- BIKE ACC.
- VICTORY / INDIAN
- COVERS / LOCKS / TIEDOWNS
- CHEMICALS
- TOOLS
- HELMETS
- HELMET ACC.
- EYEWEAR
- APPAREL / RIDER ACC.**
- PROMOTIONAL
- REFERENCE
- INDEX



**YKK**

Little Parts. Big Difference.

21 MAVERICK CHAP HIGHWAY 21

The Maverick chap is designed with America's rich history in mind. Dating back to the 1870's, chaps started finding their way onto horsemen, and over a century later they are still being widely used by horsemen and iron horsemen alike. Put on a pair of Maverick chaps and step into the past to protect your future.

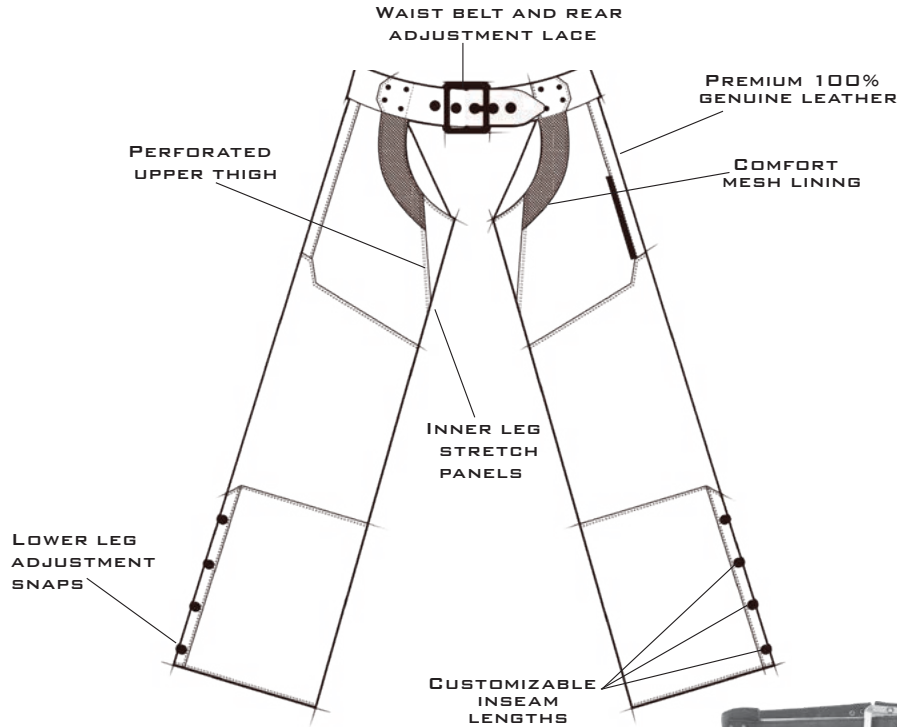

Size	Black	Size	Black
S (30"-42" Waist)	<b>489-1090S</b>	2X (38"-50")	<b>489-10902X</b>
M (32"-44")	<b>489-1090M</b>	3X (40"-52")	<b>489-10903X</b>
L (34"-46")	<b>489-1090L</b>	4X (42"-54")	<b>489-10904X</b>
X (36"-48")	<b>489-1090X</b>		

- WINDSHIELDS / FAIRINGS
- AUDIO / COMMUNICATION
- SEATS / LUGGAGE
- BAR / MIRRORS / CONTROLS
- EXHAUST
- AIR / FUEL SYSTEMS
- ENGINE
- TRANSMISSION / DRIVELINE
- GASKETS / SEALS
- ELECTRICAL
- LIGHTING
- CABLES
- BRAKES
- OIL FILTERS
- SUSPENSION
- BODY
- WHEELS
- TIRES / TIRE ACC.
- BIKE ACC.
- VICTORY / INDIAN
- COVERS / LOCKS / TIEDOWNS
- CHEMICALS
- TOOLS
- HELMETS
- HELMET ACC.
- EYEWEAR
- APPAREL / RIDER ACC.**
- PROMOTIONAL
- REFERENCE
- INDEX

# HIGHWAY 21 DEFENDER JEANS



The Highway 21 Defender DuPont™ Kevlar® Jeans is our classic straight-leg pant for men. Purposed solely for self-preservation, it provides the highest level of DuPont™ Kevlar® and CE protection. When obstacles keep multiplying and streets grow hostile, put on your armor and guard yourself with the Defender Jeans.

LEATHER BELT LOOP FOR CHAIN ATTACHMENT

DETACHABLE HIP ARMOR POCKETS - CAN BE USED WITH CE BARRICADE HIP ARMOR

PLAID POCKETS AND INTERIOR TRIM DETAIL

YKK® FLY ZIPPER

HEAVY WEIGHT 12OZ DENIM

DUPONT™ KEVLAR® FIBER REINFORCED PANELS WITH OVER 70% COVERAGE

CE KNEE ARMOR WITH ADJUSTABLE KNEE ARMOR POCKETS



Size	Inseam	Black	Stonewash
30	30"	489-13130	489-13230
32	32"	489-13132	489-13232
32 Tall	35"	489-13132T	489-13232T
34	32"	489-13134	489-13234
34 Tall	35"	489-13134T	489-13234T
36	32"	489-13136	489-13236
36 Tall	35"	489-13136T	489-13236T
38	33"	489-13138	489-13238
38 Tall	36"	489-13138T	489-13238T
40	33"	489-13140	489-13240
42	33"	489-13142	489-13242
<b>CE BARRICADE HIP ARMOR</b>		<b>477-0007</b>	

- WINDSHIELDS / FAIRINGS
- AUDIO / COMMUNICATION
- SEATS / LUGGAGE
- BARS / MIRRORS / CONTROLS
- EXHAUST
- AIR / FUEL SYSTEMS
- ENGINE
- TRANSMISSION / DRIVELINE
- GASKETS / SEALS
- ELECTRICAL
- LIGHTING
- CABLES
- BRAKES
- OIL FILTERS
- SUSPENSION
- BODY
- WHEELS
- TIRES / TIRE ACC.
- BIKE ACC.
- VICTORY / INDIAN
- COVERS / LOCKS / TIEDOWNS
- CHEMICALS
- TOOLS
- HELMETS
- HELMET ACC.
- EYEWEAR
- APPAREL / RIDER ACC.**
- PROMOTIONAL
- REFERENCE
- INDEX



WOMEN'S PALISADE JEANS **HIGHWAY 21**

The Highway 21 Palisade DuPont™ Kevlar® Jeans is the perfect combination of comfort, protection, and style. Tailored to highlight any figure, this pant is the optimal boot-cut fit that will flatter effortlessly while offering protection.

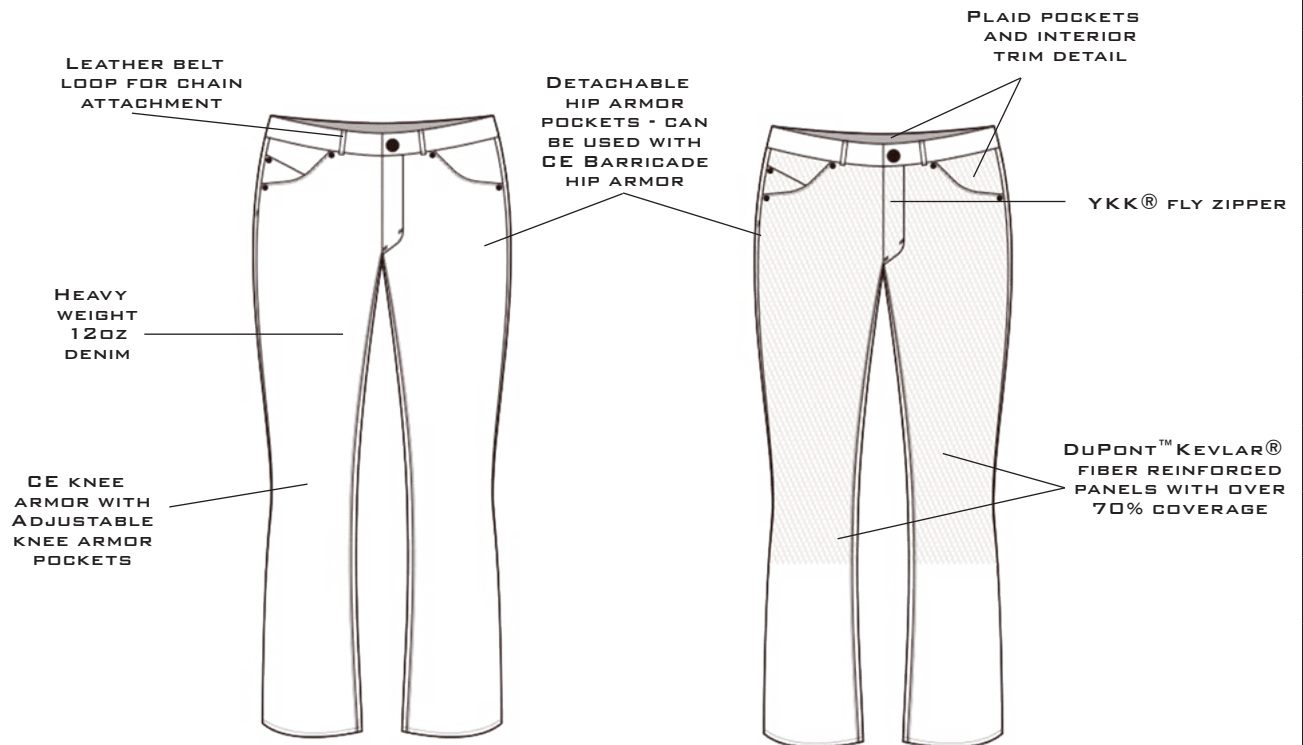

Size	Inseam	Black
2	31"	489-14102
4	31"	489-14104
6	32"	489-14106
8	32"	489-14108
10	33"	489-14110
12	33"	489-14112
14	34"	489-14114
16	34"	489-14116
18	34"	489-14118

**CE BARRICADE HIP ARMOR**  
477-0007

- WINDSHIELDS / FAIRINGS
- AUDIO / COMMUNICATION
- SEATS / LUGGAGE
- BAR / MIRRORS / CONTROLS
- EXHAUST
- AIR / FUEL SYSTEMS
- ENGINE
- TRANSMISSION / DRIVELINE
- GASKETS / SEALS
- ELECTRICAL
- LIGHTING
- CABLES
- BRAKES
- OIL FILTERS
- SUSPENSION
- BODY
- WHEELS
- TIRES / TIRE ACC.
- BIKE ACC.
- VICTORY / INDIAN
- COVERS / LOCKS / TIEDOWNS
- CHEMICALS
- TOOLS
- HELMETS
- HELMET ACC.
- EYEWEAR
- APPAREL / RIDER ACC.**
- PROMOTIONAL
- REFERENCE
- INDEX

**HIGHWAY 21 CASUAL APPAREL**

**HIGHWAY 21 HAT**

- FlexFit flat bill shape with snap back
- Front embroidered logo patch
- One size fits most



**Size WPS#**

Black **489-1900**

**HIGHWAY 21 TEE**

- Standard Fit
- 100% Ring-spun Cotton, 5.5 oz



**Size WPS#**

S **489-1920S**

M **489-1920M**

L **489-1920L**

XL **489-1920X**

2XL **489-19202X**

3XL **489-19203X**

**BLOOD TYPE TEE**



- Premium Fit
- 50/50 Combed-cotton blend, 3.7oz

**Size Black Heather**

S **489-1925S** **489-1926S**

M **489-1925M** **489-1926M**

L **489-1925L** **489-1926L**

XL **489-1925X** **489-1926X**

2X **489-19252X** **489-19262X**

3X **489-19253X** **489-19263X**



WINDSHIELDS / FAIRINGS  
AUDIO / COMMUNICATION  
SEATS / LUGGAGE  
BARS / MIRRORS / CONTROLS  
EXHAUST  
AIR / FUEL SYSTEMS  
ENGINE  
TRANSMISSION / DRIVELINE  
GASKETS / SEALS  
ELECTRICAL  
LIGHTING  
CABLES  
BRAKES  
OIL FILTERS  
SUSPENSION  
BODY  
WHEELS  
TIRES / TIRE ACC.  
BIKE ACC.  
VICTORY / INDIAN  
COVERS / LOCKS / TIEDOWNS  
CHEMICALS  
TOOLS  
HELMETS  
HELMET ACC.  
EYEWEAR  
APPAREL / RIDER ACC.  
PROMOTIONAL  
REFERENCE  
INDEX





### ARMORED TECH HOODY

**MATERIAL:** Tech shell construction is ultra comfortable and lightweight.

**PROTECTION:** EVA armor in shoulders, elbows and back. Can be upgraded to CE armor with optional Fly CE armor kits.

**LINER:** The windproof, water resistant breathable membrane helps keep you warm and dry.

**FEATURES:** A versatile jacket for short runs to the market or out for the evening. Abrasion resistant sub-panel in elbow and shoulder area. Reflective piping and logos for night visibility. Mesh lined interior adds comfort and warmth. Shock cord waistband. Removable hood.



Back without hood attached

With hood attached

Size	Black
S	477-2009S
M	477-2009M
L	477-2009L
X	477-2009X
2X	477-20092X
3X	477-20093X



Shoulders



Elbows



### BARRICADE CE ARMOR KIT

Upgrade your textile or leather jacket to CE level protection

**FEATURES:** Improves performance against impact and abrasions. Fits Fly and most other brands with armor pockets. Flexible and comfortable with a high level of protection. Elbow/shoulder kit includes 2 elbow pads and 2 shoulder pads

**SPECIFICATIONS:** Shoulder: 5"W x 7"H, .5" thick. Elbow: 5"W x 8.25"H, .5" thick. Back kit includes 1 CE level 1 back pad, 11.5"W x 15.5"H, .75" thick

Description	WPS#
Elbows/Shoulders	477-0005
Back	477-0006

- WINDSHIELDS / FAIRINGS
- AUDIO / COMMUNICATION
- SEATS / LUGGAGE
- BARS / MIRRORS / CONTROLS
- EXHAUST
- AIR / FUEL SYSTEMS
- ENGINE
- TRANSMISSION / DRIVELINE
- GASKETS / SEALS
- ELECTRICAL
- LIGHTING
- CABLES
- BRAKES
- OIL FILTERS
- SUSPENSION
- BODY
- WHEELS
- TIRES / TIRE ACC.
- BIKE ACC.
- VICTORY / INDIAN
- COVERS / LOCKS / TIEDOWNS
- CHEMICALS
- TOOLS
- HELMETS
- HELMET ACC.
- EYEWEAR
- APPAREL / RIDER ACC.
- PROMOTIONAL
- REFERENCE
- INDEX



# FLY STRATA JACKET

4 Season jacket allows rider to customize layers based on riding condition.

## OUTER JACKET

**MATERIAL:** 600 D poly-fabric abrasion resistant material. 1680 D ballistic nylon used in high impact areas. Hydra-guard - Weatherproof technology

**PROTECTION:** CE Level 1 removable armor in the shoulders and elbows conforms to EN1621-1 standards. Protective PE back armor that can be upgraded with FLY Barricade CE Armor Kit

**FEATURES:** Windproof and water resistant. Taped seam construction. Anatomically fitted for the perfect riding position. Arm volume adjusters secure armor and provide optimum fit. Velcro® waist adjusters for a customized fit. High-visibility reflective panels and logos for added safety. YKK® main zipper. Drop tail for added coverage. Micro fleece collar for added comfort. Zipper pulls for ease of use with gloves

## MESH JACKET

**MATERIAL:** Abrasion resistant open mesh construction for maximum air flow. 1680D ballistic nylon used in high impact areas

**PROTECTION:** CE Level 1 removable armor in the shoulders and elbows conforms to EN1621-1 standards. Protective PE back armor that can be upgraded with FLY Barricade CE Armor Kit

**FEATURES:** Arm volume adjusters secure armor and provide optimum fit. Velcro® waist adjusters for a customized fit. High-visibility reflective panels and logos for added safety. Drop tail for added coverage. YKK® main zipper. Micro fleece collar for added comfort. Zipper pulls for ease of use with gloves

## THERMAL VEST

**MATERIAL:** 20G of high efficiency thermal insulation.

**FEATURES:** Internal storage pocket. Slim design for performance fit. Reflective chest logo. Low profile collar for maximum comfort. Two zippered hand warmer pockets



OUTER JACKET



MESH JACKET



THERMAL VEST



Black/White/Red



Hi-Vis/Black

Size	Black	Blk/Wht/Red	Hi-Vis/Blk
S	477-2100S	477-2101S	477-2104S
M	477-2100M	477-2101M	477-2104M
L	477-2100L	477-2101L	477-2104L
X	477-2100X	477-2101X	477-2104X
2X	477-21002X	477-21012X	477-21042X
3X	477-21003X	477-21013X	477-21043X
4X	477-21004X	477-21014X	477-21044X



# BASELINE JACKET



Black/White/Red

**MATERIAL:** Advanced lightweight poly main shell provides excellent abrasion and tear resistance with high abrasive fabric used in high impact areas. Shell is waterproof with taped seams to keep you dry.

**PROTECTION:** CE Level 1 removable armor in the shoulders and elbows conforms to EN1621-1 standards. Back armor is PE foam. All armor can be upgraded with FLY Barricade CE Armor Kit. Jacket has high-visibility reflective panels and logos for added safety.

**LINER:** Removable thermal vest provides extra warmth on cold days.

**FEATURES:** Anatomically fitted for reduced fatigue and enhanced rider comfort. Arm volume adjusters secure armor and provide optimum fit on the arms with Velcro® waist adjusters for a customized fit. Drop tail for added coverage with a belt loop snap for quick attachment. Zipper pulls for ease of use with gloves. Soft touch collar for added comfort. YKK® main zipper.



Black



Hi-Vis/Black

Size	Black	Blk/Wht/Red	Hi-Vis/Blk
S	477-2090S	477-2091S	477-2094S
M	477-2090M	477-2091M	477-2094M
L	477-2090L	477-2091L	477-2094L
X	477-2090X	477-2091X	477-2094X
2X	477-20902X	477-20912X	477-20942X
3X	477-20903X	477-20913X	477-20943X
4X	477-20904X	477-20914X	477-20944X

- WINDSHIELDS / FAIRINGS
- AUDIO / COMMUNICATION
- SEATS / LUGGAGE
- BARS / MIRRORS / CONTROLS
- EXHAUST
- AIR / FUEL SYSTEMS
- ENGINE
- TRANSMISSION / DRIVELINE
- GASKETS / SEALS
- ELECTRICAL
- LIGHTING
- CABLES
- BRAKES
- OIL FILTERS
- SUSPENSION
- BODY
- WHEELS
- TIRES / TIRE ACC.
- BIKE ACC.
- VICTORY / INDIAN
- COVERS / LOCKS / TIEDOWNS
- CHEMICALS
- TOOLS
- HELMETS
- HELMET ACC.
- EYEWEAR
- APPAREL / RIDER ACC.
- PROMOTIONAL
- REFERENCE
- INDEX



# FLY BUTANE 4 JACKET



Red/Black



Black



Blue/Black



Gun/Black



Hi-Vis/Black

**MATERIAL:** Multi-material construction with an advanced poly-fabric textile main shell for excellent abrasion and tear resistance. HYDRAGuard protection for durably waterproofing, wind proofing and breathability

**PROTECTION:** CE-certified elbow and shoulder armor. PE back and spine protector. Upper and lower sleeve volume control helps keep your armor in the correct position

**LINER:** Full removable long sleeve thermal liner for climate control. Features inner pocket and fleece lined back panel.

**FEATURES:** Anatomically correct construction for reduced fatigue and enhanced riding comfort. Water resistant zippers on vents. YKK main zippers. Internal waist connection zipper to allow attachment to FLY riding pants. Reflective panels for improved rider visibility.

Size	Black	Red/Black	Blue/Black	Gun/Black	Hi-Vis/Black
S	477-2070S	477-2071S	477-2072S	477-2073S	477-2074S
M	477-2070M	477-2071M	477-2072M	477-2073M	477-2074M
L	477-2070L	477-2071L	477-2072L	477-2073L	477-2074L
X	477-2070X	477-2071X	477-2072X	477-2073X	477-2074X
2X	477-20702X	477-20712X	477-20722X	477-20732X	477-20742X
3X	477-20703X	477-20713X	477-20723X	477-20733X	477-20743X
4X	477-20704X	477-20714X	477-20724X	477-20734X	477-20744X

See page 1310 for size chart

# FLY AIRRAID MESH JACKET



White/Black/Red

**MATERIAL:** Diamond mesh for maximum airflow. YKK zippers®. High abrasive nylon fabric used in impact areas for added protection.

**PROTECTION:** CE Level 1 removable armor in the shoulders and elbows conforms to EN1621-1 standards. Protective PE back armor - CE Barricade armor upgrade compatible. 360° high-visibility reflective panels for added safety.

**LINER:** Hydraguard removable liner provides superior waterproofness and breathability.

**FEATURES:** 3D mesh collar for optimum breathability. Anatomically fitted for the perfect sport riding position. Adjustable Velcro® cuff and waist adjusters for a customized fit. Arm volume adjusters secure armor and provide optimum fit. Zipper pulls for ease of use with gloves. Drop tail for added coverage with a belt loop snap and waist connection zipper for connection to pants.



Black



Hi-Vis/Black

Size	Black	Wht/Blk/Red	Hi-Vis/Blk
S	477-4060S	477-4066S	477-4065S
M	477-4060M	477-4066M	477-4065M
L	477-4060L	477-4066L	477-4065L
X	477-4060X	477-4066X	477-4065X
2X	477-40602X	477-40662X	477-40652X
3X	477-40603X	477-40663X	477-40653X

- WINDSHIELDS / FAIRINGS
- AUDIO / COMMUNICATION
- SEATS / LUGGAGE
- BARS / MIRRORS / CONTROLS
- EXHAUST
- AIR / FUEL SYSTEMS
- ENGINE
- TRANSMISSION / DRIVELINE
- GASKETS / SEALS
- ELECTRICAL
- LIGHTING
- CABLES
- BRAKES
- OIL FILTERS
- SUSPENSION
- BODY
- WHEELS
- TIRES / TIRE ACC.
- BIKE ACC.
- VICTORY / INDIAN
- COVERS / LOCKS / TIEDOWNS
- CHEMICALS
- TOOLS
- HELMETS
- HELMET ACC.
- EYEWEAR
- APPAREL / RIDER ACC.
- PROMOTIONAL
- REFERENCE
- INDEX



# COOLPRO MESH JACKET

**MATERIAL:** Abrasion-resistant mesh and poly outer shell for increased airflow and optimal protection

**PROTECTION:** Removable CE approved armor in the shoulders and elbows. Protective PE back foam and spine protector. High abrasion material used in high impact areas. High-visibility reflective panels and logos for added visibility.

**LINER:** HYDRAGuard removable liner is waterproof, windproof, and breathable so you stay dry without overheating

**FEATURES:** Anatomically correct construction for reduced fatigue and enhanced riding comfort. Arm volume adjusters secure armor and Velcro waist adjusters help customize fit. Zipper pulls designed for ease of use with gloves. Side expansion panels add an extra level of room and comfort. Drop tail for added coverage. Belt loop snap for quick attachment. 8" attachment zipper connects to pant. Micro fleece collar for added comfort. YKK main zipper. 2 zippered exterior hand pockets.



White/Black



Black



Silver/Black



Hi-Vis/Black

Size	Black	Silver/Black	Hi-Vis/Black	White/Black
S	477-4050S	477-4054S	477-4055S	477-4056S
M	477-4050M	477-4054M	477-4055M	477-4056M
L	477-4050L	477-4054L	477-4055L	477-4056L
X	477-4050X	477-4054X	477-4055X	477-4056X
2X	477-40502X	477-40542X	477-40552X	477-40562X
3X	477-40503X	477-40543X	477-40553X	477-40563X

[See page 1310 for size chart](#)



# FLUX AIR MESH JACKET



Black

**MATERIAL:** Full flow mesh for maximum air flow.

**PROTECTION:** CE Level 1 removable armor in the shoulders and elbows conforms to EN1621-1 standards. Protective PE back armor - FLY Barricade CE armor upgrade compatible. High abrasion fabric used in critical impact areas. High-visibility reflective panels for added safety.

**FEATURES:** Anatomically correct construction for reduced fatigue and enhanced riding comfort. Adjustable Velcro® cuff. Velcro® waist adjusters for customized fit. Side expansion panels add an extra level of room and comfort. Arm volume adjusters secure armor and provide optimum fit. YKK® main zipper. Main zipper pull for ease of use with gloves. Drop tail for added coverage. Belt loop snap for quick attachment.



Black/White



Black/Hi-Vis



Camo

Size	Black	Black/White	Black/Hi-Vis	Camo
S	477-4070S	477-4074S	477-4075S	477-4078S
M	477-4070M	477-4074M	477-4075M	477-4078M
L	477-4070L	477-4074L	477-4075L	477-4078L
X	477-4070X	477-4074X	477-4075X	477-4078X
2X	477-40702X	477-40742X	477-40752X	477-40782X
3X	477-40703X	477-40743X	477-40753X	477-40783X

## FLUX AIR MESH INK 'N NEEDLE JACKET

**MATERIAL:** Abrasion-resistant mesh for increased airflow

**PROTECTION:** Removable polyethylene approved armor in the shoulders, elbows and back. Upgradable CE armor kit available. High visibility reflective piping for added safety.

**LINER:** HYDRAGuard - waterproof and windproof removable liner is great for the occasional rain shower, or perfect windbreaker..

**FEATURES:** Anatomically correct construction. 3-step adjustable sleeve volume contro. Zippered wrist cuff

enclosure with security snap. Dual Velcro adjustable waist straps provide a custom fit. 2 zippered hand pockets, interior zippered chest pocket and Velcro chest pocket. Dual, full length side expanders for customized fit.

Size	Ink 'n Needle
S	477-4049S
M	477-4049M
L	477-4049L
X	477-4049X
2X	477-40492X
3X	477-40493X



Ink 'N Needle

- WINDSHIELDS / FAIRINGS
- AUDIO / COMMUNICATION
- SEATS / LUGGAGE
- BARS / MIRRORS / CONTROLS
- EXHAUST
- AIR / FUEL SYSTEMS
- ENGINE
- TRANSMISSION / DRIVELINE
- GASKETS / SEALS
- ELECTRICAL
- LIGHTING
- CABLES
- BRAKES
- OIL FILTERS
- SUSPENSION
- BODY
- WHEELS
- TIRES / TIRE ACC.
- BIKE ACC.
- VICTORY / INDIAN
- COVERS / LOCKS / TIEDOWNS
- CHEMICALS
- TOOLS
- HELMETS
- HELMET ACC.
- EYEWEAR
- APPAREL / RIDER ACC.
- PROMOTIONAL
- REFERENCE
- INDEX



## WOMEN'S BUTANE JACKET



Black

**MATERIAL:** Multi-material construction with an advanced poly-fabric textile main shell for excellent abrasion and tear resistance. HYDRAGuard protection for durably waterproofing, wind proofing and breathability.

**PROTECTION:** CE-certified elbow and shoulder armor. PE back and spine protector. Sleeve volume control helps keep your armor in the correct position. High-visibility reflective panels and logos for added safety.

**LINER:** Full removable long sleeve thermal liner for climate control. Features inner pocket and fleece lined back panel.

**FEATURES:** Anatomically correct construction for reduced fatigue and enhanced riding comfort. YKK main zipper. Zippered cuff with Velcro® adjustment. Velcro® hip and waist adjusters for a customized fit. Side expansion panels add an extra level of room and comfort. Drop tail for added coverage. Belt loop snap for quick attachment. 8" attachment zipper connects to pant. Micro fleece collar for added comfort.



Black/Yellow



Black/Pink



Black/White

Size	Black	Blk/Hi-Vis	Blk/Wht	Blk/Pnk
XS	477-7030XS	477-7036XS	477-7037XS	477-7038XS
S	477-7030S	477-7036S	477-7037S	477-7038S
M	477-7030M	477-7036M	477-7037M	477-7038M
L	477-7030L	477-7036L	477-7037L	477-7038L
XL	477-7030X	477-7036X	477-7037X	477-7038X
2X	477-70302X	477-70362X	477-70372X	477-70382X
3X	477-70303X	477-70363X	477-70373X	477-70383X

See page 1310 for size chart



**WOMEN'S COOLPRO JACKET**



Black

**MATERIAL:** Abrasion-resistant mesh and poly outer shell for increased airflow and optimal protection.

**PROTECTION:** CE-certified elbow and shoulder armor. PE back and spine protector. Sleeve volume control helps keep your armor in the correct position. High-visibility reflective panels and logos for added safety.

**LINER:** HYDRAGuard removable liner is waterproof, windproof, and breathable so you stay dry without overheating.

**FEATURES:** Anatomically correct construction for reduced fatigue and enhanced riding comfort. YKK main zipper. Zippered cuff with Velcro® adjustment. Velcro® waist adjusters for a customized fit. Side expansion panels add an extra level of room and comfort. Drop tail for added coverage. Belt loop snap for quick attachment. 8" attachment zipper connects to pant. Micro fleece collar for added comfort.



Black Back



White/Black



Pink/Black

Size	Black	White/Black	Pink/Black
XS	477-8050XS	477-8056XS	477-8058XS
S	477-8050S	477-8056S	477-8058S
M	477-8050M	477-8056M	477-8058M
L	477-8050L	477-8056L	477-8058L
XL	477-8050X	477-8056X	477-8058X
2X	477-80502X	477-80562X	477-80582X
3X	477-80503X	477-80563X	477-80583X

See page 1310 for size chart

- WINDSHIELDS / FAIRINGS
- AUDIO / COMMUNICATION
- SEATS / LUGGAGE
- BARS / MIRRORS / CONTROLS
- EXHAUST
- AIR / FUEL SYSTEMS
- ENGINE
- TRANSMISSION / DRIVELINE
- GASKETS / SEALS
- ELECTRICAL
- LIGHTING
- CABLES
- BRAKES
- OIL FILTERS
- SUSPENSION
- BODY
- WHEELS
- TIRES / TIRE ACC.
- BIKE ACC.
- VICTORY / INDIAN
- COVERS / LOCKS / TIEDOWNS
- CHEMICALS
- TOOLS
- HELMETS
- HELMET ACC.
- EYEWEAR
- APPAREL / RIDER ACC.
- PROMOTIONAL
- REFERENCE
- INDEX



# FLY WOMEN'S FLUX AIR MESH JACKET

**MATERIAL:** Abrasion-resistant mesh for increased airflow and optimal protection.

**PROTECTION:** Formed polyethylene armor in the shoulders, elbows, and back. CE Armor upgrade kit available. High visibility reflective piping for added safety.

**LINER:** HYDRAGuard - water/wind resistant removable liner is great for the occasional rain shower, or perfect windbreaker for cool mornings or evenings.

**FEATURES:** Anatomically correct construction for reduced fatigue and enhanced riding comfort. 3-step adjustable sleeve volume control, helps keep your armor in just the right place. Zippered wrist cuff enclosure with security snap. Dual Velcro adjustable waist straps provide a custom fit. 2 zippered hand pockets, 1 zippered chest pocket and 1 Velcro chest pocket. Dual, full length side expanders for customized fit.



Black



Hi-Vis/Silver



White/Silver



White/Pink

Size	Black	Hi-Vis/Silver	White/Silver	White/Pink
XS	477-8030XS	477-8036XS	477-8037XS	477-8038XS
S	477-8030S	477-8036S	477-8037S	477-8038S
M	477-8030M	477-8036M	477-8037M	477-8038M
L	477-8030L	477-8036L	477-8037L	477-8038L
X	477-8030X	477-8036X	477-8037X	477-8038X
2X	477-80302X	477-80362X	477-80372X	477-80382X
3X	477-80303X	477-80363X	477-80373X	477-80383X

See page 1310 for size chart

- WINDSHIELDS / FAIRINGS
- AUDIO / COMMUNICATION
- SEATS / LUGGAGE
- BARS / MIRRORS / CONTROLS
- EXHAUST
- AIR / FUEL SYSTEMS
- ENGINE
- TRANSMISSION / DRIVELINE
- GASKETS / SEALS
- ELECTRICAL
- LIGHTING
- CABLES
- BRAKES
- OIL FILTERS
- SUSPENSION
- BODY
- WHEELS
- TIRES / TIRE ACC.
- BIKE ACC.
- VICTORY / INDIAN
- COVERS / LOCKS / TIEDOWNS
- CHEMICALS
- TOOLS
- HELMETS
- HELMET ACC.
- EYEWEAR
- APPAREL / RIDER ACC.
- PROMOTIONAL
- REFERENCE
- INDEX



# TERRA TREK PANT



**MATERIAL:** 600D polyester outer shell with fully taped seams and 1680D material at critical wear areas for added abrasion resistance.

**PROTECTION:** CE Level 1 knee armor - conforms to EN1621-1 standards and sits in an adjustable position pocket. Hip armor pockets that can be used with Fly Street CE Barricade hip armor. High-visibility reflective panels and logos for added safety.

**Liner:** HYDRAGuard waterproof, windproof, and breathable membrane and removable thermal liner.

**FEATURES:** Anatomically fitted for an ideal riding position with strategically placed 4-way stretch panels for added range of motion. Expandable intake and exhaust vents for mass airflow. Cargo pockets for added storage with water resistant pocket zippers. Hi-rise back for full coverage in riding position with accordion back panel for maximum flexibility. Belt loops for refined adjustment with Velcro® dual strap adjustable leg cuffs and waist adjusters for a customized fit. 8" zipper for jacket attachment. Gusseted dual snap fly.

Size	Inseam	Black
30	32"	<b>478-10630</b>
32	33"	<b>478-10632</b>
32 Tall	36"	<b>478-10632T</b>
34	33"	<b>478-10634</b>
34 Tall	36"	<b>478-10634T</b>
36	33"	<b>478-10636</b>
36 Tall	36"	<b>478-10636T</b>
38	34"	<b>478-10638</b>
38 Tall	37"	<b>478-10638T</b>
40	34"	<b>478-10640</b>
40 Tall	37"	<b>478-10640T</b>



- WINDSHIELDS / FAIRINGS
- AUDIO / COMMUNICATION
- SEATS / LUGGAGE
- BARS / MIRRORS / CONTROLS
- EXHAUST
- AIR / FUEL SYSTEMS
- ENGINE
- TRANSMISSION / DRIVELINE
- GASKETS / SEALS
- ELECTRICAL
- LIGHTING
- CABLES
- BRAKES
- OIL FILTERS
- SUSPENSION
- BODY
- WHEELS
- TIRES / TIRE ACC.
- BIKE ACC.
- VICTORY / INDIAN
- COVERS / LOCKS / TIEDOWNS
- CHEMICALS
- TOOLS
- HELMETS
- HELMET ACC.
- EYEWEAR
- APPAREL / RIDER ACC.**
- PROMOTIONAL
- REFERENCE
- INDEX



## BUTANE OVERPANT

**MATERIAL:** Abrasion resistant 600D polyester outer shell with fully taped seams and a HYDRAGuard waterproof, windproof, yet breathable membrane.

**LINER:** Comfort inner liner

**PROTECTION:** CE rated knee armor included in height adjustable pockets. Pockets ready for hip armor which is available separately. Reflective panels and logos for increased visibility.

**FEATURES:** Anatomically fitted for ideal riding position. Designed and fitted to wear over clothes. 3/4 length YKK 2-way side zippers with rain flap and gutter. Waterproof pocket zippers. 8" jacket attachment zipper. Belt loops and high rise back for full coverage and secure fit. Velcro waist and leg cuff adjusters. Leg cuff cutouts to prevent heel drag.



Size	Inseam	Black
30	30"	<b>478-10530</b>
32 Short	30"	<b>478-10532S</b>
32	32"	<b>478-10532</b>
32 Tall	34"	<b>478-10532T</b>
34 Short	30"	<b>478-10534S</b>
34	32"	<b>478-10534</b>
34 Tall	34"	<b>478-10534T</b>
36 Short	31"	<b>478-10536S</b>
36	33"	<b>478-10536</b>
36 Tall	35"	<b>478-10536T</b>
38 Short	31"	<b>478-10538S</b>
38	33"	<b>478-10538</b>
38 Tall	35"	<b>478-10538T</b>
40 Short	31"	<b>478-10540S</b>
40	33"	<b>478-10540</b>
40 Tall	35"	<b>478-10540T</b>

## LADIES BUTANE OVERPANT

**MATERIAL:** Abrasion resistant 600D polyester outer shell with fully taped seams and a HYDRAGuard waterproof, windproof, yet breathable membrane.

**LINER:** Comfort inner liner

**PROTECTION:** CE rated knee armor included in height adjustable pockets. Pockets ready for hip armor which is available separately. Reflective panels and logos for increased visibility.

**FEATURES:** Anatomically fitted for ideal riding position. Designed and sized for women, fitted to wear over clothes. 3/4 length YKK 2-way side zippers with rain flap and gutter. Waterproof pocket zippers. 8" jacket attachment zipper. Belt loops and high rise back for full coverage and secure fit. Velcro waist and leg cuff adjusters. Leg cuff cutouts to prevent heel drag.



Size	Inseam	Black
XS	31"	<b>478-4015XS</b>
S	31.5"	<b>478-4015S</b>
M	32"	<b>478-4015M</b>
L	32"	<b>478-4015L</b>
X	33"	<b>478-4015X</b>
2X	33"	<b>478-40152X</b>

[See page 1310 for size chart](#)

# FLY COOLPRO II MESH PANT



**MATERIAL:** Multi-panel, abrasion resistant mesh design keeps you cool in the hottest conditions. Ballistic nylon in high impact areas

**LINER:** Removable HYDRAGuard liner provides durable windproof, waterproof, and breathable technology.

**PROTECTION:** Removable CE approved knee armor and PE foam hip armor for added protection. Ballistic nylon in high impact areas. Reflective panels for increased visibility.

**Features:** Adjustable, dual Velcro belts with an elastic waist. Two front zipper pockets to help securely store all your goods.

Size	Inseam	Black
30	33"	<b>478-20430</b>
32	34"	<b>478-20432</b>
34	34.5"	<b>478-20434</b>
36	35"	<b>478-20436</b>
38	35.5"	<b>478-20438</b>
40	36.5"	<b>478-20440</b>



[See page 1310 for size chart](#)

- WINDSHIELDS / FAIRINGS
- AUDIO / COMMUNICATION
- SEATS / LUGGAGE
- BARS / MIRRORS / CONTROLS
- EXHAUST
- AIR / FUEL SYSTEMS
- ENGINE
- TRANSMISSION / DRIVELINE
- GASKETS / SEALS
- ELECTRICAL
- LIGHTING
- CABLES
- BRAKES
- OIL FILTERS
- SUSPENSION
- BODY
- WHEELS
- TIRES / TIRE ACC.
- BIKE ACC.
- VICTORY / INDIAN
- COVERS / LOCKS / TIEDOWNS
- CHEMICALS
- TOOLS
- HELMETS
- HELMET ACC.
- EYEWEAR
- APPAREL / RIDER ACC.**
- PROMOTIONAL
- REFERENCE
- INDEX



## MEN'S RESISTANCE JEANS

**MATERIALS:** Heavy weight 12oz denim  
**PROTECTION:** Kevlar reinforced panels with over 70% coverage. CE Level 1 knee armor - conforms to EN1621-1 standards. Detachable hip armor pockets - can be used with CE Barricade hip armor.

**FEATURES:** Plaid pockets and interior trim detail. Key chain attachment in front pocket.



Indigo

Blue

Size	Inseam	Indigo	Blue
30	30"	<b>478-30230</b>	<b>478-30330</b>
32	32"	<b>478-30232</b>	<b>478-30332</b>
32 Tall	35"	<b>478-30232T</b>	<b>478-30332T</b>
34	32"	<b>478-30234</b>	<b>478-30334</b>
34 Tall	35"	<b>478-30234T</b>	<b>478-30334T</b>
36	32"	<b>478-30236</b>	<b>478-30336</b>
36 Tall	35"	<b>478-30236T</b>	<b>478-30336T</b>
38	33"	<b>478-30238</b>	<b>478-30338</b>
38 Tall	36"	<b>478-30238T</b>	<b>478-30338T</b>

## LADIES FORTRESS JEANS

**MATERIALS:** Heavy weight 12oz denim  
**PROTECTION:** Kevlar reinforced panels with over 70% coverage. CE Level 1 knee armor - conforms to EN1621-1 standards. Detachable hip armor pockets - can be used with CE Barricade hip armor.

**FEATURES:** Plaid pockets and interior trim detail. Key chain attachment in front pocket.



Size	Inseam	Indigo
2	31"	<b>478-36202</b>
4	31"	<b>478-36204</b>
6	32"	<b>478-36206</b>
8	32"	<b>478-36208</b>
10	33"	<b>478-36210</b>
12	33"	<b>478-36212</b>
14	34"	<b>478-36214</b>
16	34"	<b>478-36216</b>
18	34"	<b>478-36218</b>

**CE BARRICADE HIP ARMOR**  
**477-0007**

[See page 1310 for size chart](#)



## 1909 VINTAGE JACKET **NEW**

The 1909 vintage leather jacket is made from premium leather that is distressed by hand for a unique soft vintage feel and look. The patterning and fit has been optimized for comfort in the riding position. All critical seams have our EXO-Stitch® internal safety stitching making this a real motorcycle jacket. This antique looking jacket offers excellent protection from the elements and abrasion, and protects against impacts with the removable SAS-Tec® armor at elbows and shoulders. This is an extremely luxurious jacket that will be enjoyed for generations.



- Soft distressed 1.4mm top grain leather and YKK zippers
- Reinforced EXO-Stitch® safety stitching on all critical seams
- Shoulder and elbow SAS-Tec® body armor included
- Leather overlays at elbows
- Perforated inner arm and torso panels
- Removable Everheat® thermal liner
- Four external pockets and two internal pockets

**Size Black/Brown**

S	75-5010S
MD	75-5010M
LG	75-5010L
XL	75-5010X
2X	75-50102X
3X	75-50103X

## CATALINA JACKET **NEW**

We see a lot of people riding around in leather jackets that are not designed for use on motorcycles. Sure they may look nice, but if the materials and construction are not up to the job, the jacket if not going to hold up when you need it most. We've taken extra care when we made the Catalina jacket to use high quality leather, our EXO-Stitch internal safety seam construction, careful patterning and reinforcements, and CE certified SAS-Tec® armor to create a jacket that flatters the female form, and protects the rider.



- Soft distressed 1.2mm top grain leather and YKK zippers
- Reinforced safety stitching on all critical seams
- Shoulder and elbow SAS-Tec® body armor included
- Leather overlays at elbows
- Two zippered shoulder and two rear exhaust vents
- Removable Everheat® thermal vest liner
- Four external pockets and two internal pockets

**Size Brown**

S	75-5304S
M	75-5304M
L	75-5304L
X	75-5304X
2X	75-53042X

- WINDSHIELDS / FAIRINGS
- AUDIO / COMMUNICATION
- SEATS / LUGGAGE
- BAR / MIRRORS / CONTROLS
- EXHAUST
- AIR / FUEL SYSTEMS
- ENGINE
- TRANSMISSION / DRIVELINE
- GASKETS / SEALS
- ELECTRICAL
- LIGHTING
- CABLES
- BRAKES
- OIL FILTERS
- SUSPENSION
- BODY
- WHEELS
- TIRES / TIRE ACC.
- BIKE ACC.
- VICTORY / INDIAN
- COVERS / LOCKS / TIEDOWNS
- CHEMICALS
- TOOLS
- HELMETS
- HELMET ACC.
- EYEWEAR
- APPAREL / RIDER ACC.
- PROMOTIONAL
- REFERENCE
- INDEX



# BIRGMINGHAM JACKETS **NEW**

This is not just another waxed cotton jacket. We've taken the classic waxed cotton jacket and made it better. We strengthened the outer material by combining abrasion resistant nylon into the weave of the fabric. Then we laminated a waterproof / breathable membrane to the back of it, and seam taped every seam. Then we applied a fine waxed coating for the vintage look and to prevent the fabric from absorbing water. Now you have a 100% waterproof garment that has classic looks and 21st century technology. The collar and inner lapel is leather lined, as well as the two large internal pockets. A cotton plaid lining adds to the vintage look. Because this is a motorcycle jacket, we included SAS-Tec armor at the elbows and shoulders. There is a pocket for an optional back protector.

- Abrasion resistant cotton / nylon blend fabric
- 100% waterproof / breathable seam taped
- Reinforced fabrics on elbows/shoulders
- Reinforced EXO-Stitch® safety stitching on all critical seams
- Shoulder and elbow SAS-Tec® body armor included
- Leather trim at collar and inner lapel
- Traditional cotton plaid lining
- Antique brass YKK zippers and snaps.
- Four exterior pockets, two large leather lined inner pockets and rear storage pocket



Size	Black	Green	Size	Black	Green
S	75-5030S	75-5031S	X	75-5030X	75-5031X
M	75-5030M	75-5031M	2X	75-50302X	75-50312X
L	75-5030L	75-5031L	3X	75-50303X	75-50313X

# BIRGMINGHAM PANTS **NEW**

These classic pants are equally comfortable at home walking around town and around the campsite, as they are when worn for long days in the saddle. When combined with the Birmingham jacket you have a traditional looking riding suit that is 100% waterproof, or you can use these riding pants with your current favorite jacket. The included SAS-Tec armor is easily removed from the knees, without having to take the pants off.

- Abrasion resistant cotton / nylon blend fabric
- 100% waterproof / breathable seam taped
- Reinforced fabrics on knees, shins and seat
- Reinforced EXO-Stitch® safety stitching on all critical seams
- Knee and hip SAS-Tec® body protection systems included
- Antique brass YKK zippers and snaps
- Four pockets and two large cargo pockets



Size	Black	Green
S	75-5220S	75-5221S
M	75-5220M	75-5221M
L	75-5220L	75-5221L
X	75-5220X	75-5221X
2X	75-52202X	75-52212X
3X	75-52203X	75-52213X



# INFLUX JACKET **NEW**



Fully ventilated mesh sport jacket with removable wind blocking liner

- Two types of poly mesh main body fabrics for maximum airflow
- 600d polyester reinforcements at elbows and shoulders
- Reinforced EXO-Stitch® safety stitching on all critical seams
- Removable SAS-Tec® body protection for shoulder and elbow included
- Removable full sleeve AirGuard® windproof liner
- NightViz® reflective areas for increased night time visibility
- Accordion stretch panels at elbows and shoulders for full range of motion
- Multiple adjustments for fit and comfort
- Two large hand pockets and internal cell phone / media pocket
- 8" jacket to pants zipper



Size	Black	Red	Grey	Hi-Vis
S	75-5060S	75-5061S	75-5062S	75-5063S
M	75-5060M	75-5061M	75-5062M	75-5063M
L	75-5060L	75-5061L	75-5062L	75-5063L

Size	Black	Red	Grey	Hi-Vis
X	75-5060X	75-5061X	75-5062X	75-5063X
2X	75-50602X	75-50612X	75-50622X	75-50632X
3X	75-50603X	75-50613X	75-50623X	75-50633X

# VERANO JACKET **NEW**

Industry leading lightweight mesh sport jacket for women

- Poly mesh panels and 600d poly textile at arms, shoulders & side of torso
- Reinforced EXO-Stitch® safety stitching on all critical seams
- Removable EXO-Tec® pads for shoulder and elbow included
- Removable AirGuard® windproof liner
- Dual waist adjusters
- NightViz® piping for night time visibility
- Two hand pockets and internal phone / media pockets
- Belt loop for pant attachment



Size	Black	Grey/Blue	Pink
XS	75-5310XS	75-5311XS	75-5312XS
S	75-5310S	75-5311S	75-5312S
M	75-5310M	75-5311M	75-5312M

Size	Black	Grey/Blue	Pink
L	75-5310L	75-5311L	75-5312L
X	75-5310X	75-5311X	75-5312X
2X	75-53102X	75-53112X	75-53122X

- WINDSHIELDS / FAIRINGS
- AUDIO / COMMUNICATION
- SEATS / LUGGAGE
- BARS / MIRRORS / CONTROLS
- EXHAUST
- AIR / FUEL SYSTEMS
- ENGINE
- TRANSMISSION / DRIVELINE
- GASKETS / SEALS
- ELECTRICAL
- LIGHTING
- CABLES
- BRAKES
- OIL FILTERS
- SUSPENSION
- BODY
- WHEELS
- TIRES / TIRE ACC.
- BIKE ACC.
- VICTORY / INDIAN
- COVERS / LOCKS / TIEDOWNS
- CHEMICALS
- TOOLS
- HELMETS
- HELMET ACC.
- EYEWEAR
- APPAREL / RIDER ACC.
- PROMOTIONAL
- REFERENCE
- INDEX



## COVERT WAX RIDING SHIRT NEW

When you don't want to wear a heavy riding jacket, but need more than just a t-shirt; that's where the covert waxed riding shirt comes in. We infused 12oz denim with a unique mixture of micro and technical waxes to make a riding shirt that looks and feels like a classic work shirt, but protects against wind, water, and abrasion. Additionally, it is fully lined with 165g DuPont™ Kevlar® fiber to resist tearing and add strength. EXO-Stitch® safety seams and mesh armor pockets at the elbows, shoulders, and back (for optional SAS-Tec® armor) enable you to add protection from impact. Scorpion has combined the best of old and new technologies to deliver style, comfort, and safety.

- 12 oz. denim with paraffin waxed coating
- 165 GSM DuPont™ Kevlar® lining
- Polyester mesh lining
- Mesh pockets on elbows, shoulders and back for optional SAS-Tec® CE armor
- YKK® center front zipper as well as snaps
- Two upper chest external pockets



Size	Black
S	<b>75-5505S</b>
M	<b>75-5505M</b>
L	<b>75-5505L</b>
X	<b>75-5505X</b>
2X	<b>75-55052X</b>
3X	<b>75-55053X</b>

## COVERT MOTO FLANNEL NEW

We didn't just take a cotton shirt add some Kevlar thread and call it a protective garment. We've been making protective riding apparel for over ten years and want our customers to be safe. The Covert flannel was designed from the very beginning to be a protective garment. The entire shirt is based on a chassis made with 165g DuPont™ Kevlar® lining to protect from tear and abrasion. then we sew a cotton flannel fabric onto the chassis, and add a comfortable mesh liner. Additionally, we have pockets for optional SAS-Tec® CE certified armor at the elbows, shoulders and back. So sure, it looks like your favorite flannel shirt, but inside it has a heart of Kevlar® gold.

- Cotton flannel outer fabric
- 165g DuPont™ Kevlar® lining
- Mesh pockets in elbows, shoulders and back for optional SAS-Tec® CE certified armor
- Two upper chest pockets, and one internal pocket



Size	Black/Grey	Red/Black	Tan/Brown	Black/Yellow	Size	Black/Grey	Red/Black	Tan/Brown	Black/Yellow
S	<b>75-5500S</b>	<b>75-5501S</b>	<b>75-5502S</b>	<b>75-5503S</b>	2X	<b>75-55002X</b>	<b>75-55012X</b>	<b>75-55022X</b>	<b>75-55032X</b>
M	<b>75-5500M</b>	<b>75-5501M</b>	<b>75-5502M</b>	<b>75-5503M</b>	3X	<b>75-55003X</b>	<b>75-55013X</b>	<b>75-55023X</b>	<b>75-55033X</b>
L	<b>75-5500L</b>	<b>75-5501L</b>	<b>75-5502L</b>	<b>75-5503L</b>	4X	<b>75-55004X</b>			
X	<b>75-5500X</b>	<b>75-5501X</b>	<b>75-5502X</b>	<b>75-5503X</b>					



## COVERT/COVERT PRO JEANS

### COVERT PRO

Protective riding jeans with durable Cordura® denim, fully lined with heavy DuPont™ Kevlar® lining for strength and abrasion resistance.

- Cordura® denim is much stronger than standard denim
- Heavy 250g DuPont™ Kevlar® lining
- Mesh pockets for optional larger size SAS-Tec® SC/1-05 knee armor and hip armor
- Knees pockets have “hook & loop” to accommodate armor with Velcro for adjustability
- Nightviz® reflective material in inner cuff for increased nighttime visibility



### COVERT

Lighter weight riding jeans with 14oz denim fully lined with lighter DuPont™ Kevlar® lining for strength and abrasion resistance.

- Standard 14oz denim
- Light 165g DuPont™ Kevlar® lining
- Mesh pockets for optional standard SAS-Tec® SC/1-02 knee armor and SC/1-07 hip armor

Size	Covert Pro		Covert	
	Wash	Blue	Black	Blue
30	75-55330	75-55430	75-55130	75-55230
32	75-55332	75-55432	75-55132	75-55232
34	75-55334	75-55434	75-55134	75-55234
36	75-55336	75-55436	75-55136	75-55236
38	75-55338	75-55438	75-55138	75-55238
40	75-55340	75-55440	75-55140	75-55240
42	75-55342	75-55442	75-55142	75-55242

## SAS-TEC ARMOR

- Viscoelastic memory foam: after an impact or deformation of the foam, the protector will quickly revert to its original shape
- Multiple impact compliance: even if the same area of the protector receives repeated impacts, the protector maintains if fully functional capability
- Adaptive absorption: the air within the cells of the protector allow progressive absorption of energy as the material becomes more firm as it compresses
- Climate stability: SAS-Tec Viscoelastic foam does not break down under high temperatures and can withstand up to 212 degrees Fahrenheit
- Environmentally conscience: partially made of recyclable materials
- Sold as ONE PAIR (except back protectors) certain armor doubles for multiple abrasion zones i.e. elbow, knee means that armor works for both elbow and knees

SAS-Tec® CE Removable Armor	WPS#
SC-1/15 Back Protector Men's	75-08005
SC-1/4 Back Protector Women's	75-08004
SC-1/02 Shoulder/Elbow/Knee Armor Men's	75-08000
SC-1/03 Shoulder Armor - Men's ADV	75-08001
SC-1/01 Shoulder/Elbow/Knee Armor Women's	75-08006
SC-1/07 Hip Armor	75-08007
SC-1/05V Elbow/Knee w/velcro - Men's ADV and Covert Jeans	75-08003

- WINDSHIELDS / FAIRINGS
- AUDIO / COMMUNICATION
- SEATS / LUGGAGE
- BARS / MIRRORS / CONTROLS
- EXHAUST
- AIR / FUEL SYSTEMS
- ENGINE
- TRANSMISSION / DRIVELINE
- GASKETS / SEALS
- ELECTRICAL
- LIGHTING
- CABLES
- BRAKES
- OIL FILTERS
- SUSPENSION
- BODY
- WHEELS
- TIRES / TIRE ACC.
- BIKE ACC.
- VICTORY / INDIAN
- COVERS / LOCKS / TIEDOWNS
- CHEMICALS
- TOOLS
- HELMETS
- HELMET ACC.
- EYEWEAR
- APPAREL / RIDER ACC.
- PROMOTIONAL
- REFERENCE
- INDEX



## DRAYKO RIDING JEANS

Our promise to motorcyclists is, and always will be, in the business of protecting motorcyclists. At Drayko we are dedicated to ensuring that our lining remains at the forefront of fibre technology and provides the safest protection. That has always been our promise to those who choose to wear our products.

It is in keeping this promise, that our jeans are the first and only motorcycle jeans in the world to achieve CE approval. The Drayko lining features the world leading combination of Kevlar® and Dyneema®, the World's Strongest Fiber,™ and is

soft, breathable, flexible, non-allergenic and vastly superior to basic woven or knitted Kevlar® alternatives. Drayko's revolutionary lining takes advantage of Dyneema's amazing strength to weight ratio to deliver unrivalled safety and comfort. Tested in the USA by Precision Laboratories (who do the testing for AMA Superbikes apparel), the lining also achieved results unmatched by any other fiber in its class. Putting the science in perspective, Drayko lining has been proven to last almost 2.5 times longer in crash scenarios than linings found in other products on the market.



## RENEGADE RIDING JEANS

- Heavy liner constructed of Kevlar® and Dyneema® is placed in key areas to protect you from the pavement
- Outlasts the competition by almost 2.5 times
- Added stretch capability allows you to ride comfortably all day long
- Added length allows the rider to customize pant sizing to personal preference

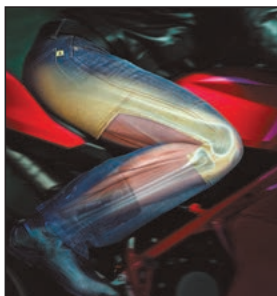

Size	Blue	Black
30	472-11230	472-11030
32	472-11232	472-11032
34	472-11234	472-11034
36	472-11236	472-11036

Size	Blue	Black
38	472-11238	472-11038
40	472-11240	472-11040
42	472-11242	472-11042
44	472-11244	472-11044

## CARGO JEANS

- CE approved riding jean
- Modern military styling
- Optix is a Drayko trademarked digital print
- Traditional waist for rider coverage
- Heavy weight cotton drill fabric
- Loose leg for comfort and fits over riding boots
- Reinforced seams

- Matching stitching
- Wide belt loops
- Zip fly and no rivets on the back for safety
- 4 large front and 2 rear pockets
- Casual and comfortable
- Great for summer riding
- Ideal for travel



Black

Size	Khaki	Black	Optix
30	472-19630	472-19530	472-19430
32	472-19632	472-19532	472-19432
34	472-19634	472-19534	472-19434
36	472-19636	472-19536	472-19436
38	472-19638	472-19538	472-19438
40	472-19640	472-19540	472-19440
42	472-19642	472-19542	472-19442
44	472-19644	472-19544	



Optix



## REBEL RIDING JEANS

- Light blue
- Super soft stretch denim
- Next Gen Patented Technology
- No visible seams/panels
- Mid rise
- Sports liner makes them breathable all year round
- Hip and Knee pockets for armor
- Roomoto™ 7.0 performance lining

Size	WPS #
30	472-12430
32	472-12432
34	472-12434
36	472-12436
38	472-12438
40	472-12440
42	472-12442



## HOLE SHOT JEANS

- Full 360° Roomoto® Liner gives race level protection with 7.45 seconds road abrasion
- Level 2 CE Approved
- Hip and knee armor included
- World's best motorcycle jeans
- Mesh sports comfort liner

Size	WPS#
30	472-19730
32	472-19732
34	472-19734
36	472-19736
38	472-19738
40	472-19740
42	472-19742
44	472-19744



## RACEY RIDING JEANS

- Slim/Skinny Leg
- Super soft blue wash
- No visible seams/panels
- Mid rise
- Sports liner makes them breathable all year round
- Made from stretch denim for comfort
- Roomoto™ 7.0 performance lining

Size	WPS #
2	472-12302
4	472-12304
6	472-12306
8	472-12308
10	472-12310
12	472-12312
14	472-12314

- WINDSHIELDS / FAIRINGS
- AUDIO / COMMUNICATION
- SEATS / LUGGAGE
- BARS / MIRRORS / CONTROLS
- EXHAUST
- AIR / FUEL SYSTEMS
- ENGINE
- TRANSMISSION / DRIVELINE
- GASKETS / SEALS
- ELECTRICAL
- LIGHTING
- CABLES
- BRAKES
- OIL FILTERS
- SUSPENSION
- BODY
- WHEELS
- TIRES / TIRE ACC.
- BIKE ACC.
- VICTORY / INDIAN
- COVERS / LOCKS / TIEDOWNS
- CHEMICALS
- TOOLS
- HELMETS
- HELMET ACC.
- EYEWEAR
- APPAREL / RIDER ACC.
- PROMOTIONAL
- REFERENCE
- INDEX



## TWISTA RIDING JEANS

- No external stitching
- Mesh sports comfort liner
- Breathable

- Skinny Leg
- Knee amour pockets included
- Roomoto™ 7.0 performance lining

### MENS

Size	WPS #
30	472-12530
32	472-12532
34	472-12534
36	472-12536
38	472-12538
40	472-12540
42	472-12542



### LADIES

Size	WPS #
2	472-12502
4	472-12504
6	472-12506
8	472-12508
10	472-12510
12	472-12512
14	472-12514



## DRIFT RIDING JEANS

- CE approved riding jean
- Modern street style fashion jean
- Low waist for comfort
- Hand distressed denim
- Loose leg for comfort and fits over riding boots
- Reinforced seams
- Matching stitching
- Wide belt loops
- Zip fly and no rivets on the back for safety
- Large coin pocket on left for easy access

### MENS

Size	WPS #
28	472-12228
30	472-12230
32	472-12232
34	472-12234
36	472-12236
38	472-12238
40	472-12240
42	472-12242
44	472-12244



### LADIES

Size	WPS #
4	472-22308
6	472-22310
8	472-22312
10	472-22314
12	472-22316
14	472-22318
16	472-22320





Black



## 2-PC. RAINUIT

**MATERIALS:** High quality polyester shell construction with slick inner liner makes putting the suit on a breeze

**FEATURES:** High waist to keep water from entering under coat. Removable shoe straps hold the pants down to keep water from blowing up your leg. Rear vents help remove hot air to keep you drier. Reflective back logo and reflective stripes on chest, back and arms help visibility.

Size	Black/Orange		Black/Hi-Vis
	Black	Black/Orange	Black/Hi-Vis Yellow
S	478-8010S	478-8016S	478-8015S
M	478-8010M	478-8016M	478-8015M
L	478-8010L	478-8016L	478-8015L
X	478-8010X	478-8016X	478-8015X
2X	478-80102X	478-80162X	478-80152X
3X	478-80103X	478-80163X	478-80153X
4X	478-80104X	478-80164X	478-80154X
5X	478-80105X	478-80165X	478-80155X



**DOWCO**  
ENGINEERED FOR ADVENTURE™

## RAINSUIT

- Made of 100% polyester PVC
- Concealed hood sewn into collar
- Reflective piping for increased visibility at night
- Two large front pockets with an additional pocket on the inside liner and drawstring waist
- Pants feature a large zip opening for ease of sliding boots through
- Boot straps hold pants down

Size	WPS #
S	27-6760S
L	27-6760L
X	27-6760X

- WINDSHIELDS / FAIRINGS
- AUDIO / COMMUNICATION
- SEATS / LUGGAGE
- BARS / MIRRORS / CONTROLS
- EXHAUST
- AIR / FUEL SYSTEMS
- ENGINE
- TRANSMISSION / DRIVELINE
- GASKETS / SEALS
- ELECTRICAL
- LIGHTING
- CABLES
- BRAKES
- OIL FILTERS
- SUSPENSION
- BODY
- WHEELS
- TIRES / TIRE ACC.
- BIKE ACC.
- VICTORY / INDIAN
- COVERS / LOCKS / TIEDOWNS
- CHEMICALS
- TOOLS
- HELMETS
- HELMET ACC.
- EYEWEAR
- APPAREL / RIDER ACC.
- PROMOTIONAL
- REFERENCE
- INDEX



WINDSHIELDS / FAIRINGS  
 AUDIO / COMMUNICATION  
 SEATS / LUGGAGE  
 BARS / MIRRORS / CONTROLS  
 EXHAUST  
 AIR / FUEL SYSTEMS  
 ENGINE  
 TRANSMISSION / DRIVELINE  
 GASKETS / SEALS  
 ELECTRICAL  
 LIGHTING  
 CABLES  
 BRAKES  
 OIL FILTERS  
 SUSPENSION  
 BODY  
 WHEELS  
 TIRES / TIRE ACC.  
 BIKE ACC.  
 VICTORY / INDIAN  
 COVERS / LOCKS / TIEDOWNS  
 CHEMICALS  
 TOOLS  
 HELMETS  
 HELMET ACC.  
 EYEWEAR  
**APPAREL / RIDER ACC.**  
 PROMOTIONAL  
 REFERENCE  
 INDEX

### SR-6000 STORMRIDER

- Two-piece, 100% waterproof rain suit.
- Soft Polyester outer shell with PVC backing.
- Jacket has full-length zipper with Velcro® storm flap.
- Two large outer pockets and cooling vents under each arm.
- Soft corduroy inner collar with hood.
- Elasticized waist and adjustable cuff with Velcro® tabs.
- Reflective striping on both jacket and pants for night visibility.
- Pants feature elasticized waist band and cuffs with oversized zipper gussets and elasticized boot stirrups.
- 2 year "No Hassle" warranty.
- Available in Black and Black/Hi-Visibility Yellow.
- Sizes S-4XL.



Size	Black	Black/Hi-Vis	Orange
S	270-1502S	270-1503S	270-1504S
M	270-1502M	270-1503M	270-1504M
L	270-1502L	270-1503L	270-1504L
XL	270-1502X	270-1503X	270-1504X
2X	270-15022X	270-15032X	270-15042X
3X	270-15023X	270-15033X	270-15043X
4X	270-15024X	270-15034X	270-15044X

### WP-8000 WEATHERPRO

- Two-piece, 100% waterproof rain suit.
- Soft Polyester outer shell with PVC backing.
- Jacket has full-length zipper with Velcro® storm flap.
- Outer waterproof chest pocket.
- Elasticized cuff and waist.
- Reflective striping for night visibility.
- Pants feature ankle gussets for easy boot entry.
- 2 year "No Hassle" warranty.
- Available in Black/Black and Black/Hi-Visibility Yellow.
- Sizes S-3XL.



Size	Black	Black/Hi-Vis
S	270-1500S	270-1501S
M	270-1500M	270-1501M
L	270-1500L	270-1501L
XL	270-1500X	270-1501X
2X	270-15002X	270-15012X
3X	270-15003X	270-15013X





## COMPACT RAIN JACKET

- Packs into integrated zippered pouch for convenient storage
- 100% Waterproof Tri-Max Nylon with heat taped seams
- Waterproof zippers and material keep water out and you dry
- Light weight and relaxed fit for comfort
- 2 side zippered pockets and 2 inside stow away open pouches
- Concealed hood with drawstring
- Adjustable draw cord waist for improved comfort and fit
- Elastic cuffs for comfort and adjustability
- 1-Year Warranty

Size	Black	Hi-Viz Yellow
SM	<b>270-1508S</b>	<b>270-1509S</b>
MD	<b>270-1508M</b>	<b>270-1509M</b>
LG	<b>270-1508L</b>	<b>270-1509L</b>
XL	<b>270-1508X</b>	<b>270-1509X</b>
2XL	<b>270-15082X</b>	<b>270-15092X</b>



## AS-3000 ASTON RAINSUIT

- Two-piece 100% waterproof motorcycle rain suit
- Soft Polyester outer shell with PVC backing
- Jacket has full-length zipper with Self-fastening storm flap
- Breathable mesh back lining with nylon lined sleeves
- Three large waterproof outer pockets
- Additional waterproof zippered mesh pocket that can also be used as a vent
- Full length adjustable zipped back ventilation system
- Soft corduroy inner collar with hood
- Comfort stretch elasticized belt adjusters and adjustable cuff with Self-fastening tabs
- Easily accessed waterproof thigh pocket
- Reflective piping on both jacket and pants for night visibility
- Pants boast oversized zipper gussets and elasticized ankle cuff and boot stirrups
- Heat resistant material to protect legs from brief contact with hot parts
- Integrated seat panel to minimize slipping and add strength
- Adjustable elastic suspender straps
- Exclusive 2 year warranty

Size	Black	Hi-Viz	Orange
SM	<b>270-1505S</b>	<b>270-1506S</b>	<b>270-1507S</b>
MD	<b>270-1505M</b>	<b>270-1506M</b>	<b>270-1507M</b>
LG	<b>270-1505L</b>	<b>270-1506L</b>	<b>270-1507L</b>
XL	<b>270-1505X</b>	<b>270-1506X</b>	<b>270-1507X</b>
2X	<b>270-15052X</b>	<b>270-15062X</b>	<b>270-15072X</b>
3X	<b>270-15053X</b>	<b>270-15063X</b>	<b>270-15073X</b>
4X	<b>270-15054X</b>	<b>270-15064X</b>	<b>270-15074X</b>

- WINDSHIELDS / FAIRINGS
- AUDIO / COMMUNICATION
- SEATS / LUGGAGE
- BARS / MIRRORS / CONTROLS
- EXHAUST
- AIR / FUEL SYSTEMS
- ENGINE
- TRANSMISSION / DRIVELINE
- GASKETS / SEALS
- ELECTRICAL
- LIGHTING
- CABLES
- BRAKES
- OIL FILTERS
- SUSPENSION
- BODY
- WHEELS
- TIRES / TIRE ACC.
- BIKE ACC.
- VICTORY / INDIAN
- COVERS / LOCKS / TIEDOWNS
- CHEMICALS
- TOOLS
- HELMETS
- HELMET ACC.
- EYEWEAR
- APPAREL / RIDER ACC.
- PROMOTIONAL
- REFERENCE
- INDEX



**PILOT FROGG™**

The Pilot Crusier is made out of our DriPore Gen 2 waterproof fabric with >15,000mm waterproof and > 10,000 MCTR breathability. This jacket has fully taped and sealed seams.

**CRUISER JACKET**

- Vented, removable hood
- Internal adjustable wrist gaskets
- Beefy #8 chest zipper
- Reflective Frogg Eyzz piping
- New, insulated liner-retention system (Co-Pilot puff jacket and vest insulated liner sold separately)
- New, larger internal dry-storage pocket
- TEFLON DWR coating
- E-Z push hood and hem push-button cord locks
- Zippered, external chest storage and hand-warmer pockets



Size	Hi-Vis Green/ Black
S	<b>470-0056S</b>
M	<b>470-0056M</b>
L	<b>470-0056L</b>
X	<b>470-0056X</b>
2X	<b>470-00562X</b>

**ILLUMINATOR JACKET**

- Vented, removable hood
- Internal adjustable wrist gaskets
- Beefy #8 chest zipper
- Reflective Frogg Eyzz piping and heat-applied reflective tape for max visibility
- New, insulated liner retention system (Co-Pilot insulated puff jacket and vest liner sold separately).
- New, larger internal dry-storage pocket
- TELON DWR coating
- E-Z push hood and hem push-button cord locks
- Zippered, external chest storage and hand-warmer pockets



Size	Black/ Charcoal Grey
S	<b>470-0055S</b>
M	<b>470-0055M</b>
L	<b>470-0055L</b>
X	<b>470-0055X</b>
2X	<b>470-00552X</b>

**ROAD PANTS**

- New locking web belt design
- New heat-resistant inner leg liners
- Removable retention spats at leg openings
- Heat-applied reflective tape for max visibility
- Knee-high zips for easy on and off



Size	Black
S	<b>470-0057S</b>
M	<b>470-0057M</b>
L	<b>470-0057L</b>
X	<b>470-0057X</b>
2X	<b>470-00572X</b>

WINDSHIELDS / FAIRINGS  
AUDIO / COMMUNICATION  
SEATS / LUGGAGE  
BARS / MIRRORS / CONTROLS  
EXHAUST  
AIR / FUEL SYSTEMS  
ENGINE  
TRANSMISSION / DRIVELINE  
GASKETS / SEALS  
ELECTRICAL  
LIGHTING  
CABLES  
BRAKES  
OIL FILTERS  
SUSPENSION  
BODY  
WHEELS  
TIRES / TIRE ACC.  
BIKE ACC.  
VICTORY / INDIAN  
COVERS / LOCKS / TIEDOWNS  
CHEMICALS  
TOOLS  
HELMETS  
HELMET ACC.  
EYEWEAR  
APPAREL / RIDER ACC.  
PROMOTIONAL  
REFERENCE  
INDEX



## TOADZ HIGHWAY™ RAIN JACKET AND PANT

### JACKET FEATURES

- Fully sealed and taped waterproof seams
- Zippered front closure
- Dual storm flap and rain gutter with hook-and-loop front closure and snaps at the top bottom
- Exclusive Frogg Eyzz reflective piping and 2" Toad Strip on back
- Adjustable elastic cuff openings and hideaway hood with drip-free collar adjustments
- Easy-access hand-warmer pockets
- Adjustable elastic wristband with shock cord and dual cord locks

Size	Black/Silver	Hi-Vis Green/Black
<b>TOADZ HIGHWAY™ JACKET</b>		
S	470-0046S	470-0048S
M	470-0046M	470-0048M
L	470-0046L	470-0048L
XL	470-0046X	470-0048X
2XL	470-00462X	470-00482X



### PANT FEATURES

- Fully sealed and taped waterproof seams
- Adjustable, oversized zippered leg openings with storm flap for easy on and off over boots and shoes
- Adjustable elastic waistband with adjustable webbing belt and quick-release buckle
- Frogg Eyzz reflective piping
- Reflective boot strips
- Removable elastic spats to hold leggings down in the wind and rain
- Articulated knee for superior comfort

Size	Black/Silver
<b>TOADZ HIGHWAY™ PANT</b>	
S	470-0049S
M	470-0049M
L	470-0049L
XL	470-0049X
2XL	470-00492X

- WINDSHIELDS / FAIRINGS
- AUDIO / COMMUNICATION
- SEATS / LUGGAGE
- BAR / MIRRORS / CONTROLS
- EXHAUST
- AIR / FUEL SYSTEMS
- ENGINE
- TRANSMISSION / DRIVELINE
- GASKETS / SEALS
- ELECTRICAL
- LIGHTING
- CABLES
- BRAKES
- OIL FILTERS
- SUSPENSION
- BODY
- WHEELS
- TIRES / TIRE ACC.
- BIKE ACC.
- VICTORY / INDIAN
- COVERS / LOCKS / TIEDOWNS
- CHEMICALS
- TOOLS
- HELMETS
- HELMET ACC.
- EYEWEAR
- APPAREL / RIDER ACC.
- PROMOTIONAL
- REFERENCE
- INDEX

- WINDSHIELDS / FAIRINGS
- AUDIO / COMMUNICATION
- SEATS / LUGGAGE
- BARS / MIRRORS / CONTROLS
- EXHAUST
- AIR / FUEL SYSTEMS
- ENGINE
- TRANSMISSION / DRIVELINE
- GASKETS / SEALS
- ELECTRICAL
- LIGHTING
- CABLES
- BRAKES
- OIL FILTERS
- SUSPENSION
- BODY
- WHEELS
- TIRES / TIRE ACC.
- BIKE ACC.
- VICTORY / INDIAN
- COVERS / LOCKS / TIEDOWNS
- CHEMICALS
- TOOLS
- HELMETS
- HELMET ACC.
- EYEWEAR
- APPAREL / RIDER ACC.
- PROMOTIONAL
- REFERENCE
- INDEX



## WOMENS SWEET "T" REFLECTIVE RAIN JACKET AND PANT

### JACKET FEATURES

- New open-waist design for greater versatility, performance and comfort
- E-Z push hood and hem cord locks
- Raglan sleeve
- Adjustable, tuck-away hood
- Elastic wrist openings
- False cape design

Size	Black
S	470-0053S
M	470-0053M
L	470-0053L
X	470-0053X
2X	470-00532X



### PANT FEATURES

- New heat-resistant inner leg liners
- Reflective Frogg Eyzz piping
- 12-inch leg zippers for easy on and off
- Elastic waist with cord lock adjustment

Size	Black
S	470-0054S
M	470-0054M
L	470-0054L
X	470-0054X
2X	470-00542X



## ULTIMATE REPAIR KIT

Everything you need to repair most types of waders and waterproof outerwear. Contains patch adhesive, roughener, applicator brush, as well as rubber, Frogg Toggs® and heat resistant patch materials.

Description	WPS#
Ultimate Repair Kit	470-0029



# MEN'S CLASSIC 50 ROAD TOAD™ RAIN JACKET AND PANT



## JACKET FEATURES

- New open-waist design for greater versatility, performance and comfort
- E-Z push hood and hem cord locks
- Raglan sleeve
- Adjustable, tuck-away hood
- Elastic wrist openings
- False cape design

Size	Black	Hi-Vis Green/Black
S	<b>470-0050S</b>	<b>470-0051S</b>
M	<b>470-0050M</b>	<b>470-0051M</b>
L	<b>470-0050L</b>	<b>470-0051L</b>
XL	<b>470-0050X</b>	<b>470-0051X</b>
2X	<b>470-00502X</b>	<b>470-00512X</b>
3X	<b>470-00503X</b>	



## PANT FEATURES

- New heat-resistant inner leg liners
- Reflective Frogg Eyzz piping
- 12-inch leg zippers for easy on and off
- Elastic waist with cord lock adjustment

Size	Black
S	<b>470-0052S</b>
M	<b>470-0052M</b>
L	<b>470-0052L</b>
X	<b>470-0052X</b>
2X	<b>470-00522X</b>
3X	<b>470-00523X</b>



## FROGG LEGGS®

These heavy duty 17" leggings fit over shoes and boots. Constructed of durable, waterproof 600 denier rubberized nylon, Frogg Leggs® feature adjustable calf and ankle straps, a custom fit calf wrap with top cinch draw cord/cord lock, and a slip-free ripple rubber out-sole for dry walking and riding in rain or snow. The adjustable upper provides leak and burn-free protection for your clothing and shoes. They're ultra-packable, and easily store in a briefcase, backpack or saddlebag.

Shoe Size	WPS#
7 - 9	<b>470-0021S</b>
9 - 11	<b>470-0021M</b>
11 - 13	<b>470-0021L</b>

- WINDSHIELDS / FAIRINGS
- AUDIO / COMMUNICATION
- SEATS / LUGGAGE
- BAR / MIRRORS / CONTROLS
- EXHAUST
- AIR / FUEL SYSTEMS
- ENGINE
- TRANSMISSION / DRIVELINE
- GASKETS / SEALS
- ELECTRICAL
- LIGHTING
- CABLES
- BRAKES
- OIL FILTERS
- SUSPENSION
- BODY
- WHEELS
- TIRES / TIRE ACC.
- BIKE ACC.
- VICTORY / INDIAN
- COVERS / LOCKS / TIEDOWNS
- CHEMICALS
- TOOLS
- HELMETS
- HELMET ACC.
- EYEWEAR
- APPAREL / RIDER ACC.
- PROMOTIONAL
- REFERENCE
- INDEX



## FLY COOLING VEST

**MATERIALS:** Polymer embedded fabric holds the water and keeps you cool as the water evaporates. Remains hydrated for several hours.

**FEATURES:** Evaporative cooling system helps keep you cool even through the hottest summer ride. Only requires two minutes of soaking in water to activate. Outperforms the competition by having an increased evaporative surface area, keeping you cooler.



Size	Black
S	477-6023S
M	477-6023M
L	477-6023L
X	477-6023X
2X	477-60232X
3X	477-60233X

## FLY FAST PASS VEST

**MATERIALS:** Flow through mesh design helps keep you cool

**FEATURES:** High visibility color for increased safety. Highly reflective panels and logos on both front and back for protection during night time riding. Removable I.D. sleeve for quick response. Large back storage pocket stores the vest inside with two internal loops to attach to your belt. Front zipper pocket for tollpass storage. Dual Velcro® expandable side straps offer a wide range of adjustability. Quality YKK® brand zippers. Conforms to Military Branch Codes:



Army: AR 385-10 B-3  
 Navy: OPNAVINST 5100 12H  
 Air Force: AFI 91-207  
 Marines: MCO 5100.19E

Size	Flo Orange
SM - L	478-6019L

ACCESSORIES	
Vest Pouch Pocket	478-6011

## SAFETY VEST

**MATERIALS:** Safety yellow 100% polyester mesh

**FEATURES:** Meets requirements for military base use. EN471 and EN340 compliant for high visibility fabric and high reflective zone. Fully adjustable side straps for custom fit. 3M reflective on front, back, and sides for maximum visibility. YKK main zipper



Size	Hi-Viz Yellow
S-M	478-6020
L-X	478-6021
2X-3X	478-6022

- WINDSHIELDS / FAIRINGS
- AUDIO / COMMUNICATION
- SEATS / LUGGAGE
- BARS / MIRRORS / CONTROLS
- EXHAUST
- AIR / FUEL SYSTEMS
- ENGINE
- TRANSMISSION / DRIVELINE
- GASKETS / SEALS
- ELECTRICAL
- LIGHTING
- CABLES
- BRAKES
- OIL FILTERS
- SUSPENSION
- BODY
- WHEELS
- TIRES / TIRE ACC.
- BIKE ACC.
- VICTORY / INDIAN
- COVERS / LOCKS / TIEDOWNS
- CHEMICALS
- TOOLS
- HELMETS
- HELMET ACC.
- EYEWEAR
- APPAREL / RIDER ACC.
- PROMOTIONAL
- REFERENCE
- INDEX



## BASE LAYERS

### LIGHTWEIGHT

- High-IQ™ advanced evaporation technology helps wick hollow-core fibers transport moisture to the outer surface to dry quickly
- Open fabric structure offers lightweight warmth and all day comfort
- Flat-lock stitch seam construction for added comfort
- Ergonomic panels are form fitting (non-compression)
- Multi-direction stretch fabric allows for un-restricted range of motion
- UPF 40+ sun protection
- Polygiene® Odor Control Technology

### HEAVYWEIGHT

- FLY's heavyweight base-layers are perfect for those colder days, for extra warmth that still wicks moisture fast and dries quick
- Flat-Lock stitch seam construction for added comfort
- Ergonomic panels are form fitting (non-compression)
- Multi-Direction stretch fabric allows for un-restricted range of motion
- UPF 40+ sun protection
- Polygiene® Odor Control Technology

**TOP**

Black	WPS#
<b>LITE LONG SLEEVE TOP</b>	
XS	354-6310XS
S	354-6310S
M	354-6310M
L	354-6310L
X	354-6310X
2X	354-63102X

Black	WPS#
<b>HEAVY LONG SLEEVE TOP</b>	
XS	354-6312XS
S	354-6312S
M	354-6312M
L	354-6312L
X	354-6312X
2X	354-63122X

**PANT**

Black	WPS#
<b>LITE WEIGHT PANT</b>	
XS	354-6311XS
S	354-6311S
M	354-6311M
L	354-6311L
X	354-6311X
2X	354-63112X

Black	WPS#
<b>HEAVY WEIGHT PANT</b>	
XS	354-6313XS
S	354-6313S
M	354-6313M
L	354-6313L
X	354-6313X
2X	354-63132X



- WINDSHIELDS / FAIRINGS
- AUDIO / COMMUNICATION
- SEATS / LUGGAGE
- BAR / MIRRORS / CONTROLS
- EXHAUST
- AIR / FUEL SYSTEMS
- ENGINE
- TRANSMISSION / DRIVELINE
- GASKETS / SEALS
- ELECTRICAL
- LIGHTING
- CABLES
- BRAKES
- OIL FILTERS
- SUSPENSION
- BODY
- WHEELS
- TIRES / TIRE ACC.
- BIKE ACC.
- VICTORY / INDIAN
- COVERS / LOCKS / TIEDOWNS
- CHEMICALS
- TOOLS
- HELMETS
- HELMET ACC.
- EYEWEAR
- APPAREL / RIDER ACC.**
- PROMOTIONAL
- REFERENCE
- INDEX

WINDSHIELDS / FAIRINGS  
 AUDIO / COMMUNICATION  
 SEATS / LUGGAGE  
 BARS / MIRRORS / CONTROLS  
 EXHAUST  
 AIR / FUEL SYSTEMS  
 ENGINE  
 TRANSMISSION / DRIVELINE  
 GASKETS / SEALS  
 ELECTRICAL  
 LIGHTING  
 CABLES  
 BRAKES  
 OIL FILTERS  
 SUSPENSION  
 BODY  
 WHEELS  
 TIRES / TIRE ACC.  
 BIKE ACC.  
 VICTORY / INDIAN  
 COVERS / LOCKS / TIEDOWNS  
 CHEMICALS  
 TOOLS  
 HELMETS  
 HELMET ACC.  
 EYEWEAR  
**APPAREL / RIDER ACC.**  
 PROMOTIONAL  
 REFERENCE  
 INDEX



## 12V GRAND TOURING HEATED MOTORCYCLE SOFT SHELLS



### VentureHeat's 12V Heated Grand Touring Motorcycle Vest

is the complete package, and one of the most versatile vests on the market. This heated vest features 4 heating panels in order to keep your entire core warm. A built-in temperature controller allows you to adjust the heat settings while you are on the go.

You may purchase a wireless remote kit to attach to your handlebars so that you can change the temperature without taking your eyes off of the road.

The vest is constructed with a windproof, stretchable soft shell material to keep you protected from the elements. Pre-wired glove connectors also give you the option to plug-in a set of our heated motorcycle gloves to help minimize the amount of cable and maximize your comfort while out riding.

### Venture 12V Heated Pant Liners

Perfect for taking on the elements and riding in comfort. These heated pant liners are constructed with a wind blocking soft shell on the front, and a stretchable back to help fit comfortably underneath your regular riding pants.



- Built-In Temperature Controller
- Optional Wireless Remote
- Pre-wired Glove Connectors

Size Black

#### SOFT SHELL VEST

S	472-4012S
M	472-4012M
L	472-4012L
XL	472-4012X
2XL	472-40122X

## 12V HYBRID SOFT SHELL HEATED VEST

The 12V Duo Hybrid Heated Vest has versatile capabilities that is designed to work with small to medium size bikes, snowmobiles, ATVs, and older vehicles with limited available power. Although this heated vest draws less than 1.5 amps, it still powers the 4 heating panels located on the collar, chests, and back.

The Duo Hybrid heated vest can be powered by your vehicle's battery via battery harness or by an optional 12V battery. Use the lightweight 12V battery and extend your warm after a long bike ride.

The exterior shell is both water and wind resistant, which keeps you warm and dry on your adventures.

### Quad-Zone Quick Heat

With heat on demand in under 10 second, the Duo Hybrid Heated Vest features a heating element on the back, 1 on each chest, and even the collar is heated.

### Windproof Membrane

The 4-way stretch outer shell is both wind and water resistant to maximize your comfort at all times.



Size Black

XXS	472-4019XXS
XS	472-4019XS
S	472-4019S
M	472-4019M
L	472-4019L
XL	472-4019X
2XL	472-40192X



## 12V HEATED MOTORCYCLE JACKET LINER WITH WIRELESS REMOTE



The Most Comfortable Heated Jacket Liner

Venture Heat's 12V Heated Jacket Liner is a dream come true for any motorcycle rider taking on the elements. This lightweight jacket is windproof and water blocking to help protect you from the cold weather. Its slim design, and form-fitting construction allow you to wear this jacket liner underneath your regular riding jacket.

With a built-in temperature controller, you can adjust the heat to 3 different heat settings with just the touch of a button. This heated jacket also features a wireless remote which can be attached to your handlebars so that you can control the heat without ever having to take your eyes off of the road.

Pick up your 12V heated jacket liner today and start enjoying your rides even more!



- Wireless Remote Included
- Pre-Wired Glove Connectors
- Slim, Form-Fitting Design

### Multi-Zone Heating

The heaters are strategically located on the front, back, sleeves and collar of the jacket to create the most effective heating performance.

Size	Black
XS	472-4016XS
S	472-4016S
M	472-4016M
L	472-4016L
XL	472-4016X
2XL	472-40162X
3XL	472-40163X



## 12V HEATED JACKET LINER LITE



Warm up your next ride with the Heated Motorcycle Liner Lite. Enjoy top-quality warmth similar to the regular Heated Jacket Liner, but for small or medium sized vehicles.

Each heated jacket liner includes a built-in temperature controller that allows heat on-demand. Choose from three temperature settings: hot, medium, and low.

The travel friendly design allows you to roll up the heated jacket liner into its self-contained map pocket. Once it's rolled up, store it away without taking up valuable space.

Full heat coverage  
Even with the smaller amperage, the heated motorcycle jacket liner lite will keep the upper body warm. Enjoy warmth from the heating panel located on the collar, arms, chest, and back.

Size	Black
XXS	472-4001XXS
XS	472-4001XS
S	472-4001S
M	472-4001M
L	472-4001L
XL	472-4001X
2XL	472-40012X
3XL	472-40013X

3.5 amp draw  
The lesser amp draw is designed for smaller vehicles or vintage bikes with limited amp power. Consult vehicle dealership or instructional manual for full battery draw availability.

- WINDSHIELDS / FAIRINGS
- AUDIO / COMMUNICATION
- SEATS / LUGGAGE
- BAR / MIRRORS / CONTROLS
- EXHAUST
- AIR / FUEL SYSTEMS
- ENGINE
- TRANSMISSION / DRIVELINE
- GASKETS / SEALS
- ELECTRICAL
- LIGHTING
- CABLES
- BRAKES
- OIL FILTERS
- SUSPENSION
- BODY
- WHEELS
- TIRES / TIRE ACC.
- BIKE ACC.
- VICTORY / INDIAN
- COVERS / LOCKS / TIEDOWNS
- CHEMICALS
- TOOLS
- HELMETS
- HELMET ACC.
- EYEWEAR
- APPAREL / RIDER ACC.
- PROMOTIONAL
- REFERENCE
- INDEX

- WINDSHIELDS / FAIRINGS
- AUDIO / COMMUNICATION
- SEATS / LUGGAGE
- BARS / MIRRORS / CONTROLS
- EXHAUST
- AIR / FUEL SYSTEMS
- ENGINE
- TRANSMISSION / DRIVELINE
- GASKETS / SEALS
- ELECTRICAL
- LIGHTING
- CABLES
- BRAKES
- OIL FILTERS
- SUSPENSION
- BODY
- WHEELS
- TIRES / TIRE ACC.
- BIKE ACC.
- VICTORY / INDIAN
- COVERS / LOCKS / TIEDOWNS
- CHEMICALS
- TOOLS
- HELMETS
- HELMET ACC.
- EYEWEAR
- APPAREL / RIDER ACC.
- PROMOTIONAL
- REFERENCE
- INDEX



## 12V HEATED INSOLES

Tired of cold feet while riding, here is your solution. The heating elements are positioned throughout the entire insole which allows warmth to be circulated within your foot to give the comfort and protection you need. The polyurethane foam absorbs shock to make bumpier roads more comfortable. The contoured shape follows your foot's anatomical form for maximum support, flexibility, and comfort.



Size	Black
S / 5-6	<b>472-4049S</b>
M / 7-8	<b>472-4049M</b>
L / 9-10	<b>472-4049L</b>
X / 11-12	<b>472-4049X</b>

## HEATED CLOTHING ACCESSORIES

	Description	WPS #
A	12V Replacement Coax Battery Harness	<b>472-4100</b>
B	12V Y-Cable Extension	<b>472-4102</b>
C	12V Powerlet to Female Coax Cable	<b>472-4103</b>
D	12V Coax Y-Splitter Cable	<b>472-4104</b>
E	12V Coax 24" Extension Cable	<b>472-4105</b>
F	12V SAE to Coax Female Cable	<b>472-4106</b>
G	12v Car Adapter	<b>472-4112</b>
H	12v LI-Battery for 12V Gloves	<b>472-4122</b>
I	12v Battery for Hybrid Vest	<b>472-4123</b>
J	Battery Charger for Hybrid Vest Battery 472-4123	<b>472-4124</b>



A



B



C



D



E



F



G



H



I



J



# HIGHWAY 21



## HOOK GLOVE

**MATERIAL:** Genuine Goat skin leather

**FEATURES:** Dual density memory foam for comfort and protection. Gauntlet Cuff. Adjustable wrist closure. Reinforced knuckle. Pre-curved fingers for added comfort and less fatigue. 2 year manufacture's warranty.

Size	Black
<b>HOOK GLOVE</b>	
8 S	<b>489-0010S</b>
9 M	<b>489-0010M</b>
10 L	<b>489-0010L</b>
11 X	<b>489-0010X</b>
12 2X	<b>489-00102X</b>
13 3X	<b>489-00103X</b>



Jab

## JAB GLOVE

**MATERIAL:** Genuine goat skin leather

**FEATURES:** Dual density memory foam for comfort and protection. Kevlar knuckle panel. Adjustable wrist closure. Padded knuckle and palm. Pre-curved fingers for added comfort and less fatigue. 2 year manufacture's warranty

Size	Black
<b>JAB GLOVE</b>	
8 S	<b>489-0019S</b>
9 M	<b>489-0019M</b>
10 L	<b>489-0019L</b>
11 X	<b>489-0019X</b>
12 2X	<b>489-00192X</b>
13 3X	<b>489-00193X</b>
14 4X	<b>489-00194X</b>
15 5X	<b>489-00195X</b>



Perforated Leather



Half Jab

Size	Black
<b>JAB PERFORATED LEATHER</b>	
8 S	<b>489-0017S</b>
9 M	<b>489-0017M</b>
10 L	<b>489-0017L</b>
11 X	<b>489-0017X</b>
12 2X	<b>489-00172X</b>
13 3X	<b>489-00173X</b>
14 4X	<b>489-00174X</b>
15 5X	<b>489-00175X</b>
<b>HALF JAB PERFORATED LEATHER</b>	
8 S	<b>489-0018S</b>
9 M	<b>489-0018M</b>
10 L	<b>489-0018L</b>
11 X	<b>489-0018X</b>
12 2X	<b>489-00182X</b>
13 3X	<b>489-00183X</b>
14 4X	<b>489-00184X</b>
15 5X	<b>489-00185X</b>

- WINDSHIELDS / FAIRINGS
- AUDIO / COMMUNICATION
- SEATS / LUGGAGE
- BARS / MIRRORS / CONTROLS
- EXHAUST
- AIR / FUEL SYSTEMS
- ENGINE
- TRANSMISSION / DRIVELINE
- GASKETS / SEALS
- ELECTRICAL
- LIGHTING
- CABLES
- BRAKES
- OIL FILTERS
- SUSPENSION
- BODY
- WHEELS
- TIRES / TIRE ACC.
- BIKE ACC.
- VICTORY / INDIAN
- COVERS / LOCKS / TIEDOWNS
- CHEMICALS
- TOOLS
- HELMETS
- HELMET ACC.
- EYEWEAR
- APPAREL / RIDER ACC.
- PROMOTIONAL
- REFERENCE
- INDEX

# HIGHWAY 21

## TRIGGER GLOVE

**MATERIAL:** Genuine goat skin leather

**FEATURES:** Touch screen compatible. Adjustable wrist closure. Pre-curved fingers for added comfort and less fatigue. Memory foam in palms for reduced vibration and comfort. Reinforced knuckle, finger and palm pads. 2 year manufacture's warranty

Size	Black
<b>TRIGGER GLOVE</b>	
8 S	489-0011S
9 M	489-0011M
10 L	489-0011L
11 X	489-0011X
12 2X	489-00112X
13 3X	489-00113X



Touch screen compatible



## HAYMAKER GLOVE

**MATERIAL:** Genuine goat skin leather

**FEATURES:** Touch screen compatible. Adjustable wrist closure. Pre-curved fingers for added comfort and less fatigue. Memory foam in palms for reduced vibration and comfort. Reinforced hard knuckle. 2 year manufacture's warranty

Size	Black
<b>HAYMAKER</b>	
8 S	489-0012S
9 M	489-0012M
10 L	489-0012L
11 X	489-0012X
12 2X	489-00122X
13 3X	489-00123X



Touch screen compatible



## REVOLVER GLOVE

**MATERIAL:** Genuine goat skin leather. Tactical Kevlar outer shell.

**FEATURES:** Touch screen compatible. Adjustable wrist closure. Pre-curved fingers for added comfort and less fatigue. Memory foam in palms for reduced vibration and comfort. Reinforced hard knuckle. 2 year manufacture's warranty

Size	Black
<b>REVOLVER</b>	
8 S	489-0013S
9 M	489-0013M
10 L	489-0013L
11 X	489-0013X
12 2X	489-00132X
13 3X	489-00133X



Touch screen compatible



- WINDSHIELDS / FAIRINGS
- AUDIO / COMMUNICATION
- SEATS / LUGGAGE
- BARS / MIRRORS / CONTROLS
- EXHAUST
- AIR / FUEL SYSTEMS
- ENGINE
- TRANSMISSION / DRIVELINE
- GASKETS / SEALS
- ELECTRICAL
- LIGHTING
- CABLES
- BRAKES
- OIL FILTERS
- SUSPENSION
- BODY
- WHEELS
- TIRES / TIRE ACC.
- BIKE ACC.
- VICTORY / INDIAN
- COVERS / LOCKS / TIEDOWNS
- CHEMICALS
- TOOLS
- HELMETS
- HELMET ACC.
- EYEWEAR
- APPAREL / RIDER ACC.**
- PROMOTIONAL
- REFERENCE
- INDEX

WINDSHIELDS / FAIRINGS  
 AUDIO / COMMUNICATION  
 SEATS / LUGGAGE  
 BARS / MIRRORS / CONTROLS  
 EXHAUST  
 AIR / FUEL SYSTEMS  
 ENGINE  
 TRANSMISSION / DRIVELINE  
 GASKETS / SEALS  
 ELECTRICAL  
 LIGHTING  
 CABLES  
 BRAKES  
 OIL FILTERS  
 SUSPENSION  
 BODY  
 WHEELS  
 TIRES / TIRE ACC.  
 BIKE ACC.  
 VICTORY / INDIAN  
 COVERS / LOCKS / TIEDOWNS  
 CHEMICALS  
 TOOLS  
 HELMETS  
 HELMET ACC.  
 EYEWEAR  
**APPAREL / RIDER ACC.**  
 PROMOTIONAL  
 REFERENCE  
 INDEX



**SILENCER GLOVE**

**MATERIAL:** Genuine Goat skin leather. Tactical Kevlar outer shell.

**FEATURES:** Touch screen compatible. Adjustable wrist closure. Pre-curved fingers for added comfort and less fatigue. Memory foam in palms for reduced vibration and comfort. Reinforced knuckle, finger and palm pads. 2 year manufacturer's warranty

Size	Black
<b>SILENCER</b>	
8 S	<b>489-0014S</b>
9 M	<b>489-0014M</b>
10 L	<b>489-0014L</b>
11 X	<b>489-0014X</b>
12 2X	<b>489-00142X</b>
13 3X	<b>489-00143X</b>



Touch screen compatible



**RECOIL GLOVE**

**MATERIAL:** Genuine Goat skin leather

**FEATURES:** YKK brand zipper closure. Memory foam in palms for reduced vibration and comfort. 2 year manufacturer's warranty

Size	Black	Tan
<b>RECOIL</b>		
8 S	<b>489-0008S</b>	<b>489-0009S</b>
9 M	<b>489-0008M</b>	<b>489-0009M</b>
10 L	<b>489-0008L</b>	<b>489-0009L</b>
11 X	<b>489-0008X</b>	<b>489-0009X</b>
12 2X	<b>489-00082X</b>	<b>489-00092X</b>
13 3X	<b>489-00083X</b>	<b>489-00093X</b>



- WINDSHIELDS / FAIRINGS
- AUDIO / COMMUNICATION
- SEATS / LUGGAGE
- BARS / MIRRORS / CONTROLS
- EXHAUST
- AIR / FUEL SYSTEMS
- ENGINE
- TRANSMISSION / DRIVELINE
- GASKETS / SEALS
- ELECTRICAL
- LIGHTING
- CABLES
- BRAKES
- OIL FILTERS
- SUSPENSION
- BODY
- WHEELS
- TIRES / TIRE ACC.
- BIKE ACC.
- VICTORY / INDIAN
- COVERS / LOCKS / TIEDOWNS
- CHEMICALS
- TOOLS
- HELMETS
- HELMET ACC.
- EYEWEAR
- APPAREL / RIDER ACC.
- PROMOTIONAL
- REFERENCE
- INDEX

# HIGHWAY 21

## PITT GLOVE

**MATERIAL:** Genuine Goat skin leather

**FEATURES:** Touch screen compatible. Adjustable wrist closure. 2 year manufacture's warranty.

Size	Black
<b>PITT LEATHER GLOVE</b>	
8 S	<b>489-0025S</b>
9 M	<b>489-0025M</b>
10 L	<b>489-0025L</b>
11 X	<b>489-0025X</b>
12 2X	<b>489-00252X</b>
13 3X	<b>489-00253X</b>



Touch screen compatible



## TURBINE MESH GLOVE

**MATERIAL:** High -flow mesh for superior breathability. Full genuine leather palms for dexterity and abrasion resistance

**FEATURES:** Impact foam reinforced palms for protection and vibration absorption. Pre-curved construction for comfortable fit. Leather accordion panels on knuckles for added protection and flex. Touch screen compatible. Branded snap enclosure.

Size	Black
<b>TURBINE MESH GLOVE</b>	
8 S	<b>489-0001S</b>
9 M	<b>489-0001M</b>
10 L	<b>489-0001L</b>
11 X	<b>489-0001X</b>
12 2X	<b>489-00012X</b>
13 3X	<b>489-00013X</b>



Touch screen compatible



## RANGER GLOVE NEW

**MATERIAL:** Genuine Leather. 4-way stretch panels.

**FEATURES:** Perforated Top Panels. Finger pull tabs. Vibration dampening. Velcro cuff closure

Size	Black
<b>RANGER</b>	
8 S	<b>489-0030S</b>
9 M	<b>489-0030M</b>
10 L	<b>489-0030L</b>
11 X	<b>489-0030X</b>
12 2X	<b>489-00302X</b>
13 3X	<b>489-00303X</b>
14 4X	<b>489-00304X</b>
15 5X	<b>489-00305X</b>



WINDSHIELDS / FAIRINGS  
 AUDIO / COMMUNICATION  
 SEATS / LUGGAGE  
 BARS / MIRRORS / CONTROLS  
 EXHAUST  
 AIR / FUEL SYSTEMS  
 ENGINE  
 TRANSMISSION / DRIVELINE  
 GASKETS / SEALS  
 ELECTRICAL  
 LIGHTING  
 CABLES  
 BRAKES  
 OIL FILTERS  
 SUSPENSION  
 BODY  
 WHEELS  
 TIRES / TIRE ACC.  
 BIKE ACC.  
 VICTORY / INDIAN  
 COVERS / LOCKS / TIEDOWNS  
 CHEMICALS  
 TOOLS  
 HELMETS  
 HELMET ACC.  
 EYEWEAR  
 APPAREL / RIDER ACC.  
 PROMOTIONAL  
 REFERENCE  
 INDEX



**LADIES ROULETTE GLOVE**

**MATERIAL:** Genuine Goat skin leather

**FEATURES:** Expandable cuff. Adjustable wrist closure. Memory foam in palms for reduced vibration and comfort. Pre-curved fingers for added comfort and less fatigue. 2 year manufacture's warranty.

Size	Black
<b>ROULETTE</b>	
6 S	489-0082S
7 M	489-0082M
8 L	489-0082L
9 X	489-0082X
10 2X	489-00822X



**BLACK IVY LADIES GLOVE**

**MATERIAL:** Genuine Goat skin leather

**FEATURES:** Dual density memory foam for comfort and protection. Laser etched design. Adjustable wrist closure. Pre curved fingers for added comfort and less fatigue. Reinforced knuckle. 2 year manufacture's warranty

Size	Black
<b>BLACK IVY LADIES GLOVE</b>	
6 S	489-0080S
7 M	489-0080M
8 L	489-0080L
9 X	489-0080X
10 2X	489-00802X



**LADIES RANGER GLOVE**



**MATERIAL:** Genuine Leather. 4-way stretch panels.

**FEATURES:** Perforated Top Panels. Finger pull tabs. Vibration dampening. Velcro cuff closure

Size	Black
<b>RANGER</b>	
6 S	489-0098S
7 M	489-0098M
8 L	489-0098L
9 X	489-0098X
10 2X	489-00982X

# HIGHWAY 21

## LADIES VIXEN GLOVE

**MATERIAL:** Genuine goat skin leather palm

**FEATURES:** Touch screen compatible. Reflective piping for increased visibility. Soft knuckles provide protection and comfort. Pre-curved fingers for added comfort and less fatigue. 2 year manufacture's warranty.



Size	Black	Blk/Wht Lace	Purple Lace	Liberty Brown
<b>VIXEN</b>				
6 S	489-0090S	489-0091S	489-0092S	489-0093S
7 M	489-0090M	489-0091M	489-0092M	489-0093M
8 L	489-0090L	489-0091L	489-0092L	489-0093L
9 X	489-0090X	489-0091X	489-0092X	489-0093X
10 2X	489-00902X	489-00912X	489-00922X	489-00932X



## LADIES TURBINE MESH GLOVE

**MATERIAL:** High flow mesh

**FEATURES:** Genuine leather palm. Pre-curved fingers. Vibration dampening. Accordion panels for full flex. Touch Screen technology. 2 year manufacture's warranty.



Size	WPS#
<b>TURBINE</b>	
6 S	489-0085S
7 M	489-0085M
8 L	489-0085L
9 XL	489-0085X
10 2XL	489-00852X



Touch screen compatible

- WINDSHIELDS / FAIRINGS
- AUDIO / COMMUNICATION
- SEATS / LUGGAGE
- BAR / MIRRORS / CONTROLS
- EXHAUST
- AIR / FUEL SYSTEMS
- ENGINE
- TRANSMISSION / DRIVELINE
- GASKETS / SEALS
- ELECTRICAL
- LIGHTING
- CABLES
- BRAKES
- OIL FILTERS
- SUSPENSION
- BODY
- WHEELS
- TIRES / TIRE ACC.
- BIKE ACC.
- VICTORY / INDIAN
- COVERS / LOCKS / TIEDOWNS
- CHEMICALS
- TOOLS
- HELMETS
- HELMET ACC.
- EYEWEAR
- APPAREL / RIDER ACC.
- PROMOTIONAL
- REFERENCE
- INDEX





### RADIANT GLOVE

**MATERIAL:** Genuine leather construction

**FEATURES:** Lithium ion battery and controller with 3 heat settings. 100g of Thinsulate insulation. Hipora® liner is waterproof and windproof while still offering breathability. Adjustable gauntlet. Armored knuckles for added protection. Pre-curved fingers enhance comfort and reduce rider fatigue. Touch Screen compatible

Size	WPS#
<b>RADIANT</b>	
8 S	489-0003S
9 M	489-0003M
10 L	489-0003L
11 XL	489-0003X
12 2XL	489-00032X
13 3XL	489-00033X
<b>REPLACEMENT PARTS</b>	
Radiant Battery w/out heat control (ea)	476-29005
Wall charger	476-29002



Touch screen compatible



Wind deflector attached

### DEFLECTOR COLD WEATHER GLOVE

**MATERIAL:** Premium 100% Genuine Leather

**FEATURES:** Armored Knuckles for added protection. Pre-curved fingers. Impact foam reinforced palm. Removable 4" wind deflector. Impact foam reinforced fingers. Touch screen compatible. Accordion finger panels for added flexibility. Cold Comfort cuff.

Size	Black
<b>DEFLECTOR GLOVE</b>	
8 S	489-0002S
9 M	489-0002M
10 L	489-0002L
11 X	489-0002X
12 2X	489-00022X
13 3X	489-00023X



Touch screen compatible



4" Wind Deflector can be removed

- WINDSHIELDS / FAIRINGS
- AUDIO / COMMUNICATION
- SEATS / LUGGAGE
- BARS / MIRRORS / CONTROLS
- EXHAUST
- AIR / FUEL SYSTEMS
- ENGINE
- TRANSMISSION / DRIVELINE
- GASKETS / SEALS
- ELECTRICAL
- LIGHTING
- CABLES
- BRAKES
- OIL FILTERS
- SUSPENSION
- BODY
- WHEELS
- TIRES / TIRE ACC.
- BIKE ACC.
- VICTORY / INDIAN
- COVERS / LOCKS / TIEDOWNS
- CHEMICALS
- TOOLS
- HELMETS
- HELMET ACC.
- EYEWEAR
- APPAREL / RIDER ACC.
- PROMOTIONAL
- REFERENCE
- INDEX

- WINDSHIELDS / FAIRINGS
- AUDIO / COMMUNICATION
- SEATS / LUGGAGE
- BARS / MIRRORS / CONTROLS
- EXHAUST
- AIR / FUEL SYSTEMS
- ENGINE
- TRANSMISSION / DRIVELINE
- GASKETS / SEALS
- ELECTRICAL
- LIGHTING
- CABLES
- BRAKES
- OIL FILTERS
- SUSPENSION
- BODY
- WHEELS
- TIRES / TIRE ACC.
- BIKE ACC.
- VICTORY / INDIAN
- COVERS / LOCKS / TIEDOWNS
- CHEMICALS
- TOOLS
- HELMETS
- HELMET ACC.
- EYEWEAR
- APPAREL / RIDER ACC.
- PROMOTIONAL
- REFERENCE
- INDEX

# HIGHWAY 21

## GRANITE GLOVE

**MATERIAL:** Genuine Goat skin leather

**FEATURES:** 3M 60g Thinsulate insulation. Adjustable dual wrist closures. Foam reinforced palm. HiPora waterproof/breathable liner. Pre-curved finger construction for comfort and less fatigue. 2 year manufacture's warranty

Size	Black
<b>GRANITE GLOVE</b>	
8 S	<b>489-0020S</b>
9 M	<b>489-0020M</b>
10 L	<b>489-0020L</b>
11 X	<b>489-0020X</b>
12 2X	<b>489-00202X</b>
13 3X	<b>489-00203X</b>



## LADIES BLACK ROSE GLOVE

**MATERIAL:** Genuine leather palm. Hipora® waterproof liner

**FEATURES:** 70grams of Thinsulate insulation. Armored knuckles. Adjustable wrist cuff. Pre-curved fingers. Vibration dampening. Touch Screen Compatible.

Size	WPS#
<b>BLACK ROSE</b>	
6 S	<b>489-0096S</b>
7 M	<b>489-0096M</b>
8 L	<b>489-0096L</b>
9 XL	<b>489-0096X</b>
10 2XL	<b>489-00962X</b>



Touch screen compatible





**SUBVERT GLOVE**



Fracture

**MATERIALS:** Genuine Leather Palm. Molded hard knuckles. 4-way stretch at forchettes.

**FEATURES:** Pre-curved construction. Thumb and palm reinforcement. Sublimated Graphic touch screen technology. TPR wrist closure



Touch screen compatible

Size	Highland	Fracture	Ink 'N Needle
<b>SUBVERT</b>			
8 S	476-2072S	476-2073S	476-2074S
9 M	476-2072M	476-2073M	476-2074M
10 L	476-2072L	476-2073L	476-2074L
11 X	476-2072X	476-2073X	476-2074X
12 2X	476-20722X	476-20732X	476-20742X
13 3X	476-20723X	476-20733X	476-20743X



Highland



Ink 'N Needle



**THRUST LEATHER GLOVE**

**MATERIALS:** Genuine goat skin. Foam impact knuckle. Thermoplastic finger knuckles

**FEATURES:** Expansion gussets. TPR closure system. Gloves snap together. Touchscreen technology

Size	WPS#
<b>THRUST</b>	
8 S	476-0025S
9 M	476-0025M
10 L	476-0025L
11 XL	476-0025X
12 2XL	476-00252X
13 3XL	476-00253X



Touch screen compatible

- WINDSHIELDS / FAIRINGS
- AUDIO / COMMUNICATION
- SEATS / LUGGAGE
- BARS / MIRRORS / CONTROLS
- EXHAUST
- AIR / FUEL SYSTEMS
- ENGINE
- TRANSMISSION / DRIVELINE
- GASKETS / SEALS
- ELECTRICAL
- LIGHTING
- CABLES
- BRAKES
- OIL FILTERS
- SUSPENSION
- BODY
- WHEELS
- TIRES / TIRE ACC.
- BIKE ACC.
- VICTORY / INDIAN
- COVERS / LOCKS / TIEDOWNS
- CHEMICALS
- TOOLS
- HELMETS
- HELMET ACC.
- EYEWEAR
- APPAREL / RIDER ACC.
- PROMOTIONAL
- REFERENCE
- INDEX

WINDSHIELDS / FAIRINGS  
 AUDIO / COMMUNICATION  
 SEATS / LUGGAGE  
 BARS / MIRRORS / CONTROLS  
 EXHAUST  
 AIR / FUEL SYSTEMS  
 ENGINE  
 TRANSMISSION / DRIVELINE  
 GASKETS / SEALS  
 ELECTRICAL  
 LIGHTING  
 CABLES  
 BRAKES  
 OIL FILTERS  
 SUSPENSION  
 BODY  
 WHEELS  
 TIRES / TIRE ACC.  
 BIKE ACC.  
 VICTORY / INDIAN  
 COVERS / LOCKS / TIEDOWNS  
 CHEMICALS  
 TOOLS  
 HELMETS  
 HELMET ACC.  
 EYEWEAR  
**APPAREL / RIDER ACC.**  
 PROMOTIONAL  
 REFERENCE  
 INDEX



## BRAWLER GLOVE

**MATERIALS:** Perforated leather. Kevlar stitching.  
**FEATURES:** Short street brawler design. Vented knuckle armor. Pre-curved fingers. Palm and wrist impact foam. Touch screen compatible.



Size		Black	Gunmetal	Black/White	Black/ Hi-Vis	White/Hi-Vis
<b>BRAWLER</b>						
8	S	476-2040S	476-2044S	476-2045S	476-2046S	476-2048S
9	M	476-2040M	476-2044M	476-2045M	476-2046M	476-2048M
10	L	476-2040L	476-2044L	476-2045L	476-2046L	476-2048L
11	X	476-2040X	476-2044X	476-2045X	476-2046X	476-2048X
12	2X	476-20402X	476-20442X	476-20452X	476-20462X	476-20482X
13	3X	476-20403X	476-20443X	476-20453X	476-20463X	476-20483X



Touch screen compatible

## COOLPRO FORCE GLOVE

**MATERIALS:** Expanded mesh back panels. Reinforced Clarino™ palm.  
**FEATURES:** Mesh/hard knuckle design offers protection even on the hottest day. TPR wrist closure. Pre-curved construction. Touch screen compatible.



Size		Black	Red/Black	Blue/Black	Gun/Black	Black/Silver
<b>COOLPRO FORCE</b>						
8	S	476-4110S	476-4111S	476-4112S	476-4113S	476-4114S
9	M	476-4110M	476-4111M	476-4112M	476-4113M	476-4114M
10	L	476-4110L	476-4111L	476-4112L	476-4113L	476-4114L
11	X	476-4110X	476-4111X	476-4112X	476-4113X	476-4114X
12	2X	476-41102X	476-41112X	476-41122X	476-41132X	476-41142X
13	3X	476-41103X	476-41113X	476-41123X	476-41133X	476-41143X



Touch screen compatible



**COOLPRO II GLOVE**

**MATERIALS:** Mesh construction. Expanded mesh back panels. Reinforced Clarino™ palm with silicone print for grip

**FEATURES:** Pre-curved construction. Touch screen compatible. TPR wrist closure



Size		Black	Red/Black	Blue/Black	Gun/Black	
<b>COOLPRO II</b>						
8	S	476-4020S	476-4021S	476-4022S	476-4023S	
9	M	476-4020M	476-4021M	476-4022M	476-4023M	
10	L	476-4020L	476-4021L	476-4022L	476-4023L	
11	X	476-4020X	476-4021X	476-4022X	476-4023X	
12	2X	476-40202X	476-40212X	476-40222X	476-40232X	
13	3X	476-40203X	476-40213X	476-40223X	476-40233X	



Touch screen compatible



- WINDSHIELDS / FAIRINGS
- AUDIO / COMMUNICATION
- SEATS / LUGGAGE
- BARS / MIRRORS / CONTROLS
- EXHAUST
- AIR / FUEL SYSTEMS
- ENGINE
- TRANSMISSION / DRIVELINE
- GASKETS / SEALS
- ELECTRICAL
- LIGHTING
- CABLES
- BRAKES
- OIL FILTERS
- SUSPENSION
- BODY
- WHEELS
- TIRES / TIRE ACC.
- BIKE ACC.
- VICTORY / INDIAN
- COVERS / LOCKS / TIEDOWNS
- CHEMICALS
- TOOLS
- HELMETS
- HELMET ACC.
- EYEWEAR
- APPAREL / RIDER ACC.**
- PROMOTIONAL
- REFERENCE
- INDEX



### LADIES COOLPRO II GLOVE

**MATERIALS:** Expanded mesh back panel Reinforced Clarino™ palm with silicone print for extra grip.  
**FEATURES:** TPR wrist closure. Pre-curved construction. Touchscreen compatible.



Size	White/Pink	White/Gray	Black
<b>LADIES COOLPRO II</b>			
6 S	476-6210S	476-6211S	476-6212S
7 M	476-6210M	476-6211M	476-6212M
8 L	476-6210L	476-6211L	476-6212L
9 X	476-6210X	476-6211X	476-6212X

### LADIES I-84 LEATHER GLOVE

**MATERIALS:** Genuine goat skin leather  
**FEATURES:** Adjustable wrist. Padded reinforced palm. External outseam design and pre-curved fingers for rider comfort

Size	Black
<b>LADIES I-84</b>	
6 S	476-6010S
7 M	476-6010M
8 L	476-6010L
9 X	476-6010X



### LADIES VENUS GLOVE

**MATERIALS:** Genuine leather accents. Reinforced Clarino™ palm.  
**FEATURES:** TPR wrist closure. Soft knuckles provide protection and comfort. Touchscreen compatible



Touch screen compatible



Size	Blk/Gry	Pnk/Blk	Wht/Blk
<b>LADIES VENUS</b>			
6 S	476-6120S	476-6121S	476-6122S
7 M	476-6120M	476-6121M	476-6122M
8 L	476-6120L	476-6121L	476-6122L
9 X	476-6120X	476-6121X	476-6122X

WINDSHIELDS / FAIRINGS  
 AUDIO / COMMUNICATION  
 SEATS / LUGGAGE  
 BARS / MIRRORS / CONTROLS  
 EXHAUST  
 AIR / FUEL SYSTEMS  
 ENGINE  
 TRANSMISSION / DRIVELINE  
 GASKETS / SEALS  
 ELECTRICAL  
 LIGHTING  
 CABLES  
 BRAKES  
 OIL FILTERS  
 SUSPENSION  
 BODY  
 WHEELS  
 TIRES / TIRE ACC.  
 BIKE ACC.  
 VICTORY / INDIAN  
 COVERS / LOCKS / TIEDOWNS  
 CHEMICALS  
 TOOLS  
 HELMETS  
 HELMET ACC.  
 EYEWEAR  
**APPAREL / RIDER ACC.**  
 PROMOTIONAL  
 REFERENCE  
 INDEX



### RUMBLE CW GLOVE

**MATERIALS:** All leather outer is tough, but comfortable. HydraGuard waterproof and breathable membrane.

Mid-weight insulation

**FEATURES:** Adjustable wrist closure.

Size	Black
<b>RUMBLE CW</b>	
8 S	476-0050S
9 M	476-0050M
10 L	476-0050L
11 X	476-0050X
12 2X	476-00502X
13 3X	476-00503X

### RUMBLE LEATHER GLOVE

**MATERIALS:** Genuine goat skin leather. Available in standard and perforated versions.

**FEATURES:** Adjustable wrist closure. Padded reinforced palm. Pre-curved construction

Size	Black
<b>RUMBLE LEATHER</b>	
8 S	476-0010S
9 M	476-0010M
10 L	476-0010L
11 X	476-0010X
12 2X	476-00102X
13 3X	476-00103X

Size	Black
<b>RUMBLE PERFORATED LEATHER</b>	
8 S	476-0020S
9 M	476-0020M
10 L	476-0020L
11 X	476-0020X
12 2X	476-00202X
13 3X	476-00203X



Standard Leather

Perforated Leather

### HALF N HALF LEATHER GLOVE

**MATERIALS:** Genuine goat skin leather. Available in standard and perforated versions.

**FEATURES:** Adjustable wrist closure. Padded reinforced palm. Fingerless design.

Size	Black
<b>HALF-N-HALF FINGERLESS LEATHER</b>	
8 S	476-0030S
9 M	476-0030M
10 L	476-0030L
11 X	476-0030X
12 2X	476-00302X
13 3X	476-00303X

Size	Black
<b>HALF-N-HALF FINGERLESS PERFORATED LEATHER</b>	
8 S	476-0040S
9 M	476-0040M
10 L	476-0040L
11 X	476-0040X
12 2X	476-00402X
13 3X	476-00403X



Standard Leather

Perforated Leather

- WINDSHIELDS / FAIRINGS
- AUDIO / COMMUNICATION
- SEATS / LUGGAGE
- BAR / MIRRORS / CONTROLS
- EXHAUST
- AIR / FUEL SYSTEMS
- ENGINE
- TRANSMISSION / DRIVELINE
- GASKETS / SEALS
- ELECTRICAL
- LIGHTING
- CABLES
- BRAKES
- OIL FILTERS
- SUSPENSION
- BODY
- WHEELS
- TIRES / TIRE ACC.
- BIKE ACC.
- VICTORY / INDIAN
- COVERS / LOCKS / TIEDOWNS
- CHEMICALS
- TOOLS
- HELMETS
- HELMET ACC.
- EYEWEAR
- APPAREL / RIDER ACC.
- PROMOTIONAL
- REFERENCE
- INDEX

- WINDSHIELDS / FAIRINGS
- AUDIO / COMMUNICATION
- SEATS / LUGGAGE
- BARS / MIRRORS / CONTROLS
- EXHAUST
- AIR / FUEL SYSTEMS
- ENGINE
- TRANSMISSION / DRIVELINE
- GASKETS / SEALS
- ELECTRICAL
- LIGHTING
- CABLES
- BRAKES
- OIL FILTERS
- SUSPENSION
- BODY
- WHEELS
- TIRES / TIRE ACC.
- BIKE ACC.
- VICTORY / INDIAN
- COVERS / LOCKS / TIEDOWNS
- CHEMICALS
- TOOLS
- HELMETS
- HELMET ACC.
- EYEWEAR
- APPAREL / RIDER ACC.
- PROMOTIONAL
- REFERENCE
- INDEX



## XPLORE GLOVE

**MATERIALS:** Leather palm panels. 3M 60g Thinsulate insulation keeps fingers warm on those cold mornings yet thin for good grip. Hipora® waterproof and breathable membrane. Nylon and leather panels.

**FEATURES:** Reflective piping. Touchscreen compatible



Size	Black	Black/ Hi-Vis	Gun/Black
<b>XPLORE</b>			
6 XXS	476-2060XXS	476-2065XXS	476-2063XXS
7 XS	476-2060XS	476-2065XS	476-2063XS
8 S	476-2060S	476-2065S	476-2063S
9 M	476-2060M	476-2065M	476-2063M
10 L	476-2060L	476-2065L	476-2063L
11 X	476-2060X	476-2065X	476-2063X
12 2X	476-20602X	476-20652X	476-20632X
13 3X	476-20603X	476-20653X	476-20633X



Touch screen compatible

## AURORA II GLOVE

**MATERIALS:** Fully insulated 115g Thinsulate™ cold weather glove. 20g Thinsulate™ in palm for easier use of your controls. Hipora® waterproof, windproof, breathable membrane keeps you dry and warm all day. High grade genuine leather palm and finger tips for years of durability. Additional leather strip between thumb and index finger provides reinforcement in high use-area of glove

**FEATURES:** Touch screen compatible. Extended neoprene cuff eliminates open exposed area between gloves and jacket. Cinch cord cuff may be tightened around jacket sleeve for additional protection from the elements. Wrist strap offers additional adjustment to ensure a custom fit. Reflective safety piping offers added visibility in all riding conditions



Size	WPS#
<b>AURORA II</b>	
8 S	363-3891S
9 M	363-3891M
10 L	363-3891L
11 XL	363-3891X
12 2X	363-38912X
13 3X	363-38913X



Touch screen compatible





### IGNITOR PRO GLOVE

**MATERIALS:** Full Leather Palm & Fingers. 3M 80g Thinsulate Insulation. 20g Thinsulate in palm for easier use of your controls. Hipora® Liner waterproof, windproof, and breathable. Silicone Print on Palm for Increased Grip. Integrated Hard Knuckle Armor.

**FEATURES:** Reflective Logos and Print for Improved Visibility. Cuff Pull Tab to assist in pulling on. Touch screen compatible. Stainless Core heating technology provides superior life, even heating and extreme durability. Pre-curved fingers for added comfort. Adjustable wrist strap. 2 Lithium ion batteries and controller with 3 heat settings. Gauntlet adjuster. LED indicating activation and heat status. 110 volt wall charger with dual charging ports. Storage bag included

Size	WPS#
<b>IGNITOR PRO</b>	
8 S	476-2920S
9 M	476-2920M
10 L	476-2920L
11 XL	476-2920X
12 2XL	476-29202X
13 3XL	476-29203X
<b>REPLACEMENT PARTS</b>	
Ignitor Pro Battery w/out heat control (ea)	476-29005
Wall charger	476-29002



### IGNITOR BATTERY HEATED GLOVE

**MATERIALS:** Full Leather Palm & Fingers. 200g 3M Thinsulate, 20g Thinsulate in palm. Hipora® Liner waterproof, windproof, and breathable.

**FEATURES:** Touch screen compatible. Stainless Core heating technology provides superior life, even heating and extreme durability. Pre-curved fingers for added comfort. Adjustable wrist strap. 2 Lithium ion battery and controller with 3 heat settings. Gauntlet adjuster. LED indicating activation and heat status. 110 volt wall charger with dual charging ports. Storage bag included

Size	WPS#
<b>IGNITOR II</b>	
7 XS	476-2910XS
8 S	476-2910S
9 M	476-2910M
10 L	476-2910L
11 XL	476-2910X
12 2XL	476-29102X
12 3XL	476-29103X
<b>REPLACEMENT PARTS</b>	
Ignitor Battery w/out heat control (ea) (for Ignitor II and Ignitor Pro)	476-29005
Ignitor Battery w/heat control (for original Ignitor)	476-29001
Wall charger	476-29002

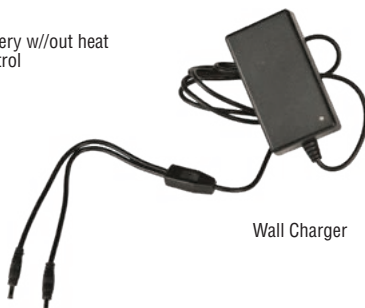

- WINDSHIELDS / FAIRINGS
- AUDIO / COMMUNICATION
- SEATS / LUGGAGE
- BARS / MIRRORS / CONTROLS
- EXHAUST
- AIR / FUEL SYSTEMS
- ENGINE
- TRANSMISSION / DRIVELINE
- GASKETS / SEALS
- ELECTRICAL
- LIGHTING
- CABLES
- BRAKES
- OIL FILTERS
- SUSPENSION
- BODY
- WHEELS
- TIRES / TIRE ACC.
- BIKE ACC.
- VICTORY / INDIAN
- COVERS / LOCKS / TIEDOWNS
- CHEMICALS
- TOOLS
- HELMETS
- HELMET ACC.
- EYEWEAR
- APPAREL / RIDER ACC.
- PROMOTIONAL
- REFERENCE
- INDEX

- WINDSHIELDS / FAIRINGS
- AUDIO / COMMUNICATION
- SEATS / LUGGAGE
- BARS / MIRRORS / CONTROLS
- EXHAUST
- AIR / FUEL SYSTEMS
- ENGINE
- TRANSMISSION / DRIVELINE
- GASKETS / SEALS
- ELECTRICAL
- LIGHTING
- CABLES
- BRAKES
- OIL FILTERS
- SUSPENSION
- BODY
- WHEELS
- TIRES / TIRE ACC.
- BIKE ACC.
- VICTORY / INDIAN
- COVERS / LOCKS / TIEDOWNS
- CHEMICALS
- TOOLS
- HELMETS
- HELMET ACC.
- EYEWEAR
- APPAREL / RIDER ACC.
- PROMOTIONAL
- REFERENCE
- INDEX



## GLOVE RAIN COVER

**MATERIALS:** 99% Polyester and 1% PVC.

**FEATURES:** Keeps your hands and gloves dry. Helps block the wind. Silicone grip area helps to hold the bars in rainy conditions. Cinch cord seals cover to jacket to keep the elements out. Reflective logo



Size	WPS#
S 7-8	477-0020S
M 8-9	477-0020M
L 10-11	477-0020L
XL 12-13	477-0020X

## BOOT RAIN COVER

**MATERIALS:** Heavy duty waterproof nylon keeps your boots and lower leg dry. 68% Polyester. 30% Rubber. 1% Plastic. 1% Velcro.

**FEATURES:** Helps block the wind. Half sole design allows your shoes heel to grip the peg in rainy conditions. Reflective areas to add visibility. Velcro back allows covers to be put on quickly.



Size	WPS#
S 7-8	477-0021S
M 9-10	477-0021M
L 11-12	477-0021L
XL 13-14	477-0021X





### SGS MKII GLOVES



Premium leather short cuff sport gloves with carbon fiber hard knuckles.

- Top quality goat leather
- Carbon fiber reinforced TPU knuckle protector
- Knox SPS® palm sliders
- Hard TPU finger protectors
- Protective padded Pisiform protector
- Velcro wrist strap closure
- Digital embossed palm grip reinforcement
- Perforated leather back of hand
- Pre-curved palm and fingers
- Touch screen compatible index finger

Size	Black	Red	White
S	75-5710S	75-5711S	75-5712S
M	75-5710M	75-5711M	75-5712M
L	75-5710L	75-5711L	75-5712L
X	75-5710X	75-5711X	75-5712X
2X	75-57102X	75-57112X	75-57122X
3X	75-57103X	75-57113X	75-57123X



### SGS MKII GLOVES



Premium leather short cuff sport gloves for women with carbon fiber hard knuckles.

- Top quality goat leather
- Carbon fiber reinforced TPU knuckle protector
- Knox SPS® palm sliders
- Hard TPU finger protectors
- Protective padded Pisiform protector
- Velcro wrist strap closure
- Digital embossed palm grip reinforcement
- Perforated leather back of hand
- Pre-curved palm and fingers
- Touch screen compatible index finger

Size	Black	White
XS	75-5720XS	75-5721XS
S	75-5720S	75-5721S
M	75-5720M	75-5721M
L	75-5720L	75-5721L
X	75-5720X	75-5721X



- WINDSHIELDS / FAIRINGS
- AUDIO / COMMUNICATION
- SEATS / LUGGAGE
- BARS / MIRRORS / CONTROLS
- EXHAUST
- AIR / FUEL SYSTEMS
- ENGINE
- TRANSMISSION / DRIVELINE
- GASKETS / SEALS
- ELECTRICAL
- LIGHTING
- CABLES
- BRAKES
- OIL FILTERS
- SUSPENSION
- BODY
- WHEELS
- TIRES / TIRE ACC.
- BIKE ACC.
- VICTORY / INDIAN
- COVERS / LOCKS / TIEDOWNS
- CHEMICALS
- TOOLS
- HELMETS
- HELMET ACC.
- EYEWEAR
- APPAREL / RIDER ACC.
- PROMOTIONAL
- REFERENCE
- INDEX



## HAVOC GLOVES



Long gauntlet sport leather / mesh glove

- Top grain goatskin leather palm and fingers
- Synthetic leather reinforcement on palms for extra grip and protection.
- Durable breathable mesh on back of hand and between fingers
- Hard TPU knuckle protector on hinged panel for extra mobility
- TPR finger protectors and padded areas on palm and wrist for additional protection
- Pre-curved ergonomic fit
- TPU and hook and loop fastener wrist closure system
- Kwik Touch™ touch screen capable



Size	Black
S	75-5730S
M	75-5730M
L	75-5730L
X	75-5730X
2X	75-57302X
3X	75-57303X

## TALON GLOVES



Short cuff sport leather / mesh glove

- Top grain goatskin leather palm and fingers
- Synthetic leather reinforcement on palms for extra grip and protection.
- Durable breathable mesh on back of hand and between fingers
- Hard TPU knuckle protector on hinged panel for extra mobility
- TPR finger protectors and padded areas on palm and wrist for additional protection
- Pre-curved ergonomic fit
- TPU and hook and loop fastener wrist closure system
- Kwik Touch™ touch screen capable



Size	Black
S	75-5735S
M	75-5735M
L	75-5735L
X	75-5735X
2X	75-57352X
3X	75-57353X

WINDSHIELDS / FAIRINGS  
AUDIO / COMMUNICATION  
SEATS / LUGGAGE  
BARS / MIRRORS / CONTROLS  
EXHAUST  
AIR / FUEL SYSTEMS  
ENGINE  
TRANSMISSION / DRIVELINE  
GASKETS / SEALS  
ELECTRICAL  
LIGHTING  
CABLES  
BRAKES  
OIL FILTERS  
SUSPENSION  
BODY  
WHEELS  
TIRES / TIRE ACC.  
BIKE ACC.  
VICTORY / INDIAN  
COVERS / LOCKS / TIEDOWNS  
CHEMICALS  
TOOLS  
HELMETS  
HELMET ACC.  
EYEWEAR  
APPAREL / RIDER ACC.  
PROMOTIONAL  
REFERENCE  
INDEX



## KLAW 11 GLOVES



Short cuff leather riding glove

- Durable, goatskin leather construction
- TPU molded knuckle protection
- Pre-curved palm and fingers for grip comfort
- TPR molded finger protectors
- Rib-stretch knuckle expansion panels provide flexibility
- Neoprene wrist relief panel
- Hook and loop wrist closure



Size	Black	White
S	75-5740S	75-5741S
M	75-5740M	75-5741M
L	75-5740L	75-5741L
X	75-5740X	75-5741X
2X	75-57402X	75-57412X
3X	75-57403X	75-57413X



## BIXBY GLOVES



Short cuff leather modern cafe/cruiser glove

- Top grain goatskin leather
- Padded back of hand, and palm
- Leather overlay panel on grip area, palm and along pinky
- Accordion stretch panels at wrist and fingers
- Stretch elastic / hook and loop closure at wrist
- Reinforced and padded palm
- Pre-curved ergonomic fit
- Kwik Touch™ touch screen capable

Size	Black	Brown
S	75-5745S	75-5746S
M	75-5745M	75-5746M
L	75-5745L	75-5746L
X	75-5745X	75-5746X
2X	75-57452X	75-57462X
3X	75-57453X	75-57463X



- WINDSHIELDS / FAIRINGS
- AUDIO / COMMUNICATION
- SEATS / LUGGAGE
- BARS / MIRRORS / CONTROLS
- EXHAUST
- AIR / FUEL SYSTEMS
- ENGINE
- TRANSMISSION / DRIVELINE
- GASKETS / SEALS
- ELECTRICAL
- LIGHTING
- CABLES
- BRAKES
- OIL FILTERS
- SUSPENSION
- BODY
- WHEELS
- TIRES / TIRE ACC.
- BIKE ACC.
- VICTORY / INDIAN
- COVERS / LOCKS / TIEDOWNS
- CHEMICALS
- TOOLS
- HELMETS
- HELMET ACC.
- EYEWEAR
- APPAREL / RIDER ACC.
- PROMOTIONAL
- REFERENCE
- INDEX



## COOLHAND II GLOVES **NEW**

Short cuff leather palm ventilated glove

- Durable, leather palm with Nash® overlay panels
- Ventilated, nylon mesh top maximizes airflow
- Pre-curved palm and fingers for grip comfort
- Molded, padded knuckle protector
- Creora® inner finger panels offer flexibility and comfort
- Rib-stretch finger expansion panels for flexibility
- TPR molded wrist closure provides a secure fit
- NightViz® reflective piping for added night time visibility

Size	Black	Silver	Neon
S	75-5750S	75-5751S	75-5752S
M	75-5750M	75-5751M	75-5752M
L	75-5750L	75-5751L	75-5752L
X	75-5750X	75-5751X	75-5752X
2X	75-57502X	75-57512X	75-57522X
3X	75-57503X	75-57513X	75-57523X



## COOLHAND II WOMEN'S GLOVES **NEW**

Women's short cuff leather palm ventilated glove

- Durable, leather palm with Nash® overlay panels
- Ventilated, nylon mesh top maximizes airflow
- Pre-curved palm and fingers for grip comfort
- Molded, padded knuckle protector
- Creora® inner finger panels offer flexibility and comfort
- Rib-stretch finger expansion panels for flexibility
- TPR molded wrist closure provides a secure fit
- NightViz® reflective piping for added night time visibility

Size	Black	Pink	Neon	Purple
XS	75-5780XS	75-5781XS	75-5782XS	75-5783XS
S	75-5780S	75-5781S	75-5782S	75-5783S
M	75-5780M	75-5781M	75-5782M	75-5783M
L	75-5780L	75-5781L	75-5782L	75-5783L
X	75-5780X	75-5781X	75-5782X	75-5783X





## SKRUB GLOVES



Short cuff synthetic palm ventilated glove

- TPR molded protectors
- Creora® inner finger panels offer flexibility and comfort
- Neoprene® stretch panels
- Nash® palm material
- Padded palm panels
- Two-way stretch back panel
- Nash® thumb guard
- TPR molded wrist closure



Size	Black	Red
S	75-5755S	75-5756S
M	75-5755M	75-5756M
L	75-5755L	75-5756L
X	75-5755X	75-5756X
2X	75-57552X	75-57562X
3X	75-57553X	75-57563X



## SKRUB WOMENS GLOVES



Women's short cuff synthetic palm ventilated glove

- TPR molded protectors
- Creora® inner finger panels offer flexibility and comfort
- Neoprene® stretch panels
- Nash® palm material
- Padded palm panels
- Two-way stretch back panel
- Nash® thumb guard
- TPR molded wrist closure



Size	Black	Pink	Purple
XS	75-5785XS	75-5786XS	75-5787XS
S	75-5785S	75-5786S	75-5787S
M	75-5785M	75-5786M	75-5787M
L	75-5785L	75-5786L	75-5787L
X	75-5785X	75-5786X	75-5787X

- WINDSHIELDS / FAIRINGS
- AUDIO / COMMUNICATION
- SEATS / LUGGAGE
- BAR / MIRRORS / CONTROLS
- EXHAUST
- AIR / FUEL SYSTEMS
- ENGINE
- TRANSMISSION / DRIVELINE
- GASKETS / SEALS
- ELECTRICAL
- LIGHTING
- CABLES
- BRAKES
- OIL FILTERS
- SUSPENSION
- BODY
- WHEELS
- TIRES / TIRE ACC.
- BIKE ACC.
- VICTORY / INDIAN
- COVERS / LOCKS / TIEDOWNS
- CHEMICALS
- TOOLS
- HELMETS
- HELMET ACC.
- EYEWEAR
- APPAREL / RIDER ACC.
- PROMOTIONAL
- REFERENCE
- INDEX



## TEMPEST CW GLOVES



100% waterproof insulated double gauntlet glove

- Unique double gauntlet with dual drain holes
- Waterproof Hypora® lining
- 100g Thinsulate insulation inside the waterproof liner
- Palm does not have insulation to allow heated grips to be felt
- Reinforced areas on gripping area with silicone gripping areas
- 4 way stretch materials on back of hand for excellent fit & comfort
- Goat leather palm
- Fully bonded palm for secure grip
- Dual wrist closures
- Hard knuckle protectors
- Dual visor squeegee
- Reflective piping



Size	Black
S	75-5775S
M	75-5775M
L	75-5775L
X	75-5775X
2X	75-57752X
3X	75-57753X

## FULL CUT GLOVES



Long cuff leather cruiser glove

- Soft and durable, perforated leather construction
- Reinforced leather palm with shock and vibration reducing padding
- Throttle-guard leather panel between thumb and index finger
- Breathable, stretch Lycra® fourchettes and pre-curved palm and fingers for grip comfort
- Storage snaps keep the pair together when not in use



Size	Black
S	75-5760S
M	75-5760M
L	75-5760L
X	75-5760X
2X	75-57602X
3X	75-57603X

WINDSHIELDS / FAIRINGS  
 AUDIO / COMMUNICATION  
 SEATS / LUGGAGE  
 BARS / MIRRORS / CONTROLS  
 EXHAUST  
 AIR / FUEL SYSTEMS  
 ENGINE  
 TRANSMISSION / DRIVELINE  
 GASKETS / SEALS  
 ELECTRICAL  
 LIGHTING  
 CABLES  
 BRAKES  
 OIL FILTERS  
 SUSPENSION  
 BODY  
 WHEELS  
 TIRES / TIRE ACC.  
 BIKE ACC.  
 VICTORY / INDIAN  
 COVERS / LOCKS / TIEDOWNS  
 CHEMICALS  
 TOOLS  
 HELMETS  
 HELMET ACC.  
 EYEWEAR  
**APPAREL / RIDER ACC.**  
 PROMOTIONAL  
 REFERENCE  
 INDEX





**SHORT CUT GLOVES** **NEW**



Short cuff leather cruiser glove

- Soft and durable, perforated leather construction
- Reinforced leather palm with shock and vibration reducing padding
- Throttle-guard leather panel between thumb and index finger
- Breathable, stretch Lycra® fourchettes and pre-curved palm and fingers for grip comfort

Size	Black
S	75-5765S
M	75-5765M
L	75-5765L
X	75-5765X
2X	75-57652X
3X	75-57653X



**HALF CUT GLOVES** **NEW**



Open finger leather cruiser gloves

- Soft and durable, perforated leather construction
- Reinforced leather palm with shock and vibration reducing padding
- Extended palm pull-tabs allow for easy removal
- Leather cuff with a secure hook and loop wrist closure
- Storage snaps keep the pair together when not in use

Size	Black
S	75-5770S
M	75-5770M
L	75-5770L
X	75-5770X
2X	75-57702X
3X	75-57703X



WINDSHIELDS / FAIRINGS  
 AUDIO / COMMUNICATION  
 SEATS / LUGGAGE  
 BARS / MIRRORS / CONTROLS  
 EXHAUST  
 AIR / FUEL SYSTEMS  
 ENGINE  
 TRANSMISSION / DRIVELINE  
 GASKETS / SEALS  
 ELECTRICAL  
 LIGHTING  
 CABLES  
 BRAKES  
 OIL FILTERS  
 SUSPENSION  
 BODY  
 WHEELS  
 TIRES / TIRE ACC.  
 BIKE ACC.  
 VICTORY / INDIAN  
 COVERS / LOCKS / TIEDOWNS  
 CHEMICALS  
 TOOLS  
 HELMETS  
 HELMET ACC.  
 EYEWEAR  
**APPAREL / RIDER ACC.**  
 PROMOTIONAL  
 REFERENCE  
 INDEX



## 12V ALL LEATHER GLOVES

Many riders ask for heated motorcycle gloves that can extend its warming capabilities beyond the bike. Designed from the ground up, the Hybrid Heated Motorcycle Gloves can stay powered by a wired connection to the vehicle's battery, or by an optional rechargeable power pack.

With the optional 12 volt battery, feel free to explore the great outdoors, stroll through town, or even catch a ball game without the fear of cold hands.

With it's built-in temperature controller, yours hands can stay warm with its 3 heat settings. Plus, the leather material is a natural insulator that helps retain the heated glove's warmth.

Designed as one of the most comfortable heating gloves for

riding, the Hybrid Heated Motorcycle Gloves are guaranteed to provide maximum comfort. Each pair is made with premium Nappa leather that is soft to touch, but offers much needed durable and weather protection.

Both the palm and fingers have reinforced leather to prevent wear-and-tear. The sleek, flexible design contours to your natural riding position.

Size	Black
XS	472-4063XS
S	472-4063S
M	472-4063M
L	472-4063L
XL	472-4063X
2X	472-40632X



## 12V HEATED GLOVE LINERS

Every rider is unique. Some look for a supplement heat source in addition to their favorite motorcycle gloves, while others simply need a thinner glove with heating capabilities. The 12V Heated Glove Liners allow each rider to enjoy their own motorcycle glove without the sacrifice of heat performance. The heated glove liner's thin material contours to the hand, which allows the heated glove liner to comfortably fit under the rider's outer motorcycle glove.

If two glove layers is too much, feel free to wear the heated glove liners on their own and still enjoy top-quality warmth.

- Touchscreen friendly! Keep the glove liner on and navigate through any smartphone, tablet, or GPS system
- Built in temperature controller! At the push of a button, manage the heat setting at ease. Choose from hot, medium, or low

The thermal protection circuit located in the heated glove liner and the fuse kit provides dual protection from overheating. Riders are safe to use them in rain or shine.

- Made to comfortably fit under any motorcycle glove

Size	Black
XS/S	472-4056XS
M/L	472-4056M
X/2X	472-4056X





## 12V HEATED GRAND TOURING GLOVES



VentureHeat's 12V Heated Grand Touring Motorcycle Gloves are all-around great motorcycle gloves. Constructed with premium leather and a waterproof membrane, they are sure to keep your hands protected while you are out on your ride.

Turn on the heat with the touch of the button and enjoy comforting warmth throughout your hands to combat cold temperatures and harsh winds.

As an added bonus, these heated motorcycle gloves also have touchscreen fingertips so that you can pull over and use your cell phone without even taking your gloves off. Make your next ride more comfortable with a pair of 12V Heated Grand Touring Gloves from VentureHeat

- Premium Leather
- Digital Temp Controller
- Waterproof Membrane
- Touch Screen Compatible

**Size WPS#**

S	472-4062S
M	472-4062M
L	472-4062L
XL	472-4062X
2XL	472-40622X
3XL	472-40623X

## BX-125 12v HEATED GLOVES



- Dare to ride free this winter with the BX-125 12V Heated Leather Gloves
- Outfitted with only the best heavy duty materials and a premium heating element, it effectively protects you from the chilly winter air for years of service
- It offers better handle bar grip for your safety as you ride. Defy nature, Get out and ride with a pair of BX-125 12V Heated Gloves

**Unlimited Continuous Heat**

- Designed to be plugged into a 12v DC power source, warmth and comfort go with you wherever the road leads

**Protects Your Hands from Impact**

- Waterproof, breathable liner with nylon shell that is reinforced with leather throughout the palm and knuckles area, the gloves offer protection from wind, weather and impact

**Easy to Operate Built-in Temperature Controller**

- Create your very own micro climate ideal for your needs with the 3 setting temperature controller. Press and hold for 3 seconds to turn on and off, and then just press button to change setting. Easy to see LED light shows you the setting

**Size Black**

S	472-4064S
M	472-4064M
L	472-4064L
X	472-4064X
2X	472-40642X
3X	472-40643X

- WINDSHIELDS / FAIRINGS
- AUDIO / COMMUNICATION
- SEATS / LUGGAGE
- BARS / MIRRORS / CONTROLS
- EXHAUST
- AIR / FUEL SYSTEMS
- ENGINE
- TRANSMISSION / DRIVELINE
- GASKETS / SEALS
- ELECTRICAL
- LIGHTING
- CABLES
- BRAKES
- OIL FILTERS
- SUSPENSION
- BODY
- WHEELS
- TIRES / TIRE ACC.
- BIKE ACC.
- VICTORY / INDIAN
- COVERS / LOCKS / TIEDOWNS
- CHEMICALS
- TOOLS
- HELMETS
- HELMET ACC.
- EYEWEAR
- APPAREL / RIDER ACC.
- PROMOTIONAL
- REFERENCE
- INDEX



### GLOVES w/LED FINGERS

- Knit gloves have multi-color LED's in the fingertips
- 6 different color modes create an amazing light show
- 1 size fits most



WPS#
12-6780
12-6780D



### JACKET VENT

Ventz is a clever product that attaches easily to your jacket and helps to cool you down.

USA Design Registered, Patented, Proven, Shatter Proof, Insect Proof

When riding in warm weather an invisible layer of hot air, trapped in your jacket, raises your core body temperature to uncomfortable levels, which can cause a dangerous loss of concentration. Ventz creates a flow of soothing air that removes the trapped heat, making your journey cooler and more comfortable. Safe and comfortable to wear, Ventz is effective for both the rider and passenger.



Color	WPS#
Black	271-1000BK



### V-Twin Skin<sup>®</sup> By Ryder Clips<sup>®</sup>

- Protect your boots from shifter damage
- Custom made with durable leather
- 26-7211 Fits all shifters from 1"-1½" wide to 2½"-3" long (Harley Davidson, Yamaha and others)
- The V-Twin Skin Display Rack with header card fits up to twelve products, contact your WPS sales rep. for details.



Description	WPS #
1"-1½" wide x 2½"-3" long	26-7211

**PRIMARY ENGINEER BOOT**

**MATERIAL:** 100% top quality full grain leather. Water-resistant oiled leather.

**PROTECTION:** Goodyear® welt construction for durability (can be re-soled).

**FEATURES:** HiPora® waterproof lining throughout. Removable insole. Full length cushioned sock lining. Pull loop for easy-on wearability. 2 year manufacturer's warranty



Size	WPS#
<b>PRIMARY ENGINEER BOOT</b>	
7	361-80107
8	361-80108
9	361-80109
10	361-80110
11	361-80111
12	361-80112
13	361-80113
14	361-80114

Size	WPS#
<b>PRIMARY ENGINEER BOOT LOW</b>	
7	361-80207
8	361-80208
9	361-80209
10	361-80210
11	361-80211
12	361-80212
13	361-80213
14	361-80214

- WINDSHIELDS / FAIRINGS
- AUDIO / COMMUNICATION
- SEATS / LUGGAGE
- BARS / MIRRORS / CONTROLS
- EXHAUST
- AIR / FUEL SYSTEMS
- ENGINE
- TRANSMISSION / DRIVELINE
- GASKETS / SEALS
- ELECTRICAL
- LIGHTING
- CABLES
- BRAKES
- OIL FILTERS
- SUSPENSION
- BODY
- WHEELS
- TIRES / TIRE ACC.
- BIKE ACC.
- VICTORY / INDIAN
- COVERS / LOCKS / TIEDOWNS
- CHEMICALS
- TOOLS
- HELMETS
- HELMET ACC.
- EYEWEAR
- APPAREL / RIDER ACC.**
- PROMOTIONAL
- REFERENCE
- INDEX



### RPM BOOT

**MATERIAL:** 100% top quality full grain leather. Water-resistant oiled leather.

**PROTECTION:** Goodyear® welt construction for durability (can be re-soled).

**FEATURES:** Oil-resistant, anti-slip rubber sole. HiPora® waterproof lining throughout. Removable insole. Full length cushioned sock lining. Pull loop for easy-on wearability. 2 year manufacturer's warranty



Size WPS#

RPM BOOT	
7	361-80507
8	361-80508
9	361-80509
10	361-80510
11	361-80511
12	361-80512
13	361-80513
14	361-80514
15	361-80515

### SPARK BOOT

**MATERIAL:** 100% top quality full grain leather. Water-resistant oiled leather.

**PROTECTION:** Goodyear® welt construction for durability (can be re-soled).

**FEATURES:** Oil-resistant, anti-slip rubber sole. HiPora® waterproof lining throughout. Removable insole. Full length cushioned sock lining. Pull loop for easy-on wearability. 2 year manufacturer's warranty



Size WPS#

SPARK LOW	
7	361-80407
8	361-80408
9	361-80409
10	361-80410
11	361-80411
12	361-80412
13	361-80413
14	361-80414

Size WPS#

SPARK	
7	361-80307
8	361-80308
9	361-80309
10	361-80310
11	361-80311
12	361-80312
13	361-80313
14	361-80314



- WINDSHIELDS / FAIRINGS
- AUDIO / COMMUNICATION
- SEATS / LUGGAGE
- BAR / MIRRORS / CONTROLS
- EXHAUST
- AIR / FUEL SYSTEMS
- ENGINE
- TRANSMISSION / DRIVELINE
- GASKETS / SEALS
- ELECTRICAL
- LIGHTING
- CABLES
- BRAKES
- OIL FILTERS
- SUSPENSION
- BODY
- WHEELS
- TIRES / TIRE ACC.
- BIKE ACC.
- VICTORY / INDIAN
- COVERS / LOCKS / TIEDOWNS
- CHEMICALS
- TOOLS
- HELMETS
- HELMET ACC.
- EYEWEAR
- APPAREL / RIDER ACC.
- PROMOTIONAL
- REFERENCE
- INDEX

**NEW** JOURNEYMAN BOOT



- **MATERIAL:** Genuine Full Grain Leather. 100% Waterproof Sympatex® liner
- **PROTECTION:** Poron® XRD® flexible impact protection in ankles. Reinforced toe and heel for added strength.
- **FEATURES:** Oil Resistant non slip Vibram® outsole- slip resistant, durable, and shock absorbing. Aerated insole for maximum breathability.

Size	Black
6	361-80606
7	361-80607
8	361-80608
9	361-80609
10	361-80610
11	361-80611
12	361-80612
13	361-80613
14	361-80614



- WINDSHIELDS / FAIRINGS
- AUDIO / COMMUNICATION
- SEATS / LUGGAGE
- BAR / MIRRORS / CONTROLS
- EXHAUST
- AIR / FUEL SYSTEMS
- ENGINE
- TRANSMISSION / DRIVELINE
- GASKETS / SEALS
- ELECTRICAL
- LIGHTING
- CABLES
- BRAKES
- OIL FILTERS
- SUSPENSION
- BODY
- WHEELS
- TIRES / TIRE ACC.
- BIKE ACC.
- VICTORY / INDIAN
- COVERS / LOCKS / TIEDOWNS
- CHEMICALS
- TOOLS
- HELMETS
- HELMET ACC.
- EYEWEAR
- APPAREL / RIDER ACC.**
- PROMOTIONAL
- REFERENCE
- INDEX

- WINDSHIELDS / FAIRINGS
- AUDIO / COMMUNICATION
- SEATS / LUGGAGE
- BARS / MIRRORS / CONTROLS
- EXHAUST
- AIR / FUEL SYSTEMS
- ENGINE
- TRANSMISSION / DRIVELINE
- GASKETS / SEALS
- ELECTRICAL
- LIGHTING
- CABLES
- BRAKES
- OIL FILTERS
- SUSPENSION
- BODY
- WHEELS
- TIRES / TIRE ACC.
- BIKE ACC.
- VICTORY / INDIAN
- COVERS / LOCKS / TIEDOWNS
- CHEMICALS
- TOOLS
- HELMETS
- HELMET ACC.
- EYEWEAR
- APPAREL / RIDER ACC.
- PROMOTIONAL
- REFERENCE
- INDEX



**TRADESMAN BOOT** NEW

**MATERIAL:** Genuine Full Grain Leather. 100% Waterproof Sympatex® liner

**PROTECTION:** Reinforced toe and heel for added strength. Ankle armor for added protection.

**FEATURES:** Oil Resistant non slip outsole. Aerated insole for maximum breathability.



Size	Brown
6	361-10006
7	361-10007
8	361-10008
9	361-10009
10	361-10010
11	361-10011
12	361-10012
13	361-10013
14	361-10014





M16 RIDING SHOES



**CANVAS SHOE**

**MATERIAL:** Ballistic textile upper

**PROTECTION:** Crush resistant sole.

Composite shank isolates your foot from engine vibrations. Dual density ankle protectors on lateral and medial sides.

Toe and heel box are reinforced to give strategic support and impact performance

**FEATURES:** Metal eyelet lace closure system for durable and adaptable fit. Removable, replaceable comfort insoles.

Size	Grey/Black Textile
8	361-98908
9	361-98909
10	361-98910
11	361-98911
12	361-98912
13	361-98913



**WATERPROOF SHOE**

**MATERIAL:** Top grain leather upper.

Waterproof membrane lining ensures feet remain dry in wet conditions.

**PROTECTION:** Crush resistant sole.

Composite shank isolates your foot from engine vibrations. Dual density ankle protectors on lateral and medial sides.

Toe and heel box are reinforced to give strategic support and impact performance

**FEATURES:** Metal eyelet lace closure system for durable and adaptable fit. Removable, replaceable comfort insoles.

Size	Black Waterproof
8	361-98808
9	361-98809
10	361-98810
11	361-98811
12	361-98812
13	361-98813

- WINDSHIELDS / FAIRINGS
- AUDIO / COMMUNICATION
- SEATS / LUGGAGE
- BARS / MIRRORS / CONTROLS
- EXHAUST
- AIR / FUEL SYSTEMS
- ENGINE
- TRANSMISSION / DRIVELINE
- GASKETS / SEALS
- ELECTRICAL
- LIGHTING
- CABLES
- BRAKES
- OIL FILTERS
- SUSPENSION
- BODY
- WHEELS
- TIRES / TIRE ACC.
- BIKE ACC.
- VICTORY / INDIAN
- COVERS / LOCKS / TIEDOWNS
- CHEMICALS
- TOOLS
- HELMETS
- HELMET ACC.
- EYEWEAR
- APPAREL / RIDER ACC.
- PROMOTIONAL
- REFERENCE
- INDEX

- WINDSHIELDS / FAIRINGS
- AUDIO / COMMUNICATION
- SEATS / LUGGAGE
- BARS / MIRRORS / CONTROLS
- EXHAUST
- AIR / FUEL SYSTEMS
- ENGINE
- TRANSMISSION / DRIVELINE
- GASKETS / SEALS
- ELECTRICAL
- LIGHTING
- CABLES
- BRAKES
- OIL FILTERS
- SUSPENSION
- BODY
- WHEELS
- TIRES / TIRE ACC.
- BIKE ACC.
- VICTORY / INDIAN
- COVERS / LOCKS / TIEDOWNS
- CHEMICALS
- TOOLS
- HELMETS
- HELMET ACC.
- EYEWEAR
- APPAREL / RIDER ACC.
- PROMOTIONAL
- REFERENCE
- INDEX



## M21 SHOE

**MATERIAL:** Exterior leather upper for extra wear protection. Vented mesh side panel for increased air flow.

**PROTECTION:** Shifter wear protection. Protective ankle and heel reinforcement. Crush resistant composite shank.

**FEATURES:** Double stitched for increased durability. Street inspired sole for increased grip and traction. Velcro secured shoelace cover. Reflective areas for high visibility. Removable comfort insoles. Integrated pocket keeps the lace flap out of the way when tying the laces



Size	Black	Black/Hi-Vis
7	361-98607	361-98707
8	361-98608	361-98708
9	361-98609	361-98709
10	361-98610	361-98710
11	361-98611	361-98711
12	361-98612	361-98712
13	361-98613	361-98713



**PORTABLE BOOT DRYERS**

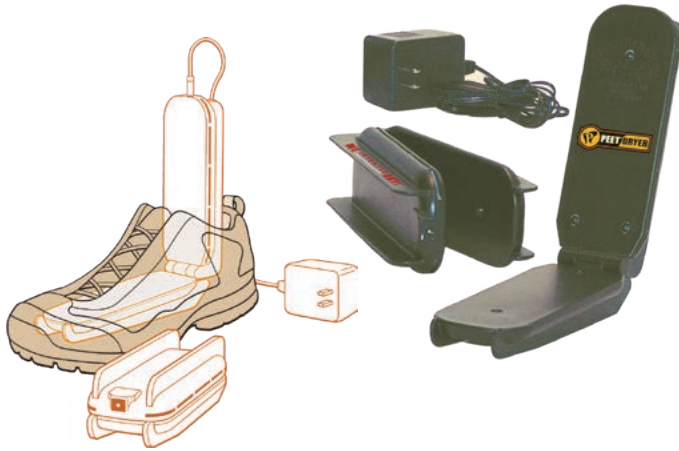

**PEET DRYER**

- Convenient small size for traveling
- UV Light Technology eliminates contaminants like bacteria, viruses, and mold.
- Comes with wall plug in and cigarette lighter plug in
- Temperature limiting heating elements will not overheat.
- Travel pouch included
- 2 year warranty

Description	WPS#
Portable Boot Dryer	56-1181



**ACCESSORIES**

**GLOVE DRY PORT ACCESSORY**

- Fits any two air chamber dryer
- Dries two gloves
- 2 year warranty

Description	WPS#
Glove Adaptor	56-1183



**HELMET DRY PORT ACCESSORY**

- Fits any two air chamber dryer
- Dries one helmet
- 2 year warranty

Description	WPS#
Helmet Adaptor	56-1184



**HYDRATION BAG DRYER**

- Easy one-step solution for drying hydration reservoirs
- Patented design produces warm airflow circulation that inhibits the growth of mold, mildew, and sickness causing bacteria
- Adjustable to fit most types of reservoirs
- Dry time approximately 2.5 hours

Description	WPS#
Hydration System Dryer	56-1186

WINDSHIELDS / FAIRINGS  
 AUDIO / COMMUNICATION  
 SEATS / LUGGAGE  
 BARS / MIRRORS / CONTROLS  
 EXHAUST  
 AIR / FUEL SYSTEMS  
 ENGINE  
 TRANSMISSION / DRIVELINE  
 GASKETS / SEALS  
 ELECTRICAL  
 LIGHTING  
 CABLES  
 BRAKES  
 OIL FILTERS  
 SUSPENSION  
 BODY  
 WHEELS  
 TIRES / TIRE ACC.  
 BIKE ACC.  
 VICTORY / INDIAN  
 COVERS / LOCKS / TIEDOWNS  
 CHEMICALS  
 TOOLS  
 HELMETS  
 HELMET ACC.  
 EYEWEAR  
**APPAREL / RIDER ACC.**  
 PROMOTIONAL  
 REFERENCE  
 INDEX

WINDSHIELDS / FAIRINGS  
 AUDIO / COMMUNICATION  
 SEATS / LUGGAGE  
 BARS / MIRRORS / CONTROLS  
 EXHAUST  
 AIR / FUEL SYSTEMS  
 ENGINE  
 TRANSMISSION / DRIVELINE  
 GASKETS / SEALS  
 ELECTRICAL  
 LIGHTING  
 CABLES  
 BRAKES  
 OIL FILTERS  
 SUSPENSION  
 BODY  
 WHEELS  
 TIRES / TIRE ACC.  
 BIKE ACC.  
 VICTORY / INDIAN  
 COVERS / LOCKS / TIEDOWNS  
 CHEMICALS  
 TOOLS  
 HELMETS  
 HELMET ACC.  
 EYEWEAR  
**APPAREL / RIDER ACC.**  
 PROMOTIONAL  
 REFERENCE  
 INDEX



## BOOT DRYERS

### ADVANTAGE DRYER

- Quiet fan assisted heat moves air to dry even faster
- Built-in Ionization Technology eliminates contaminants like bacteria, viruses, and mold.
- Dries with or without heat.
- Comes with four footwear dry ports to dry two pair of boots.
- Accepts helmet and glove dry ports.
- 2 year warranty.



Description	WPS#
Advantage Dryer	56-1180

### MULTI DRYER

- Quiet convection drying.
- Comes with four footwear dry ports to dry two pair of boots.
- Accepts helmet and glove dry ports.
- 25 year warranty.



Description	WPS#
Powersports Dryer	56-1182

### ORIGINAL DRYER

- Quiet convection drying.
- Temperature limiting heating elements will not overheat.
- Comes with two footwear dry ports to dry one pair of boots.
- Accepts helmet and glove dry ports.
- 25 year warranty.



Description	WPS#
Original Dryer	56-1185



A



B



C



D



E



F



G



H



A



B



C



D



E



F

## DELUXE BANDANNA

- Deluxe Bandanna features vibrant graphics
- Offers a variety of uses such as: headband, head wrap, sweatband, handkerchief, neck tie, face mask and much more
- Made of soft sublimated 100% polyester, the edges of the Deluxe Bandanna are sewn to prevent fraying
- 24" x 24"

	Description	WPS#
A	AMERICAN VINTAGE	26-5114
B	BLACK PAISLEY	26-5115
C	PINK AND PURPLE SKULL PAISLEY	26-5116
D	CLASSIC TIMES	26-5117
E	MOTHER ROAD	26-5118
F	MOTORCYCLE MONTAGE	26-5119
G	ZAN WORKSHOP	26-5120
H	FOREST CAMO	26-5121

## BANDANNAS

- Pre-washed 100% medium weight cotton
- Rolled and sewn edges
- 22" x 22", machine washable

	Description	WPS#
A	Paisley, Black	26-4029
B	Paisley, Navy	26-4030
C	Paisley, Red	26-4031
D	Woodland Camo	26-4046
E	USA Wavy	26-4045
F	Skull Row	26-4052

- WINDSHIELDS / FAIRINGS
- AUDIO / COMMUNICATION
- SEATS / LUGGAGE
- BARS / MIRRORS / CONTROLS
- EXHAUST
- AIR / FUEL SYSTEMS
- ENGINE
- TRANSMISSION / DRIVELINE
- GASKETS / SEALS
- ELECTRICAL
- LIGHTING
- CABLES
- BRAKES
- OIL FILTERS
- SUSPENSION
- BODY
- WHEELS
- TIRES / TIRE ACC.
- BIKE ACC.
- VICTORY / INDIAN
- COVERS / LOCKS / TIEDOWNS
- CHEMICALS
- TOOLS
- HELMETS
- HELMET ACC.
- EYEWEAR
- APPAREL / RIDER ACC.
- PROMOTIONAL
- REFERENCE
- INDEX



**FLYDANNA®**

- Six panel bandanna sewn into a headwrap
- Fits securely on the head using attached head ties
- 100% soft cotton



A



B



C



D



E



F



G



H

	Description	WPS#
A	Ride It Like you	26-4239
B	Woodland Camo	26-4247
C	Solid Black	26-4246
D	Mixed Butterfly	26-4249
E	Pink Ribbon, Black	26-4295
F	Pink Ribbon, Paisley	26-4298
G	Web Wrapped	26-4254
H	Reverse flames	26-4255

- WINDSHIELDS / FAIRINGS
- AUDIO / COMMUNICATION
- SEATS / LUGGAGE
- BARS / MIRRORS / CONTROLS
- EXHAUST
- AIR / FUEL SYSTEMS
- ENGINE
- TRANSMISSION / DRIVELINE
- GASKETS / SEALS
- ELECTRICAL
- LIGHTING
- CABLES
- BRAKES
- OIL FILTERS
- SUSPENSION
- BODY
- WHEELS
- TIRES / TIRE ACC.
- BIKE ACC.
- VICTORY / INDIAN
- COVERS / LOCKS / TIEDOWNS
- CHEMICALS
- TOOLS
- HELMETS
- HELMET ACC.
- EYEWEAR
- APPAREL / RIDER ACC.
- PROMOTIONAL
- REFERENCE
- INDEX



**FLYDANNA®**

- Six panel bandanna sewn into a headwrap
- Fits securely on the head using attached head ties
- 100% soft cotton

Description	WPS#
A Stars & Stripes 04	26-4208
B Wavy American Flag	26-4218
C Paisley Black	26-4200
D Paisley White	26-4315
E Paisley Red	26-4316
F Paisley Navy	26-4317
G Urban Camo	26-4214
H Lightning Blue	26-4215
I Tank Flame Black	26-4251
J Tank Flame Blue	26-4252
K Tank Flame Silver	26-4253

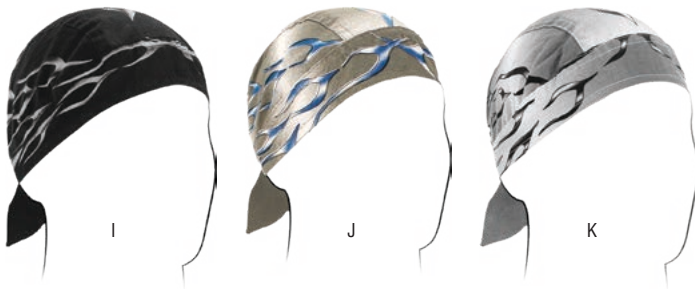

**ROADHOG FLYDANNA®**

- Heavy 7 oz. 100% cotton twill
- Larger than traditional head wraps
- Sewn-in cotton terry cloth sweatband

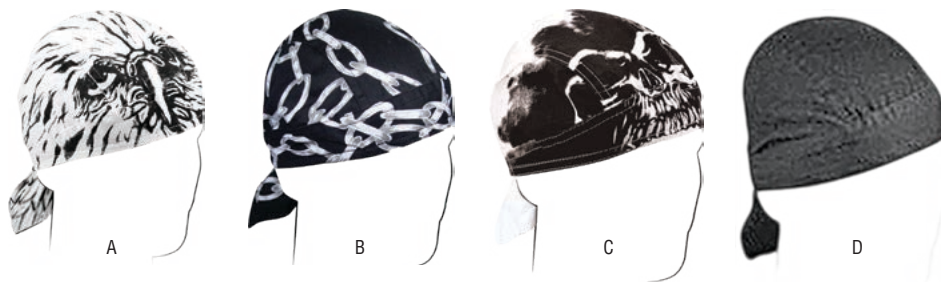

Description	WPS#
A Airbrushed Eagle	26-4459
B Chains	26-4456
C Airbrushed Skull	26-4457
D Black	26-4465

**FLYDANNA® DELUXE**

- Built in sweatband
- 7 oz. 100% cotton twill
- Longer and wider head ties and tail, than regular Flydannas®
- Larger than standard Flydanna®



Color	WPS#
Black	26-4304

WINDSHIELDS / FAIRINGS  
AUDIO / COMMUNICATION  
SEATS / LUGGAGE  
BARS / MIRRORS / CONTROLS  
EXHAUST  
AIR / FUEL SYSTEMS  
ENGINE  
TRANSMISSION / DRIVELINE  
GASKETS / SEALS  
ELECTRICAL  
LIGHTING  
CABLES  
BRAKES  
OIL FILTERS  
SUSPENSION  
BODY  
WHEELS  
TIRES / TIRE ACC.  
BIKE ACC.  
VICTORY / INDIAN  
COVERS / LOCKS / TIEDOWNS  
CHEMICALS  
TOOLS  
HELMETS  
HELMET ACC.  
EYEWEAR  
APPAREL / RIDER ACC.  
PROMOTIONAL  
REFERENCE  
INDEX



**FLYDANNA®**

- Six panel bandanna sewn into a headwrap
- Fits securely on the head using attached head ties
- 100% soft cotton



A



B



C



D



E



F



G



H



I



J



K



L



M

Flydanna® 24 pcs. display

Description	WPS#
A Skull Paisley Black	26-4261
B Skull Paisley Pink	26-4262
C Gray Barbed Wire	26-4263
D Pow/MIA III	26-4265
E Flamin Orange Pistons	26-4312
F American Flag	26-4310

Description	WPS#
G Coolmax Black	26-4266
H Ribbon Butterflies	26-4323
I Voodoo Child, Grey	26-4326
J Orange Tribal Skull	26-4327
K American Flag Black and White	26-4066
L American Flag Vintage	26-4067
M Flydanna, 24pc on Display	26-42000





A



B



C



D



E

## VENTED FLYDANNA®

- Absorbent cotton terry cloth liner/sweatband
- Cooler and lighter than regular head wraps

Description	WPS#
A Skull & Cross	26-4400
B Solid Black	26-4401
C Lightning Blue	26-4402
D Woodland Camo	26-4430
E Wavy US Flag	26-4432



A



B



C

## HEADBANDS

Description	WPS#
A V-Twin Wings	26-4633
B All Over Skull	26-4636
C Black	26-4637



A



B



C



D



E

## HELMET LINER

- Sleek and comfortable liner, available in nylon, coolmax and micro fleece
- One size fits all

### MicroLUX™

- Provides comfortable coverage of the head and ears
- Thin durable nylon fabric liner provides non-bulky protection from the elements
- Soft, breathable faux fur beard provides warmth of the nose and lower face
- Beard is detachable for those times you prefer to go without it
- Hand Washable, 1 Size fits most, Under Helmet, Moisture Wicking, Cold Weather

Description	WPS#
A Nylon Dome Black	26-4500
B Coolmax Black	26-4502
C Micro Fleece Black	26-4503
D Skull Cap w/ Comfort Band Black	26-5110
E Mesh Skull Cap w/ Comfort Band Black	26-5111

- WINDSHIELDS / FAIRINGS
- AUDIO / COMMUNICATION
- SEATS / LUGGAGE
- BARS / MIRRORS / CONTROLS
- EXHAUST
- AIR / FUEL SYSTEMS
- ENGINE
- TRANSMISSION / DRIVELINE
- GASKETS / SEALS
- ELECTRICAL
- LIGHTING
- CABLES
- BRAKES
- OIL FILTERS
- SUSPENSION
- BODY
- WHEELS
- TIRES / TIRE ACC.
- BIKE ACC.
- VICTORY / INDIAN
- COVERS / LOCKS / TIEDOWNS
- CHEMICALS
- TOOLS
- HELMETS
- HELMET ACC.
- EYEWEAR
- APPAREL / RIDER ACC.
- PROMOTIONAL
- REFERENCE
- INDEX



### FLYDANNA®

- Six panel bandanna sewn into a headwrap
- Fits securely on the head using attached head ties
- 100% soft cotton



Description	WPS#
A Flames Red	26-4360
B Patriotic Skull	26-4361
C PurplePaisley	26-4213
D Black and White Flame	26-5112
E Muerte	26-5113

### COOLDANNA®

- 100% cotton head or neck wrap
- Contains non-toxic water absorbent crystals
- Provides over 8 hours of cooling
- Reusable up to 100 times

Description	WPS#
A Wavy American Flag	26-4166
B Black	26-4160
C Paisley Red	26-4158
D Paisley Navy	26-4159
E Black Paisley	26-4157
F White Paisley	26-4179
G Pink Paisley	26-4174
H Woodland Camo	26-4172
I Flames	26-4170
J Black and White Flag	26-5212
K Houndstooth Olive	26-5213
L Lightning Wrench	26-5214
M 18pc on Display	26-41500





**SPORTFLEX™ SERIES**



- Innovative new fabrication for mid-weight protection

- Heavier than original Motley Tube® but lighter than fleece lined ones

- Soft comfortable material
- machine washable

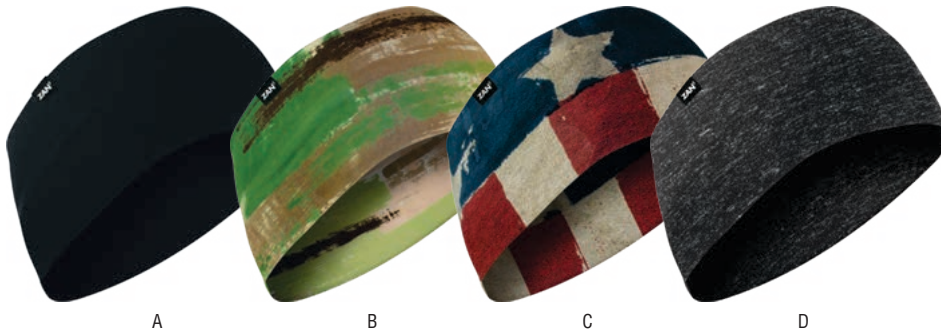

**HEADBAND**

Headband	WPS#
A Black	<b>26-5141</b>
B Multi Brushed Camo	<b>26-5142</b>
C Patriot	<b>26-5143</b>
D Charcoal Heather	<b>26-5144</b>

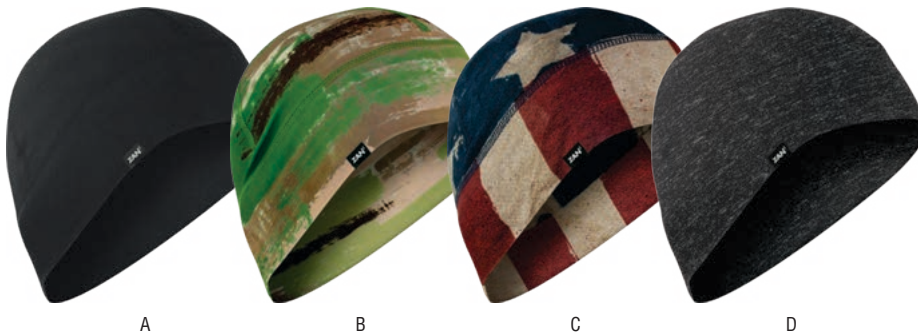

**BEANIE**

Beanie	WPS#
A Black	<b>26-5145</b>
B Multi Brushed Camo	<b>26-5146</b>
C Patriot	<b>26-5147</b>
D Charcoal Heather	<b>26-5148</b>



**MONTLEY TUBE**

Montley Tube	WPS#
A Black	<b>26-5149</b>
B Multi Brushed Camo	<b>26-5150</b>
C Patriot	<b>26-5151</b>
D Charcoal Heather	<b>26-5152</b>

- WINDSHIELDS / FAIRINGS
- AUDIO / COMMUNICATION
- SEATS / LUGGAGE
- BAR / MIRRORS / CONTROLS
- EXHAUST
- AIR / FUEL SYSTEMS
- ENGINE
- TRANSMISSION / DRIVELINE
- GASKETS / SEALS
- ELECTRICAL
- LIGHTING
- CABLES
- BRAKES
- OIL FILTERS
- SUSPENSION
- BODY
- WHEELS
- TIRES / TIRE ACC.
- BIKE ACC.
- VICTORY / INDIAN
- COVERS / LOCKS / TIEDOWNS
- CHEMICALS
- TOOLS
- HELMETS
- HELMET ACC.
- EYEWEAR
- APPAREL / RIDER ACC.
- PROMOTIONAL
- REFERENCE
- INDEX



## NEODANNA

- Combined a neoprene face mask with a soft 100% cotton bandanna
- Provides warmth as well as wind protection

Description	WPS#
A Black Paisley	26-4110
B Red Paisley	26-4111
C Skull	26-4120
D Fleece Windbreaker, Skull	26-4128
E Fleece Windbreaker Black	26-4122
F RideFree	26-4131



A



B



C



Fleece Material

D



E



F

## COMBO GAITER

- Soft yet, durable stretchy polyester shell lined with warm and super soft Cozy Fleece on the inside
- Wear as a neck gaiter or pull up over the nose to wear as a half mask
- Contoured to fit your shoulders without bunching
- Available in various prints and colors

Description	WPS#
A Quad Plaid	26-4049
B Skull Flower	26-4054
C Dark Paisley	26-4055
D Skull Plaid	26-4056
E Black and White Flag	26-4057
F Black	26-4058
G Classic Bandana	26-5127
H Patriot	26-5128



A



B



C



D



E



F



G



H





**MOTLEY TUBE**

- Versatile and durable multi-functional headgear
- 100% Polyester



Description	WPS#
A Black	26-4480
B Pink Ribbon	26-44807
C Classic Flames	26-44806
D Purple Paisley	26-4485
E Black Paisley	26-44801
F Red Paisley	26-44802
G Blue Paisley	26-44803
H Crossbones Design	26-44804
I Skull Xbones	26-4482
J Woodland Camo	26-4494
K Black & White Flag	26-5081
L Sugar Skull	26-5082
M Bone Breath	26-5083
N Dorado	26-5084
O Forest Camo	26-5085
P Floral Skull	26-5086

**FLEECE LINED MOTLEY TUBE**

- The Fleece Lined Motley Tube is a versatile all-in-one headgear constructed of polyester lined with soft microfleece
- Moisture wicking polyester layer on one side and insulating soft microfleece on the other
- Perfect to wear as a balaclava, face mask, neck warmer, scarf, beanie, and ear warmer to keep warm in the coldest of climates
- Lightweight and machine washable, one size fits most adults
- 100% Polyester

Description	WPS#
A Black Paisley	26-4491
B Purple Paisley	26-44901
C Black	26-4495
D Skull Xbones	26-4499
E Spandex Black (All Fleece)	26-4497
F Woodland Camo/Lime High Vis	26-5031
G Wavy Flag	26-5033
H Black and White Flag	26-5087
I Mother Road	26-5088
J Winter Camo	26-5138
K Olive	26-5139
L Patriot	26-5140



WINDSHIELDS / FAIRINGS  
AUDIO / COMMUNICATION  
SEATS / LUGGAGE  
BARS / MIRRORS / CONTROLS  
EXHAUST  
AIR / FUEL SYSTEMS  
ENGINE  
TRANSMISSION / DRIVELINE  
GASKETS / SEALS  
ELECTRICAL  
LIGHTING  
CABLES  
BRAKES  
OIL FILTERS  
SUSPENSION  
BODY  
WHEELS  
TIRES / TIRE ACC.  
BIKE ACC.  
VICTORY / INDIAN  
COVERS / LOCKS / TIEDOWNS  
CHEMICALS  
TOOLS  
HELMETS  
HELMET ACC.  
EYEWEAR  
APPAREL / RIDER ACC.  
PROMOTIONAL  
REFERENCE  
INDEX



ZANheadgear® HALF FACE MASK



- Stretchy neoprene material is warm and water resistant
- Reversible
- One size fits most
- 2" neoprene extension sold as an accessory



GLOW IN THE DARK

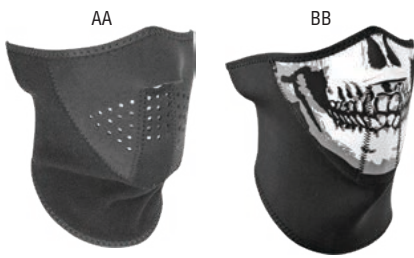

Neoprene extension piece for all Neoprene products.

Description	WPS#	Description	WPS#	Description	WPS#
A Black	26-4667	K Pink Flames	26-4665	U Forest Camo	26-5097
B Oversized Black	26-4534	L Spider Web	26-4666	V Patriot	26-5099
C Skull	26-4650	M Burning Skull	26-4668	W Muerte Skull	26-5104
D Oversized Skull	26-4532	N BioMech	26-4669	X Electric Skull	26-5133
E Red Flames	26-4651	O Purple Paisley	26-46510	Y Canadian Maple	26-5134
F Blue Chrome Skull	26-4658	P Bone Breath Glow	26-5054	Z Midnight Skull	26-5135
G Chrome Skull	26-4657	Q Sugar Skull reversible to purple	26-4027	EXT Neoprene Extension Piece, 6 Pack	26-4599
H Skull, Glow-in-the-dark	26-4654	R Black and White Flag	26-4035	<b>3-PANEL HALF MASK</b>	
I Hannibal	26-4662	S Dark Paisley	26-4038	AA Black	26-4043
J Alien	26-4663	T Pain	26-5095	BB Skull Face	26-4024



**FULL FACE MASK** ZANheadgear®



- Nylon bound edges for durability and comfort
- Thermal insulation and water resistant
- 2mm thick neoprene
- Reversible
- US Patent # D604, 910S



(Reversible Orange)



Description	WPS#
<b>FULL FACE MASK</b>	
A Black & White Skull	26-4550
B Stars & Stripes	26-4551
C Black	26-4567
D Bomber	26-4560
E Skull, Glow-in-the-Dark	26-4580
F Chrome Skull	26-4582
G Blue Chrome Skull	26-4583
H Urban Camo	26-4553

Description	WPS#
<b>FULL FACE MASK (CONT'D...)</b>	
I Woodland Camo	26-4568
J Woodland Rev High Vis Org	26-5051
K Mardi Gras	26-4577
L Jason mask, Glow-in-the-Dark	26-4588
M Red Paisley Bandanna	26-4540
N Spiderweb, Glow-in-the-Dark	26-4541
O Trickster	26-4543

- WINDSHIELDS / FAIRINGS
- AUDIO / COMMUNICATION
- SEATS / LUGGAGE
- BAR / MIRRORS / CONTROLS
- EXHAUST
- AIR / FUEL SYSTEMS
- ENGINE
- TRANSMISSION / DRIVELINE
- GASKETS / SEALS
- ELECTRICAL
- LIGHTING
- CABLES
- BRAKES
- OIL FILTERS
- SUSPENSION
- BODY
- WHEELS
- TIRES / TIRE ACC.
- BIKE ACC.
- VICTORY / INDIAN
- COVERS / LOCKS / TIEDOWNS
- CHEMICALS
- TOOLS
- HELMETS
- HELMET ACC.
- EYEWEAR
- APPAREL / RIDER ACC.
- PROMOTIONAL
- REFERENCE
- INDEX



**FULL FACE MASK**



- Nylon bound edges for durability and comfort
- Thermal insulation and water resistant
- 2mm thick neoprene
- Reversible
- US Patent # D604, 910S



Coldweather prepack:  
 • 12 Face masks  
 • 6 Half masks  
 • 6 Neodannas

Description	WPS#	Description	WPS#	Description	WPS#
A Skull	26-4591	G Black (Oversized)	26-4533	M Small Face, Black	26-4681
B Alien	26-4593	H Black (Fleece Lined)	26-4536	N Small Face Woodland Camo	26-4683
C Butterfly/Multi	26-4594	I Smiley Face	26-4538	O Vintage Flag Black and White	26-4034
D Orange Flame	26-4595	J BioMechanical	26-4556	P Dark Paisley	26-4037
E Vampire Glow-in-the-Dark	26-4547	K Blk/Wht Muerte	26-4557	Q Neoprene face mask, 24pc display	26-45500
F Skull (Oversized)	26-4531	L Small Face, Kitty	26-4561		



**NEOPRENE FULL FACE MASK** 



A



B



C



- Nylon bound edges for durability and comfort
- Thermal insulation and water resistant
- 2mm thick neoprene
- Reversible
- US Patent # D604, 910S



D



E



F



G



H



I



J



K



L



M



N



O

Description	WPS#
A Pain	26-5094
B Forest Camo	26-5096
C Patriot	26-5098
D Skull Ghost	26-5100
E Chicano Clown	26-5101
F Vintage Eagle	26-5102
G Muerte Skull	26-5103
H Silver Bullet	26-5105

Description	WPS#
I All Over Skull Camo	26-5106
J Mardi Gras (small face)	26-5107
K Black & White Flag (small face)	26-5108
L Red Dawn (small face)	26-5109
M Sprocket Skull	26-5129
N Multi Brushed Camo	26-5130
O Psychedelic Skull	26-5131
P Flower Skull	26-5132



P

- WINDSHIELDS / FAIRINGS
- AUDIO / COMMUNICATION
- SEATS / LUGGAGE
- BAR / MIRRORS / CONTROLS
- EXHAUST
- AIR / FUEL SYSTEMS
- ENGINE
- TRANSMISSION / DRIVELINE
- GASKETS / SEALS
- ELECTRICAL
- LIGHTING
- CABLES
- BRAKES
- OIL FILTERS
- SUSPENSION
- BODY
- WHEELS
- TIRES / TIRE ACC.
- BIKE ACC.
- VICTORY / INDIAN
- COVERS / LOCKS / TIEDOWNS
- CHEMICALS
- TOOLS
- HELMETS
- HELMET ACC.
- EYEWEAR
- APPAREL / RIDER ACC.**
- PROMOTIONAL
- REFERENCE
- INDEX



## NEOPRENE MASK HIGHWAY HONEYES

- One size fits most
- Hand embellished with over 20 Swarovski Crystals
- All season!
- Nylon bound edges for durability and better fit



A



B



C

Description	WPS#
<b>FULL MASK</b>	
A Mardi Gras	26-5041
B Butterfly	26-5042
C Muerte	26-5043
<b>HALF MASK</b>	
D Pink Flames	26-5044
E Purple Paisley	26-5045



D



E





- Many configurations available to suit most riding conditions
- One size fits all

**Fleece Lined**

- Ultimate Softness for comfort and warmth
- Silky soft fleece lining offers extra warmth
- Thick cotton/Poly Shell
- Easy on/off and access to face
- Machine Washable, 1 Size fits most, Moisture Wicking, Cold Weather



- A**
  - Flat seams
  - Non-bulky, durable nylon
- B**
  - Nylon bound seams for durability
  - Fleece resists bunching and pulling
- C**
  - Spandex head covering
  - Fleece Dickie tucks under shirt or jacket
- D**
  - Hook & Loop Closure
  - Mesh mouth provides ventilation

**Bamboo Balaclava**

- Nano infused bamboo cotton is naturally antibacterial & odor resistant
- Soft, comfortable, and protects from the elements
- Contoured neckline to prevent bunching
- Flat seams



- E**
  - Windflap on zipper
  - Weatherproof zipper closure
- F**
  - Insulating neoprene face fabric
  - Flat seams
- G**
  - Mesh mouth provides ventilation
  - Hook & Loop Closure
- H**
  - Optional neck or neck & mouth coverage
- I**
  - Half neoprene face mask
  - Neoprene tucks into shirt/jacket
- J**
  - Full neoprene face mask covers ears
  - Neoprene tucks into shirt/jacket



- K**
  - Neoprene face
  - Convenient for storage
  - Flat seam
- L**
  - Neoprene face
  - Convenient for storage
  - Flat seam
- M**
  - Soft 100% cotton polar fleece
  - Ideal for use under helmet
  - Non bulky - snug fit
- N**
  - 100% cotton
  - Ideal for any season
  - Fits under any style helmet
  - Protection from dust and bugs
- O**
  - 100% cotton
  - Ideal for any season
  - Fits under any style helmet
  - Protection from dust and bugs



Description	WPS#	Description	WPS#	Description	WPS#
A Nylon black	26-4080	I Black w/ Neoprene neck shield	26-4660	P Microfleece reversible neck gaiter	26-4020
B Fleece black	26-4081	J Black w/ Neoprene neck shield	26-4587	Q Microfleece reversible neck gaiter	26-4022
C Fleece spandex crown Black	26-4083	K Balaclava Extreme, FULL Mask, B&W Skull	26-4078	R Balaclava Motley Tube Polyester/ Spandex	26-5122
D Fleece velcro black	26-4084	L Balaclava Extreme, FULL Mask, Solid Black	26-4079	<b>COMFORT FLEECE</b>	
E Microfleece w/zipper	26-4086	M Cotton Balaclava, Black	26-40801	S Black	26-5036
F Coolmax w/mask black	26-4087	N Cotton Balaclava, Skull	26-40802		
G Microfleece w/mesh mouth black	26-4088	O Nylon Skull	26-40806		
H Neck warmer, Black micro-fleece	26-4090				

- WINDSHIELDS / FAIRINGS
- AUDIO / COMMUNICATION
- SEATS / LUGGAGE
- BARS / MIRRORS / CONTROLS
- EXHAUST
- AIR / FUEL SYSTEMS
- ENGINE
- TRANSMISSION / DRIVELINE
- GASKETS / SEALS
- ELECTRICAL
- LIGHTING
- CABLES
- BRAKES
- OIL FILTERS
- SUSPENSION
- BODY
- WHEELS
- TIRES / TIRE ACC.
- BIKE ACC.
- VICTORY / INDIAN
- COVERS / LOCKS / TIEDOWNS
- CHEMICALS
- TOOLS
- HELMETS
- HELMET ACC.
- EYEWEAR
- APPAREL / RIDER ACC.
- PROMOTIONAL
- REFERENCE
- INDEX



# BALACLAVA MICROLUX™



**MOISTURE WICKING**  
Fabric transfers moisture away from the skin & evaporates quickly, to keep you warm & dry.



**ANTIBACTERIAL**  
Treatment of fabric inhibits growth of odor causing bacteria.



**UPF**  
Provides ultraviolet radiation protection of 50+ UPF (Ultraviolet Protection Factor).



**FIT**

- Ability to wear over nose or below chin
- One size fits most

**CONSTRUCTION**

- Flat seams ensure a comfortable fit and no painful pressure points
- Contoured construction creates an excellent fit without bunching

**COMFORT**

- Lightweight, thin fabric provides a non-bulky layer of protection for use with or without a helmet
- 4 way stretch for a comfortable non restricting fit

**FABRIC**

- Luxuriously soft material provides comfort and warmth while wicking moisture away from the skin
- Antibacterial fabric eliminates odors



## MICROLUX™ BALACLAVA

- Luxuriously soft MicroLUX™ provides comfort and warmth by wicking moisture away from the skin
- Thin enough to comfortably fit under a helmet
- No irritating center seams
- Contoured construction creates an excellent fit without bunching
- Antibacterial fabric and flat seams
- 50+ UPF Sun Protection
- Machine Washable, 1 Size fits most, Moisture Wicking, Under Helmet, All Season, antibacterial

Description	WPS #
Geometric Skulls	26-5034
Black	26-5035

## CONVERTIBLE MICROLUX™ BALACLAVA



**MOISTURE WICKING**  
Fabric transfers moisture away from the skin & evaporates quickly, to keep you warm & dry.



**ANTIBACTERIAL**  
Treatment of fabric inhibits growth of odor causing bacteria.



**UPF**  
Provides ultraviolet radiation protection of 50+ UPF (Ultraviolet Protection Factor).

**4 WAYS TO WEAR**



**BALACLAVA**



**HOOD**



**NECK WARMER**



**FACE MASK**

**VERSATILE**

- Hinged construction allows for easy conversion according to weather and temperature conditions
- One size fits most
- Wear 4 different ways

**CONSTRUCTION**

- Flat seams ensure a comfortable fit and no painful pressure points
- Contoured neckline to prevent bunching

**COMFORT**

- Thin enough to comfortably fit under a helmet or alone
- 4 way stretch for a comfortable non restricting fit

**FABRIC**

- Luxuriously soft MicroLUX™ provides comfort and warmth
- Quick drying

Description	WPS #
A Black	26-4009
B Fuchsia	26-4010
C Blue	26-4011
D Gray	26-4012
E Geometric Skull	26-4008



**POLYESTER BALACLAVA**

- Polyester Balaclava offers optimal protection from the elements by providing coverage of the head, neck and face
- Constructed of 100% stretchy polyester
- Allows for a snug, yet comfortable fit.
- Also features two smooth seams that are strategically placed to eliminate an irritating pressure point when worn under a helmet
- Boasts vibrant graphics and its contoured design mitigates uncomfortable bunching



Description	WPS#
A Sugar Skull	26-5089
B Black & White Flag	26-5090
C Red Dawn	26-5091
D Black	26-5092
E Forest Camo	26-5093
F Polar Lights	26-5136
G Winter Camo	26-5137



**MODI-FACE BALACLAVA**

This Modi-Face™ Balaclava features a detachable mask that can be changed out to suit different styles and/or environments. The balaclava can also be worn with or without the detachable mask, making this a very versatile and fun headwear to use.

- Stretchy nylon balaclava provides comfortable lightweight protection
- Detachable mask allows for use with or without mask
- Change up your style with different detachable mask designs
- Neoprene face mask is warm and water resistant

Modi-Face Balaclava	WPS #
A Black balaclava w/ black detachable mask	26-4064
<b>DETACHABLE MASK</b>	
B Muerte mask ONLY	* 26-4013
C Gray Skull mask ONLY	* 26-4059
D Black and White Stars mask ONLY	* 26-4063
E Bone Breath mask ONLY (glow in the dark)	* 26-4065

\*Detachable face mask only. Must buy Balaclava (26-4064) to use.

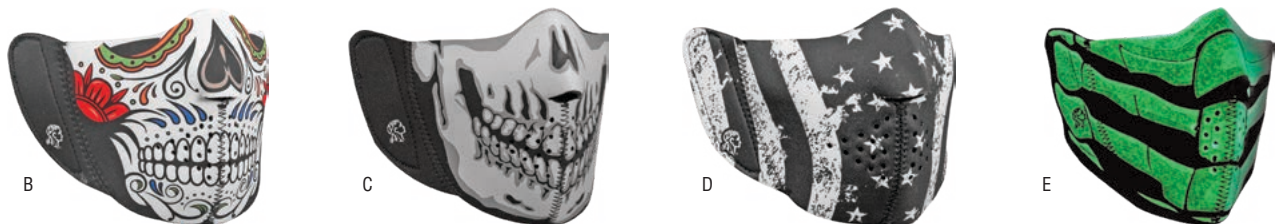

WINDSHIELDS / FAIRINGS  
 AUDIO / COMMUNICATION  
 SEATS / LUGGAGE  
 BARS / MIRRORS / CONTROLS  
 EXHAUST  
 AIR / FUEL SYSTEMS  
 ENGINE  
 TRANSMISSION / DRIVELINE  
 GASKETS / SEALS  
 ELECTRICAL  
 LIGHTING  
 CABLES  
 BRAKES  
 OIL FILTERS  
 SUSPENSION  
 BODY  
 WHEELS  
 TIRES / TIRE ACC.  
 BIKE ACC.  
 VICTORY / INDIAN  
 COVERS / LOCKS / TIEDOWNS  
 CHEMICALS  
 TOOLS  
 HELMETS  
 HELMET ACC.  
 EYEWEAR  
 APPAREL / RIDER ACC.  
 PROMOTIONAL  
 REFERENCE  
 INDEX



## NEO-X FACE MASK **NEW**

- Adjustable metal nosepiece: Ensures a comfortable, secure fit
- Replaceable antibacterial bamboo filter: 3 biodegradable filters included to protect against airborne debris and can be easily replaced
- Neoprene Lip: In conjunction with the metal nose piece, the lip effectively aids in inhibiting fogging
- Air vents: Offer ventilation for the ease of breathing
- Nylon bound edges: For durability and better fit



A



B



C



D

	WPS#
A Black	26-5123
B Multi Brushed Camo	26-5124
C Classic Bandana	26-5125
D Midnight Skull	26-5126

## TROOPER HATS

Description	WPS#
A Buffalo Plaid	26-4060
B Black	26-4061



A



B

# RYDER CLIPS FOR LACED BOOTS



- Our Goal is to Keep Your Pants Down with function, safety and style
- Many different designs to match the style of both men and women
- Available with two clip version for Laced Boots or single money clip version for Stirrup/Strap boots. Sold in pairs.
- Instructions are printed on the back of each display card

**OUR GOAL IS TO KEEP YOUR PANTS DOWN®**



*clip to Lace*

*clip to pant cuff*

Ryder Clip display available, contact your WPS rep. for details.

	Description	WPS#
<b>LACE TYPE</b>		
A	Bones/Skull	26-7000
B	Engine/Shield	26-7001
C	Flames	26-7002
D	Flower	26-7003
E	Heart/Skull	26-7004
F	Heart/Skull Chrome	26-7005
G	John 3:16	26-7006
H	Maltese Cross	26-7007
I	POW/MIA	26-7008
J	Western Star	26-7009
K	Skull/Wings	26-7010
L	Armed Forces	26-7011
M	USMC Red	26-7012
N	USMC Bronze	26-7013



- WINDSHIELDS / FAIRINGS
- AUDIO / COMMUNICATION
- SEATS / LUGGAGE
- BAR / MIRRORS / CONTROLS
- EXHAUST
- AIR / FUEL SYSTEMS
- ENGINE
- TRANSMISSION / DRIVELINE
- GASKETS / SEALS
- ELECTRICAL
- LIGHTING
- CABLES
- BRAKES
- OIL FILTERS
- SUSPENSION
- BODY
- WHEELS
- TIRES / TIRE ACC.
- BIKE ACC.
- VICTORY / INDIAN
- COVERS / LOCKS / TIEDOWNS
- CHEMICALS
- TOOLS
- HELMETS
- HELMET ACC.
- EYEWEAR
- APPAREL / RIDER ACC.
- PROMOTIONAL
- REFERENCE
- INDEX



## RYDER CLIPS FOR STIRRUP/STRAP BOOTS

OUR GOAL IS  
TO KEEP  
YOUR  
PANTS DOWN®

- Our Goal is to Keep Your Pants Down with function, safety and style
- Many different designs to match the style of both men and women
- Available with two clip version for Laced Boots or single money clip version for Stirrup/Strap boots. Sold in pairs.
- Instructions are printed on the back of each display card

Description	WPS#
<b>STIRRUP/STRAP TYPE</b>	
O Engine/Shield	26-7050
P Flames	26-7051
Q Flower	26-7052
R Heart/Skull	26-7053
S Heart/Skull Chrome	26-7054
T John 3:16	26-7055
U Maltese Cross	26-7056
V POW/MIA	26-7057
W Western Star	26-7059
X Skull/Wings	26-7058
Y Armed Forces	26-7060
Z USMC Red	26-7061
AA USMC Bronze	26-7062



slip over strap



clip to pant cuff

O

P



Q

R

S

T



U

V

W

X



Y

Z

AA





# ARMPRO SLEEVES



Our "Arm Pro Compression Sleeves" are made from a 4-way stretch, moisture wicking material that provides a cooling effect while riding. To increase the cooling effect on really hot days, just wet them down with water. Protect your arms and your ink from the harmful effects of the sun and stay cool with these muscle compression sleeves featuring stunning tattoo designs.

- Made from high tech moisture wicking material that acts as cooling system when riding
- SPF 50
- 4-way stretch fabric provides compression to help prevent muscle fatigue
- Can be worn wet to enhance cooling effect
- Non-slip silicone gripper at bicep
- 15 unique stunning tattoo designs to choose from



B C left C right D E F G H left



H right I J left K right K L left M right M N



O left P right



P Q R S T



A



B



C

Model	XS	S	M	L	X
A Turn Signals	261-1001XS	261-1001S	261-1001M	261-1001L	
B American Freedom		261-1002S	261-1002M	261-1002L	261-1002X
C Iraqi Freedom		261-1003S	261-1003M	261-1003L	261-1003X
D Face Off	261-1005XS	261-1005S	261-1005M	261-1005L	261-1005X
E Don't Be Koi	261-1006XS	261-1006S	261-1006M	261-1006L	261-1006X
F Love Bites	261-1007XS	261-1007S	261-1007M	261-1007L	261-1007X
G Biomechanical Me		261-1008S	261-1008M	261-1008L	261-1008X
H Mother Mary	261-1009XS	261-1009S	261-1009M	261-1009L	261-1009X
I Guns N Money		261-1010S	261-1010M	261-1010L	261-1010X
J Cherokee Wisdom		261-1011S	261-1011M	261-1011L	261-1011X
K POW*MIA		261-1012S	261-1012M	261-1012L	261-1012X
L Forever Inked	261-1013XS	261-1013S	261-1013M	261-1013L	261-1013X
M Bones N Roses	261-1014XS	261-1014S	261-1014M	261-1014L	261-1014X
N Armed & Dangerous		261-1015S	261-1015M	261-1015L	261-1015X
O Grace & Forgiveness	261-1016XS	261-1016S	261-1016M	261-1016L	261-1016X
P Solid Blue	261-1017XS	261-1017S	261-1017M	261-1017L	261-1017X
Q Solid Pink	261-1018XS	261-1018S	261-1018M	261-1018L	261-1018X
R Solid White	261-1019XS	261-1019S	261-1019M	261-1019L	261-1019X
S Solid Red	261-1020XS	261-1020S	261-1020M	261-1020L	261-1020X
T Solid Black	261-1021XS	261-1021S	261-1021M	261-1021L	261-1021X

- WINDSHIELDS / FAIRINGS
- AUDIO / COMMUNICATION
- SEATS / LUGGAGE
- BARS / MIRRORS / CONTROLS
- EXHAUST
- AIR / FUEL SYSTEMS
- ENGINE
- TRANSMISSION / DRIVELINE
- GASKETS / SEALS
- ELECTRICAL
- LIGHTING
- CABLES
- BRAKES
- OIL FILTERS
- SUSPENSION
- BODY
- WHEELS
- TIRES / TIRE ACC.
- BIKE ACC.
- VICTORY / INDIAN
- COVERS / LOCKS / TIEDOWNS
- CHEMICALS
- TOOLS
- HELMETS
- HELMET ACC.
- EYEWEAR
- APPAREL / RIDER ACC.
- PROMOTIONAL
- REFERENCE
- INDEX

# HEAROS EAR PLUGS

## ULTIMATE SOFTNESS EAR PLUGS

- 14 Pairs
- 32 Decibel noise reduction rating
- Made in the U.S.A.

Description	WPS#
14 pr w/o case	27-9023



## EXTREME PROTECTION EAR PLUGS

- 7 pairs
- Free case
- 33 Decibel noise reduction rating
- Made in the U.S.A.

Description	WPS#
14 pr w/o case	27-9022



## ROCK'N ROLL EAR PLUGS

- Washable, Reusable
- 1 Pair
- Free case
- 22 Decibel noise reduction rating
- Made in the U.S.A.

Series	WPS#
Rock N' Roll	27-9001

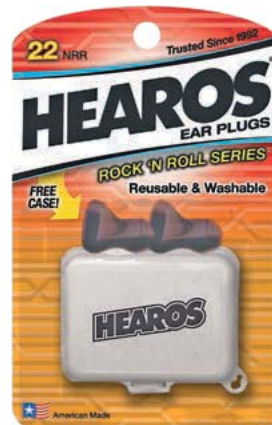

# ADAPTIV<sup>TM</sup> TECHNOLOGIES



WPS#  
**71-DISPLAY**



Shipped From WPS#

WPS	<b>56-DISPLAY1</b>
WPS	<b>56-DISPLAY2</b>



Description WPS#

Air Hawk slat wall display **86-9520**



C



D



A



B

	Description	Shipped From	WPS #
A	Counter Display	WPS	<b>84-9993</b>
B	Both Floor Displays	Bel-Ray	
C	Optional Graphics	Bel-Ray	
D	Optional Graphics	Bel-Ray	
E	18"x12" Metal Sign	Bel-Ray	

- WINDSHIELDS / FAIRINGS
- AUDIO / COMMUNICATION
- SEATS / LUGGAGE
- BARS / MIRRORS / CONTROLS
- EXHAUST
- AIR / FUEL SYSTEMS
- ENGINE
- TRANSMISSION / DRIVELINE
- GASKETS / SEALS
- ELECTRICAL
- LIGHTING
- CABLES
- BRAKES
- OIL FILTERS
- SUSPENSION
- BODY
- WHEELS
- TIRES / TIRE ACC.
- BIKE ACC.
- FACTORY / NON-FACTORY
- COVERS / LOCKS / TIE-DOWNS
- CHEMICALS
- TOOLS
- HELMETS
- HELMET ACC.
- WEAR
- APPAREL / RIDER ACC.
- PROMOTIONAL
- REFERENCE
- INDEX



## COUNTER DISPLAYS

Drop shipped from Bobster

	Description	WPS #
A	Goggle Counter Display	<b>26-BOBSTER3</b>
B	Sunglass Counter Display	<b>26-BOBSTER5</b>
C	Spinning Counter Display	<b>26-BOBSTER6</b>
D	Mini Tower(drop shipped from Bobster)	
E	Tower(drop shipped from Bobster)	
	UV Flashlight	<b>26-LIGHT</b>

A



B



D



C



E



- WINDSHIELDS / FAIRINGS
- AUDIO / COMMUNICATION
- SEATS / LUGGAGE
- BARS / MIRRORS / CONTROLS
- EXHAUST
- AIR / FUEL SYSTEMS
- ENGINE
- TRANSMISSION / DRIVELINE
- GASKETS / SEALS
- ELECTRICAL
- LIGHTING
- CABLES
- BRAKES
- OIL FILTERS
- SUSPENSION
- BODY
- WHEELS
- TIRES / TIRE ACC.
- BIKE ACC.
- VICTORY / INDIAN
- COVERS / LOCKS / TIEDOWNS
- CHEMICALS
- TOOLS
- HELMETS
- HELMET ACC.
- EYEWEAR
- APPAREL / RIDER ACC.
- PROMOTIONAL**
- REFERENCE
- INDEX



Sidekick Display

# Bomber™ COUNTER DISPLAYS

**Smaller Starter Kit Contents Qty**

SAFETY/FLOATING	
A-Bomb Lt. Blue lens	2
Z-Bomb Smoke lens	2
Stink-Bomb Black/ Smoke lens	3
FLOATING	
Nitro-Bomb Tortoise/ Amber lens	2
K-Bomb Silver/ Mirror lens	1
B-52 Black/ Smoke Polarized	2
Sugar-Bomb Black/ Smoke lens	2

Description	WPS#
Sidekick Display ONLY (free w/purchase of 18 pairs of glasses)	519-0002



## DISPLAY

- Free-standing display
- Sign included
- Each shelf can hold 36 one-quart bottles or 6 one-gallon jugs
- 3 shelves are height adjustable to allow for multiple merchandise configurations
- Bold Castrol branding on the header care and each of the adjustable shelves
- Ships from Castrol

# CLYMER® DISPLAYS

- Holds approximately 20 manuals, depending on the size of manuals
- Rotates on a ball bearing base



Description	WPS#
25 Title rack	27-1015
20 Title counter spinning rack	27-1014
9 Title rack	27-1010A
6 Title rack	27-1012

- WINDSHIELDS / FAIRINGS
- AUDIO / COMMUNICATION
- SEATS / LUGGAGE
- BAR / MIRRORS / CONTROLS
- EXHAUST
- AIR / FUEL SYSTEMS
- ENGINE
- TRANSMISSION / DRIVELINE
- GASKETS / SEALS
- ELECTRICAL
- LIGHTING
- CABLES
- BRAKES
- OIL FILTERS
- SUSPENSION
- BODY
- WHEELS
- TIRES / TIRE ACC.
- BIKE ACC.
- VICTORY / INDIAN
- COVERS / LOCKS / TIEDOWNS
- CHEMICALS
- TOOLS
- HELMETS
- HELMET ACC.
- EYEWEAR
- APPAREL / RIDER ACC.
- PROMOTIONAL
- REFERENCE
- INDEX

- WINDSHIELDS / FAIRINGS
- AUDIO / COMMUNICATION
- SEATS / LUGGAGE
- BARS / MIRRORS / CONTROLS
- EXHAUST
- AIR / FUEL SYSTEMS
- ENGINE
- TRANSMISSION / DRIVELINE
- GASKETS / SEALS
- ELECTRICAL
- LIGHTING
- CABLES
- BRAKES
- OIL FILTERS
- SUSPENSION
- BODY
- WHEELS
- TIRES / TIRE ACC.
- BIKE ACC.
- VICTORY / INDIAN
- COVERS / LOCKS / TIEDOWNS
- CHEMICALS
- TOOLS
- HELMETS
- HELMET ACC.
- EYEWEAR
- APPAREL / RIDER ACC.
- PROMOTIONAL
- REFERENCE
- INDEX



## DRAGON DISPLAYS

Description	Dimensions W x H x D	WPS#
A Top/Counter	19.5" x 24" x 14"	724-2468
B Tray Base	23.5" x 43" x 19"	724-2479
Medium display eyewear	16.5" x 71" x 19"	724-2465
Large display goggle	30" x 78" x 16"	724-2471
C Free Stand		724-71360
P.O.P. Kit		724-1909



### A TOP / COUNTER

W 23.5" x L 24" x D 18.5"

(Product not included)

### B BASE WITH SHELVES

W 23.5" x L 43" x D 19"



C



Description	WPS#
Floor Display	27-6001



## WATERFALL FIXTURE

For every 5 pair of Drayko jeans purchased on one order get 1 Drayko slatwall waterfall fixture FREE

Description	WPS#
Slatwall water fall	472-1001



## EBC

Each display comes complete with a dual purpose leaflet holder, which either attaches to the EBC rotor display or can be left free standing.

Description	WPS#
Big Twin	15-DISPLAY
Brochure Holder	15-DISPLAY INFO



# FLOOR DISPLAYS

Display Racks can be ordered with the following signs and can be configured to showcase apparel, hats, goggles and more. Racks and Signs are sold separately.



A



B

Shown with FLY Street signs

Description	WPS#
<b>DISPLAY RACKS</b>	
A Small Display Rack 15"L x 16"W x 60" H	<b>363-9920</b>
B Large Display Rack 48"L x 16"W x 60"	<b>363-9921</b>

C Small FLY Street Sign	<b>477-SIGN13</b>
D Small Highway 21 Sign	<b>489-SIGN13</b>
E Small FLY Racing Sign	<b>363-SIGN13</b>
F Large FLY Street Sign	<b>477-SIGN44</b>
G Large Highway 21 Sign	<b>489-SIGN44</b>
H Large FLY Racing Sign	<b>363-SIGN44</b>

**DISPLAY SIGNS**



C



D



E



F



G



H



A / B  
20 Helmet Display  
shown with sign

## HELMET DISPLAY

- Displays 20 helmets
- Back of display includes a mirror and a display area for accessories
- Hardware and directions included
- Sign must be ordered separately

Description	WPS#
A 20 Helmet Display	<b>73-0001</b>
B Fly sign	<b>73-DISPLAY SIGN</b>



C / D  
12 Helmet Display  
shown with signs

## 12 HELMET FLY STREET DISPLAY

- 12-pc Helmet Display Rack
- Shown with the FLY Racing 4-pack insert signs which must be ordered separately (73-0008).

Description	WPS#
C 12 Helmet Display	<b>74-DISPLAY</b>
D FLY Sign for 12 Helmet Display	<b>73-0008*</b>
Replacement shelf for 12 Helmet Display	<b>74-SHELF</b>



## SLAT WALL SHELVES

Description	WPS#
Helmet Shelf	<b>36-HELMET SHELF</b>
Boot Shelf	<b>36-BOOT SHELF</b>
3x6 Fly Street Banner	<b>BANNER-FLYSTREET</b>
Fly Boot Shelf 2/pk	<b>363-9924</b>

- WINDSHIELDS / FAIRINGS
- AUDIO / COMMUNICATION
- SEATS / LUGGAGE
- BARS / MIRRORS / CONTROLS
- EXHAUST
- AIR / FUEL SYSTEMS
- ENGINE
- TRANSMISSION / DRIVELINE
- GASKETS / SEALS
- ELECTRICAL
- LIGHTING
- CABLES
- BRAKES
- OIL FILTERS
- SUSPENSION
- BODY
- WHEELS
- TIRES / TIRE ACC.
- BIKE ACC.
- VICTORY / INDIAN
- COVERS / LOCKS / TIEDOWNS
- CHEMICALS
- TOOLS
- HELMETS
- HELMET ACC.
- EYEWEAR
- APPAREL / RIDER ACC.
- PROMOTIONAL
- REFERENCE
- INDEX



Description	WPS#
A Garmin Zumo Table Tent	989-9990
B Garmin Zumo Window Cling	989-9991
C Garmin Zumo Shelf Talker	989-9992
Garmin Brochure	989-9993
D Garmin Zumo 390LM Display	989-DISPLAY
E Garmin Zumo Pop-Up Display	989-DISPLAY3
Garmin Virb Camera Small Display	989-DISPLAY1
F Garmin Virb Camera Large HD Display	989-DISPLAY2
G Free Standing Display	989-DISPLAY4
H Garmin Virb 360 Display	989-DISPLAY5



## HELMET DISPLAYS

### 20 HELMET DISPLAY

- Back of display includes a mirror and a display area for accessories
- Hardware and directions included
- Sign must be ordered separately

### 12-PIECE HELMET DISPLAY

- Includes 12 angled shelves to display helmet neatly in full view
- Industrial looking branded signs available, 4 total to a set
- Assembly instructions included
- Insert signs must be ordered separately

Description	WPS#
A 20 Helmet Display	73-0001
B G-Max Sign	72-DISPLAY SIGN
C 12 Helmet Display	74-DISPLAY
D G-Max Sign for the 12 Helmet Display	72-0008
Replacement shelf for 12 Helmet Display	74-SHELF
E Slat wall helmet display shelf	72-SHELF
Slat wall shelf stand	72-STAND
F MX86 Display	72-0001
G FF88 Display	72-0002



A/B  
20 Helmet Display shown with sign

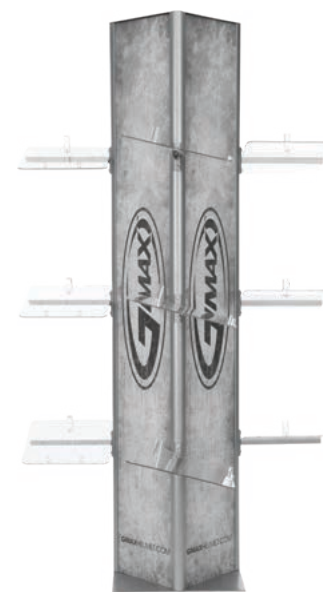

C/D  
12-Piece Helmet Display shown with signs



E





A



B

Description	WPS#
A HardDrive Rug 33" x 73"	<b>RUG-HARDDRIVE</b>
HardDrive Banner 3' x 6'	<b>BANNER-HARDDRIVE</b>
B HardDrive Banner 18" x 36"	<b>BANNER-HARDDRIVE2</b>

Description	WPS#
Leather Black Key Chain	<b>489-9982</b>



Description	WPS#
Hard Drive Mechanic Stool	<b>810-9998</b>



Description	WPS#
Oil Rack	<b>822-DISPLAY</b>
Oil Sign	<b>820-9980</b>

**KICKSTAND PAD**

- 4" diameter durable plastic kickstand pad
- Sold in a pack of 20 w/display box



Description	WPS#
KICKSTAND PADS 20 PK W/DISPLAY BOX	<b>820-99100</b>

WINDSHIELDS / FAIRINGS  
 AUDIO / COMMUNICATION  
 SEATS / LUGGAGE  
 BARS / MIRRORS / CONTROLS  
 EXHAUST  
 AIR / FUEL SYSTEMS  
 ENGINE  
 TRANSMISSION / DRIVELINE  
 GASKETS / SEALS  
 ELECTRICAL  
 LIGHTING  
 CABLES  
 BRAKES  
 OIL FILTERS  
 SUSPENSION  
 BODY  
 WHEELS  
 TIRES / TIRE ACC.  
 BIKE ACC.  
 VICTORY / INDIAN  
 COVERS / LOCKS / TIEDOWNS  
 CHEMICALS  
 TOOLS  
 HELMETS  
 HELMET ACC.  
 EYEWEAR  
 APPAREL / RIDER ACC.  
 PROMOTIONAL  
 REFERENCE  
 INDEX



10x20



10x10



Full Wall

Size	WPS#
10' x 10'	810-9900
10' x 20'	810-9905
<b>ACCESSORIES</b>	
Canopy Top 10' x 10'	810-9901
Full Wall 10'	810-9902
Canopy Top 10' x 20'	810-9906
Full Wall 20'	810-9907



11'

18'

Solar Flag ground stakes are sold separately

Description	WPS#
11' Solar Flag	810-9911
18' Solar Flag	810-9912
Solar Flag Ground Stake	360-9884



Description	WPS#
8' Table Cover	810-9910

- WINDSHIELDS / FAIRINGS
- AUDIO / COMMUNICATION
- SEATS / LUGGAGE
- BARS / MIRRORS / CONTROLS
- EXHAUST
- AIR / FUEL SYSTEMS
- ENGINE
- TRANSMISSION / DRIVELINE
- GASKETS / SEALS
- ELECTRICAL
- LIGHTING
- CABLES
- BRAKES
- OIL FILTERS
- SUSPENSION
- BODY
- WHEELS
- TIRES / TIRE ACC.
- BIKE ACC.
- VICTORY / INDIAN
- COVERS / LOCKS / TIEDOWNS
- CHEMICALS
- TOOLS
- HELMETS
- HELMET ACC.
- EYEWEAR
- APPAREL / RIDER ACC.
- PROMOTIONAL**
- REFERENCE
- INDEX

# HIGHWAY 21



Canopy



Table Cloth



Solar Flag



Solar Flag ground stakes are sold separately



Waterfall hanger post



Sign 44" Display



Banner



Key Chains



Fob Cover



Decals

Size / Description	Color	WPS#
<b>HWY21 CANOPY</b>		
10x10'	Black	<b>489-9903</b>
<b>HWY21 SOLAR FLAG</b>		
11'	Black	<b>489-9902</b>
<b>HWY21 TABLE COVER</b>		
8' X 30"	Black	<b>489-9901</b>
<b>REPLACEMENT PARTS/ACCESSORIES</b>		
10x10' Canopy Top	Black	<b>489-9900</b>
10x10' Heavy Duty *Frame Only		<b>360-9879</b>
Replacement Legs HD		<b>360-9903</b>
Plastic Corner HD Frame		<b>360-9905</b>
Plastic Cross Brace Fittings		<b>360-9902</b>
Plastic Corner STD Frame		<b>360-9904</b>
Standard Replacement Legs		<b>360-9900</b>
Aluminum Cross Piece		<b>360-9901</b>
Solar Flag Ground Stake		<b>360-9884</b>
Solar Flag Leg Mount HD		<b>360-9885</b>

Description	WPS#
3x6 Banner	<b>BANNER-HWY21</b>
Waterfall Hanger Post	<b>489-9905</b>
Sign 44" Display	<b>489-SIGN44</b>
Leather Key Chain Black	<b>489-9980</b>
Leather Key Chain Brown	<b>489-9981</b>
Leather Fob Cover	<b>489-9982</b>
Decals (10pk)	<b>99-8321</b>
Decals (100pk)	<b>99-8320</b>

- WINDSHIELDS / FAIRINGS
- AUDIO / COMMUNICATION
- SEATS / LUGGAGE
- BARS / MIRRORS / CONTROLS
- EXHAUST
- AIR / FUEL SYSTEMS
- ENGINE
- TRANSMISSION / DRIVELINE
- GASKETS / SEALS
- ELECTRICAL
- LIGHTING
- CABLES
- BRAKES
- OIL FILTERS
- SUSPENSION
- BODY
- WHEELS
- TIRES / TIRE ACC.
- BIKE ACC.
- VICTORY / INDIAN
- COVERS / LOCKS / TIEDOWNS
- CHEMICALS
- TOOLS
- HELMETS
- HELMET ACC.
- EYEWEAR
- APPAREL / RIDER ACC.
- PROMOTIONAL
- REFERENCE
- INDEX

- WINDSHIELDS / FAIRINGS
- AUDIO / COMMUNICATION
- SEATS / LUGGAGE
- BAR / MIRRORS / CONTROLS
- EXHAUST
- AIR / FUEL SYSTEMS
- ENGINE
- TRANSMISSION / DRIVELINE
- GASKETS / SEALS
- ELECTRICAL
- LIGHTING
- CABLES
- BRAKES
- OIL FILTERS
- SUSPENSION
- BODY
- WHEELS
- TIRES / TIRE ACC.
- BIKE ACC.
- VICTORY / INDIAN
- COVERS / LOCKS / TIEDOWNS
- CHEMICALS
- TOOLS
- HELMETS
- HELMET ACC.
- EYEWEAR
- APPAREL / RIDER ACC.
- PROMOTIONAL
- REFERENCE
- INDEX



## FILTER DISPLAYS

- Comes with a K&N filter and paper filter and shows how much more air the K&N filter flows
- Works great on the customer counter
- Oil filter display holds 6 K&N Oil Filters
- Slat/Gridwall display includes signage & 2 shelves

Description	Shipped From	WPS#
A Free-Standing Display	K&N	
B Metal Sign	WPS	33-9011
C Counter Display	WPS	56-DISPLAY
D Hitch cover	WPS	33-9012
E Air Filter Display	K&N	



A

Some displays are shipped directly from K&N



B



C



D

## KRYPTONITE®

- 2 x 5 Kryptonite display
- Display is drop shipped from Kryptonite

Description
2X5 Display (Drop shipped from Kryptonite)



Description	WPS #
Banner	58-5396
A Counter Mat	58-5397
B Display Rack	58-5395
C Oil Demonstrator	58-5398

A



C



B





A



B

C



D

### DISPLAY

- Lightweight plastic design is strong and easy to assemble
- Sign included

Description	WPS#
A Maxima Oil Display	78-9960
B Air filter Display	780-0399
C Oil filter Display	780-0199
D Counter Display	78-9962



### GLOVE DISPLAY

- Easy to assemble counter display comes with the following Mechanix Original gloves:

	Black	Red	Blue
M	1	1	1
L	2	2	2
X1	1	1	

Plus one extra black large glove FREE

Description	WPS#
13 Piece Display Rack	26-DISPLAY



Tire inserts for tire stands and slat walls



Description	WPS#
Pilot Power	87-9912
Pilot Power 2CT	87-9900
Pilot Road 3	87-9902
Power Pure	87-9906
Commander	87-9904
M12	87-9909
S12	87-9908
S12 XC	87-9905
Starcross 19"	87-9907
Starcross	87-9903



### TIRE RACK

- All metal rack is 2 levels that holds 20-30 mixed tires
- Strong swivel-caster wheels make it easy to move the rack for cleaning or rearranging the store
- Includes attractive Michelin sign

**Must order both parts to make complete tire rack**

Description	WPS#
Tire Rack	87-TIRE RACK
Michelin Sign (Metric)	87-0010
Michelin Sign (V-twin)	87-0014
Replacement tire/wheel	87-TIRE RACK WHEEL

WINDSHIELDS / FAIRINGS  
 AUDIO / COMMUNICATION  
 SEATS / LUGGAGE  
 BARS / MIRRORS / CONTROLS  
 EXHAUST  
 AIR / FUEL SYSTEMS  
 ENGINE  
 TRANSMISSION / DRIVELINE  
 GASKETS / SEALS  
 ELECTRICAL  
 LIGHTING  
 CABLES  
 BRAKES  
 OIL FILTERS  
 SUSPENSION  
 BODY  
 WHEELS  
 TIRES / TIRE ACC.  
 BIKE ACC.  
 VICTORY / INDIAN  
 COVERS / LOCKS / TIEDOWNS  
 CHEMICALS  
 TOOLS  
 HELMETS  
 HELMET ACC.  
 EYEWEAR  
 APPAREL / RIDER ACC.  
 PROMOTIONAL  
 REFERENCE  
 INDEX

WINDSHIELDS / FAIRINGS  
 AUDIO / COMMUNICATION  
 SEATS / LUGGAGE  
 BARS / MIRRORS / CONTROLS  
 EXHAUST  
 AIR / FUEL SYSTEMS  
 ENGINE  
 TRANSMISSION / DRIVELINE  
 GASKETS / SEALS  
 ELECTRICAL  
 LIGHTING  
 CABLES  
 BRAKES  
 OIL FILTERS  
 SUSPENSION  
 BODY  
 WHEELS  
 TIRES / TIRE ACC.  
 BIKE ACC.  
 VICTORY / INDIAN  
 COVERS / LOCKS / TIEDOWNS  
 CHEMICALS  
 TOOLS  
 HELMETS  
 HELMET ACC.  
 EYEWEAR  
 APPAREL / RIDER ACC.  
 PROMOTIONAL  
 REFERENCE  
 INDEX



## CABLE HANGERS

- 4 1/2" long cable holders with header card to write in part number

Description	WPS#
Cable Hangers	70-1158



## DISPLAYS

### Description

- A 4 Shelf Large Rack (Drop shipped from Motorex)
- B 4 Shelf Small Rack (Drop shipped from Motorex)
- C Drum Table (Drop shipped from Motorex)



C



A



B



## BARSTOOLS



### DISPLAY

Plastic stand with 4 shelves

Drop shipped from Motul



## COVER DISPLAY

Description	WPS#
Nelson Rigg Cover Display	270-DISPLAY



## SPARK PLUG CABINET

- Rugged, lightweight all metal construction
- 5 Shelves holds up to 500 spark plugs
- Pre-drilled for easy wall mounting
- Dimensions 18-1/8"W x 23"H x 8"D



## SPARK PLUG WIRE RACK



Description	WPS#
Cabinet (special order)	2-2000
Wire display	2-2001



## TIRE RACK DISPLAY

- All metal rack is 2 levels that holds 20-30 mixed tires
- Strong swivel-caster wheels make it easy to move the rack for cleaning or rearranging the store
- Nice Pirelli sign to add a great look

Description	WPS#
Tire Rack	87-TIRE RACK
Pirelli Sign	87-0011
Replacement tire/wheel	87-TIRE RACK WHEEL



## RUG & BANNER

Description	WPS#
Pirelli Track Banner 3' x 9'	BANNER-PIRELLI2



Description	WPS#
Ram Mount Display	71-RAMDISPLAY

- WINDSHIELDS / FAIRINGS
- AUDIO / COMMUNICATION
- SEATS / LUGGAGE
- BAR / MIRRORS / CONTROLS
- EXHAUST
- AIR / FUEL SYSTEMS
- ENGINE
- TRANSMISSION / DRIVELINE
- GASKETS / SEALS
- ELECTRICAL
- LIGHTING
- CABLES
- BRAKES
- OIL FILTERS
- SUSPENSION
- BODY
- WHEELS
- TIRES / TIRE ACC.
- BIKE ACC.
- VICTORY / INDIAN
- COVERS / LOCKS / TIEDOWNS
- CHEMICALS
- TOOLS
- HELMETS
- HELMET ACC.
- EYEWEAR
- APPAREL / RIDER ACC.
- PROMOTIONAL
- REFERENCE
- INDEX

# The Original **Ryder Clips**

Description	WPS #
Ryder clips display for 24 pcs	<b>26-7290</b>
V-twin skins display for 10 pcs	<b>26-7293</b>
Ryder balls display for 30 pcs	<b>26-7291</b>



# SENA

Description	WPS#
Countertop Display	<b>843-CDISPLAY</b>



# S100 Cycle Care Products

Drop shipped from S100



# FUCHS **Silkolene**<sup>®</sup> SUPERIOR MOTORCYCLE LUBRICANTS

- Free standing display
- Measures 63"H x 29½"W x 20½"D

WPS#  
**89-RACK**







## TIRE RACK

- All metal rack is 2 levels that holds 20-30 mixed tires
- Strong swivel-caster wheels make it easy to move the rack for cleaning or rearranging the store
- Attractive Shinko sign, order separately



Description	WPS#
Tire Rack	<b>87-TIRE RACK</b>
Shinko Sign	<b>87-0015</b>
Replacement tire/wheel	<b>87-TIRE RACK WHEEL</b>

**Must order both parts to make complete tire rack**



## ALUMINUM CANOPIES

- High quality aluminum framed canopies
- Each canopy comes with tie down stakes, rope and a handy carrying bag
- Replacement canopy tops work with Shinko and Fly canopy frames

Size	Color	WPS #
10' x 10'	Black w/std frame	<b>87-4980</b>
10' x 10"	Black w/heavy duty frame	<b>87-4981</b>
10 X 10	Replacement Top	<b>87-4982</b>
	Full Wall	<b>87-4985</b>
	Replacemnet carry bag	<b>87-4986</b>

Description	WPS #
<b>REPLACEMENT PARTS</b>	
Plastic cross brace fittings	<b>360-9902</b>
Replacement legs	<b>360-9900</b>
Aluminum cross piece	<b>360-9901</b>
Replacement canopy top	<b>87-4982</b>

## TIRE STAND

- Great way to display tire models, "sets," deals and to "show and sell," Shinko tires in your store
- Focus attention to a certain Shinko Tire



Order both, stand and display sign, for complete look

Description	WPS#
Tire Stand ea.	<b>87-Shinko Stand</b>



A



B



C



D

Description	WPS#
A Shinko Floor Rug	<b>RUG-SHINKO</b>
B Shinko Track Banner 6' x 3'	<b>BANNER-SHINKO</b>
C Solar Flag	<b>87-4983</b>
D Table Cover	<b>87-4984</b>

- WINDSHIELDS / FAIRINGS
- AUDIO / COMMUNICATION
- SEATS / LUGGAGE
- BAR / MIRRORS / CONTROLS
- EXHAUST
- AIR / FUEL SYSTEMS
- ENGINE
- TRANSMISSION / DRIVELINE
- GASKETS / SEALS
- ELECTRICAL
- LIGHTING
- CABLES
- BRAKES
- OIL FILTERS
- SUSPENSION
- BODY
- WHEELS
- TIRES / TIRE ACC.
- BIKE ACC.
- VICTORY / INDIAN
- COVERS / LOCKS / TIEDOWNS
- CHEMICALS
- TOOLS
- HELMETS
- HELMET ACC.
- EYEWEAR
- APPAREL / RIDER ACC.
- PROMOTIONAL
- REFERENCE
- INDEX

# Star brite®



- 96 Piece double sided

Description	WPS#
Floor Display	57-1144

# StreetFX™

Drop shipped from Buztronics / Street FX



- Counter top spinner
- Holds approx. 32 pcs



- A variety of display boards available, see sales rep for details



- Floor spinner
- Holds approx. 64 pcs



## DISPLAY

Description	WPS#
Techmount slatwall display	571-display





- Display has 4 shelves
- Free standing

Drop shipped from Torco



Description	WPS#
A Counter display w/o demo headsets	<b>71-DISPLAY1</b>
B Slat wall merchandising kit	<b>16POS1</b>



Shipped from Venture

8" Video Monitor that is pre-loaded with a looping Venture product information video

## WPS

Brand:	
Size:	
Model:	
Part No:	
Price:	



### WPS TIRE LABELS



Description	WPS#
50 pk wraps	<b>87-LABEL</b>
100 pk stickers	<b>87-LABEL2</b>

- WINDSHIELDS / FAIRINGS
- AUDIO / COMMUNICATION
- SEATS / LUGGAGE
- BAR / MIRRORS / CONTROLS
- EXHAUST
- AIR / FUEL SYSTEMS
- ENGINE
- TRANSMISSION / DRIVELINE
- GASKETS / SEALS
- ELECTRICAL
- LIGHTING
- CABLES
- BRAKES
- OIL FILTERS
- SUSPENSION
- BODY
- WHEELS
- TIRES / TIRE ACC.
- BIKE ACC.
- VICTORY / INDIAN
- COVERS / LOCKS / TIEDOWNS
- CHEMICALS
- TOOLS
- HELMETS
- HELMET ACC.
- EYEWEAR
- APPAREL / RIDER ACC.
- PROMOTIONAL
- REFERENCE
- INDEX

WINDSHIELDS / FAIRINGS  
 AUDIO / COMMUNICATION  
 SEATS / LUGGAGE  
 BARS / MIRRORS / CONTROLS  
 EXHAUST  
 AIR / FUEL SYSTEMS  
 ENGINE  
 TRANSMISSION / DRIVELINE  
 GASKETS / SEALS  
 ELECTRICAL  
 LIGHTING  
 CABLES  
 BRAKES  
 OIL FILTERS  
 SUSPENSION  
 BODY  
 WHEELS  
 TIRES / TIRE ACC.  
 BIKE ACC.  
 VICTORY / INDIAN  
 COVERS / LOCKS / TIEDOWNS  
 CHEMICALS  
 TOOLS  
 HELMETS  
 HELMET ACC.  
 EYEWEAR  
 APPAREL / RIDER ACC.  
 PROMOTIONAL  
 REFERENCE  
 INDEX



## BATTERY DISPLAYS



Description	WPS #
Battery Rack Display (order sign separately, 490-FPSIGN)	490-RACK
Store Sign	490-FPSIGN



Description	WPS#
Cover Rack and Sign	27-RACK



- Full graphics on display highlights your Wizard's chemical area
  - Available in 2 or 4 shelf versions
- Easy to assemble

Description	WPS#
2 Shelf Display	57-DISPLAY2
4 Shelf Display	57-DISPLAY1



# YUASA BATTERY

- Free standing display
- No tools required for assembly
- Double sided display, 78" H x 29" W x 14" D
- Display includes; 2 header cards, 2 application charts, 2 literature holders, 6 peg hooks, and 200 Yuasa high performance sheets

Description	WPS#
Yuasa Display	49-9998



## 360 pc. SPINNER RACK

- Includes 1 spinner
- 5 tiers with 6 prongs each
- Each prong can hold up to 12 pcs
- Stands 5 feet tall

## 96 pc. SPINNER RACK

- Includes 1 spinner
- 2 tiers with 4 prongs each
- Each prong can hold up to 12 pcs
- Stands 4½ feet tall

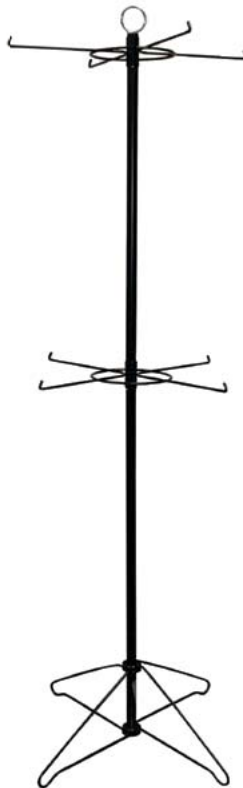

# ZANheadgear

Displays will come with a header card  
Header card may vary

*Drop shipped from ZanHeadgear*

Description	WPS#	Description	WPS#
360 pc display	26-ZAN4	Multi Display	26-ZAN6
96 pc display	26-ZAN5	Styro Head	26-HEAD

## MULTI DISPLAY

- 5.5 ft tall
- Spins and has 3 sides-perfect for multi-product display
- Comes with 18 hooks
- Includes plastic base, connection clips and sign holder
- Easy assembly; no hardware required
- Available in black

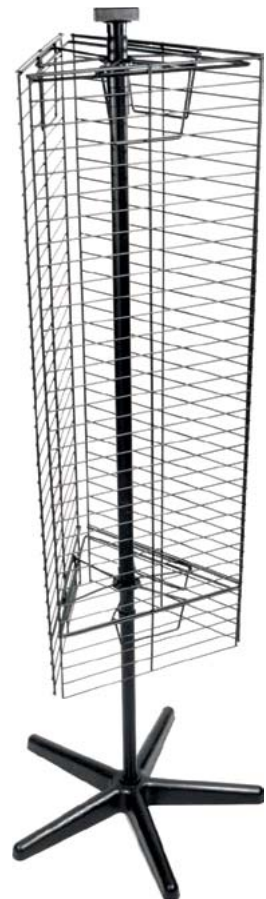

- WINDSHIELDS / FAIRINGS
- AUDIO / COMMUNICATION
- SEATS / LUGGAGE
- BAR / MIRRORS / CONTROLS
- EXHAUST
- AIR / FUEL SYSTEMS
- ENGINE
- TRANSMISSION / DRIVELINE
- GASKETS / SEALS
- ELECTRICAL
- LIGHTING
- CABLES
- BRAKES
- OIL FILTERS
- SUSPENSION
- BODY
- WHEELS
- TIRES / TIRE ACC.
- BIKE ACC.
- VICTORY / INDIAN
- COVERS / LOCKS / TIEDOWNS
- CHEMICALS
- TOOLS
- HELMETS
- HELMET ACC.
- EYEWEAR
- APPAREL / RIDER ACC.
- PROMOTIONAL
- REFERENCE
- INDEX



# MEN'S & LADIES' STREET GEAR SIZING CHARTS

### MENS Sizing Chart

- SLEEVE**  
Measure from the center of the spine at the base of the neck around the shoulder, over the elbow and down to the wrist
- CHEST**  
Measure around the broadest part of the chest, 1-2 inches below the armpits
- WAIST**  
Measure about 1 inch below the top of the pelvic bone
- INSEAM**  
Measure down from the crotch to the top of the ankle bone

### WOMENS Sizing Chart

- SLEEVE**  
Measure from the center of the spine at the base of the neck around the shoulder, over the elbow and down to the wrist
- BUST**  
Measure around the fullest part of the bust
- WAIST**  
Measure around the narrowest part of the waist
- HIP**  
Measure around the body halfway between the belly button and the crotch
- INSEAM**  
Measure down from the crotch to the top of the ankle bone

STANDARD JACKET	S	M	L	XL	2XL	3XL	4XL
SLEEVE	31-32"	32-33"	33-34"	34-35"	37"	37"	37"
CHEST	34-35"	36-38"	40-42"	44-46"	48-50"	52-54"	56-58"

TALL JACKET	M	L	XL	2XL	3XL
SLEEVE	34 1/2-35 1/2"	35 1/2-36 1/2"	36 1/2-37 1/2"	39 1/2"	39 1/2"
CHEST	36-38"	40-42"	44-46"	48-50"	52-54"

STANDARD PANTS	30	32	34	36	38	40
WAIST	30 1/2-32"	32 1/2-34"	34 1/2-36"	36 1/2-38"	38 1/2-40"	40 1/2-42"
INSEAM	29"	31"	32"	33"	33 1/2"	34"

SHORT PANTS	32s	34s	36s	38s	40s
WAIST	32 1/2-34"	34 1/2-36"	36 1/2-38"	38 1/2-40"	40 1/2-42"
INSEAM	28"	29"	30"	30 1/2"	31"

TALL PANTS	32t	34t	36t	38t	40t
WAIST	32 1/2-34"	34 1/2-36"	36 1/2-38"	38 1/2-40"	40 1/2-42"
INSEAM	34"	35"	36"	36 1/2"	37"

Sizing information does not guarantee a perfect fit. Please use this chart as a guide only

JACKET	XS	S	M	L	XL	2XL	3XL	4XL
SLEEVE	28"	29"	30"	31"	32"	33"	33"	33"
BUST	32"	35"	38"	41"	45"	49"	53"	57"
WAIST	24"	27"	29 1/2"	32 1/2"	36 1/2"	40 1/2"	44 1/2"	48 1/2"

PANTS	3-4	5-6	7-8	9-10	11-12	13-14	15-16
HIP	33"	36 1/2"	40"	42"	44"	46"	48"
INSEAM	28"	29"	30"	31"	31 1/2"	31 1/2"	31 1/2"

Sizing information does not guarantee a perfect fit. Please use this chart as a guide only

### BOOT Sizing Chart

US SIZE	EURO SIZE	UK SIZE	INCHES	CM
7	40	6.5	9.625"	24.4
8	41	7.5	9.9375"	25.4
9	42	8.5	10.25"	26
10	43	9.5	10.5625"	27
11	44	10.5	10.9375"	27.9
12	45	11.5	11.25"	28.6
13	46	12.5	11.5625"	29.4
14	47	13.5	11.875"	30.2

Sizing information does not guarantee a perfect fit. Please use this chart as a guide only

### GLOVE Sizing Chart

Glove size is measured at the widest part of your palm, just below the knuckles

	S	M	L	XL	2XL	3XL	4XL
<b>MENS</b>	2 3/4"	3 1/4"	3 3/4"	4 1/4"	4 3/4"	5 1/4"	5 3/4"
<b>WOMENS</b>	2 1/4"	2 3/4"	3 1/4"	3 3/4"	4 1/4"	4 3/4"	5 1/4"

Sizing information does not guarantee a perfect fit. Please use this chart as a guide only

GLOVE SIZING CHART

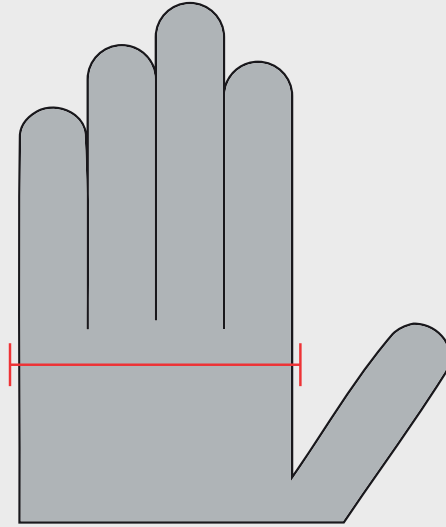

GLOVE SIZE IS MEASURED AT THE WIDEST PART OF YOUR PALM, JUST BELOW THE KNUCKLES.

<b>MENS</b>	<b>S</b>	<b>M</b>	<b>L</b>	<b>XL</b>	<b>2XL</b>	<b>3XL</b>	<b>4XL</b>
<b>INCHES</b>	<b>2 3/4</b>	<b>3 1/4</b>	<b>3 3/4</b>	<b>4 1/4</b>	<b>4 3/4</b>	<b>5 1/4</b>	<b>5 3/4</b>
<b>LADIES</b>	<b>S</b>	<b>M</b>	<b>L</b>	<b>XL</b>	<b>2XL</b>	<b>3XL</b>	<b>4XL</b>
<b>INCHES</b>	<b>2 1/4</b>	<b>2 3/4</b>	<b>3 1/4</b>	<b>3 3/4</b>	<b>4 1/4</b>	<b>4 3/4</b>	<b>5 1/4</b>



- WINDSHIELDS / FAIRINGS
- AUDIO / COMMUNICATION
- SEATS / LUGGAGE
- BARS / MIRRORS / CONTROLS
- EXHAUST
- AIR / FUEL SYSTEMS
- ENGINE
- TRANSMISSION / DRIVELINE
- GASKETS / SEALS
- ELECTRICAL
- LIGHTING
- CABLES
- BRAKES
- OIL FILTERS
- SUSPENSION
- BODY
- WHEELS
- TIRES / TIRE ACC.
- BIKE ACC.
- VICTORY / INDIAN
- COVERS / LOCKS / TIEDOWNS
- CHEMICALS
- TOOLS
- HELMETS
- HELMET ACC.
- EYEWEAR
- APPAREL / RIDER ACC.
- PROMOTIONAL
- REFERENCE**
- INDEX



# SIZING CHARTS

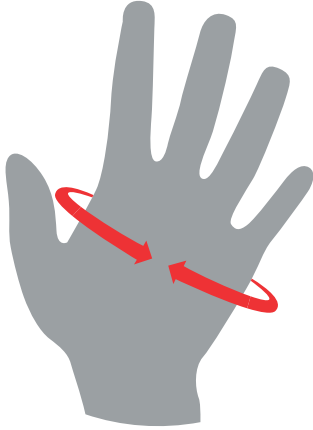

Measure the circumference around your hand at mid palm (just below the knuckles) using a soft tape measure.

Our high grade leather is designed to break in over time and will stretch out to fit your hand comfortably over the life of your gloves.

If you are between sizes, as a rule of thumb we recommend that you choose the larger of the two sizes.

### EXO-GLOVES SIZING CHART

GLOVE SIZE	XS	SM	MD	LG	XL	2XL	3XL
MEN'S CIRCUMFERENCE	5"	6"	7"	8"	9"	10"	11"
WOMEN'S CIRCUMFERENCE	5"	6"	7"	8"	9"	-	-

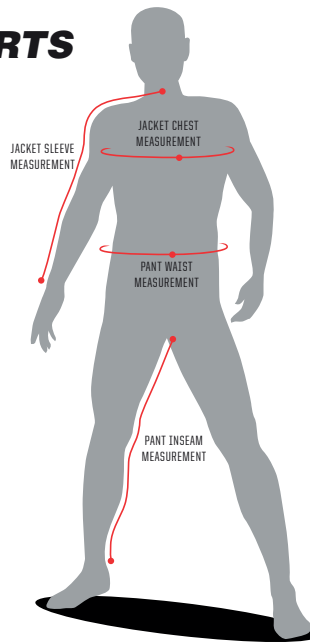

### MEN'S JACKETS

REGULAR	XS	SM	MD	LG	XL	2XL	3XL
CHEST	34-36"	36-38"	38-40"	42-44"	44-46"	46-48"	48-50"
SLEEVE	31"	32"	33"	34"	35"	36"	37"

TALL SIZES	LGT	XLT	2XLT	3XLT
SLEEVE	34-36"	35-37"	36-38"	37-39"

Tall sizes are 1.5" to 2" longer in both body length and sleeve length.

### MEN'S PANTS

	SM	MD	LG	XL	2XL	3XL
WAIST	30-31"	32-33"	34-35"	36-37"	38-39"	40-41"
INSEAM [REGULAR]	33"	33"	34"	34"	35"	35"
INSEAM [TALL]	35"	35"	36"	36"	37"	37"

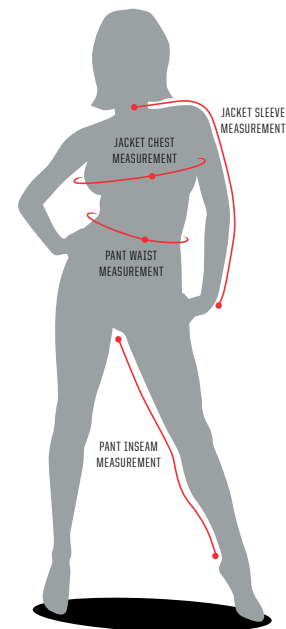

### WOMEN'S JACKETS

JACKET SIZE	XS	SM	MD	LG	XL	2XL
BUST	33"	34-35"	36-37"	38-40"	41-43"	45"
SLEEVE	29.5"	29.5-30"	30.5-31"	31.5-32"	32.5-33"	33.5-34"

### WOMEN'S PLUS SIZING

	1W	2W	3W
DRESS	16-18"	20-22"	24"
BUST	42-44"	46-48"	50-52"
WAIST	33-35"	37-39"	41-43"

### WOMEN'S PANTS

	XS	SM	MD	LG	XL	2XL
NATURAL WAIST	26-27"	28-29"	30-31"	32-33"	34-35"	36-37"
INSEAM	31"	32"	32"	33"	33"	34"

THE SIZING CHARTS ARE SIMPLY A STARTING GUIDE, AS BODY SHAPES VARY. FOR THE ULTIMATE BEST FIT, ALL APPAREL SHOULD BE FITTED TO YOU AT AN AUTHORIZED DEALER.



### HELMET SIZE CHART

SIZE	XS	SM	MD	LG	XL	2XL	3XL
CIRCUMFERENCE	20 <sup>7/8</sup> -21 <sup>1/4</sup>	21 <sup>5/8</sup> -22	22 <sup>7/16</sup> -22 <sup>3/4</sup>	23 <sup>1/8</sup> -23 <sup>5/8</sup>	24-24 <sup>3/8</sup>	24 <sup>3/4</sup> -25 <sup>3/16</sup>	25 <sup>9/16</sup> -26

THE SIZING CHART IS SIMPLY A STARTING GUIDE, AS HEAD SHAPES VARY. FOR THE BEST FIT, HELMETS SHOULD BE FITTED TO YOU BY AN AUTHORIZED DEALER.

### HELMET MEASUREMENT

Start by measuring the circumference around your head at the temple, just above the eyebrow line (approximately one inch above eyebrows) using a soft tape measure. Then select the helmet size that is closest to your head from the Size Chart below. If your head falls between two helmet sizes, first start by trying on the smaller of the two sizes.

### PROPER FITMENT

To help maximize head protection, your helmet must fit properly and be securely fastened under your chin. Your helmet should fit snug all the way around your head with no pressure points or shake. Consult your authorized SCORPION dealer for proper fitment. It is not only important for comfort, but for safety as well.

### HELMET HEAD SHAPES

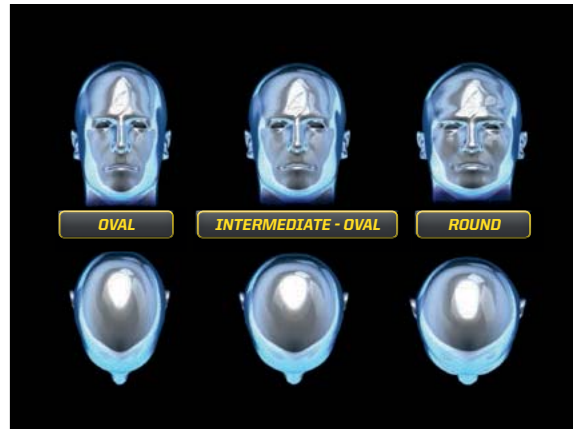

### HELMET MODEL SHELL SHAPE GUIDE

// OVAL	// INTERMEDIATE - OVAL	// ROUND
EXO-GT3000	EXO-T1200	EXO-CT220
EXO-R2000	EXO-AT950	EXO-C110
	EXO-GT920	BELFAST
	EXO-R710	VX-R70
	EXO-R510	VX-35
	EXO-R420	
	EXO-CT220	
	EXO-C110	
	BELFAST	
	VX-R70	
	VX-35	

This is a guideline for reference only. Please visit your local dealer to ensure the purchase of a proper fitting helmet.



# HARLEY-DAVIDSON MODEL IDENTIFICATION

WINDSHIELDS / FAIRINGS  
AUDIO / COMMUNICATION  
SEATS / LUGGAGE  
BARS / MIRRORS / CONTROLS  
EXHAUST  
AIR / FUEL SYSTEMS  
ENGINE  
TRANSMISSION / DRIVELINE  
GASKETS / SEALS  
ELECTRICAL  
LIGHTING  
CABLES  
BRAKES  
OIL FILTERS  
SUSPENSION  
BODY  
WHEELS  
TIRES / TIRE ACC.  
BIKE ACC.  
VICTORY / INDIAN  
COVERS / LOCKS / TIEDOWNS  
CHEMICALS  
TOOLS  
HELMETS  
HELMET ACC.  
EYEWEAR  
APPAREL / RIDER ACC.  
PROMOTIONAL  
REFERENCE  
INDEX

Designation	Model Name
<b>HARLEY-DAVIDSON</b>	
<b>TOURING</b>	
FLH	Electra Glide
FLHR	Road King
FLHRC	Road King Classic
FLHRS	Road King Custom
FLHRXS	Road King Special
FLHRSE	Screamin' Eagle Road King
FLHS	Electra Glide Sport
FLHT	Electra Glide Standard
FLHTC	Electra Glide Classic
FLHTCSE	Screamin' Eagle Electra Glide Classic
FLHTCU	Electra-Glide Ultra Classic
FLHTCUL	Electra Glide Ultra Classic Low
FLHTCUSE	Screamin' Eagle Ultra Classic
FLHTK	Ultra Limited
FLHTKL	Ultra Limited Low
FLHTKSE	CVO Limited
FLHX	Street Glide
FLHXS	Street Glide Special
FLHXSE	Screamin' Eagle Street Glide
FLHXSE	Street Glide CVO (2018)
FLT	Tour Glide
FLTC	Tour Glide
FLTCU	Tour Glide Ultra Classic
FLTR	Road Glide
FLTRSE	Screamin' Eagle Road Glide
FLTRU	Road Glide Ultra
FLTRX	Road Glide Custom, Road Glide (2015)
FLTRXS	Road Glide Special
FLTRXSE	Road Glide CVO
<b>TRIKE</b>	
FLHTCUTG	Tri-Glide Ultra Classic
FLHXXX	Street Glide Trike
FLTRT	Freewheeler
<b>SOFTAIL</b>	
FLDE	Softail Deluxe 107
FLFBS	Softail Fatboy 114
FLHC	Softail Heritage Classic 107
FLHCS	Softail Heritage Classic 114
FLSL	Softail Slim 107
FLSB	Softail Sport Glide 107
FXBR	Softail Breakout 107
FXBRS	Softail Breakout 114
FXFB	Softail Fat Bob 107
FXFBS	Softail Fat Bob 114
FXLR	Softail Low Rider 107
FLS	Softail Slim
FLSS	Softail Slim S
FLST	Heritage Softail
FLSTC	Heritage Softail Classic
FLSTF	Fat Boy
FLSTFS	Fat Boy S
FLSTFB	Fat Boy Lo
FLSTFSE	Screamin' Eagle Fat Boy
FLSTN	Heritage Softail Special, Nostalgia, Deluxe
FLSTNSE	Screamin' Eagle Deluxe
FLSTS	Heritage Springer Softail
FLSTSB	Softail Crossbones
FLSTSC	Softail Springer Classic
FLSTSE	Screamin' Eagle Convertible
FXCW	Rocker
FXCWC	Rocker C
FXBB	Softail Street Bob 107
FXS	Blackline
FXSB	Breakout
FXSBSE	Screamin' Eagle Breakout
FXSE	Pro Street Breakout
FXST	Softail Standard
FXSTB	Night Train
FXSTC	Softail Custom
FXSTD	Softail Duece
FXSTDSE	Screamin' Eagle Duece
FXSTS	Springer Softail
FXSTSB	Bad Boy
FXSTSSE	Screamin' Eagle Springer

Designation	Model Name
<b>DYNA/FXR</b>	
FLD	Dyna Switchback
FXB	Super Glide Sturgis
FXD	Dyna Super Glide
FXDB	Dyna Street Bob
FXDB-D	Dyna Glide Daytona-Belt
FXDB-S	Dyna Glide Sturgis-Belt
FXDC	Dyna Super Glide Custom
FXDF	Dyna Fat Bob
FXDFSE	Screamin' Eagle Fat Bob
FXDG	Dyna Glide Sturgis
FXDG	Wide Glide
FXDL	Dyna Low Rider
FXDLS	Dyna Lowrider S
FXDS-CONV	Dyna Glide Convertible
FXDSE	Screamin' Eagle Dyna
FXDWG	Dyna Wide Glide
FXDX	Dyna Super Glide Sport
FXDXT	Dyna Super Glide ST Sport
FXEF	Super Glide Fat Bob
FXLR	Low Rider Custom
FXLR-FX	Low Rider-Evolution
FXR	Super Glide Rubber Mount
FXRC	Low Glide Custom
FXRD	Sport Glide Grand Touring
FXRDG	Disc Glide
FXRP	Super Glide Police
FXRS	Super Glide Rubber Mount-Sport
FXRS-CONV	Low Rider Sport Convertible
FXRS-SP	Low Rider Sport
FXRT	FXR Touring-Sport Glide
FXRT/P	Sport Glide Police
FXS	Super Glide Low Rider
FXSB	Super Glide Low Rider-Belt
<b>SPORTSTER</b>	
XL	4-Speed 883 Sportster
XL1100	Standard 1100
XL1200	Standard 1200
XL1200C	1200 Custom
XL1200CP	1200 Custom
XL1200CX	1200 Roadster ('17-Up)
XL1200L	1200 Low
XL1200N	Nightster
XL1200R	1200 Roadster
XL1200S	1200 Sport
XL1200T	Super Low
XL1200V	Seventy-Two
XL1200X	Forty-Eight
XL883	883 Hugger
XL883C	883 Custom
XL883L	883 Low, Super Low
XL883N	Iron 883
XL883R	883 Roadster
XLCH	4-Speed 900cc Kick Start
XLCR	Caf Racer 1000
XLH1200	Standard 1200
XLH1200S	Sport
XLH883	883 Hugger
XLS	4-Speed Roadster
XLX	4-Speed 1000
XR1000	1000 w/ Competition Heads-Dual Carbs
XR1200	XR 1200
XR1200X	XR 1200
<b>STREET SERIES</b>	
YG500	Street 500
YG750	Street 750
YG750A	Street Rod 750
<b>V-ROD</b>	
VRSC	V-Rod
VRSCA	V-Rod w/ more options
VRSCAW	V-Rod 200mm rear tire
VRSCB	Basic V-Rod
VRSCD	Night Rod
VRSCDX	Night Rod Special
VRSCF	V-Rod Muscle
VRSCR	Street Rod
VRSCSE	Screamin' Eagle V-Rod

Designations containing SE are Screaming Eagle models (CVO)

# QUICK REFERENCE APPLICATION CHART

WINDSHIELDS / FAIRINGS  
AUDIO / COMMUNICATION  
SEATS / LUGGAGE  
BARS / MIRRORS / CONTROLS  
EXHAUST  
AIR / FUEL SYSTEMS  
ENGINE  
TRANSMISSION / DRIVE SHAFT  
GASKETS / SEALS  
ELECTRICAL  
LIGHTING  
CABLES  
BRAKES  
OIL FILTERS  
SUSPENSION  
BODY  
WHEELS  
TIRES / TIRE ACC.  
BIKE ACC.  
VICTORY / INDIAN  
COVERS / LOCKS / TIEDOWNS  
CHEMICALS  
TOOLS  
HELMETS  
HELMET ACC.  
EYEWEAR  
APPAREL / RIDER ACC.  
PROMOTIONAL  
REFERENCE  
INDEX

cid	cc	Model	Name	Year	NGK	Front Tire	Rear Tire	Battery
<b>HARLEY DAVIDSON</b>								
<b>TOURING</b>								
74	1200	FLH	Electra Glide	'55-64	R5670-5	MT90-16	MT90-16	
74	1200	FLH	Electra Glide	'70-74	R5670-5	MT90-16	MT90-16	YHD-12H
74	1200	FLH	Electra Glide	'75-78	BPR5ES-11	MT90-16	MT90-16	YHD-12H
74	1200	FLTC	Tour Glide Classic	'81-84	BPR5ES-11	MT90-16	MT90-16	YTX24HL-BS
80	1338	FLH	Electra Glide	'79	BPR5ES-11	MT90-16	MT90-16	YHD-12H
80	1338	FLH	Electra Glide	'80-83	BPR5ES-11	MT90-16	MT90-16	YTX24HL-BS
80	1340	FLH	Electra Glide	'84-85	BPR5ES-11	MT90-16	MT90-16	YTX24HL-BS
80	1340	FLHC	Electra Glide Classic	'79-81	BPR5ES-11	MT90-16	MT90-16	YHD-12H
80	1340	FLHR	Road King	'94-98	BPR5ES-11	MT90-16	MT90-16	YIX30L-BS
80	1340	FLHRC	Road King Classic	'98	BPR5ES-11	MT90-16	MT90-16	YIX30L-BS
80	1338	FLHS	Electra Glide Sport	'80-84	BPR5ES-11	MT90-16	MT90-16	YTX24HL-BS
80	1340	FLHS	Electra Glide Sport	'84-93	BPR5ES-11	MT90-16	MT90-16	YTX24HL-BS
80	1340	FLHT	Electra Glide	'86-87, '95-96	BPR5ES-11	MT90-16	MT90-16	YTX24HL-BS
80	1340	FLHT	Electra Glide	'97-98	BPR5ES-11	MT90-16	MT90-16	YIX30L-BS
80	1450	FLHT	Electra Glide	'04-06	DCPR7E	MT90-16	MU85-16	YIX30L-BS
80	1338	FLHTC	Electra Glide Classic	'83-84	BPR5ES-11	MT90-16	MT90-16	YTX24HL-BS
80	1340	FLHTC	Electra Glide Classic	'84-96	BPR5ES-11	MT90-16	MT90-16	YTX24HL-BS
80	1340	FLHTC	Electra Glide Classic	'97-98	BPR5ES-11	MT90-16	MT90-16	YIX30L-BS
80	1340	FLHTCU	Electra Glide Ultra Classic	'89-96	BPR5ES-11	MT90-16	MT90-16	YTX24HL-BS
80	1340	FLHTCU	Electra Glide Ultra Classic	'97-98	BPR5ES-11	MT90-16	MT90-16	YIX30L-BS
80	1340	FLHX	Electra Glide Special	'84-85	BPR5ES-11	MT90-16	MT90-16	YTX24HL-BS
80	1338	FLT	Tour Glide	'79-83	BPR5ES-11	MT90-16	MT90-16	YTX24HL-BS
80	1338	FLTC	Tour Glide Classic	'84-91	BPR5ES-11	MT90-16	MT90-16	YTX24HL-BS
80	1340	FLTCU	Tour Glide Ultra Classic	'89-96	BPR5ES-11	MT90-16	MT90-16	YTX24HL-BS
80	1340	FLTR	Road Glide	'98	DCPR7E	MT90-16	MU85-16	YIX30L-BS
88	1450	FLHR	Road King	'04-06	DCPR7E	MT90-16	MU85-16	YIX30L-BS
88	1450	FLHR	Road King	'99-03	DCPR7E	MT90-16	MT90-16	YIX30L-BS
88	1450	FLHRC	Road King Classic	'04-06	DCPR7E	MT90-16	MU85-16	YIX30L-BS
88	1450	FLHRC	Road King Classic	'99-03	DCPR7E	MT90-16	MT90-16	YIX30L-BS
88	1450	FLHRS	Road King Custom	'04-06	DCPR7E	MT90-16	MU85-16	YIX30L-BS
88	1450	FLHT	Electra Glide	'99-03	DCPR7E	MT90-16	MT90-16	YIX30L-BS
88	1450	FLHTC	Electra Glide Classic	'04-06	DCPR7E	MT90-16	MU85-16	YIX30L-BS
88	1450	FLHTC	Electra Glide Classic	'99-03	DCPR7E	MT90-16	MT90-16	YIX30L-BS
88	1450	FLHTCU	Electra Glide Ultra Classic	'04-06	DCPR7E	MT90-16	MU85-16	YIX30L-BS
88	1450	FLHTCU	Electra Glide Ultra Classic	'99-03	DCPR7E	MT90-16	MT90-16	YIX30L-BS
88	1450	FLHX	Street Glide	'06	DCPR7E	MT90-16	MU85-16	YIX30L-BS
88	1450	FLTR	Road Glide	'99-06	DCPR7E	MT90-16	MU85-16	YIX30L-BS
95	1550	FLHRSEI	CVO Screamin' Eagle Road King	'02	DCPR7E	MT90-16	MT90-16	YIX30L-BS
95	1550	FLTRSEI	CVO Screamin' Eagle Road Glide	'00-01	DCPR7E			YIX30L-BS
96	1584	FLHR	Road King	'07-08	DCPR7E	MT90-16	MU85-16	YIX30L-BS
96	1584	FLHR	Road King	'09-11	DCPR7E	130/80-17	180/65-16	YIX30L-BS
96	1584	FLHRC	Road King Classic	'07-08	DCPR7E	MT90-16	MU85-16	YIX30L-BS
96	1584	FLHRC	Road King Classic	'09-10	DCPR7E	130/90-16	180/65-16	YIX30L-BS
96	1584	FLHRS	Road King Custom	'07	DCPR7E	MT90-16	MU85-16	YIX30L-BS
96	1584	FLHT	Electra Glide	'07-09	DCPR7E	MT90-16	MU85-16	YIX30L-BS
96	1584	FLHTC	Electra Glide Classic	'07-08	DCPR7E	MT90-16	MU85-16	YIX30L-BS
96	1584	FLHTC	Electra Glide Classic	'09-11	DCPR7E	130/80-17	180/65-16	YIX30L-BS
96	1584	FLHTCU	Electra Glide Ultra Classic	'07-08	DCPR7E	MT90-16	MU85-16	YIX30L-BS
96	1584	FLHTCU	Electra Glide Ultra Classic	'09-11	DCPR7E	130/80-17	180/65-16	YIX30L-BS
96	1584	FLHX	Street Glide	'07-08	DCPR7E	MT90-16	MU85-16	YIX30L-BS
96	1584	FLHX	Street Glide	'09	DCPR7E	130/80-17	180/65-16	YIX30L-BS
96	1584	FLHX	Street Glide	'10-11	DCPR7E	130/70B18	180/65-16	YIX30L-BS
96	1584	FLTR	Road Glide	'07-08	DCPR7E	MT90-16	MU85-16	YIX30L-BS
96	1584	FLTR	Road Glide	'09	DCPR7E	130/80-17	180/65-16	YIX30L-BS
96	1584	FLTRX	Road Glide Custom	'10-11	DCPR7E	130/80-18	180/65-16	YIX30L-BS
103	1690	FLHR	Road King	'12-16	DCPR7E	130/80-17	180/65-16	YIX30L-BS
103	1690	FLHRC	Road King Classic	'11-13	DCPR7E	130/90-16	180/65-16	YIX30L-BS
103	1690	FLHRSEI2	CVO Screamin' Eagle Road King	'03	DCPR7E	MT90-16	MT90-16	YIX30L-BS
103	1690	FLHTC	Electra Glide Classic	'12-13	DCPR7E	130/80-17	180/65-16	YIX30L-BS
103	1690	FLHTCSE	CVO Screamin' Eagle Electra Glide	'04-05	DCPR7E	MT90-16	MU85-16	YIX30L-BS
103	1690	FLHTCU	Electra Glide Ultra Classic	'12-16	DCPR7E	130/80-17	180/65-16	YIX30L-BS
103	1690	FLHTCUL	Electra Glide Ultra Classic Low	'15-16	DCPR7E	130/80-17	180/65-16	YIX30L-BS
103	1690	FLHTCUSE	CVO Screamin' Eagle Ultra Classic Electra Glide	'06	DCPR7E	MT90-16	MU85-16	YIX30L-BS
103	1690	FLHTK	Electra Glide Ultra Limited	'10-16	DCPR7E	130/80-17	180/65-16	YIX30L-BS
103	1690	FLHTKL	Electra Glide Ultra Limited Low	'15-16	DCPR7E	130/80-17	180/65-16	YIX30L-BS
103	1690	FLHX	Street Glide	'12-13	DCPR7E	130/80-18	180/65-16	YIX30L-BS
103	1690	FLHX	Street Glide	'14-16	DCPR7E	130/60-19	180/65-16	YIX30L-BS
103	1690	FLHXS	Street Glide Special	'15-16	DCPR7E	130/60-19	180/65-16	YIX30L-BS
103	1690	FLTRU	Road Glide Ultra	'11-13, '16	DCPR7E	130/80-17	180/65-16	YIX30L-BS
103	1690	FLTRX	Road Glide Custom	12-13	DCPR7E	130/80-17	180/65-16	YIX30L-BS
103	1690	FLTRX	Road Glide	'15-16	DCPR7E	130/60-19	180/65-16	YIX30L-BS

This chart is for reference only - refer to appropriate application charts to order parts

**QUICK REFERENCE APPLICATION CHART**

cid	cc	Model	Name	Year	NGK	Front Tire	Rear Tire	Battery
<b>HARLEY DAVIDSON (CONT'D...)</b>								
<b>TOURING (CONT'D...)</b>								
103	1690	FLTRXS	Road Glide Special	'15-16	DCPR7E	130/60-19	180/65-16	Y1X30L-BS
107	1750	FLHR	Road King	'17-18	CR9E	130/80-17	180/65-16	Y1X30L-BS
107	1750	FLHRXS	Road King Special	'18	CR9E	130/60-19	180/55-18	Y1X30L-BS
107	1750	FLHX	Street Glide	'17-18	CR9E	130/60-19	180/65-16	Y1X30L-BS
107	1750	FLHXS	Street Glide Special	'17	CR9E	130/60-19	180/65-16	Y1X30L-BS
107	1750	FLHXS	Street Glide Special	'18	CR9E	130/60-19	180/55-18	Y1X30L-BS
107	1750	FLTR	Road Glide	'17-18	CR9E	130/60-19	180/65-16	Y1X30L-BS
107	1750	FLTRS	Road Glide Special	'17	CR9E	130/60-19	180/65-16	Y1X30L-BS
107	1750	FLTRXS	Road Glide Special	'18	CR9E	130/60-19	180/55-18	Y1X30L-BS
107	1750	FLTRU	Road Glide Ultra	'17-18	CR9E	130/80-17	180/65-16	Y1X30L-BS
107	1750	FLHTCU	Electra Glide Ultra Classic	'17-18	CR9E	130/80-17	180/65-16	Y1X30L-BS
107	1750	FLHTK	Electra Glide Ultra Limited	'17-18	CR9E	130/80-17	180/65-16	Y1X30L-BS
107	1750	FLHTKL	Electra Glide Ultra Limited Low	'17-18	CR9E	130/80-17	180/65-16	Y1X30L-BS
110	1803	FLHRSE3	CVO Screamin' Eagle Road King	'07-08	DCPR7E	130/70-18	170/60-17	Y1X30L-BS
110	1803	FLHRSE5	CVO Screamin' Eagle Road King	'13-14	DCPR7E	130/60-19	180/55-18	Y1X30L-BS
110	1803	FLHTCUSE	CVO Screamin' Eagle Ultra Classic Electra Glide	'07-08	DCPR7E	MT90-16	MU85-16	Y1X30L-BS
110	1803	FLHTCUSE	CVO Ultra Classic Electra Glide	'09-13	DCPR7E	130/80-17	180/65-16	Y1X30L-BS
110	1803	FLHTKSE	CVO Limited	'14-16	DCPR7E	130/80-17	180/65-16	Y1X30L-BS
110	1803	FLHXSE	CVO Street Glide	'10-12, '15-16	DCPR7E	130/60-19	180/55-18	Y1X30L-BS
110	1803	FLTRSE3	CVO Road Glide	'09	DCPR7E	130/70-18	180/55-18	Y1X30L-BS
110	1803	FLTRUSE	CVO Road Glide Ultra	'11	DCPR7E	130/70-18	180/55-18	Y1X30L-BS
110	1803	FLTRUSE	CVO Road Glide Ultra	'15-16	DCPR7E	130/80-17	180/65-16	Y1X30L-BS
110	1803	FLTRXSE	CVO Road Glide Custom	'12-13	DCPR7E	130/60-19	180/55-18	Y1X30L-BS
114	1868	FLHXSE	CVO Street Glide	'17	CR9E	130/60-19	180/55-18	Y1X30L-BS
114	1868	FLHTKSE	CVO Limited	'17	CR9E	130/80-17	180/65-16	Y1X30L-BS
117	1923	FLHTKSE	CVO Limited	'18	CR9E	130/80-17	180/65-16	Y1X30L-BS
117	1923	FLTRXSE	CVO Road Glide	'18	CR9E	130/60-21	180/55-18	Y1X30L-BS
117	1923	FLHXSE	CVO Street Glide	'18	CR9E	130/60-19	180/55-18	Y1X30L-BS
<b>TRIKE</b>								
103	1690	FLHTCUTG	Tri Glide Ultra Classic	'09-16	DCPR7E	MT90-16	P205/65-15	Y1X30L-BS
103	1690	FLHTXXX	Street Glide Trike	'10-11	DCPR7E	MT90-16	P205/65-15	Y1X30L-BS
103	1690	FLTRT	Freewheeler	'15-16	DCPR7E	MT90-16	P205/65-15	Y1X30L-BS
107	1750	FLTRT	Freewheeler	'17-18	CR9E	130/60-19	P205/65-15	Y1X30L-BS
107	1750	FLHTCUTG	Tri Glide Ultra Classic	'17-18	CR9E	MT90-16	P205/65-15	Y1X30L-BS
<b>SOFTAIL</b>								
80	1340	FLST	Heritage Softail	'86-90	BPR5ES-11	MT90-16	MT90-16	YTX20L-BS
80	1340	FLSTC	Heritage Softail Classic	'88-90	BPR5ES-11	MT90-16	MT90-16	YTX20L-BS
80	1340	FLSTC	Heritage Softail Classic	'91-97	BPR5ES-11	MT90-16	MT90-16	YTX20L-BS
80	1340	FLSTF	Softail Fat Boy	'90-98	BPR5ES-11	MT90-16	MT90-16	YTX20L-BS
80	1340	FLSTS	Softail Heritage Springer	'97-98	BPR5ES-11	MT90-16	MT90-16	YTX20L-BS
80	1340	FXST	Softail Standard	'84-90	BPR5ES-11	MH90-21	130/90-16	YTX20L-BS
80	1340	FXSTC	Softail Custom	'86-90	BPR5ES-11	MH90-21	MT90-16	YTX20L-BS
80	1340	FXSTC	Softail Custom	'91-98	BPR5ES-11	MH90-21	MT90-16	YTX20L-BS
80	1340	FXSTS	Springer Softail	'88-90	BPR5ES-11	MH90-21	MT90-16	YTX20L-BS
80	1340	FXSTS	Springer Softail	'91-98	BPR5ES-11	MH90-21	MT90-16	YTX20L-BS
80	1340	FXSTSB	Softail Bad Boy	'95-97	BPR5ES-11	100/90-19	130/90-16	YTX20L-BS
88	1450	FLST	Heritage Softail	'06	DCPR7E	MT90-16	150/80-16	YTX20L-BS
88	1450	FLSTC	Heritage Softail Classic	'03-06	DCPR7E	MT90-16	150/80-16	YTX20L-BS
88	1450	FLSTC	Heritage Softail Classic	'99-02	DCPR7E	MT90-16	MT90-16	YTX20L-BS
88	1450	FLSTF	Softail Fat Boy	'04-06	DCPR7E	MT90-16	150/80-16	YTX20L-BS
88	1450	FLSTF	Softail Fat Boy	'99-03	DCPR7E	MT90-16	MT90-16	YTX20L-BS
88	1450	FLSTN	Softail Deluxe	'05-06	DCPR7E	MT90-16	MU85-16	YTX20L-BS
88	1450	FLSTS	Softail Heritage Springer	'03	DCPR7E	MT90-16	MU85-16	YTX20L-BS
88	1450	FLSTS	Softail Heritage Springer	'99-02	DCPR7E	MT90-16	MT90-16	YTX20L-BS
88	1450	FLSTSC	Softail Springer Classic	'05-06	DCPR7E	MT90-16	150/80-16	YTX20L-BS
88	1450	FXST	Softail Standard	'03-05	DCPR7E	MH90-21	150/80-16	YTX20L-BS
88	1450	FXST	Softail Standard	'06	DCPR7E	MH90-21	200/55-17	YTX20L-BS
88	1450	FXST	Softail Standard	'99-02	DCPR7E	MH90-21	130/90-16	YTX20L-BS
88	1450	FXSTB	Softail Night Train	'03-05	DCPR7E	MH90-21	150/80-16	YTX20L-BS
88	1450	FXSTB	Softail Night Train	'06	DCPR7E	MH90-21	200/55-17	YTX20L-BS
88	1450	FXSTB	Softail Night Train	'99-02	DCPR7E	MH90-21	130/90-16	YTX20L-BS
88	1450	FXSTC	Softail Custom	'99	BPR5ES-11	MH90-21	MT90-16	YTX20L-BS
88	1450	FXSTD	Softail Deuce	'00-06	DCPR7E	MH90-21	160/70-17	YTX20L-BS
88	1450	FXSTS	Springer Softail	'00-02	DCPR7E	MH90-21	MT90-16	YTX20L-BS
88	1450	FXSTS	Springer Softail	'03-05	DCPR7E	MH90-21	150/80-16	YTX20L-BS
88	1450	FXSTS	Springer Softail	'06	DCPR7E	MH90-21	200/55-17	YTX20L-BS
88	1450	FXSTS	Springer Softail	'99	BPR5ES-11	MH90-21	MT90-16	YTX20L-BS
95	1550	FXSTDSE	CVO Screamin' Eagle Softail Deuce	'03-04	DCPR7E	MH90-21	160/70-17	YTX20L-BS
96	1584	FLSTC	Heritage Softail Classic	'07-11	DCPR7E	MT90-16	150/80-16	YTX20L-BS
96	1584	FLSTF	Softail Fat Boy	'07-11	DCPR7E	140/75-17	200/55-17	YTX20L-BS
96	1587	FLSTFB	Softail Fat Boy Lo	'10-11	DCPR7E	140/75-17	200/55-17	YTX20L-BS

**This chart is for reference only - refer to appropriate application charts to order parts**

- WINDSHIELDS / FAIRINGS
- AUDIO / COMMUNICATION
- SEATS / LUGGAGE
- BARS / MIRRORS / CONTROLS
- EXHAUST
- AIR / FUEL SYSTEMS
- ENGINE
- TRANSMISSION / DRIVELINE
- GASKETS / SEALS
- ELECTRICAL
- LIGHTING
- CABLES
- BRAKES
- OIL FILTERS
- SUSPENSION
- BODY
- WHEELS
- TIRES / TIRE ACC.
- BIKE ACC.
- VICTORY / INDIAN
- COVERS / LOCKS / TIEDOWNS
- CHEMICALS
- TOOLS
- HELMETS
- HELMET ACC.
- EYEWEAR
- APPAREL / RIDER ACC.
- PROMOTIONAL
- REFERENCE
- INDEX

# QUICK REFERENCE APPLICATION CHART

	cid	cc	Model	Name	Year	NGK	Front Tire	Rear Tire	Battery
	<b>HARLEY DAVIDSON (CONT'D...)</b>								
	<b>SOFTAIL (CONT'D...)</b>								
	96	1584	FLSTN	Softail Deluxe	'07-11	DCPR7E	MT90-16	MU85-16	YTX20L-BS
	96	1584	FLSTSB	Softail Cross Bones	'08-11	DCPR7E	MT90-16	200/55-17	YTX20L-BS
	96	1584	FLSTSC	Softail Springer Classic	'07	DCPR7E	MT90-16	150/80-16	YTX20L-BS
	96	1584	FXCW	SoftailRocker	'08-09	DCPR7E	90/90-19	240/40-18	YTX20L-BS
	96	1584	FXCWC	Softail Rocker C	'08	DCPR7E	MH90-21	200/55-17	YTX20L-BS
	96	1584	FXCWC	Softail Rocker C	'09-11	DCPR7E	90/90-19	240/40-18	YTX20L-BS
	96	1584	FXS	Softail Blackline	'11	DCPR7E	MH90-21	MU85-16	YTX20L-BS
	96	1584	FXST	Softail Standard	'07	DCPR7E	MH90-21	200/55-17	YTX20L-BS
	96	1584	FXSTB	Softail Night Train	'07-09	DCPR7E	MH90-21	200/55-17	YTX20L-BS
	96	1584	FXSTC	Softail Custom	'07-10	DCPR7E	MH90-21	200/55-17	YTX20L-BS
	96	1584	FXSTD	Softail Deuce	'07	DCPR7E	MH90-21	160/70-17	YTX20L-BS
	103	1690	FLS	Softail Slim	'12-17	DCPR7E	MT90-16	MU85-16	YTX20L-BS
	103	1690	FLSTC	Heritage Softail Classic	'12-17	DCPR7E	MT90-16	150/80-16	YTX20L-BS
	103	1690	FLSTF	Softail Fat Boy	'12-17	DCPR7E	140/75-17	200/55-17	YTX20L-BS
	103	1690	FLSTFB	Softail Fat Boy Lo	'12-16	DCPR7E	140/75-17	200/55-17	YTX20L-BS
	103	1690	FLSTFSE	CVO Screamin' Eagle Fat Boy	'05	DCPR7E	MT90-16	150/80-16	YTX20L-BS
	103	1690	FLSTFSE2	CVO Screamin' Eagle Fat Boy	'06	DCPR7E	140/75-17	200/55-17	YTX20L-BS
	103	1690	FLSTN	Softail Deluxe	'12-17	DCPR7E	MT90-16	MU85-16	YTX20L-BS
	103	1690	FXS	Softail Blackline	'12-13	DCPR7E	MH90-21	MU85-16	YTX20L-BS
	103	1690	FXSB	Softail Breakout	'13-17	DCPR7E	130/60/21	240/40/18	YTX20L-BS
	107	1750	FXBB	Softail Street Bob	'18	CR9E	100/90-19	150/80-16	YTX20L-BS
	107	1750	FXFB	Softail Fat Bob	'18	CR9E	150/80-16	180/70-16	YTX20L-BS
	107	1750	FXBR	Softail Breakout	'18	CR9E	130/60-21	240/40-18	YTX20L-BS
	107	1750	FLSL	Softail Slim	'18	CR9E	130/90-16	150/80-16	YTX20L-BS
	107	1750	FXLR	Softail Low Rider	'18	CR9E	110/90-19	180/70-16	YTX20L-BS
	107	1750	FLFB	Softail Fat Boy	'18	CR9E	160/60-18	240/40-18	YTX20L-BS
	107	1750	FLHC	Softail Heritage Classic	'18	CR9E	130/90-16	150/80-16	YTX20L-BS
	107	1750	FLSB	Softail Sport Glide	'18	CR9E	130/80-16	180/70-16	YTX20L-BS
	110	1803	FLSS	Softail Slim S	'16-17	DCPR7E	MT90-16	MU85-16	YTX20L-BS
	110	1803	FLSTFS	Softail Fat Boy S	'16-17	DCPR7E	140/75-17	200/55-17	YTX20L-BS
	110	1803	FLSTNSE	CVO Softail Deluxe	'14-15	DCPR7E	MT90-16	MU85-16	YTX20L-BS
	110	1803	FLSTSE	CVO Softail Convertible	'10-12	DCPR7E	130/70-18	200/50-18	YTX20L-BS
	110	1803	FXSBSE	CVO Breakout	'13-14	DCPR7E	130/60-21	240/40-18	YTX20L-BS
	110	1803	FXSE	CVO Breakout Pro Street	'16-17	DCPR7E	130/60-19	240/40-18	YTX20L-BS
	110	1803	FXSTSSE	CVO Screamin' Eagle Softail Springer	'07	DCPR7E	MH90-21	200/55-17	YTX20L-BS
	110	1803	FXSTSSE2	CVO Screamin' Eagle Softail Springer	'08	DCPR7E	130/70-18	200/55-17	YTX20L-BS
	110	1803	FXSTSSE3	CVO Softail Springer	'09	DCPR7E	130/70-18	240/55-18	YTX20L-BS
	114	1868	FXFBS	Softail Fat Bob	'18	CR9E	150/80-16	180/70-16	YTX20L-BS
	114	1868	FXBRS	Softail Breakout	'18	CR9E	130/60-21	240/40-18	YTX20L-BS
	114	1868	FLFBS	Softail Fat Boy	'18	CR9E	160/60-18	240/40-18	YTX20L-BS
	114	1868	FLHCS	Softail Heritage Classic	'18	CR9E	130/90-16	150/80-16	YTX20L-BS
	<b>DYNA/FXR</b>								
	74	1200	FX	Dyna Super Glide	'71-74	R5670-5			YTX20-BS
	74	1200	FX	Dyna Super Glide	'75-78	BPR5ES-11			YTX20-BS
	74	1200	FXE	Dyna Super Glide	'74	R5670-5			YTX20-BS
	74	1200	FXE	Dyna Super Glide	'75-78	BPR5ES-11			YTX20-BS
	74	1200	FXS	Dyna Low Rider	'77-78	BPR5ES-11			YTX20-BS
	74	1200	FXSB	Dyna Low Rider - Belt	'83-84	BPR5ES-11			YTX20-BS
	74	1200	FXWG	Dyna Wide Glide	'80-84	BPR5ES-11	MH90-21	MT90-16	YTX20-BS
	80	1340	FXB	Dyna Sturgis	'80-82	BPR5ES-11			YTX20-BS
	80	1340	FXD	Dyna Super Glide	'95-98	BPR5ES-11	100/90-19	130/90-16	YTX20L-BS
	80	1340	FXDB-D	Dyna Glide Daytona	'92	BPR5ES-11	100/90-19	MT90-16	YTX20L-BS
	80	1340	FXDB-S	Dyna Glide Sturgis	'91	BPR5ES-11	100/90-19	MT90-16	YTX20L-BS
	80	1340	FXDC	Dyna Super Glide Custom	'92	DCPR7E	100/90-19	160/70-17	YTX20L-BS
	80	1340	FXDG	Disc Glide	'83	BPR5ES-11	MT90-16	MT90-16	YTX24HL-BS
	80	1340	FXDL	Dyna Low Rider	'93-98	BPR5ES-11	100/90-19	130/90-16	YTX20L-BS
	80	1340	FXDS-Conv	Dyna Convertible	'94-98	BPR5ES-11	100/90-19	130/90-16	YTX20L-BS
	80	1340	FXDWG	Dyna Wide Glide	'93-98	BPR5ES-11	MH90-21	130/90-16	YTX20L-BS
	80	1340	FXE	Dyna Super Glide	'79-84	BPR5ES-11			YTX20-BS
	80	1340	FXEF	Dyna Fat Bob	'79-81, '85	BPR5ES-11			YTX20-BS
	80	1340	FXLR	Low Rider Custom	'87-94	BPR5ES-11	100/90-19	MT90-16	YTX20L-BS
	80	1340	FXR	Super Glide II	'82-83	BPR5ES-11	100/90-19	MT90-16	YTX20-BS
	80	1340	FXR	Super Glide II	'86-94	BPR5ES-11	100/90-19	MT90-16	YTX20-BS
	80	1340	FXRC	Low Rider Chrome	'85, '87	BPR5ES-11			YTX20-BS
	80	1340	FXRD	Sport Glide Grand Touring	'86	BPR5ES-11			YTX20-BS
	80	1340	FXRDG	Disc Glide	'84	BPR5ES-11	MT90-16	MT90-16	YTX24HL-BS
	80	1340	FXRS	Low Glide	'82-84	BPR5ES-11	MJ90-19	MT90-16	YTX20-BS
	80	1340	FXRS	Low Glide	'84-91	BPR5ES-11	MJ90-19	MT90-16	YTX20-BS
	80	1340	FXRS	Low Glide	'92	BPR5ES-11	100/90-19	130/90-16	YTX20-BS
	80	1340	FXRS-Conv	Low Rider Sport Convertible	'90-91	BPR5ES-11	MJ90-19	MT90-16	YTX20-BS

This chart is for reference only - refer to appropriate application charts to order parts

**QUICK REFERENCE APPLICATION CHART**

cid	cc	Model	Name	Year	NGK	Front Tire	Rear Tire	Battery
<b>HARLEY DAVIDSON (CONT'D...)</b>								
<b>DYNA/FXR (CONT'D...)</b>								
80	1340	FXRS-Conv	Low Rider Sport Convertible	'92-93	BPR5ES-11	100/90-19	130/90-19	YTX20-BS
80	1340	FXRS-SP	Low Rider Sport	'86-91	BPR5ES-11			YTX20-BS
80	1340	FXRS-SP	Low Rider Sport	'92-93	BPR5ES-11	100/90-19	130/90-16	YTX20-BS
80	1340	FXRT	Sport Glide	'83-84	BPR5ES-11	100/90-19	MT90-16	YTX20-BS
80	1340	FXRT	Sport Glide	'84-92	BPR5ES-11	100/90-19	MT90-16	YTX20-BS
80	1340	FXS	Low Rider	'79-82	BPR5ES-11			YTX20-BS
80	1340	FXSB	Low Rider - Belt	'84-85	BPR5ES-11			YTX20-BS
80	1340	FXWG	Wide Glide	'84-86	BPR5ES-11	MH90-21	MT90-16	YTX20-BS
88	1450	FXD	Dyna Super Glide	'02-05	DCPR7E	100/90-19	150/80-16	YTX20L-BS
88	1450	FXD	Dyna Super Glide	'06	DCPR7E	100/90-19	160/70-17	YTX20L-BS
88	1450	FXD	Dyna Super Glide	'99-01	DCPR7E	100/90-19	130/90-16	YTX20L-BS
88	1450	FXDB	Dyna Street Bob	'06	DCPR7E	100/90-19	160/70-17	YTX20L-BS
88	1450	FXDC	Dyna Super Glide Custom	'05-06	DCPR7E	100/90-19	160/70-17	YTX20L-BS
88	1450	FXDI35	Dyna 35th Anniversary Super Glide	'06	DCPR7E	100/90-19	160/70-17	YTX20L-BS
88	1450	FXDL	Dyna Low Rider	'02-05	DCPR7E	100/90-19	150/80-16	YTX20L-BS
88	1450	FXDL	Dyna Low Rider	'06	DCPR7E	100/90-19	160/70-17	YTX20L-BS
88	1450	FXDL	Dyna Low Rider	'99-01	DCPR7E	100/90-19	130/90-16	YTX20L-BS
88	1450	FXDS-Conv	Dyna Convertible	'99-00	BPR5ES-11	100/90-19	130/90-16	YTX20L-BS
88	1450	FXDWG	Dyna Wide Glide	'02-05	DCPR7E	MH90-21	150/80-16	YTX20L-BS
88	1450	FXDWG	Dyna Wide Glide	'06	DCPR7E	MH90-21	160/70-17	YTX20L-BS
88	1450	FXDWG	Dyna Wide Glide	'99-01	DCPR7E	MH90-21	130/90-16	YTX20L-BS
88	1450	FXDX	Dyna Super Glide Sport	'02-05	DCPR7E	100/90-19	150/80-16	YTX20L-BS
88	1450	FXDX	Dyna Super Glide Sport	'99-01	DCPR7E	100/90-19	130/90-16	YTX20L-BS
88	1450	FXDXT	Dyna Super Glide T-Sport	'01	DCPR7E	100/90-19	130/90-16	YTX20L-BS
88	1450	FXDXT	Dyna Super Glide T-Sport	'02-03	DCPR7E	100/90-19	150/80-16	
88	1450	FXR2		'99	DCPR7E	MH90-21	130/90-16	YTX20L-BS
88	1450	FXR3		'99	DCPR7E	MH90-21	130/90-16	YTX20L-BS
88	1450	FXR4		'00	DCPR7E			YTX20L-BS
96	1584	FXD	Dyna Super Glide	'07-10	DCPR7E	100/90-19	160/70-17	YTX20L-BS
96	1584	FXDB	Dyna Street Bob	'07-13	DCPR7E	100/90-19	160/70-17	YTX20L-BS
96	1584	FXDC	Dyna Super Glide Custom	'07-13	DCPR7E	100/90-19	160/70-17	YTX20L-BS
96	1584	FXDF	Dyna Fat Bob	'08-11	DCPR7E	130/90-16	180/70-16	YTX20L-BS
96	1584	FXDL	Dyna Low Rider	'07-09	DCPR7E	100/90-19	160/70-17	YTX20L-BS
96	1584	FXDWG	Dyna Wide Glide	'07-08	DCPR7E	MH90-21	160/70-17	YTX20L-BS
96	1584	FXDWG	Dyna Wide Glide	'10-11	DCPR7E	80/90-21	180/60-17	YTX20L-BS
103	1690	FLD	Dyna Switchback	'12-16	DCPR7E	130/70-18	160/70-17	YTX20L-BS
103	1690	FXDB	Dyna Street Bob	'14-17	DCPR7E	100/90-19	160/70-17	YTX20L-BS
103	1690	FXDC	Dyna Super Glide Custom	'14	DCPR7E	100/90-19	160/70-17	YTX20L-BS
103	1690	FXDF	Dyna Fat Bob	'12-17	DCPR7E	130/90-16	180/70-16	YTX20L-BS
103	1690	FXDL	Dyna Low Rider	'15-17	DCPR7E	100/90-19	160/70-17	YTX20L-BS
103	1690	FXDWG	Dyna Wide Glide	'12-17	DCPR7E	80/90-21	180/60-17	YTX20L-BS
110	1803	FXDLS	Dyna Lowrider S	'16-17	DCPR7E	100/90-19	160/70-17	YTX20L-BS
110	1803	FXDFSE	CVO Dyna Fat Bob	'09-10	DCPR7E	130/90-16	180/70-16	YTX20L-BS
110	1803	FXDSE	CVO Screamin' Eagle Dyna	'07-08	DCPR7E	MH90-21	170/60-17	YTX20L-BS
<b>SPORTSTER</b>								
53	883	XL883	Sportster	'04-08	DCPR7E	100/90-19	150/80-16	YTX14L-BS
53	883	XL883C	Sportster 883 Custom	'04-09	DCPR7E	MH90-21	150/80-16	YTX14L-BS
53	883	XL883C	Sportster 883 Custom	'99-03	DCPR7E	100/90-19	130/90-16	YTX20L-BS
53	883	XL883L	Sportster 883 Low/SuperLow	'05-10	DCPR7E	100/90-19	150/80-16	YTX14L-BS
53	883	XL883L	Sportster 883 SuperLow	'11-18	DCPR7E	120/70-18	150/60-17	YTX14L-BS
53	883	XL883N	Sportster Iron 883	'09-18	DCPR7E	100/90-19	150/80-16	YTX14L-BS
53	883	XL883R	Sportster 883 Roadster	'02-07	DCPR7E	100/90-19	130/90-16	YTX14L-BS
53	883	XLH883	Sportster	'86-96	DCPR7E	100/90-19	130/90-16	YTX20-BS
53	883	XLH883DLX	Sportster 883 Deluxe	'86-95	DCPR7E	100/90-19	130/90-16	YTX20-BS
53	883	XLH883HUG	Sportster 883 Hugger	'87-96	DCPR7E	100/90-19	130/90-16	YTX20-BS
53	883	XLH883HUG	Sportster 883 Hugger	'97-03	DCPR7E	100/90-19	130/90-16	YTX20L-BS
53	883	XLH883	Sportster	'97-03	DCPR7E	100/90-19	130/90-16	YTX20L-BS
55	900	XL	Sportster	'57-59	B6L			
55	900	XLCH	Sportster	'58	B6L			
55	900	XLCH	Sportster	'58-71	B6L			12N7-4A
55	900	XLH900	Sportster	'58-71	B6L			
55	900	XLR	Sportster	'59-60	B6L			
55	900	XLRTT	Sportster	'58-64	B6L			
55	900	XR	Sportster	'69-70	B6L			
61	1000	XLCH	Sportster	'71-78	B6L			12N7-4A
61	1000	XLCH	Sportster	'79	BPR6HS-10			12N7-4A
61	1000	XLCR	Sportster Cafe Racer	'77-78	B6L			YTX20-BS
61	1000	XLH1000	Sportster	'72-78	B6L			YHD-12H
61	1000	XLH1001	Sportster	'79-85	BPR6HS-10			YHD-12H
61	1000	XLS	Sportster Roadster	'78	B6L			YTX20-BS
61	1000	XLS	Sportster Roadster	'79-85	BPR6HS-10			YTX20-BS
61	1000	XLT	Sportster	'77-78	B6L			YTX20-BS
61	1000	XLX 1000	Sportster	'83-85	BPR6HS-10			YTX20-BS
61	1000	XR	Sportster	'74-75	B6L			

WINDSHIELDS / FAIRINGS  
AUDIO / COMMUNICATION  
SEATS / LUGGAGE  
BARS / MIRRORS / CONTROLS  
EXHAUST  
AIR / FUEL SYSTEMS  
ENGINE  
TRANSMISSION / DRIVELINE  
GASKETS / SEALS  
ELECTRICAL  
LIGHTING  
CABLES  
BRAKES  
OIL FILTERS  
SUSPENSION  
BODY  
WHEELS  
TIRES / TIRE ACC.  
BIKE ACC.  
VICTORY / INDIAN  
COVERS / LOCKS / TIEDOWNS  
CHEMICALS  
TOOLS  
HELMETS  
HELMET ACC.  
EYEWEAR  
APPAREL / RIDER ACC.  
PROMOTIONAL  
REFERENCE  
INDEX

**QUICK REFERENCE APPLICATION CHART**

	cid	cc	Model	Name	Year	NGK	Front Tire	Rear Tire	Battery
	<b>HARLEY DAVIDSON (CONT'D...)</b>								
	<b>SPORTSTER (CONT'D...)</b>								
WINDSHIELDS / FAIRINGS	61	1000	XR1000	Sportster	'83-85	BPR6HS-10			YTX20-BS
AUDIO / COMMUNICATION	67	1100	XLH1100	Sportster	'86-87	DCPR7E			YTX20-BS
SEATS / LUGGAGE	73	1200	XL1200C	Sportster 1200 Custom	'04-10	DCPR7E	MH90-21	150/80-16	YTX14L-BS
BARS / MIRRORS / CONTROLS	73	1200	XL1200C	Sportster 1200 Custom	'11-18	DCPR7E	130/90-16	150/80-16	YTX14L-BS
EXHAUST	73	1200	XL1200C	Sportster 1200 Custom	'96-03	DCPR7E	MH90-21	130/90-16	YTX20L-BS
AIR / FUEL SYSTEMS	73	1200	XL1200L	Sportster 1200 Low	'06-11	DCPR7E	100/90-19	150/80-16	YTX14L-BS
ENGINE	73	1200	XL1200N	Sportster 1200 Nightster	'07-12	DCPR7E	100/90-19	150/80-16	YTX14L-BS
TRANSMISSION / DRIVE SHAFT	73	1200	XL1200R	Sportster 1200 Roadster	'04-08	DCPR7E	100/90-19	150/80-16	YTX14L-BS
GASKETS / SEALS	73	1200	XL1200CX	Sportster 1200 Roadster	'17-18	DCPR7E	120/70-19	150/70-18	YTX14L-BS
ELECTRICAL	73	1200	XL1200S	Sportster 1200 Sport	'96-03	DCPR7E	100/90-20	130/90-16	YTX20L-BS
LIGHTING	73	1200	XL1200T	Sportster 1200 Super Low T	'15-17	DCPR7E	120/70-18	150/70-17	YTX14L-BS
CABLES	73	1200	XL1200V	Sportster Seventy-Two	'12-16	DCPR7E	MH90-21	150/80-16	YTX14L-BS
BRAKES	73	1200	XL1200X	Sportster Forty-Eight	'10-11	DCPR7E	MT90-16	150/80-16	YTX14L-BS
OIL FILTERS	73	1200	XL1200X	Sportster Forty-Eight	'12-18	DCPR7E	130/90-16	150/80-16	YTX14L-BS
SUSPENSION	73	1200	XL50	50th Anniversary Sportster	'07	DCPR7E	100/90-19	150/80-16	YTX14L-BS
BODY	73	1200	XLH1200	Sportster	'88-96	DCPR7E	100/90-19	130/90-16	YTX20-BS
WHEELS	73	1200	XLH1200	Sportster	'97-03	DCPR7E	100/90-19	130/90-16	YTX20L-BS
TIRES / TIRE ACC.	73	1200	XR1200/X	Sportster	'09-12	DCPR7E	120/70-18	180/55-17	YTX14L-BS
BIKE ACC.	<b>STREET</b>								
VICTORY / INDIAN	30	500	XG500	Street 500	'15-17		100/80-17	140/75-15	YTX14L-BS
COVERS / LOCKS / TIEDOWNS	45	750	XG750	Street 750	'15-17		100/80-17	140/75-15	YTX14L-BS
CHEMICALS	45	750	XG750A	Street Rod	'17-18		120/70-17	160/60-17	YTX14L-BS
TOOLS	<b>VROD</b>								
HELMETS	69	1130	VRSCA	V-Rod	'02-06	DCPR8E	120/70-19	180/55-18	YTX14
HELMET ACC.	69	1130	VRSCAW	V-Rod	'07	DCPR8E	120/70-19	240/40-18	YTX14
EYEWEAR	69	1130	VRSCB	V-Rod	'04-05	DCPR8E	120/70-19	180/55-18	YTX14
APPAREL / RIDER ACC.	69	1130	VRSCD	Night Rod	'06-07	DCPR8E	120/70-19	180/55-18	YTX14
PROMOTIONAL	69	1130	VRSCDX	Night Rod Special	'07	DCPR8E	120/70-19	240/40-18	YTX14
REFERENCE	69	1130	VRSCR	Street Rod	'06-07	DCPR8E	120/70-19	180/55-18	YTX14
INDEX	69	1130	VRSCX	V-Rod	'07	DCPR8E	120/70-19	240/40-18	YTX14
	76	1250	VRSCAW	V-Rod	'08-10	DCPR8E	120/70-19	240/40-18	YTX20L
	76	1250	VRSCDX	Night Rod Special	'08-17	DCPR8E	120/70-19	240/40-18	YTX20L
	76	1250	VRSCF	V-Rod Muscle	'09-17	DCPR8E	120/70-19	240/40-18	YTX20L
	76	1250	VRSCSE	CVO Screamin' Eagle V-Rod	'05-06	DCPR8E	120/70-19	180/55-18	YTX14
	79	1300	VRXSE	CVO Screamin' Eagle Destroyer	'06	DCPR8E	100/70-18	200/40-18	YTX14
	<b>MISC</b>								
	5	90	X90	Mini Bike	'73-75	BP5ES	3.00 X 10	3.00 X 10	
	5	90	Z90	Dual Sport	'73-75	BP5ES			12N7-3B
	7	125	SS125	Dual Sport	'76-77	B9ES			12N7-3B
	7	125	SX125	Dual Sport	'74-75	B7ES			12N7-3B
	7	125	SXT125	Dual Sport	'76-77	B9ES			12N7-3B
	7	125	TX125	Dual Sport	'73				12N7-3B
	10	175	SS175	Dual Sport	'76-77	B9ES			12N7-3B
	10	175	SX175	Dual Sport	'74-75	B9ES			12N7-3B
	15	250	SS250	Dual Sport	'75-77	B9ES			12N7-3B
	15	250	SX250	Dual Sport	'75-78	B8ES			12N7-3B
	21	350	SS350	Dual Sport	'69-74	B8ES			6N11A-1B
	45	740	WL	W Model	'50-51	R5670-5			
	45	750	G	G Model	'50-56	R5670-5			
	45	750	K	K Model	'52-54	R5670-5			
	55	900	KH	K Model	'55-56	B6L			
	55	900	KHK	K Model	'55-56	B6L			
	55	900	KHRTT	K Model	'55-57	B6L			
	55	900	KR	K Model	'55-64	R5670-5			
	55	900	KRTT	K Model	'55-63	R5670-5			
	61/74	1000/1200	E	E Model	'36-37, '41-50	A6			
	61/74	1000/1200	EL	E Model	'36-47	A6			
	64/74	1000/1200	EL	E Model	'48-52	R5670-5			
	61/74	1000/1200	F	F Model	'41-47	A6			
	61/74	1000/1200	F	F Model	'48-50	R5670-5			
	61/74	1000/1200	FL	F Model	'41-47	A6			
	61/74	1000/1200	FL	F Model	'48-64	R5670-5			
	61/74	1000/1200	FLF	F Model	'53-64	R5670-5			
	61/74	1000/1200	FLHF	F Model	'55-64, '70-72	R5670-5			
	74	1200	FLFB	F Model	'65-69	R5670-5			
	74	1200	FLHB	F Model	'65-69	R5670-5			
	74	1200	FLHFB	F Model	'65-69	R5670-5			
	74	1200	U	U Model	'37-48	A6			
	74	1200	UL	U Model	'37-48	A6			
	74	1200	V	V Model	'30-33	A6			
	74	1200	VC	V Model	'30-33	A6			
	74	1200	VD	V Model	'34-36	A6			
	74	1200	VFDS	V Model	'34	A6			

# QUICK REFERENCE APPLICATION CHART

cid	cc	Model	Name	Year	NGK	Front Tire	Rear Tire	Battery
<b>HARLEY DAVIDSON (CONT'D...)</b>								
<b>MISC (CONT'D...)</b>								
74	1200	VL	V Model	'30-33	A6			
74	1200	VLD	V Model	'34-36	A6			
74	1200	VLDD	V Model	'35	A6			
74	1200	VLDJ	V Model	'35	A6			
74	1200	VLH	V Model	'36	A6			
80	1300	UH	U Model	'37-40	A6			
80	1300	ULH	U Model	'37-40	A6			
<b>INDIAN</b>								
61	1000		Scout Sixty	'16-18	MR7F	130/90-16	150/80-16	YTX14AH-BS
69	1133		Scout	'15-18	MR7F	130/90-16	150/80-16	YTX14AH-BS
69	1133		Scout Bobber	'18	MR7F	130/90-16	150/80-16	YTX14AH-BS
88	1442		Chief	'99-01	BPR6ES	130/90-16	130/90-16	YTX20H-BS
88	1442		Scout	'01	BPR6ES	100/90-19	130/90-16	YTX20H-BS
88	1442			'02-03	BPR6ES	100/90-19	130/90-16	YTX20H-BS
88	1442		Spirit	'01	BPR6ES	130/90-16	130/90-16	YTX20H-BS
88	1442			'02-03	BPR6ES	MT90-16	MT90-16	YTX20H-BS
100	1638		Chief	'02-03	BPR5ES	MT90-16	MT90-16	YTX24HL-BS
105	1720		Chief Blackhawk	'11	BCPR6ES	130/90-16	150/80-16	YTX20H-BS
105	1720		Chief Blackhawk Dark	'11	BCPR6ES	130/90-16	150/80-16	YTX20H-BS
105	1720		Chief Bomber	'10	BCPR6ES	130/90-16	150/80-16	YTX20H-BS
105	1720		Chief Classic	'10-11	BCPR6ES	130/90-16	150/80-16	YTX20H-BS
105	1720			'12-13	BKR6ES	130/90-16	150/80-16	YTX24HL-BS
105	1720		Chief Dark Horse	10-11	BCPR6ES	130/90-16	150/80-16	YTX20H-BS
105	1720			'12-13	BKR6ES	130/90-16	150/80-16	YTX24HL-BS
105	1720		Chief Deluxe	'09	BCPR6ES	130/90-16	150/80-16	YTX20H-BS
105	1720		Chief Roadmaster	'09-11	BCPR6ES	130/90-16	150/80-16	YTX20H-BS
105	1720		Chief Standard	'09	BCPR6ES	130/90-16	150/80-16	YTX20H-BS
105	1720		Chief Vintage	'09-11	BCPR6ES	130/90-16	150/80-16	YTX20H-BS
105	1720			'12-13	BKR6ES	130/90-16	150/80-16	YTX24HL-BS
111	1819		Chief Classic	'14-18	DCPR8E	130/90-16	180/65-16	YTX20HL
111	1819		Chief Vintage	'14-18	DCPR8E	130/90-16	180/65-16	YTX20HL
111	1819		Chief Dark Horse	'16-18	DCPR8E	130/90-16	180/60-16	YTX20HL
111	1819		Chieftain	'14-17	DCPR8E	130/90-16	180/60-16	YTX20HL
111	1819		Chieftain	'18	DCPR8E	130/60-19	180/60-16	YTX20HL
111	1819		Chieftain Classic	'18	DCPR8E	130/90-16	180/60-16	YTX20HL
111	1819		Chieftain Dark Horse	'18	DCPR8E	130/60-19	180/60-16	YTX20HL
111	1819		Chieftain Limited	'18	DCPR8E	130/60-19	180/60-16	YTX20HL
111	1819		Roadmaster	'15-18	DCPR8E	130/90-16	180/60-16	YTX20HL
111	1819		Roadmaster Classic	'18	DCPR8E	130/90-16	180/60-16	YTX20HL
111	1819		Roadmaster Elite	'18	DCPR8E	130/90-16	180/60-16	YTX20HL
111	1819		Springfield	'17-18	DCPR8E	130/90-16	180/60-16	YTX20HL
111	1819		Springfield Dark Horse	'18	DCPR8E	130/60-19	180/60-16	YTX20HL



- WINDSHIELDS / FAIRINGS
- AUDIO / COMMUNICATION
- SEATS / LUGGAGE
- BARS / MIRRORS / CONTROLS
- EXHAUST
- AIR / FUEL SYSTEMS
- ENGINE
- TRANSMISSION / DRIVELINE
- GASKETS / SEALS
- ELECTRICAL
- LIGHTING
- CABLES
- BRAKES
- OIL FILTERS
- SUSPENSION
- BODY
- WHEELS
- TIRES / TIRE ACC.
- BIKE ACC.
- VICTORY / INDIAN
- COVERS / LOCKS / TIEDOWNS
- CHEMICALS
- TOOLS
- HELMETS
- HELMET ACC.
- EYEWEAR
- APPAREL / RIDER ACC.
- PROMOTIONAL
- REFERENCE
- INDEX

**HARDDRIVE TO OEM CROSS REFERENCE**

	OEM#	WPS#	Vendor	Vend#	Page#	OEM#	WPS#	Vendor	Vend#	Page#
WINDSHIELDS / FAIRINGS	3	274-0160	Accel	2401	<b>558</b>	11159	681-4517	James Gaskets	JGI-11159	<b>478</b>
AUDIO / COMMUNICATION	738	681-4572	James Gaskets	JGI-738	<b>479</b>	11161	681-5452	James Gaskets	JGI-11161	<b>492</b>
SEATS / LUGGAGE	5710	830-1198	Colony	9912-2	<b>719</b>	11162	68-9495	Cometric Gaskets	C9495	<b>461</b>
BARS / MIRRORS / CONTROLS	6007	68-9498	Cometric Gaskets	C9498	<b>461</b>	11162	681-4680	James Gaskets	JGI-11162	<b>480</b>
EXHAUST	6007	681-4691	James Gaskets	JGI-6007	<b>480</b>	11165	68-9361	Cometric Gaskets	C9361	<b>461</b>
AIR / FUEL SYSTEMS	6007	681-4728	James Gaskets	JGI-6007-X	<b>481</b>	11165	681-4681	James Gaskets	JGI-11165	<b>480</b>
ENGINE	6033	681-5474	James Gaskets	JGI-6033	<b>492</b>	11166	68-9530	Cometric Gaskets	C9530	<b>461</b>
TRANSMISSION / DRIVELINE	6057	681-4638	James Gaskets	JGI-6057	<b>479</b>	11166	681-4677	James Gaskets	JGI-11166	<b>480</b>
GASKETS / SEALS	6114	68-9400	Cometric Gaskets	C9400	<b>458</b>	11167	68-9443	Cometric Gaskets	C9443	<b>466</b>
ELECTRICAL	6156	681-4867	James Gaskets	JGI-6156	<b>483</b>	11168	68-9444	Cometric Gaskets	C9444	<b>466</b>
LIGHTING	6377	681-4868	James Gaskets	JGI-6377	<b>483</b>	11170	681-4732	James Gaskets	JGI-11170	<b>481</b>
CABLES	6581	681-4869	James Gaskets	JGI-6581	<b>483</b>	11171	68-9436	Cometric Gaskets	C9436	<b>460</b>
BRAKES	6737	681-4472	James Gaskets	JGI-6737	<b>478</b>	11173	681-4714	James Gaskets	JGI-11173	<b>481</b>
OIL FILTERS	7019	681-5432	James Gaskets	JGI-7019	<b>492</b>	11176	68-9296	Cometric Gaskets	C9296	<b>466</b>
SUSPENSION	7078	681-4313	James Gaskets	JGI-7078	<b>475</b>	11176	681-5304	James Gaskets	JGI-11176	<b>491</b>
BODY	7402	681-4948	James Gaskets	JGI-7402	<b>485</b>	11178	681-4684	James Gaskets	JGI-11178	<b>480</b>
WHEELS	7652	830-1142	Colony	2293-1	<b>385</b>	11179	68-9447	Cometric Gaskets	C9447	<b>461</b>
TIRES / TIRE ACC.	7839	830-1138	Colony	2285-1	<b>385</b>	11179	681-4685	James Gaskets	JGI-11179	<b>480</b>
BIKE ACC.	8010	830-1146	Colony	2376-1	<b>385</b>	11187	681-5433	James Gaskets	JGI-11187	<b>492</b>
VICTORY / INDIAN	8011	830-1140	Colony	2287-1	<b>385</b>	11188	681-5434	James Gaskets	JGI-11188	<b>492</b>
COVERS / LOCKS / TIEDOWNS	8866	681-4523	James Gaskets	JGI-8866	<b>478</b>	11190	681-5302	James Gaskets	JGI-11190	<b>491</b>
CHEMICALS	9208	22-81204	All Balls Racing	28-1204	<b>758</b>	11191	68-9661	Cometric Gaskets	C9661	<b>461</b>
TOOLS	9247	22-51394	All Balls Racing	25-1394	<b>795</b>	11191	681-4686	James Gaskets	JGI-11191	<b>480</b>
HELMETS	9267	22-51368	All Balls Racing	25-1368	<b>795</b>	11201	681-4311	James Gaskets	JGI-11201	<b>475</b>
HELMET ACC.	9276	22-51405	All Balls Racing	25-1405	<b>795</b>	11202	681-5401	James Gaskets	JGI-11202	<b>492</b>
EYEWEAR	9276	22-51571	All Balls Racing	25-1571	<b>795</b>	11241	681-4516	James Gaskets	JGI-11241	<b>478</b>
APPAREL / RIDER ACC.	11002	681-4520	James Gaskets	JGI-11002	<b>478</b>	11256	68-9628	Cometric Gaskets	C9628	<b>455</b>
PROMOTIONAL	11067	810-4007EACH	Alto Clutches	95252	<b>405</b>	11256	681-4149	James Gaskets	JGI-11256	<b>474</b>
REFERENCE	11067	810-4007	Alto Clutches	095252-UP10	<b>405</b>	11270	68-9629	Cometric Gaskets	C9629	<b>455</b>
INDEX	11100	681-5525	James Gaskets	JGI-11100	<b>493</b>	11270	681-4107	James Gaskets	JGI-11270	<b>474</b>
	11101	68-9451	Cometric Gaskets	C9451	<b>462</b>	11273	68-9438	Cometric Gaskets	C9438	<b>455</b>
	11101	681-4810	James Gaskets	JGI-11101	<b>483</b>	11273	681-4146	James Gaskets	JGI-11273	<b>474</b>
	11102	681-5684	James Gaskets	JGI-11102	<b>495</b>	11286	68-9437	Cometric Gaskets	C9437	<b>456</b>
	11103	68-9458	Cometric Gaskets	C9458	<b>469</b>	11286	681-4180	James Gaskets	JGI-11286	<b>474</b>
	11103	681-5655	James Gaskets	JGI-11103	<b>495</b>	11288	68-9627	Cometric Gaskets	C9627	<b>456</b>
	11106	681-5641	James Gaskets	JGI-11106	<b>494</b>	11288	681-4166	James Gaskets	JGI-11288	<b>474</b>
	11107	68-9452	Cometric Gaskets	C9452	<b>463</b>	11289	681-4167	James Gaskets	JGI-11289	<b>474</b>
	11107	681-4895	James Gaskets	JGI-11107	<b>484</b>	11290	68-9642	Cometric Gaskets	C9642	<b>457</b>
	11110	68-9448	Cometric Gaskets	C9448	<b>466</b>	11290	681-4315	James Gaskets	JGI-11290	<b>475</b>
	11110	681-5305	James Gaskets	JGI-11110	<b>491</b>	11291	68-9630	Cometric Gaskets	C9630	<b>456</b>
	11113	68-9460	Cometric Gaskets	C9460	<b>461</b>	11291	681-4218	James Gaskets	JGI-11291	<b>474</b>
	11113	681-5451	James Gaskets	JGI-11113	<b>492</b>	11292	681-4220	James Gaskets	JGI-11292	<b>474</b>
	11114	681-4982	James Gaskets	JGI-11114	<b>485</b>	11293	681-4121	James Gaskets	JGI-11293	<b>474</b>
	11115	68-9529	Cometric Gaskets	C9529	<b>461</b>	11293	681-4024	James Gaskets	JGI-11293-K	<b>473</b>
	11115	681-4983	James Gaskets	JGI-11115	<b>485</b>	11293	681-4025	James Gaskets	JGI-11293-TC	<b>473</b>
	11116	68-9433	Cometric Gaskets	C9433	<b>460</b>	11297	681-4333	James Gaskets	JGI-11297	<b>476</b>
	11116	681-5473	James Gaskets	JGI-11116	<b>492</b>	11298	681-4168	James Gaskets	JGI-11298	<b>474</b>
	11117	68-9484	Cometric Gaskets	C9484	<b>461</b>	11301	681-4181	James Gaskets	JGI-11301	<b>474</b>
	11117	681-4687	James Gaskets	JGI-11117	<b>480</b>	11324	681-4275	James Gaskets	JGI-11324	<b>475</b>
	11118	68-9711F	Cometric Gaskets	C9711	<b>462</b>	11326	681-4183	James Gaskets	JGI-11326	<b>474</b>
	11119	68-9455	Cometric Gaskets	C9455	<b>469</b>	11345	681-4184	James Gaskets	JGI-11345	<b>474</b>
	11119	681-5654	James Gaskets	JGI-11119	<b>495</b>	11351	681-4246	James Gaskets	JGI-11351	<b>475</b>
	11120	68-9961	Cometric Gaskets	C9961	<b>467</b>	11377	68-9956	Cometric Gaskets	C9956	<b>466</b>
	11120	681-4185	James Gaskets	JGI-11120	<b>474</b>	11377	681-5301	James Gaskets	JGI-11377	<b>491</b>
	11124	681-5387	James Gaskets	JGI-11124	<b>491</b>	11377	681-5229	James Gaskets	JGI-11377-K	<b>490</b>
	11124	681-5388	James Gaskets	JGI-11124-DL	<b>491</b>	11428	681-4957	James Gaskets	JGI-11428	<b>485</b>
	11125	68-9536	Cometric Gaskets	C9536	<b>463</b>	11447	820-52263	HardDrive	820-52263	<b>738</b>
	11125	681-4947	James Gaskets	JGI-11125	<b>485</b>	11447	681-4602	James Gaskets	JGI-11447	<b>479</b>
	11132	68-9459	Cometric Gaskets	C9459	<b>455</b>	12002	681-5006	James Gaskets	JGI-12002	<b>486</b>
	11132	681-4468	James Gaskets	JGI-11132	<b>478</b>	12010	68-9531	Cometric Gaskets	C9531	<b>461</b>
	11133	68-9461	Cometric Gaskets	C9461	<b>462</b>	12010	681-4987	James Gaskets	JGI-12010	<b>485</b>
	11133	681-4812	James Gaskets	JGI-11133	<b>483</b>	12014	68-9494	Cometric Gaskets	C9494	<b>463</b>
	11139	68-9446	Cometric Gaskets	C9446	<b>469</b>	12014	681-4944	James Gaskets	JGI-12014	<b>485</b>
	11139	681-5470	James Gaskets	JGI-11139	<b>492</b>	12014	681-4417	James Gaskets	JGI-12014-K	<b>477</b>
	11140	681-4731	James Gaskets	JGI-11140	<b>481</b>	12018	68-9518	Cometric Gaskets	C9518	<b>463</b>
	11145	681-4470	James Gaskets	JGI-11145	<b>478</b>	12018	681-4945	James Gaskets	JGI-12018	<b>485</b>
	11145	681-4471	James Gaskets	JGI-11145-X	<b>478</b>	12021	68-9367	Cometric Gaskets	C9367	<b>469</b>
	11147	68-9441	Cometric Gaskets	C9441	<b>457</b>	12021	681-5653	James Gaskets	JGI-12021	<b>495</b>
	11147	681-4625	James Gaskets	JGI-11147	<b>479</b>	12022	68-9506	Cometric Gaskets	C9506	<b>463</b>
	11148	68-9357	Cometric Gaskets	C9357	<b>463</b>	12022	681-4981	James Gaskets	JGI-12022	<b>485</b>
	11148	681-4688	James Gaskets	JGI-11148	<b>480</b>	12023	68-9369	Cometric Gaskets	C9369	<b>468</b>
	11156	681-5014	James Gaskets	JGI-11156	<b>486</b>	12030	68-9362	Cometric Gaskets	C9362	<b>467</b>
	11157	681-4469	James Gaskets	JGI-11157	<b>478</b>	12030	681-5453	James Gaskets	JGI-12030	<b>492</b>



**HARDDRIVE TO OEM CROSS REFERENCE**

OEM#	WPS#	Vendor	Vend#	Page#
12035	681-4678	James Gaskets	JGI-12035-B	480
12036	681-5580	James Gaskets	JGI-12036	494
12043	68-9528	Cometic Gaskets	C9528	461
12043	681-4669	James Gaskets	JGI-12043	480
12043	681-4670	James Gaskets	JGI-12043-A	480
12045	681-4671	James Gaskets	JGI-12045-DL	480
12045	681-4668	James Gaskets	JGI-12045-M	480
12047	681-5024	James Gaskets	JGI-12047-DL	486
12049	681-5450	James Gaskets	JGI-12049-DL	492
12050	68-9359	Cometic Gaskets	C9359	461
12050	681-4672	James Gaskets	JGI-12050	480
12050	681-4415	James Gaskets	JGI-12050-K	477
12051	68-9491	Cometic Gaskets	C9491	460
12051	681-4683	James Gaskets	JGI-12051	480
12052	68-9260	Cometic Gaskets	C9260	457
12052	681-4630	James Gaskets	JGI-12052	479
12052	681-4629	James Gaskets	JGI-12052-F	479
12053	681-4634	James Gaskets	JGI-12053	479
12053	681-4635	James Gaskets	JGI-12053-A	479
12066	68-9261	Cometic Gaskets	C9261	457
12066	681-4633	James Gaskets	JGI-12066-A	479
12067	681-4679	James Gaskets	JGI-12067-A	480
12067	681-4414	James Gaskets	JGI-12067-AK	477
12068	68-9632	Cometic Gaskets	C9632	455
12068	681-4165	James Gaskets	JGI-12068	474
12074	68-9215	Cometic Gaskets	C9215	457
12074	681-4308	James Gaskets	JGI-12074	475
12074	681-4031	James Gaskets	JGI-12074-K	473
12074	681-5242	James Gaskets	JGI-12074-XL	490
12077	68-9200	Cometic Gaskets	C9200	457
12077	681-4309	James Gaskets	JGI-12077	475
20597	820-50818	HardDrive	820-50818	211
28780	820-50836	HardDrive	820-50836	211
11000101	68-10213	Cometic Gaskets	C10213	453
11000101	681-6115	James Gaskets	JGI-11000101	472
11000134	68-10209	Cometic Gaskets	C10209	453
11000134	681-6127	James Gaskets	JGI-11000134	472
11900010	68-10208	Cometic Gaskets	C10208	453
11900010	681-6109	James Gaskets	JGI-11900010	472
11900090	68-10201	Cometic Gaskets	C10201	453
11900090	681-6107	James Gaskets	JGI-11900090	472
11900092	68-10212	Cometic Gaskets	C10212	453
11900092	681-6108	James Gaskets	JGI-11900092	472
11900103	68-10210	Cometic Gaskets	C10210	453
11900103	68-10210	Cometic Gaskets	C10210	453
11900103	681-6111	James Gaskets	JGI-11900103	472
11900116	68-10189	Cometic Gaskets	C10189	452
11900116	681-6103	James Gaskets	JGI-11900116	472
16500305	68-10165	Cometic Gaskets	C10165	452
16500326	68-10164	Cometic Gaskets	C10164	452
16500326	681-6100	James Gaskets	JGI-16500326	472
16500332	68-10177	Cometic Gaskets	C10177	453
16500332	681-6101	James Gaskets	JGI-16500332	472
18100044	68-10202	Cometic Gaskets	C10202	452
18100044	681-6102	James Gaskets	JGI-18100044	472
24400215	68-10214	Cometic Gaskets	C10214	453
24400215	681-6116	James Gaskets	JGI-24400215	472
25600455	681-6120	James Gaskets	JGI-25600455	472
25700362	68-10172	Cometic Gaskets	C10172	452
25700362	681-6104	James Gaskets	JGI-25700362	472
25700370	68-10173	Cometic Gaskets	C10173	453
25700372	68-10179	Cometic Gaskets	C10179	452
25700372	68-10179-2	Cometic Gaskets	C10179-2	452
25700372	681-6105	James Gaskets	JGI-25700372	472
25700378	68-10198F1	Cometic Gaskets	C10198F1	453
25700378	681-6119	James Gaskets	JGI-25700378	472
25700425	68-10183	Cometic Gaskets	C10183	452
25700425	681-6106	James Gaskets	JGI-25700425	472
25700433	68-10174	Cometic Gaskets	C10174	453
25700433	681-6110	James Gaskets	JGI-25700433	472
25700452	68-10215	Cometic Gaskets	C10215	453
25700452	681-6117	James Gaskets	JGI-25700452	472
25700453	68-10216	Cometic Gaskets	C10216	453

OEM#	WPS#	Vendor	Vend#	Page#
25700453	681-6118	James Gaskets	JGI-25700453	472
25700455	68-10211	Cometic Gaskets	C10211	453
25700729	68-10217	Cometic Gaskets	C10217	452
25700729	681-6122	James Gaskets	JGI-25700729	472
25700730	681-6123	James Gaskets	JGI-25700730	472
25700731	68-10178	Cometic Gaskets	C10178	452
25700746	68-10196	Cometic Gaskets	C10196	452
25800370	681-6112	James Gaskets	JGI-25800370	472
26500002	68-10039	Cometic Gaskets	C10039	455
27300082	68-10204	Cometic Gaskets	C10204	453
27300087	68-10203	Cometic Gaskets	C10203	453
27300087	681-6113	James Gaskets	JGI-27300087	472
29000108	68-10207	Cometic Gaskets	C10207	453
29000149	68-10176	Cometic Gaskets	C10176	453
29000149	681-6114	James Gaskets	JGI-29000149	472
32700065	68-10190	Cometic Gaskets	C10190	453
36500020	820-52350	HardDrive	820-52350	415
36700052	820-55050	HardDrive	820-55050	217
36700065	820-55005	HardDrive	820-55005	213
36700094	820-55004	HardDrive	820-55004	208
41300009	820-51285	HardDrive	820-51285	676
41300019	820-51264	HardDrive	820-51264	662
41500020	830-1107	Colony	2925-10	669
41500094	820-51265	HardDrive	820-51265	662
45500113	820-52316	HardDrive	820-52316	714
45600022	820-52370	HardDrive	820-52370	714
45600023	820-52371	HardDrive	820-52371	714
50500167	820-55261	HardDrive	820-55261	238
50500168	820-55263	HardDrive	820-55263	238
50700008	820-55600	HardDrive	820-55600	221
56000039	820-0828	HardDrive	820-0828	196
56000042	820-0829	HardDrive	820-0829	196
67800173	820-52357	HardDrive	820-52357	604
71500185	820-55001	HardDrive	820-55001	213
01-931	68-9540	Cometic Gaskets	C9540	456
10R12A	4-4162	Autolite Sparkplugs	4162	559
10R12A	4-XS4162	Autolite Sparkplugs	XS4162	559
10R12A	2-DCPR8E	NGK Sparkplugs	4339	558
10R12A	2-DCPR8EIX	NGK Sparkplugs	6546	558
11105/11102/11273	68-9435	Cometic Gaskets	C9435	460
111157, 25PK	68-9292	Cometic Gaskets	C9292	459
11124-DL	68-9355	Cometic Gaskets	C9355	466
11132A	681-4122	James Gaskets	JGI-11132-A	474
11133A	681-4821	James Gaskets	JGI-11133-A	483
11133-FL	68-9584	Cometic Gaskets	C9584	462
11133-FLH	68-9585	Cometic Gaskets	C9585	462
11133-V2	68-9586	Cometic Gaskets	C9586	455
11140/11241/11289	68-9667	Cometic Gaskets	C9667	455
11145, 25PK	68-9293	Cometic Gaskets	C9293	455
11145A	681-4123	James Gaskets	JGI-11145-A	474
11167A	681-5306	James Gaskets	JGI-11167-A	491
11168A	681-5307	James Gaskets	JGI-11168-A	491
11177A	810-4006EACH	Alto Clutches	95251	405
11177A	810-4006	Alto Clutches	095251-UP10	405
11178/62673-90	68-9263	Cometic Gaskets	C9263	461
11187/11201	68-9434	Cometic Gaskets	C9434	467
11190/11293, 10PK	68-9294	Cometic Gaskets	C9294	455
11241/11140/11289	68-9684	Cometic Gaskets	C9684	460
11298, 10PK	68-9631	Cometic Gaskets	C9631	456
11447 and 5775	830-1134	Colony	2105-8	739
12013A	68-9493	Cometic Gaskets	C9493	461
12013A	681-4673	James Gaskets	JGI-12013	480
12013A	681-4674	James Gaskets	JGI-12013-A	480
12026A	68-9351	Cometic Gaskets	C9351	461
12026A	681-4501	James Gaskets	JGI-12026-A	478
12035A	68-9258	Cometic Gaskets	C9258	461
12036A	68-9376	Cometic Gaskets	C9376	467
12036A	681-5365	James Gaskets	JGI-12036-A	491
12044A	681-4978	James Gaskets	JGI-12044-A	485
12044A	681-4755	James Gaskets	JGI-12044-AK	482
12044A	681-4979	James Gaskets	JGI-12044-DL	485
12044DL	68-9527	Cometic Gaskets	C9527	461
12045DL	68-9259	Cometic Gaskets	C9259	461

WINDSHIELDS / FAIRINGS  
 AUDIO / COMMUNICATION  
 SEATS / LUGGAGE  
 BARS / MIRRORS / CONTROLS  
 EXHAUST  
 AIR / FUEL SYSTEMS  
 ENGINE  
 TRANSMISSION / DRIVELINE  
 GASKETS / SEALS  
 ELECTRICAL  
 LIGHTING  
 CABLES  
 BRAKES  
 OIL FILTERS  
 SUSPENSION  
 BODY  
 WHEELS  
 TIRES / TIRE ACC.  
 BIKE ACC.  
 VICTORY / INDIAN  
 COVERS / LOCKS / TIEDOWNS  
 CHEMICALS  
 TOOLS  
 HELMETS  
 HELMET ACC.  
 EYEWEAR  
 APPAREL / RIDER ACC.  
 PROMOTIONAL  
 REFERENCE  
 INDEX

**HARDDRIVE TO OEM CROSS REFERENCE**

	OEM#	WPS#	Vendor	Vend#	Page#	OEM#	WPS#	Vendor	Vend#	Page#
WINDSHIELDS / FAIRINGS	12049DL	68-9356	Cometic Gaskets	C9356	<b>467</b>	16777-86S	68-9615	Cometic Gaskets	C9615	<b>459</b>
AUDIO / COMMUNICATION	12052B	681-4273	James Gaskets	JGI-12052-A	<b>475</b>	16778-84A	68-9285	Cometic Gaskets	C9285	<b>465</b>
SEATS / LUGGAGE	12053, DL LIP SEAL	68-9379	Cometic Gaskets	C9379	<b>460</b>	16778-97X	68-9561	Cometic Gaskets	C9561	<b>458</b>
BARS / MIRRORS / CONTROLS	12067A	68-9262	Cometic Gaskets	C9262	<b>461</b>	16779-84B	68-9284	Cometic Gaskets	C9284	<b>458</b>
EXHAUST	16-0243	68-9223	Cometic Gaskets	C9223	<b>456</b>	16779-84B	681-4449	James Gaskets	JGI-16779-84-X	<b>478</b>
AIR / FUEL SYSTEMS	16219-79B	820-52281	HardDrive	820-52281	<b>395</b>	16779-97X	68-9563	Cometic Gaskets	C9563	<b>458</b>
ENGINE	16219-79C	820-52280	HardDrive	820-52280	<b>395</b>	16779-99	681-4448	James Gaskets	JGI-16779-99-X	<b>478</b>
TRANSMISSION / DRIVELINE	16258-95B	820-52282	HardDrive	820-52282	<b>395</b>	16787-99	681-4143	James Gaskets	JGI-16787-99	<b>474</b>
GASKETS / SEALS	16461-02 16465-06	191-57009C	Kibble White	20-20690C	<b>370</b>	16787-99	681-4140	James Gaskets	JGI-16787-99-MLS	<b>474</b>
ELECTRICAL	16461-02 16465-06	191-57011C	Kibble White	20-20700C	<b>370</b>	16787-99	681-4144	James Gaskets	JGI-16787-99-X	<b>474</b>
LIGHTING	16465-06 16461-02	191-57009C	Kibble White	20-20690C	<b>370</b>	16800-84	68-9865	Cometic Gaskets	C9865	<b>458</b>
CABLES	16465-06 16461-02	191-57011C	Kibble White	20-20700C	<b>370</b>	16800-84	68-9866	Cometic Gaskets	C9866	<b>459</b>
BRAKES	16480-85A and 16478-85A	830-1100	Colony	2011-8	<b>393</b>	17026-71	68-9045F	Cometic Gaskets	C9045F	<b>468</b>
OIL FILTERS	16480-92 and 16478-85A	830-1101	Colony	2012-8	<b>393</b>	17026-71	681-5502	James Gaskets	JGI-17026-71	<b>493</b>
SUSPENSION	16664-86	681-5331	James Gaskets	JGI-16664-86	<b>491</b>	17026-72	68-9047F	Cometic Gaskets	C9047F	<b>468</b>
BODY	16664-86B	68-9205	Cometic Gaskets	C9205	<b>466</b>	17026-73	681-5501	James Gaskets	JGI-17026-73	<b>493</b>
WHEELS	16665-86	681-5330	James Gaskets	JGI-16665-86	<b>491</b>	17026-73L	68-9049F	Cometic Gaskets	C9049F	<b>468</b>
TIRES / TIRE ACC.	16719-99	68-9576	Cometic Gaskets	C9576	<b>455</b>	17026-79	68-9051F	Cometic Gaskets	C9051F	<b>468</b>
BIKE ACC.	16719-99	681-4102	James Gaskets	JGI-16719-99	<b>474</b>	17026-82	68-9117F	Cometic Gaskets	C9117F	<b>468</b>
VICTORY / INDIAN	16769-57	681-5544	James Gaskets	JGI-16769-57	<b>493</b>	17026-86A	68-9757F	Cometic Gaskets	C9757F	<b>465</b>
COVERS / LOCKS / TIEDOWNS	16769-72A	68-9698	Cometic Gaskets	C9698	<b>468</b>	17026-86A	681-5215	James Gaskets	JGI-17026-86	<b>490</b>
CHEMICALS	16769-72A	681-5543	James Gaskets	JGI-16769-72-A	<b>493</b>	17026-86A	681-5214	James Gaskets	JGI-17026-86-MLS	<b>490</b>
TOOLS	16769-73	68-9565	Cometic Gaskets	C9565	<b>468</b>	17026-91	681-5213	James Gaskets	JGI-17026-91	<b>490</b>
HELMETS	16769-73	681-5542	James Gaskets	JGI-16769-73	<b>493</b>	17026-91	681-5212	James Gaskets	JGI-17026-91-MLS	<b>490</b>
HELMET ACC.	16769-73	681-5541	James Gaskets	JGI-16769-73-T	<b>493</b>	17026-91A	68-9124	Cometic Gaskets	C9124	<b>465</b>
EYEWEAR	16769-82	68-9566	Cometic Gaskets	C9566	<b>468</b>	17026-91A	68-9133	Cometic Gaskets	C9133	<b>465</b>
APPAREL / RIDER ACC.	16769-82	681-5540	James Gaskets	JGI-16769-82	<b>493</b>	17026-91A	68-9758F	Cometic Gaskets	C9758F	<b>465</b>
PROMOTIONAL	16770-48	681-5081	James Gaskets	JGI-16770-48	<b>488</b>	17026-91A	68-9759	Cometic Gaskets	C9759	<b>465</b>
REFERENCE	16770-48	681-5080	James Gaskets	JGI-16770-48-X	<b>488</b>	17026-91A	68-9760	Cometic Gaskets	C9760	<b>465</b>
INDEX	16770-48	681-5080	James Gaskets	JGI-16770-48-X	<b>488</b>	17026-91A	68-97610E	Cometic Gaskets	C9761	<b>465</b>
	1677048MLS	68-9137	Cometic Gaskets	C9137	<b>464</b>	17026-91A	68-97620E	Cometic Gaskets	C9762	<b>465</b>
	16770-66A	681-4843	James Gaskets	JGI-16770-66-A	<b>483</b>	17026-91A	68-9763	Cometic Gaskets	C9763	<b>465</b>
	16770-66A	681-4842	James Gaskets	JGI-16770-66-B	<b>483</b>	17026-91A	68-9764	Cometic Gaskets	C9764	<b>465</b>
	16770-66A	681-4746	James Gaskets	JGI-16770-66-S	<b>482</b>	17026-91A	68-9765	Cometic Gaskets	C9765	<b>465</b>
	16770-66A	681-4841	James Gaskets	JGI-16770-66-X	<b>483</b>	17026-91A	68-9766	Cometic Gaskets	C9766	<b>458</b>
	16770-66X	68-9984	Cometic Gaskets	C9984	<b>462</b>	17026-91A	68-9767	Cometic Gaskets	C9767	<b>458</b>
	16770-84B	681-4391	James Gaskets	JGI-16770-84-A	<b>477</b>	17026-91A	68-9768	Cometic Gaskets	C9768	<b>458</b>
	16770-84B	681-4483	James Gaskets	JGI-16770-84-B	<b>478</b>	17026-91A	68-9769	Cometic Gaskets	C9769	<b>458</b>
	16770-84B	681-4480	James Gaskets	JGI-16770-84-MLS	<b>478</b>	17026-91A	68-9854F	Cometic Gaskets	C9854F	<b>465</b>
	16770-84B	681-4484	James Gaskets	JGI-16770-84-X	<b>478</b>	17026-91A	68-9855F	Cometic Gaskets	C9855F	<b>465</b>
	16771-08	68-10003	Cometic Gaskets	C10003	<b>466</b>	17026-91A	68-9907	Cometic Gaskets	C9907	<b>465</b>
	16771-08XX	68-10004	Cometic Gaskets	C10004	<b>466</b>	17026-91A	68-9980	Cometic Gaskets	C9980	<b>459</b>
	16773-85	681-4481	James Gaskets	JGI-16773-85	<b>478</b>	17027-04	68-9952	Cometic Gaskets	C9952	<b>465</b>
	16773-85	681-4482	James Gaskets	JGI-16773-85-T	<b>478</b>	17027-04	68-9953	Cometic Gaskets	C9953	<b>465</b>
	16773-85	681-4485	James Gaskets	JGI-16773-85-TS	<b>478</b>	17027-04	681-5211	James Gaskets	JGI-17047-04-X	<b>490</b>
	16774-57	68-9699	Cometic Gaskets	C9699	<b>468</b>	17027-04B	681-5210	James Gaskets	JGI-17047-07-X	<b>490</b>
	16774-57	681-5546	James Gaskets	JGI-16774-57	<b>493</b>	17028-48	681-5051	James Gaskets	JGI-17028-48	<b>487</b>
	16774-72	68-9603	Cometic Gaskets	C9603	<b>468</b>	17029-48	68-9966	Cometic Gaskets	C9966	<b>464</b>
	16774-72	681-5545	James Gaskets	JGI-16774-72	<b>493</b>	17029-66X	68-9900	Cometic Gaskets	C9900	<b>462</b>
	16774-86	68-9009	Cometic Gaskets	C9009	<b>459</b>	17029-70	681-4741	James Gaskets	JGI-17029-70	<b>482</b>
	16774-86A	681-5332	James Gaskets	JGI-16774-86	<b>491</b>	17029-70	681-4740	James Gaskets	JGI-17029-70-A	<b>482</b>
	16774-86A	681-5335	James Gaskets	JGI-16774-96	<b>491</b>	17029-70A	68-9964	Cometic Gaskets	C9964	<b>462</b>
	16774-86A	681-5334	James Gaskets	JGI-16774-96-XT1	<b>491</b>	17029-70-A	68-9154	Cometic Gaskets	C9154	<b>462</b>
	16774-86A	681-5333	James Gaskets	JGI-16774-96-XT2	<b>491</b>	17029-80	68-9965	Cometic Gaskets	C9965	<b>462</b>
	16774-86D	68-9008	Cometic Gaskets	C9008	<b>466</b>	17030-17	681-6125	James Gaskets	JGI-17030-17	<b>472</b>
	16774-86E	68-9214	Cometic Gaskets	C9214	<b>466</b>	17030-57	68-9102	Cometic Gaskets	C9102	<b>468</b>
	16774-96	68-9553	Cometic Gaskets	C9553	<b>466</b>	17030-57	681-5504	James Gaskets	JGI-17030-57	<b>493</b>
	16775-99	68-9790	Cometic Gaskets	C9790	<b>455</b>	17030-72	68-9103	Cometic Gaskets	C9103	<b>468</b>
	16775-99	681-4141	James Gaskets	JGI-16775-99	<b>474</b>	17030-72A	681-5503	James Gaskets	JGI-17030-72-A	<b>493</b>
	16775-99	681-4142	James Gaskets	JGI-16775-99-X	<b>474</b>	17030-72AL	68-9104	Cometic Gaskets	C9104	<b>468</b>
	16776-48	68-9567	Cometic Gaskets	C9567	<b>462</b>	17030-72B	68-9052	Cometic Gaskets	C9052	<b>468</b>
	16776-48	681-5083	James Gaskets	JGI-16776-48	<b>488</b>	17030-82	68-9116	Cometic Gaskets	C9116	<b>468</b>
	16776-63	681-4847	James Gaskets	JGI-16776-63	<b>483</b>	17032-86A	681-5221	James Gaskets	JGI-17032-86-B	<b>490</b>
	16776-64	681-4845	James Gaskets	JGI-16776-63-X	<b>483</b>	17032-86A	681-5220	James Gaskets	JGI-17032-86-MLS	<b>490</b>
	16776-65	681-4846	James Gaskets	JGI-16776-63-X1	<b>483</b>	17032-91A	681-5219	James Gaskets	JGI-17032-91	<b>490</b>
	16777-48	68-9568	Cometic Gaskets	C9568	<b>462</b>	17032-91A	681-5218	James Gaskets	JGI-17032-91-MLS	<b>490</b>
	16777-48	681-5084	James Gaskets	JGI-16777-48	<b>488</b>	17033-83A	681-4388	James Gaskets	JGI-17033-83	<b>477</b>
	16777-63	681-4848	James Gaskets	JGI-16777-63	<b>483</b>	17033-83A	681-4387	James Gaskets	JGI-17033-83-A	<b>477</b>
	16777-83A	681-4489	James Gaskets	JGI-16777-83-A	<b>478</b>	17033-83A	681-4386	James Gaskets	JGI-17033-83-MLS	<b>477</b>
	16777-83A	681-4491	James Gaskets	JGI-16777-86-S	<b>478</b>	17033-83A	681-4397	James Gaskets	JGI-17033-83-R	<b>477</b>
	16777-83A	681-4488	James Gaskets	JGI-16777-94	<b>478</b>	17033-83-A	68-9747	Cometic Gaskets	C9747	<b>458</b>
	16777-83A	681-4490	James Gaskets	JGI-16777-94-S	<b>478</b>	17033-83-A	68-9851	Cometic Gaskets	C9851	<b>458</b>
						17034-48	68-9968	Cometic Gaskets	C9968	<b>464</b>

# HARDDRIVE TO OEM CROSS REFERENCE

OEM#	WPS#	Vendor	Vend#	Page#	OEM#	WPS#	Vendor	Vend#	Page#
17034-48	681-5053	James Gaskets	JGI-17034-48	<b>487</b>	17358-84A	68-9283	Cometic Gaskets	C9283	<b>459</b>
17034-66	681-4744	James Gaskets	JGI-17034-66	<b>482</b>	17358-84A	681-4442	James Gaskets	JGI-17358-84-A	<b>478</b>
17034-66	681-4743	James Gaskets	JGI-17034-66-X	<b>482</b>	17362-07	68-9196	Cometic Gaskets	C9196	<b>466</b>
17034-66X	68-9967	Cometic Gaskets	C9967	<b>462</b>	17362-07	681-5270	James Gaskets	JGI-17362-07	<b>491</b>
17034-66-X	68-9918	Cometic Gaskets	C9918	<b>462</b>	17369-06	68-9150	Cometic Gaskets	C9150	<b>457</b>
17035-83	681-4383	James Gaskets	JGI-17035-83-B	<b>477</b>	17369-06	68-9152F1	Cometic Gaskets	C9152F1	<b>456</b>
17035-83	681-4382	James Gaskets	JGI-17035-83-MLS	<b>477</b>	17369-06	68-9152F5	Cometic Gaskets	C9152F5	<b>456</b>
17040-92	681-4385	James Gaskets	JGI-17040-92	<b>477</b>	17386-99	681-4101	James Gaskets	JGI-17386-99	<b>474</b>
17040-92	681-4384	James Gaskets	JGI-17040-92-MLS	<b>477</b>	17393-07	68-9198	Cometic Gaskets	C9198	<b>466</b>
17041-92	681-4381	James Gaskets	JGI-17041-92-A	<b>477</b>	17393-07	681-5272	James Gaskets	JGI-17393-07	<b>491</b>
17041-92	681-4380	James Gaskets	JGI-17041-92-MLS	<b>477</b>	17507-48	68-9346	Cometic Gaskets	C9346	<b>464</b>
17041-92-A	68-9748F	Cometic Gaskets	C9748F	<b>458</b>	17507-48	681-5064	James Gaskets	JGI-17507-48	<b>487</b>
17041-92-A	68-9846F	Cometic Gaskets	C9846F	<b>458</b>	17536-70	68-9602	Cometic Gaskets	C9602	<b>468</b>
17041-92-A	68-99080E	Cometic Gaskets	C9908	<b>458</b>	17536-70	681-5520	James Gaskets	JGI-17536-70	<b>493</b>
17041-92-A	68-9974	Cometic Gaskets	C9974	<b>458</b>	17540-69	68-10008	Cometic Gaskets	C10008	<b>462</b>
17042-92A	68-9752	Cometic Gaskets	C9752	<b>458</b>	17540-69	68-9336	Cometic Gaskets	C9336	<b>462</b>
17042-92A	68-9753	Cometic Gaskets	C9753	<b>458</b>	17540-69	68-9986	Cometic Gaskets	C9986	<b>462</b>
17042-92A	68-9754F	Cometic Gaskets	C9754F	<b>465</b>	17540-69	681-4803	James Gaskets	JGI-17540-69	<b>483</b>
17042-92A	68-9755F	Cometic Gaskets	C9755F	<b>465</b>	17540-69	681-4804	James Gaskets	JGI-17540-69-A	<b>483</b>
17042-92A	68-9756F	Cometic Gaskets	C9756F	<b>465</b>	17540-69	681-4802	James Gaskets	JGI-17540-69-X	<b>483</b>
17043-95	681-4046	James Gaskets	JGI-17043-99	<b>473</b>	17540-69	681-4801	James Gaskets	JGI-17540-99-X	<b>483</b>
17045-99	68-9664	Cometic Gaskets	C9664	<b>456</b>	17541-48A	68-9342	Cometic Gaskets	C9342	<b>464</b>
17048-98	681-4049	James Gaskets	JGI-17048-98	<b>473</b>	17541-48B	681-5061	James Gaskets	JGI-17541-48-A	<b>487</b>
17049-04	68-9219	Cometic Gaskets	C9219	<b>465</b>	17541-48B	681-5062	James Gaskets	JGI-17541-48-B	<b>487</b>
17049-04	68-9970	Cometic Gaskets	C9970	<b>466</b>	17541-48B	681-5063	James Gaskets	JGI-17541-48-C	<b>487</b>
17049-04	68-9971	Cometic Gaskets	C9971	<b>466</b>	17541-48B	681-5060	James Gaskets	JGI-17541-48-DL	<b>487</b>
17049-04	681-5217	James Gaskets	JGI-17049-04-X	<b>490</b>	17591-99	68-9579	Cometic Gaskets	C9579	<b>456</b>
17049-04A	681-5216	James Gaskets	JGI-17049-07-X	<b>490</b>	17591-99	681-4103	James Gaskets	JGI-17591-99	<b>474</b>
17052-100	681-4017	James Gaskets	JGI-17054-99-MLS	<b>473</b>	17592-99	68-9580	Cometic Gaskets	C9580	<b>456</b>
17052-101	681-4019	James Gaskets	JGI-17054-99-X	<b>473</b>	17592-99	681-4105	James Gaskets	JGI-17592-99	<b>474</b>
17052-99	681-4020	James Gaskets	JGI-17052-99	<b>473</b>	17695-07	68-9197	Cometic Gaskets	C9197	<b>466</b>
17052-99	681-4016	James Gaskets	JGI-17052-99-MLS	<b>473</b>	17695-07	681-5271	James Gaskets	JGI-17695-07	<b>491</b>
17052-99	681-4018	James Gaskets	JGI-17052-99-X	<b>473</b>	17920-53A	820-58016	HardDrive	820-58016	<b>377</b>
17052-99	681-4021	James Gaskets	JGI-17054-99	<b>473</b>	17935-79	830-1128	Colony	9213-4	<b>375</b>
17052-99B	68-9146	Cometic Gaskets	C9146	<b>454</b>	17944-89	68-9295	Cometic Gaskets	C9295	<b>466</b>
17052-99B	681-4014	James Gaskets	JGI-17052-05	<b>473</b>	17944-89	681-5303	James Gaskets	JGI-17944-89	<b>491</b>
17052-99B	681-4012	James Gaskets	JGI-17052-05-X	<b>473</b>	17948-99	830-1119	Colony	9969-4	<b>375</b>
17052-99B	681-4015	James Gaskets	JGI-17054-05	<b>473</b>	17955-36	68-9598	Cometic Gaskets	C9598	<b>462</b>
17052-99B	681-4011	James Gaskets	JGI-17054-05-MLS	<b>473</b>	17955-36	681-4815	James Gaskets	JGI-17955-36	<b>483</b>
17052-99B	681-4013	James Gaskets	JGI-17054-05-X	<b>473</b>	17955-36A	681-4813	James Gaskets	JGI-17955-36-A	<b>483</b>
17053-99B	68-9171	Cometic Gaskets	C9171	<b>454</b>	17955-36-A	68-9408	Cometic Gaskets	C9408	<b>468</b>
17053-99B	681-4004	James Gaskets	JGI-17053-05	<b>473</b>	17955-48	68-9606	Cometic Gaskets	C9606	<b>462</b>
17053-99B	681-4005	James Gaskets	JGI-17053-05-X	<b>473</b>	17955-48	681-4819	James Gaskets	JGI-17955-48	<b>483</b>
17053-99B	681-4009	James Gaskets	JGI-17053-99	<b>473</b>	17955-48A	681-4817	James Gaskets	JGI-17955-48-A	<b>483</b>
17053-99B	681-4010	James Gaskets	JGI-17053-99-X	<b>473</b>	17976-04	68-9955	Cometic Gaskets	C9955	<b>466</b>
17053-99XX	68-9172	Cometic Gaskets	C9172	<b>454</b>	17976-04	681-5309	James Gaskets	JGI-17976-04	<b>491</b>
17286-99	68-9577	Cometic Gaskets	C9577	<b>455</b>	17976-04	681-5308	James Gaskets	JGI-17976-04-F	<b>491</b>
17353-86	68-9279	Cometic Gaskets	C9279	<b>465</b>	18000-81	68-9424	Cometic Gaskets	C9424	<b>462</b>
17353-86	681-5280	James Gaskets	JGI-17353-86	<b>491</b>	18000-81	68-9998	Cometic Gaskets	C9998	<b>462</b>
17353-86A	681-5278	James Gaskets	JGI-17353-86-A	<b>491</b>	18000-81	681-4822	James Gaskets	JGI-18000-81	<b>483</b>
17353-89	681-5275	James Gaskets	JGI-17353-89	<b>491</b>	18001-83	68-9836	Cometic Gaskets	C9836	<b>455</b>
17353-89A	681-5273	James Gaskets	JGI-17353-04	<b>491</b>	18001-83A	681-4125	James Gaskets	JGI-18001-83-A	<b>474</b>
17353-89B	68-9280	Cometic Gaskets	C9280	<b>465</b>	18023-87	191-17007	Kibble White	20-2013	<b>368</b>
17353-89C	68-9208	Cometic Gaskets	C9208	<b>465</b>	18024-87	191-17008	Kibble White	20-2014	<b>368</b>
17354-86	68-9275	Cometic Gaskets	C9275	<b>465</b>	18030-86	191-17006	Kibble White	20-20092	<b>368</b>
17354-86	681-5279	James Gaskets	JGI-17354-86	<b>491</b>	18031-86	191-17005	Kibble White	20-20090	<b>368</b>
17354-86A	68-9010	Cometic Gaskets	C9010	<b>465</b>	18046-98 S/EAGLE	68-9166	Cometic Gaskets	C9166	<b>455</b>
17354-86A	681-5277	James Gaskets	JGI-17354-86-A	<b>491</b>	18069-65R	191-17020	Kibble White	20-4167	<b>368</b>
17354-89	68-9276	Cometic Gaskets	C9276	<b>466</b>	18070-70	191-17021	Kibble White	20-4196	<b>368</b>
17354-89A	681-5274	James Gaskets	JGI-17354-89	<b>491</b>	18071-48	191-17013	Kibble White	20-4257	<b>368</b>
17355-84	681-4446	James Gaskets	JGI-17355-84	<b>478</b>	18071-58	191-17023	Kibble White	20-4258	<b>368</b>
17355-84A	68-9281	Cometic Gaskets	C9281	<b>458</b>	18074-05A	191-17011	Kibble White	20-20322	<b>368</b>
17355-84A	681-4444	James Gaskets	JGI-17355-84-A	<b>478</b>	18074-66	191-17003	Kibble White	20-4194	<b>368</b>
17355-92	68-9282	Cometic Gaskets	C9282	<b>458</b>	18074-83A	191-17001	Kibble White	20-4171	<b>368</b>
17355-92	681-4441	James Gaskets	JGI-17355-92	<b>478</b>	18080-58A	191-17015	Kibble White	20-4197	<b>368</b>
17356-84	681-4445	James Gaskets	JGI-17356-84	<b>478</b>	18080-58R	191-17015	Kibble White	20-4197	<b>368</b>
17356-84A	68-9277	Cometic Gaskets	C9277	<b>458</b>	18082-57A	191-17004	Kibble White	20-4195	<b>368</b>
17356-84A	681-4443	James Gaskets	JGI-17356-84-A	<b>478</b>	18082-57A	191-17004	Kibble White	20-4195	<b>368</b>
17356-92	68-9278	Cometic Gaskets	C9278	<b>459</b>	18082-83	191-17002	Kibble White	20-4170	<b>368</b>
17356-92	681-4440	James Gaskets	JGI-17356-92	<b>478</b>	18085-05A	191-17012	Kibble White	20-20325	<b>368</b>
1735-86A	68-9014	Cometic Gaskets	C9014	<b>465</b>	18094-02	68-9153	Cometic Gaskets	C9153	<b>455</b>
17358-84	68-9707F	Cometic Gaskets	C9707	<b>466</b>	18094-02	681-4124	James Gaskets	JGI-18094-02	<b>474</b>
17358-84	681-4447	James Gaskets	JGI-17358-84	<b>478</b>	18104-81A	191-57049C	Kibble White	20-2056C	<b>371</b>

WINDSHIELDS / FAIRINGS
AUDIO / COMMUNICATION
SEATS / LUGGAGE
BAR / MIRRORS / CONTROLS
EXHAUST
AIR / FUEL SYSTEMS
ENGINE
TRANSMISSION / DRIVELINE
GASKETS / SEALS
ELECTRICAL
LIGHTING
CABLES
BRAKES
OIL FILTERS
SUSPENSION
BODY
WHEELS
TIRES / TIRE ACC.
BIKE ACC.
VICTORY / INDIAN
COVERS / LOCKS / TIEDOWNS
CHEMICALS
TOOLS
HELMETS
HELMET ACC.
EYEWEAR
APPAREL / RIDER ACC.
PROMOTIONAL
REFERENCE
INDEX

# HARDDRIVE TO OEM CROSS REFERENCE

	OEM#	WPS#	Vendor	Vend#	Page#	OEM#	WPS#	Vendor	Vend#	Page#
WINDSHIELDS / FAIRINGS	18104-81A	191-57049C	Kibble White	20-2056C	371	24016-80	830-1145	Colony	2375-1	385
AUDIO / COMMUNICATION	18106-81A	191-57048C	Kibble White	20-2054C	371	24017-72 and 24017-80	830-1141	Colony	2288-1	385
SEATS / LUGGAGE	18108-81A	191-57047C	Kibble White	20-2052C	371	24023-36	830-1139	Colony	2286-1	385
BARS / MIRRORS / CONTROLS	18108-81A	191-57047C	Kibble White	20-2052C	371	24023-54	830-1150	Colony	2409-1	385
EXHAUST	18109-81A	191-57002C	Kibble White	20-2051C	371	24275-57A	820-58009	HardDrive	820-58009	367
AIR / FUEL SYSTEMS	18112-92	191-57003C	Kibble White	20-4320C	370	24275-80B	820-58010	HardDrive	820-58010	367
ENGINE	18130-83C	191-57004C	Kibble White	20-4321C	370	24275-86B	820-58011	HardDrive	820-58011	367
TRANSMISSION / DRIVELINE	18131-83C	191-57040C	Kibble White	20-4323C	370	24281-41B	820-58004	HardDrive	820-58004	367
GASKETS / SEALS	18133-83A	191-57039C	Kibble White	20-4322C	370	24281-74B	820-58005	HardDrive	820-58005	367
ELECTRICAL	18138-79A	191-57041C	Kibble White	20-2020C	371	24281-80A	820-58006	HardDrive	820-58006	367
LIGHTING	18138-79A	191-57042C	Kibble White	20-2021C	371	24281-83A	820-58007	HardDrive	820-58007	367
CABLES	18138-79A	191-57017C	Kibble White	20-2030C	371	24281-83B	820-58008	HardDrive	820-58008	367
BRAKES	18138-79A	191-57018C	Kibble White	20-2031C	371	24370-52B	820-58003	HardDrive	820-58003	367
OIL FILTERS	18138-79C	191-57041C	Kibble White	20-2020C	371	24385-40B	820-58001	HardDrive	820-58001	367
SUSPENSION	18138-79C	191-57017C	Kibble White	20-2030C	371	24931-39	681-5178	James Gaskets	JGI-24931-39	488
BODY	18140-79A	191-57046C	Kibble White	20-2026C	371	24978-57	68-9404	Cometic Gaskets	C9404	469
WHEELS	18140-79A	191-57022C	Kibble White	20-2036C	371	24978-57	681-5626	James Gaskets	JGI-24978-57	494
TIRES / TIRE ACC.	18141-79A	191-57045C	Kibble White	20-2024C	371	24982-70	830-1104	Colony	2146-2	384
BIKE ACC.	18141-79A	191-57021C	Kibble White	20-2034C	371	24990-52	681-5163	James Gaskets	JGI-24990-52	488
VICTORY / INDIAN	18143-79A	191-57043C	Kibble White	20-2022C	371	25224-52A	681-5604	James Gaskets	JGI-25224-52-A	494
COVERS / LOCKS / TIEDOWNS	18143-79A	191-57043C	Kibble White	20-2022C	371	25224-52A	681-5603	James Gaskets	JGI-25224-52-X	494
CHEMICALS	18143-79A	191-57019C	Kibble White	20-2032C	371	25225-36C	68-9334F5	Cometic Gaskets	C9334F5	463
TOOLS	18170-57A	191-57034C	Kibble White	20-2330C	371	25225-36C	681-4881	James Gaskets	JGI-25225-36-C	484
HELMETS	18172-57A	191-57035C	Kibble White	20-2331C	371	25225-36C	681-4880	James Gaskets	JGI-25225-36-CX	484
HELMET ACC.	18176-57A	191-57056C	Kibble White	20-2320C	371	25225-70	68-9302F1	Cometic Gaskets	C9302F1	459
EYEWEAR	18176-57A	191-57056C	Kibble White	20-2320C	371	25225-70A	681-4547	James Gaskets	JGI-25225-70-B	479
PROMOTIONAL	18176-57A	191-57056C	Kibble White	20-2320C	371	25225-70A	681-4546	James Gaskets	JGI-25225-70-X	479
REFERENCE	18176-57A	191-57056C	Kibble White	20-2320C	371	25225-70A	681-4545	James Gaskets	JGI-25225-70-XM	479
INDEX	18176-57A	191-57056C	Kibble White	20-2320C	371	25225-70B	68-9302F5	Cometic Gaskets	C9302F5	459
	18176-57A	191-57056C	Kibble White	20-2320C	371	25225-93	68-9328F1	Cometic Gaskets	C9328F1	459
	18179-57B	191-57057C	Kibble White	20-2321C	371	25225-93	68-9328F5	Cometic Gaskets	C9328F5	459
	18196-51	68-9419	Cometic Gaskets	C9419	462	25225-93B	681-4543	James Gaskets	JGI-25225-93	479
	18196-51	681-4826	James Gaskets	JGI-18196-51	483	25225-93B	681-4542	James Gaskets	JGI-25225-93-X	479
	18229-83	191-27788	Kibble White	20-2096	369	25225-93B	681-4541	James Gaskets	JGI-25225-93-XM	479
	18542-83A/18540-83A	820-58015	HardDrive	820-58015	377	25244-99	68-9575F1	Cometic Gaskets	C9575F1	456
	18570-38	830-1186	Colony	8780-4	373	25244-99	68-9575F5	Cometic Gaskets	C9575F5	456
	18600-66B/18610-66B	820-58013	HardDrive	820-58013	377	25244-99	681-4202	James Gaskets	JGI-25244-99	474
	18600-66B/18610-66B	820-58014	HardDrive	820-58014	377	25263-81	68-9332	Cometic Gaskets	C9332	468
	18633-48C	681-4467	James Gaskets	JGI-18633-48-A/C	478	25263-81	681-5602	James Gaskets	JGI-25263-81	494
	18633-48D	68-9297	Cometic Gaskets	C9297	462	25263-86	681-5386	James Gaskets	JGI-25263-86	491
	18633-48D	68-9297F	Cometic Gaskets	C9297F	459	25263-86	681-5385	James Gaskets	JGI-25263-86-X	491
	18633-48D	681-4463	James Gaskets	JGI-18633-48-D	478	25263-90	681-5383	James Gaskets	JGI-25263-90	491
	18633-48D	681-4461	James Gaskets	JGI-18633-48-X	478	25263-90	681-5382	James Gaskets	JGI-25263-90-X	491
	18634-48C	68-9298	Cometic Gaskets	C9298	462	25263-90B	68-9313F5	Cometic Gaskets	C9313F5	466
	18634-48C	68-9298F	Cometic Gaskets	C9298F	459	25263-90C	681-5380	James Gaskets	JGI-25263-90-X	491
	18634-48C	681-4466	James Gaskets	JGI-18634-48-A/B	478	25263-90D	68-9944F1	Cometic Gaskets	C9944F1	466
	18634-48C	681-4462	James Gaskets	JGI-18634-48-C	478	25263-90D	68-9944F5	Cometic Gaskets	C9944F5	466
	18634-48C	681-4460	James Gaskets	JGI-18634-48-X	478	25279-08	68-10029F1	Cometic Gaskets	C10029F1	466
	18635-99	68-9578F	Cometic Gaskets	C9578F	455	25279-08	68-10029F5	Cometic Gaskets	C10029F5	466
	18635-99	681-4120	James Gaskets	JGI-18635-99-F	474	25414-79A	681-4873	James Gaskets	JGI-25414-79-A	483
	18690-02	191-17028	Kibble White	20-20260	368	25414-82	681-5033	James Gaskets	JGI-25414-82-DL	486
	18691-02	191-17030	Kibble White	20-20265	368	25416-16	68-10140F1	Cometic Gaskets	C10140F1	453
	22265-00Y	681-5351	James Gaskets	JGI-26638-00-Y	491	25416-70	68-9338F1	Cometic Gaskets	C9338F1	463
	23557-83	275-01151	SMP	MCV0S2	525	25416-70	681-4941	James Gaskets	JGI-25416-70	485
	23901-81	830-1157	Colony	2570-2	385	25416-70	681-4942	James Gaskets	JGI-25416-70-C	485
	23902-81	830-1159	Colony	2572-1	385	25416-70	681-4622	James Gaskets	JGI-25416-70-DL	479
	23960-54	820-58002	HardDrive	820-58002	367	25416-70	681-4940	James Gaskets	JGI-25416-70-X	485
	23961-41	820-58000	HardDrive	820-58000	367	25416-70C	68-9338F5	Cometic Gaskets	C9338F5	463
	23961-80A	820-58020	HardDrive	820-58020	367	25416-84	68-9442	Cometic Gaskets	C9442	460
	23966-36	830-1171	Colony	7109-2	385	25416-84	681-4621	James Gaskets	JGI-25416-84	480
	23966-54A	830-1152	Colony	2412-2	385	25416-84	681-4620	James Gaskets	JGI-25416-84-X	480
	23967-41	830-1151	Colony	2411-2	385	25416-99	68-9662	Cometic Gaskets	C9662	456
	23967-54A	830-1156	Colony	2569-2	385	25416-99A	681-4267	James Gaskets	JGI-25416-99	475
	23969-83	830-1158	Colony	2571-2	385	25416-99A	681-4266	James Gaskets	JGI-25416-99-F	475
	23971-41	830-1153	Colony	2412-6	385	25416-99B	681-4269	James Gaskets	JGI-25416-99-X	475
	23971-54	830-1154	Colony	2413-6	385	25416-99C	68-9183F1	Cometic Gaskets	C9183F1	460
	24003-55	830-1182	Colony	7826-1	385	25416-99C	68-9183F5	Cometic Gaskets	C9183F5	460
	24015-36	830-1147	Colony	2384-4	385	25416-99C	68-997F1	Cometic Gaskets	C997F1	456
						25416-99C	68-997F5	Cometic Gaskets	C997F5	456
						25416-99C	681-4268	James Gaskets	JGI-25416-06-X	475
						25437-86	681-5430	James Gaskets	JGI-25437-86	492
						25463-94	681-5431	James Gaskets	JGI-25463-94	492

**HARDDRIVE TO OEM CROSS REFERENCE**

OEM#	WPS#	Vendor	Vend#	Page#
25463-94A	68-9220	Cometic Gaskets	C9220	<b>467</b>
25700370-K	681-6124	James Gaskets	JGI-25700370-K	<b>472</b>
25700378-K	681-6126	James Gaskets	JGI-25700378-K	<b>472</b>
25811-11	681-5001	James Gaskets	JGI-25811-11	<b>486</b>
26035-99B	820-58017	HardDrive	820-58017	<b>384</b>
26037-06	820-58018	HardDrive	820-58018	<b>384</b>
26072-90	68-9490F	Cometic Gaskets	C9490F	<b>460</b>
26072-90A	681-4665	James Gaskets	JGI-26072-90	<b>480</b>
26072-90A	681-4664	James Gaskets	JGI-26072-90-X	<b>480</b>
26072-99	68-9646F	Cometic Gaskets	C9646F	<b>456</b>
26072-99	681-4304	James Gaskets	JGI-26072-99	<b>475</b>
26072-99	681-4305	James Gaskets	JGI-26072-99-X	<b>475</b>
26077-93	68-9265F	Cometic Gaskets	C9265F	<b>460</b>
26077-93	681-4663	James Gaskets	JGI-26077-93	<b>480</b>
26077-99	68-9647F	Cometic Gaskets	C9647F	<b>456</b>
26077-99	681-4306	James Gaskets	JGI-26077-99	<b>475</b>
26227-58	68-9349	Cometic Gaskets	C9349	<b>460</b>
26227-58	681-4872	James Gaskets	JGI-26227-58	<b>484</b>
26231-78	68-9715	Cometic Gaskets	C9715	<b>462</b>
26231-78	681-4870	James Gaskets	JGI-26231-78	<b>484</b>
26244-37	68-9397	Cometic Gaskets	C9397	<b>462</b>
26245-41	68-9393	Cometic Gaskets	C9393	<b>462</b>
26245-41	681-4865	James Gaskets	JGI-26245-41	<b>484</b>
26246-68A	681-4861	James Gaskets	JGI-26246-68-A	<b>484</b>
26246-68A	681-4863	James Gaskets	JGI-26246-68-D	<b>484</b>
26246-68D	68-9391	Cometic Gaskets	C9391	<b>462</b>
26255-41	681-5121	James Gaskets	JGI-26255-41	<b>488</b>
26256-52	68-9390	Cometic Gaskets	C9390	<b>469</b>
26256-52	681-5579	James Gaskets	JGI-26256-52	<b>494</b>
26257-41	681-5120	James Gaskets	JGI-26257-41	<b>488</b>
26257-50A	68-9394	Cometic Gaskets	C9394	<b>462</b>
26257-50A	681-4864	James Gaskets	JGI-26257-50-A	<b>484</b>
26258-52	68-9385	Cometic Gaskets	C9385	<b>469</b>
26258-52	681-5577	James Gaskets	JGI-26258-52	<b>494</b>
26258-62	68-9389	Cometic Gaskets	C9389	<b>469</b>
26258-62	681-5575	James Gaskets	JGI-26258-62	<b>494</b>
26258-68B	681-4860	James Gaskets	JGI-26258-68-B	<b>484</b>
26258-68B	681-4862	James Gaskets	JGI-26258-68-D	<b>484</b>
26258-68D	68-9392	Cometic Gaskets	C9392	<b>462</b>
26259-52	68-9388	Cometic Gaskets	C9388	<b>469</b>
26259-52	681-5578	James Gaskets	JGI-26259-52	<b>494</b>
26259-52	681-5576	James Gaskets	JGI-26259-62	<b>494</b>
26259-62	68-9386	Cometic Gaskets	C9386	<b>469</b>
26263-80	830-1102	Colony	2073-2	<b>384</b>
26273-80B	68-9381	Cometic Gaskets	C9381	<b>460</b>
26273-80B	681-4512	James Gaskets	JGI-26273-80-AM	<b>478</b>
26273-80B	681-4514	James Gaskets	JGI-26273-80-B	<b>478</b>
26273-92	68-9383	Cometic Gaskets	C9383	<b>460</b>
26273-92	681-4510	James Gaskets	JGI-26273-92	<b>478</b>
26276-80A	68-9382	Cometic Gaskets	C9382	<b>460</b>
26276-80A	681-4515	James Gaskets	JGI-26276-80-A	<b>478</b>
26276-80A	681-4513	James Gaskets	JGI-26276-80-M	<b>478</b>
26276-92	681-4511	James Gaskets	JGI-26276-92	<b>478</b>
26340-36	681-4866	James Gaskets	JGI-26340-36	<b>484</b>
26348-15	681-4521	James Gaskets	JGI-26348-15	<b>478</b>
26348-36	681-4522	James Gaskets	JGI-26348-36	<b>478</b>
26381-92A	820-2680	HardDrive	820-2680	<b>399</b>
26432-76A	68-9287	Cometic Gaskets	C9287	<b>455</b>
26432-76A	681-4486	James Gaskets	JGI-26432-76-A	<b>478</b>
26432-76A	681-4487	James Gaskets	JGI-26432-76-X	<b>478</b>
26432-99	681-4147	James Gaskets	JGI-26432-99	<b>474</b>
26432-99	681-4148	James Gaskets	JGI-26432-99-X	<b>474</b>
26433-77	681-5581	James Gaskets	JGI-26433-77	<b>494</b>
26433-77 / 11301	68-9449	Cometic Gaskets	C9449	<b>456</b>
26434-76A	68-9439	Cometic Gaskets	C9439	<b>467</b>
26434-76A	68-9445	Cometic Gaskets	C9445	<b>469</b>
26434-76A	681-5366	James Gaskets	JGI-26434-76-A	<b>491</b>
26434-91	681-5367	James Gaskets	JGI-26434-91	<b>491</b>
26495-75	68-9399	Cometic Gaskets	C9399	<b>469</b>
26495-75	68-9399F	Cometic Gaskets	C9399F	<b>467</b>
26495-75	681-5364	James Gaskets	JGI-26495-75	<b>491</b>
26495-75	681-5363	James Gaskets	JGI-26495-75-F	<b>491</b>
26495-89	681-5362	James Gaskets	JGI-26495-89	<b>491</b>

OEM#	WPS#	Vendor	Vend#	Page#
26495-89	681-5361	James Gaskets	JGI-26495-89-DL	<b>491</b>
26495-89	681-5360	James Gaskets	JGI-26495-89-F	<b>491</b>
26495-89B	68-9315F	Cometic Gaskets	C9315F	<b>467</b>
26558-84	275-01150	SMP	MCVOS1	<b>525</b>
26561-99	275-01001	SMP	MCOPS4	<b>523</b>
26566-91	275-01152	SMP	MCVOS3	<b>525</b>
26856-89	68-9481	Cometic Gaskets	C9481	<b>459</b>
26856-89	681-5276	James Gaskets	JGI-26856-89	<b>491</b>
26858-99	68-9633	Cometic Gaskets	C9633	<b>455</b>
26858-99	681-4108	James Gaskets	JGI-26858-99	<b>474</b>
26995-86A	681-4219	James Gaskets	JGI-26992-99	<b>474</b>
26995-86A	681-4562	James Gaskets	JGI-26995-86-A	<b>479</b>
26995-86A	681-4563	James Gaskets	JGI-26995-97-X	<b>479</b>
26995-86A	681-4564	James Gaskets	JGI-26995-98	<b>479</b>
26995-86A/26992-99	68-9290	Cometic Gaskets	C9290	<b>456</b>
27002-89	68-9088	Cometic Gaskets	C9088	<b>456</b>
27002-89	681-4565	James Gaskets	JGI-27002-89	<b>479</b>
27006-76	865-01035	Cycle Pro	20706	<b>339</b>
27006-76T	681-4777	James Gaskets	JGI-27006-76	<b>340</b>
27006-88	865-01036	Cycle Pro	20709	<b>339</b>
27009-86B	820-2694	HardDrive	820-2694	<b>341</b>
27010-86B	820-2695	HardDrive	820-2695	<b>341</b>
27023-71	68-9417	Cometic Gaskets	C9417	<b>463</b>
27023-71	681-4891	James Gaskets	JGI-27023-71	<b>484</b>
27060-55	68-9453	Cometic Gaskets	C9453	<b>463</b>
27060-55	681-4893	James Gaskets	JGI-27060-55	<b>484</b>
27060-55	681-4894	James Gaskets	JGI-27060-55-V	<b>484</b>
27062-78	68-9608	Cometic Gaskets	C9608	<b>463</b>
27062-78	681-4890	James Gaskets	JGI-27062-78	<b>484</b>
27071-88T	820-2686	HardDrive	820-2686	<b>341</b>
27077-78	68-9425	Cometic Gaskets	C9425	<b>459</b>
27077-78	681-4560	James Gaskets	JGI-27077-78	<b>479</b>
27077-78	681-4561	James Gaskets	JGI-27077-78-X	<b>479</b>
27121-89	681-4597	James Gaskets	JGI-27121-89	<b>479</b>
27157-89	681-4600	James Gaskets	JGI-27157-89	<b>479</b>
27219-95	275-01034	SMP	MCFPR1	<b>522</b>
27237-95	681-4240	James Gaskets	JGI-27237-95	<b>475</b>
27244-95	681-4241	James Gaskets	JGI-27244-95	<b>475</b>
27270-95	275-01040	SMP	MCATS1	<b>522</b>
27311-76	865-01042	Cycle Pro	22733	<b>339</b>
27311-76A	681-4592	James Gaskets	JGI-27311-76-A	<b>479</b>
27312-76	681-4915	James Gaskets	JGI-27312-76	<b>484</b>
27324-83	681-4913	James Gaskets	JGI-27324-83	<b>484</b>
27326-71	681-5627	James Gaskets	JGI-27326-71	<b>494</b>
27336-76	681-4892	James Gaskets	JGI-27336-76	<b>484</b>
27337-76	865-01040	Cycle Pro	22731	<b>339</b>
27358-76	681-4916	James Gaskets	JGI-27358-76	<b>484</b>
27360-76	681-4591	James Gaskets	JGI-27360-76	<b>479</b>
27361-76	865-01039	Cycle Pro	22730	<b>339</b>
27361-76	681-4590	James Gaskets	JGI-27361-76	<b>479</b>
27374-57	681-4912	James Gaskets	JGI-27374-57	<b>484</b>
27378-57	681-5166	James Gaskets	JGI-27378-57	<b>488</b>
27385-76	681-4594	James Gaskets	JGI-27385-76	<b>479</b>
27402-33	681-5164	James Gaskets	JGI-27402-33	<b>488</b>
27403-71	681-4910	James Gaskets	JGI-27403-71	<b>484</b>
27404-71	681-4911	James Gaskets	JGI-27404-71	<b>484</b>
27410-57	681-5140	James Gaskets	JGI-27410-57	<b>488</b>
27444-00Y	68-9201	Cometic Gaskets	C9201	<b>455</b>
27444-00Y	681-4330	James Gaskets	JGI-27444-00-Y	<b>476</b>
27483-07	820-2634	HardDrive	820-2634	<b>341</b>
27577-88	681-4599	James Gaskets	JGI-27577-88	<b>479</b>
27577-92	681-4598	James Gaskets	JGI-27577-92	<b>479</b>
27581-88	820-50921	HardDrive	820-50921	<b>339</b>
27585-88	865-01032	Cycle Pro	20755	<b>339</b>
27594-76	820-50569	HardDrive	820-50569	<b>342</b>
27609-01	275-01038	SMP	MCINJ3	<b>522</b>
27628-01A	275-01037	SMP	MCIAC3	<b>522</b>
27629-01	275-01030	SMP	MCTPS1	<b>522</b>
27646-71	681-5625	James Gaskets	JGI-27646-71	<b>494</b>
27658-06	275-01036	SMP	MCIAC2	<b>522</b>
27659-06	275-01031	SMP	MCTPS2	<b>522</b>
27683-07	865-01001	Cycle Pro	14273	<b>332</b>
27703-08	865-01002	Cycle Pro	14274	<b>332</b>

WINDSHIELDS / FAIRINGS
AUDIO / COMMUNICATION
SEATS / LUGGAGE
BAR / MIRRORS / CONTROLS
EXHAUST
AIR / FUEL SYSTEMS
ENGINE
TRANSMISSION / DRIVELINE
GASKETS / SEALS
ELECTRICAL
LIGHTING
CABLES
BRAKES
OIL FILTERS
SUSPENSION
BODY
WHEELS
TIRES / TIRE ACC.
BIKE ACC.
VICTORY / INDIAN
COVERS / LOCKS / TIEDOWNS
CHEMICALS
TOOLS
HELMETS
HELMET ACC.
EYEWEAR
APPAREL / RIDER ACC.
PROMOTIONAL
REFERENCE
INDEX

# HARDDRIVE TO OEM CROSS REFERENCE

	OEM#	WPS#	Vendor	Vend#	Page#	OEM#	WPS#	Vendor	Vend#	Page#
WINDSHIELDS / FAIRINGS	27719-07	865-01000	Cycle Pro	14272	<b>332</b>	29951-99	273-1431	Cycle Electric	CE-9902	<b>529</b>
AUDIO / COMMUNICATION	27886-78	865-01041	Cycle Pro	22732	<b>339</b>	29965-75	273-1412	Cycle Electric	CE-7680	<b>529</b>
SEATS / LUGGAGE	27889-78	681-4914	James Gaskets	JGI-27889-78	<b>484</b>	29965-81A	273-1421	Cycle Electric	CE-8188	<b>529</b>
BARS / MIRRORS / CONTROLS	27892-78	681-4917	James Gaskets	JGI-27892-78	<b>484</b>	29967-84A	273-1424	Cycle Electric	CE-8590	<b>529</b>
EXHAUST	27964-00	681-4243	James Gaskets	JGI-27964-00	<b>475</b>	29967-89	273-1429	Cycle Electric	CE-9100	<b>529</b>
AIR / FUEL SYSTEMS	28780CP	820-50835	HardDrive	820-50835	<b>211</b>	29970-88	273-1426	Cycle Electric	CE-8999	<b>529</b>
ENGINE	29036-41	NU-3412	UNI filter	NU-3412	<b>323</b>	29975-65A	26-20003	WPS Starter	GHD0003	<b>532</b>
TRANSMISSION / DRIVELINE	29036-72	NU-3403	UNI filter	NU-3403	<b>323</b>	29975-65A/29978-77A	280-2001	All Balls Racing	80-2001	<b>532</b>
GASKETS / SEALS	29036-72	NU-3403	UNI filter	NU-3403	<b>323</b>	29987-02	273-1402	Cycle Electric	CE-3845-02	<b>529</b>
ELECTRICAL	29036-86T	722085	K&N	HD-2085	<b>321</b>	29987-06A	273-1418	Cycle Electric	CE-8012	<b>529</b>
LIGHTING	29036-88	NU-3424	UNI filter	NU-3424	<b>323</b>	29987-97	273-1403	Cycle Electric	CE-3845-97	<b>529</b>
CABLES	29036-88B/29331-96	721388	K&N	HD-1388	<b>321</b>	29987-99	273-1404	Cycle Electric	CE-3845-99	<b>529</b>
BRAKES	29044-04B	720900	K&N	HD-0900	<b>321</b>	29997-07	273-1401	Cycle Electric	CE-0732	<b>529</b>
OIL FILTERS	29058-77	68-9300	Cometic Gaskets	C9300	<b>459</b>	30017-01	273-1405	Cycle Electric	CE-6010	<b>529</b>
SUSPENSION	29058-77	681-4570	James Gaskets	JGI-29058-77	<b>479</b>	30017-01	273-1405	Cycle Electric	CE-6010	<b>529</b>
BODY	29058-77	681-4896	James Gaskets	JGI-29058-77-A	<b>484</b>	30017-07	273-1413	Cycle Electric	CE-8010-07	<b>529</b>
WHEELS	29059-88	681-4568	James Gaskets	JGI-29059-88	<b>479</b>	30017-07	273-1413	Cycle Electric	CE-8010-07	<b>529</b>
TIRES / TIRE ACC.	29059-88	681-4569	James Gaskets	JGI-29059-88-A	<b>479</b>	30017-08	273-1415	Cycle Electric	CE-8010-08	<b>529</b>
BIKE ACC.	29059-88	681-4567	James Gaskets	JGI-29059-88-X	<b>479</b>	30017-08	273-1415	Cycle Electric	CE-8010-08	<b>529</b>
VICTORY / INDIAN	29059-88-A	68-9301	Cometic Gaskets	C9301	<b>461</b>	30143-30	68-9322	Cometic Gaskets	C9322	<b>462</b>
COVERS / LOCKS / TIEDOWNS	29062-95	68-9626F	Cometic Gaskets	C9626F	<b>456</b>	30143-30	681-5102	James Gaskets	JGI-30143-30	<b>488</b>
CHEMICALS	29062-95B	681-4244	James Gaskets	JGI-29062-95-B	<b>475</b>	30143-58	68-9321	Cometic Gaskets	C9321	<b>469</b>
TOOLS	29086-75	NU-3405	UNI filter	NU-3405	<b>323</b>	30143-58	68-9321F	Cometic Gaskets	C9321F	<b>462</b>
HELMETS	29086-75	NU-3405	UNI filter	NU-3405	<b>323</b>	30143-58	681-5101	James Gaskets	JGI-30143-58	<b>488</b>
HELMET ACC.	29095-95	681-4571	James Gaskets	JGI-29095-95	<b>479</b>	30145-46A	681-5007	James Gaskets	JGI-30145-46-A	<b>486</b>
EYEWEAR	29191-08	729608	K&N	HD-9608	<b>321</b>	31015-30	681-5103	James Gaskets	JGI-31015-30	<b>488</b>
APPAREL / RIDER ACC.	29209-86	70-6247	Motion Pro	06-0247	<b>643</b>	31320-80	68-9507F	Cometic Gaskets	C9507F	<b>460</b>
PROMOTIONAL	29210-86	70-6247	Motion Pro	06-0247	<b>643</b>	31320-80	681-4708	James Gaskets	JGI-31320-80	<b>481</b>
REFERENCE	29211-86	70-6205	Motion Pro	06-0205	<b>643</b>	31321-80	68-9508F	Cometic Gaskets	C9508F	<b>461</b>
INDEX	29213-79	70-6205	Motion Pro	06-0205	<b>643</b>	31321-80	681-4709	James Gaskets	JGI-31321-80	<b>481</b>
	29216-72	70-6244	Motion Pro	06-0244	<b>643</b>	31341-80	681-4636	James Gaskets	JGI-31341-80-DL	<b>480</b>
	29219-78	70-6244	Motion Pro	06-0244	<b>643</b>	31341-80-DL	68-9509	Cometic Gaskets	C9509	<b>461</b>
	29225-79	70-6247	Motion Pro	06-0247	<b>643</b>	31390-86	280-1009	All Balls Racing	80-1009	<b>534</b>
	29229-88/A	70-6204	Motion Pro	06-0204	<b>643</b>	31390-86	26-20004	WPS Starter	SHD0004	<b>533</b>
	29236-90	70-6204	Motion Pro	06-0204	<b>643</b>	31390-91B	280-1010	All Balls Racing	80-1010	<b>534</b>
	29238-92	70-6295	Motion Pro	06-0295	<b>643</b>	31433-84	681-4626	James Gaskets	JGI-31433-84	<b>480</b>
	29241-08	681-4211	James Gaskets	JGI-29241-08	<b>474</b>	31433-84A	68-9363	Cometic Gaskets	C9363	<b>460</b>
	29242-83	68-9299	Cometic Gaskets	C9299	<b>459</b>	31433-84A	681-4627	James Gaskets	JGI-31433-84-A	<b>480</b>
	29242-83	681-4566	James Gaskets	JGI-29242-83	<b>479</b>	31443-65	820-60300	HardDrive	820-60300	<b>535</b>
	29244-08	720818	K&N	HD-0818	<b>321</b>	31443-65A	279-2109	All Balls Racing	79-2109	<b>536</b>
	29259-83TA	722084	K&N	HD-2084	<b>321</b>	31461-70	68-9701F	Cometic Gaskets	C9701	<b>469</b>
	29259-86	NU-3423	UNI filter	NU-3423	<b>323</b>	31461-70	681-5674	James Gaskets	JGI-31461-70	<b>495</b>
	29259-86T	722086	K&N	HD-2086	<b>321</b>	31463-88T	280-1007	All Balls Racing	80-1007	<b>534</b>
	29259-89	NU-3425	UNI filter	NU-3425	<b>323</b>	31463-88T	26-20001	WPS Starter	SHD0001	<b>533</b>
	29259-91A/29330-96	721390	K&N	HD-1390	<b>321</b>	31471-67	681-5675	James Gaskets	JGI-31471-67-A	<b>495</b>
	29259-93	NU-3427	UNI filter	NU-3427	<b>323</b>	31471-67A	68-9324	Cometic Gaskets	C9324	<b>469</b>
	29291-95	721395	K&N	HD-1395	<b>321</b>	31478-65	681-4956	James Gaskets	JGI-31478-65-X	<b>485</b>
	29313-95	68-9634F	Cometic Gaskets	C9634F	<b>456</b>	31488-77	68-9333	Cometic Gaskets	C9333	<b>469</b>
	29313-95	681-4217	James Gaskets	JGI-29313-95	<b>474</b>	31488-77	681-5673	James Gaskets	JGI-31488-77	<b>495</b>
	29314-08	721611	K&N	HD-1611	<b>321</b>	31488-77	681-5672	James Gaskets	JGI-31488-77-F	<b>495</b>
	29331-04	728834	K&N	HD-8834	<b>321</b>	31488-81	68-9312	Cometic Gaskets	C9312	<b>469</b>
	29368-99	68-9641F	Cometic Gaskets	C9641F	<b>456</b>	31488-81	681-5472	James Gaskets	JGI-31488-81	<b>492</b>
	29368-99	681-4242	James Gaskets	JGI-29368-99	<b>475</b>	31488-81	681-5471	James Gaskets	JGI-31488-81-F	<b>492</b>
	29377-08	721208	K&N	HD-1208	<b>321</b>	31497-65	681-4950	James Gaskets	JGI-31497-65	<b>485</b>
	29385-08	720808	K&N	HD-0808	<b>321</b>	31504-91A	275-01093	SMP	MCRLY4	<b>524</b>
	29437-01	721102	K&N	HD-1102	<b>321</b>	31506-79B	275-01091	SMP	MCRLY2	<b>524</b>
	29442-99A/B/C/D/E	720800	K&N	HD-0800	<b>321</b>	31511-01A	275-01095	SMP	MCRLY6	<b>524</b>
	29461-99	721499	K&N	HD-1499	<b>321</b>	31522-00	275-01094	SMP	MCRLY5	<b>524</b>
	29462-99	728899	K&N	HD-8899	<b>321</b>	31544-90	279-2103	All Balls Racing	79-2103	<b>536</b>
	29463-99	68-9643F	Cometic Gaskets	C9643F	<b>456</b>	31553-90	280-1001	All Balls Racing	80-1001	<b>534</b>
	29463-99	681-4216	James Gaskets	JGI-29463-99	<b>475</b>	31553-90	280-1003	All Balls Racing	80-1003	<b>534</b>
	29550-55	68-9327	Cometic Gaskets	C9327	<b>469</b>	31553-90	26-20006	WPS Starter	SHD0006	<b>533</b>
	29550-55	681-5561	James Gaskets	JGI-29550-55	<b>493</b>	31553-94	280-1002	All Balls Racing	80-1002	<b>534</b>
	29583-01	681-4213	James Gaskets	JGI-29583-01	<b>475</b>	31553-94	280-1004	All Balls Racing	80-1004	<b>534</b>
	29583-01A	681-4212	James Gaskets	JGI-29583-01-A	<b>475</b>	31553-94	26-20006C	WPS Starter	SHD0006C	<b>533</b>
	29603-48	681-5562	James Gaskets	JGI-29603-48	<b>493</b>	31570-73	280-1005	All Balls Racing	80-1005	<b>534</b>
	29633-08	721508	K&N	HD-1508	<b>321</b>	31570-73	26-30011	WPS Starter	SHI0011	<b>533</b>
	29645-08	68-10007	Cometic Gaskets	C10007	<b>456</b>	31570-73	26-30011C	WPS Starter	SHI0011-C	<b>533</b>
	29645-08	681-4214	James Gaskets	JGI-29645-08	<b>475</b>	31586-07	275-01097	SMP	MCRLY9	<b>524</b>
	29670-09	720910	K&N	HD-0910	<b>321</b>	31601-04	275-01096	SMP	MCRLY8	<b>524</b>
	29911-82	681-5563	James Gaskets	JGI-29911-82	<b>493</b>	31618-06	280-1013	All Balls Racing	80-1013	<b>534</b>
	29951-99	273-1431	Cycle Electric	CE-9902	<b>529</b>	31618-06	26-20013	WPS Starter	SHD0013	<b>533</b>

**HARDDRIVE TO OEM CROSS REFERENCE**

OEM#	WPS#	Vendor	Vend#	Page#	OEM#	WPS#	Vendor	Vend#	Page#
31618-06A	280-1014	All Balls Racing	80-1014	534	34824-36	68-9522F	Cosmetic Gaskets	C9522F	463
31618-06A	26-20013C	WPS Starter	SHD0013-C	533	34824-36	681-4970	James Gaskets	JGI-34824-36	486
31633-07	820-60304	HardDrive	820-60304	535	34824-79	68-9516-032AFM	Cosmetic Gaskets	C9516-032AFM	460
31663-90	279-2101	All Balls Racing	79-2101	536	34824-79	681-4653	James Gaskets	JGI-34824-79	480
31663-90	820-60303	HardDrive	820-60303	535	34901-07	68-9179F1	Cosmetic Gaskets	C9179F1	457
31663-90	820-60302	HardDrive	820-60302	535	34901-07	68-9179F5	Cosmetic Gaskets	C9179F5	457
31681-07	279-2104	All Balls Racing	79-2104	536	34901-07	681-4261	James Gaskets	JGI-34901-07	475
31695-90	681-4331	James Gaskets	JGI-31695-90	476	34901-07	681-4260	James Gaskets	JGI-34901-07-F	475
31717-01K	26-20020	WPS Starter	SHD0020	533	34901-79	681-4932	James Gaskets	JGI-34901-79	485
32315-01	275-01033	SMP	MCTS2	522	34901-79	681-4612	James Gaskets	JGI-34901-79-A	480
32316-99	275-01043	SMP	MCMAP3	522	34901-79	681-4611	James Gaskets	JGI-34901-79-B	480
32400-80A	275-01070	SMP	MCSPA1	525	34901-85	68-9308F1	Cosmetic Gaskets	C9308F1	460
32400-94	275-01072	SMP	MCSPA3	525	34901-85	68-9308F5	Cosmetic Gaskets	C9308F5	460
32404-90	275-01071	SMP	MCSPA2	525	34901-94	68-9307F1	Cosmetic Gaskets	C9307F1	457
32424-95	275-01041	SMP	MCMAP1	522	34901-94	68-9307F5	Cosmetic Gaskets	C9307F5	457
32446-99	275-01032	SMP	MCTS1	522	34901-94	681-4264	James Gaskets	JGI-34901-94	475
32521-36	68-9337	Cosmetic Gaskets	C9337	464	34902-79A	681-4623	James Gaskets	JGI-34902-79-A	480
32521-36	681-5002	James Gaskets	JGI-32521-36	486	34903-79	681-4624	James Gaskets	JGI-34903-79	480
32522-37	68-9325	Cosmetic Gaskets	C9325	468	34904-00	68-9267	Cosmetic Gaskets	C9267	457
32591-70	68-9323	Cosmetic Gaskets	C9323	463	34904-79	68-9499F	Cosmetic Gaskets	C9499F	460
32591-70	681-5671	James Gaskets	JGI-32591-70	495	34904-79	681-4652	James Gaskets	JGI-34904-79	480
32591-70	681-5670	James Gaskets	JGI-32591-70-F	495	34904-86	681-4651	James Gaskets	JGI-34904-86	480
32591-80	68-9306	Cosmetic Gaskets	C9306	463	34904-86	681-4650	James Gaskets	JGI-34904-86-X	480
32591-80	68-9306F	Cosmetic Gaskets	C9306F	459	34904-86B	68-9983F	Cosmetic Gaskets	C9983F	460
32591-80	681-4710	James Gaskets	JGI-32591-80	481	34904-86C	681-4292	James Gaskets	JGI-34904-00-X	475
32591-80	681-4711	James Gaskets	JGI-32591-80-F	481	34904-86C	681-4293	James Gaskets	JGI-34917-99	475
32661-70	275-01020	SMP	MCDR2240X	553	34906-79	68-9303F1	Cosmetic Gaskets	C9303F1	460
32726-30A	275-01022	SMP	MCDR60X	553	34906-79	68-9303F5	Cosmetic Gaskets	C9303F5	460
32726-30A	275-01023	SMP	MCDR90X	553	34906-79	681-4935	James Gaskets	JGI-34906-79	485
33031-17	681-6121	James Gaskets	JGI-33031-17	472	34906-79	681-4618	James Gaskets	JGI-34906-79-A	480
33031-70	68-9464	Cosmetic Gaskets	C9464	463	34906-79	681-4938	James Gaskets	JGI-34906-79-DL	485
33031-70	68-9464F	Cosmetic Gaskets	C9464F	462	34906-85	68-9305F1	Cosmetic Gaskets	C9305F1	456
33031-80	68-9465	Cosmetic Gaskets	C9465	463	34906-85	681-4617	James Gaskets	JGI-34906-85	480
33031-82	68-9466	Cosmetic Gaskets	C9466	460	34906-85	681-4619	James Gaskets	JGI-34906-85-DL	480
33031-85	68-9467	Cosmetic Gaskets	C9467	460	34906-85	681-4616	James Gaskets	JGI-34906-85-X	480
33031-91	68-9468	Cosmetic Gaskets	C9468	460	34906-85A	68-9305F5	Cosmetic Gaskets	C9305F5	456
33043-80	68-9497	Cosmetic Gaskets	C9497	461	34917-06	68-9189	Cosmetic Gaskets	C9189	457
33043-80	681-4690	James Gaskets	JGI-33043-80	480	34917-06	681-4290	James Gaskets	JGI-34917-06-F	475
33057-72	820-53008	HardDrive	820-53008	427	34917-06	681-4291	James Gaskets	JGI-34917-06-X	475
33068-54	820-53011	HardDrive	820-53011	427	34917-90	68-9488F	Cosmetic Gaskets	C9488F	460
33076-37	68-9384	Cosmetic Gaskets	C9384	460	34917-90	681-4294	James Gaskets	JGI-34917-90	475
33076-37	681-4988	James Gaskets	JGI-33076-37	485	34917-90	681-4295	James Gaskets	JGI-34917-90-X	475
33076-37/29603-48	68-9374	Cosmetic Gaskets	C9374	461	34917-99	68-9645F	Cosmetic Gaskets	C9645F	457
33085-36T	820-53015	HardDrive	820-53015	427	34934-06	68-9199F1	Cosmetic Gaskets	C9199F1	457
33126-90/33126-93	279-2105	All Balls Racing	79-2105	536	34934-06	68-9199F5	Cosmetic Gaskets	C9199F5	457
33126-94	279-2106	All Balls Racing	79-2106	536	34934-06	681-4271	James Gaskets	JGI-34934-06	475
33196-79	68-9517F	Cosmetic Gaskets	C9517F	461	34952-52	68-9317F5	Cosmetic Gaskets	C9317F5	469
33196-79	681-4662	James Gaskets	JGI-33196-79	480	34952-52	681-5639	James Gaskets	JGI-34952-52	494
33295-36	68-9515-032AFM	Cosmetic Gaskets	C9515-032AFM	460	34952-52	681-5638	James Gaskets	JGI-34952-52-A	494
33295-36	681-4657	James Gaskets	JGI-33295-36	480	34955-04	68-9943F1	Cosmetic Gaskets	C9943F1	467
33295-36	681-4656	James Gaskets	JGI-33295-36-X	480	34955-04	68-9943F5	Cosmetic Gaskets	C9943F5	467
33318-85	681-4631	James Gaskets	JGI-33318-85	480	34955-04	681-5421	James Gaskets	JGI-34955-04-F	492
33340-90	681-4637	James Gaskets	JGI-33340-90	480	34955-67	68-9318F5	Cosmetic Gaskets	C9318F5	469
33345-89	681-4632	James Gaskets	JGI-33345-89	480	34955-67	681-5637	James Gaskets	JGI-34955-67-A	494
33668-07	820-54214	HardDrive	820-54214	437	34955-67	681-5635	James Gaskets	JGI-34955-67-F	494
33709-82A	820-51762	HardDrive	820-51762	437	34955-67	681-5636	James Gaskets	JGI-34955-67-F5	494
33900-59C	275-01081	SMP	MCNSS2	523	34955-67A	68-9703	Cosmetic Gaskets	C9703	469
33901-79	275-01083	SMP	MCNSS4	523	34955-75	68-9310F1	Cosmetic Gaskets	C9310F1	467
33902-98	275-01084	SMP	MCNSS5	523	34955-75	68-9310F5	Cosmetic Gaskets	C9310F5	467
33904-00	275-01085	SMP	MCNSS6	523	34955-75	681-5426	James Gaskets	JGI-34955-75	492
34035-52	68-9370	Cosmetic Gaskets	C9370	469	34955-75	681-5427	James Gaskets	JGI-34955-75-F	492
34035-52	681-5640	James Gaskets	JGI-34035-52	494	34955-75	681-5428	James Gaskets	JGI-34955-75-F5	492
34036-36	68-9519	Cosmetic Gaskets	C9519	463	34955-75	681-5429	James Gaskets	JGI-34955-75-X	492
34036-36	681-4971	James Gaskets	JGI-34036-36	485	34955-89	68-9314F1	Cosmetic Gaskets	C9314F1	467
34036-80	68-9510	Cosmetic Gaskets	C9510	461	34955-89	681-5425	James Gaskets	JGI-34955-89	492
34036-80	681-4689	James Gaskets	JGI-34036-80	480	34955-89	681-5422	James Gaskets	JGI-34955-89-F	492
34552-52	68-9520F	Cosmetic Gaskets	C9520F	463	34955-89	681-5423	James Gaskets	JGI-34955-89-F5	492
34552-52	681-4976	James Gaskets	JGI-34552-52	486	34955-89	681-5424	James Gaskets	JGI-34955-89-X	492
34565-52	68-9521F	Cosmetic Gaskets	C9521F	463	34955-89A	68-9314F5	Cosmetic Gaskets	C9314F5	467
34565-52	681-4977	James Gaskets	JGI-34565-52	486	34986-04	68-9957	Cosmetic Gaskets	C9957	467
34624-77	68-9401	Cosmetic Gaskets	C9401	467	34990-08	681-5420	James Gaskets	JGI-34990-08	492
34624-77	681-5454	James Gaskets	JGI-34624-77	492					

WINDSHIELDS / FAIRINGS  
 AUDIO / COMMUNICATION  
 SEATS / LUGGAGE  
 BARS / MIRRORS / CONTROLS  
 EXHAUST  
 AIR / FUEL SYSTEMS  
 ENGINE  
 TRANSMISSION / DRIVELINE  
 GASKETS / SEALS  
 ELECTRICAL  
 LIGHTING  
 CABLES  
 BRAKES  
 OIL FILTERS  
 SUSPENSION  
 BODY  
 WHEELS  
 TIRES / TIRE ACC.  
 BIKE ACC.  
 VICTORY / INDIAN  
 COVERS / LOCKS / TIEDOWNS  
 CHEMICALS  
 TOOLS  
 HELMETS  
 HELMET ACC.  
 EYEWEAR  
 APPAREL / RIDER ACC.  
 PROMOTIONAL  
 REFERENCE  
 INDEX

**HARDDRIVE TO OEM CROSS REFERENCE**

	OEM#	WPS#	Vendor	Vend#	Page#	OEM#	WPS#	Vendor	Vend#	Page#
WINDSHIELDS / FAIRINGS	35046-36 and 35050-40	830-1155	Colony	2430-2	<b>434</b>	37762-52	68-9319	Cometic Gaskets	C9319	<b>469</b>
AUDIO / COMMUNICATION	35047-71A and 35050-52	830-1163	Colony	2679-2	<b>434</b>	37762-52	681-5650	James Gaskets	JGI-37762-52	<b>495</b>
SEATS / LUGGAGE	35147-03	681-4300	James Gaskets	JGI-35147-03-F	<b>476</b>	37871-84	810-4003	Alto Clutches	26767	<b>405</b>
BARS / MIRRORS / CONTROLS	35147-03	681-4301	James Gaskets	JGI-35147-03-X	<b>476</b>	37906-90	22-53104	All Balls Racing	5207-2RS	<b>412</b>
EXHAUST	35148-03	681-4298	James Gaskets	JGI-35148-03-F	<b>476</b>	37975-41/37975-81	810-4160	Alto Clutches	095761-290	<b>405</b>
AIR / FUEL SYSTEMS	35148-03	681-4299	James Gaskets	JGI-35148-03-X	<b>476</b>	37975-41/37975-81	810-4161	Alto Clutches	095761A290	<b>405</b>
ENGINE	35151-52A	68-9366	Cometic Gaskets	C9366	<b>469</b>	37975-41/37975-81	810-4162	Alto Clutches	095761B290	<b>405</b>
ENGINE	35151-52A	681-5560	James Gaskets	JGI-35151-52-A	<b>493</b>	37975-90/37977-90	810-4169	Alto Clutches	95763	<b>405</b>
ENGINE	35151-74	68-9353	Cometic Gaskets	C9353	<b>467</b>	38010-41	820-54718	HardDrive	820-54718	<b>410</b>
ENGINE	35151-74	681-5350	James Gaskets	JGI-35151-74	<b>491</b>	38075-41	191-27791	Kibble White	20-0788	<b>412</b>
ENGINE	35154-52	681-5686	James Gaskets	JGI-35154-52	<b>495</b>	38075-41	191-27791	Kibble White	20-0788	<b>412</b>
TRANSMISSION / DRIVELINE	35175-38	681-4975	James Gaskets	JGI-35175-38	<b>486</b>	38075-68	191-27790	Kibble White	20-0789	<b>412</b>
TRANSMISSION / DRIVELINE	35211-91B	830-1144	Colony	2320-1	<b>434</b>	38599-80A	70-6004	Motion Pro	06-0004	<b>640</b>
GASKETS / SEALS	35216-36	681-4972	James Gaskets	JGI-35216-36	<b>486</b>	38599-80A +4	70-6046	Motion Pro	06-0046	<b>640</b>
GASKETS / SEALS	35230-39DL	68-9523	Cometic Gaskets	C9523	<b>463</b>	38599-83A	70-6005	Motion Pro	06-0005	<b>640</b>
ELECTRICAL	35231-36	68-9411	Cometic Gaskets	C9411	<b>463</b>	38599-83A	70-6123	Motion Pro	06-0123	<b>640</b>
ELECTRICAL	35231-36	681-4974	James Gaskets	JGI-35231-36	<b>486</b>	38599-83A	70-660072	Motion Pro	66-0072	<b>647</b>
ELECTRICAL	35607-06	681-4314	James Gaskets	JGI-35607-06	<b>476</b>	38599-83A +6	70-660223	Motion Pro	66-0223	<b>647</b>
ELECTRICAL	35607-73	681-4985	James Gaskets	JGI-35607-73	<b>486</b>	38601-87+8	70-6222	Motion Pro	06-0222	<b>640</b>
LIGHTING	35652-79	681-4655	James Gaskets	JGI-35652-79-A	<b>481</b>	38601-89	70-6145	Motion Pro	06-0145	<b>640</b>
LIGHTING	35652-79	681-4654	James Gaskets	JGI-35652-79-X	<b>481</b>	38601-89	70-660158	Motion Pro	66-0158	<b>647</b>
CABLES	35652-79A	68-9264F	Cometic Gaskets	C9264F	<b>460</b>	38601-89 +12	70-6251	Motion Pro	06-0251	<b>640</b>
CABLES	35653-98	68-9644F	Cometic Gaskets	C9644F	<b>457</b>	38601-89 +12	70-660262	Motion Pro	66-0262	<b>647</b>
BRAKES	35653-98	681-4307	James Gaskets	JGI-35653-98	<b>476</b>	38601-89 +16	70-6293	Motion Pro	06-0293	<b>640</b>
BRAKES	35654-06	68-9187	Cometic Gaskets	C9187	<b>457</b>	38601-89 +6	70-6164	Motion Pro	06-0164	<b>640</b>
BRAKES	35654-06	681-4302	James Gaskets	JGI-35654-06-F	<b>476</b>	38601-89 +6	70-660170	Motion Pro	66-0170	<b>647</b>
BRAKES	35654-06	681-4303	James Gaskets	JGI-35654-06-X	<b>476</b>	38602-92	70-6164	Motion Pro	06-0164	<b>640</b>
OIL FILTERS	36025-36	681-5190	James Gaskets	JGI-36025-36	<b>489</b>	38602-92	70-660170	Motion Pro	66-0170	<b>647</b>
OIL FILTERS	36753-87A	70-6144	Motion Pro	06-0144	<b>641</b>	38602-92 +2	70-6222	Motion Pro	06-0222	<b>640</b>
OIL FILTERS	36753-87A	70-660157	Motion Pro	66-0157	<b>648</b>	38602-92 +6	70-660262	Motion Pro	66-0262	<b>647</b>
SUSPENSION	36753-87A +6	70-6163	Motion Pro	06-0163	<b>641</b>	38605-86	70-6086	Motion Pro	06-0086	<b>640</b>
SUSPENSION	36753-87A +6	70-660169	Motion Pro	66-0169	<b>648</b>	38605-86	70-660252	Motion Pro	66-0252	<b>647</b>
BODY	36755-87A	70-6143	Motion Pro	06-0143	<b>641</b>	38606-87A	70-6146	Motion Pro	06-0146	<b>641</b>
BODY	36755-87A	70-660156	Motion Pro	66-0156	<b>648</b>	38606-87A	70-660159	Motion Pro	66-0159	<b>648</b>
BODY	36801-79	68-9526F	Cometic Gaskets	C9526F	<b>460</b>	38606-87A +6	70-6165	Motion Pro	06-0165	<b>641</b>
WHEELS	36801-79	681-4661	James Gaskets	JGI-36801-79	<b>481</b>	38606-87A +6	70-660171	Motion Pro	66-0171	<b>648</b>
WHEELS	36801-79	681-4660	James Gaskets	JGI-36801-79-X	<b>481</b>	38607-87A	70-6145	Motion Pro	06-0145	<b>640</b>
TIRES / TIRE ACC.	36801-87	681-4659	James Gaskets	JGI-36801-87-A	<b>481</b>	38607-87A	70-660158	Motion Pro	66-0158	<b>647</b>
TIRES / TIRE ACC.	36801-87	681-4658	James Gaskets	JGI-36801-87-X	<b>481</b>	38607-87A +12	70-6251	Motion Pro	06-0251	<b>640</b>
BIKE ACC.	36801-87A	68-9483	Cometic Gaskets	C9483F	<b>457</b>	38607-87A +12	70-660262	Motion Pro	66-0262	<b>647</b>
BIKE ACC.	36805-06	68-9188	Cometic Gaskets	C9188	<b>457</b>	38607-87A +16	70-6293	Motion Pro	06-0293	<b>640</b>
BIKE ACC.	36805-06	681-4296	James Gaskets	JGI-36805-06-F	<b>476</b>	38607-87A +6	70-6164	Motion Pro	06-0164	<b>640</b>
VICTORY / INDIAN	36805-06	681-4297	James Gaskets	JGI-36805-06-X	<b>476</b>	38607-87A +6	70-660170	Motion Pro	66-0170	<b>647</b>
VICTORY / INDIAN	36821-68	681-4986	James Gaskets	JGI-36821-68	<b>486</b>	38618-52	70-6000	Motion Pro	06-0000	<b>640</b>
COVERS / LOCKS / TIEDOWNS	369-36	830-1170	Colony	2901-4	<b>385</b>	38618-52 +6	70-6064	Motion Pro	06-0064	<b>640</b>
COVERS / LOCKS / TIEDOWNS	37091-80	68-9496	Cometic Gaskets	C9496	<b>461</b>	38618-68A/B	70-6001	Motion Pro	06-0001	<b>640</b>
COVERS / LOCKS / TIEDOWNS	37091-80	681-4524	James Gaskets	JGI-37091-80	<b>478</b>	38618-68A/B	70-6120	Motion Pro	06-0120	<b>640</b>
CHEMICALS	37101-84	68-9354	Cometic Gaskets	C9354	<b>461</b>	38618-68A/B	70-660025	Motion Pro	66-0025	<b>647</b>
CHEMICALS	37101-84	681-4682	James Gaskets	JGI-37101-84	<b>481</b>	38618-68A/B +4	70-6044	Motion Pro	06-0044	<b>640</b>
CHEMICALS	37101-84	681-4312	James Gaskets	JGI-37101-84-B	<b>476</b>	38618-68A/B +4	70-6125	Motion Pro	06-0125	<b>640</b>
TOOLS	37107-06	681-5455	James Gaskets	JGI-37107-06	<b>492</b>	38618-68A/B+6	70-6063	Motion Pro	06-0063	<b>640</b>
TOOLS	37116-06	820-50800	HardDrive	820-50800	<b>424</b>	38618-68A/B+6	70-6127	Motion Pro	06-0127	<b>640</b>
TOOLS	37116-06	820-50801	HardDrive	820-50801	<b>424</b>	38618-68A/B+6	70-660026	Motion Pro	66-0026	<b>647</b>
HELMETS	37337-36	681-5191	James Gaskets	JGI-37337-36	<b>489</b>	38619-57A	70-6002	Motion Pro	06-0002	<b>642</b>
HELMETS	37339-53	68-9364	Cometic Gaskets	C9364	<b>469</b>	38619-57A +6	70-6067	Motion Pro	06-0067	<b>642</b>
HELMETS	37339-53	681-5651	James Gaskets	JGI-37339-53	<b>495</b>	38619-71B	70-6088	Motion Pro	06-0088	<b>642</b>
HELMET ACC.	37496-90	820-54717	HardDrive	820-54717	<b>410</b>	38619-71B	70-6107	Motion Pro	06-0107	<b>642</b>
HELMET ACC.	37503-41	681-4951	James Gaskets	JGI-37503-41	<b>485</b>	38619-71B	70-660029	Motion Pro	66-0029	<b>649</b>
EYEWEAR	37531-56	681-5652	James Gaskets	JGI-37531-56-B	<b>495</b>	38619-71B +6	70-6126	Motion Pro	06-0126	<b>642</b>
EYEWEAR	37531-56B	68-9368	Cometic Gaskets	C9368	<b>469</b>	38619-71B +6	70-6236	Motion Pro	06-0236	<b>642</b>
EYEWEAR	37549-41	810-4001	Alto Clutches	095762KT	<b>405</b>	38619-84	70-6088	Motion Pro	06-0088	<b>642</b>
APPAREL / RIDER ACC.	3762M	830-1105	Colony	2341-5	<b>669</b>	38619-84	70-6107	Motion Pro	06-0107	<b>642</b>
APPAREL / RIDER ACC.	37740-57	68-9371	Cometic Gaskets	C9371	<b>469</b>	38619-84 +6	70-6236	Motion Pro	06-0236	<b>642</b>
PROMOTIONAL	37740-57	681-5656	James Gaskets	JGI-37740-57	<b>495</b>	38619-86A	70-6137	Motion Pro	06-0137	<b>642</b>
PROMOTIONAL	37741-67	681-5657	James Gaskets	JGI-37741-67	<b>495</b>	38619-86A	70-660155	Motion Pro	66-0155	<b>649</b>
PROMOTIONAL	37741-67	681-5658	James Gaskets	JGI-37741-67-A	<b>495</b>	38619-86A +6	70-6161	Motion Pro	06-0161	<b>642</b>
REFERENCE	37741-67A	68-9513	Cometic Gaskets	C9513	<b>463</b>	38619-86A +6	70-660167	Motion Pro	66-0167	<b>649</b>
REFERENCE	37741-82	681-4675	James Gaskets	JGI-37741-82-A	<b>481</b>	38620-96	70-6286	Motion Pro	06-0286	<b>642</b>
REFERENCE	37741-82	681-4676	James Gaskets	JGI-37741-82-DL	<b>481</b>	38620-96	70-660287	Motion Pro	66-0287	<b>649</b>
INDEX	37741-82DL	68-9514	Cometic Gaskets	C9514	<b>461</b>	38621-86A	70-6147	Motion Pro	06-0147	<b>642</b>
INDEX						38621-86A	70-6203	Motion Pro	06-0203	<b>642</b>



# HARDDRIVE TO OEM CROSS REFERENCE

OEM#	WPS#	Vendor	Vend#	Page#	OEM#	WPS#	Vendor	Vend#	Page#
38621-86A	70-660160	Motion Pro	66-0160	649	44017-00	820-32008	HardDrive	820-32008	670
38626-77B	70-6106	Motion Pro	06-0106	642	44017-06	820-32003	HardDrive	820-32003	670
38626-84	70-6106	Motion Pro	06-0106	642	44023-00	820-32005	HardDrive	820-32005	670
38661-00	70-6164	Motion Pro	06-0164	640	44045-87	865-01205	Cycle Pro	19136M	687
38662-00	70-6286	Motion Pro	06-0286	642	44046-00	820-32004	HardDrive	820-32004	670
38663-00	70-6137	Motion Pro	06-0137	642	44046-08	820-32000	HardDrive	820-32000	670
38665-00	70-6327	Motion Pro	06-0327	640	44047-83	865-01202	Cycle Pro	19133M	687
38666-00	70-6329	Motion Pro	06-0329	640	44080-02	820-32009	HardDrive	820-32009	670
38699-04	70-6369	Motion Pro	06-0369	642	44082-00/00C	15-400H	EBC Brakes	FA400HH	673
38699-04	70-660369	Motion Pro	66-0369	650	44082-08	15-457H	EBC Brakes	FA457HH	673
40015-00	811-11011	Carlisle	62-1959	439	44127-72A	865-01207	Cycle Pro	19138M	687
40024-04	811-11013	Carlisle	62-1961	439	44136-84A	820-51836	HardDrive	820-51836	661
40036-06	820-51204	HardDrive	820-51204	416	44151-77	865-01201	Cycle Pro	19132M	687
40037-07	820-51203	HardDrive	820-51203	416	44152-77	865-01203	Cycle Pro	19134M	687
40147-04	820-51212	HardDrive	820-51212	416	44208-82	865-01204	Cycle Pro	19135M	687
40250-94	820-51194	HardDrive	820-51194	443	44209-82/A	15-78V	EBC Brakes	FA78V	674
40266-85	820-52635	HardDrive	820-52635	414	44209-87B/C,	15-200H	EBC Brakes	FA200HH	674
40267-85	820-52612	HardDrive	820-52612	414	44213-87				
40269-85A	820-52629	HardDrive	820-52629	414	44277-74	865-01200	Cycle Pro	19131M	687
40275-70	820-52628	HardDrive	820-52628	414	44296-04	820-55206	HardDrive	820-55206	391
40280-70	820-52626	HardDrive	820-52626	414	44296-04	820-55207	HardDrive	820-55207	391
40282-70	820-52627	HardDrive	820-52627	414	44314-00	820-51290	HardDrive	820-51290	676
40299-70	820-52615	HardDrive	820-52615	414	44315-00	865-01210	Cycle Pro	19143M	687
40299-83A	820-52616	HardDrive	820-52616	414	44328-00	865-01209	Cycle Pro	19140M	687
40308-94	820-52630	HardDrive	820-52630	414	44337-00	820-51280	HardDrive	820-51280	676
40375-70	820-52632	HardDrive	820-52632	414	44337-08	820-51286	HardDrive	820-51286	676
40384-83A	820-52613	HardDrive	820-52613	414	44351-00	820-51291	HardDrive	820-51291	676
40384-91	820-52614	HardDrive	820-52614	414	44432-04	820-55201	HardDrive	820-55201	391
4074 and 6724	830-1162	Colony	2573-4	706	44553-06A	820-51262	HardDrive	820-51262	662
40908-06	820-32002	HardDrive	820-32002	670	45006-96	820-50601	HardDrive	820-50601	687
40908-08	820-32001	HardDrive	820-32001	670	45072-87	865-01250	Cycle Pro	18372	687
40925-00	820-32007	HardDrive	820-32007	670	45072-96	865-01252	Cycle Pro	19255M	687
41210-55	681-5026	James Gaskets	JGI-41210-55	486	45072-96	820-50603	HardDrive	820-50603	687
41731-82	820-0552	HardDrive	820-0552	685	45125-52	681-5677	James Gaskets	JGI-46125-52	495
41791-79A	820-51838	HardDrive	820-51838	661	45359-00	681-4182	James Gaskets	JGI-45359-00	474
41854-08/42897-08	15-409H	EBC Brakes	FA409HH	673	45378-87	681-4720	James Gaskets	JGI-45378-87	481
42028-07	820-32012	HardDrive	820-32012	670	45387-83	681-5008	James Gaskets	JGI-45387-83	486
42040-06	820-51263	HardDrive	820-51263	662	45400-75	681-5010	James Gaskets	JGI-45400-75	486
42298-08	15-458H	EBC Brakes	FA458HH	674	45401-87	681-4727	James Gaskets	JGI-45401-87	481
42301-87	830-1106	Colony	2638-8	686	45403-75	681-5019	James Gaskets	JGI-45403-75	486
42345-08	820-51282	HardDrive	820-51282	676	45404-75	820-50307	HardDrive	820-50307	716
42382-87A	865-01251	Cycle Pro	18389	687	45406-75	681-5020	James Gaskets	JGI-45406-75	486
42712-04	820-2628	HardDrive	820-2628	239	45443-86	681-4726	James Gaskets	JGI-45443-86	481
42803-07	820-32010	HardDrive	820-32010	687	45451-07	820-50303	HardDrive	820-50303	716
42809-07	820-32011	HardDrive	820-32011	687	45465-99	681-4221	James Gaskets	JGI-45465-99	475
42823-04	820-51287	HardDrive	820-51287	676	45583-83	681-4730	James Gaskets	JGI-45583-83	481
42824-04	820-51288	HardDrive	820-51288	676	45670-80	830-1129	Colony	2058-1	719
42831-04/A	15-381H	EBC Brakes	FA381HH	673	45733-48	681-4723	James Gaskets	JGI-45733-48	481
42832-04	820-51283	HardDrive	820-51283	676	45780-52	681-5683	James Gaskets	JGI-45780-52	495
42836-04	15-387H	EBC Brakes	FA387HH	674	45839-84	830-1164	Colony	2736-1	719
42837-04	820-51284	HardDrive	820-51284	676	45841-84	830-1165	Colony	2737-1	719
42863-06	820-51289	HardDrive	820-51289	676	45842-77A	681-4722	James Gaskets	JGI-45842-77-A	481
42932-08	820-52942	HardDrive	820-52942	687	45843-77	681-5009	James Gaskets	JGI-45843-77	486
43063-83/A/C	15-94H	EBC Brakes	FA94HH	673	45844-77	681-5021	James Gaskets	JGI-45844-77	486
43567-92	830-1116	Colony	9807-10	669	45845-77	681-4724	James Gaskets	JGI-45845-77	481
43567-92	830-1117	Colony	9818-5	669	45846-84	681-4718	James Gaskets	JGI-45846-84	481
43570-35	681-5200	James Gaskets	JGI-43570-35	489	45850-48	681-5017	James Gaskets	JGI-45850-48	486
43571-35	681-5201	James Gaskets	JGI-43571-35	489	45852-48	681-5012	James Gaskets	JGI-45852-48	486
43576-35	681-5202	James Gaskets	JGI-43576-35	489	45865-84	681-4729	James Gaskets	JGI-45865-84	481
43577-67	22-51366	All Balls Racing	25-1366	795	45875-84	681-4719	James Gaskets	JGI-45875-84	481
43840-01	820-55203	HardDrive	820-55203	391	45905-87	681-4721	James Gaskets	JGI-45905-87	481
43841-01	820-55205	HardDrive	820-55205	391	45908-80	681-5013	James Gaskets	JGI-45908-80	486
43857-00	820-55202	HardDrive	820-55202	391	45927-73	681-5011	James Gaskets	JGI-45927-73	486
43858-00	820-55200	HardDrive	820-55200	391	45964-86	820-52372	HardDrive	820-52372	714
43859-00	820-55204	HardDrive	820-55204	391	45964-89	820-52373	HardDrive	820-52373	714
43895-87	820-51354	HardDrive	820-51354	790	45968-59	681-5682	James Gaskets	JGI-45968-59	495
43895-87	820-51355	HardDrive	820-51355	790	45975-71	681-5681	James Gaskets	JGI-45975-71	495
43945-79	865-01208	Cycle Pro	19139M	687	45982-73	681-5015	James Gaskets	JGI-45982-73	486
43957-86/A/B/D	15-201H	EBC Brakes	FA201HH	674	45983-73	820-50308	HardDrive	820-50308	716
43959-86	820-51281	HardDrive	820-51281	676	45984-87	681-4725	James Gaskets	JGI-45984-87	481
44007-80	865-01206	Cycle Pro	19137M	687	45986-73	681-5018	James Gaskets	JGI-45986-73	486
44016-00D/44441-00D	820-32006	HardDrive	820-32006	670	45992-73	681-5016	James Gaskets	JGI-45992-73	486
					45996-87	830-1199	Colony	9913-2	719

WINDSHIELDS / FAIRINGS  
 AUDIO / COMMUNICATION  
 SEATS / LUGGAGE  
 BARS / MIRRORS / CONTROLS  
 EXHAUST  
 AIR / FUEL SYSTEMS  
 ENGINE  
 TRANSMISSION / DRIVELINE  
 GASKETS / SEALS  
 ELECTRICAL  
 LIGHTING  
 CABLES  
 BRAKES  
 OIL FILTERS  
 SUSPENSION  
 BODY  
 WHEELS  
 TIRES / TIRE ACC.  
 BIKE ACC.  
 VICTORY / INDIAN  
 COVERS / LOCKS / TIEDOWNS  
 CHEMICALS  
 TOOLS  
 HELMETS  
 HELMET ACC.  
 EYEWEAR  
 APPAREL / RIDER ACC.  
 PROMOTIONAL  
 REFERENCE  
 INDEX

**HARDDRIVE TO OEM CROSS REFERENCE**

	OEM#	WPS#	Vendor	Vend#	Page#	OEM#	WPS#	Vendor	Vend#	Page#
WINDSHIELDS / FAIRINGS	46001-54	820-50304	HardDrive	820-50304	<b>716</b>	56324-81A	70-660070	Motion Pro	66-0070	<b>644</b>
AUDIO / COMMUNICATION	46111-48	681-5022	James Gaskets	JGI-46111-48	<b>486</b>	56324-81A +6	70-6058	Motion Pro	06-0058	<b>637</b>
SEATS / LUGGAGE	46125-48	681-5023	James Gaskets	JGI-46125-48	<b>486</b>	56324-81A +6	70-660071	Motion Pro	66-0071	<b>644</b>
BARS / MIRRORS / CONTROLS	46175-00	681-4339	James Gaskets	JGI-46175-00	<b>476</b>	56324-81A +8	70-6175	Motion Pro	06-0175	<b>637</b>
EXHAUST	46508-01	681-4334	James Gaskets	JGI-46508-01	<b>476</b>	56327-81B	70-6060	Motion Pro	06-0060	<b>637</b>
AIR / FUEL SYSTEMS	46512-01	681-4337	James Gaskets	JGI-46512-01	<b>476</b>	56327-81B	70-660179	Motion Pro	66-0179	<b>644</b>
ENGINE	46513-01	681-4340	James Gaskets	JGI-46513-01	<b>476</b>	56327-81B +6	70-6173	Motion Pro	06-0173	<b>637</b>
TRANSMISSION / DRIVELINE	46514-01	681-4338	James Gaskets	JGI-46514-01	<b>476</b>	56327-81B +6	70-660187	Motion Pro	66-0187	<b>644</b>
GASKETS / SEALS	46515-01	681-4335	James Gaskets	JGI-46515-01	<b>476</b>	56327-90	70-6195	Motion Pro	06-0195	<b>637</b>
ELECTRICAL	46605-06	820-52309	HardDrive	820-52309	<b>714</b>	56327-90	70-660212	Motion Pro	66-0212	<b>644</b>
LIGHTING	46615-06	681-4336	James Gaskets	JGI-46615-06	<b>476</b>	56327-90 +6	70-6211	Motion Pro	06-0211	<b>637</b>
CABLES	46617-06	820-52310	HardDrive	820-52310	<b>714</b>	56327-90 +6	70-660213	Motion Pro	66-0213	<b>644</b>
BRAKES	46721-06	15-434H	EBC Brakes	FA434HH	<b>674</b>	56327-96	70-6278	Motion Pro	06-0278	<b>637</b>
OIL FILTERS	47519-58	681-5025	James Gaskets	JGI-47519-58	<b>486</b>	56327-96	70-660280	Motion Pro	66-0280	<b>644</b>
SUSPENSION	47519-72	681-5680	James Gaskets	JGI-47519-72	<b>495</b>	56328-81A	70-6061	Motion Pro	06-0061	<b>637</b>
BODY	47519-72	681-5679	James Gaskets	JGI-47519-72-2	<b>495</b>	56328-81A	70-660183	Motion Pro	66-0183	<b>644</b>
WHEELS	47519-83A	681-4712	James Gaskets	JGI-47519-83-A	<b>481</b>	56328-81A +6	70-6176	Motion Pro	06-0176	<b>637</b>
TIRES / TIRE ACC.	47519-83A	681-4713	James Gaskets	JGI-47519-83-A2	<b>481</b>	56328-81A +6	70-660190	Motion Pro	66-0190	<b>644</b>
BIKE ACC.	47519-83A	681-5685	James Gaskets	JGI-47519-83-DL	<b>495</b>	56328-90	70-6197	Motion Pro	06-0197	<b>637</b>
VICTORY / INDIAN	47577-00	820-52351	HardDrive	820-52351	<b>790</b>	56328-90	70-660218	Motion Pro	66-0218	<b>644</b>
COVERS / LOCKS / TIEDOWNS	48332-48B	830-1168	Colony	2799-1	<b>718</b>	56328-90 +6	70-6217	Motion Pro	06-0217	<b>637</b>
CHEMICALS	48745-08	820-52313	HardDrive	820-52313	<b>714</b>	56328-90 +6	70-660219	Motion Pro	66-0219	<b>644</b>
TOOLS	50100-70	681-4639	James Gaskets	JGI-50100-70	<b>480</b>	56328-96	70-6279	Motion Pro	06-0279	<b>637</b>
HELMETS	50599-89T	820-51101	HardDrive	820-51101	<b>251</b>	56328-96	70-660281	Motion Pro	66-0281	<b>644</b>
HELMET ACC.	50621-79A	820-51100	HardDrive	820-51100	<b>251</b>	56331-81	70-6096	Motion Pro	06-0096	<b>638</b>
EYEWEAR	50631-04	820-51102	HardDrive	820-51102	<b>251</b>	56332-81	70-6095	Motion Pro	06-0095	<b>638</b>
APPAREL / RIDER ACC.	50829-07A	820-55260	HardDrive	820-55260	<b>238</b>	56333-83	70-6098	Motion Pro	06-0098	<b>638</b>
PROMOTIONAL	50830-07A	820-55262	HardDrive	820-55262	<b>238</b>	56336-83	70-6074	Motion Pro	06-0074	<b>638</b>
REFERENCE	53437-79A	820-0389	HardDrive	820-0389	<b>600</b>	56336-83	70-660180	Motion Pro	66-0180	<b>645</b>
INDEX	53437-79A	820-0390	HardDrive	820-0390	<b>600</b>	56336-83 +6	70-6174	Motion Pro	06-0174	<b>638</b>
	54648-00	820-52708	HardDrive	820-52708	<b>706</b>	56336-83 +6	70-660188	Motion Pro	66-0188	<b>644</b>
	56237-99	70-6362	Motion Pro	06-0362	<b>637</b>	56337-83	70-6075	Motion Pro	06-0075	<b>638</b>
	56237-99	70-660362	Motion Pro	66-0362	<b>644</b>	56337-83	70-660184	Motion Pro	66-0184	<b>645</b>
	56237-99 +6	70-660371	Motion Pro	66-0371	<b>644</b>	56337-83 +6	70-6177	Motion Pro	06-0177	<b>638</b>
	56302-74	70-6055	Motion Pro	06-0055	<b>637</b>	56337-83 +6	70-660191	Motion Pro	66-0191	<b>644</b>
	56302-74 +4	70-6056	Motion Pro	06-0056	<b>637</b>	56342-88	70-6075	Motion Pro	06-0075	<b>638</b>
	56305-88	70-6151	Motion Pro	06-0151	<b>637</b>	56342-88	70-660184	Motion Pro	66-0184	<b>645</b>
	56305-88	70-660186	Motion Pro	66-0186	<b>644</b>	56342-88 +6	70-6177	Motion Pro	06-0177	<b>638</b>
	56305-88 +6	70-6178	Motion Pro	06-0178	<b>637</b>	56342-88 +6	70-660191	Motion Pro	66-0191	<b>644</b>
	56305-88 +6	70-660192	Motion Pro	66-0192	<b>644</b>	56342-90	70-6196	Motion Pro	06-0196	<b>637</b>
	56305-90	70-6246	Motion Pro	06-0246	<b>637</b>	56342-90	70-660215	Motion Pro	66-0215	<b>644</b>
	56305-90	70-660265	Motion Pro	66-0265	<b>644</b>	56342-90 +6	70-6214	Motion Pro	06-0214	<b>637</b>
	56305-96	70-62971	Motion Pro	06-0297	<b>638</b>	56342-90 +6	70-660216	Motion Pro	66-0216	<b>644</b>
	56305-96	70-660299	Motion Pro	66-0299	<b>644</b>	56342-96	70-6267	Motion Pro	06-0267	<b>637</b>
	56306-88	70-6150	Motion Pro	06-0150	<b>637</b>	56342-96	70-660271	Motion Pro	66-0271	<b>644</b>
	56306-88	70-660182	Motion Pro	66-0182	<b>644</b>	56342-96 +6	70-6269	Motion Pro	06-0269	<b>637</b>
	56306-88 +6	70-6175	Motion Pro	06-0175	<b>637</b>	56342-96 +6	70-660273	Motion Pro	66-0273	<b>644</b>
	56306-88 +6	70-660189	Motion Pro	66-0189	<b>644</b>	56343-88	70-6074	Motion Pro	06-0074	<b>638</b>
	56306-90	70-6245	Motion Pro	06-0245	<b>637</b>	56343-88	70-660180	Motion Pro	66-0180	<b>645</b>
	56306-90	70-660264	Motion Pro	66-0264	<b>644</b>	56343-88 +6	70-6174	Motion Pro	06-0174	<b>638</b>
	56306-96	70-62961	Motion Pro	06-0296	<b>638</b>	56343-88 +6	70-660188	Motion Pro	66-0188	<b>644</b>
	56306-96	70-660298	Motion Pro	66-0298	<b>644</b>	56343-90	70-6194	Motion Pro	06-0194	<b>637</b>
	56308-86	70-6092	Motion Pro	06-0092	<b>639</b>	56343-90	70-660209	Motion Pro	66-0209	<b>644</b>
	56308-88	70-6138	Motion Pro	06-0138	<b>639</b>	56343-90 +6	70-6208	Motion Pro	06-0208	<b>637</b>
	56308-88	70-660181	Motion Pro	66-0181	<b>646</b>	56343-90 +6	70-660210	Motion Pro	66-0210	<b>644</b>
	56308-96	70-6282	Motion Pro	06-0282	<b>639</b>	56343-96	70-6266	Motion Pro	06-0266	<b>637</b>
	56308-96	70-660283	Motion Pro	66-0283	<b>646</b>	56343-96	70-660270	Motion Pro	66-0270	<b>644</b>
	56309-86	70-6090	Motion Pro	06-0090	<b>639</b>	56343-96 +6	70-6268	Motion Pro	06-0268	<b>637</b>
	56309-88	70-6139	Motion Pro	06-0139	<b>639</b>	56343-96 +6	70-660272	Motion Pro	66-0272	<b>644</b>
	56309-88	70-660185	Motion Pro	66-0185	<b>646</b>	56355-92	70-6258	Motion Pro	06-0258	<b>637</b>
	56309-96	70-6284	Motion Pro	06-0284	<b>639</b>	56355-92	70-660260	Motion Pro	66-0260	<b>644</b>
	56313-76	70-6031	Motion Pro	06-0031	<b>637</b>	56355-96	70-6275	Motion Pro	06-0275	<b>637</b>
	56313-76 +4	70-6033	Motion Pro	06-0033	<b>637</b>	56355-96	70-660277	Motion Pro	66-0277	<b>644</b>
	56313-76 +6	70-6057	Motion Pro	06-0057	<b>637</b>	56356-92	70-6257	Motion Pro	06-0257	<b>637</b>
	56314-78	70-6055	Motion Pro	06-0055	<b>637</b>	56356-92	70-660259	Motion Pro	66-0259	<b>644</b>
	56314-78 +6	70-6056	Motion Pro	06-0056	<b>637</b>	56356-96	70-62741	Motion Pro	06-0274	<b>637</b>
	56316-80	70-6097	Motion Pro	06-0097	<b>637</b>	56356-96	70-660276	Motion Pro	66-0276	<b>644</b>
	56323-81C	70-6007	Motion Pro	06-0007	<b>637</b>	56357-02	70-660350	Motion Pro	66-0350	<b>644</b>
	56323-81C	70-660068	Motion Pro	66-0068	<b>644</b>	56357-02 +6	70-660370	Motion Pro	66-0370	<b>644</b>
	56323-81C +6	70-6059	Motion Pro	06-0059	<b>637</b>	56358-02	70-6364	Motion Pro	06-0364	<b>637</b>
	56323-81C +6	70-660069	Motion Pro	66-0069	<b>644</b>	56358-02	70-660364	Motion Pro	66-0364	<b>644</b>
	56323-81C +8	70-6178	Motion Pro	06-0178	<b>637</b>	56358-02 +6	70-660372	Motion Pro	66-0372	<b>644</b>
	56324-81A	70-6008	Motion Pro	06-0008	<b>637</b>	56358-96	70-6363	Motion Pro	06-0363	<b>637</b>

**HARDDRIVE TO OEM CROSS REFERENCE**

OEM#	WPS#	Vendor	Vend#	Page#	OEM#	WPS#	Vendor	Vend#	Page#
56368-96	70-660301	Motion Pro	66-0301	<b>644</b>	60567-65	681-4614	James Gaskets	JGI-60567-65-B	<b>480</b>
56375-94	70-6254	Motion Pro	06-0254	<b>637</b>	60567-65	681-4936	James Gaskets	JGI-60567-65-C	<b>485</b>
56375-94	70-660256	Motion Pro	66-0256	<b>644</b>	60567-65C	68-9331F5	Cosmetic Gaskets	C9331F5	<b>456</b>
56376-02	70-6302	Motion Pro	06-0302	<b>637</b>	60567-90	681-4615	James Gaskets	JGI-60567-90	<b>480</b>
56376-02	70-660304	Motion Pro	66-0304	<b>644</b>	60567-90	681-4939	James Gaskets	JGI-60567-90-DL	<b>485</b>
56376-94	70-6253	Motion Pro	06-0253	<b>637</b>	60567-90	681-4613	James Gaskets	JGI-60567-90-F	<b>480</b>
56376-94	70-660255	Motion Pro	66-0255	<b>644</b>	60629-55	681-5179	James Gaskets	JGI-60629-55	<b>488</b>
56379-96	70-660300	Motion Pro	66-0300	<b>644</b>	60629-65	681-4943	James Gaskets	JGI-60629-65	<b>485</b>
56381-96	70-6288	Motion Pro	06-0288	<b>639</b>	60641-74	68-9525	Cosmetic Gaskets	C9525	<b>461</b>
56381-96	70-660289	Motion Pro	66-0289	<b>646</b>	60641-74	681-4946	James Gaskets	JGI-60641-74	<b>485</b>
56382-96	70-6290	Motion Pro	06-0290	<b>639</b>	60645-65	68-9702	Cosmetic Gaskets	C9702	<b>463</b>
56382-96	70-660291	Motion Pro	66-0291	<b>646</b>	60645-65	681-5032	James Gaskets	JGI-60645-65	<b>486</b>
56389-74	70-6055	Motion Pro	06-0055	<b>637</b>	60645-65	681-4955	James Gaskets	JGI-60645-65-X	<b>485</b>
56389-74 +6	70-6056	Motion Pro	06-0056	<b>637</b>	60764-06	820-2631	HardDrive	820-2631	<b>419</b>
56454-00	820-2608	HardDrive	820-2608	<b>146</b>	60782-06	820-2629	HardDrive	820-2629	<b>419</b>
56466-86A	820-2603	HardDrive	820-2603	<b>146</b>	61023-93	820-52213	HardDrive	820-52213	<b>736</b>
56481-03	820-2610	HardDrive	820-2610	<b>146</b>	61109-85C	681-4595	James Gaskets	JGI-61109-85-C	<b>479</b>
56495-02	820-2609	HardDrive	820-2609	<b>146</b>	61111-77	681-5004	James Gaskets	JGI-61111-77	<b>486</b>
56502-74	70-6055	Motion Pro	06-0055	<b>637</b>	61114-48	681-5005	James Gaskets	JGI-61114-48	<b>486</b>
56502-74 +6	70-6056	Motion Pro	06-0056	<b>637</b>	61116-65	681-5003	James Gaskets	JGI-61116-65	<b>486</b>
56522-02 +6	70-660379	Motion Pro	66-0379	<b>644</b>	61192-88	681-4596	James Gaskets	JGI-61192-88	<b>479</b>
56523-02	70-6302	Motion Pro	06-0302	<b>637</b>	61211-67	820-52206	HardDrive	820-52206	<b>735</b>
56523-02	70-660304	Motion Pro	66-0304	<b>644</b>	61213-83	820-52208	HardDrive	820-52208	<b>735</b>
56525-02 +6	70-660376	Motion Pro	66-0376	<b>644</b>	61218-67A	820-52205	HardDrive	820-52205	<b>735</b>
56526-02 +6	70-660378	Motion Pro	66-0378	<b>644</b>	61219-83	820-52207	HardDrive	820-52207	<b>735</b>
56802-06	820-2619	HardDrive	820-2619	<b>146</b>	61326-95	681-4601	James Gaskets	JGI-61326-95	<b>479</b>
57852-02A	820-55282	HardDrive	820-55282	<b>614</b>	61348-96A	820-52214	HardDrive	820-52214	<b>736</b>
58082-02A	820-55281	HardDrive	820-55281	<b>614</b>	62085-40	681-5165	James Gaskets	JGI-62085-40	<b>488</b>
58383-89	820-0388	HardDrive	820-0388	<b>600</b>	62-0938	811-11005	Carlisle	40023-86	<b>439</b>
58384-89	820-0387	HardDrive	820-0387	<b>600</b>	62-0941	811-11004	Carlisle	40017-94	<b>439</b>
58478-96B	820-52354	HardDrive	820-52354	<b>48</b>	62-0941	811-11004	Carlisle	4WM-46241-00-00	<b>439</b>
58938-96C	820-52353	HardDrive	820-52353	<b>48</b>	62-0942	811-11006	Carlisle	40015-90	<b>439</b>
59181-80	681-4706	James Gaskets	JGI-59181-80	<b>481</b>	62-0943	811-11003	Carlisle	40012-90	<b>439</b>
59626-84	820-2675	HardDrive	820-2675	<b>852</b>	62-0944	811-11009	Carlisle	40038-91	<b>439</b>
59672-09	820-0401	HardDrive	820-0401	<b>600</b>	62-0945	811-11010	Carlisle	40022-91	<b>439</b>
59672-09	820-0402	HardDrive	820-0402	<b>600</b>	62-0964	811-11007	Carlisle	40001-85	<b>439</b>
59672-99	820-0393	HardDrive	820-0393	<b>600</b>	62-0998	811-11030	Carlisle	5PX-46241-00-00	<b>439</b>
59672-99	820-0394	HardDrive	820-0394	<b>600</b>	62-1172	811-11012	Carlisle	40307-00	<b>439</b>
59683-03	820-0399	HardDrive	820-0399	<b>600</b>	62-1178	811-11008	Carlisle	40024-97	<b>439</b>
59683-03	820-0400	HardDrive	820-0400	<b>600</b>	62125-55B	820-52253	HardDrive	820-52253	<b>349</b>
59995-55A	820-2676	HardDrive	820-2676	<b>852</b>	62172-02	681-4245	James Gaskets	JGI-62172-02	<b>475</b>
5R6A	274-0162	Accel	2410A	<b>558</b>	62172-75	681-4593	James Gaskets	JGI-62172-75	<b>479</b>
5R6A	274-0164	Accel	Y2410P	<b>558</b>	62270-32	681-5161	James Gaskets	JGI-62270-32	<b>488</b>
5R6A	4-4265	Autolite Sparkplugs	4265	<b>559</b>	62360-50	681-5162	James Gaskets	JGI-62360-50	<b>488</b>
5R6A	4-XS65	Autolite Sparkplugs	XS65	<b>559</b>	62423-90	68-9489	Cosmetic Gaskets	C9489F	<b>461</b>
5R6A	2-BPR5ES-11	NGK Sparkplugs	7634	<b>558</b>	62423-90A	681-4667	James Gaskets	JGI-62423-90	<b>481</b>
60161-06	820-2618	HardDrive	820-2618	<b>146</b>	62432-93	68-9266F	Cosmetic Gaskets	C9266F	<b>457</b>
60518-65	68-9717F	Cosmetic Gaskets	C9717F	<b>461</b>	62432-93	681-4666	James Gaskets	JGI-62432-93	<b>481</b>
60518-65	681-5031	James Gaskets	JGI-60518-65	<b>486</b>	62563-65	820-2690	HardDrive	820-2690	<b>768</b>
60518-65	681-4954	James Gaskets	JGI-60518-65-DL	<b>485</b>	62563-65	820-2691	HardDrive	820-2691	<b>768</b>
60538-81	681-4931	James Gaskets	JGI-60538-81-A	<b>485</b>	62595-82A	820-2643	HardDrive	820-2643	<b>398</b>
60538-81	681-4930	James Gaskets	JGI-60538-81-C	<b>485</b>	62617-52	681-5583	James Gaskets	JGI-62617-52	<b>494</b>
60538-81D	68-9607F1	Cosmetic Gaskets	C9607F1	<b>460</b>	62628-36	681-5123	James Gaskets	JGI-62628-36	<b>488</b>
60538-81D	68-9607F5	Cosmetic Gaskets	C9607F5	<b>460</b>	62628-52	681-5676	James Gaskets	JGI-62628-52	<b>495</b>
60539-89	681-4610	James Gaskets	JGI-60539-89-X	<b>480</b>	62628-66	681-4874	James Gaskets	JGI-62628-66	<b>484</b>
60539-89/60539-94	68-9309F5	Cosmetic Gaskets	C9309F5	<b>457</b>	62636-96	820-2646	HardDrive	820-2646	<b>398</b>
60539-89/94	68-9309F1	Cosmetic Gaskets	C9309F1	<b>457</b>	62644-84T	820-2644	HardDrive	820-2644	<b>398</b>
60539-94	681-4265	James Gaskets	JGI-60539-94	<b>475</b>	62667-87T	820-2655	HardDrive	820-2655	<b>398</b>
60540-36	681-5175	James Gaskets	JGI-60540-36	<b>488</b>	62672-90	68-9485	Cosmetic Gaskets	C9485	<b>461</b>
60540-65	681-4934	James Gaskets	JGI-60540-65	<b>485</b>	62672-90	681-4518	James Gaskets	JGI-62672-90	<b>479</b>
60540-65	681-4933	James Gaskets	JGI-60540-65-A	<b>485</b>	62673-90	681-4519	James Gaskets	JGI-62673-90	<b>479</b>
60547-06	68-9145F1	Cosmetic Gaskets	C9145F1	<b>457</b>	62702-52	68-9403	Cosmetic Gaskets	C9403	<b>461</b>
60547-06	68-9145F5	Cosmetic Gaskets	C9145F5	<b>457</b>	62809-06	820-2636	HardDrive	820-2636	<b>345</b>
60547-06	681-4263	James Gaskets	JGI-60547-06	<b>475</b>	62845-00A	820-2635	HardDrive	820-2635	<b>398</b>
60547-06	681-4262	James Gaskets	JGI-60547-06-F	<b>475</b>	63525-92	681-4525	James Gaskets	JGI-63525-92	<b>479</b>
60559-80	68-9330F	Cosmetic Gaskets	C9330F	<b>461</b>	63528-92	68-10011	Cosmetic Gaskets	C10011	<b>460</b>
60559-80	681-4707	James Gaskets	JGI-60559-80	<b>481</b>	63528-92	681-4526	James Gaskets	JGI-63528-92	<b>479</b>
60565-36	681-5176	James Gaskets	JGI-60565-36	<b>488</b>	63529-50	681-5126	James Gaskets	JGI-63529-50	<b>488</b>
60567-36	68-9326F	Cosmetic Gaskets	C9326F	<b>469</b>	63529-57	68-9365	Cosmetic Gaskets	C9365	<b>462</b>
60567-36	68-9326F1	Cosmetic Gaskets	C9326F1	<b>463</b>	63529-57	681-4871	James Gaskets	JGI-63529-57	<b>484</b>
60567-36	68-9326F5	Cosmetic Gaskets	C9326F5	<b>463</b>	63731-99	820-0721	HardDrive	820-0721	<b>690</b>
60567-36	681-5177	James Gaskets	JGI-60567-36	<b>488</b>	63731-99	820-0723	HardDrive	820-0723	<b>690</b>
60567-65	681-4937	James Gaskets	JGI-60567-65	<b>485</b>	63731-99	550-0171	Hiflo Oil Filters	HF170B	<b>692</b>

WINDSHIELDS / FAIRINGS  
AUDIO / COMMUNICATION  
SEATS / LUGGAGE  
BARS / MIRRORS / CONTROLS  
EXHAUST  
AIR / FUEL SYSTEMS  
ENGINE  
TRANSMISSION / DRIVELINE  
GASKETS / SEALS  
ELECTRICAL  
LIGHTING  
CABLES  
BRAKES  
OIL FILTERS  
SUSPENSION  
BODY  
WHEELS  
TIRES / TIRE ACC.  
BIKE ACC.  
VICTORY / INDIAN  
COVERS / LOCKS / TIEDOWNS  
CHEMICALS  
TOOLS  
HELMETS  
HELMET ACC.  
EYEWEAR  
APPAREL / RIDER ACC.  
PROMOTIONAL  
REFERENCE  
INDEX

# HARDDRIVE TO OEM CROSS REFERENCE

	OEM#	WPS#	Vendor	Vend#	Page#	OEM#	WPS#	Vendor	Vend#	Page#
WINDSHIELDS / FAIRINGS	63731-99	56-0171	K&N	KN-171B	693	67060-87A	70-6011	Motion Pro	06-0011	643
AUDIO / COMMUNICATION	63782-80T	550-0172C	Hiflo Oil Filters	HF172C	692	67060-87A	70-660129	Motion Pro	66-0129	651
SEATS / LUGGAGE	63782-80T	56-0172C	K&N	KN-172C	693	67063-89	70-6250	Motion Pro	06-0250	643
BARS / MIRRORS / CONTROLS	63793-01K	550-0174C	Hiflo Oil Filters	HF174C	692	67063-89	70-660263	Motion Pro	66-0263	651
EXHAUST	63793-01K	56-0174C	K&N	KN-174C	693	67072-79	70-6011	Motion Pro	06-0011	643
AIR / FUEL SYSTEMS	63796-77	550-0170C	Hiflo Oil Filters	HF170C	692	67072-79	70-660129	Motion Pro	66-0129	651
ENGINE	63796-77	56-0170C	K&N	KN-170C	693	67072-87A	70-6013	Motion Pro	06-0013	643
TRANSMISSION / DRIVELINE	63798-99	820-0720	HardDrive	820-0720	690	67072-87A	70-6013	Motion Pro	06-0013	643
GASKETS / SEALS	63798-99	820-0722	HardDrive	820-0722	690	67096-87	681-4715	James Gaskets	JGI-67096-87	481
ELECTRICAL	63798-99	550-0171C	Hiflo Oil Filters	HF171C	692	67098-87	681-4716	James Gaskets	JGI-67098-87	481
LIGHTING	63798-99	56-0171C	K&N	KN-171C	693	67118-87	681-4717	James Gaskets	JGI-67118-87	481
CABLES	63805-80A	550-0170	Hiflo Oil Filters	HF170B	692	67141-36	68-9512F	Cometic Gaskets	C9512F	463
BRAKES	63805-80A	56-0170	K&N	KN-170	693	67141-36	681-4973	James Gaskets	JGI-67141-36	486
OIL FILTERS	63805-80T	820-0701	HardDrive	820-0701	690	6762B	681-4473	James Gaskets	JGI-6762-B	478
SUSPENSION	63805-80T	820-0703	HardDrive	820-0703	690	68020-92A	820-52854	HardDrive	820-52854	510
BODY	63806-83	820-0700	HardDrive	820-0700	690	68021-92A	820-52853	HardDrive	820-52853	510
WHEELS	63806-83	820-0702	HardDrive	820-0702	690	68022-92A	820-52851	HardDrive	820-52851	510
TIRES / TIRE ACC.	63809-48	681-5125	James Gaskets	JGI-63809-48-DL	488	68023-92A	820-52852	HardDrive	820-52852	510
BIKE ACC.	63813-90	550-0173C	Hiflo Oil Filters	HF173C	692	68024-92A	820-52850	HardDrive	820-52850	510
VICTORY / INDIAN	63813-90	56-0173C	K&N	KN-173C	693	68026-73	820-0382	HardDrive	820-0382	595
COVERS / LOCKS / TIEDOWNS	63815-99	68-9679	Cometic Gaskets	C9679	456	68027-90	820-0381	HardDrive	820-0381	595
CHEMICALS	63840-53	550-0178	Hiflo Oil Filters	HF178B	692	68027-90	681-4702	James Gaskets	JGI-68027-90	481
TOOLS	63848-48	681-5124	James Gaskets	JGI-63848-48	488	68033-90	820-0380	HardDrive	820-0380	595
HELMETS	63858-49	68-9286	Cometic Gaskets	C9286	459	68121-55	681-5027	James Gaskets	JGI-68121-55	486
HELMET ACC.	63858-49	681-4450	James Gaskets	JGI-63858-49	478	68122-55	681-5028	James Gaskets	JGI-68122-55	486
EYEWEAR	63859-95	681-4628	James Gaskets	JGI-63859-95	480	68123-55	681-5029	James Gaskets	JGI-68123-55	486
APPAREL / RIDER ACC.	63859-95A	68-9942F1	Cometic Gaskets	C9942F1	457	68123-73	820-0383	HardDrive	820-0383	595
PROMOTIONAL	63859-95A	68-9942F5	Cometic Gaskets	C9942F5	457	68123-73	681-4701	James Gaskets	JGI-68123-73	481
REFERENCE	63869-06	681-4272	James Gaskets	JGI-63869-06	475	68425-86	681-4703	James Gaskets	JGI-68425-86	481
INDEX	63879-53	681-4875	James Gaskets	JGI-63879-53	484	68451-86	681-4704	James Gaskets	JGI-68451-86	481
	65324-83	68-9719	Cometic Gaskets	C9719	456	68455-86	681-4705	James Gaskets	JGI-68455-86	481
	65324-83A	68-9288	Cometic Gaskets	C9288	456	68481-73	681-5678	James Gaskets	JGI-68481-73	495
	65324-83A	681-4227	James Gaskets	JGI-65324-83	475	68520-63	681-5030	James Gaskets	JGI-68520-63	486
	65324-83A	681-4226	James Gaskets	JGI-65324-83-A	475	68706-00	820-0395	HardDrive	820-0395	600
	65324-83A	681-4228	James Gaskets	JGI-65324-83-CG	475	68706-00	820-0398	HardDrive	820-0398	600
	65324-83X	68-9247	Cometic Gaskets	C9247	456	68712-94A	820-55280	HardDrive	820-55280	614
	65325-83A	681-4225	James Gaskets	JGI-65325-83-A	475	69012-93A	820-2683	HardDrive	820-2683	511
	65721-85	681-4575	James Gaskets	JGI-65721-85	479	69024-77	820-2678	HardDrive	820-2678	520
	65724-85	820-2641	HardDrive	820-2641	298	69120-91	820-2684	HardDrive	820-2684	511
	65781-82	681-4574	James Gaskets	JGI-65781-82	479	69123-92	820-52500	HardDrive	820-52500	768
	65826-90	681-4573	James Gaskets	JGI-65826-90	479	69278-06	820-52356	HardDrive	820-52356	604
	65834-68A	681-4900	James Gaskets	JGI-65834-68-SC	484	6R12	274-0163	Accel	2418	558
	65834-68X	68-9587	Cometic Gaskets	C9587	463	6R12	274-0165	Accel	Y2418P	558
	65948-00	YTX14	WPS Batteries		568	6R12	4-4164	Autolite Sparkplugs	4164	559
	65958-04	YTX14L-BS	WPS Batteries		568	6R12	4-XS4164	Autolite Sparkplugs	XS4164	559
	65989-97A	YTX20HL-BS	WPS Batteries		568	6R12	2-DCPR7E	NGK Sparkplugs	3932	558
	65991-82B	YTX20H-BS	WPS Batteries		568	6R12	2-DCPR7EIX	NGK Sparkplugs	6046	558
	66010-82B	YTX24HL-BS	WPS Batteries		568	71313-96A	820-50850	HardDrive	820-50850	521
	66010-97A/C	YIX30L	WPS Batteries		568	71313-96A	820-50851	HardDrive	820-50851	521
	66210-85B	820-2720	HardDrive	820-2720	570	71419-11	820-50856	HardDrive	820-50856	521
	66210-97	820-2721	HardDrive	820-2721	570	71419-11	820-50857	HardDrive	820-50857	521
	67024-84A	70-6011	Motion Pro	06-0011	643	71469-69	279-2108	All Balls Racing	79-2108	538
	67024-84A	70-660129	Motion Pro	66-0129	651	71483-72	820-50824	HardDrive	820-50824	211
	67026-37	70-6152	Motion Pro	06-0152	643	71507-65	275-01080	SMP	MCNSS1	523
	67026-62	70-6012	Motion Pro	06-0012	643	71507-71	275-01082	SMP	MCNSS3	523
	67026-81	70-6013	Motion Pro	06-0013	643	71517-11	820-50854	HardDrive	820-50854	521
	67026-81	70-660131	Motion Pro	66-0131	651	71517-11	820-50855	HardDrive	820-50855	521
	67027-96A	820-2639	HardDrive	820-2639	506	71534-72	820-50819	HardDrive	820-50819	211
	67033-99	820-2640	HardDrive	820-2640	506	71535-72	820-50825	HardDrive	820-50825	211
	67038-84	70-6011	Motion Pro	06-0011	643	71546-75A	820-50816	HardDrive	820-50816	211
	67038-84	70-660129	Motion Pro	66-0129	651	71547-75A	820-50823	HardDrive	820-50823	211
	67051-73	70-6010	Motion Pro	06-0010	643	71589-92	820-50828	HardDrive	820-50828	211
	67051-73	70-660128	Motion Pro	66-0128	651	71589-92CP	820-50833	HardDrive	820-50833	211
	67051-74	70-6011	Motion Pro	06-0011	643	71590-92	820-50830	HardDrive	820-50830	211
	67051-74	70-660129	Motion Pro	66-0129	651	71590-96	820-50837	HardDrive	820-50837	211
	67052-78A	70-6010	Motion Pro	06-0010	643	71591-92	820-50829	HardDrive	820-50829	211
	67052-78A	70-660128	Motion Pro	66-0128	651	71591-92CP	820-50834	HardDrive	820-50834	211
	67052-78B	70-6050	Motion Pro	06-0050	643	71597-92	820-50826	HardDrive	820-50826	211
	67052-78B	70-660132	Motion Pro	66-0132	651	71597-92CP	820-50831	HardDrive	820-50831	211
	67054-83A/B	70-6116	Motion Pro	06-0116	643	71599-92	820-50827	HardDrive	820-50827	211
	67054-83A/B	70-660135	Motion Pro	66-0135	651	71599-92CP	820-50832	HardDrive	820-50832	211
	67060-79A	70-6109	Motion Pro	06-0109	643	71800-26A	820-50814	HardDrive	820-50814	211
	67060-79A	70-660133	Motion Pro	66-0133	651	72001-69B	820-50820	HardDrive	820-50820	211

# HARDDRIVE TO OEM CROSS REFERENCE

OEM#	WPS#	Vendor	Vend#	Page#	OEM#	WPS#	Vendor	Vend#	Page#
72023-51A	275-01050	SMP	MCSLS4	<b>523</b>	74523-84A	273-1206	Cycle Electric	CE-205	<b>529</b>
72023-51E	275-01051	SMP	MCSLS4	<b>523</b>	74523-84A	820-60144	HardDrive	820-60144	<b>530</b>
72102-94BK	850-05503	Novello	DN-2RB	<b>513</b>	74523-84A	820-60145	HardDrive	820-60145	<b>530</b>
72103-94BK	850-05507	Novello	DN-3RB	<b>513</b>	74523-91	273-1207	Cycle Electric	CE-206	<b>529</b>
72104-94BK	850-05511	Novello	DN-4RB	<b>513</b>	74523-91	820-60142	HardDrive	820-60142	<b>530</b>
72106-94BK	850-05515	Novello	DN-6RB	<b>513</b>	74523-91	820-60143	HardDrive	820-60143	<b>530</b>
72108-94BK	850-05519	Novello	DN-8RB	<b>513</b>	74523-92	820-60140	HardDrive	820-60140	<b>530</b>
72109-94BK	850-05523	Novello	DN-12RB	<b>513</b>	74523-92	820-60141	HardDrive	820-60141	<b>530</b>
72112-94BK	850-05502	Novello	DN-2PB	<b>513</b>	74523-92A	273-1208	Cycle Electric	CE-207	<b>529</b>
72113-94BK	850-05506	Novello	DN-3PB	<b>513</b>	74523-94	820-60138	HardDrive	820-60138	<b>530</b>
72114-94BK	850-05510	Novello	DN-4PB	<b>513</b>	74523-94	820-60139	HardDrive	820-60139	<b>530</b>
72116-94BK	850-05514	Novello	DN-6PB	<b>513</b>	74523-94A	273-1209	Cycle Electric	CE-208	<b>529</b>
72118-94BK	850-05518	Novello	DN-8PB	<b>513</b>	74540-01	273-1221	Cycle Electric	CE-601	<b>529</b>
72119-94BK	850-05522	Novello	DN-12PB	<b>513</b>	74540-07	273-1222	Cycle Electric	CE-601-07	<b>529</b>
72122-94GY	850-05501	Novello	DN-2R	<b>513</b>	74540-07	820-60110	HardDrive	820-60110	<b>530</b>
72123-94GY	850-05505	Novello	DN-3R	<b>513</b>	74540-07	820-60111	HardDrive	820-60111	<b>530</b>
72124-94GY	850-05509	Novello	DN-4R	<b>513</b>	74540-08	273-1223	Cycle Electric	CE-601-08	<b>529</b>
72126-94GY	850-05513	Novello	DN-6R	<b>513</b>	74540-08	820-60108	HardDrive	820-60108	<b>530</b>
72128-94GY	850-05517	Novello	DN-8R	<b>513</b>	74540-08	820-60109	HardDrive	820-60109	<b>530</b>
72129-94GY	850-05521	Novello	DN-12R	<b>513</b>	74546-07	820-60134	HardDrive	820-60134	<b>530</b>
72132-94GY	850-05500	Novello	DN-2P	<b>513</b>	74546-07	820-60135	HardDrive	820-60135	<b>530</b>
72133-94GY	850-05504	Novello	DN-3P	<b>513</b>	74564-07	273-1211	Cycle Electric	CE-211	<b>529</b>
72134-94GY	850-05508	Novello	DN-4P	<b>513</b>	74587-94	275-01013	SMP	MCCBR4	<b>517</b>
72136-94GY	850-05512	Novello	DN-6P	<b>513</b>	74589-73	275-01012	SMP	MCCBR3	<b>517</b>
72138-94GY	850-05516	Novello	DN-8P	<b>513</b>	74599-77B	275-01011	SMP	MCCBR2	<b>517</b>
72139-94GY	850-05520	Novello	DN-12P	<b>513</b>	74600-94	275-01010	SMP	MCCBR1	<b>517</b>
74420-94	820-52359	HardDrive	820-52359	<b>507</b>	74600-97A	275-01016	SMP	MCCBR7	<b>517</b>
74430-00	820-52360	HardDrive	820-52360	<b>507</b>	74610-01	820-60112	HardDrive	820-60112	<b>530</b>
74437-96	820-52358	HardDrive	820-52358	<b>507</b>	74610-01	820-60113	HardDrive	820-60113	<b>530</b>
74504-78	820-60148	HardDrive	820-60148	<b>530</b>	74631-04	273-1224	Cycle Electric	CE-602	<b>529</b>
74504-78	820-60149	HardDrive	820-60149	<b>530</b>	74631-04	820-60120	HardDrive	820-60120	<b>530</b>
74504-82	820-60146	HardDrive	820-60146	<b>530</b>	74631-04	820-60121	HardDrive	820-60121	<b>530</b>
74504-82	820-60147	HardDrive	820-60147	<b>530</b>	74631-06	273-1225	Cycle Electric	CE-602-06	<b>529</b>
74505-02	273-1218	Cycle Electric	CE-445-02	<b>529</b>	74631-06	820-60118	HardDrive	820-60118	<b>530</b>
74505-02	820-60104	HardDrive	820-60104	<b>530</b>	74631-06	820-60119	HardDrive	820-60119	<b>530</b>
74505-02	820-60105	HardDrive	820-60105	<b>530</b>	74631-08	273-1226	Cycle Electric	CE-602-08	<b>529</b>
74505-04	273-1219	Cycle Electric	CE-445-04	<b>529</b>	74631-08	820-60116	HardDrive	820-60116	<b>530</b>
74505-04	820-60102	HardDrive	820-60102	<b>530</b>	74631-08	820-60117	HardDrive	820-60117	<b>530</b>
74505-04	820-60103	HardDrive	820-60103	<b>530</b>	74661-04	820-2638	HardDrive	820-2638	<b>508</b>
74505-06	273-1230	Cycle Electric	CE-606	<b>529</b>	74662-04	820-2637	HardDrive	820-2637	<b>508</b>
74505-06	820-60100	HardDrive	820-60100	<b>530</b>	74711-08	820-60132	HardDrive	820-60132	<b>530</b>
74505-06	820-60101	HardDrive	820-60101	<b>530</b>	74711-08	820-60133	HardDrive	820-60133	<b>530</b>
74505-09	820-60155	HardDrive	820-60155	<b>530</b>	786A	681-4274	James Gaskets	JGI-31434-06	<b>475</b>
74505-09	820-60156	HardDrive	820-60156	<b>530</b>	83162-51	681-4548	James Gaskets	JGI-83162-51	<b>479</b>
74505-95	273-1217	Cycle Electric	CE-445	<b>529</b>	83162-51	681-4549	James Gaskets	JGI-83162-51-DL	<b>479</b>
74505-97	273-1220	Cycle Electric	CE-445-97	<b>529</b>	83162-51DL	68-9350	Cometic Gaskets	C9350	<b>459</b>
74505-97	820-60106	HardDrive	820-60106	<b>530</b>	83911-09B	15-605/4H	EBC Brakes	FA605/4HH	<b>674</b>
74505-97	820-60107	HardDrive	820-60107	<b>530</b>	90-4111	68-9155	Cometic Gaskets	C9155	<b>454</b>
74507-85	820-60150	HardDrive	820-60150	<b>530</b>	91668-05	820-55250	HardDrive	820-55250	<b>144</b>
74507-85	820-60151	HardDrive	820-60151	<b>530</b>	91800058-B	68-10205	Cometic Gaskets	C10205	<b>453</b>
74508-85	820-60152	HardDrive	820-60152	<b>530</b>	91800058-O	68-10206	Cometic Gaskets	C10206	<b>453</b>
74508-85	820-60153	HardDrive	820-60153	<b>530</b>	91800058-X	68-10200	Cometic Gaskets	C10200	<b>452</b>
74510-70A	820-60130	HardDrive	820-60130	<b>530</b>	91930-92T	820-55574	HardDrive	820-55574	<b>193</b>
74510-70A	820-60131	HardDrive	820-60131	<b>530</b>	91930-92T	820-55575	HardDrive	820-55575	<b>193</b>
74510-75A	820-60128	HardDrive	820-60128	<b>530</b>	91931-92T	820-55572	HardDrive	820-55572	<b>193</b>
74510-75A	820-60129	HardDrive	820-60129	<b>530</b>	91931-92T	820-55573	HardDrive	820-55573	<b>193</b>
74512-00	273-1216	Cycle Electric	CE-325L	<b>529</b>	93-1033	68-10009	Cometic Gaskets	C10009	<b>459</b>
74512-00	820-60114	HardDrive	820-60114	<b>530</b>	Bearing:9008/9009	22-51369	All Balls Racing	25-1369	<b>795</b>
74512-00	820-60115	HardDrive	820-60115	<b>530</b>	Seal:41210-55				
74512-79A	273-1201	Cycle Electric	CE-203	<b>529</b>	Bearing:9052	22-51001	All Balls Racing	25-1001	<b>795</b>
74516-86	273-1202	Cycle Electric	CE-204	<b>529</b>	Seal:47519-72				
74516-86	820-60126	HardDrive	820-60126	<b>530</b>	Bearing:9052	22-51002	All Balls Racing	25-1002	<b>795</b>
74516-86	820-60127	HardDrive	820-60127	<b>530</b>	Seal:47519-83A				
74518-99A	273-1215	Cycle Electric	CE-324	<b>529</b>					
74518-99A	820-60122	HardDrive	820-60122	<b>530</b>					
74518-99A	820-60123	HardDrive	820-60123	<b>530</b>					
74519-88	273-1212	Cycle Electric	CE-320	<b>529</b>					
74519-88	273-1212	Cycle Electric	CE-320	<b>529</b>					
74519-88	820-60124	HardDrive	820-60124	<b>530</b>					
74519-88	820-60125	HardDrive	820-60125	<b>530</b>					
74523-04	273-1210	Cycle Electric	CE-210	<b>529</b>					
74523-04	820-60136	HardDrive	820-60136	<b>530</b>					
74523-04	820-60137	HardDrive	820-60137	<b>530</b>					

WINDSHIELDS / FAIRINGS
AUDIO / COMMUNICATION
SEATS / LUGGAGE
BAR / MIRRORS / CONTROLS
EXHAUST
AIR / FUEL SYSTEMS
ENGINE
TRANSMISSION / DRIVELINE
GASKETS / SEALS
ELECTRICAL
LIGHTING
CABLES
BRAKES
OIL FILTERS
SUSPENSION
BODY
WHEELS
TIRES / TIRE ACC.
BIKE ACC.
VICTORY / INDIAN
COVERS / LOCKS / TIEDOWNS
CHEMICALS
TOOLS
HELMETS
HELMET ACC.
EYEWEAR
APPAREL / RIDER ACC.
PROMOTIONAL
REFERENCE
INDEX

A

WINDSHIELDS / FAIRINGS

AUDIO / COMMUNICATION

SEATS / LUGGAGE

BAR / MIRRORS / CONTROLS

EXHAUST

AIR / FUEL SYSTEMS

ENGINE

TRANSMISSION / DRIVELINE

GASKETS / SEALS

ELECTRICAL

LIGHTING

CABLES

BRAKES

OIL FILTERS

SUSPENSION

BODY

WHEELS

TIRES / TIRE ACC.

BIKE ACC.

VICTORY / INDIAN

COVERS / LOCKS / TIEDOWNS

CHEMICALS

TOOLS

HELMETS

HELMET ACC.

EYEWEAR

APPAREL / RIDER ACC.

PROMOTIONAL

REFERENCE

INDEX

ABS Tube Adapters ..... 679

ABS Wheel Bearings ..... 708

**ACCEL**

Electric Charging System ..... 526

Fuel Petcocks ..... 349

Oil Pressure Gauges ..... 399

Oil Pressure Switches ..... 400

Points & Condensers ..... 553

Regulators ..... 531

Spark Plugs ..... 558

Spark Plug Wires ..... 554-555

Starter Solenoids & Relays ..... 539

Stators ..... 527

Super Coils ..... 551-552

Switches ..... 520

Accessory Mounting Kits ..... 832-840

**ACCUTRONIX**

Bagger Lights ..... 601

Brake Arms ..... 247

Fender Spacers ..... 723

Floorboards ..... 247-248

Fork Stem Nut ..... 718

Forward Control Extensions ..... 225

Forward Controls ..... 246

Gauge Mounts ..... 508

Latch Inserts/Covers ..... 751

License Mounts ..... 596

Master Cylinders ..... 246

Shift Levers ..... 246-247

Transmission Dipstick ..... 434

**ACERBIS**

Hand Deflectors ..... 219

**ACTIA**

Diagnostic Scan Tools ..... 542-544

Diagnostic Systems ..... 990-991

**ADAPTIV**

Radar/Laser Detectors ..... 830-831

**ADAPTIV TECHNOLOGIES**

Promotional Items/Displays ..... 1291

**Adhesive Removers**

Liquid Performance ..... 958

Permatex ..... 988

**Adhesives**

Permatex ..... 986

Three Bond ..... 984

**Air Filter Oil/Cleaners**

Bel-Ray ..... 924-925

Klotz ..... 931

K&N ..... 983

Lucas Oil ..... 934

Maxima ..... 939

PJ1 ..... 946

Air Filters, Indian / Victory ..... 873

**AIR FORCE BLASTER**

Motorcycle Dryers ..... 1023

**AIR / FUEL SYSTEMS ..... 305-353**

Air Cleaner Adapter ..... 315

Air Cleaner Brackets ..... 314

Air Cleaner Covers ..... 313

Air Cleaners ..... 305-312

Air Filter Oil/Cleaners 322, 924, 934, 939, 931

Air Filters ..... 321-323

Air Intake Systems ..... 316-321

Carb Covers ..... 310

Carb Float ..... 342

Carb Rebuild Kits ..... 339-340

Carburetors ..... 334

Carburetor Support Brackets ..... 315

A (continued...)

**AIR / FUEL SYSTEMS ..... 305-353**

Carburetor Tools ..... 343

Check Valve O-Rings ..... 344

Check Valve Rebuild Kit ..... 344

Check Valve Rebuild Tool ..... 344

Choke Knob Covers ..... 313

Crankcase Vent Air Filters ..... 322

CV Carb Recalibration Kit ..... 338

CV Carb Top Cover ..... 335

Dobeck Performance Systems ..... 871-873

Dynatek Systems ..... 870

EFI Fuel Filters ..... 347

EFI Tuners ..... 324-332

Fuel Filters ..... 353

Fuel Hose Protector ..... 352

Fuel Injection Cleaners ..... 333

Fuel Injection Lines ..... 345-346

Fuel Injectors ..... 332-333

Fuel Line ..... 350

Fuel Petcocks ..... 349

Fuel Pressure Gauge ..... 344

Fuel Pumps ..... 348

Fuel Sharing System ..... 343

Fuel Siphons ..... 353

Hose Clamps ..... 351-352

Hose Clips ..... 352

Idle Mixture Screws ..... 339

Intake Clamps ..... 341

Intake Manifold Gaskets ..... 342

Jet Kits ..... 335

Jets ..... 336-337

Leak Detector ..... 343

Manifold Mounting Flange ..... 341

Mikuni Product Catalog ..... 343

O2 Sensors ..... 332

Pocket Tuner ..... 343

Pressure Regulators ..... 347

Throttle Slide Membrane ..... 342

Tuner Kits ..... 338

**AIR HAWK**

Promotional Items/Displays ..... 1291

Seat Cushions ..... 114

**Air Hoses & Fittings ..... 1033**

Air Lifts ..... 1074-1077

**Air Tools**

Air Tanks ..... 1009

Blow Gun ..... 1010

Rivet Gun ..... 1004

Spray Tanks ..... 1009

Tire Bead Seating Tank ..... 1009

**ALL BALLS**

4-Speed Solenoid ..... 538

Battery Cables ..... 569

Clutch Hub Bearing ..... 412

Fork & Dust Seal Kits ..... 885-887

Fork/ Dust Seals ..... 717

Generators ..... 532

Jackshaft Kit ..... 536

Primary Bearings & Seal Kit ..... 435

Starters ..... 534

Steering Head Bearings ..... 718

Swing Arm Bearings ..... 718, 758

Wheel Bearings ..... 884-887

Wheel Bearings & Seals ..... 795

Allen Sockets ..... 996

Allen Wrenches/Sockets ..... 1000

Alternator Kits ..... 528

A (continued...)

**ALTO**

Clutch Kits & Parts ..... 405-406

Amp Kits ..... 37-40

**ANCRA**

Chocks ..... 914

Tiedowns ..... 907

Antennas ..... 55-56

Anti-Freeze ..... 975, 977

Anti-Seize, Bolts

Permatex ..... 986

**AO**

Saddlebag Cooler ..... 122

**APPAREL / RIDER ACC ..... 1184-1290**

Armor-FLY ..... 1201

Armor-Scorpion ..... 1219

Balaclavas ..... 1283

Base Layers ..... 1231

Boots ..... 1262-1267

Boot Dryers ..... 1267-1268

Casual Apparel-HWY 21 ..... 1200

Cooling Sleeves ..... 1289

Ear plugs ..... 1290

Gloves- HWY 21 ..... 1235-1242

Gloves-FLY ..... 1243-1251

Gloves-Scorpion ..... 1252-1258

Gloves-Venture Heat ..... 1259-1260

Head Wraps & Face Masks ..... 1269-1288

Heated Gear ..... 1232-1234

Mens Riding Jackets-FLY ..... 1202-1207

Mens Riding Jackets-HWY 21... 1184-1188

Mens Riding Jackets-Scorpion.. 1215-1217

Mens Riding Pants-FLY ..... 1211-1214

Mens Riding Pants-Scorpion ..... 1216

Rain Gear-Dowco ..... 1223

Rain Gear-FLY ..... 1223

Rain Gear-Frogg Toggs ..... 1226-1230

Rain Gear-Nelson Rigg ..... 1224-1225

Rider Pant/ Boot Clips ..... 1287-1288

Riding Chaps-HWY 21 ..... 1197

Riding Hoodie-HWY 21 ..... 1190

Riding Jeans-Daryko ..... 1220-1222

Riding Jeans-FLY ..... 1214

Riding Jeans-HWY 21 ..... 1198-1199

Riding Jeans-Scorpion ..... 1219

Riding Shirts-Scorpion ..... 1218

Safety Vests ..... 1230

Shoes, Riding ..... 1265-1266

Vests-HWY 21 ..... 1192-1196

Womens Riding Jackets-FLY ..... 1208-1210

Womens Riding Jackets-HWY 21 ..... 1189

Womens Riding Jackets-Scorpion..... 1215, 1217

Womens Riding Pants-FLY ..... 1212

Appraisal Guides ..... 1082

Apron ..... 1070

**AQUATICAV**

Bluetooth Stereos ..... 32

Speakers & Amps ..... 33-34

**ARNOTT**

Air Suspension ..... 696-697

Fox Shock Absorber ..... 883

**Assembly Lube**

Bel-Ray ..... 924

Lucas Oil ..... 933

Maxima ..... 938

Permatex ..... 988

Red Line ..... 950

Torco ..... 953

**A (continued...)**

**ATHENA**  
 Jump Start Pack ..... 580

**AUDIO / COMMUNICATION 32-81**  
 Amp Kits ..... 37-40  
 Antennas ..... 55-56  
 Bluetooth Controllers ..... 51  
 Bluetooth Stereos ..... 32  
 Handlebar Speakers ..... 50-54  
 Headsets & Communication Systems 53-55  
 Speaker & Amp Kits ..... 35-36  
 Speaker Kits ..... 41-43  
 Speakers ..... 33  
 Speaker Support Brackets ..... 48  
 Wiring Harnesses ..... 44

**AUTOLITE**  
 Spark Plugs ..... 559

Auxiliary Fuel Tank ..... 1051

**AVON**  
 Axle Nut Covers ..... 756-757  
 Footpegs ..... 230-233  
 Grips ..... 201-205, 861-863

Axels ..... 790  
 Axle Adjuster blocks, plates.. 790-791  
 Axle Nut Covers ..... 758  
 Axle Spacers  
 HardDrive ..... 792

**B**

Bagger Lights ..... 601

**BAGGER NATION**  
 Front End Kits ..... 707

Bags, Swingarm ..... 137

**BAKER DRIVETRAIN**  
 Fine Tooth Adjustment Kit ..... 415  
 Inner Primary Service Kit ..... 1057  
 Maindrive Service Kit ..... 1057  
 Oil Dipsticks, Spouts, Caps ..... 400  
 Pulley Nut Tools ..... 1057  
 Sprockets ..... 440  
 Transmission Build Kits ..... 429-431, 435  
 Transmission Parts ..... 432-433

Balancing Beads ..... 811  
 Ball Pein Hammers ..... 1003  
 Bandannas & Head Wraps 1269-1279  
 Banjo Bolts ..... 685  
 Bar Harness ..... 909-910

**BARS/MIRRORS/CONTROLS ...149-253**  
 Brake Arms ..... 239-241  
 Cruise Controller ..... 206  
 Floorboard Mounts ..... 252-253  
 Floorboards ..... 247-252  
 Footpeg Mounts ..... 238  
 Footpegs/Shiftpegs ..... 227-237  
 Forward/Mid Controls ..... 221-226, 246  
 Grips ..... 197-205  
 Grip Warmer ..... 206  
 Hand Controls ..... 214-218  
 Hand Deflectors ..... 219-220  
 Handlebars ..... 149-174  
 Heel Shift Eliminators ..... 242  
 Levers ..... 217-220  
 Master Cylinder Covers ..... 207-209  
 Mirror Mounts ..... 196  
 Mirrors ..... 187-195  
 Risers/Hardware/Clamps ..... 176-184  
 Shift Rods ..... 244-245, 436  
 Wiring Extension Kits ..... 185-186

Base Layers ..... 1231

**B (continued...)**

Batteries ..... 560-568  
 Battery Cables ..... 569  
 Battery Chargers ..... 571-579  
 Battery Hardware ..... 570  
 Battery Pack, Portable ..... 74

**BATTERY TENDER**  
 Batteries ..... 561  
 Battery Chargers ..... 572-575  
 Promotional Items/Displays ..... 1291

Battery Tester ..... 571, 579

**BAZZAZ**  
 Fuel Management Systems ..... 870

Bead Breaker ..... 1029

Bearings  
 Inner Primary ..... 435  
 Oil Seal ..... 432  
 Throwout ..... 432

**BEL-RAY**  
 Chemicals & Lubes ..... 920-925  
 Promotional Items/Displays ..... 1291

**BIG BIKE PARTS**  
 Sound Systems ..... 49  
 Tire Monitoring System ..... 817

**BIKE ACCESSORIES 820-856**  
 Camera ..... 827-829  
 Clocks ..... 850  
 Colony ..... 856  
 Dress-Up Kits ..... 848  
 Fairing Doors ..... 846  
 Fairing Vent Trim & Screen ..... 847  
 Fenix Watches ..... 825-826  
 Flag Mounts ..... 850-851  
 Fuel Sling w/Bottle ..... 849  
 Garage Door/Gate Opener ..... 821  
 Garage Door Opener ..... 821  
 Gardner-Westcott Company ..... 856  
 GPS Devices ..... 822-824  
 Key Keeper ..... 849  
 License Plate Accessories ..... 852-854  
 Mounts & Accessories ..... 832-838  
 Nash Accessories ..... 849  
 Power Ports ..... 842-843  
 Radar/Laser Detector Mounts ..... 831  
 Radar/Laser Detectors ..... 830-831  
 Reflectors ..... 854  
 Registration Tubes ..... 853  
 Ryder Balls ..... 820  
 Saddlebag Accessories ..... 844-846  
 Spot Light Visors ..... 847

Bike Wash  
 Bel-Ray ..... 925  
 Hog Wash ..... 954  
 Liquid Performance ..... 958  
 Maxima ..... 940  
 Motul ..... 944  
 Original Bike Spirits ..... 963  
 S100 ..... 964-966  
 Star Brite ..... 976  
 Wizards Products ..... 970-971

Bleeders, Brake/Clutch/Injectors 1043

**BLENDZALL**  
 Chemicals & Lubes ..... 926-927

Blow Gun ..... 1033

**BLU**  
 Tire Pressure Monitoring System ..... 818

**BLUE JOB** ..... 982

**BLUE STEAK**  
 Points & Condensers ..... 553

**B (continued...)**

Bluetooth Communication Systems... 57-65  
 Bluetooth Controllers ..... 51  
 Bluetooth Stereos ..... 32

**BLUHM ENTERPRISES**  
 X-Treme Tape ..... 1070

**BOBSTER**  
 Eyewear ..... 1150-1167  
 Promotional Items/Displays ..... 1292

**BODY 722-779**  
 Axle Nut Covers ..... 756-757  
 Battery Box ..... 762  
 Batwing Fairing ..... 28  
 Billet Ignition Covers ..... 753  
 Bolt Covers ..... 757  
 Bungs, Tabs & Plates ..... 763-767  
 Clamp-on Pegs ..... 779  
 Electronics Box ..... 762  
 Engine Guards ..... 775-776  
 Fenders & Hardware ..... 722-732  
 Fender Tips & Speedo Cowls ..... 754-755  
 FLTR Gauge Housing ..... 28  
 Front Axle Nut Covers ..... 758  
 Fuel Doors ..... 744  
 Fuel Tank Console Doors ..... 743  
 Gas Caps ..... 741-744  
 Gas Tank Cover ..... 740  
 Gas Tank Garnish Cover ..... 774  
 Gas Tank Lift Kit ..... 740  
 Gas Tanks ..... 734-737  
 Headlight Cowls ..... 29  
 Kickstands & Parts ..... 769-771  
 Mud Guards ..... 774  
 Oil Tanks ..... 761  
 Passenger Peg Relocation Kit ..... 774  
 Rigid Frames ..... 760  
 Rubber Mounts & Wellnets ..... 768  
 Saddlebag Brackets ..... 747  
 Saddlebag Latch Inserts / Covers ..... 750  
 Saddlebag Latch Kit ..... 749  
 Saddlebags - ABS ..... 746  
 Saddlebag Speaker Lids ..... 746  
 Skid Plates ..... 772-773  
 Swingarm Bearing Conversion Kit ..... 759  
 Swing Arm Bearings ..... 758  
 Swingarm Bushing ..... 758  
 Swingarm Isolator Mount ..... 758  
 Tank Mounts ..... 738-739  
 Tank Panels ..... 744  
 Tracker Swingarm ..... 759  
 Universal Hardtail Kit ..... 762

**BOLT**  
 License Plate Accessories ..... 854  
 Bolt Extractors ..... 1005

**BOMBER**  
 Eyewear ..... 1181-1182  
 Promotional Items/Displays ..... 1293

Boot Dryers ..... 1267-1268  
 Boots & Covers ..... 1264-1265

**BOSS AUDIO**  
 Bluetooth Controllers ..... 51  
 Handlebar Speaker Systems ..... 50-52

**BOYESAN**  
 Air Intake Systems ..... 316

Brake Arms ..... 239-241  
 Brake Bleeders ..... 1043  
 Brake Caliper Tool ..... 1043  
 Brake Cleaners

WINDSHIELDS / FAIRINGS

AUDIO / COMMUNICATION

SEATS / LUGGAGE

BAR / MIRRORS / CONTROLS

EXHAUST

AIR / FUEL SYSTEMS

ENGINE

TRANSMISSION / DRIVELINE

GASKETS / SEALS

ELECTRICAL

LIGHTING

CABLES

BRAKES

OIL FILTERS

SUSPENSION

BODY

WHEELS

TIRES / TIRE ACC.

BIKE ACC.

VICTORY / INDIAN

COVERS / LOCKS / TIEDOWNS

CHEMICALS

TOOLS

HELMETS

HELMET ACC.

EYEWEAR

APPAREL / RIDER ACC.

PROMOTIONAL

REFERENCE

INDEX

**B (continued...)**

**Brake Cleaners**  
 Bel-Ray..... 925  
 Klotz..... 930  
 Liquid Performance..... 958  
 Lucas Oil..... 934  
 Maxima..... 939  
 Mechanics..... 979  
 Original Bike Spirits..... 963  
 PJ1..... 947  
 Torco..... 953  
 Tru-Tension..... 968

**Brake Fluid**  
 Bel-Ray..... 924  
 Castrol..... 928  
 Lucas Oil..... 934  
 Maxima..... 940  
 Motul..... 943  
 Red Line..... 949

**Brake Light Banjos**..... 679

**Brakeline Clamps**..... 685

**Brakeline Fittings**..... 681-682

**Brakelines**..... 680

**BRAKES**..... 661-689

ABS Tube Adapters..... 679  
 Banjo Bolts..... 685  
 Brake Light Banjos..... 679  
 Brakeline Clamps..... 685  
 Brakeline Fittings..... 681-682  
 Brakeline Kits & Parts..... 676-685  
 Brakelines..... 680  
 Brake Rotor Hardware..... 669  
 Caliper Parts..... 670, 676  
 Caliper Rebuild Kits..... 687  
 Hardware..... 669-670  
 Master Cylinder Covers..... 686  
 Master Cylinder Mounting Kit..... 686  
 Master Cylinder Rebuild Kits..... 687  
 Master Cylinders..... 686  
 Pads & Shoes..... 671-674  
 Rotors..... 661-665  
 Speedbleeders..... 679  
 Tees..... 683

**BRAKING**  
 Brake Pads & Shoes..... 880

**BRASS BALLS CYCLES**  
 Air Cleaner Covers..... 313  
 Derby Covers..... 422  
 Floorboards..... 249  
 Foot/Shift Pegs..... 235  
 Fuel Doors..... 744  
 Grips..... 200, 861  
 Master Cylinder Covers..... 207  
 Points Covers..... 389  
 Risers..... 177  
 Tank Panels..... 744  
 Top Clamps..... 177

**Brushes, Nylon Bore**..... 1052

**Bungee Cords**..... 917

**BUSS**  
 Fuse Holders..... 519  
 Fuses..... 518  
 Toggle Switches..... 519

**BUTTY BUDDY**  
 Seat Pad..... 113

**C**

**Cable Locks**..... 896-904

**Cable Lube/Luber**  
 Champions Choice..... 980  
 Firepower by WPS..... 980  
 Motion Pro..... 980  
 PJ1..... 980

**CABLES**..... 637-660  
 Armor Coat Clutch Cables..... 647-650  
 Armor Coat Speedo Cables..... 651-652  
 Armor Coat Throttle Cables..... 644-646  
 Blackout Clutch Cables..... 655-656  
 Blackout Speedo Cables..... 656  
 Blackout Throttle Cables..... 653-654  
 Cable Clamps..... 658  
 Cable Fittings..... 658-660  
 Cable Wire..... 660  
 Hydraulic Clutch Lines..... 657  
 OEM Vinyl Choke Cables..... 643  
 OEM Vinyl Clutch Cables..... 640-642  
 OEM Vinyl Speedo Cables..... 643  
 OEM Vinyl Throttle Cables..... 637-639

**Cable Ties**..... 1066

**Caliper, Digital**..... 1007

**Caliper Mounting Kits**..... 669

**Caliper Parts**..... 670, 676

**Cam Covers**..... 386-388

**CAMEL**  
 Tire Repair Kits..... 1034

**Cameras**..... 60, 73, 827-829

**Cam Install Kit**..... 1053

**Camshafts, Install Kits, Parts**..... 376-381

**CANYON DANCER**  
 Tiedowns..... 910

**Carb Leak Detector**..... 1051

**Carburetor/Choke Cleaner**  
 Mechanics..... 979  
 Original Bike Spirits..... 963  
 PJ1..... 947  
 Red Line..... 950  
 Tru-Tension..... 969

**Carburetor Covers**..... 310

**Carburetor Float**..... 342

**Carburetor Products Catalog**..... 343

**Carburetor Rebuild Kits**..... 339-340

**Carburetors**..... 334

**Carburetor Support Brackets**..... 315

**Carburetor Tools**..... 343

**Cargo Nets**..... 917

**CASTROL**  
 Chemicals & Lubes..... 928-929  
 Promotional Items/Displays..... 1293

**Catalog Racks**..... 1083

**Chain Brush**..... 451

**Chain Lube/Cleaners**  
 Bel-Ray..... 923  
 Blendzall..... 927  
 Klotz..... 930  
 Lucas Oil..... 932-933  
 Luster Lace..... 961  
 Maxima..... 936-938  
 Motul..... 944  
 Original Bike Spirits..... 963  
 PJ1..... 947  
 Tirox..... 967  
 Torco..... 953  
 Tru-Tension..... 968

**C (continued...)**

**Chains**  
 Alignment Tools..... 1040, 1041  
 Breakers..... 1037-1039  
 Chemicals & Lubes..... 923, 932-938, 944, 947, 953, 963, 961  
 Rivot Tools..... 1038, 1040

**Chains, Drive**..... 444-451

**Chains, Primary**..... 416

**Chalk Spray**..... 948

**CHAMPIONS CHOICE**  
 Chemicals & Lubes..... 980

**Charging System, Electric**..... 526

**Check Valve O-Rings**..... 344

**Check Valve Rebuild Kit & Tool**..... 344

**CHEMICALS & LUBES**..... 918-989  
 Bel-Ray..... 920-925  
 Blendzall..... 926-927  
 Blue Job..... 982  
 Castrol..... 928-929  
 Champions Choice..... 980  
 Firepower by WPS..... 980  
 Fitch..... 975  
 Gasegacinch..... 979  
 HardDrive..... 918-919  
 Hog Wash..... 954-956  
 K100..... 931  
 Klotz..... 929-931  
 K&N..... 983  
 Kreem..... 983  
 Leather Therapy..... 974  
 Liquid Performance..... 957-959  
 Lucas Oil..... 932-937  
 Luster Lace..... 961  
 Maxima..... 935-941  
 Mechanics..... 979  
 Motion Pro..... 980  
 Motul..... 941-945  
 Original Bike Spirits..... 963  
 PC Racing..... 962  
 Permatex..... 985-989  
 Pig Spit..... 962  
 PJ1..... 946-950, 980  
 Plexus..... 962  
 Quik Steel..... 979  
 Red Line..... 949-951  
 S100..... 964  
 Slip Steamer..... 962  
 Sta-Bil..... 975  
 Sta-Dri..... 981  
 Star Brite..... 981  
 Three Bond..... 984  
 Tirox..... 967  
 Torco..... 951-954  
 Tri-Flow..... 980  
 Tru-Tension..... 968-969  
 Wizards Products..... 970-972  
 Workshop Hero..... 982

**Chisels/Punches**..... 1006

**Chocks**..... 913-914

**Choke Knob Covers**..... 313

**CHRIS PRODUCTS**  
 License Plate Frame..... 852  
 Reflectors..... 854

**Chrome Polish**..... 961

**Circuit Breakers**..... 517

**CIRIUS**  
 Engine Guard/ Handlebar Lights..... 605



C (continued...)

Clamp-on Pegs ..... 779, 886  
 Clamps, Cable ..... 658  
 Cleaner/Oil/Grease, Air Filter ..... 322  
 Cleaners, All Purpose  
   Hog Wash ..... 954  
   Liquid Performance ..... 958  
   Maxima ..... 940  
   Pig Spit ..... 962  
   Star Brite ..... 976  
   Tru-Tension ..... 969  
 Cleaners, Hands  
   Fast Orange ..... 989  
   Motul ..... 945  
 Cleaners, Windshield  
   Hog Wash ..... 954  
   Slip Streamer ..... 962  
 Clocks ..... 850  
 Clutch Adjuster ..... 1056  
 Clutch Cables ..... 640-642, 647-650, 655-657  
 Clutch Holding Tool ..... 1055  
 Clutch Hub Keys & Springs ..... 412  
 Clutch Hub Removing Driver ..... 1058  
 Clutch Kits & Parts ..... 405-409  
 Clutch Pushrods/Adjusters ..... 411  
 Clutch Release Kit ..... 411  
 Clutch Shells & Hubs ..... 410  
 Clutch Tools ..... 1058  
**CLYMER**  
   Promotional Items/Displays ..... 1293  
 Coils ..... 550-552  
**COLONY**  
   Battery Terminal Screw Kit ..... 570  
   Brake Rotor Hardware ..... 669  
   Caliper Mounting Kits ..... 669  
   Crank Pin Nut/ Lock Plate ..... 385  
   Fork Bearing Adjustment Kit ..... 718  
   Fork Stem Cap ..... 719  
   Fork Tube Bolt / Plug ..... 719  
   Hardware ..... 856  
   Headbolt Kits ..... 393  
   Inner Primary Mounting Kits ..... 418  
   Main Shaft Nut ..... 434  
   Master Cylinder Mounting Kit ..... 686  
   Motor Sprocket Nut ..... 385  
   Oil Pump Plugs ..... 384  
   Pinion/Sprocket Shaft Nuts ..... 385  
   Push Rod Adjuster Lock Nuts ..... 373  
   Pushrod Cover Conversion Kit ..... 374  
   Pushrod Cover Kits ..... 375  
   Push Rods ..... 373  
   Rear Brake Master Cylinder Mounts ..... 669  
   Rocker Box Nut Kit ..... 357  
   Rocker Shaft End Plugs ..... 357  
   Shock Mounting Kit ..... 706  
   Tank Mounts ..... 739  
**COMETIC** ..... 452-472  
   Scout Head Gaskets ..... 874  
 Communication  
   Sena Action Cameras ..... 60, 73  
   Sena Communication Systems ..... 57-81  
 Communication Systems ..... 53-55  
 Communication Systems, Bluetooth ..... 57-81  
 Compensator Sprockets ..... 413-414  
 Compression Tester ..... 1053  
 Condensers & Points ..... 553

C (continued...)

**CONDOR**  
   Chocks ..... 913  
 Connecting Rod Assy ..... 367  
 Connectors, Wiring ..... 512-514  
 Contact Cleaners  
   Bel-Ray ..... 925  
   Klotz ..... 930  
   Liquid Performance ..... 958  
   Lucas Oil ..... 934  
   Maxima ..... 939  
   Mechanics ..... 979  
   Original Bike Spirits ..... 963  
   PJ1 ..... 947  
   Torco ..... 953  
 Controls, Kits & Parts ..... 221-253  
 Conversion Fluid, Bendzall ..... 927  
 Coolant  
   Sta-Bil ..... 975  
   Star Brite ..... 977  
**COUNTERACT**  
   Inner Tubes ..... 811  
   Promotional Items/Displays ..... 1293  
   Wheel Weights ..... 811  
**COVERS/LOCKS/TIEDOWNS . 888-917**  
   Bar Harness ..... 909-910  
   Cargo Nets & Bungee Cords ..... 917  
   Chocks ..... 913-914  
   Covers, Dowco ..... 893-895  
   Covers, Nelson-Rigg ..... 889-891  
   Covers, Speed-Way ..... 888  
   Covers, WPS ..... 892  
   Cycle Alarm ..... 904  
   Locks, Kryptonite ..... 896-899  
   Locks, Master ..... 900-901  
   Locks, Xena ..... 902-903  
   Tiedown Assist ..... 910  
   Tiedowns, Ancra ..... 907  
   Tiedowns, High Roller ..... 909  
   Tiedowns, Lockstraps ..... 905  
   Tiedowns, Powertye ..... 906-907  
   Tiedowns, Quick Loader ..... 908  
   Tiedowns, Vortex ..... 908  
   Tow & Stow Kits ..... 912  
   Track Anchoring System ..... 915-916  
   Utility Trailer ..... 911  
**CRAMPBUSTER**  
   Cruise Controller ..... 206  
 Crankcase Vent Air Filters ..... 322, 401  
 Crankshaft Tool ..... 381  
 Crankshaft Tools ..... 1058  
 Cruise Controller ..... 206  
**CRUZ TOOLS**  
   Allen Wrenches/Sockets ..... 1036  
   Sag Scale ..... 1050  
   Socket Bit Set ..... 1016  
   Tire Pressure Gauges ..... 1032  
   Tool Kits ..... 1013-1015  
   Tool Pouch ..... 1060  
   Wrenches ..... 1050  
   Wrenches, Shock ..... 1050  
   Wrenches, Spanner ..... 1050  
 Cush Drive ..... 438  
 Cushions, Seat ..... 114-115  
**CUSTOM DESIGN STUDIOS**  
   Tracker Swingarm ..... 759  
 CV Carburetor Recalibration Kit .. 338  
 CV Carburetor Top Cover ..... 335

C (continued...)

Cycle Alarms ..... 904  
**CYCLE CRAFT**  
   Caliper Rebuild Kits ..... 687  
   Master Cylinder Rebuild Kits ..... 687  
**CYCLE ELECTRIC INC**  
   Alternator Kits ..... 528  
   Generators ..... 532  
   Stators & Regulators ..... 529  
**CYCLE PIRATES**  
   Adjustable Levers ..... 241  
   Axle Adjuster Plates & Locators ..... 791  
   Foot Pegs ..... 240  
**CYCLE PRO**  
   Carb Float ..... 342  
   Carb Rebuild Kits ..... 339  
   Carburetor Jets ..... 337-338  
   CV Carb Recalibration Kit ..... 338  
   O2 Sensors ..... 332  
   Piston Rings ..... 365  
 Cylinders ..... 366-367  
 Cylinder Stud & Head Bolt Kits ..... 394-395  
**D**  
**DANNY GRAY**  
   Seats ..... 82-89  
**DAYTONA TWIN TEC**  
   Bluetooth & USB Interface ..... 332  
   Diagnostic Scan Tools ..... 540-541  
   Diagnostic Systems ..... 992-993  
   EFI Tuners ..... 327  
   Fuel Injectors ..... 333  
   Ignition Kits ..... 548-550  
   O2 Sensors ..... 332  
 Dead Blow Hammers ..... 1003  
**DEADBOLT**  
   Tow and Stow Kits ..... 912  
 Degreasers  
   Permatex ..... 988  
   PJ1 ..... 946  
**DEI**  
   Exhaust Wrap & Shield ..... 300-301  
   Locking Ties ..... 303  
   Silicone Coating ..... 303  
 Dennis Stubblefield (D.S.S.)  
   Clutch Hub Removing Driver ..... 1058  
   Crankshaft Jam Tool ..... 1058  
   Crankshaft Turning Tool ..... 1058  
   Ignition Point Tool ..... 1058  
 Derby Covers ..... 422-423  
 Detailing Cloths  
   Hog Wash ..... 955  
   Liquid Performance ..... 957  
   S100 ..... 966  
   Wizards Products ..... 971, 973  
 Detailing/Protectant Sprays/Kits  
   Hog Wash ..... 954-955  
   Liquid Performance ..... 957  
   Luster Lace ..... 960  
   Original Bike Spirits ..... 963  
   Pig Spit ..... 962  
   S100 ..... 965-966  
   Star Brite ..... 976  
 Deutsch Wire Connectors & Kits ..... 513-514  
 Diagnostic Scan Tools ..... 540-543

WINDSHIELDS / FAIRINGS  
 AUDIO / COMMUNICATION  
 SEATS / LUGGAGE  
 BARS / MIRRORS / CONTROLS  
 EXHAUST  
 AIR / FUEL SYSTEMS  
 ENGINE  
 TRANSMISSION / DRIVELINE  
 GASKETS / SEALS  
 ELECTRICAL  
 LIGHTING  
 CABLES  
 BRAKES  
 OIL FILTERS  
 SUSPENSION  
 BODY  
 WHEELS  
 TIRES / TIRE ACC.  
 BIKE ACC.  
 VICTORY / INDIAN  
 COVERS / LOCKS / TIEDOWNS  
 CHEMICALS  
 TOOLS  
 HELMETS  
 HELMET ACC.  
 EYEWEAR  
 APPAREL / RIDER ACC.  
 PROMOTIONAL  
 REFERENCE  
**INDEX**

D (continued...)

Diagnostic Systems ..... 990-993

**D.I.D**

Chains ..... 444-445

Chain Tool ..... 445

Chain Tools ..... 1040

Die Sets ..... 1005

Disk Locks & Alarms ..... 896-904

**DOBECK PERFORMANCE**

Fuel Management Systems ..... 871-873

TFI Electronic Jet Kit ..... 326

Wiring Connector Kits ..... 512

**DOWCO**

Covers ..... 893-895

Luggage ..... 116-118

Promotional Items/Displays ..... 1294

Rain Gear ..... 1223

**DRAGON**

Promotional Items/Displays ..... 1294

Sunglasses ..... 1172-1180

**DRAGONFLY Windshields** ..... 26

Drain Pans ..... 1022

**DRAYKO**

Promotional Items/Displays ..... 1294

Riding Jeans ..... 1220-1222

Drive Belts & Pulleys ..... 438-439

Drive Cams ..... 378

Dryers, Motorcycle ..... 1023

**DYNATEK**

Fuel Management Systems ..... 870

Fuel Mixture Management Kit ..... 329

Ignition & Fuel Modules ..... 328

Ignition Kits ..... 545-547

**DYNOJET**

Jet Kits ..... 335

Tuner Kits ..... 330-331

E

Ear plugs ..... 1290

Easy Outs ..... 1005

**EBC**

Brake Pads ..... 878-879

Brake Pads & Shoes ..... 673-674

Carburetor Jets ..... 336

Promotional Items/Displays ..... 1294

Rotors ..... 668

EFI Components ..... 522

EFI Fuel Filters ..... 347

EFI Tuners ..... 324-332

EFI Tuning System ..... 544

**EK CHAINS**

Chains ..... 446-449

**EKLIPES**

Jump Start Kits ..... 582

Power Ports ..... 842-843

**ELECTRICAL** ..... 498-582

4-Speed Solenoids ..... 538

Alternator Kits ..... 528

Batteries ..... 560-568

Battery Cables ..... 569

Battery Chargers ..... 571-579

Battery Hardware ..... 570

Battery Tester ..... 571, 579

Circuit Breakers ..... 517

Coils ..... 550-552

Diagnostic Scan Tools ..... 540-543

EFI Sensors ..... 522

EFI Tuning System ..... 544

Electric Charging System ..... 526

E (continued...)

**ELECTRICAL** ..... 498-582

Fuses ..... 518-519

Gauge Mounts ..... 508

Generator Brushes ..... 531

Generator Overhaul Kits ..... 531

Generators ..... 532

Horns, Covers & Brackets ..... 511

Ignition Kits ..... 545-549

Indicator Lights ..... 510

Jackshafts ..... 536-537

Jumper Cables ..... 579-580

Points & Condensers ..... 553

Regulators ..... 529-530

Relocation Brackets ..... 509-510

Spark Plugs ..... 558-559

Spark Plug Wires ..... 554-557

Spark Plug Wrenches ..... 557

Speedometer/Tachometer Gauges ..... 498-506

Starters, Parts & Kits ..... 533-538

Stators ..... 527-529

Switches ..... 519-525

Voltage Regulators ..... 531

Wire Spools ..... 517

Wiring Connectors ..... 512-514

Wiring Extensions ..... 515-516

Electrical Connectors ..... 1067

Electrical Tape ..... 1068

Electrical Tape, Liquid

Permatex ..... 988

Star Brite ..... 977

Electric Lifts ..... 1074

Electric Testers ..... 1062

Electronics Box ..... 762

**EMD**

Air Cleaners ..... 308

Cam Covers ..... 387

Electric Kicker Covers ..... 426

Fork Covers ..... 715

Headlight Shells ..... 589

Primary Covers ..... 420

Rocker Covers ..... 354

Sprocket Covers ..... 387

Transmission Covers & Cases ..... 425

**EMGO**

Air Filters ..... 323

Eyewear ..... 1183

Floorboards ..... 251

Handlebars ..... 175

Jumper Cables ..... 580

Lever ..... 217

Oil Filters ..... 690, 882

Slip-On Mufflers ..... 295

**ENERGY ONE**

Clutch Kits & Parts ..... 407-409

**ENERGY SUSPENSION**

Poly Cush Drive ..... 438

Riser Bushings ..... 184

**ENGINE** ..... 354-404

Cam Chain Accessories ..... 381

Cam Covers ..... 386-388

Camshafts, Install Kits, Parts ..... 376-381

Colony Hardware ..... 374-375, 385

Crankcase Venting Systems ..... 401

Cylinder Dowels ..... 392

Cylinders ..... 366-367

Cylinder Studs ..... 394-395

Drive Cams ..... 378

Exhaust Studs ..... 393

E (continued...)

**ENGINE** ..... 354-404

Headbolt Covers ..... 390-392

Headbolt Kits ..... 393-394

Ignition Covers ..... 390

Intake & Exhaust Valves ..... 368-369

Motor Mounts ..... 395

Oil Coolers ..... 402-404

Oil Dipstick Caps ..... 397

Oil Dipsticks, Spouts, Caps ..... 400-401

Oil Filter Housing ..... 399

Oiling System Kit ..... 382

Oil Pressure Gauges ..... 399-400

Oil Pressure Switches ..... 400

Oil Pump Plugs ..... 384

Oil Pumps ..... 383-384

Piston Rings ..... 364-365

Pistons ..... 358-365

Points Covers, Billet ..... 388

PSI Tester ..... 386

Push Rod Adjuster Lock Nuts ..... 373

Pushrod Conversion/Adaptor ..... 374

Pushrod Cover Kits ..... 375

Push Rods ..... 372-373

Pushrod Tube Holder ..... 374

Rocker Arm Bushings ..... 357

Rocker Arms ..... 357

Rocker Box Brass Oil Lines ..... 356

Rocker Covers ..... 355

Roller Lifters ..... 376-377

Rollpin Tool ..... 372

Skid Plates ..... 396

Sprocket Covers ..... 387

Stabilizer Links ..... 395

Swingarm Isolator Mount ..... 396

Transmission Dipsticks ..... 397

Twin Cam Motor Adapter Plate ..... 396

Valve Guides & Stem Seals ..... 370-371

Valve Seats ..... 368

Valve Springs KPM ..... 369

Valve Springs & Lifters ..... 380

Wrist Pin Bushing ..... 365

Engine Cleaner, Motul ..... 944

Epoxy Putty/Fillers, Quik Steel ... 979

**ERNST**

Funnels ..... 1021

**EXHAUST** ..... 254-304

Emgo Slip-Ons ..... 295

Exhaust Packing ..... 304

Exhaust Wrap ..... 300-303

Gaskets & Clamps ..... 299

Hardware ..... 298-299

Heat Shields ..... 297

Locking Ties ..... 303

O2 Sensor Adapters ..... 298

O2 Sensor Plug ..... 299

Paughco Pipe Sets ..... 292-293

Silicone Coating ..... 303

Systems, Fire Brand ..... 258-265

Systems, Freedom Performance ... 266-291

Systems, Rooke ..... 254-255

Systems, Sawicki Speed Shop ..... 256-257

TC Bros. Choppers Builder Kits ..... 294

Torque Valve ..... 298

Universal Mufflers ..... 295

Exhaust Studs ..... 393

Exhaust Systems

Freedom Performance Exhaust .... 864-868

Extensions, Wiring ..... 515-516

E (continued...)

**EYEWEAR** ..... 1150-1183  
 Bobster..... 1150-1169  
 Bomber..... 1181-1182  
 Dragon Sunglasses..... 1172-1180  
 Emgo..... 1183  
 HMK Sunglasses..... 1170  
 Scott Sunglasses ..... 1170-1171  
 Zan Headgear ..... 1168-1169

F

Fairing Doors  
 Hard Bagger..... 846  
 Fairing Vent Trim & Screen ..... 847  
**FAST ORANGE**  
 Hand Cleaners ..... 989  
 Feeler Gauges..... 1005  
 Fender Lights..... 595-596  
 Fenders & Hardware..... 722-732  
 Fender Strut Marker Lights..... 602  
 Fender Tip Lights..... 600  
 Fenix Watches ..... 825-826  
**FEULING**  
 Cam Covers ..... 386  
 Cam & Pinion Bolts ..... 381  
 Camshafts, install Kits, Parts..... 376  
 Crankshaft Tool..... 381  
 Cylinder Stud & Head Bolt Kits..... 394-395  
 Cylinder Stud Kit..... 392  
 Exhaust Stud Kit..... 393  
 Lifters ..... 376  
 Oiling System Kit..... 382  
 Oil Pumps..... 383  
 PSI Tester..... 374  
 Push Rods..... 372  
 Pushrod Tube Holder..... 374  
 Rollpin Tool..... 372  
 Files ..... 1006  
**FIREBRAND**  
 Exhaust Systems ..... 258-265  
 Skid Plates ..... 773  
 Slip-ons ..... 353  
 Slip-on Exhaust ..... 264-265  
**FIRE POWER BY WPS**  
 12 Volt Relay ..... 520  
 Batteries ..... 564-565  
 Batteries, Victory ..... 875  
 Battery Chargers..... 571  
 Battery Hardware Kit..... 570  
 Cargo Nets..... 917  
 Chains ..... 450-451  
 Chemicals & Lubes ..... 980  
 Chocks ..... 914  
 Digital Battery Tester ..... 571  
 Electrical Tape..... 1068  
 Electric Testers ..... 1062  
 Fork/ Dust Seals..... 717  
 Fuse Holder..... 519  
 Glaze Breaker ..... 1052  
 Grip Cutter..... 1027  
 Heat Shrink Tubing..... 1062  
 Horns..... 511  
 Ignition Testers ..... 1062  
 Impact Driver & Bits..... 1016  
 Metallic Gloves..... 1071  
 Rivets ..... 1068  
 Safety Wire & Pliers..... 1027  
 Shop Stools..... 1064  
 Spark Plug Wrenches..... 557  
 Starter Motors ..... 876

F (continued...)

**FIRE POWER BY WPS**  
 Tire Irons ..... 1027  
 Valve Spring Tools..... 1054  
 Valve Tools ..... 1032  
**FITCH**  
 Chemicals & Lubes ..... 975  
 Fittings, Cable..... 658-660  
**FIXT**  
 T-Handles/Racks ..... 1020  
 Flag Mounts..... 850-851  
**FLASH 2 PASS**  
 Garage Door/Gate Opener..... 821  
 Garage Door Opener..... 821  
 Flashers/Resistors, Turn Signal... 636  
**FLEXPOWER**  
 Antennas ..... 55  
**FLO MOTOR SPORTS**  
 Footpegs ..... 236-237  
 Floorboards ..... 247-251  
 Floor Mats..... 1008  
**FLY RACING**  
 Exhaust Packing..... 304  
 Helmet Bag ..... 1149  
 Promotional Items/Displays..... 1295  
**FLY STREET**  
 Armor kit..... 1201  
 Base Layers ..... 1231  
 Boots ..... 1264  
 Display..... 1295  
 Gloves, Riding..... 1243-1250  
 Helmet Replacement Parts ..... 1128-1134  
 Helmets ..... 1084-1091  
 Mens Riding Jackets ..... 1187-1190  
 Mens Riding Jackets ..... 1202-1207  
 Mens Riding Pants ..... 1211-1214  
 Safety Vests..... 1230  
 Shoes, Riding..... 1265-1266  
 Street Gear Size Chart..... 1310  
 Womens Riding Jackets ..... 1208-1210  
 Womens Riding Pants..... 1212  
**FOGCITY**  
 Visor Inserts ..... 1147  
 Fogging Oil, Sta-Bil..... 975  
 Footpegs/Shiftpegs..... 227-237  
**FORBIDDEN MOTORCYCLES**  
 Handlebar Risers..... 157-158  
 Moto Bars..... 157  
 Fork Align Tool ..... 1040  
 Fork Boot Caps..... 715  
 Fork Boots/ Dust Boots..... 716  
 Fork Covers ..... 714-715  
 Fork/ Dust Seals ..... 717  
 Fork Oil  
 Bel-Ray..... 922  
 HardDrive ..... 919  
 Klotz ..... 929  
 Lucas Oil ..... 933  
 Maxima..... 936-937  
 Motul ..... 943  
 PJ1 ..... 946  
 Torco..... 952  
 Fork Spring Kits ..... 710  
 Fork Stem Cap ..... 719  
 Fork Stem Lock Washers..... 718  
 Fork Stem Nut ..... 718  
 Fork Stop Kits ..... 709  
 Fork Tube Bolt / Plug ..... 719  
 Fork Tube Rebuild Kits..... 715

F (continued...)

Fork Tubes ..... 714  
 Fork Valve Emulators..... 712  
**FOX**  
 Shocks..... 697-699  
**FRAM**  
 Oil Filters ..... 690, 881  
 Frames, Rigid ..... 760  
**FREEDOM PERFORMANCE**  
 Exhaust Systems ..... 266-291, 864-868  
 Exhaust tips..... 291  
**FROGG TOGGS**  
 Rain Gear..... 1226-1230  
 Fuel Filters..... 353  
 Fuel Hose Protector..... 352  
 Fuel Injection Cleaners..... 333  
 Fuel Injection Lines..... 345-346  
 Fuel Injectors ..... 332-333  
 Fuel Line..... 350, 693  
 Fuel Line Clamping Pliers..... 1061  
 Fuel Management Systems.. 870-872  
 Fuel/Oil Treatments  
 Bel-Ray..... 925  
 Blendzall..... 927  
 Fitch ..... 975  
 Hog Wash..... 956  
 K100 ..... 931  
 Klotz ..... 930  
 Lucas Oil ..... 933  
 Maxima..... 939, 981  
 Original Bike Spirits..... 963  
 PJ1 ..... 947  
 Sta-Bil..... 975  
 Sta-Dri ..... 981  
 Star Brite ..... 981  
 Torco..... 952  
 Fuel Pre-Filters ..... 1021  
 Fuel Pressure Gauge ..... 344  
 Fuel Pumps ..... 348  
 Fuel Sharing System ..... 343  
 Fuel Sling w/Bottle..... 849  
 Fuel Tank Cleaner/Liner, Kreem .. 983  
 Fuel Tank Console Doors ..... 743  
 Fuel Tank Repair Kit, Permatex ... 987  
**FUEL-TOOL**  
 Carburetor Check Valve Access..... 344  
 Fuel Pressure Gauge ..... 344  
 Fuel Sharing System..... 343  
 Funnels..... 1021-1022  
 Fuses..... 518-519  
**FUSION**  
 Light Systems..... 629-631  
**G**  
 Garage Door/Gate Opener ..... 821  
 Garage Door Opener ..... 821  
**GARDNER-WESTCOTT COMPANY**  
 Belt Pulley Bolts ..... 438  
 Builders Kits ..... 856  
 Exhaust Studs ..... 393  
 Points Cover Sets..... 389  
 Riser Bolts..... 180, 182  
 Rocker Box Cover Sets ..... 355  
 Rotor Bolts ..... 669  
 Transmission Side Cover Set ..... 335, 425  
**GARMIN**  
 Camera..... 827  
 Fenix 3 Watch..... 825  
 GPS..... 822-824  
 Promotional Items/Displays..... 1296

WINDSHIELDS / FAIRINGS  
 AUDIO / COMMUNICATION  
 SEATS / LUGGAGE  
 BARS / MIRRORS / CONTROLS  
 EXHAUST  
 AIR / FUEL SYSTEMS  
 ENGINE  
 TRANSMISSION / DRIVELINE  
 GASKETS / SEALS  
 ELECTRICAL  
 LIGHTING  
 CABLES  
 BRAKES  
 OIL FILTERS  
 SUSPENSION  
 BODY  
 WHEELS  
 TIRES / TIRE ACC.  
 BIKE ACC.  
 VICTORY / INDIAN  
 COVERS / LOCKS / TIEDOWNS  
 CHEMICALS  
 TOOLS  
 HELMETS  
 HELMET ACC.  
 EYEWEAR  
 APPAREL / RIDER ACC.  
 PROMOTIONAL  
 REFERENCE  
**INDEX**

G (continued...)

Gas Caps..... 741-744

**GASGACINCH**

Chemicals & Lubes..... 979

**Gasket Materials/Sealants**

Gasgacinch..... 979

Permatex..... 985

Three Bond..... 984

**Gaskets**..... 874-875

**GASKETS/SEALS**..... 452-497

Cometic..... 452-468

Gasket Boards..... 471, 496

HardDrive..... 497

James Gaskets..... 472-496

Gas Tank Cover..... 740

Gas Tank Garnish Cover..... 774

Gas Tank Lift Kit..... 740

Gas Tanks..... 734-737

Gauge Mounts..... 508

**GEAR BRAKE**

Tail Lights..... 628

Vector Laser Brake Light..... 628

**Gear Oil**

Bel-Ray..... 922

Castrol..... 928

HardDrive..... 919

Lucas Oil..... 932

Maxima..... 936-937

Motul..... 941, 943

Red Line..... 949

Torco..... 952

**Gear Tools**..... 1003

Generator Brushes..... 531

Generator Overhaul Kits..... 531

Generators..... 532

Generators - Indian..... 876

**GENUINE INNOVATIONS**

Repair & Inflation Kits..... 1035

Glaze Breakers..... 1052

**GLOVE BOY**

Gloves - Disposable..... 1071

Glove Liners..... 1071

Gloves - Disposable..... 1071

Gloves, Latex/Nitrile

Permatex..... 989

Gloves - Mechanix Wear... 1072-1074

Gloves - Metallic..... 1071

Gloves, Riding..... 1235-1253

Gloves - Rubber..... 1071

**GMAX**

Helmet Brake Light Kit..... 1146

Helmet Replacement Parts..... 1134-1142

Helmets..... 1092-1110

Promotional Items/Displays..... 1296

**GO CRUISE**

Cruise Controller..... 206

**GOODRIDGE**

ABS Tube Adapters..... 679

Brake Light Banjos..... 679

Brakeline Fittings..... 681-682

Brakeline Kits & Parts..... 676, 683

Brakelines..... 680

Brake Tees..... 683

Fuel Injection Lines..... 345

Hydraulic Clutch Lines..... 657

Speedbleeders..... 679

**GORILLA**

Cycle Alarm..... 904

GPS Devices..... 822-824

G (continued...)

GPS Mounting Kits..... 832-840

**Grease**

Bel-Ray..... 924

Hog Wash..... 955

Lucas Oil..... 934

Maxima..... 940

Permatex..... 987

Star Brite..... 978

Torco..... 953

**Grease Guns**..... 978

**Grip Cutter**..... 1027

**Grips**..... 197-205

Avon..... 861-863

Brass Balls Cycles..... 861

Grip Warmer..... 206

Gun Oil..... 934

H

**Hammer Hanger**..... 849

**Hammers**..... 1003

**Hand Controls**..... 214-218

**Hand Deflectors**..... 219-220

**Handlebars**..... 149-174

**Handlebar Speakers**..... 50-54

**HANDY**

Air & Electric Lifts..... 1074-1077

Tear Down Table..... 1063

**HARD BAGGER**

Fairing Doors..... 846

**HARDDRIVE**

Air Cleaner Adapter..... 315

Air Cleaner Assemblies..... 305

Air Cleaner Brackets..... 314

Air Cleaners..... 311-312

Axels..... 790

Axle Adjuster blocks, plates..... 790

Axle Covers..... 757

Axle Spacers..... 792

Banjo Bolts..... 685

Batteries..... 560, 565

Battery Hardware..... 570

Batwing Fairing..... 28

Billet Oil Filters..... 691

Bolt Covers..... 757

Brake Arms..... 239

Brakeline Clamps..... 685

Brakeline Kits..... 684-685

Brake Tees..... 683

Breather Hoses..... 342

Bullet Lights..... 610

Caliper Parts..... 676

Calipers..... 670

Cam Chain Accessories..... 381

Carburetor Top Cover..... 335

Check Valve Assemblies..... 346

Chemicals & Lubes..... 918-919

Clock..... 850

Clutch Cable Bracket..... 659

Clutch Kits & Parts..... 410-412

Clutch Release Shaft..... 428

Connecting Rod Assy..... 367

Crankcase Breathers..... 401

Crankcase Venting Systems..... 401

Cylinders..... 366-367

Derby Covers..... 423

Drive Belts & Pulleys..... 438-439

EFI Fuel Filters..... 347

EFI Fuel Lines..... 346

H (continued...)

**HARDDRIVE**

Engine Guards..... 775

Exhaust Hardware..... 298-299

Fender Lights..... 595-596

Fenders & Hardware..... 722-727, 734

Fender Tip Lights..... 600

Flag Mounts..... 850

Floorboards & Access..... 251-252

FLTR Gauge Housing..... 28

Footpeg Mounts..... 238

Footpegs/Shiftpegs..... 227-229, 234

Fork Boot Caps..... 715

Fork Boots/ Dust Boots..... 716

Fork Covers..... 714

Fork Stem Lock Washers..... 718

Fork Tube Rebuild Kits..... 715

Fork Tubes..... 714

Forward/Mid Controls..... 221

Fuel Filters..... 353

Fuel Tank Console Doors..... 743

Fuel Tank Fitting Cover..... 345

Gas Caps..... 741-742

Gaskets..... 497

Gas Tanks & Mounts..... 734-738

Gauge Mounts..... 508

Generators..... 532

Generators - Indian..... 876

Grips..... 197-199

Hand Controls..... 212-215

Handlebars..... 149-156

Hardware, Body..... 768

Headbolt Covers..... 391

Headlights..... 590

Heat Shields..... 297

Horns Covers & Brackets..... 511

Idle Mixture Screws..... 339

Ignition Switches..... 521

Indicator Lights..... 510

Inspection Covers..... 417

Intake Clamps..... 341

Intake Manifold Gaskets..... 342

Kickstand & Parts..... 768-770

LED Halo Turn Signals..... 608

Lever..... 215-217

License Plate Accessories..... 852

License Plate Frames / Lights..... 598, 609

License Plate Lights..... 599

Lifter Blocks..... 377

Light Bar..... 604

Lighting Mounts/ Brackets/ Clamps..... 587, 604

Lowering Kits..... 706

Luggage Racks..... 145-147

Manifold Mounting Flange & Cover..... 341

Master Cylinder Covers..... 208, 688

Master Cylinder Rebuild Kits..... 687

Master Cylinders..... 686

Mirror Extensions..... 196

Mirror Mounts..... 196

Mirrors..... 187-195

Motor Mounts..... 395

Motor Sprocket Keys..... 413

Oil Dipsticks, Spouts, Caps..... 398

Oil Filter Housing..... 399

Oil Filters..... 690

Oil & Fuel Lines..... 693

Oil Pressure Gauges..... 399

Oil Pumps..... 384

Passenger Grab Rail..... 144

H (continued...)

**HARDDRIVE**

Passing Lamp Brackets..... 614  
 Petcocks..... 349  
 Piston Pin Puller..... 1051  
 Pistons..... 364  
 Pressure Regulators..... 347  
 Primary Chains & Tensioners..... 415-416  
 Promotional Items/Displays..... 1297-1298  
 Pulley Lock Plate..... 440  
 Rear Seat Mounts..... 105  
 Regulators..... 530  
 Rims, Victory..... 887  
 Risers..... 176, 181  
 Rocker Arms..... 357  
 Rocker Covers..... 355  
 Rotors..... 661-665  
 Rubber Mounts & Wellnets..... 768  
 Saddlebag Brackets..... 747  
 Saddlebag Latch Kit..... 749  
 Saddlebag Lock Kit..... 135  
 Saddlebags, ABS plastic..... 746  
 Saddlebag Speaker Lids..... 746  
 Saddlebag Support Brackets..... 136  
 Sealed Beam Headlights..... 614  
 Seats..... 90-103  
 Seat Screws..... 105  
 Shift Forks..... 428  
 Shift Rod Ends..... 436  
 Shocks..... 705-707  
 Sissy Bars..... 140-141  
 Spark Plug Caps & Wrench..... 557  
 Speedometer Drives..... 794  
 Speedometer/Tachometer Gauges 506-507  
 Sprocket & Pulley Spacers..... 793  
 Sprockets..... 413-414  
 Stabilizer Links..... 395  
 Starter Clutches..... 535  
 Starter Jackshafts..... 537  
 Starter Ring Gear & Levers..... 538  
 Starters..... 533  
 Starter Shaft Bushings..... 417  
 Steering Dampers..... 720  
 Support Brackets..... 48  
 Swingarm Bushing..... 758  
 Swingarm Isolator Mount..... 396, 758  
 Tail Lights..... 594, 596  
 Throttle Clamps..... 195  
 Throttle Slide Membrane..... 342  
 Tour Pak Lenses..... 600  
 Transmission Covers..... 419, 424  
 Transmission Shift Levers..... 437  
 Transmission Sprockets..... 440  
 Turn Signal Clamps..... 611  
 Turn Signals..... 609  
 Twin Cam Motor Adapter Plate..... 396  
 Universal Mufflers..... 295  
 Valve Stems & Caps..... 812  
 Wheel Bearings & Seals..... 795  
 Wheels..... 780-790  
 Wheel Spacers & Adapters..... 794-795  
 Wheels, Victory..... 887  
 Wire Retainer..... 527  
 Wiring Extension Kits..... 185

**HARDLINE**

Rim Strip Tape..... 1024  
 Rollstand..... 1024  
 Hardware Kits..... 856

H (continued...)

**HASTINGS**

Piston Rings..... 364

**HAYDEN**

Crankcase Venting Systems..... 401  
 Primary Chain Tensioners..... 415  
 Headbolt Kits..... 393-394  
 Headlight Cowls..... 29-31  
 Headlight LED Bulb Upgrade Kits 618  
 Headlights..... 583-590, 615  
 Headsets & Comm. Systems..... 53-55

**HEAROS**

Ear plugs..... 1290

**HEAT DEMON**

Grip Warmer..... 206  
 Heat Shields..... 297  
 Heat Shrink Tubing..... 1062  
 Heat Sleeve..... 1071  
 Heel Shift Eliminators..... 242

**HELIX**

Cable Ties..... 1066  
 Fuel Hose Protector..... 352  
 Fuel/Oil Line..... 693  
 Hose Clamps..... 352  
 Jet Cleaning Tool..... 1050  
 Muffler Packing..... 304  
 Wire Safety Tools..... 1027

**HELMET ACCESSORIES..... 1128-1149**

Anti-Fog Cleaners & Clothes..... 1148  
 FLY Replacement Parts..... 1128-1134  
 GMAX Replacement Parts..... 1134-1142  
 Helmet Bags..... 1149  
 Helmet Brake Light Kit/ Lights..... 1146  
 Helmet Clasps..... 1149  
 Helmet Fresh..... 1148  
 Helmet Locks..... 1146  
 Scorpion Replacement Parts..... 1142-1145  
 Sena Replacement Parts..... 1145  
 Snap on Shields..... 1147  
 Visor Inserts..... 1147  
 Helmet Cleaner, Motul..... 945

**HELMET FRESH**

Helmet Cleaner..... 1148

**HELMETS..... 1084-1127**

FLY..... 1084-1091  
 GMAX..... 1092-1110  
 Scorpion..... 1111-1122  
 Sena..... 1125  
 Hex Key Set..... 1000  
 Hex Sockets..... 996  
 Hex/Torx Wrenches..... 1036

**HIFLOFILTRO**

Oil Filters..... 692, 881

**HIGH ROLLER**

Tiedowns..... 909

**HIGHWAY 21**

Boots..... 1261-1262  
 Casual..... 1200  
 Gloves..... 1235-1242  
 Glove Size Chart..... 1311  
 Leather Chaps..... 1197  
 Leather Vests..... 1192-1195  
 Mens Leather Riding Jackets..... 1184-1188  
 Mens Riding Jeans..... 1198  
 Promotional Items/Displays..... 1295, 1299  
 Riding Hoodies..... 1190  
 Womens Riding Jackets..... 1189  
 Womens Riding Jeans..... 1199

H (continued...)

**HMK**

Sunglasses..... 1170

**HOG WASH**

Chemicals & Lubes..... 954-956  
 Horns, Covers & Brackets..... 511  
 Hose Clamp Kits..... 1061  
 Hose Clamps..... 351-352  
 Hose Clips..... 352

**HOT CAMS**

Cam Installation Kit..... 1053  
 Hybrid LED Tail Lights..... 593  
 Hydraulic Clutch Actuator Covers 425

**HYDRON**

Snap on Shields..... 1147

**I**

Ignition Covers..... 390, 753  
 Ignition Kits..... 545-549  
 Ignition Point Tool..... 1058  
 Ignition Switches..... 521  
 Ignition Testers..... 1062  
 Impact Driver & Bits..... 1016  
 Impact Sockets..... 997  
 Impact Wrenches..... 1008  
 Indicator Lights..... 510  
 Inner Primary Service Kit..... 1057  
 Inspection Covers..... 417-418  
 Inspection Mirror..... 1010  
 Inspection Plates..... 855  
 Intake Clamps..... 341  
 Intake & Exhaust Valves..... 368-369  
 Intake Manifold Gaskets..... 342  
 Intake Systems..... 316-321

**IRC**  
 Tubes..... 810

**ISC RACER TAPE**  
 Heat Tape..... 1068  
 Racer Tape..... 1069-1070  
 Tape - Barricade..... 1069  
 Tape - Non-Skid..... 1069  
 Tape - Reflective..... 1069

**J**

Jackets/Vest, Riding..... 1184-1200  
 Jackshafts..... 536  
 Jacks, Shop..... 1080-1081

**JAGG**  
 Oil Coolers..... 402-404  
 Oil gaskets / Hoses..... 404

**JAMES GASKETS**..... 472-496  
 Carburetor Rebuild Kits..... 340  
 Seals & Gaskets..... 874

Jet Cleaning Tool..... 1050  
 Jet Kits..... 335  
 Jets..... 336-337

**J&M AUDIO**  
 Amp Kits..... 37-40  
 Antennas..... 55-56  
 Headsets & Communication Systems 53-55  
 Speaker & Amp Kits..... 35-36  
 Speaker Kits..... 41-43  
 Wiring Harnesses..... 44

**JT SPROCKETS**  
 Sprockets..... 442

Jumper Cables..... 579, 580  
 Jump Start Packs..... 580-582

**K**

**K100**  
 Chemicals & Lubes ..... 931

**KB PISTONS**  
 Pistons ..... 358-361

**Key Keeper** ..... 849

**KIBBLEWHITE**  
 Clutch Springs ..... 412  
 Cylinder Dowels ..... 392  
 Cylinder Studs ..... 392  
 Exhaust Spigot ..... 298  
 Intake & Exhaust Valves ..... 368-369  
 Kicker Shaft Bushings ..... 428  
 M8 Valve Keepers ..... 369  
 Rocker Arm Bushings ..... 357  
 Valve Guides & Stem Seals ..... 370-371  
 Wheel Weights ..... 814  
 Wrist Pin Bushings ..... 365

**K&L**  
 Air Lifts ..... 1077  
 Fork Tools ..... 1045  
 Shop Lifts/Jacks ..... 1080-1081  
 Tire Bead Holder ..... 1028  
 Tire Bead Starter ..... 1028  
 Tire Changer Machine ..... 1025  
 Utility Trailer ..... 911  
 Valve Stem Pullers ..... 1028  
 Wheel Balancer Machine ..... 1025  
 Wheel Truing Stands ..... 1030  
 Wheel Weights ..... 813

**KLEER VU**  
 Anti-Fog Cleaner ..... 1148

**KLOTZ**  
 Chemicals & Lubes ..... 929-931

**K&N**  
 Air Filter Cleaner/Oil/Grease ..... 322, 401  
 Air Filters ..... 321, 873  
 Air Intake Systems ..... 317-320  
 Chemicals & Lubes ..... 983  
 Crankcase Vent Air Filters ..... 322, 401  
 Oil Filters ..... 693, 882  
 Promotional Items/Displays ..... 1300

**KOSO**  
 Exhaust Hardware ..... 299  
 Speedometer/Tachometer Gauges ..... 498-505

**KREEM**  
 Chemicals & Lubes ..... 983

**KRYPTONITE**  
 Locks ..... 896-899  
 Promotional Items/Displays ..... 1300

**K&S**  
 Flashers/Resistors, Turn Signal ..... 636  
 License Plate Lights ..... 636  
 Tail Lights ..... 594-608

**L**

**Leak Detector** ..... 343  
**Leak Down Testers** ..... 1053  
**Leather Chaps** ..... 1197

**LEATHER THERAPY**  
 Leather & Vinyl Cleaners/Conditioners.. 974  
 Leather Vests ..... 1192-1195  
 Leather & Vinyl Cleaners/Conditioners  
 944, 956, 962, 974

**LED Bulbs** ..... 617-618  
**LED Halo Turn Signals** ..... 608  
**L.E.D. Headlights** ..... 583-585  
**LED Passing Lamp Bulb** ..... 875  
**Levers** ..... 217-220

**L (continued...)**

**License Plate Accessories**... 852-854  
**License Plate Frames / Lights** ..... 609  
**Lifters**..... 376-377, 380

**LIGHTING** ..... 583-636  
 Bagger Lights ..... 601  
 Bullet Lights ..... 610  
 Fender Lights ..... 595-596  
 Fender Strut Marker Lights ..... 602  
 Fender Tip Lights ..... 600  
 Flashers/Resistors, Turn Signal ..... 636  
 Headlights ..... 583-590, 615  
 Headlight Shells ..... 589  
 H.I.D. Light Kits ..... 616  
 LED Bulbs ..... 619  
 LED Halo Turn Signals ..... 608  
 LED Retro-Fit Kit ..... 611  
 License Plate Frames / Lights ..... 598-599, 609  
 License Plate Lights ..... 599, 636  
 Light Kits ..... 632-636  
 Light Modules ..... 624-627, 635  
 Light Systems ..... 629-631  
 Mounts/ Brackets/ Clamps ... 587, 604, 614  
 Passing Lamp Brackets ..... 614  
 Passing Lamps ..... 585  
 Sealed Beam Headlights ..... 614  
 Signal Block Off Plates ..... 603  
 Sissy Bar License Plate Mount ..... 599  
 Spot Lamps ..... 586  
 Spotlight Bars ..... 613  
 Suspended Headlight Bracket ..... 587  
 Tail Lights ..... 592  
 Tour Pak Lenses ..... 600  
 Turn Signal Bars ..... 602-603  
 Turn Signal Brackets ..... 612  
 Turn Signal Eliminators ..... 602  
 Turn Signals ..... 603, 607-608, 611  
 Vector Laser Brake Light ..... 628  
 Light Modules ..... 624-627  
**Lights, Shop**..... 1065  
**Light Systems** ..... 629-631

**LINDBY CUSTOM INC.**  
 Clamp-on Pegs ..... 779, 886  
 Engine Guards ..... 776, 886  
**Liquid Dispensers** ..... 1012

**LIQUID PERFORMANCE**  
 Chemicals & Lubes ..... , 957-959

**LITTLE GIANT**  
 Funnels ..... 1021  
**Locking Ties**..... 303  
**Locks** ..... 896-904

**LOCKSTRAPS** ..... 905  
**Lubricants, All Purpose**  
 Bel-Ray ..... 923  
 Blendzall ..... 927  
 Maxima ..... 938  
 PJ1 ..... 947  
 Star Brite ..... 976  
 Tri-Flow ..... 980  
 WD-40 ..... 980

**LUCAS OIL**  
 Chemicals & Lubes ..... 932-937

**LUCAS OILS**  
 Promotional Items/Displays ..... 1300  
**Luggage**..... 116-122, 138-139  
**Luggage Racks**..... 145-147

**LUNATI**  
 Camshafts ..... 379-380  
 Valve Springs & Lifters ..... 380

**L (continued...)**

**LUSTER LACE**  
 Chemicals & Lubes ..... 960-961

**LYNDALL BRAKES**  
 Brake Pads ..... 671  
 Rotors ..... 663-667, 786  
 Sprockets & Pulleys ..... 787  
 Wheels ..... 785

**M**

**M8 Valve Keepers** ..... 369  
**Magnetic Finger Glove** ..... 1060  
**Magnetic Parts Dish** ..... 1064  
**Magnetic Retriever** ..... 1010  
**Maindrive Service Kit** ..... 1057  
**Main Shaft Nut** ..... 434  
**Manifold Cover** ..... 335  
**Manifold Mounting Flange** ..... 341

**MASTER**  
 Catalog Racks ..... 1083  
 Locks ..... 900-901  
**Master Cylinder Covers** ..... 207-209, 686-689  
**Master Cylinder Mounting Kit** ..... 686  
**Master Cylinder Pliers** ..... 1043  
**Master Cylinder Rebuild Kits** ..... 687

**MASTER LOCK**  
 Bungee Cords ..... 917

**MAXIMA**  
 Chemicals & Lubes ..... 935-941  
 Promotional Items/Displays ..... 1301

**MC BAGGERS**  
 ABS Wheel Bearings ..... 708  
 Rake Kits ..... 708

**MECHANICS**  
 Chemicals & Lubes ..... 979

**MECHANIX WEAR**  
 Apron ..... 1070  
 Gloves ..... 1072-1073  
 Heat Sleeve ..... 1071  
 Promotional Items/Displays ..... 1301  
**Metal Cleaner/Polish**  
 Hog Wash ..... 955  
 Liquid Performance ..... 959  
 Motul ..... 945  
 Wizards Products ..... 970, 972-973  
 Workshop Hero ..... 982

**MICHELIN**  
 Promotional Items/Displays ..... 1301  
 Tires ..... 797-799  
 Tubes ..... 809

**MIDWEST CAN**  
 Drain Pans ..... 1022  
 Funnels ..... 1022

**MIKUNI**  
 Carburetor Jets ..... 336  
 Carburetors ..... 334  
 Carburetor Tools ..... 1051  
 Product Catalog ..... 343  
**Mirror Mounts** ..... 196  
**Mirrors** ..... 187-195

**MISSING LINK**  
 Cooling Sleeves ..... 1289

**MOROSO**  
 Spark Plug Wires ..... 556

**MOTION PRO**  
 Auxiliary Fuel Tank ..... 1051  
 Bead Breaker ..... 1029  
 Belt Tension Gauge ..... 1059

M (continued...)

MOTION PRO

Bleeders..... 1043  
 Brake Caliper Tool..... 1043  
 Cable, Armor Coat..... 644-652  
 Cable, Blackout..... 653-656  
 Cable, OEM Black Vinyl..... 637-643  
 Cable Fittings, Wire & Clamps..... 658-660  
 Chain Tools..... 1036-1039  
 Chemicals & Lubes..... 980  
 Clamps..... 351  
 Clutch Adjuster..... 1056  
 Clutch Holding Tool..... 1055  
 Clutch Spring Tool..... 1059  
 Compression Tester..... 1053  
 Fork Align Tool..... 1040  
 Fork Cap Nut Socket..... 1046  
 Fork Oil Level Gauge..... 1047  
 Fork Seal Bullet Set..... 1046  
 Fork Spring Tool..... 1047  
 Fuel Injection Cleaners..... 333  
 Fuel Line..... 350  
 Fuel Line Clamping Pliers..... 1061  
 Funnel..... 1022  
 Helmet Locks..... 1146  
 Hose Clamp Kits..... 1061  
 Leak Down Tester..... 1053  
 License Plate Accessories..... 854  
 Magnetic Finger Glove..... 1060  
 Magnetic Parts Dish..... 1064  
 Magnetic Pick Up Tool..... 1060  
 Master Cylinder Pliers..... 1043  
 O-Clips..... 1061  
 Oil Filter Magnet..... 1055  
 Oil Filter Strap Wrench..... 1055  
 Piston Pin Puller..... 1051  
 Piston Ring Installer..... 1051  
 Promotional Items/Displays..... 1302  
 Pushrod Tool..... 1056  
 Rim Protectors..... 1029  
 Rocker Box Wrench..... 1056  
 Shock Spring Installer..... 1050  
 Side Case Cover Puller..... 1056  
 Snap Ring Pliers..... 1055  
 Socket - Axle..... 1046  
 Sprocket Jammer..... 1038  
 Steering Stem Tool..... 1047  
 Strap Wrench..... 692  
 Tappet Tool..... 1056  
 T-Handles/Racks..... 1018-1019  
 Throttle Kits..... 211  
 Tire Changing Station..... 1024  
 Tire Irons..... 1026-1028  
 Tire Pressure Gauges..... 1032  
 Tool Kits..... 1015  
 Wheel Alignment Tool..... 1059  
 Wheel Bearing Remover..... 1045  
 Wheel Weights..... 813  
 Wire Extensions..... 515  
 Wrenches, Spoke..... 1031  
 Motorcycle Dryers..... 1023  
 Motorcycle Lifts..... 1074

**MOTOREX**  
 Promotional Items/Displays..... 1302

**Motor Mounts**  
 HardDrive..... 395  
 Paughco..... 396

**Motor Oil**  
 Bel-Ray..... 920-921

M (continued...)

Motor Oil

Blendzall..... 926-927  
 Castrol..... 928  
 HardDrive..... 918  
 Klotz..... 929  
 Lucas Oil..... 932  
 Maxima..... 935-937  
 Motul..... 941-942  
 PJ1..... 946  
 Red Line..... 949  
 Torco..... 951  
 Motor Sprockets & Keys..... 413

**MOTUL**  
 Chemicals & Lubes..... 941-945  
 Promotional Items/Displays..... 1302

**Mounts, Rear Seat..... 105**  
**Mounts, Seat Kits..... 109-111**  
**Muffler Clamps..... 293, 299**  
**Mufflers, Universal..... 295**  
**Multi-Meters..... 1007**

N

N.A.D.A.

Appraisal Guide..... 1082

NASH

Fuel Sling w/Bottle..... 849  
 Gas Caps..... 745  
 Hammer Hanger..... 849  
 Handlebars..... 166-168  
 Key Keeper..... 849  
 Luggage..... 138  
 Starter Button..... 533

NATIONAL CYCLE

Fender Tips & Speedo Cowls..... 754-755  
 FLYScreen Windshields..... 857  
 Hand Deflectors..... 219, 858  
 Heat Shields..... 20  
 Luggage Racks..... 859-860  
 Paladin Luggage Racks..... 859  
 Saddlebags..... 859, 123-124  
 Shield Wash and Water Repellent..... 20  
 Spotlight Bars..... 613  
 SwitchBlade Windshields..... 857  
 V-Stream Windscreens..... 857  
 Windshield Bag..... 20  
 Windshields/Fairings..... 4-20

NELSON-RIGG

Covers..... 889-891  
 Luggage..... 118-121  
 Promotional Items/Displays..... 1302  
 Rain Gear..... 1224-1225

NGK

Promotional Items/Displays..... 1303  
 Spark Plugs..... 558, 877  
 Spark Plug Wires..... 557

NOCO GENIUS

Battery Chargers..... 576-578  
 Battery Packs..... 581

NORMA

Hose Clamps..... 352

NOVELLO TRIBAL

Deutsch Builder Kits..... 514  
 Deutsch Connectors & Pins..... 513  
 Inspection Plates..... 855  
 Riser Extensions..... 183  
 Seat Screws..... 105  
 Shift Covers..... 242  
 Wire Spools..... 517  
 Wiring Extensions..... 186, 516

O

O2 Sensor Adapters..... 298  
 O2 Sensor Plug..... 299  
 O2 Sensors..... 332  
 OHM Meters..... 1007  
 Oil Coolers..... 402-404  
 Oil Dipsticks, Spouts, Caps .. 400-401  
 Oil Dispensers..... 1012  
 Oil / Dust Fork Seal Wiper Kits ... 885  
 Oil Filter Housing..... 399  
 Oil Filter Magnet..... 1055

**OIL FILTERS..... 690-694**

Emgo..... 690  
 Fram..... 690  
 HardDrive..... 690-691  
 HifloFiltro..... 692  
 K&N..... 693  
 Oil Filter Wrench, Strap..... 692  
 Oil & Fuel Lines..... 693  
 PC Racing..... 691  
 Oil Filter Strap Wrench..... 1055  
 Oiling System Kit..... 382  
 Oil Pressure Gauges..... 399-400  
 Oil Pressure Switches..... 400, 520  
 Oil Pump Plugs..... 384  
 Oil Pumps..... 383-384

**OLD-STF**

Brass Pushrod Clips..... 374  
 Rocker Box Brass Oil LInes..... 356  
 Mini ED Air Cleaner..... 312

**ORIGINAL BIKE SPIRITS**

Chemicals & Lubes..... 963

**OUTERWEARS**

Pre-Filters..... 1021  
 Oxygen Sensor Eliminator Kits... 332

P

Packing, Exhaust..... 304  
 Paints, Aerosol..... 948  
 Pants, Riding..... 1211-1214

**PARK TOOL USA**

Portable Workbench..... 1063  
 Saw Guide..... 1060  
 Shock Gauges..... 1049  
 Steering Race Remover/Press..... 1048  
 Vise Inserts..... 1049  
 Wheel Truing Stands..... 1029  
 Work Stand..... 1049  
 Passing Lamp Brackets..... 614

**PATHFINDER L.E.D.**

Headlight LED Bulb Upgrade Kits..... 618  
 Hybrid LED Tail Lights..... 593  
 LED Bulbs..... 619  
 LED Headlight Adapter Ring & Wiring  
 Harness..... 583  
 L.E.D. Headlights..... 583-585  
 LED Passing Lamp Bulb..... 875  
 Passing Lamps..... 585  
 Road Glide LED Headlight..... 585  
 Spot Lamps..... 586

**PATRIOT SUSPENSION**

Fork Spring Kits..... 710-711  
 Springer Springs..... 721

**PAUGHCO**

Air Cleaners..... 310  
 Brass Headlights..... 588  
 Brass Oil Tank Cap..... 398  
 Carb Covers..... 310  
 Engine Skid Plates..... 356

WINDSHIELDS / FAIRINGS  
 AUDIO / COMMUNICATION  
 SEATS / LUGGAGE  
 BARS / MIRRORS / CONTROLS  
 EXHAUST  
 AIR / FUEL SYSTEMS  
 ENGINE  
 TRANSMISSION / DRIVELINE  
 GASKETS / SEALS  
 ELECTRICAL  
 LIGHTING  
 CABLES  
 BRAKES  
 OIL FILTERS  
 SUSPENSION  
 BODY  
 WHEELS  
 TIRES / TIRE ACC.  
 BIKE ACC.  
 VICTORY / INDIAN  
 COVERS / LOCKS / TIEDOWNS  
 CHEMICALS  
 TOOLS  
 HELMETS  
 HELMET ACC.  
 EYEWEAR  
 APPAREL / RIDER ACC.  
 PROMOTIONAL  
 REFERENCE  
 INDEX

P (continued...)

**PAUGHCO**

Exhaust Systems ..... 292-293  
 Gas Tanks..... 737  
 Motor Mounts ..... 356  
 Muffler Clamps ..... 293  
 Pan Rocker Covers..... 356  
 Rigid Frames ..... 760  
 Risers ..... 179  
 Rocker Covers..... 356  
 Skid Plates ..... 396  
 Springer Forks..... 721  
 Swingarm Bearing Conversion Kit..... 759  
 Transmission Covers & Cases..... 421  
 Wind Guards ..... 20

**PBI**

Sprockets ..... 441

**PC RACING**

Chemicals & Lubes ..... 962  
 Glove Liners ..... 1071  
 Oil Filters ..... 691, 882

**PEDROS**

Torque Wrenches ..... 1017

**PEET DRYER**

Boot Dryers ..... 1267-1268

**PERFORMANCE TOOL**

Air Tanks..... 1009  
 Ball Pein Hammers..... 1003  
 Blow Gun..... 1010  
 Caliper, Digital ..... 1007  
 Chisels/Punches ..... 1006  
 Dead Blow Hammers ..... 1003  
 Feeler Gauges..... 1005  
 Files..... 1006  
 Floor Mats ..... 1008  
 Gear Pullers ..... 1003  
 Hex Key Set..... 1000  
 Impact Extensions..... 998  
 Impact Sockets..... 997  
 Impact Wrenches ..... 1008  
 Inspection Mirror..... 1010  
 Liquid Dispensers..... 1012  
 Magnetic Retriever ..... 1010  
 Multi-Meters..... 1007  
 Piston Ring Compressors..... 1011  
 Pliers ..... 1000-1001  
 Pry Bars ..... 1002  
 Ratcheting Wrenches ..... 998  
 Ratchets ..... 995  
 Razor Scrapers ..... 1010  
 Rivet Guns..... 1004  
 Scraper/Hook/Pick Tools ..... 1002  
 Screwdrivers..... 1001  
 Screw Extractors ..... 1005  
 Shop Lights ..... 1012  
 Shop Towels ..... 1011  
 Socket Extension Sets ..... 995  
 Socket Rails ..... 996  
 Sockets..... 994-996  
 Socket U-Joints - Impact ..... 998  
 Spark Plug Gauges ..... 1006  
 Spray Tanks..... 1009  
 Stud Removers/Installers ..... 1004  
 Tap & Die Sets..... 1005  
 Tape Measures..... 1011  
 T-Handles ..... 1000  
 Timing Lights ..... 1007  
 Tire Bead Seating Tank ..... 1009  
 Valve Lappers..... 1011

P (continued...)

**PERFORMANCE TOOL**

Vice Grips..... 1001  
 Wrenches ..... 995-996, 998

**PERMATEX**  
 Chemicals & Lubes ..... 985-989  
 Petcocks ..... 349

**PHOENIX SYSTEMS**  
 Bleeders, Brake/Clutch/Injectors ..... 1044

**PIAA**  
 Headlights ..... 615  
 Horns..... 511  
 Light Bulbs ..... 620-621

**PIG SPIT**  
 Checmials & Lubes ..... 962

**PIRELLI**  
 Promotional Items/Displays..... 1303  
 Tires ..... 800-801  
 Tubes..... 809  
 Piston Pin Puller ..... 1051  
 Piston Ring Compressors..... 1011  
 Piston Rings ..... 364-365  
 Pistons..... 358-365

**PJ1**  
 Chemicals & Lubes ..... 946-950, 980

**PLANO**  
 Storage Bins..... 1067  
 Plastic Cleaner/Polish/Repair Kits  
 Liquid Performance ..... 957  
 Luster Lace ..... 961  
 Motul ..... 945  
 PC Racing ..... 962  
 Plexus..... 962  
 S100..... 965  
 Three Bond ..... 962  
 Tirox ..... 967  
 Torco..... 953  
 Wizards Products ..... 972

**PLEXUS**  
 Chemicals & Lubes ..... 962  
 Pliers..... 1000-1001  
 Pocket Tuner ..... 343  
 Points & Condensers ..... 553  
 Polish, Tools/Equipment..... 962  
 Portable Device Battery Pack ..... 74  
 Powermadd  
 Helmet Clasps..... 1149

**POWERMADD**  
 Hand Deflectors ..... 218  
 Power Ports ..... 842-843

**POWERTYE**  
 Tiedown Assist ..... 910  
 Tiedowns..... 906-907  
 Track Anchoring Systems..... 915-916

**PRECISION BILLET**  
 Air Cleaners..... 306  
 Billet Covers & Latches ..... 753-754  
 Biltet Brake Cylinder Covers..... 689  
 Derby Covers..... 423  
 Footpegs ..... 245, 250  
 License Plate Frame ..... 852  
 Mirrors ..... 190  
 Points Covers, Billet ..... 388  
 Tank Covers ..... 745  
 Pre-Filters ..... 1021

**PRESION BILLIET**  
 Brake Cylinder Covers..... 209  
 Horn Cover & Bracket..... 511  
 Pressure Regulators..... 347

P (continued...)

Primary Chain Adjuster Locktab.. 416  
 Primary Chains & Tensioners 415-416  
 Primary Covers..... 417-420  
 Primary Oil  
 HardDrive ..... 919  
 Klotz ..... 929  
 Motul ..... 941

**PROFI LASER**  
 Chain Alignment Tools..... 1041

**PROMOTIONAL..... 1291-1309**  
 Adaptiv Technologies..... 1291  
 Air Hawk..... 1291  
 Battery Tender ..... 1291  
 Bel-Ray..... 1291  
 Bobster ..... 1292  
 Bomber..... 1293  
 Casterol..... 1293  
 Clymer..... 1293  
 Counteract..... 1293  
 Dowco ..... 1294  
 Dragon..... 1294  
 Drayko ..... 1294  
 EBC..... 1294  
 Fly ..... 1295  
 FLY Racing..... 1295-1302  
 FLY Street..... 1295  
 Garmin..... 1296  
 GMAX..... 1296  
 HardDrive..... 1297  
 Highway 21..... 1295, 1299  
 K&N..... 1300  
 Kryptonite ..... 1300  
 Lucas Oil ..... 1300  
 Maxima..... 1301  
 Mechanix Wear..... 1301  
 Michelin ..... 1301  
 Motion Pro..... 1302  
 Motorex ..... 1302  
 Motul ..... 1302  
 Nelson-Rigg ..... 1302  
 NGK ..... 1303  
 Pirelli ..... 1303  
 Ram Mounts ..... 1303  
 Ryder Clips..... 1304  
 S100..... 1304  
 Sena..... 1304  
 Shinko ..... 1305  
 Silkolene..... 1304  
 Star Brite ..... 1306  
 Street FX ..... 1306  
 Techmount..... 1306  
 Torco..... 1307  
 UClear..... 1307  
 Venture Heat ..... 1307  
 Wizard ..... 1308  
 WPS ..... 1307  
 Yuasa ..... 1309  
 Zan Headgear ..... 1309

**PRO-ONE**  
 Air Cleaner Covers ..... 313  
 Billet Points Cover ..... 388  
 Billet Signal Lights ..... 603  
 Choke Knob Covers ..... 313  
 Fender Strut Marker Lights..... 602  
 Fork Stop Kits..... 709  
 Hydraulic Clutch Actuator Covers ..... 425  
 Points Covers, Billet ..... 388  
 Primary Inspection Covers ..... 417



**P (continued...)**

**PRO-ONE**  
 Registration Tubes ..... 853  
 Saddlebag Latch Covers ..... 750  
 Soft Bag Brackets ..... 136  
 Soft Bag Support Brackets ..... 750  
 Turn Signal Bars ..... 602-603  
 Turn Signal Eliminators ..... 602  
 Wiring Harness-Split Tanks ..... 514  
 Pry Bars ..... 1002  
 PSI Tester ..... 386

**PSR**  
 Anthem Adjustable Levers ..... 217

**PUIG**  
 Sportster Windscreens ..... 25  
 Pulley Nut Tools ..... 1057  
 Pulleys & Pulley Spacers ..... 438-439  
 Push Rod Adjuster Lock Nuts ..... 373  
 Pushrod Conversion/Adaptor ..... 374  
 Push Rods ..... 372  
 Pushrod Tool ..... 1056  
 Pushrod Tube Holder ..... 374

**PUTCO**  
 Halogen Bulbs ..... 621-622  
 LED Bulbs ..... 617

**Q**

**QUANTUM**  
 Fuel Pumps ..... 348

**QUICK LOADER**  
 Tiedowns ..... 908

**QUIK STEEL**  
 Epoxy Putty/Fillers ..... 979

**R**

Racer Tape ..... 1069

**RACE TECH**  
 Fork Spring Kits ..... 712  
 Fork Springs ..... 713  
 Gold Valve Emulators ..... 712

**RACING BROTHERS**  
 Shocks ..... 701-704  
 Radar/Laser Detector Mounts ..... 831  
 Radar/Laser Detectors ..... 830-831

**RAM MOUNTS**  
 Accessory Mounting Kits ..... 832-838  
 Promotional Items/Displays ..... 1303  
 Ratchets ..... 995

**RATIO RITE**  
 Gas & Oil Mixer Container ..... 1021  
 Razors ..... 1010  
 Razor Scrapers ..... 1010

**RED LINE**  
 Chemicals & Lubes ..... 949-951  
 Funnel ..... 1021

**REFERENCE** ..... 1310-1333  
 Fly Street Gear Size Chart ..... 1310  
 Glove Size Chart ..... 1311  
 HardDrive to OEM Reference ... 1320-1333  
 Model Identification Chart ..... 1313  
 Quick Reference Applications ... 1314-1319  
 Reflectors ..... 854  
 Registration Tubes ..... 853  
 Regulators ..... 529-530  
 Relay Switches ..... 520  
 Relocation Brackets ..... 509-510  
 Retriever, Magnetic ..... 1010  
 Reverse Brake Bleeder ..... 1044

**R (continued...)**

**RICKS ELECTRIC**  
 Regulators ..... 876

**RIDE-ON**  
 Balancer & Sealant ..... 815  
 Smart Caps ..... 813  
 Riding Jeans ..... 1214

**RIGID INDUSTRIES**  
 LED Headlight ..... 586  
 Rim Protectors ..... 1029  
 Rim Strips ..... 810  
 Rim Strip Tape ..... 1024  
 Rims, Victory ..... 887  
 Ring Compressors ..... 1011  
 Risers, Hardware, Clamps .... 176-184

**RISK RACING**  
 Garage Light ..... 1065  
 Work Lights ..... 1065  
 Rivet Guns ..... 1004  
 Rivets ..... 1068  
 Rocker Arms ..... 357  
 Rocker Box Brass Oil Lines ..... 356  
 Rocker Box Wrench ..... 1056

**ROCKET CAMS**  
 Drive Cams ..... 378  
 Rod End Ball Joints ..... 436  
 Roller Lifters ..... 376  
 Rollpin Tool ..... 372  
 Rollstand ..... 1024

**ROOKE**  
 Air Intake ..... 307  
 Axle Nut Covers ..... 758  
 Brake Arms ..... 243  
 Derby Covers ..... 422  
 Dress-Up Kits for Touring Models ..... 848  
 Exhaust Systems ..... 254-255  
 Headbolt Covers ..... 390  
 Heel Shift Eliminators ..... 242  
 Ignition Covers ..... 390  
 Master Cylinder Covers ..... 688  
 Master Cylinder Covers ..... 208, 688  
 Mirror Mounts ..... 196  
 Oil Dipstick Caps ..... 397  
 Risers ..... 176  
 Saddlebag Latch Inserts ..... 750  
 Shift Pegs & Spacers ..... 243  
 Shift Rods ..... 244, 436  
 Transmission Dipsticks ..... 397, 435  
 Triple Trees ..... 709

**ROX**  
 Risers ..... 178  
 Rust Removers/Preventors  
 S100 ..... 965  
 Star Brite ..... 976  
 Workshop Hero ..... 982

**RYDER BALLS** ..... 820

**RYDER CLIPS**  
 Promotional Items/Displays ..... 1304  
 Rider Pant/ Boot Clips ..... 1287-1288

**S**

**S100**  
 Chemicals & Lubes ..... 964-966  
 Promotional Items/Displays ..... 1304  
 Saddlebag Accessories ..... 844-846  
 Saddlebag Brackets ..... 136, 747  
 Saddlebag Latch Inserts / Covers ..... 750  
 Saddlebag Latch Kit ..... 749  
 Saddlebag Lock Kit ..... 135

**S (continued...)**

Saddlebags ..... 121-134  
 Saddlebags - ABS ..... 746  
 Saddlebags, Indian Scout ..... 859  
 Safety Wire ..... 1027  
 Saw Guide ..... 1060

**SAWICKI SPEED SHOP**  
 Exhaust System ..... 256-257

**SCORPION**  
 Gloves ..... 1251-1257  
 Helmet Replacement Parts ..... 1142-1144  
 Helmets ..... 1111-1124  
 Mens Riding Jackets ..... 1215-1217  
 Riding Shirts ..... 1218  
 Womens Riding Jackets ..... 1215, 1217

**SCOSCHE**  
 Audio/Communications ..... 45-47

**SCOTT**  
 No-Fog Clothes ..... 1148  
 Sunglasses ..... 1170-1171  
 Scraper/Hook/Pick Tools ..... 1002  
 Scrapers ..... 1010  
 Screwdrivers ..... 1001  
 Screw Extractors ..... 1005  
 Sealant, Tire ..... 815-816  
 Sealed Beam Headlights ..... 614  
 Seals & Gaskets ..... 874-875

**SEATS / LUGGAGE** ..... 82-148  
 Grab Rails ..... 144  
 Luggage ..... 116-122, 138-139  
 Luggage Racks ..... 145-148  
 Rear Seat Mounts ..... 105  
 Saddlebag Lock Kit ..... 135  
 Saddlebags ..... 121-134  
 Saddlebag Support Brackets ..... 136  
 Seat Cushions ..... 114-115  
 Seat Mounting Kits ..... 109-111  
 Seats ..... 82-109, 112  
 Seat Screws ..... 105  
 Sissy Bars ..... 140-142  
 Swingarm Bags ..... 137

**SEDONA**  
 Tubes ..... 808

**SENA**  
 Action Cameras ..... 60, 73  
 Battery Pack, Portable ..... 74  
 Communication Systems ..... 57-75  
 Helmets ..... 1125-1127  
 Promotional Items/Displays ..... 1304  
 Shift Levers & Parts ..... 437  
 Shift Pegs & Spacers ..... 243  
 Shift Rod Ends ..... 436  
 Shift Rods ..... 244-245, 436

**SHINKO**  
 Promotional Items/Displays ..... 1305  
 Tires ..... 802-806

Shock Oil  
 Bel-Ray ..... 922  
 Maxima ..... 937  
 Motul ..... 943  
 Red Line ..... 950  
 Torco ..... 952

Shocks ..... 696-703  
 Shock Spring Installer ..... 1050  
 Shoes, Riding ..... 1265-1266  
 Shop Floor Mats ..... 1008  
 Shop Jacks ..... 1080-1081  
 Shop Lights ..... 1012  
 Shop, Stools ..... 1064

WINDSHIELDS / FAIRINGS  
 AUDIO / COMMUNICATION  
 SEATS / LUGGAGE  
 BARS / MIRRORS / CONTROLS  
 EXHAUST  
 AIR / FUEL SYSTEMS  
 ENGINE  
 TRANSMISSION / DRIVELINE  
 GASKETS / SEALS  
 ELECTRICAL  
 LIGHTING  
 CABLES  
 BRAKES  
 OIL FILTERS  
 SUSPENSION  
 BODY  
 WHEELS  
 TIRES / TIRE ACC.  
 BIKE ACC.  
 VICTORY / INDIAN  
 COVERS / LOCKS / TIEDOWNS  
 CHEMICALS  
 TOOLS  
 HELMETS  
 HELMET ACC.  
 EYEWEAR  
 APPAREL / RIDER ACC.  
 PROMOTIONAL  
 REFERENCE  
 INDEX

S (continued...)

Shop Table ..... 1063  
 Shop Towels ..... 1011  
 Shop, Work Stand ..... 1049  
**SHOW CHROME**  
 Fairing Vent Trim & Screen ..... 847  
 Luggage Racks ..... 148  
 Spot Light Visors ..... 847  
 Side Case Cover Puller ..... 1056  
**SIGNAL DYNAMICS (SDC)**  
 LED Retro-Fit Kit ..... 611  
 License Plate Frames / Lights ..... 599  
 Light Modules ..... 624-627  
 Signal Lights ..... 603  
 Silicone Coating ..... 303  
**SILKOLENE**  
 Promotional Items/Displays ..... 1304  
 Siphons ..... 353  
 Sissy Bars ..... 140-142  
 Skid Plates ..... 772, 773  
**SLIME**  
 Tire Repair ..... 816-817  
**SLIP STREAMER**  
 Windshield Cleaner/Polish ..... 962  
 Windshields ..... 21-25  
 Snap Ring Pliers ..... 1055  
 Socket - Axle ..... 1046  
 Socket Bit Set ..... 1016  
 Sockets ..... 994-996  
 Allen ..... 996  
 Extension Sets ..... 995  
 Hex ..... 996  
 Impact ..... 997  
 Impact Extensions ..... 998  
 Rails ..... 996  
 Socket/U-Joint Adapters ..... 995  
 Star ..... 996  
 Spark Plug Gauges ..... 1006  
 Spark Plugs ..... 558-559, 877  
 Spark Plug Wires ..... 554-557  
 Spark Plug Wrenches ..... 557  
 Spark Plug Wrenches/Sockets ..... 996  
 Speaker & Amp Kits ..... 35-36  
 Speaker Kits ..... 41-43  
 Speakers ..... 33-52  
**SPEAQUA**  
 Bluetooth Speakers ..... 52  
 Speedbleeders ..... 679  
 Speedo Cables ..... 643, 651-652, 656  
 Speedometer Drives ..... 794  
 Speedometer/Tachometer Gauges ..... 499-507  
**SPEEDO TUNER** ..... 504  
**SPEED-WAY**  
 Shelter ..... 888  
**SPI**  
 Heat Shrink Tubing ..... 1062  
 Hose Clips ..... 352  
 Washer Kits ..... 557  
 Spoke Wheels ..... 788-789  
 Spoke Wrenches ..... 1031  
 Spoons, Tire ..... 1026-1027  
 Spot Lamps ..... 586  
 Spot Light Visors ..... 847  
 Spray Tanks ..... 1009  
 Sprocket Covers ..... 387  
 Sprocket Jammer ..... 1038

S (continued...)

Sprocket & Pulley Spacers  
 HardDrive ..... 793  
 Sprockets ..... 413-414, 440-442  
 Sprockets & Pulleys ..... 787  
**STA-BIL**  
 Chemicals & Lubes ..... 975  
**STA-DR1**  
 Fuel Dryer ..... 981  
**STANDARD**  
 Circuit Breakers ..... 517  
 Electronic Fuel Injection Sensors ..... 522  
 Switches ..... 523-525  
**STAR BRITE**  
 Chemicals & Lubes ..... 978-979, 981  
 Promotional Items/Displays ..... 1306  
 Star Sockets ..... 996  
 Starters, Parts & Kits ..... 533-538  
 Starting Fluid, Mechanics ..... 979  
 Stators ..... 527, 529  
 Steering Dampers ..... 720  
 Steering Race Removers/Presses ..... 1048-1050  
 Stereos, Bluetooth ..... 32  
 Stoplight Switches ..... 520  
 Storage Bins ..... 1067  
**STREAMLINE**  
 Brakelines ..... 684  
**STREET FX**  
 Clocks ..... 850  
 Flashers/Resistors, Turn Signal ..... 636  
 Fuses ..... 518  
 Gloves, Riding ..... 1260  
 Light Kits ..... 632-636  
 Light Modules ..... 635  
 Promotional Items/Displays ..... 1306  
 Valve Stems, Lighted ..... 635  
 Stud Removers/Installers ..... 1004  
**SULLYS CUSTOMS**  
 Seats ..... 106  
 Sunglasses  
 Dragon ..... 1172-1180  
 HMK ..... 1170  
 Scott ..... 1170-1171  
**SUNSTAR**  
 Chains ..... 449  
 Super Glue ..... 984  
 Support Brackets, Saddlebags ..... 136  
**SUSPENSION** ..... 695-721  
 Bearings ..... 718-719  
 Fork Boot Caps ..... 715  
 Fork Boots/ Dust Boots ..... 716  
 Fork Covers ..... 714-715  
 Fork/ Dust Seals ..... 717  
 Forks ..... 721  
 Fork Spring Kits ..... 710-712  
 Fork Springs ..... 713  
 Fork Stem Cap ..... 719  
 Fork Stem Nut ..... 718  
 Fork Stop Kits ..... 709  
 Fork Tube Bolt / Plug ..... 719  
 Fork Tube Rebuild Kits ..... 715  
 Fork Tubes ..... 714  
 Front End Kits ..... 707  
 Lowering Kits ..... 706  
 Shocks ..... 696-703  
 Steering Dampers ..... 720  
 Triple Trees ..... 709

S (continued...)

Swingarm Bearing Conversion Kit ..... 759  
 Swing Arm Bearings ..... 718, 758  
 Swingarm Bushing ..... 758  
 Swingarm Isolator Mount ..... 396, 758  
 Switches ..... 519-525

T

Tail Lights ..... 591  
 Tank Mounts ..... 738-739  
 Tap & Die Sets ..... 1005  
 Tape - Barricade ..... 1069  
 Tape - Duct ..... 1069  
 Tape - Electrical ..... 1068  
 Tape, Electrical ..... 977, 988  
 Tape - Heat Foil ..... 1068  
 Tape Measures ..... 1011  
 Tape - Multipurpose ..... 1070  
 Tape - Non-Skid ..... 1069  
 Tape - Reflective ..... 1069  
 Tape - X-treme ..... 1070  
 Tappet Tool ..... 1056  
**TC BROS.**  
 Air Cleaner Accessories ..... 316  
 Air Cleaners ..... 309-310  
 Battery Box ..... 762  
 Bungs, Tabs & Plates ..... 763-767  
 Electronics Box ..... 762  
 Exhaust Systems ..... 294  
 Fender Strut Kit ..... 733  
 Forward/Mid Controls ..... 222-225  
 Gas Tank Parts ..... 734  
 Handlebars ..... 163-165  
 Headlight Cowls ..... 29-30  
 Headlights ..... 583  
 Kickstands & Parts ..... 769  
 Rigid Seats ..... 112  
 Rod End Ball Joints ..... 436  
 Seat Mounting Kits ..... 111  
 Sissy Bars ..... 141, 142  
 Tail Lights ..... 591, 597-599, 604  
 Universal HardTail Kit ..... 762  
 Tear Down Table ..... 1063  
**TECHMOUNT**  
 Accessory Mounts ..... 840-841  
 Promotional Items/Displays ..... 1306  
 Testers, Compression ..... 1053  
 Testers, Electrical ..... 1062  
 Testers, Ignition ..... 1062  
 Testers, Leak Down ..... 1053  
**T-Handles**  
 Allen ..... 1000  
 Hex ..... 1000  
 Star ..... 1000  
 T-Handles/Racks ..... 1020-1023  
**THE GRUNGE BRUSH**  
 Chain Brush ..... 451  
**THE PRO PAD**  
 Flag Mounts ..... 851  
 Floorboard Extensions ..... 253  
 Seat Pads ..... 115  
 Thread Lock/Sealant  
 Permatex ..... 988  
 Three Bond ..... 984  
**THREE BOND**  
 Chemicals & Lubes ..... 962, 984  
 Throttle Cables ..... 637-639, 643-646, 653-654

T (continued...)

Throttle Slide Membrane ..... 342  
 Tiedowns ..... 905-910  
**TIER1**  
 Fuel Optimizer ..... 872  
 Fuel Optimizers ..... 325  
 Timing Lights ..... 1007  
 Tire Bead Seating Tank ..... 1009  
 Tire Bead Starter ..... 1028  
 Tire Changer Machine ..... 1025  
 Tire Irons ..... 1027-1029  
 Tire Pressure Gauges ..... 1032  
 Tire Pressure Monitors ..... 817-818  
 Tire Repair Kits ..... 1034  
**TIRES / TIRE ACCESSORIES.. 796-819**  
 Balancing Beads ..... 811  
 Bead Breakers ..... 1029  
 Bead Holder ..... 1028  
 Bead Starter ..... 1028  
 Conversion Charts ..... 796  
 Funnels ..... 1021-1022  
 Garage Light ..... 1065  
 Michelin ..... 797-799  
 Pirelli ..... 800-801  
 Pressure Gauges ..... 1032  
 Repair Kits ..... 1034  
 Repair & Monitor ..... 817-819  
 Rim Protectors ..... 1029  
 Rim Strips ..... 810  
 Shinko ..... 802-806  
 Tire Changing Station ..... 1024  
 Tire Irons ..... 1026-1027  
 Tire Sealant ..... 815-816  
 Tubes ..... 808-810  
 Valve Stems & Caps ..... 812-813  
 Valve Tools ..... 1028, 1032  
 Wheel Weights ..... 813-814  
**TIROX**  
 Chemicals & Lubes ..... 967  
 Toggle Switches ..... 519  
**TOOLS ..... 990-1083**  
 Air Hoses & Fittings ..... 1033  
 Air Tanks ..... 1009  
 Appraisal Guides ..... 1082  
 Apron ..... 1070  
 Bead Breaker ..... 1029  
 Belt Tension Gauge ..... 1059  
 Blow Gun ..... 1033  
 Caliper, Digital ..... 1007  
 Cam Install Kit ..... 1053  
 Carb Leak Detector ..... 1051  
 Chain Tools ..... 1036-1040  
 Chisels/Punches ..... 1006  
 Clutch Adjuster ..... 1056  
 Clutch Holding Tool ..... 1055  
 Clutch Hub Removing Driver ..... 1058  
 Clutch Spring Tool ..... 1059  
 Crankshaft Jam Tool ..... 1058  
 Crankshaft Turning Tool ..... 1058  
 Diagnostic Systems ..... 990-993  
 Electrical Terminals ..... 1067  
 Electric Testers ..... 1062  
 Feeler Gauges ..... 1005  
 Files ..... 1006  
 Floor Mats ..... 1008  
 Fork Align Tool ..... 1040  
 Fork Seal Driver ..... 1045  
 Fuel Line Clamping Pliers ..... 1061  
 Gear Tools ..... 1003

T (continued...)

**TOOLS ..... 990-1083**  
 Glove Liners ..... 1071  
 Gloves - Mechanix Wear ..... 1072  
 Grip Cutter ..... 1027  
 Hammers ..... 1003  
 Heat Shrink Tubing ..... 1062  
 Heat Sleeve ..... 1071  
 Hose Clamp Kits ..... 1061  
 Ignition Point Tool ..... 1058  
 Ignition Testers ..... 1062  
 Impact Wrenches ..... 1008  
 Inner Primary Service Kit ..... 1057  
 Jet Cleaning Tool ..... 1050  
 Liquid Dispensers ..... 1012  
 Magnetic Finger Glove ..... 1060  
 Magnetic Parts Dish ..... 1064  
 Maindrive Service Kit ..... 1057  
 Motorcycle Dryers ..... 1023  
 Motorcycle Lifts ..... 1074  
 Oil Filter Magnet ..... 1055  
 Oil Filter Strap Wrench ..... 1055  
 Phoenix Systems ..... 1044  
 Piston Ring Compressors ..... 1011  
 Pliers ..... 1000-1001  
 Portable Workbench ..... 1063  
 Pry Bars ..... 1002  
 Pulley Nut Tools ..... 1057  
 Pushrod Tool ..... 1056  
 Ratchets ..... 995  
 Razor Scrapers ..... 1010  
 Red Line ..... 1021  
 Retriever, Magnetic ..... 1010  
 Rim Protectors ..... 1029  
 Rim Strip Tape ..... 1024  
 Rivet Guns ..... 1004  
 Rivets ..... 1068  
 Rocker Box Wrench ..... 1056  
 Rollstand ..... 1024  
 Safety Wire & Pliers ..... 1027  
 Saw Guide ..... 1060  
 Scraper/Hook/Pick Tools ..... 1002  
 Screwdrivers ..... 1001  
 Screw Extractors ..... 1005  
 Shock Tools ..... 1049-1050  
 Shop Lights ..... 1012  
 Shop Stools ..... 1064  
 Shop Table ..... 1063  
 Shop Towels ..... 1011  
 Side Case Cover Puller ..... 1056  
 Snap Ring Pliers ..... 1055  
 Socket - Axle ..... 1046  
 Socket Extension Sets ..... 995  
 Sockets ..... 994-996  
 Socket/U-Joint Adapters ..... 995  
 Socket U-Joints - Impact ..... 998  
 Spark Plug Gauges ..... 1006  
 Steering /Fork/Shock Tools ..... 1048-1060  
 Storage Bins ..... 1067  
 Stud Removers/Installers ..... 1004  
 Tap & Die Sets ..... 1005  
 Tape Measures ..... 1011  
 Tapes ..... 1069-1073  
 Tappet Tool ..... 1056  
 T-Handles/Racks ..... 1000, 1020-1023  
 Tire Bead Starter ..... 1028  
 Tire Irons ..... 1027-1029  
 Tire Pressure Gauges ..... 1032  
 Tire Repair & Inflation Kits ..... 1035

T (continued...)

**TOOLS ..... 990-1083**  
 Tire Repair Kits ..... 1034-1035  
 Tool Kits ..... 1013-1019  
 Tool Pouch ..... 1060  
 Torque Wrenches ..... 995, 1017  
 Truing Stands, Wheel ..... 1029-1030  
 Valve Lappers ..... 1011  
 Valve Spring Tools ..... 1054  
 Valve Stem Pullers ..... 1032  
 Vice Grips ..... 1001  
 Voltage Testers ..... 1007  
 Wheel Bearing Remover ..... 1045  
 Work Lights ..... 1065  
 Wrenches ..... 998  
 Wrenches, Spoke ..... 1031  
**TOP SHELF**  
 Saddlebag Accessories ..... 844-845  
**TORCH INDUSTRIES**  
 Handlebars ..... 159  
**TORCO**  
 Chemicals & Lubes ..... 951-955  
 Promotional Items/Displays ..... 1307  
 Torque Valve, Exhaust ..... 298  
 Torx ..... 1000  
 Tour Pak Lenses ..... 600  
 Traction Treatments ..... 927  
 Transmission Dipsticks ..... 397  
**TRANSMISSION / DRIVELINE. 405-449**  
 Chain Brush ..... 451  
 Chains ..... 444-451  
 Clutch Hub Bearing ..... 412  
 Clutch Kits & Parts ..... 405-409  
 Clutch Pushrods ..... 411  
 Clutch Release Kit ..... 411  
 Clutch Shells & Hubs ..... 410  
 Clutch Springs & Hub Keys ..... 412  
 Compensator Eliminator Sprockets ..... 413  
 Compensator Sprockets ..... 414  
 Derby Covers ..... 422-423  
 Drive Belts ..... 439  
 Electric Kicker Covers ..... 426  
 Inspection Covers ..... 417-418  
 Motor Sprockets ..... 413  
 Outer Primary Covers ..... 419-420  
 Primary Chains & Tensioners ..... 415-416  
 Pulleys & Pulley Spacers ..... 438-439  
 Shift Levers & Parts ..... 437  
 Shift Rods ..... 436  
 Sprocket Keys ..... 413  
 Sprockets ..... 440-442  
 Tin Primaries ..... 421  
 Transmission Build Kits ..... 429-431  
 Transmission Covers ..... 424-425  
 Transmission Parts ..... 432-435  
**Transmission Oil**  
 Bel-Ray ..... 922  
 HardDrive ..... 919  
 Lucas Oil ..... 932  
 Maxima ..... 936  
 Red Line ..... 949  
 Torco ..... 951  
**TRI-FLOW**  
 Chemicals & Lubes ..... 980  
 Triple Trees ..... 709  
 Truing Stands, Wheel ..... 1029, 1030  
**TRU-TENSION**  
 Belt Monkey ..... 1042  
 Chain Monkey ..... 1042

WINDSHIELDS / FAIRINGS  
 AUDIO / COMMUNICATION  
 SEATS / LUGGAGE  
 BARS / MIRRORS / CONTROLS  
 EXHAUST  
 AIR / FUEL SYSTEMS  
 ENGINE  
 TRANSMISSION / DRIVELINE  
 GASKETS / SEALS  
 ELECTRICAL  
 LIGHTING  
 CABLES  
 BRAKES  
 OIL FILTERS  
 SUSPENSION  
 BODY  
 WHEELS  
 TIRES / TIRE ACC.  
 BIKE ACC.  
 VICTORY / INDIAN  
 COVERS / LOCKS / TIEDOWNS  
 CHEMICALS  
 TOOLS  
 HELMETS  
 HELMET ACC.  
 EYEWEAR  
 APPAREL / RIDER ACC.  
 PROMOTIONAL  
 REFERENCE  
**INDEX**

T (continued...)

**TRU-TENSION**  
 Chemicals & Lubes ..... 968-969

**TTS**  
 Camshafts ..... 377  
 MasterTune System..... 324  
 Tuner Kits..... 338  
 Turn Signal Brackets..... 612  
 Turn Signal Clamps ..... 611  
 Turn Signal Eliminators..... 602-603  
 Turn Signals..... 607-608, 611  
 Twin Cam Motor Adapter Plate.... 396

U

**UCLEAR**  
 Earbuds ..... 78  
 Headphones..... 81  
 Headsets & Communication Systems 75-81  
 Promotional Items/Displays..... 1307

**UNI**  
 Air Filters ..... 323

**UNIT**  
 Snap Ring Pliers..... 1017  
 USB Chargers ..... 842-843  
 Utility Containers  
 Ernst..... 1021  
 MidWest Can..... 1022  
 Outerwears..... 1021  
 Utility Trailer ..... 911

V

Valve Grinding Compound, Permatex 987  
 Valve Guides & Stem Seals.. 370-371  
 Valve Keepers..... 369  
 Valve Lappers..... 1011  
 Valves  
 Kibblewhite ..... 368  
 Valve Seats..... 368  
 Valve Springs  
 Kibblewhite..... 369  
 Valve Springs & Lifters ..... 380  
 Lunati ..... 380  
 Valve Spring Tools ..... 1054  
 Valve Stem Pullers ..... 1032  
 Valve Stems & Caps..... 812-813  
 Valve Stems, Lighted..... 635  
 Vector Laser Brake Light ..... 628

**VENTURE**  
 Gloves, Riding ..... 1258-1259  
 Heated Gear..... 1232  
 Promotions & Displays ..... 1307  
 Vice Grips ..... 1001

**VICTORY / INDIAN ..... 857-887**  
 Air Filters ..... 873  
 Batteries ..... 875  
 Brake Pads..... 878  
 Braking Pads & Shoes ..... 880-882  
 Clamp-on Pegs..... 886  
 Engine Guards ..... 886  
 Exhaust Systems ..... 864-868  
 Fox Shock Absorber ..... 883  
 Fuel Management Systems..... 870  
 Generators - Indian ..... 876  
 Grips..... 861-863  
 Hand Deflectors ..... 858  
 LED Passing Lamp Bulb ..... 875  
 Luggage Racks ..... 859-860

V (continued...)

**VICTORY / INDIAN ..... 857-887**  
 Oil / Dust Fork Seal Wiper Kits..... 885  
 Oil Filters ..... 882-883  
 Regulators ..... 876  
 Rims, Victory ..... 887  
 Saddlebags ..... 859  
 Seals & Gaskets..... 874-875  
 Spark Plugs..... 877  
 Starter Motors ..... 876  
 Steering Head Bearings ..... 884-887  
 Wheel Bearings..... 884-887  
 Wheels, Victory ..... 887  
 Windshields ..... 857-858  
 Vinyl Cleaners/Conditioners  
 Pig Spit..... 962  
 Vise Inserts..... 1049  
 Voltage Regulators ..... 531  
 Voltage Testers ..... 1007

**VORTEX**  
 Chains ..... 449  
 Tiedowns ..... 908

W

Wax/Polish  
 Lucas Oil ..... 934  
 Luster Lace ..... 960  
 Maxima..... 938  
 Motul ..... 944  
 S100..... 964  
 Wizards Products ..... 970

**WD-40..... 980**

**WEST EAGLE**  
 Air Cleaners..... 308  
 Carburetor Support Brackets..... 315  
 Exhaust Systems ..... 295  
 Fenders ..... 728-732  
 Fender & Seat Kit..... 728  
 Gas Tank Cover..... 740  
 Gas Tank Garnish Cover ..... 774  
 Gas Tank Lift Kit ..... 740  
 Hand Guards..... 220  
 Handlebars ..... 160-162  
 Headlight Cowls ..... 29-30  
 Heat Shields..... 297  
 LED Taillights & Signals..... 606  
 Luggage ..... 139  
 Mud Guards ..... 774  
 Passenger Peg Relocation Kit..... 774  
 Raised Mid Controls..... 226  
 Relocation Brackets ..... 509-510  
 Riser Adapters ..... 183  
 Riser Bushings ..... 180  
 Risers ..... 178  
 Seat Mounting Kits ..... 109-110  
 Seats ..... 104, 107-108  
 Signal Block Off Plates..... 603  
 Sissy Bar License Plate Mount..... 599  
 Skid Plates ..... 772  
 Suspended Headlight Bracket..... 587  
 Tail Lights ..... 592  
 Triangle Headlights..... 588  
 Turn Signal Brackets ..... 612  
 Wheel Balancer Machine..... 1025  
 Wheel Bearing Remover ..... 1045

W (continued...)

Wheel Bearings ..... 884-887  
 Wheel Chocks ..... 913-914

**WHEELS ..... 780-795**  
 Axels..... 790  
 Axle Spacers..... 792  
 Bearings & Seals..... 795  
 Custom Pulleys ..... 784  
 Forged Aluminum ..... 780-783  
 Lyndall Rotors ..... 786  
 Lyndall Wheels ..... 785  
 Speedometer Drives..... 794  
 Spoke Wheels ..... 788-789  
 Sprocket & Pulley Spacers ..... 793  
 Sprockets & Pulleys..... 787  
 Wheels, Victory..... 887  
 Wheel Weights..... 813-814

**WILD 1**  
 Cable Clamps..... 658  
 Handlebars..... 169-174  
 Riser Adapters ..... 183  
 Riser Bushings ..... 184  
 Risers ..... 180  
 Speedo Bezel..... 505  
 Sure Grip Clamps..... 171  
 Top Clamps ..... 182

**WILLIE & MAX**  
 Luggage ..... 125-135, 137  
 Windshield Cleaner & Protectant. 954

**WINDSHIELDS / FAIRINGS ..... 2-24**  
 Dragonfly ..... 26  
 National Cycle ..... 4-20  
 Paughco ..... 20  
 Puig..... 25  
 Slip Streamer..... 21-25  
 Windshields, Victory/Indian ..... 857  
 Wire, Control..... 660  
 Wire Safety tools ..... 1027  
 Wiring Connectors ..... 512-514  
 Wiring Extension Kits..... 185-186  
 Wiring Extensions..... 515-516  
 Wiring Harnesses ..... 44

**WISECO**  
 Nylon Bore Brush ..... 1052  
 Pistons ..... 361-363

**WIZARDS PRODUCTS**  
 Chemicals & Lubes ..... 970-973  
 Promotional Items/Displays..... 1308  
 Work Lights..... 1065

**WORKSHOP HERO**  
 Chemicals & Lubes ..... 982  
 Work Stand ..... 1049

**WPS**  
 Batteries ..... 562-563  
 Carb Tool Kit..... 343  
 Covers ..... 892  
 Flashers/Resistors, Turn Signal..... 636  
 Fuel Line ..... 350  
 Promotional Items/Displays..... 1307  
 Wrenches ..... 998, 1050  
 Adjustable..... 999  
 Allen ..... 1000  
 Crow Foot..... 999  
 Flare Nut ..... 999  
 Ratcheting..... 998

W (continued...)	
Wrenches	
Shock .....	1050
Spanner.....	1050
Spark Plugs.....	1062
Spoke .....	1031
T-Handles .....	1018
Torque .....	995
Wrist Pin Bushing .....	365

X	
<b>XENA</b>	
Locks .....	902-903

Y	
<b>YANA SHIKI</b>	
H.I.D. Light Kits.....	616
<b>YUASA</b>	
Batteries .....	566, 875
Battery Chargers.....	579

Y (continued...)	
<b>YUASA</b>	
Jumper Cables .....	579
Promotional Items/Displays.....	1309

Z	
<b>ZAN HEADGEAR</b>	
Balaclavas .....	1283
Bandanas & Head Wraps.....	1269-1279
Eyewear .....	1168-1169
Promotional Items/Displays.....	1309



WINDSHIELDS / FAIRINGS
AUDIO / COMMUNICATION
SEATS / LUGGAGE
BAR / MIRRORS / CONTROLS
EXHAUST
AIR / FUEL SYSTEMS
ENGINE
TRANSMISSION / DRIVELINE
GASKETS / SEALS
ELECTRICAL
LIGHTING
CABLES
BRAKES
OIL FILTERS
SUSPENSION
BODY
WHEELS
TIRES / TIRE ACC.
BIKE ACC.
VICTORY / INDIAN
COVERS / LOCKS / TIEDOWNS
CHEMICALS
TOOLS
HELMETS
HELMET ACC.
EYEWEAR
APPAREL / RIDER ACC.
PROMOTIONAL
REFERENCE
INDEX

- WINDSHIELDS / FAIRINGS
- AUDIO / COMMUNICATION
- SEATS / LUGGAGE
- BARS / MIRRORS / CONTROLS
- EXHAUST
- AIR / FUEL SYSTEMS
- ENGINE
- TRANSMISSION / DRIVELINE
- GASKETS / SEALS
- ELECTRICAL
- LIGHTING
- CABLES
- BRAKES
- OIL FILTERS
- SUSPENSION
- BODY
- WHEELS
- TIRES / TIRE ACC.
- BIKE ACC.
- VICTORY / INDIAN
- COVERS / LOCKS / TIEDOWNS
- CHEMICALS
- TOOLS
- HELMETS
- HELMET ACC.
- EYEWEAR
- APPAREL / RIDER ACC.
- PROMOTIONAL
- REFERENCE

**Elizabethtown, PA**  
**Warehouse facility;**  
144,000 sq. ft.



**Memphis, TN**  
**Warehouse facility;**  
109,000 sq. ft.



**Fresno, CA**  
**Warehouse facility;**  
100,000 sq. ft.



**Boise, ID**  
**Corporate Headquarters**  
**and Warehouse facility**  
258,000 sq. ft.



**Midlothian, TX**  
**Warehouse facility;**  
180,000 sq. ft.



**Ashley, IN**  
**Warehouse facility;**  
207,000 sq. ft.



WINDSHIELDS / FAIRINGS  
AUDIO / COMMUNICATION  
SEATS / LUGGAGE  
BARS / MIRRORS / CONTROLS  
EXHAUST  
AIR / FUEL SYSTEMS  
ENGINE  
TRANSMISSION / DRIVELINE  
GASKETS / SEALS  
ELECTRICAL  
LIGHTING  
CABLES  
BRAKES  
OIL FILTERS  
SUSPENSION  
BODY  
WHEELS  
TIRES / TIRE ACC.  
BIKE ACC.  
VICTORY / INDIAN  
COVERS / LOCKS / TIEDOWNS  
CHEMICALS  
TOOLS  
HELMETS  
HELMET ACC.  
EYEWEAR  
APPAREL / RIDER ACC.  
PROMOTIONAL  
REFERENCE

# AMP GO

The UCLEAR AMP Go full-duplex Bluetooth® helmet audio system is ideal for single rider and small group communications. Using the integrated Boost Plus speaker system, you can enjoy exceptional audio quality as you head down the highway. Our exclusive noise-cancelling ABF technology eliminates virtually all background noise, while our patented DSP algorithms triangulate your voice's "sweet spot" to produce clear voice for phone calls and intercom conversations. The UCLEAR Digital AMP Go is built on the foundation of the popular Bluetooth® AMP Series. The AMP Go has many of the features of the AMP premium series including Bluetooth® 4.2 connectivity, ClearLink and enhanced audio. The AMP Go enables a rider to enjoy investment protection with upgradeable options. The AMP Go is simply the most feature rich entry level product available!

**PRODUCT FEATURES:**

- Reliable bluetooth® 4.2
- Small group (4 rider) intercom
- Up to 300m (0.186mi) intercom range
- ClearLink app
- Cross brand compatibility
- Boost plus speaker with concealed microphones
- Industry's most portable system
- Weatherproof

**Exclusive brick & mortar MAP policy**



**Included In The Box**

- (1) AMP Go Controller Unit
- (1) Boost Plus Speaker/Mic Array
- (1) Permanent Mount
- (1) Temporary Mount
- (1) USB Charging Cable
- (1) Speaker Mount Round Set
- (1) Quick Start Guide



Description	WPS#
AMP Go Single	161234



- WINDSHIELDS / FAIRINGS
- AUDIO / COMMUNICATION
- SEATS / LUGGAGE
- BARS / MIRRORS / CONTROLS
- EXHAUST
- AIR / FUEL SYSTEMS
- ENGINE
- TRANSMISSION / DRIVELINE
- GASKETS / SEALS
- ELECTRICAL
- LIGHTING
- CABLES
- BRAKES
- OIL FILTERS
- SUSPENSION
- BODY
- WHEELS
- TIRES / TIRE ACC.
- BIKE ACC.
- VICTORY / INDIAN
- COVERS / LOCKS / TIEDOWNS
- CHEMICALS
- TOOLS
- HELMETS
- HELMET ACC.
- EYEWEAR
- APPAREL / RIDER ACC.
- PROMOTIONAL
- REFERENCE
- INDEX



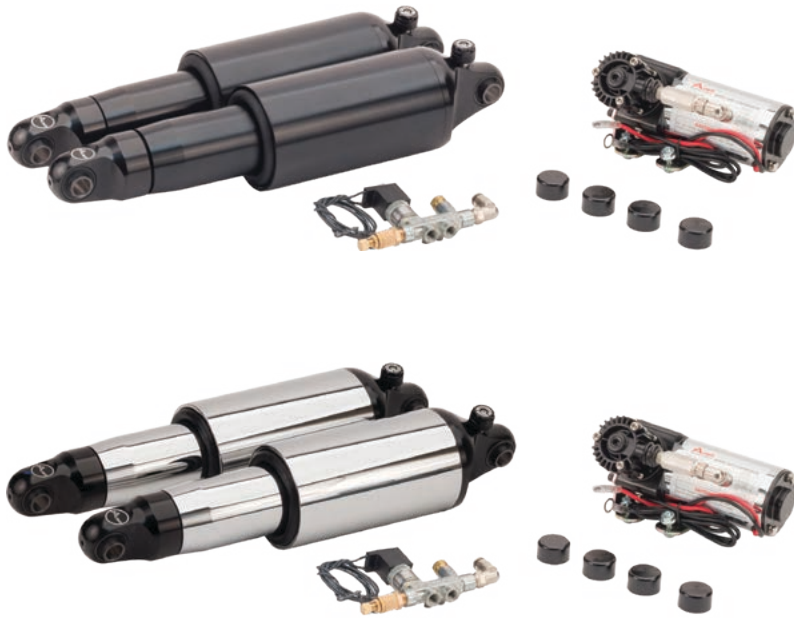

## FOX SERIES V-ROD AIR SUSPENSION

At the core of this system are two custom nitrogen charged FOX shock absorbers. Then, using a patent-pending design, Arnett adds a rugged Goodyear® air spring, ensuring superior comfort, ride quality, and durability. Arnett pairs your shocks with a small but powerful compressor, application-specific mounting bracket, and air distribution valve block which include a muffler to control how fast air is released. Each kit includes everything you need for a fast and flawless installation including Detailed Installation Manual, fused wiring harness and relay assembly, handlebar-mounted inflation switch, all necessary tubing, cable ties, fittings, bolt covers, and mounting accessories.

Application	Year	Black	Chrome
V-Rod	'07-17	850-01044	850-01045
<b>WITH REBOUND ADJUSTMENT</b>			
V-Rod	'07-17	850-01042	850-01043



## 2018 SOFTAIL SERIES AIR SUSPENSION



Arnett engineers improved the new Softail's rear suspension by designing a fully adjustable FOX® mono shock and air spring that can be controlled with an on-board compressor and inflation switch, providing exceptional ride quality, confident control while stopped and enhanced safety.

Application	Year	Black	Chrome
Softails	'18-Up	850-01070	850-01071

- WINDSHIELDS / FAIRINGS
- AUDIO / COMMUNICATION
- SEATS / LUGGAGE
- BAR / MIRRORS / CONTROLS
- EXHAUST
- AIR / FUEL SYSTEMS
- ENGINE
- TRANSMISSION / DRIVELINE
- GASKETS / SEALS
- ELECTRICAL
- LIGHTING
- CABLES
- BRAKES
- OIL FILTERS
- SUSPENSION**
- BODY
- WHEELS
- TIRES / TIRE ACC.
- BIKE ACC.
- VICTORY / INDIAN
- COVERS / LOCKS / TIEDOWNS
- CHEMICALS
- TOOLS
- HELMETS
- HELMET ACC.
- EYEWEAR
- APPAREL / RIDER ACC.
- PROMOTIONAL
- REFERENCE
- INDEX



# LYNDALL TT TRACKER AND B-52 ROTORS

Create your own rotors to match your Lyndall wheels. Choose your center carrier design and finish then choose the friction ring that fits your application in silver or black high carbon steel in crown cut or smooth. Lyndall's patented lug drive design allows for easy assembly and unmatched braking performance. Carriers fit 2000 and later wheels with hub mounted rotors, for perimeter style rotors (used on '14-Up Touring models and '06-Up Dynas with cast wheels) see the Lyndall rotors in the brake section.

Quick application guide (for exact rotor dimensions for your model refer to your OEM parts guide):

- '00-07 Touring models require 11.5" rotors front and back
- '08-13 Touring models require 11.8" rotors front and back
- '08-Up Dynas with laced wheels require 11.8" rotors front and 11.5" rear rotors



TT Tracker Chrome w/ Crown Cut Silver



TT Tracker Chrome w/ Crown Cut Black



TT Tracker Chrome w/ Smooth Silver



TT Tracker Chrome w/ Smooth Black

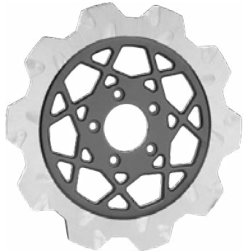

TT Tracker Black w/ Crown Cut Silver



TT Tracker Black w/ Crown Cut Black

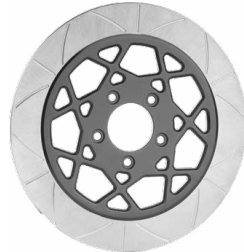

TT Tracker Black w/ Smooth Silver



TT Tracker Black w/ Smooth Black

Description	Crown Cut	Smooth
<b>TT TRACKER FRONT</b>		
Chrome Carrier/Silver Friction Ring 11.5"	<b>576-07700</b>	<b>576-07708</b>
Chrome Carrier/Black Friction Ring 11.5"	<b>576-07701</b>	<b>576-07709</b>
Chrome Carrier/Silver Friction Ring 11.8"	<b>576-07702</b>	<b>576-07710</b>
Chrome Carrier/Black Friction Ring 11.8"	<b>576-07703</b>	<b>576-07711</b>
Black Carrier/Silver Friction Ring 11.5"	<b>576-07704</b>	<b>576-07712</b>
Black Carrier/Black Friction Ring 11.5"	<b>576-07705</b>	<b>576-07713</b>
Black Carrier/Silver Friction Ring 11.8"	<b>576-07706</b>	<b>576-07714</b>
Black Carrier/Black Friction Ring 11.8"	<b>576-07707</b>	<b>576-07715</b>
<b>TT TRACKER REAR</b>		
Chrome Carrier/Silver Friction Ring 11.5"	<b>576-07732</b>	<b>576-07736</b>
Chrome Carrier/Black Friction Ring 11.5"	<b>576-07733</b>	<b>576-07737</b>
Chrome Carrier/Silver Friction Ring 11.8"	<b>576-07740</b>	<b>576-07744</b>
Chrome Carrier/Black Friction Ring 11.8"	<b>576-07741</b>	<b>576-07745</b>
Black Carrier/Silver Friction Ring 11.5"	<b>576-07734</b>	<b>576-07738</b>
Black Carrier/Black Friction Ring 11.5"	<b>576-07735</b>	<b>576-07739</b>
Black Carrier/Silver Friction Ring 11.8"	<b>576-07742</b>	<b>576-07746</b>
Black Carrier/Black Friction Ring 11.8"	<b>576-07743</b>	<b>576-07747</b>