



**20**  
AFTERMARKET CATALOG  
**21**

WHAT DRIVES US, DRIVES YOUR GROWTH™



# WHAT DRIVES US DRIVES YOUR GROWTH

More than a slogan, these words capture the passion our teams have for our business. Fueling our **INNOVATION** are marketing and engineering teams who are focused on their respective categories. Their 24/7/365 focus leads to deeper insights that we use to guide our product development. Our goal is not to develop new products, but to change the consumers' experience and raise their total satisfaction. So we pay attention to every detail, following the purchase triggers through the experience, through the product use which can include installation, use and storage. We aim to address every pinch point the consumer experiences. The higher levels of satisfaction translates into loyalty to our brands and the retailers who carry them when the consumers have another need in that category.

Our market leading positions provide us with vast data, which we mine for insights with state of the art **CATEGORY MANAGEMENT** approaches. Our passion extends to constantly uncovering opportunities to drive incremental growth, optimizing assortments, leveraging packaging and merchandising systems that encourage step-up sales that drive comp growth, and pricing and promotion strategies that strategically lift sales and profits. We call these category management analytics Prophet™ ... where we turn insights into growth.

Our focus on end-users is matched by our focus on satisfying you, our customers. Our seasoned customer service and sales teams are committed to aligning the organization to drive your satisfaction. This extends to our state of the art distribution center in Edgerton, KS. This facility is centrally located and brings all of our products under a single roof. This drives **EFFICIENCY** for you, helping you consolidate ordering across many product lines. This means fewer orders for you, fewer shipments to track and fewer shipments to receive.

We appreciate you. And we appreciate your business. We hope this catalog helps you uncover new ways to grow in the future. We look forward to hearing from you. We will be ready... because what drives us, drives your growth!

Bradley T. Kraft  
President & CEO





# SHIPPING & DISTRIBUTION

Hopkins® industry leading brands ship from three main distribution locations, including our centralized distribution center in Edgerton, Kansas. Hopkins® also offers direct import shipping for products manufactured overseas.



**Edgerton**  
Kansas

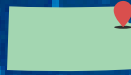

**Miami**  
Oklahoma



**HOPKINS**  
Canada  
**Blenheim**  
Ontario, Canada



## TABLE OF CONTENTS

<b>FEATURED PRODUCTS</b>	4
<b>AUTOMOTIVE AIR CARE</b>	10
ARM & HAMMER™ Air Fresheners	12
<b>CLEANING</b>	20
OXICLEAN™ Vehicle Cleaning	22
AutoSpa™ Premium Cleaning	24
The Detailer's Choice® Everyday Cleaning	32
Tanners' Select® Premium Chamois	46
Pacific Coast™ Dusting & Drying	49
Rain-X® Glass Care	50
Mallory® and Carrand™ Squeegees	52
Merchandising	55
<b>TIRE SAFETY &amp; EMERGENCY</b>	56
Genuine Victor™ Sealants and Inflators	59
Genuine Victor™ Tire Safety	62
<b>PROTECTION &amp; CONVENIENCE</b>	74
Body Glove®	76
Mossy Oak® Licensed Accessories	80
Bell® Seat Covers	82
Never Wet® Seat Covers	84
DGA™ David Gonzalez Art	85
Bell® Steering Wheel Covers	86
Bell® License Plate Frames & Fasteners	90
Bell® GoGear® Storage & Organization	92
GoGear® Sunshades	99
GoGear® Heavy-Duty Floor Mats	102
<b>SPLASH GUARDS</b>	104
<b>AUXILIARY &amp; OFF ROAD LIGHTING</b>	112
Off-Road Lighting & Accessories	114
Auxiliary Lighting	120
Warning & Emergency Lights	128
Fog & Driving Lights	134
Work Lights	136
Reflective Driveway Markers	140
<b>WINTER TOOLS</b>	142
SubZero® & Mallory® Winter Tools	144
Snowbrushes & Snowbrooms	145
Frost & Ice Scrapers	151
Mossy Oak® Licensed Winter Tools	155
Pink Tools & Accessories	156
Merchandising	157
<b>FLUID MANAGEMENT</b>	158
Ramps	160
Wrenches	162
Extractors	164
Drains	166
Funnels	168
Siphons & Pumps	171
Absorbents & Squeegees	174
Merchandising	178
<b>SAFETY ACCESSORIES</b>	180
Trailer Rearview Camera	182
Vehicle Hitch Camera	184
Animal Alerts	185
<b>DIY ORGANIZATION</b>	188
<b>HOPKINS TOWING SOLUTIONS®</b>	192
Index	194
<b>CONTACT &amp; SUPPORT</b>	199



# NEW PRODUCTS FOR 2021



## REV UP SALES WITH IMPULSE & LIFESTYLE

These items are manufactured, marketed and distributed by Hopkins Manufacturing Corporation. The ARM & HAMMER trademarks are owned by Church & Dwight Co., Inc., and are used by Hopkins Manufacturing Corporation under license.



**AMERICANA BREEZE** | PAGE 12  
**Flag Vent Clip**  
AH8271AB

**Island Breeze** | PAGE 15  
**3-D Novelty Air Freshener**  
Multiple Parts



**EcoFresh Vent Clip** | PAGE 15  
**Air Freshener**  
Multiple Parts



**GEARHEAD™ Vent Sticks** | PAGE 13  
**Car Air Fresheners**  
AH7100NEC



**OXICLEAN™ Fabric-Shield™ Water** | PAGE 22  
**and Stain Protectant Spray**  
57213OC

**OXICLEAN™ Total Interior™ Floormat** | PAGE 22  
**& Carpet Cleaner with Odor Blaster**  
57205OC

**OXICLEAN™ Pet-Stain Plus™** | PAGE 23  
**and Odor Remover**  
57214OC



This item is manufactured, marketed, and distributed by Hopkins Manufacturing Corporation. The OXICLEAN and Odor Blaster trademarks are owned by Church & Dwight Co., Inc., and are used by Hopkins Manufacturing Corporation under license.

# STEP SHOPPERS UP TO PREMIUM SOLUTIONS

**AUTOSPA™**  
LUXURY CAR CARE



**50 ft. Flex-Flow Car Wash Hose**  
90068AS

PAGE  
**30**



**Grab & Trap 4-Pack Duster Set**  
94026AS

PAGE  
**29**



**SPEED-BRUSH™ 4-Piece Drill Brush Set**  
94208AS

PAGE  
**29**



# BODY GLOVE



BODY GLOVE, and the BODY GLOVE logo are trademarks of Marquee Brands, and are used under license by Hopkins Manufacturing Corporation

**Body Glove® BG Original License Plate Frame**  
22-1-46728-8

PAGE  
**78**

**Body Glove® Premium Seat Cover Collection**  
Multiple Part Numbers

PAGE  
**77**



**MOSSY OAK®**



**HYPERFIT™ GRIP LOCK  
WITH DRAWSTRING**  
FOR AN EASY AND SECURE  
FORM FITTING SEAT COVER

**MOSSY OAK® Premium Quality  
Seat Covers**

Multiple Part Numbers

**PAGE  
81**

# PRODUCTS TO STAND OUT WHILE BLENDING IN



**MOSSY OAK® Durable  
Interior Organization and  
Protection Collection**

Multiple Part Numbers

**PAGE  
81**

MOSSY OAK, and the MOSSY OAK logo are trademarks of Haas Outdoors, Inc., and are used under license by Hopkins Manufacturing Corporation



# FLEX ON THE COMPETITION

**BELL® Flex Core™  
Steering Wheel  
Covers**

Multiple Part Numbers

PAGES

**88-89**





**RoadSport®**



**KEEP ROAD DEBRIS  
WHERE IT BELONGS**

RoadSport® Splash Guard  
Collection  
Multiple Part Numbers

PAGES  
107-110

# SHINE A LIGHT ON HIGHER PROFITS



Magnetic LED Warning Light Bar  
with Automatic Heated Lens  
C4850CACH

PAGE  
129



Blazer® HiDef Light Series  
Multiple Part Numbers

PAGES  
116-117



**SUBZERO**<sup>®</sup>  
SNOW AND ICE TOOLS

# THE POWER TO MAKE ICE DISAPPEAR

**POWER  
FORCE**<sup>™</sup>

Power Force<sup>™</sup> Snow Brushes,  
Broom and Scraper Collection |  
Multiple Part Numbers

PAGE  
147



# ICE & SNOW HAVE GOT TO GO



Customizable  
Boot Tray  
12555

PAGE  
154





OXI-CLEAN™ Winter  
Salt Eraser  
572100C

PAGE  
154

# PUT WINTER ON A LOW SODIUM DIET

This item is manufactured, marketed, and distributed by Hopkins Manufacturing Corporation. The OXICLEAN trademarks are owned by Church & Dwight Co., Inc., and are used by Hopkins Manufacturing Corporation under license.



# DIY DONE RIGHT



**L-Shaped Work Bench  
Kit with Shelf Links®** | PAGE  
188  
90162ONLMI



**L-Shaped Work Bench** | PAGE  
188  
90165ONLMI

# AN ECO-FRIENDLY APPROACH TO NEW PROFITS



RIVETING BRANDS TO MEET YOUR SHOPPERS' NEEDS

# AUTOMOTIVE AIR CARE

## DRIVING INNOVATION

Products that transform the consumer experience

## ODOR ELIMINATION

Bad odors are the #1 purchase trigger for automotive air fresheners. That is why we incorporated patented odor elimination technology, with fragrances infused with essential oils

## A FRESH MESSAGE

Clean, strikingly modern and easy-to-read packaging, eliminates the confusion and simplifies the shopping experience





# CAR AIR FRESHENERS

When your shoppers hear the name ARM & HAMMER™... they also hear odor elimination

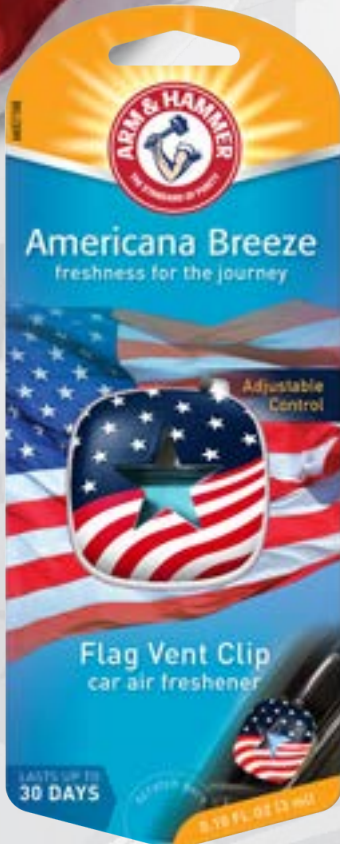

## A Star is Born

### Flag Vent Clip

- The #1 selling format
- Odor elimination technology
- Refreshing long lasting fragrance

Flag Vent Clip - AH8271AB - 1 pk, 12 pcs. Open Stock

AUTOMOTIVE AIR CARE



These items are manufactured, marketed and distributed by Hopkins Manufacturing Corporation. The ARM & HAMMER™ and Clean Burst trademarks are owned by Church & Dwight Co., Inc., and are used by Hopkins Manufacturing Corporation under license.



# REV UP TARGETED SHOPPERS

With GEARHEAD™ AIR FRESHENERS



## GEARHEAD™ Vent Clips Car Air Fresheners

- Innovative designs inspired by car enthusiasts
- Clever and cool designs to clip on vent
- Available in Classic New Car

**Gear Vent Clip - AH7000G** - 1 pk, 12 pcs. Open Stock

**V-Twin Vent Clip - AH7000V** - 1 pk, 12 pcs. Open Stock

**Vent Clip - AH7000T** - 1 pk, 12 pcs. Open Stock



## MADE FOR GUYS THAT LOVE THEIR RIDE



## GEARHEAD™ Vent Sticks Car Air Fresheners

- Innovative product inspired by car enthusiasts
- Cool and clever design to clip on to vent
- Available in Classic New Car

**GEARHEAD™ Vent Stick - AH7100NEC** - 2 pk, 12 pcs. Open Stock



# DIAL UP CONSUMER NEEDS

The first car air freshener with  
60 days of on demand freshness

## Vent Clip - Scent Spinner™

- Groundbreaking scent technology
- Fragrance scented beads for a steady flow of aroma
- Spin dial for an extra burst of freshness

**Great Outdoors - AH8601G0** - 1 pk, Open Stock

**Black Sea - AH8601BLS** - 1 pk, Open Stock

**Cabana Breeze - AH8601CA** - 1 pk, Open Stock

SPIN FOR A BURST OF FRESHNESS





**NEW**

### Island Breeze 3-D Novelty

- Style and scent to enjoy your ride
- Fun Island inspired designs to hang from mirror
- Double-sided artwork

**Surf - AH8001SU** - 1 pk, 12 pcs. Open Stock  
**Tiki - AH8001TK** - 1 pk, 12 pcs. Open Stock



**NEW**

### EcoFresh Vent Clip

- Let nature fight off unwanted smells
- Absorbs odors, releases fresh fragrances
- Designed with blends of natural materials
- Up to 30 days of freshness

**Summer Escape - AH8601SE** - 12 pcs. Open Stock  
**Garden Bloom - AH8603GB** - 12 pcs. Open Stock  
**Island Reef - AH8603IR** - 12 pcs. Open Stock



**NEW**

### Adjustable Vent Sticks

- Innovative release of New Car fragrance
- Pull tip out to release a boost of fresh aroma
- Odor elimination technology
- Slides easily onto all vents

**New Car - AH7161NEC** - 4 pk, 12 pcs. Open Stock



# BREATHING NEW LIFE INTO LONG LASTING FRESH FRAGRANCES

Patented Odor Elimination Technology and Fragrances Infused with Essential Oils

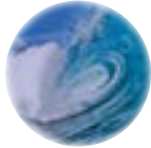

## BLACK SEA

A fusion of amber and vanilla for a sweet yet salty oceanic fragrance with a hint of citrus, ozone and dark musk



## CABANA BREEZE

Colorful blends of coconut, peony and jasmine create an aroma of lush coastal florals

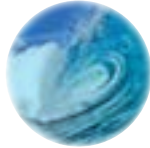

## CLEAN BURST™

Nature's garden with hints of jasmine and lilac

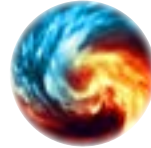

## FIRE & ICE

Fresh fruity notes combined with spices and hints of woody elements

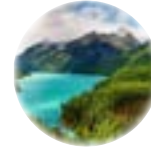

## GREAT OUTDOORS

Notes of tropical fruits and sugared citrus for a clean outdoor scent



## LEMON GRASS

Spunky lemon and rose musk, hints of orange and vanilla. A beautiful herbal fragrance



## MIDNIGHT

Intoxicating fusion of musk, patchouli and sage



## MORNING MIST

Top notes of pear, green melon and mandarin, with jasmine and floral aromas



## NEW CAR

Reviving freshness with sandalwood and lemon



## PARADISE

A gateway to an ocean breeze

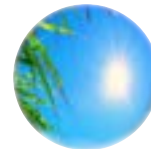

## SEASIDE FRESH

Outdoor freshness with lemons, pines and pure scents of violets and rose



## SONORA

Sweet floral desert scent of cactus blooms, a Southwest favorite!



## SPRINGTIME

Fresh outdoor aromas of meadows and pine



## SUNRISE

Awake your senses with a synergy of aromas featuring sea salt, jasmine and white musk



## TAHITI ORCHID

Rich floral island aromas, jasmine and rose pedals



## TROPICAL

An oasis of fresh pineapple, mango and coconut



## VOLCANO

Woody pine with aromatic cedar leaf, natural fir needle and sweet jasmine



## WATER LILY

Fresh, lightly sweet with a hint of lemon



## AMERICANA BREEZE

Lush scents of green meadows and rolling hills with hints of summer florals



## ISLAND BREEZE

Charming blends of floral notes, coconut and hints of sea salt

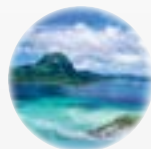

## SUMMER ESCAPE

A calming blend of lavender, violet, sage and spring blossoms, alluring cashmere, wood and vanilla

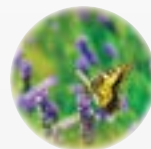

## GARDEN BLOOM

A delicate blend of fresh cut rose, lily and gardenia mingled with sheer musky accord

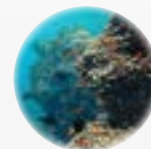

## ISLAND REEF

Refreshing fusion of patchouli with a hint of cucumber freshness infused with white floral heart and summer moss







### Vent Clip - Gear Shift

- Control the fragrance level with these decorative gear shifts
- New fragrances and styles to meet your personality
- Black carbon fiber design or solid gun metal black

**Linen Breeze** - AH8351LB - 1 pk, 0.14 oz., 12 pcs. Open Stock  
**Seaside Fresh** - AH8351SF - 1 pk, 0.14 oz., 12 pcs. Open Stock  
**Citrus Squeeze** - AH8351CS - 1 pk, 0.14 oz., 12 pcs. Open Stock  
**Classic New Car** - AH8251CNC - 1 pk, 0.14 oz., 12 pcs. Open Stock



### Vent Clip

- Vented front panel allows for full air flow
- Fully adjustable for fragrance control
- Easy to use

**New Car** - AH8200NEC - 1 pk, 0.14 oz., 12 pcs. Open Stock  
**New Car** - AH8202NEC - 2 pk, 0.14 oz. each, 12 pcs. Open Stock  
**Springtime** - AH8200SPT - 1 pk, 0.14 oz., 12 pcs. Open Stock  
**Springtime** - AH8202SPT - 2 pk, 0.14 oz. each, 12 pcs. Open Stock  
**Clean Burst™** - AH8200CB - 1 pk, 0.14 oz., 12 pcs. Open Stock  
**Clean Burst™** - AH8202CB - 2 pk, 0.14 oz. each, 12 pcs. Open Stock



### Vent Clip - Camo

- Eye-catching designs for the outdoor enthusiasts
- Fully adjustable for fragrance control
- Easily clips onto any car vent

**Midnight** - AH8221MID - 1 pk, 0.14 oz., 12 pcs. Open Stock  
**Midnight** - AH8220MID - 2 pk, 0.14 oz. each, 12 pcs. Open Stock  
**Clean Burst™** - AH8241CB - 1 pk, 0.14 oz., 12 pcs. Open Stock  
**Clean Burst™** - AH8240CB - 2 pk, 0.14 oz. each, 12 pcs. Open Stock  
**Sunrise** - AH8231SUN - 1 pk, 0.14 oz., 12 pcs. Open Stock  
**Sunrise** - AH8230SUN - 2 pk, 0.14 oz. each, 12 pcs. Open Stock



### Vent Clip - Island Leaf

- Inspired by a casual beach scene
- Traditional vent clips with adjustable fragrance control
- Easily clips onto any car vent

**Tropical** - AH8266TR - 1 pk, 0.14 oz., 12 pcs. Open Stock  
**Tropical** - AH8265TR - 2 pk, 0.14 oz. each, 12 pcs. Open Stock  
**Paradise** - AH8261PAR - 1 pk, 0.14 oz., 12 pcs. Open Stock





### Vent Clip - Pets

- Pet friendly fragrances
- Style and scents to enjoy your ride
- Easily clip onto any car vent

**Lemongrass - AH8200PAWSRB** - 2 pk, 0.14 oz. each, 12 pcs. Open Stock  
**Morning Mist - AH8200PAWSMY** - 2 pk, 0.14 oz. each, 12 pcs. Open Stock  
**Sonora - AH8263SUN** - 2 pk, 0.14 oz. each, 12 pcs. Open Stock



### Vent Clip - Blossom

- Floral designs to freshen the mood
- Fully adjustable fragrance control
- Odor elimination technology

**Morning Mist - AH8800SUN** - 1 pk, 0.14 oz., 12 pcs. Open Stock  
**Springtime - AH8800SPT** - 1 pk, 0.14 oz., 12 pcs. Open Stock  
**Tahiti Orchid - AH8800TO** - 1 pk, 0.14 oz., 12 pcs. Open Stock  
**Water Lily - AH8800WL** - 1 pk, 0.14 oz., 12 pcs. Open Stock



### Decorative Air Fresheners - Scent Catcher

- A beautiful, hand-crafted decoration to catch sunshine and moonlight
- Releases a gentle fragrance of fresh aromas for up to 30 days
- Hangable air freshener

**Springtime - AH8000SPT** - 0.10 oz., 12 pcs. Open Stock  
**Clean Burst™ - AH8000CB** - 0.10 oz., 12 pcs. Open Stock  
**Seaside Fresh - AH8000SF** - 0.10 oz., 12 pcs. Open Stock



### Vent Clip - Boost™

- Groundbreaking scent technology
- Powered with a built-in heat source to release a fine mist of fresh fragrance
- Delivers a continuous fragrance flow while eliminating odors

**New Car - AH8710NEC** - 1 pk, 0.14 oz., Open Stock



These items are manufactured, marketed and distributed by Hopkins Manufacturing Corporation. The ARM & HAMMER™ and Clean Burst trademarks are owned by Church & Dwight Co., Inc., and are used by Hopkins Manufacturing Corporation under license.



### Vent Clip - Surface™

- Sleek new design for instant freshness
- Discreetly place by sliding onto any vent
- Lasts up to 30 days

**Volcano - AH8100VOL** - 2 pk, 0.14 oz., 12 pcs. Open Stock  
**Fire and Ice - AH8100FI** - 2 pk, 0.14 oz., 12 pcs. Open Stock  
**Great Outdoors - AH8100GO** - 2 pk, 0.14 oz., 12 pcs. Open Stock



### Under-The-Seat Gel

- Scented gel will not shrink or melt
- Hide-able sturdy container
- Great for auto, home and office

**Springtime - AH8500SPT** - 3 pk, 12 pcs. Open Stock  
**New Car - AH8500NEC** - 3 pk, 12 pcs. Open Stock  
**Clean Burst™ - AH8500CB** - 3 pk, 12 pcs. Open Stock



### Gel Air Freshener

- Slide lever allows for full fragrance control
- See-through container
- Long-lasting gel will shrink for end of life alert

**New Car - AH8300NEC** - 1 pk, 4.5 oz., 12 pcs. Open Stock  
**Springtime - AH8300SPT** - 1 pk, 4.5 oz., 12 pcs. Open Stock  
**Clean Burst™ - AH8300CB** - 1 pk, 4.5 oz., 12 pcs. Open Stock

## MERCHANDISING OPTIONS

Various Off-Shelf Displays to Attract Your Shoppers

Please Contact Your Sales Rep for Additional Displays Available





# **CLEANING UP THE CATEGORY WITH INSIGHT AND INNOVATION**

**POWERFUL INNOVATION THAT DRIVES THE CATEGORY**



# VEHICLE CLEANING

## CATEGORY EXPERTISE

Our industry leading position is the result of our experience and focus. We are committed to quality and the development of "first-in-feature" ideas

## POWERFUL CLEANING TECHNOLOGY

Combining superior design, quality and value with professional grade materials has taken car washing to a whole new level of finish

## BRANDED INNOVATIONS

Bring your vehicle cleaning to a whole new level of cleaning with our innovative products that separate us from other competitors

**AUTOSPA**  
LUXURY CAR CARE

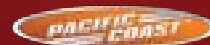

# OXI CLEAN

## CAR CARE SOLUTIONS

**IT'S NOT CLEAN  
TIL IT'S OXICLEAN!™**

*Recognized and Trusted Brand*

**TOOLS THAT TAKE CLEAN  
TO ANOTHER LEVEL**



**NEW**

### Fabric-Shield™ Water and Stain Protectant Spray - 10 oz.

- Precise spray nozzle
- 360 degree complete coverage
- Ergonomic paddle trigger
- Great for carpet, upholstery, fabric, vinyl and leather

572130C - 6 pcs. Open Stock



### OXICLEAN™ Total Wash™ 3-in-1 Technology Ultimate Wash Pad

- Triple action design
- Total body cleaning

440010C - 6 pcs. Open Stock



### OXICLEAN™ Tight-Spot™ 3-in-1 Technology Plunge and Scrub Tool

- Flexible easy reach design
- Hard to clean areas

440020C - 6 pcs. Open Stock



### OXICLEAN™ Scrub-Tuf™ Ultimate Scrub Sponge

- Clear coat safe
- Scrubs stubborn spots and stuck on debris
- Softens and flexible when wet

• 440030C - 8 pcs. Open Stock



### OXICLEAN™ Spin Clean™ 3-in-1 Car Wash System

- Hybrid wash head with soft bristles and washable microfiber bonnet
- Patented

933300C - 2 pcs. Open Stock



### OXICLEAN™ Total Wash™ Foaming Car Wash Sprayer

- Pro-Foam spray tip
- On/Off soap control
- Lever water control
- Hose connector

922320C - 4 pcs. Open Stock



### OXICLEAN™ Total Interior™ Floormat & Carpet Cleaner with Odor Blaster - 19 oz.

- Bi-Level brush design
- Heavy-duty formula with odor blaster
- Spot scrubber
- Groove cleaning tool

572050C - 6 pcs. Open Stock



# ODOR BLASTING TECHNOLOGY

ELIMINATES ODORS AND FRESHENS EVERYWHERE YOU NEED THE MOST



## OXICLEAN™ Total Interior™ Cabin & Air Vent Cleaner

- Odor Blasters™ technology resonates with the shoppers need to drive odors out!
  - Great for smoke, mildew, sweat, grocery and pet odors
  - Leaves a clean fresh scent
- 572170C** - 6 pcs. Open Stock



## OXICLEAN™ Total Interior™ Rapid-Refresh Spray - 15 oz.

- Quickly eliminates odors
  - Great for smoke, mildew, sweat, grocery and pet odors
  - Leaves a clean fresh scent
- 572040C** - 6 pcs. Open Stock



## OXICLEAN™ Pet-Stain Plus™ and Odor Remover - 15 oz.

- Powerful jet spray
  - Integrated spray lock
  - Lifting foam formula
  - Clean fresh scent
- 572140C** - 6 pcs. Open Stock



Bi-Level Brush Cap

## OXICLEAN™ Total Interior™ Carpet & Upholstery Cleaner - 19 oz.

- Stiff sweeping bristles
  - Flexible scrubbing bristles
  - Spot spray nozzle
  - Side grip scallops
- 572000C** - 6 pcs. Open Stock



Dual-Matrix™ Technology

## OXICLEAN™ Total Interior™ Multi-Purpose Cleaning Wipes™

- 2-in-1 scrub and clean
  - Scrubbing fibers reach deep into surfaces
  - Smooth fibers wipe areas clean
  - Made for big jobs
- 440050C** - 30 pk, 2 pcs. Open Stock  
**440040C** - 50 pk, 2 pcs. Open Stock

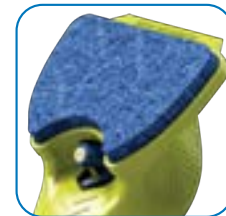

2-in-1 Scrub Cap

## OXICLEAN™ Clear View™ Glass & Mirror Cleaner - 19 oz.

- Poly-matrix scrub pad
  - Top side spot scraper
  - Side grip scallops
  - Drip catch ribbing
- 572020C** - 6 pcs. Open Stock

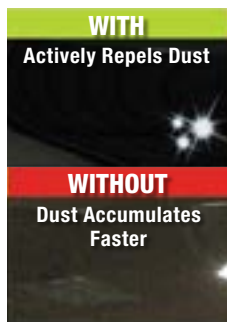

## OXICLEAN™ Out-Shine™ Ultra Foaming Car Wash - 64 oz.

- Anti-static formula keeps your car cleaner longer
  - PH balanced ultra-foaming
  - Adds shine and protection
- 571640C** - 6 pcs. Open Stock



## OXICLEAN™ Total Wash™ Foaming Car Wash

- Soaks, softens, and lifts stuck on dirt and debris
  - PH balanced ultra-foaming
  - Won't remove wax
- 571000C** - 100 oz., 4 pcs. Open Stock



One-Pass Sprayer

## OXICLEAN™ Complete Wheels™ Wheel & Tire Cleaner - 16 oz.

- Integrated One-Pass™ nozzle
  - 360 degrees complete coverage
  - Ergonomic paddle trigger
  - Side grip scallops
- 572010C** - 6 pcs. Open Stock



## POWERED CAR CARE... *Better by Design*

### Random Orbital Polishers

- Low vibration, heavy-duty motor
- Integrated Multi-Grip™ for reaching and less fatigue
- 3-Layer buffing wheel with visible moisture barrier



### 6" Professional Polisher 120v Variable Speed Random Orbital

- Heavy-duty 2500 to 5000 rpm - 120v motor ETL approved
- 3-layer foam pad with moisture barrier
- Includes foam applicator bonnet, microfiber removal bonnet and wool fine-shine bonnet

94009AS - 2 pcs. Open Stock

### PRO POWER

42% faster than standard orbital polishers. Maximizes versatility for a wide range of chemical applications



### PRO CONTROL

Electronic throttle for precision motor speed control from 2500 to 5000 rpm to deliver power where and when needed



### PRO QUALITY



### PRO RESULTS



### 10" Random Orbital Polisher with Bonus Bonnets

- Heavy-duty 3600 rpm-120v motor ETL approved
- 3-layer foam pad with moisture barrier
- Includes foam applicator bonnet and microfiber removal bonnet

94001AS - 1 pc. Open Stock



### 6" Random Orbital Polisher with Bonus Bonnets

- Heavy-duty 3500 rpm-120v motor ETL approved
- 3-layer foam pad with moisture barrier
- Includes foam applicator bonnet and microfiber removal bonnet

94000AS - 2 pcs. Open Stock



in Action

### Auto-Vac 120v Bagless Vacuum

- Heavy-duty 560 watt, 120v motor ETL approved
- Professional in-line air flow design
- Includes carpet, console, crevice and blower tools with handy on-board storage

94005AS - 4 pcs. Open Stock



# Sonic-Shine Powered Detailer™

Bring vehicle cleaning and detailing to a whole new level of finish

- Triangular design for superior ergonomics
- Thousands of vibrations per second
- Power surface treatments into the tiniest areas of the vehicle

Omnidirectional vibrations reduce surface tension and make the task quicker and easier. Polish and shine accessory sales with a high tech step-up solution

## Sonic-Shine Powered Detailer™

94110AS - 4 pcs. - Open Stock



### 3-Pack Microfiber Wax & Polish Applicator Pads

- Applies faster and saves time
- Plush microfiber applies paste or liquid waxes and sealants evenly
- Removes with less effort
- Penetrates all parts of the vehicles' finish

45652AS - 3 pk Foam Pads, 6 pcs. Open Stock



### 1-Pack Scratch Removal and Compound Pad

- Aids in removing light scratches and blemishes
- Faster results when using compounds and polishes
- Safe on all vehicle finishes

45651AS - 1 pk Applicator Pad, 12 pcs. Open Stock



### 1-Pack Synthetic Wool Polishing Bonnet

- Elastic edge keeps bonnet snug
- Extra soft for buffing and finish polishing
- Excellent for final buffing to shine

40405AS - 9-10" Wool Bonnet, 12 pcs. Open Stock

40404AS - 7-8" Wool Bonnet, 12 pcs. Open Stock

40403AS - 5-6" Wool Bonnet, 12 pcs. Open Stock

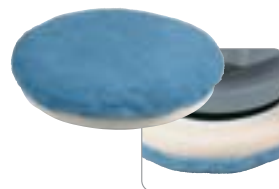

### 2-Pack Microfiber Polishing Bonnet

- Elastic edge keeps bonnet snug
- Premium soft microfiber for removing and polishing
- Excellent for waxes and polishes

40408AS - 9-10" Microfiber Bonnet, 12 pcs. Open Stock

40407AS - 7-8" Microfiber Bonnet, 12 pcs. Open Stock

40406AS - 5-6" Microfiber Bonnet, 12 pcs. Open Stock



### 1-Pack Foam Application Bonnet

- Elastic edge keeps bonnet snug
- Smooth for professional even application
- Excellent for waxes, polishes and compounds

40411AS - 9-10" Foam Bonnet, 12 pcs. Open Stock

40410AS - 7-8" Foam Bonnet, 12 pcs. Open Stock

40409AS - 5-6" Foam Bonnet, 12 pcs. Open Stock



### Cotton Terry Application Bonnet

- Elastic edge keeps bonnet snug
- Soft for applying and removing
- Excellent for waxes and polishes

45401AS - 9-10" 6 pk Cotton Bonnet, 6 pcs. Open Stock

40402AS - 9-10" 2 pk Cotton Bonnet, 12 pcs. Open Stock

40401AS - 7-8" 2 pk Cotton Bonnet, 12 pcs. Open Stock

40400AS - 5-6" 2 pk Cotton Bonnet, 12 pcs. Open Stock

**Long Pole Leader  
Through Features  
and Performance**



**LOCKING HEAD**



**ABS COMPONENTS**



**HARDENED ALUMINUM**



**POLE LOCKING NUT**



**PRESS-FIT CONNECTIONS**



**SLIDE WATER CONTROL**

**Professional Flow-Thru<sup>™</sup>  
And Dip Brushes**

This premium accessory market leader helps create step up opportunities to maximize your planogram profits



**Bucketless Car  
Wash Solutions**

Bucketless car wash solutions continue to gain marketplace momentum by making it easier than ever to clean passenger and family vehicles. Using our patented on-board soap mixing system with integrated on/off soap control; the bucketless car wash solutions family is the fastest route to a clean vehicle anywhere



On-board soap-mixing chamber



Integrated on/off control



**FLOW-THRU<sup>™</sup>**

**10" Quad Head Wash Brush Extends to 71"**

- All-sided quad brush cleans all surfaces easily and quickly
- Telescoping pole with no-spin locking head
- Slide on/off water control

93072- 6 pcs. Open Stock



**FLOW-THRU<sup>™</sup>**

**10" Bi-Level Wash Brush Extends to 71"**

- Super soft bi-level brush head with fan spray rinse
- Telescoping pole with no-spin locking head
- Slide on/off water control

93097A - 6 pcs. Open Stock

93097D - 12 pcs. Floor Display



**FLOW-THRU™**  
**10" Quad Soap Mixing Brush**  
 Extends to 55"

- All-sided quad soap brush cleans all surfaces easily and quickly
- Telescoping pole with no-spin locking head
- On/Off control allows for minimal water usage

93977 - 6 pcs. Open Stock



**Suds-N-Spray**  
**Foaming Wash System™**

- Patented exclusive design supercharges any car-wash soap into a professional foam
- Heavy-duty plastic construction with removable Clean-Rinse Nozzle™ Grip

92230 - 2 pcs. Open Stock



**Wash-Jet™ Power Wand**

- Easily fills with any car wash soap
- Mixes soap and water automatically - no bucket needed
- Molded rubber protective spray tip, trigger lock and hose swivel control

92215 - 6 pcs. Open Stock



**FLOW-THRU™**  
**10" Suds-N-Go™ Bi-Level Wash Brush**  
 Extends to 71"

- Bi-level soap brush with rubber bumpers
- Telescoping pole with no-spin locking head
- Slide on/off water control

93984 - 6 pcs. Open Stock

93984D - 12 pcs. Floor Display



**Wash-Jet™ Power Wand with**  
**Microfiber Wash Pad**

- Easily fills with any car wash soap
- Mixes soap and water automatically - no bucket needed
- Pivoting microfiber wash pad

92216 - 6 pcs. Open Stock



**Wash-Jet™ Power Wand with**  
**3-Way Adjustable Nozzle**

- Easily fills with any car wash soap
- Mixes soap and water automatically - no bucket needed
- 3-Way adjustable nozzle

92217 - 6 pcs. Open Stock



**MICROFIBER MAX™**  
**Microfiber Chenille Wash Mop**  
 Extends to 48"

- Extra absorbent long chenille microfiber wash bonnet
- Telescoping pole
- Wash glove can be removed from pole for professional hand car wash

93303 - 6 pcs. Open Stock



**9-Pattern Adjustable Spray Nozzle**

- Pro-grade aluminum and brass construction
- Durable powder-coated finish
- Comfort molded TPR grip for superior ergonomics
- Integrated trigger lock ring

90064AS - 3 pcs. Open Stock



**Adjustable Jet Spray Nozzle**

- Pro-grade aluminum and brass construction
- Durable powder-coated finish
- Comfort molded TPR grip for superior ergonomics
- Integrated trigger lock ring

90065AS - 3 pcs. Open Stock



## Hand Tool Innovations Get a Grip on Cleaning Quality Inside & Out

**GRIP TECH™**

AutoSpa™ Professional Hand Brushes with patented Grip-Tech™ technology bring high-tech design to the hand brush segment



**GRIP TECH™**  
**Deluxe Body Brush**

- Soft bristles clean wheels, fender and body
- Side protective bumper
- Soft rubber handle for comfort and function

92025 - 6 pcs. Open Stock



**GRIP TECH™**  
**Deluxe Tire & Bumper Brush**

- Stiff bristles clean bumper, grill and tire
- Soft rubber handle for comfort and function
- Side protective bumper

92036 - 6 pcs. Open Stock



**GRIP TECH™**  
**Deluxe Contoured Tire Brush**

- Contours to tire shape
- Soft rubber handle for comfort and function
- Can attach to any standard pole

92014 - 6 pcs. Open Stock

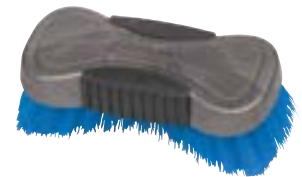

**GRIP TECH™**  
**Deluxe Tire Brush**

- Stiff bristles designed for tires
- Soft rubber handle for comfort and function
- Contours to tire shape

92011 - 6 pcs. Open Stock



**GRIP TECH™**  
**Deluxe Wheel & Brake Dust Brush**

- Strong scour pad action removes brake dust from wheel
- Outer soft bristles clean wheels, while protecting the new wheel finish
- Soft rubber handle for comfort and function

92012 - 6 pcs. Open Stock



**GRIP TECH™**  
**Deluxe Double Loop Wheel Brush**

- Patented mount design holds bristles
- Soft rubber handle for comfort and function
- Two separate durable bristle loops for complete cleaning

92010 - 6 pcs. Open Stock



**GRIP TECH™**  
**Deluxe Interior Brush**

- Super stiff bristles to remove dirt from carpet or upholstery
- Flared bristles for hard to reach areas
- Soft rubber handle for comfort and function

92018 - 6 pcs. Open Stock



**Bend & Wash™ Wheel Cleaner**

- 2-in-1 premium microfiber
- Built-in Bend & Wash™ core for hard-to-reach areas
- Bendable and safe on all surfaces
- 3D scrubbing mesh removes brake dust and debris

97373AS - 6 pcs. Open Stock

# Professional Specialty Cleaning Tools



## Cleaning Wheels Has Never Been Easier

### WHEEL-BOSS™

Professionally inspired wheel cleaning that reaches places other brushes can't!



#### Wheel Boss™

- Pivoting design reaches places other brushes can't
- Easy-reach wheel brush
- Quick and easy plunge and scrub cleaning

94021AS - 4 pcs. Open Stock



#### GRIP-TECH™

#### Deluxe Dust Pan & Broom

- Wide basin dust pan with rubber edge
- Super stiff bristles for easy cleaning
- Soft rubber handle for comfort and function

92034 - 6 pcs. Open Stock



#### 4-Pack Grab & Trap Duster Set

- Attracts and traps dust particles
- Easily dust all interior areas
- Compact, folding design
- Comfort grip with hang loop

94026AS - 6 pcs. Open Stock



#### SPEED-BRUSH™ 4 pc. Drill Brush Set

- Compact for interior and exterior jobs
- Tough scrubbing
- Spot cleaning
- Works with any drill

94208AS - 4 pcs. Open Stock



#### SPEED-BRUSH™ 2 pc. Drill Brush Set - Carpet & Interior

- Soft scrub edge design
- Corrosion resistant zinc plating
- Medium stiff fibers
- Quick change shaft

94210AS - 6 pcs. Open Stock



#### Deluxe Detail Brush Set

- Soft nylon brush for hard to reach areas
- Tough brass for cleaning battery terminals and spark plugs
- Stainless steel for body and bumper rust

92004 - 12 pcs. Open Stock



#### 2-in-1 Electrostatic Detail Brush

- Electrostatic charge picks up dust
- Vent duster brush

92049 - Detail Brush, 12 pcs. Open Stock



#### MICROFIBER MAX™

#### Body Shine Dusting Wand

- 20" extended reach
- Plush microfiber strands grab and hold surface dust
- Washable and completely reusable
- Cleans car without water and safe on all auto finishes

97370AS - 6 pcs. Open Stock



#### MICROFIBER MAX™

#### Inside Shine Interior Duster

- Pulls dust from interior surfaces
- Lint free interior dusting
- Keep in car, take anywhere

97372AS - 6 pcs. Open Stock

## MICROFIBER MAX™

### Premium Materials Take Car Care To a Whole New Level of Finish

#### Luxury Chenille Fibers

build suds for a professional wash

#### Plush Deep Pile Fibers

lift and carry away dirt & debris

#### Poly-Mesh™ Netting

removes bugs, tar and surface deposits

#### Luxury Satin Edging

will not snag on wipers, trim or emblems



#### Sheepskin Wash Mitt

- 92% Sheepskin (Mitt); 8% Polypropylene (Cuff)
- Super deep genuine sheepskin lifts dirt from surface
- Perfect polishing mitt when used dry
- Elastic cuff keeps mitt snug

40305A - 6 pcs. Open Stock



#### MICROFIBER MAX™

#### Microfiber Chenille Wash Pad

- Professional detailing
- Easy to grab and wash
- Microfiber super suds maker holds more soap and water

45133 - 6 pcs. Open Stock



#### MICROFIBER MAX™

#### Suds-N-Scrub™ Microfiber 2-in-1 Chenille Wash Pad

- Professional detailing
- Easy to grab and wash
- Microfiber scrub netting safely cleans tough spots and debris

45135 - 6 pcs. Open Stock



#### MICROFIBER MAX™

#### Total Clean All-Over Body Mitt™

- 4-in-1 waterproof wash mitt
- Suds-maker luxury chenille fibers
- Scratch and lint free professional wash
- Elastic cuff keeps mitt snug

45602AS - 12 pcs. Open Stock



#### MICROFIBER MAX™

#### Premium Body Sponge

- 2-Sided scrub and wash design
- Plush deep pile fibers for a professional wash
- Poly-Mesh™ netting gently scrubs
- Heavy-duty foam sponge core

45604AS - 12 pcs. Open Stock



#### 50 ft. Flex-Flow Car Wash Hose

- Soft touch design
- Easy on / easy off swivel-grip connector
- Heavy-duty firehose style construction
- Professional metal ends

90068AS - 4 pcs. Open Stock

# Premium Detailing Accessories

Soft, Absorbent, Versatile...

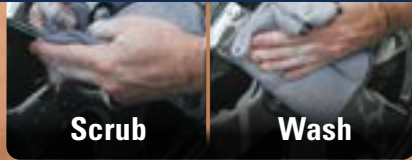

Scrub

Wash



Clean

Dry

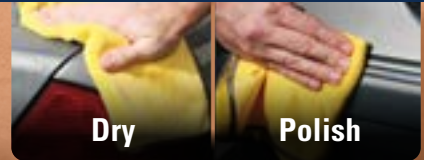

Dry

Polish

GLASS | BODY | WHEEL



MICROFIBER MAX™

### Supreme Drying Towel

- Super large 5.5 sq. ft. size dries more area faster (22" x 36")
- Scratch, lint and streak free microfiber
- Holds 7 times its weight in water and cleans as it dries
- No snag satin edging

40059AS - 6 pcs. Open Stock



MICROFIBER MAX™

### Soft Touch Detailing Towel

- 2-Sided towel for interior and exterior dusting, polishing and detailing (16" x 18")
- Plush deep pile luxury fibers
- Scratch and lint free detailing
- No chemicals needed

45606AS - 12 pcs. Open Stock



MICROFIBER MAX™

### Quick-Clean Essential Microfiber Towel, 3 Pack

- Clean Towel: 2-Sided scrub & wash
- Dry Towel: 2-Sided super absorbent
- Polish Towel: 2-Sided buff & shine
- No snag satin edging (14" x 14")

45646AS - 12 pcs. Open Stock

### Spa-Soft Detailing Towels, 6 Pack

- 100% polyester microfiber is ultra plush and has a luxury feel from the shelf (12" x 16")
- Premium HYDRO-MAX™ treatment makes these towels super absorbent compared to competitors
- Color band edging helps prevent cross contamination of chemicals
- Perfect for washing, drying, polishing and detailing

45625AS - 12 pcs. Open Stock / Tray Pack



### SPA-SOFT ADVANTAGE

Absorbs Fast

Spa-Soft with HYDRO-MAX™

Competitors

Slow to Absorb

2x Faster Absorption



No Mess Grip

- 50% faster than hand waxing alone
- Keeps hands clean
- Universal — works on all applicator pads

Patented ergonomic handle and fastening system changes the way wax, polish, and protectant are applied.



### The Gripper™ 5 Pack (5") Applicator Set with Reusable Canister

- Multi-purpose applicator pads with no-mess handle
- 3 Microfiber applicators, 2 terry applicators
- Ideal for interior and exterior uses

45128AS - 12 pcs. Open Stock

Retail Profits Boost 30% Where The Gripper™ is Placed

# DETAILING MADE SIMPLE

Easily find the right tools for the job with the usage guide



**clean**™



**dry**™



**shine**™



**detail**™



**multi-task**™



### Car Wash Bucket Mega Pack

**94108VA** - 10 pc. Bucket Kit Includes: 3 ea. Microfiber Towel; 2 ea. Microfiber Applicator Pad; 1 ea. Microfiber Wheel Detailer; 1 ea. Microfiber Wash Mitt; 1 ea. Lug Nut Brush; 1 ea. Gripper Handle; 1 ea. 3 gal. Bucket

**94114VA** - 4 pc. Bucket Kit Includes: 1 ea. Giant Bone Sponge; 1 ea. Terry Towel; 1 ea. Nylon Bug Sponge; 1 ea. 3 gal Bucket; Lid Not Included

**94109VA** - 6 pc. Bucket Kit Includes: 3 ea. Terry Towel; 1 ea. 2-in-1 Chenille Mitt; 1 ea. Nylon Bug Sponge and 1 ea. 3 gal. Bucket



### 3 Gallon (12 Quart) Specialty Car Wash Bucket

- Exclusive design made of high-impact plastic
- Accommodates up to 10" wash brush head
- Ergonomic handle with integrated towel rest

**94102N** - 36 pcs. Open Stock

**94102** - 12 pcs. Open Stock



### Professional Grade Water Hose

- Heavy-duty 3-layer construction
- Flexible and easy to maneuver
- Crush resistant ends

**90060** - 4 pcs. Open Stock







### 50 ft. Quick Connect Car Wash Hose with Two Adapters

- Heavy-duty 3-ply kink resistant hose
- Water saving auto shut-off feature
- Universal household hose bib swivel connector

90063 - 4 pcs. Open Stock



### Sweeper Nozzle

- Easy action on/off lever water control
- Powerful spray pattern
- Soft TPR over-molded tip
- Fits any standard hose thread

90072 - 24 pcs. Open Stock/Tray Pack



### Heavy-Duty Fire Hose Nozzle with On/Off

- Jet sprays over 40 feet
- Adjustable from jet to rinse
- Easy on/off water control

90051 - 6 pcs. Open Stock



### Heavy-Duty Fire Hose Nozzle

- Jet sprays over 40 feet
- Adjustable from jet to rinse

90049 - 6 pcs. Open Stock



### Heavy-Duty Trigger Nozzle

- Industrial grade nozzle
- Protects hands from hot and cold water
- Threaded tip with protective cap

90016 - 10 pcs. Open Stock



### Industrial Trigger Nozzle

- Threaded end for attachments
- Provides on/off and adjustable spray
- All metal construction

90005 - 10 pcs. Open Stock



# LONG POLE LEADER

Innovative Long Pole Wash Solutions



Hopkins® is the market leader in the ever-growing long pole wash category. Our exclusive designs have innovative features that cannot be found on any competitor's product. Over 50 years of car care experience in packaging, brush fibers, spray patterns and pole configurations gives customers virtually unlimited choices for their car care needs

## RELENTLESS INNOVATION...



Locking Head



ABS Components



Hardened Aluminum

EVERYDAY VEHICLE CLEANING



### FLOW-THRU™

#### 8" Wash Brush with Extension Pole

- Super soft brush with fan spray rinse and rubber bumpers
- Telescoping pole with on/off water control

92022S - 8" Brush with 40" Pole, 6 pcs. Open Stock

93052 - 8" Brush with 65" Pole, 6 pcs. Open Stock

93055 - 8" Brush with 28" Pole, Not Extendable, 6 pcs. Open Stock



#### 10" Wash Brush Extends to 65"

- Super soft brush with rubber bumpers
- Telescoping pole
- Foam grips for extra control

93062 - 8 pcs. Open Stock

93062D - 12 pcs. Floor Display





**FLOW-THRU™**  
**10" Wash Brush Extends to 68"**

- Super soft brush with fan spray rinse and rubber bumper
- Telescoping pole with no-spin locking head
- Variable-slide water control

**93089A** - 6 pcs. Open Stock  
**93089D** - 12 pcs. Floor Display

# ...YIELDS SUPERIOR PRODUCTS

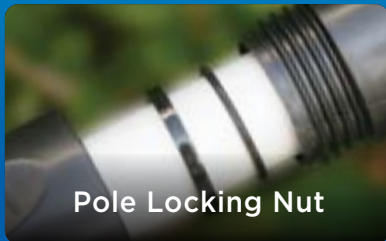

Pole Locking Nut



Press-Fit Connections



Slide Water Control



**8" Bi-Level Wash Brush with 48" Pole**

- Super soft bi-level wash brush
- Super strong all metal pole
- Plastic molded grip

**93060** - 6 pcs. Open Stock  
**93060D** - 12 pcs. Floor Display



**Wash Brush with 48" Pole**

- Super soft brush with rubber bumper
- Super strong all metal pole with plastic molded grip

**93058** - 10" Brush, 6 pcs. Open Stock  
**93053** - 8" Brush, 6 pcs. Open Stock  
**93058D** - 10" Brush, 12 pcs. Floor Display  
**93053D** - 8" Brush, 12 pcs. Floor Display



# HAND TOOL INNOVATIONS

Setting the Standard for Cleaning Quality Inside and Out



Over-Molded Grip



### Long Handle Brush 20"

- Extra-long handle for wheel and body
- Super-soft bristles
- Comfort-molded handle

93039 - 20" Body Brush, 12 pcs. Open Stock  
 94039 - Over-Molded Grip, 12 pcs. Open Stock



Over-Molded Grip



### Wheel & Bumper Brush

- Soft-bristles clean wheel, bumper and body
- Comfort-molded handle

93025 - 6 pcs. Open Stock  
 94025 - Over-Molded Grip, 6 pcs. Open Stock



Over-Molded Grip



### Tire & Grill Brush

- Stiff bristles clean bumper, grill and tire
- Comfort-molded handle

93036 - 12 pcs. Open Stock  
 94036 - Over-Molded Grip, 12 pcs. Open Stock



### Plunge & Scrub Spoke Brush

- All-sided cleaning
- Safe with most wheel finishes
- Comfort-molded handle

94037 - 12 pcs. Open Stock



### Microfiber Wheel Detailer

- Super-soft microfiber detailer with side scrubbing panels
- Comfort-molded handle
- Safe on all types of wheels

92017 - 6 pcs. Open Stock



### Wheel Brush

- Non-scratch soft bristles
- Safe with most wheel finishes
- Comfort-molded handle

93012 - 12 pcs. Open Stock





Contoured Bristles



### Contour Tire Brush

- Super-stiff bristles designed for tires
- Contours to tire shape
- Comfort-molded handle

93027 - 6 pcs. Open Stock



### Deluxe Tire Brush

- Super-tough brass bristles
- Cleans white/black wall tires and corrosion
- Thumb and finger position for extra scrubbing pressure

92016 - 6 pcs. Open Stock



### Lug Nut Brush

- Patented design cleans all sides of lug nut quickly and easily
- Works on all detailing areas of wheel, lug nut-stem-rim
- Fits all lug nut sizes

92019 - 6 pcs. Open Stock

92019WR - 12 pcs. Off Shelf/Wire Basket



### Finger Loop Scrub Brush

- Curved bristles clean crevices quickly and easily
- TPR rubber sure grip

92047 - 12 pcs. Open Stock

92047WR - 12 pcs. Off Shelf/Wire Basket



### 12" Car Dryer

- Squeegee car dryer with non-slip comfort grip handle
- 12" flexible, high quality, silicone blade car dryer

63128 - 6 pcs. Open Stock



### Tire Shine Applicator

- Quickly and easily applies tire dressing
- Contours to tire shape
- Comfort-molded handle

93047 - 6 pcs. Open Stock



### EZ Grip Applicator Sponge

- Contoured, easy grip sponge handle
- Suitable for all application uses

9-328 - 12 pcs. Open Stock



### Contour Tire Wipe

- Handle keeps hands away from chemicals
- Contoured handle shapes foam to the tire surface

92043 - 1 pk, 6 pcs. Open Stock

92043WR - 12 pcs. Off Shelf /Wire Basket

92143 - 2 pk, 6 pcs. Open Stock



Over-Molded Grip



### Interior Brush

- Durable scrubbing bristles
- Stiff carpet brush
- Easy-grip handle

93018 - 12 pcs. Open Stock

94018 - Over-molded grip, 12 pcs. Open Stock



### Dash and Crevice Detail Brush Set

- 2-Sided vent louver detailer
- Dust and crevice brush
- Vent and seam detailer

93019 - 12 pcs. Open Stock



### Interior/Exterior Detail Brush

- Soft bristles are perfect for dusting vents and dash and hard to get areas
- TPR tip removes dirt and grime from seams

92046 - 12 pcs. Open Stock

92046WR - 24 pcs. Off Shelf/Wire Basket



### Vent Brush

- Removes dust and dirt from hard to reach areas
- Stiff natural fibers

93043 - 12 pcs. Open Stock



### Detail Brush

- Dash dusting fibers
- Vent and detail brush
- Perfect for vents and seams

93044 - 12 pcs. Open Stock



### Lint & Hair Removal Brush

- Electrostatic bristles attract hair and fur like a magnet
- Removes hair, lint, and fuzz from upholstery and carpets
- Natural-rubber bristles will not scratch or scuff

93112 - 6 pcs. Open Stock



### Dust Pan & Broom

- Plastic pan and broom set
- Assorted colors

4B3208 - 12 pcs. Open Stock



### Whisk Broom

- Use in home or vehicle
- Natural fibers
- Metal hanger loop

93028 - 6 pcs. Open Stock



### Push Broom

- Great for indoor or outdoor applications
- Durable head with outer split-tip bristles
- 60" steel handle with hanging feature
- Use wet or dry

93071 - 24" broom, 6 pcs. Open Stock

6018 - 18" broom, 6 pcs. Open Stock



### Parts Brush

- General purpose brush
- Effective for all parts dusting and cleaning
- Firm bristles
- Multi-surface cleaning

4B3278 - 12 pcs. Open Stock





# EVERYDAY SOFT GOODS SOLUTIONS

Setting the Cleaning Standard



## Formulations

- Professional grade performance microfiber
- Over 30 materials and combinations for every cleaning task



## Functionality

- Superior ergonomics and ease of use
- Class-leading consumer insights



Side scrub netting



### Microfiber 3-in-1 Wheel & Body Wash Mitt

- Waterproof lining keeps hands dry and clean
- 2-Sided for separate body and wheel cleaning
- Side microfiber scrub netting safely cleans tough spots and debris

40310 - 6 pcs. Open Stock



### Microfiber Long Chenille Wash Mitt

- Long microfiber super suds maker holds more soap and water
- Cleans like a mop without snagging on crevices
- Elastic cuff keeps mitt snug

40309 - 6 pcs. Open Stock



### Ultimate Microfiber Mitt

- Dense pile cleans away dirt and grime
- Foam lined for added comfort and absorbency
- Use dry for dusting and wet for washing
- Ideal for polishing and dusting exterior and interior of your vehicle

2-303M8 - 6 pcs. Open Stock



### Super Sudsmaker Microfiber Wash Mitt

- Performance chenille super suds maker, holds more soap and water
- Convenient side for scrubbing
- Two mitts in one

45320 - 6 pcs. Open Stock



### Microfiber Wash Mitt

- Suds maker super absorbent microfiber
- Lint, streak and scratch free cleaning
- Sponge lined for extra absorbency

40307 - 6 pcs. Open Stock



### Microfiber Mesh Wash Mitt

- Plush microfiber lifts and traps dirt & dust
- Strong microfiber mesh scrubs away tough dirt
- Dual textured design allows you to clean most surfaces without sprays, polishes, or chemicals
- Plush microfiber side can be used dry for dusting and wet for washing

2-3268 - 12 pcs. Open Stock  
2-3268-7 - 12 pcs. Cut Case





### 2-in-1 Supersoft Microfiber Wash Mitt

- Chenille microfiber lifts and traps dirt and dust
- Strong microfiber mesh scrubs away tough dirt
- Mesh side for gentle scrubbing, plush side for washing

2-310M8 - 6 pcs. Open Stock



### Chenille Wash Mitt

- Super suds deep pile chenille perfect for any surface
- Elastic cuff keeps mitt snug

40302 - 6 pcs. Open Stock



### Chenille 2-in-1 Wash Mitt

- Super suds deep pile chenille perfect for any surface
- Elastic cuff keeps mitt snug
- Bug scrub netting

40304 - 6 pcs. Open Stock



### Acrylic Wool Wash Mitt

- Synthetic wool is extra soft and dense
- Great suds maker
- Elastic cuff keeps mitt snug

40306 - 6 pcs. Open Stock



### Microfiber Sponge with Added Scrub

- Large microfiber chenille pad for washing
- Two products in one
- Microfiber dog bone sponge has scrubbing mesh for bug and tar removal

45114 - 9 pcs. Open Stock



### 2-in-1 Microfiber Covered Bone Sponge

- Plush microfiber cleans away dirt and grime
- Microfiber mesh scrubs away tough dirt
- Mesh side for gentle scrubbing
- Plush side for washing

9-21M8 - 12 pcs. Open Stock

9-21M8-7 - 12 pcs. Cut Case



### Microfiber 2-in-1 Long Chenille Sponge

- Long microfiber super suds maker holds more soap and water
- Scrub side removes bug and tar from windows and mirrors
- Super absorbent sponge

40112 - 12 pcs. Open Stock



### Chenille Shampoo Wash Pad

- Dense chenille pile is sewn over an absorbent sponge, creating more sudsing action
- Super sudsing action
- Washes without scratching
- Safe on all surfaces

9-368 - 6 pcs. Open Stock



### Microfiber Bone Sponge

- Sudsmaker super absorbent microfiber material
- Lint, streak and scratch free cleaning
- Super absorbent sponge

40110 - 12 pcs. Open Stock







### Bone Sponge

- Extra absorbent and durable
- Bone shape is easy to hold
- Extra large sponge

40102 - 12 pcs. Open Stock

9-38 - 24 pc. Open Stock

9-38-7 - 14 pc. Cut Case



### Large Bug-Gone Scrubber Sponge

- Removes bug and tar stains
- Use on windshields, headlights and windows
- Super scrubbing action
- Strong and long lasting mesh-covered sponge is designed to replace steel wool and other harsh pads

9-248 - 12 pcs. Open Stock



### Nylon Bug Sponge

- Sponge with stiff netting safely scrubs bugs and tar from windows and mirrors
- Compact size fits easily into palm
- Extra absorbent

40106 - 12 pcs. Open Stock



### Microfiber Bug Scrubber

- Removes bug and tar stains
- Microfiber mesh covered sponge
- Tough on dirt yet safe to use on all surfaces
- Strong and long lasting mesh-covered sponge is designed to replace steel wool and other harsh pads

9-24M8 - 12 pcs. Open Stock



### Microfiber 2-in-1 Wheel Detailer Wash Mitt

- 2-in-1 microfiber detailer safely cleans painted and clear coated wheels
- 2-Sided microfiber pockets give cleaning power to fingers
- Microfiber reinforced scrub panel quickly cleans away brake dust and road grime

40313 - 12 pcs. Open Stock



### Microfiber Screen & Display Cleaner

- 2-Sided for dash dusting and window and mirror defogging
- Pockets hold mitt to fingers to reach along window edges
- Suede for window and mirror; terry microfiber for dusting

40314 - 12 pcs. Open Stock



## MADE FOR AUTO CARE

Thousands of split fibers per square inch provide an ultra soft, lint, streak, and scratch-free way to clean, dry, shine, detail, and more. Round corners won't scratch or snag like traditional microfiber towels, perfect for cleaning all parts of the vehicle... inside and out!

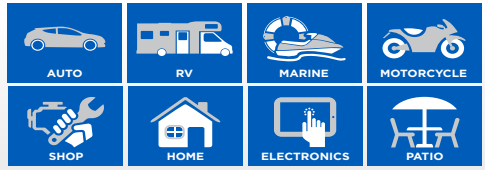

### Multi-Pack Microfiber Towels (12" x 16")

- Superior polishing, drying and detailing towel
- Extra durable and lint free
- Use for any car care task

**40062** - 8 pk towels, 12 pcs. Open Stock  
**45067** - 12 pk Assorted Colors, 6 pcs. Open Stock  
**40062D** - 12 pcs. Tray Pack



### 3-Pack Microfiber Towels

- Superior polishing, drying and detailing towel
- Extra durable and lint free
- Use for any car care task
- Towel size: 12" x 16"

**40061** - 12 pcs. Open Stock  
**40061D** - 25 pcs. Tray Pack  
**3-6068** - 6 pk. rolled, 12 pcs. Open Stock



### 18 pc. Microfiber Cloth

- Ideal for auto, home, office, and marine applications
- Soft and lint-free - Safe on all surfaces
- Lifts and traps dirt and dust like a magnet
- No chemicals needed

**3-5418** - 12 pcs. Open Stock

EVERYDAY VEHICLE CLEANING



### Wash and Dry Microfiber Cloth

- Cleans without chemicals
- Absorbs 8 times its weight in water
- Towel size: 16" x 16"

**45070** - 12 pcs. Open Stock

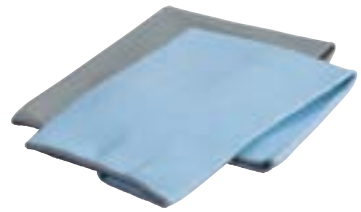

### Glass and Dusting Microfiber Cloth

- Use wet or dry for chemical-free cleaning
- Keep inside car for defogging and removing smudge marks from dash
- Cleans without chemicals

• Towel size: 16" x 16"  
**45066** - 12 pcs. Open Stock



### 2-Pack Glass Pocket Towel

- Double sided for washing & scrubbing
- Plush (yellow) side for washing
- Mesh (gray) side for gentle scrubbing
- Use dry or dampen for more cleaning power

**3-5118** - 12 pcs. Open Stock



### Deluxe Microfiber Large Drying Towel (22" x 30")

- Professional weave creates more drying sides and edges
- Super large size dries larger area quickly
- Lint and streak free drying
- Cleans as it dries and safe on all surfaces

45211 - 6 pcs. Open Stock  
3-5158 - 6.25 sq. ft., 6 pcs. Open Stock



### 9 Sq Ft Microfiber Heavy Plush Towel

- Extra large, super soft, and absorbent
- Traps and holds dust like a magnet
- Ideal for exterior/interior of your vehicle
- Clear coat safe

3-5068 - 6 pcs. Open Stock



### 2-in-1 Plush Microfiber Wax & Buff Towel

- Removes wax build-up
- Super soft plush side is great for buffing
- Towel size: 16" x 16"

3-5078 - 6 pcs. Open Stock



### 2 pc. Microfiber Spa Towel

- Super soft
- Ideal for polishing and dusting
- Clear coat safe
- Towel size: 16" x 16"

3-5088 - 12 pcs. Open Stock



### Microfiber Max Drying Towel (24" x 30")

- Textured design creates more drying surface
- Lint and streak free drying
- Super large size dries large area fast
- Cleans as it dries and safe on all surfaces

45010 - 6 pcs. Open Stock  
3-5028 - 5 sq. ft. Microfiber Waffle Drying Towel, 12 pcs. Open Stock

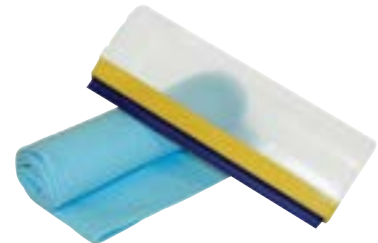

### Evaporator PVA Drying Towel w/Wipe-Out Blade Canister

- Durable PVA towel with center mesh absorbs water like a sponge
- Wipe out silicone blade removes water from body and window

40208 - 3 sq. ft., 6 pcs. Open Stock  
40209 - With Wipe out Blade Canister, 6 pcs. Open Stock



### Synthetic Chamois

- Streak and spot free drying
- Requires less effort to dry all surfaces
- Extra durable, easy to wring out and re-use

40211 - 3.5 sq. ft. 12 pcs. Open Stock  
40210 - 2.5 sq. ft. 6 pcs. Open Stock



### Polishing & Wax Removal Cloth

- Removes streaks, haze, dust and wax residue
- Towel size: 14" x 18"

45069 - 12 pcs. Open Stock



### 3 pc. Microfiber Glass Towels (14" x 14")

- One towel each for washing, scrubbing, and glass cleaning
- Blue - Cleans glass and mirrors lint free
- Gray - Scrubs away bugs and tar stains and caked-in debris
- Green - Use wet to wash, dry to dust and polish

3-5018 - 12 pcs. Open Stock



### 2-Pack Microfiber Cleaning Cloth (12" x 16")

- Works like a magnet to attract and hold dust
- Great for dusting, windows and polishing
- Microfiber technology

45062 - 12 pcs. Open Stock

3-5108 - 12 pcs. Open Stock



### Microfiber Cleaning Cloth (12" x 16")

- Works like a magnet to attract and hold dust
- Great for dusting, windows and polishing
- Microfiber technology

45063 - 12 pcs. Open Stock



### Microfiber Towel (14" x 14")

- Scoops, lifts, and traps dust and dirt
- Cleans without chemicals
- Use wet or dry
- Safe on all surfaces

3-5128 - 18 pcs. Open Stock



### The Gripper™ 2-Pack Microfiber Applicator Set (5")

- The Gripper™ handle holds tight to pad with fastening hooks
- No-mess application of interior protectants and more
- Completely reusable handle

40123 - 6 pcs. Open Stock



### The Gripper™ 3-Pack Terry Applicator Set (5")

- The Gripper™ handle holds tight to pad with fastening hooks
- No-mess application of wax and polish
- Completely reusable handle

40122 - 6 pcs. Open Stock



### Foam Applicator Pads

- Designed to evenly apply wax, polish, protectant, stain and wood finish to all surfaces
- Soft and lint free

9-198 - 12 pcs. Open Stock



### 2-Pack Terry Cloth Applicator Pads (5")

- Lint free, extra soft terry cloth
- Great for applying wax, polish and more
- Refills for The Gripper™ packs

40118 - 2 pk, 12 pcs. Open Stock

40119 - 4 pk, 12 pcs. Open Stock

9-288 - 2 pk, 12 pcs, Open Stock



### 2-Pack Microfiber Applicator Pads (5")

- Lint free and streak free
- Holds more protectant, polish and wax
- Extra absorbent and soft

40120 - 2 pk, 12 pcs. Open Stock

9-28MC8 - 2 pk, 12 pcs. Open Stock



### 6 in. Terry Applicator with Pocket

- Terry covered pad designed for easy application of protectants, waxes, stains, wood finishes and polishes to all surfaces
- Convenient hand pocket
- Soft and lint free cotton

9-278 - 12 pcs. Open Stock





### 6 in. Microfiber Applicator with Pocket

- Soft and lint free microfiber
  - Large size applies wax, polish, and protectant quickly and evenly
  - Sewn pocket adds grip and control
- 9-27MC8** - 12 pcs. Open Stock



### 1 lb. Microfiber Assorted Towels

- Soft and lint-free
  - Lifts and traps dirt and dust like a magnet
  - Multiple colors for different wiping applications
  - Machine washable and reusable
- 2-3548** - 16 pcs. Open Stock



### 6 oz. Polishing Cloth

- Super soft knitted polyester cloth
  - Perfect for polishing, waxing, and buffing
  - Clear coat safe
- 2-48** - 6 pcs. Open Stock

## POLISHING & DETAILING

Core and Essential Solutions for Complete Auto Care

Diaper Soft

Wax Removal and Exterior Polishing

Cotton Terry

Cleaning and Drying

Cotton Flannel

Super Soft Polishing Inside and Out

Cotton Shop

Absorbing and Clean Up

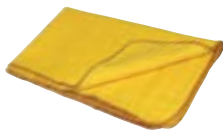

### Flannel Cloth 3-Pack (14" x 24")

- Provides the ultimate high gloss shine
  - Ultra soft and safe for all clear coats
- 40052** - 12 pcs. Open Stock  
**3-7438** - 24 pcs. Open Stock



### Diaper Soft Polishing Cloths (11" x 17")

- Super soft for wax removal and polishing any surface
  - Washable and reusable
- 40065** - 3 pk rolled, 12 pcs. Open Stock  
**2-38** - 3 pk rolled, 12 pcs. Open Stock  
**40067** - 6 pk rolled, 12 pcs. Open Stock  
**40069** - 10 pk bagged, 12 pcs. Open Stock  
**2-108** - 10 pk bagged, 12 pcs. Open Stock  
**40065D** - 3 pk rolled, 36 pcs. Tray Pack  
**2-668** - 6 pk rolled, 6 pcs. Open Stock  
**2-338-7** - 3 pk rolled, 24 pcs. Open Stock



### Cotton Terry Towel (14" x 17")

- Dries and details
  - Washable and reusable
  - Hemmed for extra durability
- 3-5238** - 2 pk rolled, 24 pcs. Open Stock  
**40050** - 3 pk rolled, 12 pcs. Open Stock  
**3-6828** - 3 pk rolled, 24 pcs. Open Stock  
**40051** - 12 pk rolled, 6 pcs. Open Stock  
**3-685-58** - 12 pk PDQ, 10 pcs. Open Stock  
**3-5288** - 12 pk rolled, 12 pcs. Open Stock  
**3-5288-7** - 12 pk bagged, 12 pcs. Cut Case  
**45054** - 4 pk bagged, 12 pcs. Open Stock  
**3-5278** - 4 pk bagged, 12 pcs. Open Stock  
**40050D** - 3 pk rolled, 30 pcs. Tray Pack  
**3-6848** - 6 pk rolled, 12 pcs. Open Stock  
**3-6848-7** - 6 pk display, 12 pcs. Cut Case



### Shop Towels (13" x 14")

- Washable and reusable general purpose use
- 40046** - 5 pk rolled, 12 pcs. Open Stock  
**3-591-158** - 5 pk PDQ, 15 pcs. Open Stock  
**40047** - 10 pk rolled, 12 pcs. Open Stock  
**40048** - 25 pk bagged, 6 pcs. Open Stock  
**40046D** - 5 pk rolled, 36 pcs. Tray Pack  
**3-5368** - 10 pk rolled, 24 pcs., Open Stock  
**3-5368-5** - 10 pk rolled, 12 pcs. Cut Case  
**3-5588** - 50 pk rolled, 8 pcs. Open Stock  
**3-5308** - 4 pk rolled, 24 pcs. Open Stock  
**3-5378** - 12 pk rolled, 20 pcs. Open Stock  
**3-5428** - 25 pk rolled, 6 pcs. Open Stock



### Bag of Rags

- Soft, washable and absorbent
  - Perfect for all purpose clean up
  - Perfect for auto, home, marine and shop use
- 40071** - 1/2 lb, 6 pcs. Open Stock  
**40072** - 1 lb, 6 pcs. Open Stock  
**2-2548** - 1 lb, 6 pcs. Open Stock



# TANNER'S SELECT®

Tanner's Select® chamois are quality controlled, cut and packaged in the US, tanned in Turkey and all made from the highest quality New Zealand sheepskin



**Award Winning  
Packaging**

TANNER'S SELECT® PREMIUM CHAMOIS

- 125 years of tanning and supply management experience
- Unmatched program strategies that boost profits and bring customers back!

## PREMIUM QUALITY, LASTING VALUE

All Tanner's Select® chamois are electronically measured before being packaged to ensure the proper sizing. Quality remains our primary focus throughout the production cycle to ensure that our final product is the finest chamois available

# FROM SHEEP TO SHELF THE TRUSTED CHOICE FOR CHAMOIS IN NORTH AMERICA

*From Selected Sheep for the Finest Chamois Available*



## Tanner's Select® Naturel Chamois

- 100% all natural sheepskin chamois
- Superior tanning for extra absorbency

**TS95T4** - 6.5 sq. ft., 4 pcs. Open Stock  
**TS90T6** - 6 sq. ft., 6 pcs. Open Stock



## Tanner's Select® Naturel Chamois

- 100% all natural sheepskin chamois
- Superior tanning for extra absorbency

**TS80T6** - 5 sq. ft., 6 pcs. Open Stock  
**TS75T6** - 4.5 sq. ft., 6 pcs. Open Stock  
**TS70T6** - 4 sq. ft., 6 pcs. Open Stock



## Tanner's Select® Naturel Chamois

- 100% all natural sheepskin chamois
- Superior tanning for extra absorbency
- Remove fingerprints and dust from dashes, windows, touchscreens, mirrors, appliances, tvs and more

**TS60T6** - 3.5 sq. ft., 6 pcs. Open Stock  
**TS40T6** - 3 sq. ft., 6 pcs. Open Stock  
**TS20T6** - 2.5 sq. ft., 6 pcs. Open Stock  
**TS10T6** - 2 sq. ft., 6 pcs. Open Stock





TANNER'S  
SELECT®

LUXURY LEATHER CARE

## Best Leather Care - Anywhere!

Tanner's Select® Leather Life products are simply the best choice to clean, condition, revive, and restore any leather item

Premium blends are specially formulated to gently and effectively clean and condition all types of leather. Our products help your leather goods maintain their flexibility and breathability over time; prolonging that factory-fresh look and feel!



Tanner's Select®  
**Leather Life** 

**Ultimate Cleaner & Conditioner  
Foaming Aerosol - 14 oz.**

- Gently loosens and lifts dirt and debris
- Penetrates and hydrates as it cleans
- Leaves a clean, non-oily surface

45704 - 6 pcs. Open Stock

***Auto • Home • Apparel • Accessories • On the Go***







# CAR DUSTERS™

Dust Off Idling Sales With a Brand That Shines



Improved Ergonomics

Reach Tight Spaces With Ease!



### Pacific Coast™ Professional Car Duster

- Specially treated fibers lift dust and dirt, will not scratch paint
- Long handle for added reach
- Storage bag included

93007 - 6 pcs. Open Stock

93008PC - 6 pcs. With wood handle, Open Stock



### Pacific Coast™ Dash Duster

- Specially treated fibers lift dust and dirt, will not scratch paint
- Use for auto, home and more
- Safe on all surfaces

93006 - 6 pcs. Open Stock



### Pacific Coast™ Drying Towel

- Premium synthetic towel in a reusable canister
- The easiest way to dry your vehicle
- Also great for household, marine and drying pets
- 3 Square feet

45218 - 6 pcs. Open Stock





# #1 Name In Glass Care... Everywhere

## Innovative Glass Care Accessories Make Each Cleaning Task Easier

Designed to handle all glass, mirror, and optical cleaning jobs for your car, truck, SUV or RV. Compact and convenient; use them at home, on the go, on their own or with your favorite Rain-X® cleaning liquids for a truly flawless result.

With solutions for washing, drying, dusting, polishing and defogging, the Rain-X® Glass Cleaning and Care Accessory line

**Lets You See Clearly... Inside & Out!**



Leverage Rain-X® brand equity to promote and cross-sell in your planogram



### Rain-X® Liquid-Filled Window Wand™

- Triangle design pivots to reach corners
- Reversible bonnet cleans and defogs glass
- Easy to reach spray pump with 4 oz. bottle

9274X - 6 pcs. Open Stock  
9275X - 6 pcs Open Stock/Tray

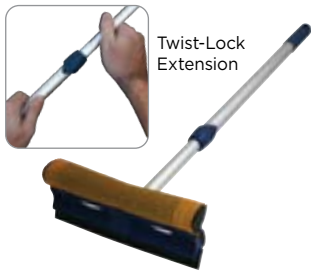

### Rain-X® 8" Squeegee with 39" Extension

- Flow-thru design reduces splash-back from bucket
- Integrated spot scrubbers
- Patented mesh locking feature adds durability

9271X - 6 pcs. Open Stock



### Rain-X® Liquid-Filled 8" Spray Squeegee

- Tough scrub netting
- Side mount scrubber
- Refillable, easy pump spray

9425CDX - 12 pcs. Open Stock/Tray Pack



### Rain-X® Compact 8" Squeegee

- Handle extends to 15" and collapses to store
- Compact design stores anywhere
- Double scrubbing action

9438X - 8 pcs. Open Stock/Tray Pack



### Rain-X® Premium 8" Squeegee with 20" Handle

- Patented "double-wrap" scrub assist netting
- Patented mesh locking system has greater pull, prolonging product life
- Exclusive Water-Shed™ head design minimizes splash back and reduces fatigue

9272X - 6 pcs. Open Stock



# Swiper

**DRIES  
EVERYTHING  
FASTER!**

**Streak-Free Drying,  
Safe on all Surfaces**

**Auto, Truck, SUV,  
RV & Home**



## Swiper

### Swiper GO! Synthetic Chamois™

- 2-sided
  - Streak-free drying
  - Safe on all surfaces
- 45222X** - 6 pcs. Open Stock



## Swiper

### Swiper Pro Ultimate Towel™

- Swiper-Matrix™ microfiber absorbs water from all sides
- Dries and polishes at the same time
- No streaks, spots or scratches
- 3.5 square feet

**45225X** - 12 pcs. Open Stock



## Swiper

### Swiper Blade Auto Drying Tool™

- Integrated soft silicone V-blade dries large areas fast
- Detail drying with microfiber bonnet
- Patented 2-sided hybrid drying blade

**96012X** - 4 pcs. Open Stock



## Swiper

### Swiper Synthetic Chamois™

- 2-sided towel and sponge
- Streak free drying
- Safe on all surfaces
- 3 square feet

**45223X** - 6 pcs. Open Stock

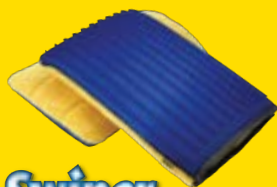

## Swiper

### Swiper Drying Mitt™

- Built-in soft squeegee blades
- Plush microfiber for detailing, drying and polishing
- Safe on all surfaces: Auto, Truck, SUV, RV & Home

**45137X** - 6 pcs. Open Stock



### Rain-X® Compact Scrub & Squeegee™

- Exclusive Sof-Tools™ 2-sided design
- Tech-Mesh™ scours stuck on debris
- Soft blades, squeegee windows clean
- Compact and easy to use

**9440X** - 4 pcs. Tray Pack

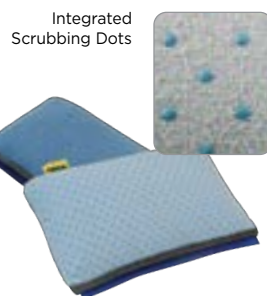

### Rain-X® 3-in-1 Window Blade™

- Premium terry microfiber removes fingerprints and window haze
- Soft suede microfiber cleaning with scrub dots
- Sof-Tools™ flexible squeegee quickly removes morning mist and dries all exterior windows

**45619X** - 6 pcs. Open Stock



### Rain-X® Triple Blade Glass Tool™

- Removes bugs and debris
- Swipes clean wiper blades
- Lifts labels and decals
- Works on all glass, mirror, and optical cleaning jobs

**45544X** - 12 pcs. Open Stock/  
Tray Pack

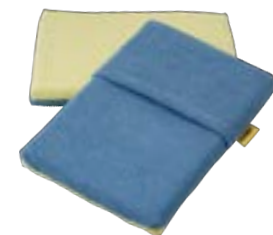

### Rain-X® 2-Sided Microfiber Defogger Sponge

- Compact microfiber sponge is ideal for quick dash cleaning and window defogging
- Blue terry microfiber quickly cleans glass screen & optical surfaces
- Yellow, soft suede microfiber removes fingerprints and window haze

**45116X** - 6 pcs. Open Stock/Tray Pack



### Rain-X® Microfiber Fog Ball

- Defogs and cleans glass and mirror surfaces
- Premium microfiber chenille
- Works on all glass, mirror and optical cleaning jobs

**45078X** - 12 pcs. Open Stock/Tray Pack



### Rain-X® 2-Sided Bug & Tar Sponge

- Gray, heavy mesh is ideal for body, bumper, and wheel scrubbing
- Blue mesh works great on glass, headlights, and optics

**45122X** - 6 pcs. Open Stock/Tray Pack



# QUALITY GLASS CARE TOOLS

The most comprehensive assortment of glass care tools available and the #1 position in North America



### Window Wash Spray Squeegee

- Refillable, easy pump spray
  - Side mount scraper
- 9025CDF** - 12 pcs. Open Stock/Tray Pack



### Compact Window Squeegee 8"

- Handle extends to use and collapses to store
  - Compact design stores anywhere
  - Double scrubbing action
- 9038** - 6 pcs. Open Stock



### 6" Red Plastic Head with 9" Handle

- Heavy-duty plastic handle with rubber blade
  - Foam with scrub netting
- 806NY** - 6 pcs. Open Stock

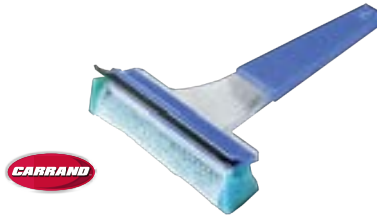

### "Misty" 6" Acrylic Plastic Squeegee with Netting

- Heavy-duty plastic handle with rubber blade
  - Foam with scrub netting
- 9020A** - 24 pcs. Open Stock



### Squeegee Bucket with Steel Bracket (Black)

- Sturdy molded plastic
  - Ideal for service station island
- 885** - 1 pc. 2 Gallon squeegee bucket with bracket  
**94101** - 18 pcs. 1 Gallon squeegee bucket with bracket



### 10" Professional Metal Squeegee with Extendable Pole

- Rust resistant, EPDM pliable blade, bug scrub netting
- Plastic side guards protects glass
- Adjustable handle

#### Multiple Parts

Brand	Part #	Description
Mallory	4-10NY-E	10" professional squeegee head with 49"- 7' aluminum telescopic handle (unassembled), 4 pk
Carrand	9500	10" squeegee with 48"- 7' extendable handle (assembled), 6 pk



### 8" Professional Metal Squeegee with Extendable Pole

- Rust resistant, EPDM pliable blade, bug scrub netting
- Plastic side guards protects glass
- Adjustable handle

#### Multiple Parts

Brand	Part #	Description
Mallory	8NYE-48	8" pro squeegee head with 48" aluminum telescopic handle, 12 pk
Carrand	9045RA	8" squeegee with 36" extendable handle (steel), 24 pk
Carrand	9049	8" deluxe squeegee with 36" extendable handle (steel), 24 pk





### Deluxe 8" Professional Metal Head with Wood Handle (assembled)

- Rust resistant, pliable blade, bug scrub netting
- Plastic side guards protects glass

#### Multiple Parts

Brand	Part #	Description
Mallory	8NY-16A	8" pro squeegee head with 12" handle, red, 24 pk
Mallory	8NY-24A	8" pro squeegee head with 20" handle, red, 12 pk
Mallory	24-808NY-30A	8" pro squeegee head with 30" handle, red, 24 pk
Carrand	9031R	8" squeegee with 12" handle, red, 24 pk
Carrand	9032R	8" squeegee with 20" handle, red, 24 pk
Carrand	9047R	8" squeegee with 32" handle, red, 24 pk
Carrand	9057	8" deluxe squeegee with 20" handle, black, 24 pk



### Deluxe 10" Professional Metal Head with Wood Handle (assembled)

- Rust resistant, pliable blade, bug scrub netting
- Plastic side guards protects glass

#### Multiple Parts

Brand	Part #	Description
Mallory	10NY-24A	10" pro squeegee head with 20" handle, red, 12 pk
Carrand	9037R	10" squeegee with 20" handle, red, 24 pk
Carrand	9058	10" deluxe squeegee with 20" handle, black, 24 pk



### Deluxe 8" Professional Plastic Squeegee with Extendable Handle (assembled)

- EPDM Blade, nylon net, heavy-duty sponge
- Adjustable handle

#### Multiple Parts

Brand	Part #	Description
Mallory	WSE-39A	8" pro squeegee head with 24"- 39" aluminum extendable handle, 8 pk
Carrand	9046	8" plastic head with 21"- 36" extendable steel handle, 24 pk



### Deluxe 8" Professional Plastic Squeegee with Solid Plastic Handle (assembled)

- EPDM Blade, nylon net, heavy-duty sponge
- Perma-net locking system; Double wrap netting

#### Multiple Parts

Brand	Part #	Description
Mallory	WS1524A	8" pro squeegee head with 15" handle, 24 pk
Mallory	WS2024A	8" pro squeegee head with 20" handle, 24 pk
Carrand	9266	8" squeegee head with 15" handle, 24 pk
Carrand	9267A	8" squeegee head with 20" handle, 24 pk

## UNASSEMBLED SQUEEGEE

### Deluxe Metal Professional

Brand	Part #	Description
Mallory	12-8NY-48	8" pro squeegee with 48" hardwood handle, 12 pk
Mallory	4-10NY-E	10" pro squeegee with 7' aluminum telescopic handle, 4 pk
Carrand	9010R	8" metal head with 20" wood handle, red, 12 pk
Carrand	9014R	8" metal head with 12" wood handle, red, 12 pk
Carrand	9039R	10" deluxe metal head with 20" wood handle, red, 12 pk
Carrand	9053	8" deluxe steel head with 20" wood handle, black, 12 pk



### Deluxe Plastic Professional

Mallory	WS1524U	8" pro head, 15" plastic handle, 24 pk
Mallory	WS2024U	8" head, 20" plastic handle, 24 pk
Mallory	WS4224U	8" head, 42" aluminum handle, 24 pk
Carrand	9262B	8" head with 15" plastic handle in sealed bag, "Professional Squeegee in a Bag", 12 pk
Carrand	9263	8" plastic head with 20" plastic handle, 12 pk





# BULK SQUEEGEES

## Unassembled Squeegee Parts

### BULK SQUEEGEE HEADS

#### Metal (Steel) Professional

Brand	Part #	Description
Mallory	12-808NYU	8" professional squeegee head
Mallory	12-810NYU	10" professional squeegee head
Carrand	9000R	8" metal head
Carrand	9033R	10" metal head
Carrand	9050	8" deluxe squeegee head
Carrand	9051	10" deluxe squeegee head

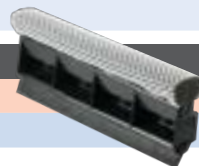

#### Plastic Professional

Mallory	WSH24	8" professional plastic head, black
Carrand	9260	8" plastic head, black

### BULK SQUEEGEE HANDLES

Brand	Part #	Description
Mallory	110U	12" professional threaded hardwood handle, black
Mallory	111U	20" professional threaded hardwood handle, red
Mallory	112U	30" professional threaded hardwood handle, red
Mallory	148	48" professional hardwood handle
Mallory	WS1524	15" professional solid, heavy-duty, plastic handle, black
Mallory	WS2024	20" professional solid, heavy-duty, plastic handle, black
Mallory	WS4212	42" professional heavy-duty, aluminum handle
Carrand	9003R	12" wood handle, red
Carrand	9005R	20" wood handle, red
Carrand	9007R	32" wood handle, red
Carrand	9008BLK	20" wood handle, black
Carrand	9217Blk	15" plastic handle, black
Carrand	9221Blk	20" plastic handle, black



### FIBERGLASS, METAL, WOOD HANDLES - BULK

Brand	Part #	Description
Mallory	160	60" professional threaded hardwood handle - natural finish
Mallory	118-54	54" professional threaded aluminum handle with grip
Carrand	92508	4-8 ft. fiberglass extension pole with metal tip - non flow-thru
Carrand	92509	6-12 ft. fiberglass extension pole with metal tip - non flow-thru
Carrand	92510	6 ft. fiberglass pole with (15/16") metal tip - non flow-thru
Carrand	92511	5-10 ft. fiberglass extension pole with metal tip - non flow-thru
Carrand	93069	60" handle with (15/16") metal tip, acme thread, steel - non flow-thru
Carrand	93501	60" handle, 1" diameter wood pole sanded, tapered, threaded - non flow-thru
Carrand	93502	72" handle, 1-1/8" diameter wood pole with metal tip, acme thread - non flow-thru
Carrand	93504	60" handle, 1" diameter wood pole with thread, lacquered - non flow-thru
Carrand	9501	48" - 84" aluminum extension handle - non flow-thru
Carrand	9507	53" - 96" aluminum extension handle with reinforced tip - non flow-thru
Carrand	9508	27" - 48" steel non flow-thru extension handle with reinforced tip, black powder coat
Carrand	9514	67" heavy-duty aluminum flow-thru extension handle with slide water control, (up to 67")



# MERCHANDISING MENU

## TRAY PACKS

Part #	Description	# Pcs.
40046D	5 pk Shop Towels (13" x 14")	36 pcs.
40050D	3 pk Cotton Terry Towels (14" x 17")	30 pcs.
40061D	3 pk Microfiber Towels (12" x 16")	25 pcs.
40062D	8 pk Microfiber Towels (12" x 16")	12 pcs.
40065D	3 pk Diaper Soft Polishing Cloths (11" x 17")	36 pcs.
45078X	Microfiber Window Mate	12 pcs.
45116X	2-Sided Microfiber Defogger Sponge	6 pcs.
45544X	Triple Blade Glass Tool	12 pcs.
45625AS	6 pk Spa-Soft Detailing towels	12 pcs.
9025CDF	Window Wash Spray Squeegee	12 pcs.
9275X	Liquid-Filled Window Wand™	6 pcs.
9425CDX	Liquid-Filled 8" Spray Squeegee	12 pcs.
9438X	8" Compact Squeegee	8 pcs.
9440X	Compact Scrub & Squeegee™	4 pcs.
90072	Sweeper Nozzle	24 pcs.
45122X	2-Sided Bug & Tar Sponge	6 pcs.



## OFF SHELF

Part #	Description	# Pcs.
92043WR	Contour Tire Wipe with Wire Basket	12 pcs.
92046WR	Interior/Exterior Detail Brush with Wire Basket	24 pcs.
92047WR	Finger Loop Scrub Brush with Wire Basket	12 pcs.



## FLOOR DISPLAYS

Part #	Description	# Pcs.
93053D	8" Wash Brush with 48" Handle	12 pcs.
93058D	10" Wash Brush with 48" Handle	12 pcs.
93060D	8" Bi-Level Wash Brush with 48" Pole	12 pcs.
93062D	10" Wash Brush Extends to 65"	12 pcs.
93089D	10" Wash Brush Extends to 68"	12 pcs.
93097D	10" Bi-Level Wash Brush Extends to 71"	12 pcs.



# HIGH QUALITY TIRE REPAIR SOLUTIONS



DRIVING SAFETY AND PROTECTION FOR OVER 65 YEARS



# TIRE SAFETY

## GAME CHANGING INNOVATION

The innovation journey spawned from our unquenchable desire to delight the consumer. We listened to your shoppers and walked in their shoes to identify unmet needs. We re-imagined products, creating “new to the world” solutions that improve the tire safety product use experience

## TURN-KEY ASSORTMENT

Different shoppers have different needs, so we created a broad portfolio with a logical progression of features. Therefore, your shopper gets a wide range of industry leading, value-added solutions tailored to their specific needs. And you can implement an integrated retail strategy to cross-promote and step up your shopper that will raise the growth trajectory for your business

## RECOGNIZED BRAND

Whether your core shopper lives in the city or in the heartland of America, we have the brand for you. Genuine Victor™ has 65 years of tire safety experience and a unique heritage with a strong, loyal following

GENUINE  
**VICTOR**™

- Trusted Tire Repair Brand
- Solutions for Every Need
- A Simpler and Better Shopping Experience

# 66 YEARS YOUNG, ALWAYS ORIGINAL



**TIRE ACCESSORIES**



**TIRE REPAIR**



**INFLATION**

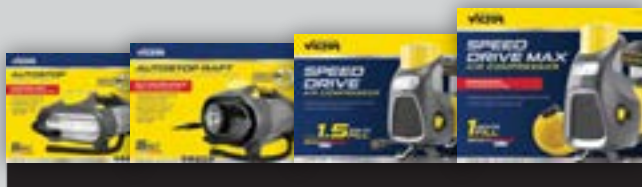

# VALVE THRU FORMULA TIRE SEALANT

ADVANCED NANO  
TECHNOLOGY

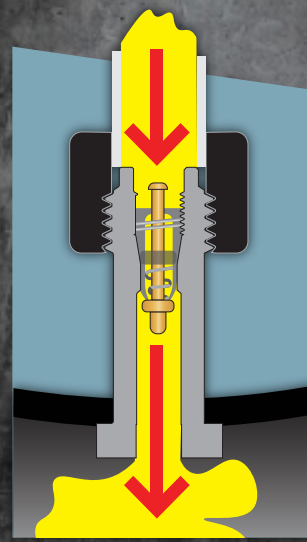

### QuickFIX™ Tire Repair Kit

- 6 Minute fill time
  - Inflates tires with or without sealant
  - Comes with 12 oz bottle of sealant
- 22-5-16005-8 - 4 pcs. Open Stock



### QuickFIX™ 12 oz. Refill Bottle

- Designed only to work with QuickFIX™ Tire Repair Kit
  - Instantly seals tread punctures up to 1/4" diameter
  - Non-toxic, non-flammable
- 22-5-57120-8 - 6 pcs. Open Stock



### Valve Thru Tire Sealant - 32 oz.

- For tubeless tires
  - Instantly seals tread punctures up to 1/4" diameter
- 22-5-57109-8 - 6 pcs. Open Stock



### Valve Thru Tire Sealant - 16 oz.

- For tubeless tires
  - Instantly seals tread punctures up to 1/4" diameter
- 22-5-57107-8 - 6 pcs. Open Stock

# SmartSTOP™ INFLATORS

Give Your Shoppers the Knowledge to Be Safe



- **SmartSTOP™ Technology**

- Countdown timer estimates and displays remaining fill time for any size tire
- Automatically shuts off at the selected pressure
- Truly the knowledge to be safe

- **Performance Guaranteed**

Backed by a lifetime warranty

- **Logical Progression of Features**

Broad portfolio of inflators to meet various shopper needs

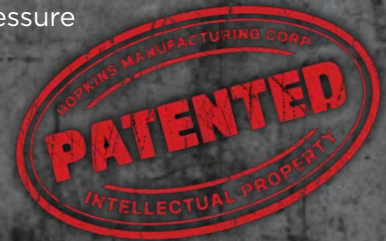

### QuickDRIVE MAX™ Tire Inflator

- 3 Minute fill time
- Digital, back-lit display for night time use
- Countdown timer displays remaining fill time

22-5-16055-8 - 2 pcs. Open Stock



### QuickDRIVE™ Tire Inflator

- 4 Minute fill time
- Digital, back-lit display for night time use
- Countdown timer displays remaining fill time

22-5-16045-8 - 2 pcs. Open Stock



### AutoSTOP ULTRA™ Tire Inflator

- 4 Minute fill time
- Cordless & rechargeable
- Countdown timer displays remaining fill time

22-5-16070-8 - 2 pcs. Open Stock



### AutoSTOP OUTDOOR™ Tire Inflator

- 5 Minute fill time
- Fills your inflatables
- Countdown timer displays remaining fill time

22-5-16040-8 - 4 pcs. Open Stock



### AutoSTOP™ Tire Inflator

- 5 Minute fill time
- Digital, back-lit display for night time use
- Countdown timer displays remaining fill time

22-5-16030-8 - 4 pcs. Open Stock



### Compact Tire Inflator

- 7 Minute fill time
- LED work light
- Digital gauge

22-5-16020-8 - 4 pcs. Open Stock



### Ultra Compact Tire Inflator

- 10 Minute fill time
- LED work Light
- Analog dial gauge

22-5-16010-8 - 4 pcs. Open Stock

# SmartTIP™ GAUGES

*Other Gauges Don't Measure Up — Drive Sales With SmartTIP™ Technology*

*Only SmartTIP™ tire gauges engage inside the valve stem for a more secure, air-tight connection*

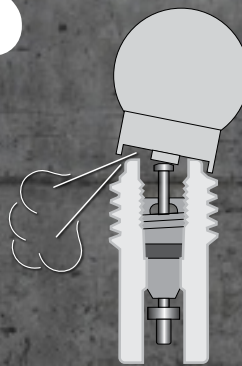

**STANDARD TIPS**

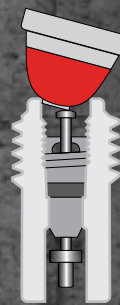

**SmartTIP™**



**SmartTIP™ Digital Gauge with Bleeder Valve 0-150 PSI**

- Attached bleeder valve
- Attached tread gauge to measure tread depth
- For all car, truck, SUV & RV tires

**22-5-16140-8** - 6 pcs. Open Stock



**SmartTIP™ Digital Gauge with Tread Gauge 0-150 PSI**

- Work light
- Attached tread gauge to measure tread depth
- For all car, truck, SUV & RV tires

**22-5-16130-8** - 6 pcs. Open Stock



**SmartTIP™ Digital Gauge with Work Light 0-100 PSI**

- Work light
- Back-lit display
- For all car, truck, SUV & RV tires
- **22-5-16120-8** - 6 pcs. Open Stock



**SmartTIP™ Digital Gauge 0-100 PSI**

- Back-lit display
- For all car, truck, SUV & RV tires
- **22-5-16110-8** - 6 pcs. Open Stock



#### SmartTIP™ Digital Tire Gauge 0-150 PSI

- For all car, truck, SUV, motorcycle & RV tires
- Back-lit display for easy-to-read tire pressure
- Chrome-plated steel body

22-5-70927-8 - 6 pcs. Open Stock



#### Dual SmartTIP™ Tire Gauge 10-120 PSI

- For all car, truck, SUV, motorcycle & RV tires
- Dual foot chuck
- High pressure

22-5-70926-8 - 6 pcs. Open Stock



#### SmartTIP™ Tire Gauge 10-50 PSI

- For vehicle tires & low pressure applications
- Chrome-plated steel body
- Two-sided indicator bar

22-5-70925-8 - 6 pcs. Open Stock

## GROW YOUR BUSINESS WITH A FAMILY THAT'S WELL CONNECTED

- **SmartTIP™ Technology**

Engages inside the valve core



- **Better Connections**

Gives 15° of flexibility for a more secure air-tight connection

- **Features for Everyone**

Pencil, digital or back-lit display, our family can meet your shoppers every need



### Hand Tire Pump

- 100 PSI capacity
  - 21" Inflator hose
  - Sport ball adapter kit
- 22-5-70008-8** - 6 pcs. Open Stock



### Hand Tire Pump

- 70 PSI capacity
  - 18" Inflator hose
  - Quick release thumb lock valve
- 22-5-00088-8** - 12 pcs. Open Stock



### Hand Tire Pump

- 50 PSI capacity
  - 18" Inflator hose
  - Quick release thumb lock valve
- 22-5-08700-8** - 12 pcs. Open Stock



### Hand Pump - Viaggio 7550GP with Dial Gauge

- 160 PSI capacity
  - 26" Inflator hose
  - Thumb lock valve works on Schrader and Presta valves
  - Ideal for road bikes, mountain bikes and more
- 7550GP** - 10 pcs. Open Stock



### Hand Pump - Max Air 7500MA

- 70 PSI capacity
  - 21" Inflator hose
  - Quick release thumb lock valve
  - Ideal for auto, mowers, tractors, bicycles and more
- 7500MA** - 12 pcs. Open Stock



### Hand Pump - Air Support 7450FP

- 100 PSI capacity
  - 14" Inflator hose
  - Quick release thumb lock valve
  - Ideal for bicycles, sport balls, small inflatables and more
- 7450FP** - 10 pcs. Open Stock



### Hand Pump - Hose Assembly 5100H

- 150 PSI capacity
  - 22" Universal replacement hose
  - Quick release thumb lock valve
- 5100H** - 1 pc. Open Stock



### 5 Gallon Portable Air Tank

- 125 PSI max operating pressure
  - Dial pressure gauge
  - Safety pressure bypass valve with manual override
  - 3 Foot air hose
- 22-5-70005-8** - 1 pc. Open Stock



### Digital Tire Inflation Air Gun

- 0-150 PSI pressure range with blue backlit display
  - For use with air tanks or compressors
  - Quick connect air chuck & built-in bleeder valve
  - (2) "AAA" batteries included
- 22-5-70525-8** - 6 pcs. Open Stock



### Inner Tube

- 700/750 R15/16
  - Radial or bias ply
  - Air tube
- 22-5-70911-8** - 6 pcs. Open Stock



### Inflator Needles

- Use with sport balls and other inflatable products
  - Metal construction
  - 2 Standard inflation needles
- 22-5-70083-8** - 12 pcs. Open Stock



### 13 Piece ATV Tire Repair Kit

- Complete ATV tire repair solution
  - Convenient kit
  - Dual tool ATV kit
- 22-5-70132-8** - 6 pcs. Open Stock





**47 Piece Tire Maintenance Kit**

- Deluxe complete tire repair solution in convenient storage case
- Tire toolbox
- Instruction booklet and carry case with handle

22-5-70126-8 - 6 pcs. Open Stock



**32 Piece Tire Maintenance Kit**

- Compact, complete tire repair solution in convenient storage case
- Deluxe tire tool box
- Gauge, tools, plugs and patches

22-5-70128-8 - 6 pcs. Open Stock



22-5-70005-8



**18 Piece Tire Maintenance Kit**

- Rapid tire repair and maintenance kit with (2) Speed Plug™ tire plugs
- Gauge, tools, cores and valve caps
- Stores easily inside a glove compartment

22-5-00130-8 - 4 pcs. Open Stock



**Truck 8 Piece Tubeless Tire Repair Kit**

- Standard t-handle repair tools
- (5) 6" Heavy-duty tire plugs
- Rubber cement

22-5-00419-8A - 12 pcs. Open Stock



**Pro 8 Piece Tubeless Tire Repair Kit**

- Pro style pistol grip repair tools
- (5) 4" Standard plugs
- Pencil gauge

22-5-70110-8 - 6 pcs. Open Stock



**Heavy-duty 7 Piece Tubeless Tire Repair Kit**

- Standard t-handle repair tools
- (5) Heavy-duty 4" plugs

22-5-70106-8 - 12 pcs. Open Stock



**5 Piece Tubeless Tire Repair Kit**

- Straight handle tire repair tools
- (3) Standard 4" plugs

22-5-00104-8 - 6 pcs. Open Stock



**8 Piece Tubeless Tire Repair Kit**

- Split eye straight tire repair tool
- (6) Plugs
- Rubber cement

22-5-00101-8 - 6 pcs. Open Stock



**8 Piece Tubeless Tire Repair Kit**

- Split eye straight tire repair tool
- (6) Plugs
- Rubber cement

22-5-00103-8 - 6 pcs. Open Stock



**8 Piece Tubeless Tire Repair Kit**

- Split eye straight tire repair tool
- (6) Vulca repair strips
- Rubber cement

22-5-00108-8 - 12 pcs. Open Stock



**5 Piece Tubeless Tire Repair Kit**

- Split eye straight tire repair tool
- (4) 6" Standard plugs

**22-5-00102-8** - 12 pcs. Open Stock



**100 Piece Patch Kit**

- For all types of rubber repairs
- (100) Assorted patches
- Rubber cement
- (2) Buffers

**22-5-70184-8** - 6 pcs. Open Stock



**33 Piece Tire and Rubber Patch Kit**

- (29) Assorted patches
- Rubber cement
- Buffer
- Storage can

**22-5-00406-8A** - 12 pcs. Open Stock



**15 Piece Tire Patch Kit - Mini-Can**

- Includes (10) feather edge patches
- Rubber cement
- Tire pencil
- Buffer

**22-5-70407-8** - 12 pcs. Open Stock



**8 Piece Patch Kit - EZ Fix Deluxe**

- For all rubber repairs
- Patches
- Rubber cement
- Buffer

**22-5-00401-8** - 12 pcs. Open Stock



**5 Piece Patch Kit - Radial/Medium**

- For heavy-duty repairs
- Patches
- Rubber cement
- Buffer

**22-5-70414-8** - 12 pcs. Open Stock



**7 Piece Patch Kit - Chemical/Round**

- For all rubber repairs
- Patches
- Rubber cement
- Buffer

**22-5-70405-8** - 12 pcs. Open Stock



**4 Piece Heavy-duty Patch Kit**

- (2) Heavy-duty 2 7/8" x 3 5/8" patches
- Rubber cement
- Buffer

**22-5-08826-8** - 6 pcs. Open Stock

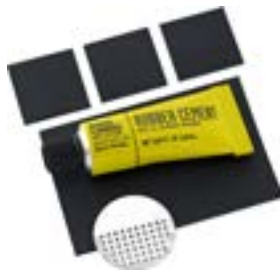

**6 Piece Patch Kit - EZ Fix Bike**

- For bicycle tire repairs
- Patches
- Rubber cement
- Buffer

**22-5-00402-8** - 12 pcs. Open Stock



**6 Piece EZ Fix Patch Kit - Box**

- (4) Patches
- Rubber cement
- Buffer

**22-5-00411-8** - 10 pcs. Open Stock



**30 Piece Black Plug Refills**

- 4" Standard plugs
- Durable repair plugs
- For tubeless off-road tires

**22-5-70111-8** - 4 pcs. Open Stock



**5 Piece Black Plug Refills**

- 7" Standard plugs
- Durable repair plugs
- For tubeless off-road tires

**22-5-00420-8** - 12 pcs. Open Stock

# SPEED PLUG™ TIRE REPAIR PLUGS

**20X FASTER** THAN TRADITIONAL TIRE STRING PLUGS



**FAST.  
EASY.  
CLEAN.**



## ELIMINATES THE **AWFUL** WORK OF STRING PLUGS

Have you ever plugged a tire with traditional strings? It's a dirty, strenuous, awful job. Even the best pluggers take about 15 minutes to complete the task. Now you can do the same job 20 times faster with a Speed Plug™ by Genuine Victor™. Just screw it in and snap off the top. It's fast, easy and clean. Drive sales by eliminating the awful work of tire repair for your shoppers



**REMOVE**



**SCREW IN**

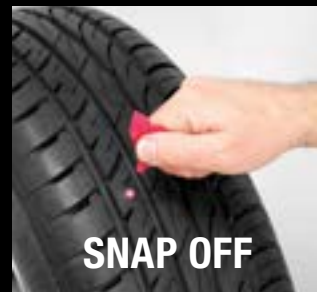

**SNAP OFF**



### 5 Piece Speed Plug Kit with Tool

- Eliminates the awful work of string plugs
- Up to 20x faster than traditional tire string plugs
- (4) Large plugs
- (1) Nail puller

22-5-70207-8 - 4 pcs. Open Stock



### 4 Piece Speed Plug Kit

- Eliminates the awful work of string plugs
- Up to 20x faster than traditional tire string plugs
- (4) Large plugs

22-5-70204-8 - 4 pcs. Open Stock

GENUINE VICTOR™ TIRE SAFETY



### 5 Piece Brown Plug Refills

- 4" heavy-duty plugs
  - Durable repair plugs
  - For tubeless off-road tires
- 22-5-70112-8** - 12 pcs. Open Stock



### 5 Piece Black Plug Refills

- 4" Standard plugs
  - Durable repair plugs
  - For tubeless off-road tires
- 22-5-70105-8** - 6 pcs. Open Stock



### Tube Rubber Cement – 1 oz. Tube

- For all rubber and tire repairs
  - Universal formula
  - Works great for patching
- 22-5-70600-8** - 12 pcs. Open Stock



### Rubber Cement – 8 oz. Can

- For all rubber and tire repairs
  - Universal formula
  - Works great for patching
- 22-5-70599-8** - 2 pcs. Open Stock



### Tire Crayon

- White tire marker
  - Mark tire repair locations
  - Touch up whitewall and tire lettering
- 22-5-60181-8** - 6 pcs. Open Stock



### Digital Pressure Gauge with Lighted Display

- 5-99 PSI pressure range
  - Built-in tire depth gauge
  - Back-lit display
- 22-5-70003-8** - 6 pcs. Open Stock



### Digital Pressure Gauge with Lighted Display

- 5-99 PSI pressure range
  - Back-lit display
  - Ergonomic design
- 22-5-60104-8** - 6 pcs. Open Stock



### Digital Pressure Gauge - Pistol Grip

- 5-59 PSI pressure range
  - (4) Plastic valve caps
  - Ergonomic pistol grip design
- 22-5-00879-V** - 6 pcs. Open Stock



### Digital Pencil Pressure Gauge

- 5-99 PSI pressure range
  - Back-lit display
  - Bar and PSI settings
- 22-5-60012-8** - 6 pcs. Open Stock



### SUV/RV Dial Pressure Gauge

- 5-75 PSI pressure range
  - Hose, dual foot and bleeder valve
- 22-5-70874-8** - 6 pcs. Open Stock



### Pro Dial Pressure Gauge

- 5-100 PSI pressure range
  - Hose and bleeder valve
- 22-5-70108-8** - 6 pcs. Open Stock



### Pro Dial Pressure Gauge

- 5-60 PSI pressure range
  - Bleeder valve
- 22-5-70881-8** - 4 pcs. Open Stock



### Mini Dial Pressure Gauge

- 5-60 PSI pressure range
  - Bleeder valve
  - Carry case
- 22-5-70023-8** - 6 pcs. Open Stock



### Mini Dial Pressure Gauge

- 5-60 PSI pressure range
  - Metal construction
  - Convenient to store
- 22-5-08770-8** - 6 pcs. Open Stock



### Dial Pressure Gauge

- 10-60 PSI pressure range
  - Bleeder valve
- 22-5-00890-8** - 6 pcs. Open Stock



### Dial Pressure Gauge

- 10-100 PSI pressure range
  - Bleeder valve
- 22-5-00897-8** - 6 pcs. Open Stock



### Truck Long Dual Foot Pencil Pressure Gauge – Black

- 10-150 PSI pressure range
  - 4-Sided metal indicator bar
  - Lanyard ring included
- 22-5-71106-8** - 6 pcs. Open Stock



### Truck Long Dual Foot Pencil Pressure Gauge – Chrome

- 10-150 PSI pressure range
  - 2-Sided indicator bar
  - Lanyard ring included
- 22-5-00889-8** - 6 pcs. Open Stock



### Truck Short Dual Foot Pencil Pressure Gauge – Black

- 10-120 PSI pressure range
  - (4) Black plastic valve caps
  - 4-Sided indicator bar
- 22-5-60105-8** - 6 pcs. Open Stock



### Dual Foot Pencil Pressure Gauge – Chrome

- 10-120 PSI pressure range
  - (4) Black plastic valve caps
  - 4-Sided indicator bar
- 22-5-00896-8** - 6 pcs. Open Stock



### Heavy-duty Pencil Pressure Gauge

- 20-120 PSI pressure range
  - 4-Sided indicator bar
  - High pressure
- 22-5-00895-8** - 6 pcs. Open Stock



### Standard Pencil Pressure Gauge

- 10-100 PSI pressure range
  - 2-Sided indicator bar
  - Pocket clip
- 22-5-00900-8** - 6 pcs. Open Stock



### Deluxe Pencil Pressure Gauge

- 10-50 PSI pressure range
  - 4-Sided indicator bar
- 22-5-00894-8** - 6 pcs. Open Stock



### Stainless Steel Pencil Pressure Gauge

- 10-50 PSI pressure range
  - (4) Black plastic valve caps
  - 4-Sided indicator bar
- 22-5-00876-8** - 6 pcs. Open Stock



**Standard Pencil Pressure Gauge**

- 5-50 PSI pressure range
- 2-Sided indicator bar
- Chrome plated steel body

**22-5-70902-8** - 6 pcs. Open Stock



**Low Pressure Pencil Pressure Gauge**

- 1-20 PSI pressure range
- 4-Sided indicator bar
- Pocket-clip

**22-5-00887-8** - 6 pcs. Open Stock



**Digital Pocket Pressure Gauge - Triangle**

- 0-99 PSI pressure range
- Accurate reading
- Convenient to store

**22-5-84042-8** - 3 pcs. Open Stock - Bulk



**Digital Pocket Pressure Gauge - Square**

- 0-99 PSI pressure range
- Accurate reading
- Convenient to store

**22-5-84043-8** - 3 pcs. Open Stock - Bulk



**Digital Pressure Gauge - Sport**

- 5-99 PSI pressure range
- Accurate reading
- Rubberized grip
- Back-lit display and tip

**22-5-60096-8** - 6 pcs. Open Stock - Bulk



**Mini Dial Pressure Gauge - Tread/Magnet**

- 5-60 PSI pressure range
- Convenient to store
- Includes magnet

**22-5-60190-8** - 12 pcs. Open Stock - Bulk



**Mini Dial Pressure Gauge - Magnet**

- 5-60 PSI pressure range
- Convenient to store
- Includes magnet

**22-5-60195-8** - 12 pcs. Open Stock - Bulk



**Mini Dial Pressure Gauge - Tread**

- 5-60 PSI pressure range
- Sure grip rubber tread over-mold
- Convenient to store

**22-5-60090-8** - 12 pcs. Open Stock - Bulk



**Dual Foot Pencil Pressure Gauge**

- 10-120 PSI pressure range
- 4-Sided indicator bar
- High pressure
- Pocket clip

**22-5-60087-8** - 12 pcs. Open Stock - Bulk



**Standard Pencil Pressure Gauge**

- 10-50 PSI pressure range
- 2-Sided indicator bar
- Pocket clip

**22-5-60084-8** - 12 pcs. Open Stock - Bulk



**Mini Pencil Pressure Gauge - Magnet**

- 10-50 PSI pressure range
- 4-sided indicator bar
- Includes magnet

**22-5-60116-8M** - 15 pcs. Open Stock - Bulk



**Standard Pencil Pressure Gauge - 24 PC Display**

- 10-50 PSI pressure range
- Pocket clip
- Xtreme designs

**22-5-86724-VCD24** - 24 pcs. Open Stock Display



### Valve Caps – Paw Prints

- (4) Aluminum valve caps
- Plastic thread insert
- Protects your tire valve cores

22-5-70747-8 - 12 pcs. Open Stock



### Valve Caps – Black Hex

- (4) Aluminum valve caps
- Black anodized finish
- Protects your tire valve cores

22-5-70341-8 - 12 pcs. Open Stock



### Valve Caps – Sport

- (4) Aluminum valve caps
- Plastic thread insert
- Protects your tire valve cores

22-5-70260-8 - 12 pcs. Open Stock



### Valve Caps – Sport

- (4) Black aluminum valve caps
- Plastic thread insert
- Protects your tire valve cores

22-5-00726-8 - 6 pcs. Open Stock



### Valve Caps – Sport

- (4) Black aluminum valve caps
- Plastic thread insert
- Protects your tire valve cores

22-5-70173-8 - 12 pcs. Open Stock



### Valve Caps – Sport

- (4) Red aluminum valve caps
- Plastic thread insert
- Protects your tire valve cores

22-5-70265-8 - 12 pcs. Open Stock



### Valve Caps – Sport

- (4) Blue aluminum valve caps
- Plastic thread insert
- Protects your tire valve cores

22-5-70266-8 - 12 pcs. Open Stock



### Valve Caps – Sport

- (4) Dark blue aluminum valve caps
- Plastic thread insert
- Protects your tire valve cores

22-5-70267-8 - 12 pcs. Open Stock



### Valve Caps – Chrome Skulls

- (4) Chrome skull valve caps
- Protects your tire valve cores

22-5-70851-8 - 12 pcs. Open Stock



### Valve Caps & Sleeves – Chrome

- (4) Chrome valve caps and sleeves
- Protects your tire valve cores

22-5-70722-8 - 12 pcs. Open Stock



### Valve Caps – Chrome Hex

- (4) Chrome hex valve caps
- Protects your tire valve cores

22-5-00716-8 - 12 pcs. Open Stock



### Valve Caps – Slotted Head Chrome

- (4) Chrome valve caps
- Caps include valve core tool
- Protects your tire valve cores

22-5-00715-8 - 12 pcs. Open Stock



### Valve Caps – Plastic (Nitrogen)

- (4) Chrome/green plastic valve caps
  - Replacement for old valve caps
  - Durable plastic
- 22-5-70721-8** - 12 pcs. Open Stock



### Valve Caps – Plastic

- (4) Chrome/plastic valve caps
  - Replacement for old valve caps
  - Durable plastic
- 22-5-70746-8** - 12 pcs. Open Stock



### Valve Caps – Plastic

- (4) Gray plastic valve caps
  - Replacement for old valve caps
  - Durable plastic
- 22-5-70731-8** - 12 pcs. Open Stock



### Valve Caps – Plastic

- (4) Black plastic valve caps
  - Replacement for old valve caps
  - Durable plastic
- 22-5-70709-8** - 12 pcs. Open Stock



### Valve Caps – TPMS Plastic

- (4) Black TPMS plastic valve caps
  - Replacement for old valve caps
  - Durable plastic
- 22-5-70707-8** - 12 pcs. Open Stock



### Tire Valves – Metal

- 2 Pack
  - 1¼" Long
  - Bolt-in design
- 22-5-70410-8** - 6 pcs. Open Stock



### TPMS Snap-in Tire Valve

- Single pack
  - Multi-purpose
  - Easy to install
- 22-5-70200-8** - 12 pcs. Open Stock



### Tubeless Tire Valves – TR418

- 2 Pack
  - 2" Long
  - Snap-in design
- 22-5-70418-8** - 12 pcs. Open Stock



### Tubeless Tire Valves – TR415

- 2 Pack
  - 1¼" Long
  - Snap-in design
- 22-5-70415-8** - 12 pcs. Open Stock



### Tubeless Tire Valves – TR413

- 2 Pack
  - 1½" Long
  - Snap-in design
- 22-5-70413-8** - 12 pcs. Open Stock



### Valve Extensions – Metal

- 4 Pack
  - 1¼" Long
- 22-5-70718-8** - 12 pcs. Open Stock



### Valve Extensions – Plastic

- 4 Pack
  - 1½" Long
- 22-5-00713-8** - 12 pcs. Open Stock



# New Products... New Look



## Valve Extensions – Plastic

- 4 Pack
  - 1¼" Long
- 22-5-70712-8** - 12 pcs. Open Stock



## Valve Extensions – Plastic

- 4 Pack
  - ¾" Long
- 22-5-00711-V** - 12 pcs. Open Stock



## Tire Tread Depth Gauge

- Chrome with pocket clip
  - Tire tool
  - Ensure safe driving
- 22-5-70174-8** - 6 pcs. Open Stock



## 4-Way Valve Tool – Valve Cores

- 5 Pack
  - 4-Way valve tool
  - (4) Standard valve cores
- 22-5-70141-8** - 12 pcs. Open Stock



## Valve Tool – 4-Way

- Single pack
  - 4-Way valve tool
- 22-5-00714-8** - 12 pcs. Open Stock



## Valve Cores – Short

- 4 Pack
  - Standard valve cores
- 22-5-00710-8** - 12 pcs. Open Stock

A close-up photograph of a car's interior, focusing on the steering wheel and dashboard. The steering wheel is black with silver accents and features a control panel with buttons for navigation and communication. The dashboard is also black with silver trim. The text "COMFORT & ORGANIZATION WITH QUALITY & INNOVATION" is overlaid in large, white, bold letters in the upper left corner.

# COMFORT & ORGANIZATION WITH QUALITY & INNOVATION

PREMIUM ACCESSORIES FOR  
PROTECTION AND CONVENIENCE



# PROTECTION & CONVENIENCE

## SUPERIOR TECHNOLOGY

Delivering performance has been our passion for decades and we continue to develop pioneering innovation to improve the consumer experience

## DESIGNS FOR EVERY STYLE

Different shoppers appreciate different styles. That's why we've combined forward fashion with scientific method to develop a broad, impactful portfolio that will optimize your shelf and drive greater sales

## BRANDS THAT RESONATE

Some people explore the outdoors, some explore the sights of the city. Wherever an adventure takes your shopper, we have the brand for them. From Bell<sup>®</sup>, blue-collared ambition to GoGear<sup>™</sup> practicality; from the active Body Glove<sup>®</sup> lifestyle to the provocative energy of David Gonzales; we have the brands that your shoppers know and love



BODY GLOVE





# BODY GLOVE

## CREATE HAPPINESS

In 1953 twins Bill and Bob Meistrell designed the first practical neoprene wetsuit in a pool in Boonville, Missouri, and Body Glove® was born. Since then Body Glove® has grown to be a leading lifestyle brand worldwide and successfully launched products across dozens of categories, from wetsuits to now vehicle accessories. Trusted as an active outdoor brand, customers can continue to enjoy Body Glove®'s innovation and quality in the comfort of their vehicles.



**NEW**

### Body Glove® Grid Sideless Seat Cover

- Sleek and sporty Body Glove® seat cover
- Convenient front pocket

22-1-70445-9 - 4 pcs. Open Stock

PROTECTION & CONVENIENCE





NeverWet

**HYPERFIT™**

**Body Glove® Universal Bucket Seat Cover with NeverWet®**

- Water repellent
  - Durable and comfortable neoprene
- 22-1-70359-9 - 4 pcs. Open Stock



NeverWet

**HYPERFIT™**

**Body Glove® Bench Seat Cover with NeverWet®**

- Water repellent
  - Patented middle seat belt shoulder strap access panels
- 22-1-70395-9 - 4 pcs. Open Stock



NeverWet

**HYPERFIT™**

**Body Glove® Seat Cover Kit with NeverWet®**

- Water repellent
  - Patented middle seat belt shoulder strap access panels
- 22-1-70418-9 - 2 pcs. Open Stock



**HYPERFIT™**

**Body Glove® Universal Bucket Seat Cover**

- Officially licensed Body Glove® cool neoprene material
- 22-1-70331-9 - 4 pcs. Open Stock



**HYPERFIT™**

**Body Glove® Universal Bucket Seat Cover - Smoothie**

- Sleek and sporty Body Glove® seat cover
  - Zig-zag stitching for style and durability
- 22-1-70231-9 - 4 pcs. Open Stock



**Body Glove® Bench Seat Cover**

- Officially licensed Body Glove® cool neoprene material
  - Patented middle seat belt shoulder strap access panels
- 22-1-70332-9 - 4 pcs. Open Stock



**HYPERFIT™**

**Body Glove® Low-Back Bucket Seat Cover - Hex Black (Sold as a Pair)**

- New core style with Body Glove® brand
  - Quilted neoprene for style and comfort
- 22-1-70448-9 - 4 pcs. Open Stock



**HYPERFIT™**

**Body Glove® Low-Back Bucket Seat Cover - Hex Gray (Sold as a Pair)**

- New core style with Body Glove® brand
  - Quilted neoprene for style and comfort
- 22-1-70449-9 - 4 pcs. Open Stock



**HYPERFIT™**

**Body Glove® Low-Back Bucket Seat Cover - Hex Tan (Sold as a Pair)**

- New core style with Body Glove® brand
  - Quilted neoprene for style and comfort
- 22-1-70450-9 - 4 pcs. Open Stock



**HYPERFIT™**

**Body Glove® Universal Bucket Seat Cover - Red**

- Sleek and sporty Body Glove® seat cover
- Zig-zag stitching for style and durability

22-1-70381-9 - 4 pcs. Open Stock



**HYPERFIT™**

**Body Glove® Universal Bucket Seat Cover - Blue**

- Sleek and sporty Body Glove® seat cover
- Zig-zag stitching for style and durability

22-1-70382-9 - 4 pcs. Open Stock



**HYPERFIT™**

**Body Glove® Low-Back Bucket Seat Cover - Smoothie**

- Sleek and sporty Body Glove® seat cover
- Zig-zag stitching for style and durability

22-1-70239-9 - 4 pcs. Open Stock



**MAKE WAVES OF CHANGE**



**Body Glove® BG Original License Plate Frame**

- Retro-inspired Body Glove® design
- Durable metal frame

22-1-46728-8 - 4 pcs. Open





**HYPERFIT™**

**Body Glove® Low-Back  
Bucket Seat Cover - Red**

- Same great Body Glove® seat cover now with colored bolsters
- Zig-zag stitching for style and durability

22-1-70387-9 - 4 pcs. Open Stock



**Body Glove®  
Cargo Net with Mounting Kit**

- Ideal for the rear cargo areas of cars, vans, trucks & SUVs
- 45" x 24" size
- Cargo net stretches to 60"

22-1-70412-8 - 4 pcs. Open Stock



**Body Glove®  
Seat Gap Net Organizer**

- Pocketed hammock assembly secures items between front seats
- 12" x 11" size, stretches to 20"

22-1-70411-8 - 4 pcs. Open Stock



**Body Glove® Red  
Steering Wheel Cover**

- Body Glove® steering wheel cover now with colors
- Zig-zag stitching for style and durability

22-1-97492-9 - 6 pcs. Open Stock



**Body Glove® Smoothie  
Steering Wheel Cover**

- Body Glove® steering wheel cover now with two-tone matte black
- Zig-zag stitching for style and durability

22-1-97505-9 - 6 pcs. Open Stock



**Body Glove®  
Steering Wheel Cover**

- Officially licensed Body Glove® cool neoprene material

22-1-97443-9 - 6 pcs. Open Stock



**Body Glove®  
Console Cooler**

- Officially licensed Body Glove® cool neoprene material

22-1-70330-8 - 6 pcs. Open Stock



**Body Glove®  
Visor Organizer**

- Officially licensed Body Glove® cool neoprene material

22-1-70329-8 - 4 pcs. Open Stock



**Body Glove®  
Magnetic Sunglass Case**

- Visor mounted case
- Magnetic to remove/attach easily
- Includes hook for backpacks and more

22-1-70340-8 - 4 pcs. Open Stock



# FUEL YOUR OBSESSION



Mossy Oak® started from a deep and abiding passion to connect with the Great Outdoors. Over the past 30-plus years, that passion has grown into an obsession to make more connections to wild critters and wild places while helping people live their best life outdoors. The line of Mossy Oak® seat covers are among the latest improvements from our workshop, with several features to help you ride in comfort and style.







**Mossy Oak® Work Wear Black Seat Cover (Truck, 1-Piece)**

- Specifically designed with trucks and large SUVs in mind for that full size fit
- Premium Padding – Interwoven luxury foam provides contoured fit and superior comfort
- Compatible with most side air bags to help maintain personal protection in your vehicle

22-1-70008-9 - 3 pcs. Open Stock



**Mossy Oak® Work Wear Tan Seat Cover (Truck, 3-Piece)**

- Specifically designed with trucks and large SUVs in mind for that full size fit
- Premium Padding – Interwoven luxury foam provides contoured fit and superior comfort
- Compatible with most side air bags to help maintain personal protection in your vehicle

22-1-70009-9 - 3 pcs. Open Stock



**Mossy Oak® Blackout Obsession Seat Cover (Sold as a Pair)**

- Exclusive Mossy Oak® design subtly reflects your passion for the outdoors
- Compatible with most side air bags to help maintain personal protection in your vehicle

22-1-70007-9 - 4 pcs. Open Stock



**Mossy Oak® Blackout Obsession Steering Wheel Cover**

- Exclusive Mossy Oak® design subtly reflects your passion for the outdoors
- HyperFlex Core™

22-1-70011-9 - 6 pcs. Open Stock



**Mossy Oak® Visor Organizer**

- Easy access holder for pen, pencil or tire gauge
- Pocket for tickets, receipts, registration, proof of insurance and change
- Large zippered pocket for maps and other documents

22-1-70012-8 - 4 pcs. Open Stock



**Mossy Oak® Large Organizer**

- Hook and loop secures organizer in place and upright
- Convenient handle for organization on the go
- MOLLE panel for external storage

22-1-70013-8 - 12 pcs. Open Stock



# HYPERFIT™ SEAT COVERS

## LASTING. SNUG. FIT.

Upgrade your shoppers to consumer preferred HyperFit™ technology. Unlike loose straps that can't be tightened, the distinctive HyperFit™ Grip Lock system delivers 360° of form-fitting tension that won't bunch or stretch out over time, ensuring your seat cover will always have a tailored look. Give your shoppers a seat cover with a long-lasting, snug fit—HyperFit™

UNIVERSAL FIT. TAILORED LOOK. THE HYPERFIT™ DIFFERENCE.



COVER WITHOUT **HYPERFIT™**



**HYPERFIT™**





**HYPERFIT™**

**Baja Blanket Universal Bucket Seat Cover**

- Baja jacket inspired design
- 22-1-56258-9 - 4 pcs. Open Stock



**HYPERFIT™**

**Baja Blanket Bench Seat Cover**

- Baja jacket inspired design
- 22-1-56259-8 - 1 pc. Open Stock



**HYPERFIT™**

**Indigenous Blanket Low-Back Bucket Seat Covers (Sold as a Pair)**

- Tribal pattern woven durable blanket material
- 22-1-55508-9 - 4 pcs. Open Stock



**HYPERFIT™**

**Mayan Mint Low-Back Bucket Seat Covers (Sold as a Pair)**

- Mayan pattern woven durable blanket material
- 22-1-58051-9 - 4 pcs. Open Stock



**HYPERFIT™**

**Mayan Mint Low-Back Bucket Seat Cover**

- Mayan pattern woven durable blanket material
- 22-1-58048-9 - 4 pcs. Open Stock



**HYPERFIT™**

**Gray Marle Low-Back Bucket Seat Cover (Sold as a Pair)**

- Stylish and comfortable marle gray fabric bolstered on neoprene
- 22-1-58228-9 - 4 pcs. Open Stock





**Sideless Tan**

- Compatible with built-in armrests and harness seatbelts
- 22-1-58255-9** - 4 pcs. Open Stock



**Sideless Gray**

- Compatible with built-in armrests and harness seatbelts
- 22-1-58254-9** - 4 pcs. Open Stock

**Keep it dry,  
keep it clean, keep it**



There's nothing better than creating memories... like diving through the crashing waves of your favorite beach or gazing at a sunset streaming over the mountaintops. But some memories we try to forget. Like the grape juice stain on the back seat of your vehicle or the muddy paw prints of your best friend. For times like these, it's great to have NeverWet® seat covers. NeverWet® is an ingredient that makes these seat covers super water resistant. That way, spills can easily be wiped up, keeping your seat cover—and seat underneath—dry and clean



**HYPERFIT™**

**All Terrain Black Universal Bucket Seat Cover**

- Rugged and durable 600D nylon
- 22-1-55303-A** - 1 pc. Open Stock



**All Terrain Black Bench Seat Cover**

- Rugged and durable 600D nylon
- 22-1-55302-A** - 1 pc. Open Stock



**NeverWet® Black Bench Seat Protector**

- Treated with NeverWet® for superhydrophobicity
- 22-1-70337-3** - 4 pcs. Open Stock
- 22-1-70337-8** - 4 pcs. Open Stock



**NeverWet® Black Bucket Seat Protector**

- Treated with NeverWet® for superhydrophobicity
- 22-1-70336-3** - 4 pcs. Open Stock
- 22-1-70336-8** - 4 pcs. Open Stock





# COUNTER CULTURE FOR YOUR SHOPPER'S CAR

David Gonzales is one of the most influential artists of both car & bike culture. Now his designs can be enjoyed in your vehicle



### DGA™ Rose Steering Wheel Cover

- Amazing printed graphics
- Includes many of the great DGA™ art pieces

22-1-97478-9 - 6 pcs. Open Stock  
22-1-97478-8 - 2 pcs. Open Stock



### DGA™ Bonita License Plate Frame

- Amazing printed graphics
- Includes many of the great DGA™ art pieces

22-1-46725-8 - 4 pcs. Open Stock



### DGA™ Bonitas Steering Wheel Cover

- Amazing printed graphics
- Includes many of the great DGA™ art pieces

22-1-97653-924 - 24 pcs. Open Stock



### HYPERFIT™

### DGA™ Skin Deep Seat Cover

- Authentic licensed sublimated graphics on microfiber

22-1-70274-9 - 4 pcs. Open Stock



### HYPERFIT™

### DGA™ Ride or Die Seat Cover

- Authentic licensed sublimated graphics on microfiber

22-1-70296-9 - 4 pcs. Open Stock



### HYPERFIT™

### DGA™ Ride or Die Seat Covers (Sold as a Pair)

- Authentic licensed sublimated graphics on microfiber

22-1-70416-9 - 4 pcs. Open Stock



### HYPERFIT™

### DGA™ Bombshell Seat Covers (Sold as a Pair)

- Authentic licensed sublimated graphics on microfiber

22-1-70417-9 - 4 pcs. Open Stock





# HYPERFLEX CORE™

## STEERING WHEEL COVERS



**NEW Improved Core**

- #1 Steering Wheel Cover Brand
- More Durable & Easier to Install  
Than Standard Steering Wheel Covers

**2X**  
**EASIER  
TO INSTALL**  
THAN STANDARD  
STEERING WHEEL COVERS



PROTECTION & CONVENIENCE



# STEERING WHEEL COVER BEST SELLERS



22-1-97505-9

22-1-97443-9

22-1-97478-9

22-1-97049-9

22-1-97596-9

22-1-97505-9	Body Glove® Smoothie	Two-tone matte black neoprene with zig-zag stitching
22-1-97443-9	Body Glove® Black	Officially licensed Body Glove® neoprene material
22-1-97478-9	David Gonzales Art	Incorporates many amazing DGA™ art pieces
22-1-97049-9	Moxie	Faux fur for style and comfort
22-1-97596-9	Fluffy Black	Soft faux fur for luxury, style and comfort



22-1-97039-9

22-1-97114-9

22-1-97152-9

22-1-97487-9

22-1-97038-9

22-1-97039-9	Sport Gel Blue	Classic sport look with blue accents
22-1-97114-9	Baja Blanket	Best selling pattern for all to enjoy
22-1-97152-9	Black Wood Chrome	Modern burlwood with chrome accents
22-1-97487-9	Mayan Mint	Just like the baja blanket, but with new color and design
22-1-97038-9	Sport Gel Red	Classic sport look with red accents



22-1-96126-9

22-1-97616-9

22-1-97653-9

22-1-70011-9

Part #	Product	Description
22-1-96126-9	Indigenous Blanket	Tribal inspired pattern on blanket material
22-1-97616-9	Sunset Blanket	Soft & durable sunset inspired on blanket material
22-1-97653-9	 DGA™ Bonitas	Includes many of the great DGA™ art pieces
22-1-70011-9	 Mossy Oak® Blackout	Exclusive OE Blackout camo pattern
22-1-97654-9	 Rainbow	Shimmery rainbow wrapped with leather
22-1-97652-9	 Silver Scale	Sleek and sporty silver scaled design
22-1-97315-9	Stripe Bling Black	Inset diamond accents with stripes
22-1-97037-9	Chicane	Sports performance inspired design
22-1-97311-9	Anodized Silver	Sleek and sporty anodized piping



22-1-97654-9

22-1-97652-9

22-1-97315-9

22-1-97037-9

22-1-97311-9







Part #	Product	Description
22-1-97655-9	 Leopard Fluffy	Fuax fur for style and comfort
22-1-97657-9	 Leopard Fluffy Thumbgrip	Contoured thumb grips with a Fuax fur for style and comfort
22-1-97658-9	 Burlwood Grip	Ergonomic grip with burlwood pattern
22-1-97313-9	Stratos	Classic two-tone design for added style
22-1-97023-9	Pleated Black	Classic look and design for added style
22-1-97651-9	 Blue Contrast Quilted Grip	Blue diamond stitching for a stylish clean look
22-1-97656-9	 Truck Tri Grip Tan 	Work wear styling with heavy-duty grip for trucks
22-1-97032-9	Fastline Black	Classic look and design with chrome piping
22-1-97029-9	Fine Stitch Black	Accent stitching for a stylish, clean look



# LICENSE PLATE FRAMES

Protection, fun or fashion. Regardless of what drives your shopper, we have the solution for you. From simple to sassy, classic to creative, or fun to far out—Bell® has a wide assortment of license plate frames and fasteners to meet every need



## Barbed Wire Black License Plate Frame

- The classic just got cooler... matte black

22-1-46565-8 - 2 pcs. Open Stock

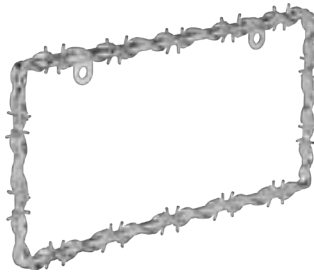

## Barbed Wire License Plate Frame

- Classic tough barbed wire design

22-1-46144-8 - 4 pcs. Open Stock

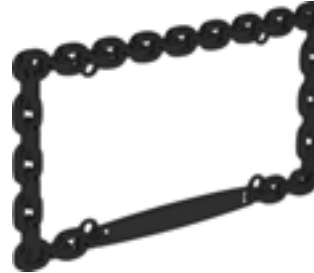

## Mega Metal Chain Black License Plate Frame

- Classic metal chain to add style to any ride

22-1-46573-8 - 2 pcs. Open Stock

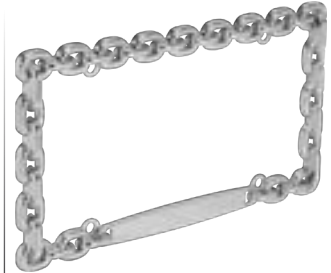

## Mega Metal Chain Chrome License Plate Frame

- Classic metal chain to add style to any ride

22-1-46009-8 - 2 pcs. Open Stock

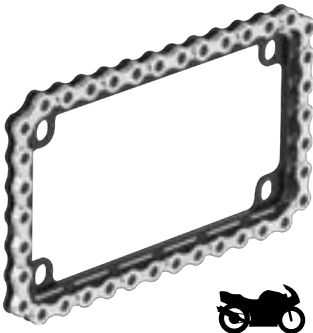

## Chain Motorcycle License Plate Frame

- Molded plastic frame sized to fit motorcycles

22-1-46497-8 - 3 pcs. Open Stock



## High Heels Hot Pink License Plate Frame

- High heel design with faux diamond accents

22-1-46511-8 - 2 pcs. Open Stock

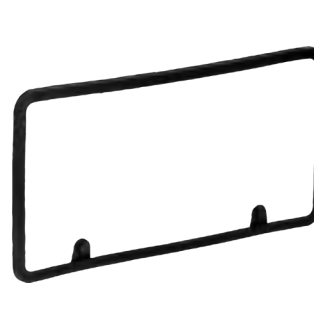

## Silicone Bumper Black License Plate Frame

- Silicone frame for style and function
- Prevents license plate rattle

22-1-46714-8 - 4 pcs. Open Stock



## Spike License Plate Frame

- Cool and tough 3D spike design

22-1-46117-8 - 2 pcs. Open Stock





### Bonitas License Plate Frame

- Amazing printed graphics
- Includes many of the great DGA™ art pieces

22-1-46725-8 - 4 pcs. Open Stock



### Leopard Print License Plate Frame

- Fashion forward, all-over leopard print design

22-1-46727-8 - 2 pcs. Open Stock



### Body Glove® BG Original License Plate Frame

- Retro-inspired, Body Glove® design

22-1-46728-8 - 2 pcs. Open Stock

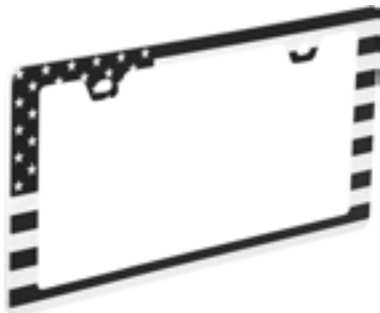

### Black and White Flag License Plate Frame

- Bold, patriotic design

22-1-46724-8 - 4 pcs. Open Stock

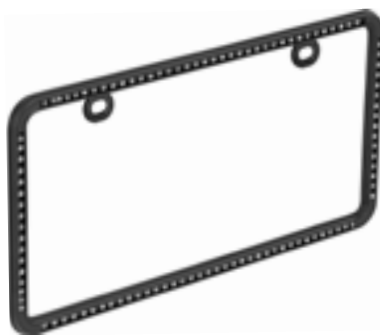

### Diamonds Black License Plate Frame

- Diamonds are a girl's best friend

22-1-46501-8 - 2 pcs. Open Stock

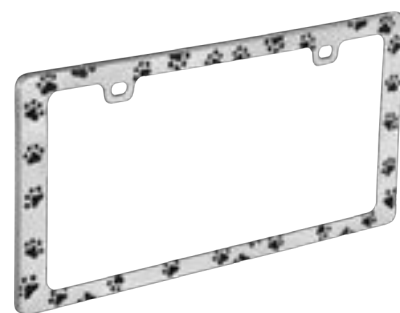

### Paw Prints License Plate Frame

- All over pattern because everyone loves their pets

22-1-46104-8 - 4 pcs. Open Stock



### Dealer Slim Blue License Plate Frame

- Anodized blue aluminum frame

22-1-46601-8 - 12 pcs. Open Stock



### Dealer Classic Chrome License Plate Frame

- Dealer classic for that clean look

22-1-46215-8 - 3 pcs. Open Stock



### Tribal License Plate Frame

- Tribal print with black inlay for style

22-1-46163-8 - 3 pcs. Open Stock





# INTERIOR ORGANIZATION & ACCESSORIES



22-1-33653-8

## *Enjoy Your Ride*

Shoppers are spending more time in their vehicles—and driving more miles. Now, more than ever, they are looking for ways to organize their vehicle and make each ride more enjoyable. Provide your shoppers the latest solutions from our full line of organization and accessory products. From powering up mobile devices to storing different types of cargo, we have the right product for you.





### Cargo Net

- Ideal for the rear cargo areas of cars, vans, trucks & SUVs
  - 45" x 24" size
  - Cargo net stretches to 60"
- 22-1-33653-8** - 2 pcs. Open Stock



### Console Plus Organizer™

- Unique mobile phone landing pad
  - Multiple pockets and divided storage
  - Magnetic lid keeps items out of view
- CNSLPLUS-BLA** - 3 pcs. Open Stock



### Mini Organizer™

- Adaptable: slides into or between seats
  - Removable divider to customize your storage areas
  - Stores easily under your seat when not in use
- MINIORG** - 3 pcs. Open Stock



### Vent Pack Organizer™

- Durable netting allows you to see inside the organizer
  - Adjustable clip fits almost any air vent
  - Easy to move, simple to use
- VENT-05** - 6 pcs. Open Stock, Clip Strip



### Vent Pack XL Organizer™

- Large enough for a smartphone
  - Bonus front pocket sized to fit slim cell phones
  - Adjustable clip fits most air vents
- VENT-10** - 6 pcs. Open Stock, Clip Strip



### Seat Console

- Designed to mount to floors, humps or seats
  - Includes storage for CDs, pens and coins
  - Two adjustable locking drink holders accommodate most size drinks
- SC-BLA, SC-CHA** - 2 pcs. Open Stock



### Mini Console

- Designed for efficient storage and organization
  - Storage for coins and CDs
  - Two adjustable locking drink holders accommodate most size drinks
- EMIG-BLA, EMIG-CHA** - 3 pcs. Open Stock



### Efficiency Console

- Economy console stores common travel items
  - Storage for coins and CDs
  - Two drink holders hold small to medium sized drinks
- EFF-BLA, EFF-CHA** - 5 pcs. Open Stock

GO GEAR



### Visor Organizer™

- Storage space for smartphone
- All-purpose pocket and pen holder
- Durable Ny-Max™ material stands up to the toughest use and demands

VSR - 6 pcs. Open Stock

BELL



### Visor Organizer™ Ostrich Black

- Classic design with faux ostrich material
- Fits most visors

22-1-33225-8 - 4 pcs. Open Stock

BELL



### Seat Belt Shoulder Pad with Phone Holder

- Phone/garage door opener holder
- Perfect for seat belts, backpacks and pretty much any strap

22-1-33943-8 - 4 pcs. Open Stock

BELL



### Seat Belt Clips

- Helps keep strap comfortably positioned
- Sold as a pair

22-1-33671-8 - 6 pcs. Open Stock

BELL



### Deluxe Litter Bag

- Perfect for those little messes
- Includes 6 disposable liners
- Zippered bottom for easy access

22-1-00337-8A - 12 pcs. Open Stock

GO GEAR



### Pop-Up Trash Can™

- Pops up to use, collapses down to store
- Treated liner helps contain spills and cleans easily
- Special tab on bottom keeps can from tipping and rolling

TRASH-BLA - 6 pcs. Clip Strip

GO GEAR



### Space Saver Trash Can™

- Slim design utilizes vehicle space more efficiently
- Attaches to console, door, gear shift or seat pocket

TRASH10-BLA - 6 pcs. Open Stock

BELL



### Deer Warnings Black

- Air flow activation
- Produces two separate, unique frequencies to help reduce vehicle-animal collisions
- Adhesive mount included

22-1-01000-8 - 3 pcs. Open Stock

BELL



### Deer Warnings Chrome

- Air flow activation
- Produces two separate, unique frequencies to help reduce vehicle-animal collisions
- Adhesive mount included

22-1-01001-8 - 3 pcs. Open Stock

**BELL**



### Clothes Bar Ultra

- Adjustable to fit most vehicles
- Extendable from 35" to 56"
- Cushioned no-slide bar

22-1-00073-8 - 2 pcs. Open Stock

**BELL**



### Wedge Cup Holder

- Secure cup holders with small middle storage
- Equipped to hold pens/pencils

22-1-05591-8 - 6 pcs. Open Stock

**BELL**



### Octopus Drink Holder

- Self adjusting to fit many size drinks
- Non-slip base convenient for many different areas

22-1-00051-8 - 6 pcs. Open Stock

**BELL**



### Enduro Drink Holder 4 Pack

- Installs easily into top of door/window area

22-1-05560-8 - 48 pcs. Open Stock  
22-1-05560-8P6 - 6 pcs. Tray Pack of 6

**BELL**



### Door Mount Drink Holder

- Holds small to medium cups, cans and bottles

22-1-05585-8 - 12 pcs. Open Stock

**GO GEAR**



### Twin Cup Holder

- Includes two adjustable drink holders and a convenient personal organizer
- Unit mounts easily and securely to console, armrest or floor
- Console strap included

SMT - 6 pcs. Open Stock

**GO GEAR**



### Compact Cup Holder

- Ideal for compact spaces
- Single drink holder adjusts to fit drinks from 6 to 32 oz.
- Mounts easily to armrest, console or floor

SEJ - 6 pcs. Open Stock

**BELL**



### Hula Doll

- Classic ornament for any ride
- Spring action hips
- Adhesive mount

22-1-36707-8 - 2 pcs. Open Stock

**GO GEAR**



### Grab and Go Lighter

- Push to light
- Simple, safe and completely portable
- Works with any 12V outlet
- 100 lights per charge

AUTOLIGHTER - 6 pcs. Open Stock

GENUINE  
**VICTOR™**



**Butt Bucket Counter  
6 Piece PDQ**

- Glow in the dark lid
  - Helps remove odor
  - Extinguish and store cigarette butts
- 22-5-00370-VP6** - 6 pcs. PDQ Tray

GENUINE  
**VICTOR™**



**Butt Bucket  
Counter 12 Piece PDQ**

- Helps remove odor
  - Extinguish and store cigarette butts
- 22-5-00370-VCT12** - 12 pcs. PDQ Tray

**BELL**



**Ash Tray Aluminum Blue**

- Converts extra cup holder into functional ashtray
  - Blue aluminum canister with chrome accent
  - Easy to remove and clean
- 22-1-39264-8** - 2 pcs. Open Stock

**BELL**



**Ash Tray Aluminum Black**

- Converts extra cup holder into functional ashtray
  - Black aluminum canister with chrome accent
  - Easy to remove and clean
- 22-1-30230-8** - 2 pcs. Open Stock

**BELL**



**Ash Tray Diamonds Pink**

- Converts extra cup holder into functional ashtray
  - Pink aluminum canister with white rhinestone detail
  - Easy to remove and clean
- 22-1-39268-8** - 2 pcs. Open Stock

**BELL**



**Digital Clock**

- Lighted, dash mount or stands upright
  - Displays hours, minutes, month and date
  - Battery included
- 22-1-37015-8** - 2 pcs. Open Stock

**BELL**



**Jumbo Clock**

- Lighted, dash mount or stands upright
  - Hook & loop tape and battery included
- 22-1-37014-8** - 2 pcs. Open Stock

**BELL**



**Compass Lighted**

- Floating dial, suction cup/hook & loop mounts
  - Lighted for improved visibility
  - Battery included
- 22-1-24006-8** - 2 pcs. Open Stock

**BELL**



**Mini Compass Suction Cup**

- Liquid float, ball style compass
  - Suction cup attaches easily to any clean glossy surface
- 22-1-00371-8** - 2 pcs. Open Stock





**BELL**



**Combo Clock/Compass/  
Thermometer**

- Lighted and mounts with hook & loop tape
  - Battery included
- 22-1-29015-8** - 2 pcs. Open Stock

**BELL**



**Universal Mobile Device Holder**

- Suction cup and air vent mounting
- 22-1-22235-8** - 2 pcs. Open Stock

**BELL**



**Universal Mobile Device Holder**

- Soft protective holder with air vent mount
- 22-1-22246-8** - 2 pcs. Open Stock



**BELL**

**BELL**



**Triple Socket Power Outlet**

- Converts 12V cigarette lighter/power socket into a three outlet power source

22-1-39023-8 - 2 pcs. Open Stock

**BELL**



**USB Power Plug**

- Provides (1) 1.0 amp USB power port

22-1-39287-8 - 2 pcs. Open Stock

**BELL**



**Dual Socket Power Outlet**

- Converts 12V cigarette lighter/power socket into a dual outlet power source

22-1-39010-8 - 2 pcs. Open Stock

**BELL**



**Dual Socket Power Outlet**

- Converts 12V cigarette lighter/power socket into a dual outlet power source

22-1-39046-8 - 2 pcs. Open Stock

**BELL**



**Auxiliary Power Socket**

- Adds an extra power source to your vehicle

22-1-39048-8 - 2 pcs. Open Stock

**BELL**



**All Weather 12 Volt Power Socket**

- Adds an extra power source to your vehicle

22-1-39052-8 - 2 pcs. Open Stock

**BELL**



**Single Socket Battery Clip Power Adapter**

- Power 12V devices directly from 12V battery

22-1-39011-8 - 2 pcs. Open Stock

**BELL**



**Replacement 12 Volt Power Cord**

- 8 Foot cord with fused 12V plug

22-1-39047-8 - 2 pcs. Open Stock

**BELL**



**Replacement 12 Volt Power Plug**

- Replaceable fuse lighter plug

22-1-39002-8 - 2 pcs. Open Stock

**BELL**



# KEEP YOUR COOL WITH PREMIUM SUNSHADES



UNIVERSAL SIZE

## Pride Never Fades Accordion Shade

- Patriotic design

SP120621U - 6 pcs. Tray Pack

SP120621UFD - 36 pcs. Floor Display

When the weather heats up, you can still be cool... with popular sunshades by GoGear® and more





UNIVERSAL SIZE

### Sunset Beach Accordion Shade

- Beach horizon
- 60"W x 30"H

**SP120623U** - 6 pcs. Tray Pack  
**SP120623UFD** - 36 pcs. Floor Display



UNIVERSAL SIZE

### California Nights Accordion Shade

- Beach summer night design
- 60"W x 30"H

**SP120624U** - 6 pcs. Tray Pack  
**SP120624UFD** - 36 pcs. Floor Display



UNIVERSAL SIZE

### American Flag Accordion Shade

- Classic American flag
- 60"W x 30"H

**SP120610U** - 6 pcs. Tray Pack  
**SP120610UFD** - 24 pcs. Floor Display



UNIVERSAL SIZE

### Palm Trees Accordion Shade

- Relaxing beach design
- 60"W x 30"H

**SP120608U** - 6 pcs. Tray Pack



UNIVERSAL SIZE

### Silver

- Simple neutral style
- 60"W x 30"H

**SP130801U** - 6 pcs. Tray Pack



UNIVERSAL SIZE

### Carbon Fiber

- Contemporary pattern
- 60"W x 30"H

**SP120605U** - 6 pcs. Tray Pack



UNIVERSAL SIZE

### Palm Trees Pop-Up Shades

- Relaxing beach design
- 30"W x 30"H

**SP240618U** - 6 pcs. Open Stock



### QuickCling™ Pop-Up Side Shade

- Press and stick innovation - no suction cups
- Remove and replace easily - no marks or residue
- Filters heat and sun for backseat passengers

**SP2605042** - 6 pcs. Open Stock  
**SP2605042CS** - 6 pcs. Clip Strip  
**SP2605042SK** - 18 pcs. Sidekick



UNIVERSAL SIZE

### Silver Pop-Up Shade

- Simple neutral style
- 30"W x 30"H

**SP240401U** - 6 pcs. Open Stock

# TRAY PACKS

Organize your planogram and boost holding power

Part #	Description	# Pcs.
EFF-CHA-PDQ	Efficiency Console (Charcoal)	5 pcs.
TRASH-BLA-PDQ	Pop-Up Trash Can™	6 pcs.
TRASH13-BLA-PDQ	Tall Pop-Up Trash Can	6 pcs.



# CLIP STRIPS

Add a clip strip for increased off-shelf sales

Part #	Description	# Pcs.
TRASH-BLA	Pop-Up Trash Can™	6 pcs.
TRASH13-BLA-CS	Tall Pop-Up Trash Can	6 pcs.
VENT-05	Vent Pack Organizer™	6 pcs.
VENT-10	Vent Pack XL Organizer™	6 pcs.
SP2605042CS	QuickCling™ Side Shade	6 pcs.
AUTOLIGHTER	12V Cigarette Lighter	6 pcs.



# FLOOR DISPLAYS

GoGear® floor displays increase seasonal sale opportunities

Part #	Description	# Pcs.
SP240612UFD	Pop Up - Pacific Vibe Print - Universal	36 pcs.
SP240401JFD	Pop Up - Silver - Jumbo	36 pcs.
SP240401SFD	Pop Up - Silver - Standard	36 pcs.
SP240603JFD	Pop Up - Sail Away Edging - Jumbo	36 pcs.
SP240603SFD	Pop Up - Sail Away Edging - Standard	36 pcs.
SP120616UFD	Folding - Premium - Tiger Eye Print - Universal	24 pcs.
SP120612UFD	Folding - Premium - Pacific Vibe - Universal	24 pcs.
SP130901JFD	Folding - Advanced - Silver - Jumbo	12 pcs.
SP130901SJD	Folding - Advanced - Silver - Jumbo	12 pcs.



FULL-SIZE & MID-SIZE  
HEAVY-DUTY

# FLOOR MATS

GoGear® Heavy-Duty Floor Mats are designed for Truck, SUV and Crossover interiors, meeting tougher demands for interior protection

Refined engineering and quality construction provides the durability and comfort that shoppers want



**For Ultimate Interior Protection, You Won't Find A Better Value**



## 1 FIT

### Easy-Trim Guides

Provides a superior fit when compared to other retail products on the market



## 2 PROTECTION

### Raised Border

To protect the interior floor



## 3 SECURE

### Premium Lockdown

Up to 3X the holding power of the competition, for a safer mat



### Spike-Style Anchors

at the top keep your mat from rolling back onto pedals



### Cleat-Style Anchors

filling out the rest of the mat prevent forward sliding



### Hook & Loop

A premium feature built into every GoGear® driver side mat for added safety

### Rear Flex Mat™

Lets consumers choose the option that provides the best interior protection for their vehicle



### Separate rear twin mats or full-across runner



GOGEAR® PROTECTION & CONVENIENCE



**Black Full-Size Rubber Mats,  
4 Piece Set**

79000 - 4 Sets Open Stock



**Gray Full-Size Rubber Mats,  
4 Piece Set**

79001 - 4 Sets Open Stock



**Beige Full-Size Rubber Mats,  
4 Piece Set**

79002 - 4 Sets Open Stock



**Black Mid-Size Rubber Mats,  
4 Piece Set**

79100 - 4 Sets Open Stock



**Gray Mid-Size Rubber Mats,  
4 Piece Set**

79101 - 4 Sets Open Stock



**Black Full-Size Front Mats,  
2 Piece Set**

79040 - 4 Sets Open Stock



**Gray Full-Size Front Mats,  
2 Piece Set**

79041 - 4 Sets Open Stock



**Beige Full-Size Front Mats,  
2 Piece Set**

79042 - 4 Sets Open Stock



**Black Mid-Size Front Mats,  
2 Piece Set**

79140 - 4 Sets Open Stock



**KEEPING ROAD DEBRIS  
WHERE IT BELONGS**





# MUD AND SPLASH GUARDS

## PROTECT YOUR RIDE

For DIY vehicle owners who enjoy the pride and confidence they feel from driving a vehicle that looks brand new, RoadSport™ Splash Guards provide high-quality, durable solutions to meet every need.

## FULL COVERAGE

No matter the vehicle or budget, RoadSport™ has a product to fit your shoppers' needs. Protect your ride or whatever you tow with peace of mind.

## THE BRAND SHOPPERS TRUST

The only brand of universal splash guards that provide an OEM look and fit. Made from unbreakable materials, RoadSport™ brand Splash Guards are built for the long haul.





# PROTECT YOUR RIDE

For DIY vehicle owners who enjoy the pride and confidence they feel from driving a vehicle that looks brand new. RoadSport™ Splash Guards provide high-quality, durable solutions to meet every need. Designed with unbreakable materials with a broad assortment of sizes for cars, trucks, SUVs, trailers and RVs so drivers can keep their vehicle protected. The industry's largest assortments of universal fit splash guards.

# Big Mudder™

Splash Guards can handle the toughest street or off-road duty. Molded with a diamond-plate pattern, Big Mudder™ Splash Guards provide protection and coverage for oversized wheels and tires. If you are fitting a fleet, work, off-road, farm or raised truck and need a mud guard that will protect and last, you need Big Mudder™ Splash Guards



## Large Big Mudder Splash Guard

- Molded from a heavy-duty, unbreakable, flexible material
- Pre-marked mounting locations can be found on the rear of the splash guard
- Mounting hardware included

3102 - 4 pcs. Open Stock



## X-Large Big Mudder Splash Guard

- Molded from a heavy-duty, unbreakable, flexible material
- Pre-marked mounting locations can be found on the rear of the splash guard
- Mounting hardware included

3103 - 4 pcs. Open Stock



## Extreme Big Mudder Splash Guard

- Molded from a heavy-duty, unbreakable, flexible material
- Pre-marked mounting locations can be found on the rear of the splash guard
- Mounting hardware and stainless steel accents included

3105 - 4 pcs. Open Stock



## Dually Big Mudder Splash Guard

- Molded from a heavy-duty, unbreakable, flexible material
- Shaped for dual wheels
- Mounting hardware included

3104 - 4 pcs. Open Stock



## Big Mudder Stainless Steel Accent

- Rolled outer edges for safety and strength
- Works with model #3102, 3103, and 3104
- Easy way to accent and add extra flair to your splash guards
- Mounting hardware included

3101 - 6 pcs. Open Stock

# Pro-Fit™

Provides full protection and enhanced styling to match the body lines of your vehicle for an OEM style with a universal fit. Seven profiles work with virtually all makes and models Trucks, SUVs and cars



## Pro-Fit Splash Guard Car 1

- Fits most compact passenger cars
- Custom look universal fit
- Large lip area conforms to fender flares and body panels
- Soft radii to follow body curves

6401 - 4 pcs. Open Stock



## Pro-Fit Splash Guard Car 2

- Fits most mid-size passenger cars
- Custom look universal fit
- Large lip area conforms to fender flares and body panels
- Soft radii to follow body curves

6402 - 4 pcs. Open Stock



### Pro-Fit Splash Guard Car 3

- Fits most intermediate size passenger cars
- Custom look universal fit
- Large lip area conforms to fender flares and body panels
- Soft radii to follow body curves

6403 - 4 pcs. Open Stock



### Pro-Fit Splash Guard Car 4

- Fits most full-size passenger cars and small SUVs/CUVs
- Custom look universal fit
- Large lip area conforms to fender flares and body panels
- Soft radii to follow body curves

6404 - 4 pcs. Open Stock



### Pro-Fit Splash Guard Truck 6

- Fits most light-duty trucks
- Custom look universal fit
- Large lip area conforms to fender flares and body panels
- Soft radii to follow body curves

6416 - 2 pcs. Open Stock



### Pro-Fit Splash Guard Truck 7

- Fits most medium-duty trucks
- Custom look universal fit
- Large lip area conforms to fender flares and body panels
- Soft radii to follow body curves

6417 - 2 pcs. Open Stock



### Pro-Fit Splash Guard Truck 8

- Fits most heavy-duty trucks
- Custom look universal fit
- Large lip area conforms to fender flares and body panels
- Soft radii to follow body curves

6418 - 2 pcs. Open Stock



### Pro-Fit Splash Guard Hardware Kit

- Patented clips create mounting points for splash guards
- Package contains hardware to mount front or rear pair of splash guards
- Corrosion-resistant mounting hardware

6400KT - 6 pcs. Open Stock

# Premier-Fit™

Splash Guards are the economical way to add style and protection to your vehicle. Available in a variety of sizes and designs to fit the needs of your car, truck, SUV, RV and trailer



## Premier Fit Splash Guard A - Red Accent

- Universal fit to protect most small applications
- Molded from heavy-duty material with red reflector
- Mounting hardware included

4649 - 6 pcs. Open Stock



## Premier Fit Splash Guard B - Red Accent

- Universal fit to protect most medium applications
- Molded from heavy-duty material with red reflector
- Mounting hardware included

4766 - 6 pcs. Open Stock



## Premier Fit Splash Guard C - Red Accent

- Universal fit to protect most large applications
- Molded from heavy-duty material with red reflector
- Mounting hardware included

4326 - 6 pcs. Open Stock



## Premier Fit Splash Guard A

- Universal fit to protect most small applications
- Molded from heavy-duty material
- Mounting hardware included

4406 - 4 pcs. Open Stock



## Premier Fit Splash Guard B

- Universal fit to protect most medium applications
- Molded from heavy-duty material
- Mounting hardware included

4754 - 6 pcs. Open Stock



## Premier Fit Splash Guard C

- Universal fit to protect most large applications
- Molded from heavy-duty material
- Mounting hardware included

• 4322 - 6 pcs. Open Stock



### Premier Fit Splash Guard C - 4X4

- Universal fit to protect most large applications
- Molded from heavy-duty material with silver 4X4 insignia
- Mounting hardware included

4320 - 6 pcs. Open Stock



### Premier Fit Splash Guard

- Universal fit for pick-up trucks, vans and RVs
- Textured black rubber for a long lasting fit
- Easy installation with pre-marked mounting location

5526 - 4 pcs. Open Stock

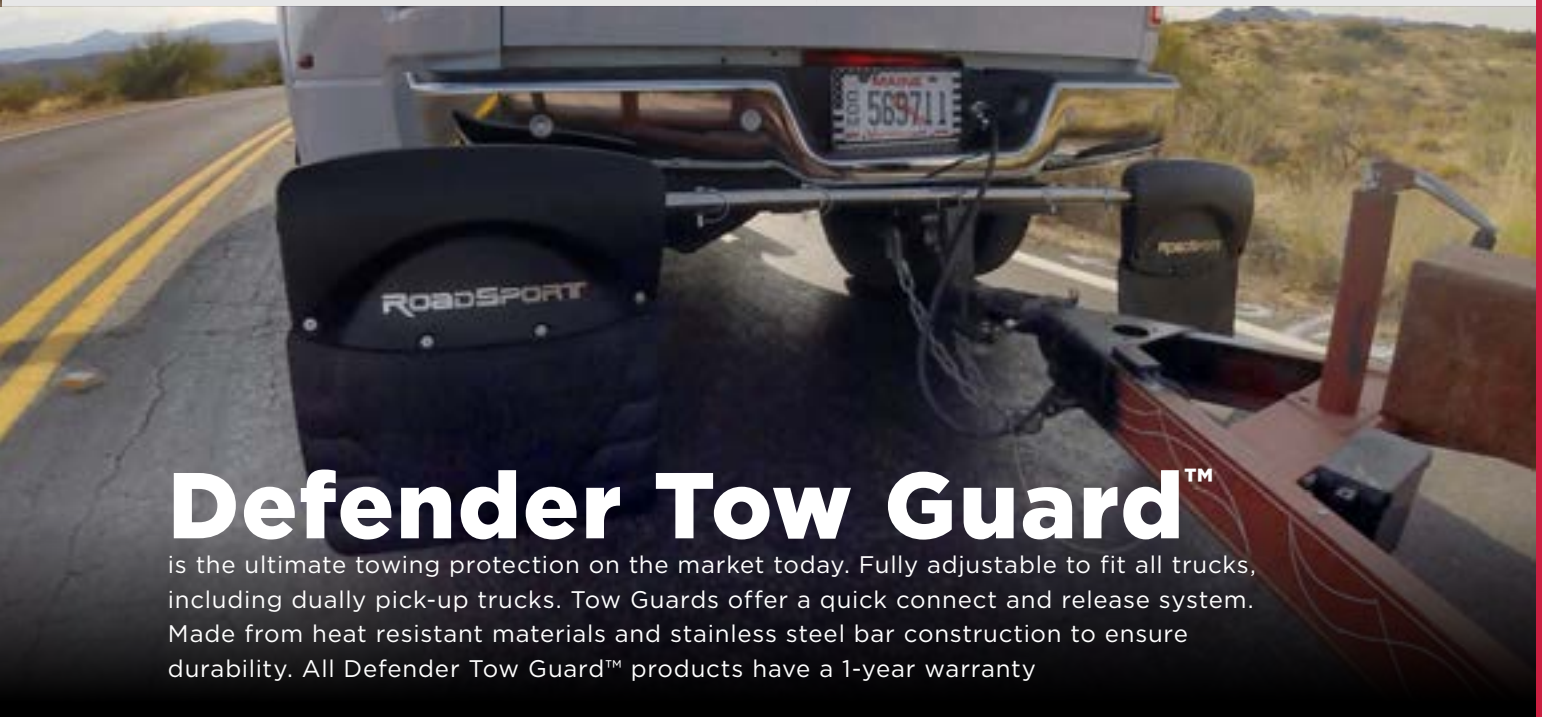

# Defender Tow Guard™

is the ultimate towing protection on the market today. Fully adjustable to fit all trucks, including dually pick-up trucks. Tow Guards offer a quick connect and release system. Made from heat resistant materials and stainless steel bar construction to ensure durability. All Defender Tow Guard™ products have a 1-year warranty



### Defender Tow Guard™

- Fits all pick-up trucks, duallys and RVs
- Easily installed and removed when not towing
- Quick release pins for easy on & off
- Fits most 2" draw bars

3304 - 1 pc. Open Stock



### Roadguard Tow Guard™

- Fits all light-duty pick-up trucks and SUVs
- Easily installed and removed when not towing
- Fully adjustable from RV to SUV
- Fits most 1-1/4" or 2" draw bars

3305 - 2 pcs. Open Stock

# LIGHTING THE WAY FOR A BRIGHTER PERFORMANCE





**50+**  
**YEARS**

**RECOGNIZED  
AND TRUSTED  
BRAND FOR  
OVER 50 YEARS**

For five decades, Blazer® has delivered vehicle lighting solutions to heavy-duty trucks, farm/ag, performance, commercial and off-road enthusiasts. Focused on high performance and overall visibility, Blazer® lights the way!

### **INSIGHTFUL INNOVATION**

We follow a consistent philosophy, leveraging consumer insights to drive product innovation

### **EXCEPTIONAL VALUE**

By delivering patented products at competitive prices, we provide the right balance between quality, cost and performance

**BLAZER**  
**INTERNATIONAL 1970**

**AUXILIARY & OFF-ROAD LIGHTING**



# OFF-ROAD LIGHTING

## Quality, Performance, and Durability

We are obsessed with every little detail to make sure that our customers have a 5 star experience



Radio Frequency Interference Shielding



IP67 Dust and Water Protection



Compact Housing Design Reduces Wind Noise at All Speeds



Fast and Easy Installation



Adjustable Mounting Brackets and Hardware Included



Off-Road Tough With High Output LEDs, Aluminum Housings, and High Impact Lenses



Award-Winning Innovation

### LED Technology

- ABLE TO WITHSTAND SHOCK, VIBRATION, AND EXTREME TEMPERATURES •
- SUPERIOR OPERATIONAL LIFESPAN... UP TO 30,000 HOURS •
- NO WARM UP PERIOD - LIGHTS UP INSTANTLY •



# OPTIMIZING CONSUMER SHOPABILITY AND USER SATISFACTION

Blazer® makes it easier for you and your customer with a simplified retail communication strategy. The introduction of color-coded category segmentation quickly orients your shopper to the proper type of product, and a clear communication system helps drive step-up sales for a more rewarding shopping and user experience



**OFF-ROAD**



**ACCESSORY**



**WORK**



**WARNING**



**DRIVING/AXXENT®**



## INTRODUCING THE HI-DEF SERIES™ Engineered To Deliver Better Visibility



True  
“Ditch-to-Ditch”  
Visibility



More Visibility  
Directly Ahead  
on the Trail



**HiDEF SERIES™**

**WIDE VIEW™  
ADVANTAGE**

Enhanced light reflecting technology provides 170 degree visibility from ditch-to-ditch and delivers a 44% wider field of view compared to our standard beam patterns



**CWL52210 - 11.5"** Class 1

Amber + White, 2 Flash Patterns



**CWL521 - 11.5"**



**CWL526 - 7.5"**



**CWL528 - 6.5"**

**LUMENS**

Part Number	Beam Pattern	Length (IN)	Amp Draw	Raw	Effective
CWL52210	SPOT/FLOOD/WARNING	11.5"	2.8	4,000	2,780
CWL521	SPOT/FLOOD	11.5"	1.6	2,600	1,600
CWL526	FLOOD	7.5"	0.9	1,800	1,200
CWL528	SPOT/FLOOD	6.5"	1.43	2,900	1,700



**CWL522 - 22"** Class 1

Amber + White, 2 Flash Patterns



**CWL527 - 20"**



**CWL525 - 17.5"**



**CWL523 - 11.5"**



**CWL529 - 3.5"**

## LUMENS

Part Number	Beam Pattern	Length (IN)	Amp Draw	Raw	Effective
CWL522	SPOT/FLOOD/WARNING	22"	6.0	7,920	6,011
CWL527	FLOOD	20"	4.0	6,000	4,800
CWL525	FLOOD	17.5"	2.8	4,800	3,600
CWL523	FLOOD	11.5"	1.9	3,000	2,400
CWL529	SPOT/FLOOD	3.5"	1.0	2,500	1,500

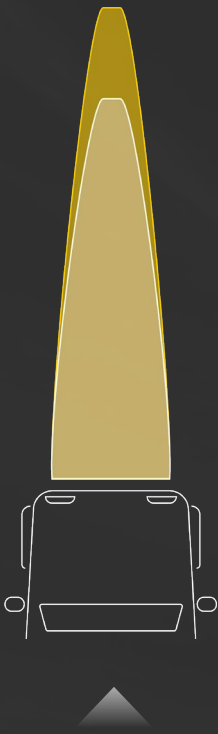

## HIDEF SERIES™

# CLEAR VIEW™ ADVANTAGE

Exclusive light reflecting technology engineered with a unique combination of optimized reflector cups and lenses to provide 25% more focused light straight ahead



C3022K - 22"



CWL520 - 22"

Fog Only / Spot Only / Fog and Spot Combination



CWL113 - 14"



CWL118 - 8"



CWL514 - 4"

### LUMENS

Part Number	Beam Pattern	Length (IN)	Amp Draw	Raw	Effective
C3022K	SPOT/FOG	22"	8.4	9,200	5,700
CWL520	COMBO/SPOT/FOG	22"	6.0	7,920	4,190
CWL113	SPOT/FOG	14"	1.8	2,400	1,500
CWL118	SPOT/FOG	8"	0.9	1,500	830
CWL514	FLOOD	4"	1.2	1,600	850



CWL552D - 52"



CWL552S - 52"



CWL536D - 38"



CWL536S - 38"



CWL524D - 24"



CWL524S - 24"

## LUMENS

Part Number	Beam Pattern	Length (IN)	Amp Draw	Raw	Effective
CWL552D	SPOT/FOG	52"	17.6	20,000	13,500
CWL552S	SPOT/FOG	52"	8.4	10,000	6,800
CWL536D	SPOT/FOG	38"	12.7	14,400	11,100
CWL536S	SPOT/FOG	38"	6.0	7,200	6,000
CWL524D	SPOT/FOG	24"	7.5	9,600	5,800
CWL524S	SPOT/FOG	24"	3.8	4,800	3,800

# AUXILIARY LIGHTING

Blaze your own trail with Blazer® lighting solutions. Blazer® lighting products are engineered with high performance components that maximize durability, provide for ease of installation and optimize light visibility where and when you need it most. **BLAZER® LIGHTS THE WAY™**







### Halogen 6.5" Spot Light

**C52CW**

- Heavy-duty steel housing with stainless steel rims and double insulated glass lens
- Lumens: 1,400 Raw, 1,000 Effective - Replaceable 100 Watt quartz halogen bulb
- Current Draw: 6.0 Amps
- Includes light with lead wire, bracket and hardware



### 4 Pk LED White Rock Light Kit

**CWL515**

- Compact design - can be mounted anywhere with the included flat or curved mounting grommets
- High-impact polycarbonate lens and reinforced resin housing
- Current draw: 0.14 Amps per light
- Includes 4 lights, quick-connecting wiring harness, 4x flat mounting grommets, 4x curved mounting grommets and mounting hardware



### LED 6" Spot Light Bar

**CWL1116**

- Compact size and shape
- Single stud mount
- Lumens: 900 Raw, 630 Effective
- Current draw: 0.5 Amps
- Includes light with lead wire, mounting bracket and hardware



### LED 7.5" Spot/Flood Light Bar

**CWL518**

- Dual-chip design produces more lumens due to improved technology and a larger surface area
- Lumens: 3,200 Raw, 1,600 Effective
- Current draw: 2.0 Amps
- Includes light with lead wire, mounting brackets and hardware



### LED 7.5" Spot Light Bar

**CWL0006**

- Compact, slim line design
- Lumens: 1,260 Raw, 850 Effective
- Current draw: 0.9 Amps
- Includes light with lead wire, mounting brackets and hardware



### LED 14" Spot/Flood Light Bar

**CWL513**

- Dual-chip design produces more lumens due to improved technology and a larger surface area
- Lumens: 6,700 Raw, 3,000 Effective
- Current draw: 4.0 Amps
- Includes light with lead wire, mounting brackets and hardware



### LED 20" Spot/Flood Light Bar

**CWL0020**

- Compact, slim line design
- Lumens: 3,780 Raw, 2,300 Effective
- Current draw: 2.7 Amps
- Includes light with lead wire, mounting brackets and hardware

# LED CUBES

COMPACT AND VERSATILE... MOUNT ANYWHERE ADDITIONAL LIGHT IS NEEDED

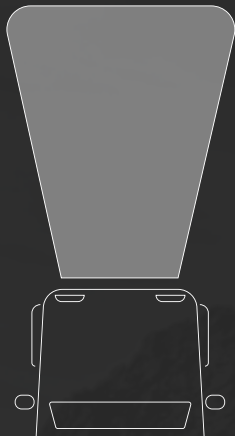

## FLOOD LIGHT

Defuses light into different directions, illuminating a larger area



C3073K - 3"



C3072K - 3"



C3073KFM - 3"  
Flush Mount

### LUMENS

Part Number	Beam Pattern	Length (IN)	Amp Draw	Raw	Effective
C3073K	SPOT	3"	1.2	1,320	1,100
C3072K	FLOOD	3"	1.2	1,720	1,200
C3073KFM	FLOOD	3"	0.75	1,720	1,200



**CWL0022 - 2 PACK - 2"**



**C3071K - 3"**  
With Daytime  
Running Light



**C3075K - 4" x 3" - 2 Pk**

Amber Only Or  White Only



## SPOT LIGHT

Projects a narrow,  
intense beam of  
light to illuminate  
straight ahead

### LUMENS

Part Number	Beam Pattern	Length (IN)	Amp Draw	Raw	Effective
CWL0022	SPOT	2"	0.71	1,230	846
C3071K	SPOT	3"	1.50	2,000	1,530
C3075K	SPOT	4" x 3"	0.80	900	575

# WIRELESS MANAGEMENT SYSTEM

Reduces light system installation by hours. No need to drill through the firewall, install switches, relays or fuses

- ✓ CWL623 controls 5 channels, allowing operation of 4+ lights and accessories
- ✓ Energy Savings! Automatically turns off after 48 hours preventing damage to the lights and battery
- ✓ CWL622 has up to 100 feet of wireless range



Award-Winning Innovation



## Quick Install Light Kit With Phone App

### CWL623

- Includes module and app (phone not included)
- Phone app operates 4+ lights (2+ each at 18 and 5 amps)
- Extra terminal for warning/emergency light patterns
- Easy installation - no drilling through firewall or adding switches to dash
- Sleep mode automatically turns off after 48 hrs. preventing damage to the lights and battery

## Quick Install Light Kit With Remote

### CWL622

- Includes module and remote
- Remote control operates 4+ lights (2+ each at 18 and 5 amps)
- Easy installation - no drilling through firewall or adding switches to dash
- Sleep mode automatically turns off after 48 hrs. preventing damage to the lights and battery

# LED LIGHT KITS WITH REMOTES

Fast and easy installation - no drilling into dash, no wiring, switch, relay, or fuse needed. It's all included in the remote system

**Each Kit Includes:**

- 26" double-row light bar or 3" cube set
- 9' lead wires from the light(s)
- Mounting brackets and hardware
- Module & remote



**2 Pk LED 3" x 3" Cubes With Remote**

**CWL51222**

- Includes lights, mounting brackets, hardware, engine compartment module, remote
- Each light built with 9 ft lead wire
- Ability to run 4+ lights (2 each at 18 amps and 5 amps) with included remote control
- Fast & easy installation - no drilling into dash, no wiring, no switch, no relay, no fuse - it's all included in the remote system



**LED 26" Double Row Light Bar Kit With Remote**

**CWL52450**

- Includes light, mounting brackets, hardware, engine compartment module, remote
- Light bar built with 9 ft lead wire
- Ability to run 4+ lights (2 each at 18 amps and 5 amps) with included remote control
- Fast & easy installation - no drilling into dash, no wiring, no switch, no relay, no fuse - it's all included in the remote system

**LUMENS**

Part Number	Beam Pattern	Length (IN)	Amp Draw	Raw	Effective
CWL51222	FLOOD	3"	1.1	1,600	1,000
CWL52450	SPOT/FLOOD	26"	4.8	7,200	6,090

# AUXILIARY LIGHTING ACCESSORIES



## Quick-Connect Wiring Harness (Heavy-Duty)

### CWL620 - 1 Light

- Harness includes quick connecting plug, 40 amp relay, 30 amp fuse and round toggle switch
- Heavy-duty wiring harness is designed for systems 300 W and over (ie: CWL552D)
- 9', 16 gauge wire
- Quick-connecting plugs are water resistant and easy to install



CWL610

## Quick-Connect Wiring Harness

### CWL610 - 1 Light

### CWL615 - 2 Lights

- Harness includes quick connecting plug, 40 amp relay, 30 amp fuse and round toggle switch
- 1 and 2-light wiring harnesses are designed for lighting systems under 200 watts
- 9', 16 gauge wire
- Quick-connecting plugs are water resistant and easy to install



## Quick-Connect Plug Set

### CWL625

- Includes male and female plugs with 6" leads
- Water resistant and easy to install
- Connect to light, wiring and/or harness



## Round On-Off Switch

### CWL624

- Fits in 0.75" diameter hole
- Illuminated switch lights red when on

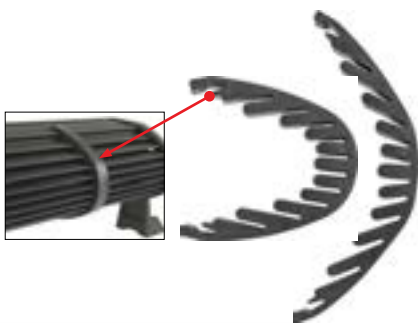

## 10 Pack Noise Reducing Inserts

### CWL627

- PVC inserts reduce vibration noise caused by wind, road and terrain
- For Blazer® double row LED light bars 22" and above



## 24 Piece Theft Prevention Hardware

### CWL626

- Includes 2 allen wrenches, 5 lock nuts and 17 screws
- Unique bolt head deters theft - standard wrenches or screwdrivers will not remove light



### Round Mounting Brackets

**CWL636 - 2" Diameter**

**CWL637 - 1.75" Diameter**

**CWL638 - 1.5" Diameter**

- Designed for mounting a single light or light bar on round or angled bars or frames
- Powder coated, durable steel frame for long lasting use
- Includes bracket, mounting hardware and padding to protect the mounting surface
- Mount can be adjusted and rotated 360° to fit height or width requirements



### Universal Mounting Bracket

**CWL639**

- Designed for mounting a single light or light bar on round or angled bars or frames
- Adjustable from 1.5" to 2.25"
- Adjustable 360° mounting
- Adhesive padding to protect painted surfaces



### Universal License Plate Bracket

**CWL692**

- Designed to use the holes that USA and Canadian license plates fit into (license plate will attach to the bracket, as well)
- Powder coated, durable steel frame for long lasting use
- Fits stud, post and side mounting brackets - fits all Blazer® lights 13" and under
- Bracket can be used on bumper, racks and other locations. Great for cameras, too
- No drilling required



6" CWL630 on 7" Double Row Light Bar



### 2 Pk Light Covers

**CWL630 - Amber**

**CWL631 - Black**

- Easy to snap on and off 6" and 8" segments
- Fits most double row light bars
- Polycarbonate lens - durable and shatter proof. Protects lens when not in use
- CWL630 amber lens improves visibility in fog or snow
- CWL631 black lens covers satisfy regulations in most states/provinces (check local laws)

# WARNING / EMERGENCY

## LED and Halogen

Convenient 12 V plug or battery powered options make installation easy with non-scratch heavy-duty magnetic base for secure mount. Most units come with a permanent mounting option

### The three SAE classifications for warning lights:

- Class 1: Emergency
- Class 2: On-road/Off-Road/Indoor
- Class 3: Off-Road/Indoor



Some units now come with a "HEATED LENS" option that is designed to automatically de-ice the surface of the lens. Look for the "HEATED LENS" icon to find this advanced feature



### LED 11.5" Spot/Flood/Warning Combination Light

CWL52210 **Class 1**

- Multicolor beam patterns - switch between white and amber constant on or flashing
- Ditch-to-ditch visibility - 170 degree light beam pattern perfect for illuminating uneven terrain, dark roads or low visibility conditions
- Lumens: 5,000 Raw, 3,500 Effective
- Current draw: 2.8 Amps
- Includes light with lead wire, mounting brackets and hardware



### LED 22" Spot/Flood/Warning Combination Light

CWL522 **Class 1**

- Multicolor beam patterns - switch between white and amber constant on or flashing
- Ditch-to-ditch visibility - 170 degree light beam pattern perfect for illuminating uneven terrain, dark roads or low visibility conditions
- Lumens: 7,920 Raw, 6,011 Effective
- Current draw: 6.0 Amps
- Includes light with lead wire, mounting brackets and hardware





**LED Magnetic Light Bar, Amber/White LEDs**

**C4850CAC** **Class 2**

- Low-profile, aerodynamic design stands 3.2" from the surface
- Flash pattern(s): 9 - 3 amber, 3 white, 3 combination
- 12 V power cord includes plug with on/off and pattern selection switch
- Optional permanent mount (hardware not included)



**LED Magnetic Light Bar, Amber/White LEDs**

**C4850CACH** **Class 2**

- Automatic heated lens melts away snow and ice for continued visibility in winter-like conditions
- Low-profile, aerodynamic design stands 3.2" from the surface
- Flash pattern(s): 9 - 3 amber, 3 white, 3 combination
- 12 V power cord includes plug with on/off and pattern selection switch
- Optional permanent mount (hardware not included)



**LED Micro Magnetic Light Bar, Amber/White LEDs**

**C4856CAC** **Class 2**

- Low-profile, aerodynamic design stands 2" from the surface
- Flash pattern(s): 9 - 3 amber, 3 white, 3 combination
- 12 V power cord includes plug with on/off and pattern selection switch
- Optional permanent mount (hardware not included)



**LED Stealth-Black Magnetic Light Bar, Amber LEDs**

**C4857CAC** **Class 1**

- Low-profile, aerodynamic design stands 3" from the surface
- Flash pattern(s): 11
- 12 V power cord includes plug with on/off and pattern selection switch
- Optional permanent mount (hardware not included)



**LED Mini Magnetic Light Bar**

**C4855AW** **Class 1**

- Low-profile, aerodynamic design stands 2.25" from the surface
- Flash pattern(s): 8
- 12 V power cord includes plug with on/off and pattern selection switch
- Optional permanent mount (hardware not included)



**LED Mini Magnetic Light Bar, Amber LEDs**

**C4855CAW** **Class 2**

- Low-profile, aerodynamic design stands 2.25" from the surface
- Flash pattern(s): 8 amber
- 12 V power cord includes plug with on/off and pattern selection switch
- Optional permanent mount (hardware not included)



### LED Mini Magnetic Light Bar, Amber/White LEDs

**C4855CAC** **Class 2**

- Low-profile, aerodynamic design stands 2.25" from the surface
- Flash pattern(s): 9 - 3 amber, 3 white, 3 combination
- 12 V power cord includes plug with on/off and pattern selection switch
- Optional permanent mount (hardware not included)



### Halogen Magnetic Revolving Light Bar

**C4500AW** **Class 1**

- Features 2 revolving chrome reflectors with 2 replaceable H1 55W bulbs
- Flash pattern(s): 1
- 12' power cord includes plug with on/off switch
- Optional permanent mounting (hardware not included)



### LED Magnetic Light Bar

**C4850AW** **Class 1**

- Low-profile, aerodynamic design stands 3.2" from the surface
- Flash pattern(s): 21
- 12 V power cord includes plug with on/off and pattern selection switch
- Optional permanent mount (hardware not included)



### LED Low-Profile Magnetic Strobe Beacon, Amber LEDs

**C38CAW** **Class 1**

- Low-profile aerodynamic design stands 3" from the surface
- Flash pattern(s): 8
- 12 V power cord includes plug with on/off and pattern selection switch
- Optional permanent mount (hardware not included)



### LED Short Profile Magnetic Alert Beacon, Amber/White LEDs

**C36CAC** **Class 2**

- Low-profile aerodynamic design stands 2" from the surface
- Flash pattern(s): 9 - 3 amber, 3 white, 3 combination
- 12 V power cord includes plug with on/off and pattern selection switch
- Optional permanent mount (hardware not included)



### LED Standard Profile Magnetic Alert Beacon, Amber/White LEDs

**C37CAC** **Class 2**

- Low-profile aerodynamic design stands 3.4" from the surface
- Flash pattern(s): 9 - 3 amber, 3 white, 3 combination
- 12 V power cord includes plug with on/off and pattern selection switch
- Optional permanent mount (hardware not included)



### LED Tall Profile Magnetic Alert Beacon, Amber/White LEDs

**C41CAC** Class 2

- Low-profile aerodynamic design stands 5" from the surface
- Flash pattern(s): 9 - 3 amber, 3 white, 3 combination
- 12 V power cord includes plug with on/off and pattern selection switch
- Optional permanent mount (hardware not included)



### LED Tall Profile Magnetic Alert Beacon, Amber/White LEDs

**C41CACH** Class 2

- Automatic heated lens melts away snow and ice for continued visibility in winter-like conditions
- Low-profile aerodynamic design stands 5" from the surface
- Flash pattern(s): 9 - 3 amber, 3 white, 3 combination
- 12 V power cord includes plug with on/off and pattern selection switch
- Optional permanent mount (hardware not included)



### LED Magnetic Strobe Beacon

**C48AW** Class 3

- Single flash feature - 100 flashes per minute
- 12 V power cord
- Optional permanent mount (hardware not included)



### LED Magnetic Strobe Beacon

**C48AWH** Class 3

- Automatic heated lens melts away snow and ice for continued visibility in winter-like conditions
- Single flash feature - 100 flashes per minute
- 12 V power cord
- Optional permanent mount (hardware not included)



### LED Magnetic Strobe Beacon

**C43A** Class 3

- Smart on/off sensor automatically turns the light on in darkness and off in daylight
- Flash pattern(s): 4
- No wiring necessary - operated on 2 x D batteries (not included)



### LED Round Strobes, Amber/White LEDs

**C4842** Class 3

- 1.5" diameter
- Low-profile design stands 0.7" from the surface
- Flash pattern(s): 9 - 3 amber, 3 white, 3 combination
- Each light includes a 3-wire pigtail and mounting hardware to mount to the grille of the vehicle



### LED Rectangular Strobes, Amber/White LEDs

C4843 **Class 2**

- Low-profile design stands 0.5" from the surface
- Flash pattern(s): 9 - 3 amber, 3 white, 3 combination
- Each light includes a 3-wire pigtail and mounting hardware to mount to the grille of the vehicle



### LED 4" Round Strobe Light

5441B - Light Only Wig Pattern

5442B - Light Only Wag Pattern

- Grommet mount installation
- Alternating (wig-wag) or synchronous strobe pattern
- Ideal for emergency vehicles, construction equipment, work trucks and any vehicle needing greater visibility
- Current draw: 0.45 Amps



### LED 6" Oval Strobe Light

5641B - Light Only Wig Pattern

5642B - Light Only Wag Pattern

- Grommet mount installation
- Alternating (wig-wag) or synchronous strobe pattern
- Ideal for emergency vehicles, construction equipment, work trucks and any vehicle needing greater visibility
- Current draw: 0.45 Amps



### LED Magnetic Hazard Light

C42A **Class 2**

- Ideal for use on barricades or traffic drums in work zones or parking lots, warehouses and stock rooms
- Flash pattern(s): 1
- No wiring needed - operates on 4 AA batteries (not included)
- Optional permanent mount (hardware not included)



C6350

**Class 2**



C6350A

**Class 3**



C6355

**Class 3**

### LED Magnetic Emergency Light

C6350 - Red

C6350A - Amber

C6355 - Red with White Work Light

- C6355 has an additional work light on the side of the unit
- Flash pattern(s): 2
- No wiring necessary - operated on 4 x AA batteries (not included)
- Optional freestanding setup

## VISIBILITY AND SAFETY...

Two benefits **BLAZER® WARNING LIGHTS** help to provide whether working during the day, or at night. 360 degrees of high-performance lighting will survive in the harshest of conditions



## Auxiliary Lighting For Enhanced Visibility

Blazer® auxiliary lighting will enhance any vehicle's factory head lamps while providing further visibility. Fog and driving lights feature corrosion resistant housing and durable lenses to provide protection against the elements



### Halogen 4" AXXENT® Light Kit

#### C3062K - Clear Lens

- Kit includes 2 lights, wiring kit, illuminated on/off switch, mounting brackets, hardware and installation instructions
- Heavy-duty steel housing and durable polycarbonate lens provide protection against the elements
- Replacement 12V/55W/H3 bulb
- Current draw: 3.2 Amps



### LED 3.5" Driving Light Kit

#### C3067K

- Kit includes 2 lights, wiring kit, illuminated on/off switch, mounting brackets, hardware and installation instructions
- Die cast aluminum housing and durable polycarbonate lens provide protection against the elements
- 283 effective lumens
- Off-road use only
- Current draw: 0.6 Amps



### LED 2.5" AXXENT® Light Kit

#### AX4020K

- Kit includes 2 lights, wiring kit, illuminated on/off switch, mounting brackets, hardware and installation instructions
- ABS plastic housing and durable PMMA lens provide protection against the elements
- Current draw: 0.12 Amps



### LED 4" AXXENT® Light Kit

#### AX4050K

- Kit includes 2 lights, wiring kit, illuminated on/off switch, mounting brackets, hardware and installation instructions
- ABS plastic housing and durable PMMA lens provide protection against the elements
- Current draw: 0.04 Amps



### Halogen 3" x 5.5" Driving Light Kit

#### DF1073KB

- Kit includes 2 lights, wiring kit, illuminated on/off switch, mounting brackets, hardware and installation instructions
- ABS plastic housing and glass lens provide protection against the elements
- Bottom vented to burn off internal condensation
- Replaceable 12V/55W/H3 bulbs
- Current draw: 5.0 Amps



### Halogen 4" x 7" Driving Light Kit

#### CW8002K

- Kit includes 2 lights, wiring kit, illuminated on/off switch, mounting brackets, hardware and installation instructions
- Molded resin housing and glass lens provide protection against the elements
- Lamps feature a rock guard to protect lens from flying debris
- For on or off road use - Designed to meet SAE requirements for driving lights
- Current draw: 5.0 Amps



### Halogen 3" x 5.5" Fog Light Kit

#### DF1075KB

- Kit includes 2 lights, wiring kit, illuminated on/off switch, mounting brackets, hardware and installation instructions
- ABS plastic housing and amber coated glass lens provide protection against the elements
- Replacement 12V/55W/H3 bulbs
- Current draw: 5.0 Amps



### 30 AMP Relay

#### N005W

- Allows switching and adding of multiple electronic devices within vehicle's power generating system
- 12 V
- Current draw: 30 Amps



### Auxiliary Wiring Kit for 12V Accessories

#### MM510

- Kit includes 40 amp relay, illuminated on/off switch and all connectors and fuses
- Switch is rated at 15 amps and 15 VDC
- Current and power circuits have in-line fuses

## Flood, Spot, and Trapezoid Beam Patterns

Heavy-duty and high output lights engineered with high performance components for agricultural and industrial use

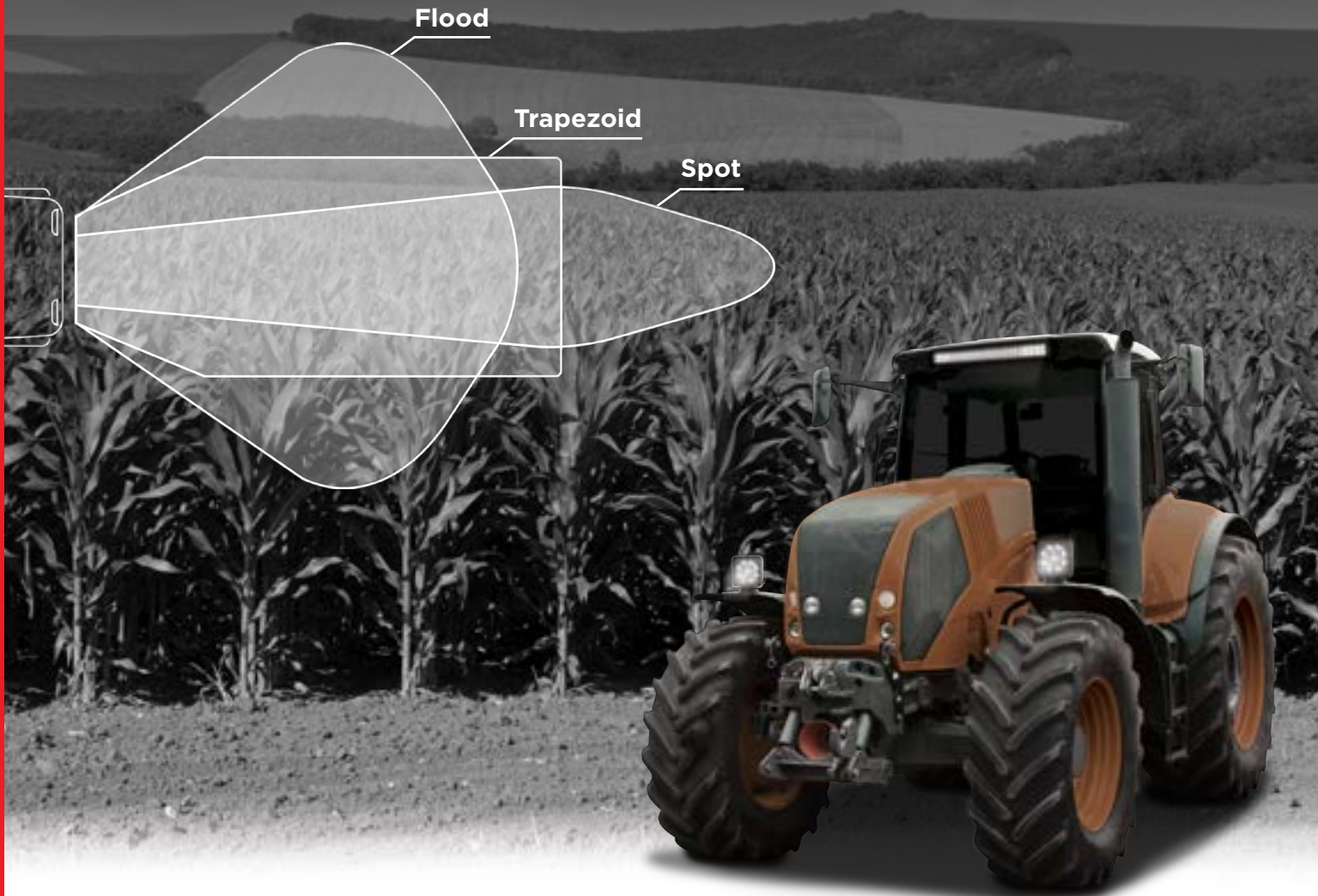

### LED 4" Work Light

#### CWL5042 - Flood Beam, 2K Lumens

- Die cast aluminum housing and high-impact polycarbonate lens
- Lumens: 3,600 Raw, 2,000 Effective
- Current draw: 2.0 Amps
- Includes light, mounting bracket and hardware

#### CWL5043 - Flood Beam, 3K Lumens

- Die cast aluminum housing and high-impact polycarbonate lens
- Lumens: 4,600 Raw, 3,000 Effective
- Current draw: 3.0 Amps
- Includes light, mounting bracket and hardware





### 2 Pk LED 4" Work Lights

#### CWL503TWP - Flood Beam

- Die cast aluminum housing and high-impact polycarbonate lens
- Lumens: 900 Raw, 625 Effective
- Current draw: 1.1 Amps
- Includes 2 lights, mounting brackets and hardware



### 2 Pk LED 4.5" Work Lights

#### CWL504TW - Flood Beam

- Die cast aluminum housing and high-impact polycarbonate lens
- Lumens: 1,450 Raw, 1,200 Effective
- Current draw: 1.15 Amps
- Includes 2 lights, mounting brackets and hardware



### LED 4.5" Work Light

#### CWL504 - Flood Beam

- Die cast aluminum housing and high-impact polycarbonate lens
- Lumens: 1,560 Raw, 1,200 Effective
- Current draw: 1.3 Amps
- Includes light, mounting bracket and hardware



### 2 Pk LED 2" Work Lights

#### CWL507TW - Flood Beam

- Die cast aluminum housing and high-impact polycarbonate lens
- Lumens: 1,200 Raw, 840 Effective
- Current draw: 0.7 Amps
- Includes 2 lights, mounting brackets and hardware



### LED 5" Work Light

#### CWL510 - Spot Beam

- Die cast aluminum housing and high-impact polycarbonate lens
- Lumens: 3,500 Raw, 2,600 Effective
- Current draw: 2.5 Amps
- Includes light, mounting bracket and hardware



### LED 5" x 2" Flood Light

#### CWL509 - Flood Beam

- Die cast aluminum housing and high-impact polycarbonate lens
- Lumens: 2,000 Raw, 950 Effective
- Current draw: 1.65 Amps
- Includes light, mounting bracket and hardware



### Halogen 5" Work Light

**C123 - 12V - Trapezoid Beam**

**C125 - 6V - Trapezoid Beam**

- Stud mount installation
- Shock proof rubber housing and glass lens
- Replaceable #4411-1 halogen bulb
- Current draw: 3.5 Amps
- Includes light, mounting bracket and hardware



### Halogen 7" x 4" Work Light

**C8005W - Trapezoid Beam**

**C8006W - Spot Beam**

**C8007W - Flood Beam**

- Stud mount installation
- Corrosion resistant molded housing and grill
- Replaceable H3-55W halogen bulb
- Current draw: 3.5 Amps
- Includes light, mounting bracket and hardware



### Halogen 6" x 3" Rear Mount Tractor Light

**C8011 - Trapezoid Beam**

**C8010 - Flood Beam**

- Surface mount installation
- Corrosion resistant molded housing and glass lens
- Replaceable 55W halogen bulb
- Current draw: 5.0 Amps
- Includes light, mounting bracket and hardware



### LED 4" Work Light

**CWL506 - Flood Beam**

- Die cast aluminum housing and high-impact polycarbonate lens
- Lumens: 1,560 Raw, 1,200 Effective
- Current draw: 1.3 Amps
- Includes light, mounting bracket and hardware



### LED 2" Work Light

**CWL507 - Flood Beam**

- Die cast aluminum housing and high-impact polycarbonate lens
- Lumens: 1,200 Raw, 600 Effective
- Current draw: 1.2 Amps
- Includes light, mounting bracket and hardware



### LED 4" x 3" Work Light

**CWL508 - Flood Beam**

- Die cast aluminum housing and high-impact polycarbonate lens
- Lumens: 1,200 Raw, 745 Effective
- Current draw: 1.43 Amps
- Includes light, mounting bracket and hardware



**The Wide View Advantage™**  
**LED 3.5" x 2.5" Work Light**

**CWL529 - Spot/Flood Beam**

- Die cast aluminum housing and high-impact polycarbonate lens
- Lumens: 2,500 Raw, 1,500 Effective
- Current draw: 1.0 Amps
- Includes light, mounting bracket and hardware



**The Wide View Advantage™**  
**LED 6.5" Work Light**

**CWL528 - Spot/Flood Beam**

- Die cast aluminum housing and high-impact polycarbonate lens
- Lumens: 2,900 Raw, 1,700 Effective
- Current draw: 1.43 Amps
- Includes light, mounting bracket and hardware



**The Wide View Advantage™**  
**LED 7.5" Light Bar**

**CWL526 - Flood Beam**

- Aluminum extrusion housing and high-impact polycarbonate lens
- Housing designed to reduce wind noise at highway speeds
- Lumens: 1,800 Raw, 1,200 Effective
- Current draw: 0.9 Amps
- Includes light with lead wire, mounting brackets and hardware



**The Wide View Advantage™**  
**LED 11.5" Light Bar**

**CWL523 - Flood Beam**

- Aluminum extrusion housing and high-impact polycarbonate lens
- Housing designed to reduce wind noise at highway speeds
- Lumens: 3,000 Raw, 2,400 Effective
- Current draw: 1.9 Amps
- Includes light with lead wire, mounting brackets and hardware



**The Wide View Advantage™**  
**LED 17.5" Light Bar**

**CWL525 - Flood Beam**

- Aluminum extrusion housing and high-impact polycarbonate lens
- Housing designed to reduce wind noise at highway speeds
- Lumens: 4,800 Raw, 3,600 Effective
- Current draw: 2.8 Amps
- Includes light with lead wire, mounting brackets and hardware



**The Wide View Advantage™**  
**LED 20" Light Bar**

**CWL527 - Flood Beam**

- Aluminum extrusion housing and high-impact polycarbonate lens
- Housing designed to reduce wind noise at highway speeds
- Lumens: 6,000 Raw, 4,800 Effective
- Current draw: 4.0 Amps
- Includes light with lead wire, mounting brackets and hardware

# REFLECTIVE DRIVEWAY MARKERS

## Any season! Any Time! Anywhere!

Blazer® Driveway markers are great for marking driveways, parking lots and curbs for snow removal or marking property boundaries

Reflector staffs are made with specialized fiberglass and/or steel that is weather resistant, highly visible and simple to install



2-Sided  
Reflector  
Markers

Fiberglass  
Reflective Tape  
Markers

Choose from a  
wide variety of  
colors, shapes  
and sizes!

Multi-Packs  
Are Great For  
Contractors

Multi-pack options: 4, 8, 24 or 72 pieces





### 36" Red 2-Sided Driveway Marker

**376RDM - Red, Single staff with UPC, 8 pcs.**

**376RDM-8 - Red, 8 pcs.**

**376RDM-24 - Red, 24 pcs.**

- 2" x 3.25" round reflectors sealed in plastic housing
- 36" galvanized rod is 0.1875" round and corrosion resistant



### 36" Blue 2-Sided Driveway Marker

**376BDM - Blue, Single staff with UPC, 8 pcs.**

**376BDM-8 - Blue, 8 pcs.**

**376BDM-24 - Blue, 24 pcs.**

- 2" x 3.25" round reflectors sealed in plastic housing
- 36" galvanized rod is 0.1875" round and corrosion resistant



### 48" Fiberglass Snow Pole Markers

**3810DM - Orange, Single staff with UPC, 24 pcs.**

**3810DM-4 - Orange, 4 pk. Carded, 8 pcs**

**3810DM-24 - Orange, 24 pcs.**

**3810DM-72 - Orange, 72 pcs.**

**381YDM - Yellow, Single staff with UPC, 24 pcs.**

**381YDM-24 - Yellow, 24 pcs.**

**381YDM-72 - Yellow, 72 pcs.**

- 48" durable fiberglass pole is 0.25" round and corrosion resistant
- Top 10" is wrapped with high visibility reflective tape and a protective cap on top to prevent splintering when tapping into ground
- Pointed tip for easy installation



### 72" Orange Fiberglass Snow Pole Marker

**3720DM - Orange, Single staff with UPC, 12 pcs.**

**3720DM-24 - Orange, 24 pcs.**

- 72" durable fiberglass pole is 0.25" round and corrosion resistant

- Top 10" is wrapped with high visibility reflective tape and a protective cap on top to prevent splintering when tapping into ground

- Pointed tip for easy installation

- 72" height for areas where snow drifting occurs, or for use in parking lots in order to see the marker above the hood or trunk of most vehicles

# WIN AT WINTER WITH EXPERIENCE AND INNOVATION FROM HOPKINS®



MAKING WINTER DRIVING SAFER THROUGH INNOVATION™

# WINTER TOOLS

## RELENTLESS INNOVATION

We are obsessed with enduring, leading edge, dependable and superior products in every subcategory to enhance the consumer experience

## PROVEN EXPERIENCE

Two brands combining for over 100 years of expertise, using and testing the product ourselves, and gaining consumer insights, all to bring our knowledge back to the products we offer

## UNRIVALED SELECTION

We are committed to providing the widest and deepest assortment of winter tools to perfectly fit any customer's needs and strategies



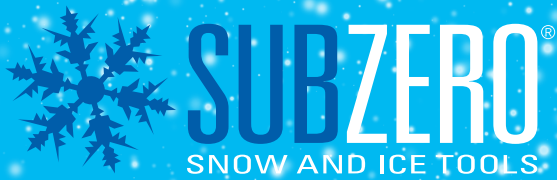

**ICE DOESN'T STAND  
A CHANCE!**

**MAXX**  
SERIES  
**FORCE™**

**Offset Chippers Cut  
Through Thick Ice**

**Patented Flex-Blade™  
Conforms to Windshield**

## **It's Not A Scraper It's an OBLITERATOR**

### **MAXX-Force Series™**

**14185** - 50" MAXX-Force™ Ultimate Crossover Snowbroom - p. 145

**1220141051** - 50" MAXX-Force™ Crossover Snowbroom - p. 145

**14161** - 60" MAXX-Force™ Snowbroom - p. 146

**14135** - 37" MAXX-Force™ Snowbrush - p. 149

**14125** - 11" MAXX-Force™ Scraper - p. 151





# CROSSOVER SNOWBROOMS™

**THE CURVE CHANGES EVERYTHING**

The Curved Pole Increases Leverage Across the Windshield Making Scraping Easier



## 50" MAXX-Force™ Ultimate Crossover Snowbroom™

- MAXX-Force™ offset ice chippers easily cut through thick ice
- Curved pole provides superior long reach scraping ability
- Pivoting triple-action broom head features EVA foam that works on light frost and water
- MAXX-Force™ blade contours to windshield for maximum scraping width

14185 - 12 pcs. Tray Pack



## 48" Ultimate Polar Vortex™ Crossover Snowbroom™

- Curved pole provides superior long reach scraping ability
- Broom head rotates 180° and features a squeegee
- Polar Vortex™ blade contours to windshield for maximum scraping width
- Extends from 30" - 48" to provide longer reach

14170 - Extends from 32" - 42" - 12 pcs. Tray Pack

14180 - Extends from 30" - 48" - 12 pcs. Tray Pack

QP48-14180 - 48 pcs. Quarter Pallet Floor Display



## 50" MAXX-Force™ Crossover Snowbroom™

- MAXX-Force™ offset ice chippers easily cut through thick ice
- Curved pole provides superior long reach scraping ability
- Pivoting brush head features long, flagged bristles to remove the deepest snow

1220141051 - 12 pcs. Tray Pack



## 50" Avalanche™ Crossover Snowbroom™

- Brush head rotates 360° for optimal snow removal
- The Quick-Lock™ Extender easily locks into the desired length
- Built-in ice chippers break up tough ice and the wide blade easily clears away any frost

14039 - 6 pcs. Tray Pack



## 35" Avalanche™ Crossover Snowbroom™

- Brush head rotates 360° for optimal snow removal
- The Quick-Lock™ extender easily locks into the desired length
- Built-in ice chippers break up tough ice and the wide blade easily clears away any frost

14035 - 6 pcs. Tray Pack



## 38" Avalanche™ Crossover Snowbroom™

- Brush head rotates 360° for optimal snow removal
- Built-in ice chippers break up tough ice and the wide blade easily clears away any frost

14038 - 6 pcs. Tray Pack

# SNOWBROOMS

# SCRATCH-FREE SNOW REMOVAL



## 51" Heavy-Duty Arctic Plow™ With Scraper

- Super wide 16+ inch push-pull foam head clears snow quickly and won't scratch paint
  - Telescoping steel handle for extra reach
  - 4" scraper blade on opposite end for quick ice removal
- 18833 - 8 pcs. Open Stock  
18837 - 10 pcs. Floor Display



## 46" Heavy-Duty Arctic Plow™ With Grip

- Super wide 16+ inch push-pull foam head clears snow quickly and won't scratch paint
  - Telescoping steel handle for extra reach
- 18841 - 8 pcs. Open Stock  
18845 - 8 pcs. Tray Pack  
18847 - 10 pcs. Floor Display



## 35" Mini Arctic Plow™ With Grip

- Clears deep and heavy snow
  - No-scratch 13.5" foam head
  - Long reach - yet small enough to store in any vehicle
- 18849 - 8 pcs. Open Stock



## 60" MAXX-Force™ Snowbroom

- MAXX-Force™ offset ice chippers easily cut through thick ice
  - Non-scratch EVA foam removes deep snow
  - Extends up to 60" for maximum reach across windshields
  - Patented Flex Blade™ contours to windshield to remove frost
- 14161 - 12 pcs. Tray Pack



## 52" Avalanche™ Extreme Snowbroom

- Wide broom head rotates 180 degrees and features non-scratch EVA foam
  - Quick-Lock™ extender easily locks into desired length
  - Rubber grips for ultimate control
- 14052 - 12 pcs. Tray Pack



## 54" Snow Plow™ Snowbroom

- Foam plow clears heavy snow
  - Quick-Lock™ extender easily locks to desired length
  - 4" Avalanche™ scraper blade for ice and frost removal
- 14403 - 12 pcs. Open Stock

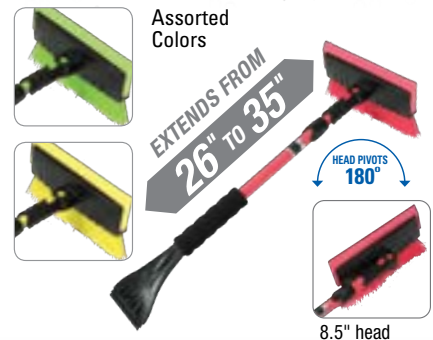

## 35" Mini Snow Plow™ Snowbroom

- Wide 8.5" sweeping area with tall head
  - EVA foam squeegee clears light frost and water without scratching paint
  - Twist-Lock™ extender easily locks into desired length
- 3512PBT - 12 pcs. Open Stock

# POWER FORCE™

POWER-Force™ ice chippers cut through thick ice



Easily locks into desired length

## THE POWER TO MAKE ICE DISAPPEAR

### POWER Force Series™

- 14454 - 54" Snowbroom - p. 148
- 13060 - 44" Extending Snowbrush - p. 149
- 13030 - 34" Snowbrush - p. 150
- 13050 - 11" Ice Scraper - p. 152





### 54" POWER-Force™ Snowbroom

- POWER-Force™ ice chippers easily cut through thick ice
- Pivoting broom head features rubber squeegee for easily removing moisture
- 4" chisel blade for frost/ice removal

14454 - 12 pcs. Tray Pack

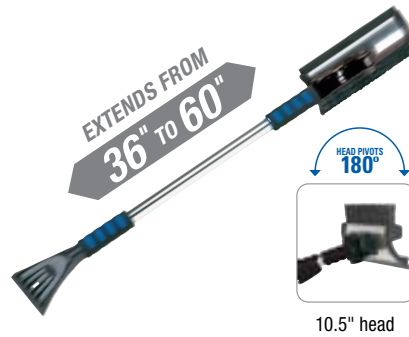

### 60" Quick-Lock™ Pivoting Snowbroom

- Quick-Lock™ extension pole reaches 60"
- Extra wide scraper blade
- Pivoting soft bristle snowbroom and squeegee
- Great for trucks, SUVs and RVs

80037 - 6 pcs. Open Stock

80038 - 6 pcs. Tray Pack

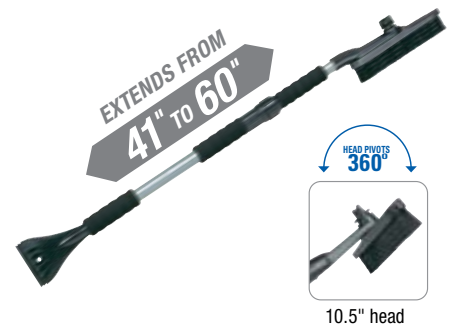

### 60" Monster™ Swivel Snowbroom

- 60" reach when fully extended
- Super heavy-duty steel tube for extended reach
- Extra wide blade for maximum ice removal

15781 - 8 pcs. Open Stock



### 54" Avalanche™ Pivoting Snowbroom

- Aggressive blade breaks through thick ice
- Added leverage positions for directing more pressure to the blade
- Heavy-duty pivoting broom + squeegee provides long reach for large vehicles
- Quick-Lock™ extender easily locks into desired length

14015 - 12 pcs. Tray Pack

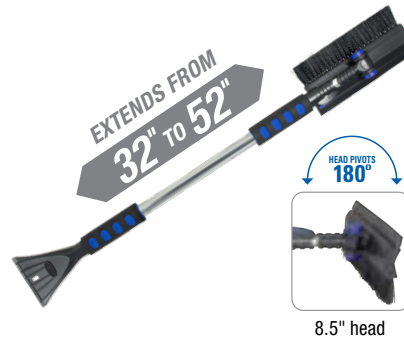

### 52" Quick-Lock™ Pivoting Snowbroom

- Quick-Lock™ extension pole reaches 52"
- Extra wide scraper blade
- Pivoting soft bristle snowbroom and squeegee
- Great for trucks, SUVs and RVs

80052 - 6 pcs. 52" Open Stock



### 52" Pivot Head Sport Telebroom™

- Extends from 34" to 52" for maximum reach
- Pivoting broom head also features a rubber squeegee
- Contour foam grip provides ultimate comfort

583-EP - 6 pcs. Open Stock

F14-583-EP - 14 pcs. Floor Display

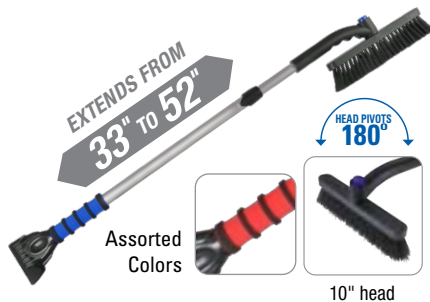

### 52" Extending Ice Chisel Snowbroom

- Broom head rotates 360° to remove snow from any angle
- Twist-Lock™ extender easily locks into desired length
- Ice Chisel™ blade has separate ice chippers to cut through thick ice

S24-582-EPSZ9 - 24 pcs. Tray Pack

582-EPSZ9 - 12 pcs. Open Stock



### 48" Sport 8 Utility Snowbroom

- Extends from 30" to 48" for added length and reach
- Barrel-lock allows for quick and easy length adjustments
- Easily pushes snow off of roof, hood and front windshield

581-E - 6 pcs. Open Stock

F12-581-E - 12 pcs. Floor Display

S12-581-E - 12 pcs. Tray Pack

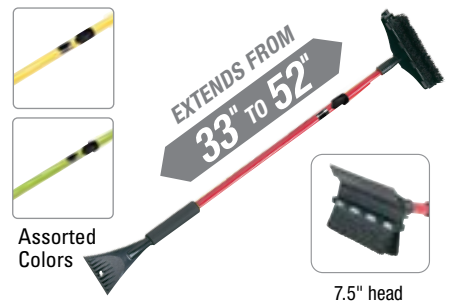

### 52" Super Extender Snowbroom

- Heavy-duty broom for snow clearing power
- Steel extender handle with soft cushion grip
- Extra wide blade on brush head with convenient removable squeegee

2610XM - 10 pcs. Open Stock

2672XM - 72 pcs. Pallet



### 48" Extender Snowbroom

- Twist-Lock™ extender easily locks into desired length
- Wide blade and broom extend to 48"
- Great for larger vehicles

2610XB - 10 pcs. Open Stock  
 2610FD - 20 pcs. Floor Display  
 26120 - 120 pcs. Pallet



### 35" Mini Pivot Telebroom™

- Extends from 26" to 35" to provide a longer reach
- Pivoting broom head also features a rubber squeegee
- Barrel-lock allows for secure extension

580-EP - 6 pcs. Open Stock  
 F15-580-EP - 15 pcs. Floor Display  
 S12-580-EP - 12 pcs. Tray Pack



### 36" Mini Extender Snowbroom

- Extends from 23" to 36" to provide a longer reach
- Barrel-lock allows for quick and easy length adjustments
- Perfect for small to mid-size vehicles

511-E - 10 pcs. Open Stock  
 F16-511-E - 16 pcs. Floor Display  
 S16-511-E - 16 pcs. Tray Pack

## SNOWBRUSHES



### 48" Polar Vortex™ Telescopic Snowbrush

- Twist-Lock™ extender easily locks into desired length
- XL brush head to clear deep snow
- Polar Vortex™ blade contours to windshield for maximum scraping width

999-EPPV - 16 pcs. Open Stock



### 37" MAXX-Force™ Snowbrush

- MAXX-Force™ offset ice chippers easily cut through thick ice
- Curved pole keeps hands out of the snow and makes removal easier
- XL brush head to clear deep snow

14135 - 12 pcs. Tray Pack



### 44" POWER-Force™ Telescopic Snowbrush

- POWER-Force™ ice chippers easily cut through thick ice
- Twist-Lock™ extension provides long reach from 34" to 44"
- Thick brush head for snow removal

13060 - 12 pcs. Tray Pack



### 42" Ice Chisel® Telescopic Snowbrush

- Ice Chisel® scraper with 2-blades-in-1, ice chipping plus frost removal
- Twist-Lock™ extender easily locks into desired length
- Improved thicker brush head

13054 - 12 pcs. Open Stock  
 13059 - 12 pcs. Tray Pack



### 35" Ultra MAXX® Snowbrush

- Five rows of bristles quickly remove deep snow
- Thick 1" lightweight aluminum pole for ease of use for all consumers
- Curved pole keeps hand out of snow

999CT - 6 pcs. Open Stock  
 F14-999CT - 14 pcs. Floor Display  
 S16-999CT - 16 pcs. Tray Pack  
 QP72-999CT - 72 pcs. Quarter Pallet



### 34" Mega MAXX™ Snowbrush

- Curved pole provides an ergonomic design making it easier to reach the middle of the windshield
- Lightweight aluminum pole is easy for any consumer to use
- Five rows of bristles quickly remove deep snow

989-34 - 6 pcs. Open Stock



**34" POWER-Force™ Snowbrush**

- POWER-Force™ ice chippers easily cut through thick ice
- Strong steel handle for increased durability
- Thick brush head for snow removal

13030 - 12 pcs. Tray Pack



**35" Ice Crusher™ Snowbrush**

- Dual action bristles provide soft protection and interior brushing power
- Separated ice chippers on the brush head break through the thickest ice
- Wide blade quickly removes frost

16620 - 12 pcs. Open Stock



**35" Avalanche™ Snowbrush**

- Aggressive blade breaks through the thickest ice
- Added leverage positions allow application of more pressure to the blade
- Improved thicker brush head

14014 - 14 pcs. Tray Pack



**35" MAXX® X35 Snowbrush**

- 35" length allows for long reach while scraping or brushing off snow and ice
- Full brush head removes snow from hard to clear areas
- Lightweight aluminum pole allows for easy use for all consumers

996-35 - 12 pcs. Open Stock  
 S24-996-35 - 24 pcs. Tray Pack  
 F20-996-35 - 20 pcs. Floor Display

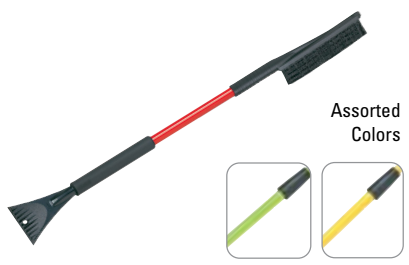

**35" Blizzard™ Snowbrush**

- Two rows of bristles quickly remove deep snow
- Contoured soft cushion grip
- Coated, heavy-duty handle

13781 - 14 pcs. Tray Pack  
 3518FD - 18 pcs. Floor Display



**32" Ice Chisel™ Snowbrush**

- Two rows of bristles quickly remove deep snow
- Ice Chisel® scraper with 2-blades-in-1, ice chipping plus frost removal
- Strong handle with soft cushion grip

13024 - 12 pcs. Open Stock  
 13025 - 12 pcs. Tray Pack



**23" Falcon™ Snowbrush**

- Ergonomic rubber styling with non-slip grip
- Double row bristles remove heavy snow
- Quickly remove ice with patented 2-way, push-pull scraper design

15613 - 12 pcs. Tray Pack  
 23110Q - 110 pcs. Pallet



**26" Power Series™ Snowbrush**

- Premium soft-touch rubber grip for ultimate comfort
- Dual grip zones improve leverage against thick ice
- Patented Duo reversible blade improves ergonomics from both sides of the vehicle

18520 - 12 pcs. Tray Pack



**26" Cool Snow Tool® Snowbrush**

- Four rows of sturdy bristles provide a thick and full brush for snow removal
- Curved handle keeps hands out of snow
- Foam grip provides ultimate comfort

532 - 12 pcs. Open Stock  
 S24-532 - 24 pcs. Tray Pack  
 F20-532 - 20 pcs. Floor Display

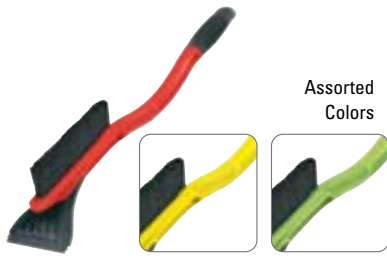

### 23" Ice Hammer™ Snowbrush

- Curved handle keeps hands out of snow
  - Soft-molded grip repels water and withstands UV rays for longer life
  - Built-in ice chippers break up tough ice
- 16511** - 8 pcs. Tray Pack



### 21.5" Ice Ripper™ Snowbrush

- Durable design encourages step-up sales
  - Aggressive scraper blade
  - Palm pad for increased leverage
- 16024** - 20 pcs. Tray Pack



### 24" Slimline 24 Snowbrush

- Molded contour grip for comfort
- Durable bristles to sweep snow off your vehicle
- Strong ice scraper provides quick and easy ice/frost removal

**523** - 24 pcs. Open Stock  
**S24-523** - 24 pcs. Tray Pack  
**F24-523** - 24 pcs. Floor Display



### 22" Super Deluxe™ Snowbrush

- World's best selling snowbrush, often copied, but never duplicated
- 4" wide Bear Claw® blade
- Perfect for small to medium size passenger vehicles

**19520** - 20 pcs. Tray Pack  
**2248FD** - 48 pcs. Floor Display



### 16" SnoWeevil™ Snowbrush

- 16" compact design stores easily
- Contour design allows for a better grip
- 4 rows of thick bristles to remove deep snow

**S18-518** - 18 pcs. Tray Pack



### 25" Valu Reach Sweep™ Wood Handle Snowbrush

- Constructed with high quality material for long lasting durability
- Strong ice scraper with ice chippers removes ice quickly and easily
- Popular among traditional consumers

**203** - 24 pcs. Open Stock  
**50-203** - 50 pcs. Open Stock

## ICE SCRAPERS



### 11" MAXX-Force™ Scraper

- MAXX-Force™ offset chippers easily cut through thick ice
- 4" wide Patented Flex Blade™ conforms to the glass
- Rubber grip for ultimate control

**14125** - 18 pcs. Tray Pack



### 11" Polar Vortex™ Scraper

- Polar Vortex™ blade contours to windshield for maximum scraping width
- Separate ice chippers to cut through thick ice
- Rubber grip for ultimate control

**14120** - 18 pcs. Tray Pack  
**14120Y** - 18 pcs. Tray Pack (Yellow)



### 11" Talon™ Ice Scraper

- Ergonomic rubber styling with non-slip grip
- 2-way, push-pull scraper design for faster removal of ice and frost
- Integrated chippers score ice for quick removal

**15511** - 24 pcs. Tray Pack



### 11" POWER-Force™ Ice Scraper

- POWER-Force™ ice chippers easily cut through thick ice
- 4" chisel blade for frost removal
- Foam grip for comfort

13050 - 24 pcs. Tray Pack



### 11" Ice Crusher™ Scraper

- Two durable blades - one for frost, one for ice
- Extra wide 4.5" blade
- Foam grip for added comfort

16621 - 24 pcs. Tray Pack



### 11" Avalanche™ Ice Scraper

- Aggressive blade breaks through the thickest ice
- Added leverage positions allow application of more pressure to the blade
- Cushioned grip for comfortable scraping

14012 - 24 pcs. Tray Pack



Assorted Colors

### 10" Ice Chisel® Scraper

- Patented 2-blades-in-1 design, ice chipping plus frost removal
- 3.5" scraper blade
- Foam grip available in assorted colors

13014 - 12 pcs. Open Stock

13044 - 24 pcs. Tray Pack



Assorted Colors

### 11" Ice Ripper™ Scraper

- Built-in side chippers break through tough ice
- 4" wide blade easily clears away frost
- Flat, compact design, for easy storage

16250 - 24 pcs. Tray Pack

16251 - 12 pcs. Open Stock



### 10" MAXX® XS Ice Scraper

- 4" wide scraper for quick and easy ice and frost removal
- Strong ice chippers on top of the blade breaks up the thickest ice
- Contour foam grip provides ultimate comfort and control

S24-994 - 24 pcs. Tray Pack



Assorted Colors

### 11" Klondike™ Ice Scraper

- Flat, compact design for easy storage
- Oversized chippers for superior ice breaking power
- Wide 4" frost clearing blade

1124F - 24 pcs. Tray Pack



### 9" Ice Ripper™ Ergonomic Scraper

- Ergonomic, rounded handle for greater grip power and comfort
- Thumb pad allows application of more pressure to the blade

16211 - 24 pcs. Tray Pack



### 10" Bear Claw® Ice Scraper

- Flat, compact design, for easy storage
- Most popular OPP scraper
- Curved handle helps keep hand off windshield
- Wide 4" frost clearing blade

16721 - 24 pcs. Tray Pack



### Faux Fur Scraper Mitt

- Elegant faux rabbit fur creates a high perceived consumer value
- Ultra soft polyester lining provides warmth and comfort
- A perfect gift item
- 4" wide scraper blade

13929 - 12 pcs. Open Stock



Assorted Colors

### Premium Ice Scraper Mitt

- Quilted outer layer for exceptionally soft feel
- Cotton core and fleece lining for extra warmth and comfort
- Durable scraper breaks through the toughest ice

13920 - 12 pcs. Tray Pack

13920CS - 12 pcs. Clip Strip





# ARCTIC DEFENSE™

## WINDSHIELD COVERS



❄️ **Single Person Setup**

❄️ **Flex Anchors™ Secure Windshield Cover to Vehicle**



17541

### ArcticDefense MAXX™ Windshield Cover

- Flex Anchors™ secure cover to windshield inside vehicle doors
- HD Canvas material
- Fits all vehicles (42" x 61")

17540 - 5 pcs. Tray Pack  
17541 - 12 pcs. Floor Display



### ArcticDefense™ Windshield Cover

- Flex Anchors™ secure cover to windshield inside vehicle doors
- Fits most vehicles (32" x 61")

17505 - 6 pcs. Tray Pack



### ArcticGuard™ Truck Windshield Cover

- Fits almost all vehicles (40" x 73")
- Covers side-view mirrors
- Packaging footprint is significantly smaller than competitive covers

17529 - 6 pcs. Tray Pack



### ArcticGuard™ Car Windshield Cover

- Folds compact for easy storage
- Packaging footprint is significantly smaller than competitive covers
- Size: (29" x 70")

17511 - 6 pcs. Tray Pack



# Ultimate Snow and Grime Protection



## Customizable Boot Tray

- 3 piece easy snap design for versatility.
- Deep channel basins along the side for liquid run off
- Assembled tray dims 36.5" x 16" x 1"
- Great for in the vehicle, home, or garage

12555 - 6 pcs. Tray Pack



## GripTrax™ Maxx Traction Tool

- Flexible traction bars conform to all terrains
- 33" length folds compactly into provided storage bag
- Eliminates shoveling and pushing

12505 - 4 pcs. Tray Pack



## GripTrax™ Traction Tool

- Place in front or behind tires for traction
- Designed to hold in place, won't fly out
- Works in snow, mud and sand

12501 - 4 pcs. Open Stock



## Heavy-Duty Aluminum Emergency Shovel

- Heavy-duty aluminum construction holds up to demanding jobs
- Extends to 30" for long reach
- Dual-function scoop or dig design

17222 - 6 pcs. Tray Pack  
17222HT - 6 pcs. Open Stock



## Auto Emergency Shovel

- Extends to 37" for long reach
- 9.5" wide shovel head
- Compact for easy storage when closed

17211 - 8 pcs. Tray Pack  
17228 - 8 pcs. Floor Display  
17297 - 8 pcs. Shovel/Scraper combo Floor Display



## Boot Tray (15" x 30" x 1.15")

- Raised ridges allow footwear to thoroughly drip dry
- Easy to clean up
- Perfect accessory for any vehicle or home

12550 - 6 pcs. Open Stock



## Ice Cleats™

- Aggressive spikes help prevent dangerous slips and falls
- One size fits most shoes
- Durable material for long lasting effectiveness

12201 - 6 pcs. Tray Pack



## Winter Salt Eraser

- Bi-level bristles utilize stiff sweeping fibers
- Cap incorporates spot scrubber and groove cleaning tool
- Great for carpet, floor mats, and fabrics
- 18.5 oz.

572100C - 6 pcs. Tray Pack



## 12V Heated Travel Blanket

- 57" x 39" super soft polyester
- High/Low heat setting
- 6.5' cord length for added reach to back seat

12620 - 6 pcs. Tray Pack



### Lock De-Icer™ and Lubricant

- Thaws frozen locks
- Lubricates lock cylinder
- Contour foam grip provides ultimate comfort and control

**22-5-00500-SZ** - 24 pcs. Tray Pack, 18.5 ml  
**22-5-00500-SZFB24** - 24 pcs. Fish Bowl, 18.5 ml  
**22-5-00502-SZ** - 12 pcs. Tray Pack, 37 ml  
**22-5-00500-SZCS12** - 12 pcs. Clip Strip, 18.5 ml



### HotSpot™ Hand Warmers

- Up to 10 hours of heat for Hand Warmers and 8 hours for Toe Warmers, activates in seconds
- Reaches temps up to 140°
- 2 warmers per pack
- Toe warmers include adhesive to keep in place

**12324** - 24 pcs. Tray Pack



### 36" Two-Sided Round Reflective Driveway Marker

- 2 x 3.25" round reflectors sealed in plastic housing
- 36" galvanized rod is 0.1875" round and corrosion resistant
- Highly visible at night and in inclement weather

**376RSZ** - Single staff with UPC, Red, 8 Pk box  
**376RSZ-8** - Red, 8 Pk box  
**376RSZ-24** - Red, 24 Pk box



### 48" & 72" Reflective Fiberglass Driveway Marker

- 48" & 72" durable fiberglass pole is 0.25" round
- Top 10" is wrapped with high visibility reflective tape and has a protective cap on top to prevent splintering when tapping into the ground
- Features a pointed tip for easy installation

**3810SZ** - 48" staff with UPC, Orange, 72 Pk box  
**3810SZ-4** - 48" staff, 4 Pk carded, Orange, 8 Pk box  
**3810SZ-24** - 48" staff, Orange, 24 Pk box  
**3810SZ-72** - 48" staff, Orange, 72 Pk box



**MOSSY OAK®**

*It's Not a Passion.  
It's an Obsession.®*

The outdoor brand leader joins forces with the worldwide leader in winter snow and ice tools



EXTENDS FROM  
**31" TO 45"**

Assorted Patterns  
Obsession™ &  
Break-Up Country™



Assorted Patterns  
Obsession™ &  
Break-Up Country™



### 45" Mossy Oak® Snowbroom

- 4" aggressive scraper blade features aggressive leverage positions to help break through the thickest ice
- Heavy-duty pivoting broom and squeegee rotates 180°
- Two foam grips provide comfort for all applications of the scraper and brush

**MO14011CB** - 12 pcs. Tray Pack  
**MO14082CB** - 48 pcs. ¼ Pallet

### 32" Mossy Oak® Snowbrush

- 4" aggressive blade breaks through the thickest ice
- Added leverage positions allow application of more pressure to the blade
- Thick bristles quickly remove deep snow

**MO14021CB** - 12 pcs. Tray Pack  
**MO14091CBFD** - 24 pcs. Floor Display  
**MO14093FD** - 24 pcs. Floor Display, Assorted Colors Pink & Green

### 32" Mossy Oak® Break-Up® Pink Snowbrush

- 4" aggressive blade breaks through the thickest ice
- Added leverage positions allow application of more pressure to the blade
- Thick bristles quickly remove deep snow

**MO14020PB** - 12 pcs. Tray Pack  
**MO14092PBFD** - 24 pcs. Floor Display  
**MO14093FD** - 24 pcs. Floor Display, Assorted Colors Pink & Green

### Mossy Oak® Break-Up® Pink Mitt Scraper

- Quilted outer layer for exceptionally soft feel
- 4" durable scraper for frost
- Separate ice chippers break through thick ice

**MO13910PB** - 12 pcs. Tray Pack



# SEE A BETTER ROAD AHEAD

**A DONATION IS MADE FOR EVERY PINK PRODUCT SOLD**



SubZero® and Mallory® have teamed up to support the National Breast Cancer Foundation, Inc.® (NBCF) by offering four different pink items to help support the NBCF

A portion of all sales will be donated to NBCF in support of their mission - to save lives through increasing breast cancer awareness through education, providing diagnostic breast cancer care services for those in need, and providing nurturing support services



### 45" Telescopic Snowbroom

- Extends from 28" to 45" for increased reach
- Contour foam grip provides ultimate comfort
- Barrel-lock allows for quick and easy length adjustments

**S12-577-EPKUS** - 12 pcs. Tray Pack  
**D8-577-EPKUS** - 8 pcs. Display



### 31" Pink Snowbrush

- Strong ice scraper to remove frost and heavy ice
- Thick, full brush for easy snow removal
- Lightweight aluminum pole provides ease-of-use for all consumers

**S30-886PKUS** - 30 pcs. Tray Pack  
**D24-886PKUS** - 24 pcs. Display



### 22" Pink Snowbrush

- Effective scraper cuts through frost and heavy ice
- Brush easily clears snow from all areas of the vehicle
- Compact size for effective storage

**S24-527PKUS** - 24 pcs. Tray Pack  
**DS58-3BHPKUS** - 24 pcs. Floor Display



### 10" Pink Ice Scraper

- 4" blade removes frost and heavy ice
- Easy to store in any vehicle
- Contour foam grip provides ultimate comfort

**994PKUS** - 24 pcs. Tray Pack

# FLOOR DISPLAYS

Whether it's inside the front entrance or another key traffic location, floor displays create high impact display options

Part #	Description	# Pcs.
2248FD	22" Super Deluxe Snowbrush Floor Display	48 pcs.
2610FD	48" Extender Snowbroom Tee Pee Display	20 pcs.
3518FD	35" Blizzard Snowbrush Floor Display	18 pcs.
3648	22" Super Deluxe Snowbrush Floor Display	36 pcs.
	10" Bear Claw Floor Display	48 pcs.
17228	Auto Emergency Shovel Floor Display	8 pcs.
17297	Auto Emergency Shovel with Bonus Ice Ripper Scraper Floor Display	8 pcs.
18837	Arctic Plow with Scraper Floor Display	10 pcs.
18847	Arctic Plow with Grip Floor Display	10 pcs.
F20-996-35	35" MAXX X35	20 pcs.
F20-532	26" Cool Snow Tool	20 pcs.
F24-523	24" Slimline 24	24 pcs.
F14-583-EP	52" Pivot Head Sport Tele Snowbroom	14 pcs.
F15-580-EP	35" Mini Pivot Tele Snowbroom	15 pcs.
F12-581-E	48" Sport 8 Utility Broom	12 pcs.
F16-511-E	36" Tele Snowbroom	16 pcs.
D8-577-EPKUS	45" Pink Telescopic Snowbroom	8 pcs.
D24-886PKUS	31" Pink Snowbrush	24 pcs.
DS58-2BPKUS	48 pcs. 886PKUS, 10 pcs. 577-EPKUS	58 pcs.
DS58-3BHPKUS	24 pcs. 886PKUS, 24 pcs. 527PKUS, 10 pcs. 577-EPKUS	58 pcs.
F14-999CT	14 pcs. 35" Ultra Maxx Snowbrush	14 pcs.
17541	ArcticDefense MAXX™ Windshield Cover	12 pcs.



17541



F14-999CT

# SPINNER RACK DISPLAYS

Highly visible movable inventory that creates a category presence for retailers with limited shelf space

Part #	Description	# Pcs.
EDWR-6	2/3 Tier Empty Wire Spinner Rack	1 pcs.
SPINNER-4W	2 Tier Empty Wire Spinner Rack	1 pcs.
DWR5D	10" Bear Claw® Ice Scraper	24 pcs.
	11" Talon™ Ice Scraper	24 pcs.
	22" Super Deluxe™ Snowbrush	40 pcs.
	23" Ice Hammer™ Snowbrush	24 pcs.
	42" Ice Chisel® Telescopic Snowbrush	24 pcs.
DWR60A	35" Crossover Snowbroom	30 pcs.
	38" Crossover Snowbroom	30 pcs.
DWRBRUSH2	21.5" Ice Ripper™ Snowbrush	40 pcs.
	42" Ice Chisel® Telescopic Snowbrush	36 pcs.
	48" Extender Snowbroom	10 pcs.
	54" Klondike™ Pivoting Snowbroom	12 pcs.
DWR112	21.5" Ice Ripper™ Snowbrush	40 pcs.
	23" Falcon™ Snowbrush	24 pcs.
	10" Ice Chisel® Scraper	48 pcs.
DWR120	22" Super Deluxe™ Snowbrush	40 pcs.
	9" Ice Ripper™ Ergonomic Scraper	48 pcs.
	23" Ice Hammer™ Snowbrush	32 pcs.
DWR137	32" Ice Chisel™ Snowbrush	24 pcs.
	35" Mini Pivoting Snow Plow™	24 pcs.
	21.5" Ice Ripper™ Snowbrush	40 pcs.
	10" Ice Chisel® Scraper	48 pcs.



DWR120



EDWR-6

# PALLET DISPLAYS

Late November and December result in as much as 50% of your seasonal sales. Capture this heavy traffic and create holding power by capitalizing on these high volume promotional vehicles

Part #	Description	# Pcs.
QP72-999CT	35" Ultra MAXX® Snowbrush	72 pcs.
QP48-14180	48" Ultimate Polar Vortex Snowbroom	48 pcs.
1090800052	52" Quick-Lock™ Snowbroom	48 pcs.
1090130056	42" Twist-Lock™ Snowbrush	60 pcs.
DS72-532L	26" Cool Snow Tool® Snowbrush	72 pcs.
QP72-1850	26" Power Series™ Snowbrush	72 pcs.



QP48-14180



**LIFT SALES WITH  
INNOVATIVE TOOLS  
THAT SATISFY  
SHOPPERS**



**THE RIGHT TOOL AT EVERY STEP™**

## INNOVATION LEADER

Continuous innovation is at the core of what we do. Within the FloTool® family of products runs a heritage of “firsts” that is driven by our commitment to improving the experience for DIY’ers

## THE RIGHT BRAND FOR EVERY SHOPPER

The brand neutral FloTool® line of products are always compatible, regardless of the brand allegiance of your customer. Never lose a sale by having the wrong brand

## THE RANGE OF PRODUCTS SHOPPERS ARE LOOKING FOR

Only FloTool® can tailor your planogram with opening price point items along with innovative step-up solutions that make vehicle maintenance easier for DIY’ers... keeping your customers satisfied and coming back for more





# LIFTING OIL CHANGES TO THE HIGHEST STANDARD



Patented structural design combined with high strength, lightweight material makes the RhinoRamps® as strong as any other ramps on the market, resin or metal



## Better by Design

Strength and stability - that was our goal. RhinoRamps® achieve this with a Strong as Steel™ superstructure and integrated Core-Trac™ non-skid feet to reduce sliding during use. Adding our superior tread pattern and wide design make these the most secure ramps on the market. A reduced rise angle also works to accommodate low profile vehicles... a feature most other ramps can't claim!

## Space Saving and Lightweight

Our unique, nestable design not only saves space in the consumer's garage but more pieces on a pallet means reducing footprint in the warehouse, on the truck and minimizes space required on the retail shelf. This combined with our lightweight material allows for easy handling and portability making RhinoRamps® the best choice in lifting devices





Made in USA

# RAMPS

## PATENTED

Better by design

## STRONGEST

The ONLY PASE certified resin ramps

## NESTABLE

Saves space and money

## LIGHTWEIGHT

Easier to handle



### 12,000 lb. GVW RhinoRamps®

- Nestable for maximum cube utilization
- 17 degree angle for low clearance vehicles
- Wide tire width
- Made in the USA

11909MI - 1 pair Open Stock



### 16,000 lb. GVW RhinoRamps Max®

- Nestable for maximum cube utilization
- 17 degree angle for low clearance vehicles
- Extra-wide tire width
- Made in the USA

11912MI - 1 pair Open Stock

## CHOCKS



### EZ Lift Rider Ramps™

- Makes mower maintenance easy
- Provides 6" of lift
- Gripping points for use on concrete or grass
- Made in the USA

11935MI - 4 pair Cut Case



### Heavy-Duty Wheel Chocks™

- Safety device to use with ramps or other lifting devices
- Prevents tires from rolling
- Not for commercial use
- Made in the USA

11930MI - 4 pair Open Stock



### Heavy-duty Chock and Block™

- Perfect for any boat trailer, RV, stock trailer, camper, etc.
- Prevents tires from rolling
- Made in the USA

11933MI - 6 pcs.

# GRIPTECH™

The No-Slip Wrench™

## MAXIMUM GRIP WRENCHES

The GRIPTECH™ family of wrenches uses a non-slip grip that is superior to traditional oil change tools. This patented innovative grip allows the wrench to firmly grab the oil filter and remove it easily, quickly and without scrapes and bruises. Making the oil change easier can increase demand for DIY oil changes. That's exactly what GRIPTECH™ delivers.

# WRENCHES

GRIPTECH



### Swivel Handle Small Band Wrench

- Remove oil filters in hard to reach areas
- Fits oil filters 2 $\frac{7}{8}$ " to 3 $\frac{5}{16}$ " (73mm to 85mm) in diameter

10621GT - 6 pcs. Open Stock  
10621GTPDQ - 6 pcs. Cut Case



GRIPTECH



### Swivel Handle Medium Band Wrench

- Remove oil filters in hard to reach areas
- Fits oil filters 3 $\frac{3}{8}$ " to 3 $\frac{3}{4}$ " (85mm to 95mm) in diameter

10622GT - 6 pcs. Open Stock

GRIPTECH



### Swivel Handle Large Band Wrench

- Remove oil filters in hard to reach areas
- Fits oil filters 3 $\frac{3}{4}$ " to 4 $\frac{7}{16}$ " (95mm to 110mm) in diameter

10634GT - 6 pcs. Open Stock

GRIPTECH



### Swivel Handle Adjustable Band Wrench

- Accommodates four filter sizes in one
- Fits oil filters 2 $\frac{3}{4}$ " to 4 $\frac{1}{4}$ " (70mm to 108mm) in diameter

10620GT - 6 pcs. Open Stock

GRIPTECH



### Jaw-Style Wrench

- Great for hard to reach filters
- Fits oil filters 2 $\frac{1}{4}$ " to 4" (70mm to 102mm) in diameter

10631GT - 6 pcs. Open Stock

GRIPTECH



### Adjustable Chain Wrench

- Adjustable chain fits a wide range of oil filter sizes
- Fits oil filters 2 $\frac{1}{2}$ " to 4 $\frac{7}{16}$ " (64mm to 112mm) in diameter

10633GT - 6 pcs. Open Stock

GRIPTECH



### Adjustable 3-Prong Wrench

- Self adjusts to filter
- Fits oil filters 2 $\frac{3}{8}$ " to 3 $\frac{3}{4}$ " (60mm to 95mm) in diameter

10617GT - 6 pcs. Open Stock



**GRIPTECH**



**Heavy-Duty  
3-Position Pliers**

- Extra-long handles for hard to reach areas
- Fits oil filters 2½" to 4¼" (63mm to 108mm) in diameter

**10627GT** - 6 pcs. Open Stock  
**10627GTPDQ** - 6 pcs. Cut Case

**GRIPTECH**



**Industrial Strength  
Rubber Strap Wrench**

- Multiple automotive and household uses
- Fits objects up to 12" (304mm) in diameter

**10632GT** - 6 pcs. Open Stock



**Custom Fit Cap Wrench**

- Super strong graphite
- No slip grip

**Multiple Sizes** - 6 pcs. Open Stock/Carded  
**10601B/12-10609B/12** - 12 pcs. Open Stock/Bulk



**Nylon Strap Wrench**

- Use with an adjustable wrench
- Removes filters up to 6" (152mm) in diameter

**10619** - 6 pcs. Open Stock



**Small Band Wrench**

- Inside grippers hold filter
- Fits oil filters 2⅞" to 3⅝" (73mm to 85mm) in diameter

**10614** - 6 pcs. Open Stock/Carded  
**10614B/6** - 6 pcs. Open Stock/Bulk



**Medium Band Wrench**

- Inside grippers hold filter
- Fits oil filters 3⅜" to 3¾" (85mm to 95mm) in diameter

**10615** - 6 pcs. Open Stock/Carded  
**10615B/6** - 6 pcs. Open Stock/Bulk

# EXTRACTORS



## EXPERIENCE THE QUICKEST, CLEANEST & EASIEST OIL CHANGE!



### EASE OF USE

Hand pump action creates a powerful vacuum for fluid extraction - no electricity needed!



### COMPACT DESIGN

Allows for accessibility in tight spots and conveniently transfers fluids for storing, transporting and recycling



### FLEXIBLE

A versatile lineup that is perfect for a variety of applications from large to small engine fluid services

Extraction allows oil and fluids to be removed through the dip stick port. The powerful vacuum combined with tubing extensions allows easy access to hard to reach places and eliminates the need to go under the vehicle



The Topsider's reliability, convenience, and versatility make it one of the top fluid removing systems in the marine and automotive aftermarket. This sturdy and well-built product will have you changing your own fluids for years to come



### Topsider™ 8 Quart Fluid Extraction System

- A legend in the marine industry since 1985
- Durable steel construction
- Used oil and other liquids are stored safely for proper disposal
- Made in the USA

5060TS - 2 pcs. Open Stock

DO NOT USE WHILE BOAT IS IN MOTION



Made in USA



### LiquiVac™ 8 Quart Fluid Extraction System

- 8 Quart capacity for large engines or multiple small engine changes
- No mess from spills or inconvenient drain plugs
- Used oil and other liquids are stored safely for proper disposal
- Made in the USA

2000LV - 3 pcs. Open Stock



### LiquiVac™ 3 Quart Fluid Extraction System

- 3 Quart capacity is perfect size for small engine (4 cycle) oil changes
- No mess from spills or inconvenient drain plugs
- Used oil and other liquids are stored safely for proper disposal
- Made in the USA

2005LV - 3 pcs. Open Stock

# DRAINS



Made in USA



## SUPER DUTY

High Capacities and Leak-Proof Design Give Shoppers The Best DIY Drain Containers in the Market

### LEAK PROOF

Eliminates the Mess

### HIGH CAPACITY

Multiple Changes and Large Equipment

### SPACE SAVING

Store Upright or Lay Flat

### ROBUST HANDLES

Easy Transport and Handling



## SUPER DUTY™

### 16 Quart Drain Container™

- Stores upright or flat without leaking
- Integrated handle and grip for easy carrying and handling
- Extended design captures the full stream of fluid - less mess
- Made in the USA

42003MI - 4 pcs. Open Stock  
420032MI - 2 pcs. Open Stock



## SUPER DUTY™

### 10 Quart Drain Container™

- Stores upright or flat without leaking
- Integrated corner hand grips for easy carrying and handling
- Extended design captures the full stream of fluid - less mess
- Made in the USA

42001MI - 6 pcs. Open Stock  
420013MI - 3 pcs. Open Stock



## SUPER DUTY™

### 24 Quart Drain Container™

- Deep recess reduces splatter - less mess
- Three ergonomic hand grips for easy transport
- Stores upright or flat without leaking
- Made in the USA

42004MI - 2 pcs. Open Stock



## SUPER DUTY™

### 58 Quart Drain Container™

- Large capacity for multiple oil changes or commercial use
- Stores upright or flat without leaking
- Built-in wheels aid in maneuverability
- Made in the USA

42008MI - 1 pc. Open Stock

# MESSY JOBS...

# HOLD THE MESS



## **SUPER DUTY™**

### **20 Quart Less Mess Drain Pan™**

- Reduced splash
- Wider catch radius for large oil changes and radiator flushes
- Nestable design delivers more profit from less shelf space
- Made in the USA

**42010MI** - 10 pcs. Open Stock



### **Less Mess Drain Pan™**

- Extended profile catches full fluid flow
- Great for anti-freeze applications
- Built-in filter drain stand
- Made in the USA

**05080MI** - 12 pcs. Open Stock



### **7 Quart Drain Pan™**

- Built-in raised rim handles provide ease of use
- Drain scale helps track oil usage (1 to 7 quarts)
- Improved structural integrity
- Made in the USA

**OP-1** - 36 pcs. Open Stock

**OP-112** - 12 pcs. Open Stock



### **5 Gallon Drain Pan™**

- Large capacity holds multiple oil changes
- Handle and spout for easy carrying and pouring control
- Great for anti-freeze applications
- Made in the USA

**11845MI** - 4 pcs. Open Stock



### **15 Quart Drain Container™**

- Large capacity holds multiple oil changes
- Handle and spout for easy carrying and pouring control
- Built-in groove to drain filter
- Made in the USA

**11838MI** - 4 pcs. Open Stock



### **Large Drip Tray™**

- Heavy gauge steel
- Large size - 25" x 36"
- No Spills, No Mess!™
- Made in the USA

**DP-10** - 12 pcs. Open Stock

**11430MI** - 120 pcs. Pallet

## **RECYCLER**



### **Dispos-Oil™**

- 12 Quart capacity for multiple changes
- Container transports easily
- Molded handle and big mouth opening for easy carrying and pouring purposes
- Made in the USA

**11849MI** - 4 pcs. Open Stock

# HIGH-PERFORMANCE

fastest growing segment within "fill" products

QuickFill® Series funnels drive consumer satisfaction with performance features that DIYers value

## FULFILLING CUSTOMERS' NEEDS

The diversity of the FloTool® funnel lineup is proven in delivering step-up opportunities and comp store growth

### High-Performance

The ultimate funnel design puts best-in-class features to work to help the DIYer get the job done quickly and easily. Our high-performance funnels include "no-mess" splash guards, easy grip hand holds, speed channels and wide spout openings for high speed pouring. These funnels set the standard for fluid handling performance

### Task-Specific

FloTool® continues to be the leader in developing high margin funnels that are specific to certain tasks, making fluid handling easier for the consumer. These include measuring and mixing, gasoline control, diesel exhaust fluid, transmission fluid and more. Task specific products generate increased revenue for you and higher satisfaction for the consumer

### Multi-Purpose

Our multi-purpose funnels include unique step-up features such as the "no-mess" splash guard, bottle rests and flexible spouts to get to hard to reach filler holes. These middle price point items are key to product differentiation, offering balance and flexibility in your planogram

### Basic Series

The FloTool® Basic Series of funnels provide essential fluid handling benefits at a value. Typically purchased by the budget-oriented consumer for smaller engine applications and general tasks, these funnels play a pivotal role in any "Good – Better – Best" product and pricing strategy



#### Giant QuickFill® Funnel

- Designed to hold large volume bottles
- Built-in hand hold for a better grip
- Filter screen included
- No-mess splash guard
- 8¾" wide x 12¼" tall

10705 - 6 pcs. Cut Case



#### Super QuickFill® Funnel

- Designed to hold one quart bottles
- Built-in hand hold for a better grip
- Extra wide neck for high-speed pouring
- No-mess splash guard

05062MI - 12 pcs. Open Stock

05062PDQMI - 12 pcs. Cut Case



#### QuickFill® Funnel

- Speed channels maximize flow rate
- Distinct hand hold for a better grip
- No-mess splash guard

10718 - 10 pcs. Cut Case

10718WR - 12 pcs. Off Shelf/Wire Ring

10718B/24 - 24 pcs. Open Stock



# FUNNELS

TASK-SPECIFIC - engineered to do the job right



## Diesel Exhaust Fluid DEF Funnel™

- Designed to fit all DEF filler holes
- Large basin and optimal angle to prevent leaking
- Speed channels maximize flow rate

**10732WR** - 10 pcs. Off Shelf/Wire Ring  
**10732PDQ** - 10 pcs. Cut Case



## Measu Funnel™

- Measures and pours
- On/off spout with tube and cap
- Easy grip handle for premixing
- Perfect for high accuracy applications

**10704** - 6 pcs. Cut Case



## Gas Gauge Funnel™

- Floating indicator signals when gas tank is full, helps prevent spills and overfills
- Great for lawn mowers and more
- No-mess splash guard

**10711** - 6 pcs. Cut Case



## Tight Spot Funnel™

- Pliable material conforms to space
- Ideal for tight engine compartments
- Molded hand-holds for a better grip

**10716PDQ10** - 10 pcs. Cut Case  
**10716WR** - 12 pcs. Off Shelf/Wire Ring



## 2 Quart Funnel with Screen

- 2 quart capacity for large volume
- Filter screen included to clean fluids
- Built-in hang tab

**10721** - 12 pcs. Open Stock



## 1 Pint Funnel with Screen

- 2 pint capacity, great for smaller engines
- Filter screen included to clean fluids
- Built-in hang tab

**10720** - 12 pcs. Open Stock



## Super Trio Funnel

- Super QuickFill®, Multi-Purpose™, and Radiator Funnel™ combo
- Features no-mess splash guard
- Prevents fluid cross contamination
- Covers wide range of fluid applications

**10714MX3** - 6 pcs. Cut Case



## Capless Gas Tank Funnel™

- For adding fuel additives or gas from portable containers to capless and restricted fuel fillers/tanks
- Flat spot allows use with CARB Compliant Spouts

**10719** - 12 pcs. Clip Strip  
**10719PDQ5** - 5 pcs. Cut Case



## Locking Oil Funnel™

- Lock-in oil filler hole
- Funnel holds bottle while pouring
- No waste and no-mess quick pouring

**10709** - 6 pcs. Cut Case  
**10709WR** - 6 pcs. Off Shelf/Wire Ring



## Transmission Funnel

- 18" funnel made from durable copolymer plastic
- Designed for hard-to-reach fluid-filling applications
- Perfect for transmission fluid

**06064MI** - 12 pcs. Open Stock



## Radiator Funnel™

- Locks in most radiators
- No-mess splash guard
- Wide opening for quick pouring

**10703** - 12 pcs. Cut Case  
**10703WR** - 12 pcs. Off Shelf/ Wire Ring

**MULTI-PURPOSE - innovative features step shoppers up**



**Multi-Task 5-in-1 Funnel™**

- Holds one quart oil bottle
- Three interchangeable spouts, including the Flexi-Spout™
- Patented nestable design

**10710WR** - 6 pcs. Off Shelf/Wire Ring



**Super Multi-Purpose™ Funnel**

- Large size (18") for multiple applications
- Perfect for transmissions and other engine fluids
- High perceived value allows for higher retail price points

**10712WR** - 12 pcs. Off Shelf/Wire Ring  
**10712MXPW** - 20 pcs. Sidekick  
**10712PDQ** - 12 pcs. Cut Case



**3-in-1 Flex Funnel™**

- Ideal for hard to reach applications
- Distinct hand holds for a better grip
- Detachable flexible spout

**05060MI** - 12 pcs. Open Stock



**2-Piece Funnel Set**

- Multi-Purpose™ and Radiator Funnel™ combo
- No-mess splash guards
- Covers all general purpose fluid applications

**10701MX2** - 12 pcs. Open Stock



**Multi-Purpose Funnel™**

- No-mess splash guard
- Fits all sizes of filler tubes
- Extended filler neck opens gas tank trap door

**10701** - 12 pcs. Cut Case  
**10701WR** - 12 pcs. Off Shelf/Wire Ring  
**10701MXPW** - 40 pcs. Sidekick



**Big Mouth Funnel™**

- No-mess splash guard
- Wide opening for quick pouring
- Notched bottle rest

**10713** - 12 pcs. Cut Case

**BASIC**



**Extra Large Funnel**

- All purpose 18" funnel
- Great for hard to reach applications
- Tapered spout easily fits small openings

**05034MI** - 12 pcs. Cut Case



**General Purpose Funnel**

**05007MI** - 72 pcs. Small Funnel, 1/2 pint (Gray)  
**05015MI** - 72 pcs. Medium Funnel, 1 pint (Charcoal)  
**05064MI** - 12 pcs. Large Funnel, 2 QT (Black)  
**05068MI** - 12 pcs. Funnel Set (3) (Small, Medium & Large)

**SPOUTS**



**Transmission Fluid/Gear Oil Spout**

- On/off adjustable flow spout
- Reduced tip for transmission filler tubes
- Fits quarts or gallons

**10106B/6** - 6 pcs. Cut Case  
**10106WB** - 12 pcs. Off Shelf/Wire Basket



**Anti-Freeze/Windshield Washer Spout**

- On/off valve
- Adjustable flow
- No Spills, No Mess!™

**10101B/12** - 12 pcs. Open Stock  
**10101WB** - 18 pcs. Off Shelf/Wire Basket



**No Spill Oil Spout™**

- Great for quart bottles
- No Spills, No Mess!™
- Adjustable built-in valve

**10107B/12** - 12 pcs. Open Stock  
**10107WB** - 18 pcs. Off Shelf/Wire Basket



**Super Flexi-Spout™**

- Works great for hard to reach areas
- Dual threading fits most quart and gallon containers
- Perfect for adding motor oil, anti-freeze, transmission and windshield washer fluid

**10119B/24** - 24 pcs. Cut Case



**MixMizer™ Injector**

- Measure and mix only what is needed
- Complete with extension tube
- Ratio scale for exact measuring

**10111/6** - 6 pcs. Open Stock  
**10111X/6** - 6 pcs. Off Shelf/Clip Strip

# SIPHONS/PUMPS



## MAKES FLUID TRANSFER QUICK AND EASY



### Battery Operated Siphon Pump™

- Pumps 7 quarts of liquid per minute
- Pumps light fluids including gas, diesel, kerosene, anti-freeze, water and other non-corrosive liquids; *not for use with oils*
- Extended reach with 13" suction pipe
- 24" transfer tubing

10810 - 3 pcs. (Boxed) Open Stock



### Multi-Purpose Transfer Pump™

- Easily siphons or pumps any liquid
- Can be used as an air pump or blower
- Perfect for any gas can or fluid set

10803 - 6 pcs. Open Stock

10803PDQ - 6 pcs. Cut Case



### Super Siphon™

- Clear tube to view liquid flow
- Safe and easy to use
- Perfect for transferring all types of liquids
- 6 feet long

10800/6 - 6 pcs. Open Stock

10800X/6 - 6 pcs. Off Shelf



## TRANSPORT



### 5 Gallon Pail Pump

- Easily transfer fluids from 5 gallon pails
- Equipped with heavy-duty 22" tube
- Clamp holds pump in place for ease of use

10804 - 3 pcs. Open Stock (Carded Poly bag)

10804/4 - 4 pcs. Open Stock (Boxed)



### Shaker Siphon™

- Moves up to 3.5 gallons a minute
- 6 foot anti-static tube
- Perfect for home, auto, ranch, marine or farm

10801 - 6 pcs. Open Stock



### Economy Siphon™

- 6 foot tube provides length for most jobs
- Easily transfers fluids
- Perfect for the budget oriented consumer

10802 - 6 pcs. Open Stock



### 6+ Gallon Water Can

- Six gallon, 64 ounce capacity
- Self-venting spout
- Top handle and back grip for easy carrying and pouring

50863MI - 4 pcs. Open Stock

# PORTABLE FUEL FILTERS

YOUR TOOL FOR PURE FUEL

Dirt and water are the top reasons for fuel related engine failure

**DIRTY FUEL IN PURE FUEL OUT**

**Pure Fuel Makes Any Engine Run Better and Last Longer**

Dirt and water are practically unavoidable in stored fuel, causing corrosive acids, electrolysis, rust and more. These contaminants can plug filters, corrode components, decrease efficient combustion and cause engine shutdown or system failure

You can combat these problems by refueling with a Portable Fuel Filter. Protect your engine by using this innovative product every time you transfer fuel to your tank



**Works With Gasoline, Diesel, Heating Oil and Kerosene**

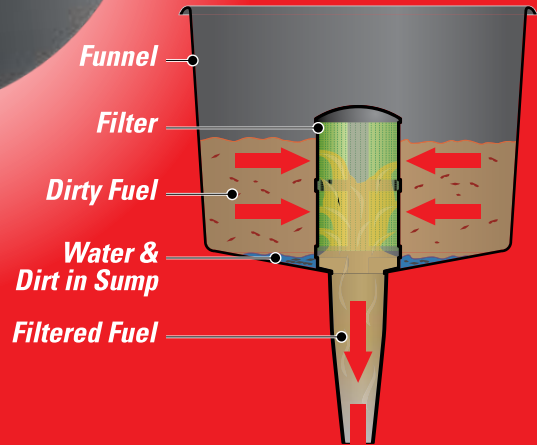

## CHOOSE THE PORTABLE FUEL FILTER WITH THE FLOW RATE BEST SUITED TO YOUR CUSTOMERS' USE

FILTER	AGRICULTURE	INDUSTRIAL	MARINE	RECREATION	LAWN	GENERATOR
F15						
F8						
F3						
F1						



### 12" Flexible Spout

- Fill fuel at any angle
- Use with medium fuel filter funnels (F3 models) only

E3 - 12 pcs. Open Stock  
ZE3 - 12 pcs. Bulk Open Stock



## UNIQUE FILTER TECHNOLOGY

When fuel is poured through a Portable Fuel Filter, water and debris will not pass through the filter's fluoropolymer-coated stainless steel filter. Only filtered fuel flows through to your engine, improving its efficiency, durability and proper operation. The sump area collects the deflected water and debris for proper disposal



### High Rate Conductive Portable Fuel Filter

Flow Rate - 12 Gallons per minute  
Diameter - 8.5 Inches  
Height - 10 Inches

F15C - 4 pcs. Open Stock



### Large Conductive Portable Fuel Filter

Flow Rate - 5 Gallons per minute  
Diameter - 8.5 Inches  
Height - 10 Inches

F8C - 6 pcs. Open Stock



### Medium Non-Conductive Portable Fuel Filter

Flow Rate - 3.5 Gallons per minute  
Diameter - 5.5 Inches  
Height - 9 Inches

F3NC - 12 pcs. Open Stock



### Medium Conductive Portable Fuel Filter

Flow Rate - 3.5 Gallons per minute  
Diameter - 5.5 Inches  
Height - 9 Inches

F3C - 12 pcs. Open Stock



### Small Conductive Portable Fuel Filter

Flow Rate - 2.5 Gallons per minute  
Diameter - 3.5 Inches  
Height - 6 Inches

F1C - 12 pcs. Open Stock



### Small Non-Conductive Portable Fuel Filter

Flow Rate - 2.5 Gallons per minute  
Diameter - 3.5 Inches  
Height - 6 Inches

F1NC - 12 pcs. Open Stock

# ABSORBENTS

## CLEAN WITH CONFIDENCE

Keeping a floor clear of spills and slickness is essential, whether it is in the commercial or DIY setting. A high quality absorbent such as FloTool® High Performance Absorbent™ will quickly stop the spread of spills, and a Mallory® floor squeegee will make clean-up a breeze. Choose from commercial-grade oil resistant blades, to general-purpose blades, to foam blades, great on smooth surfaces

*Whatever the surface, whatever the fluid,  
Mallory® floor squeegees get the job done right!*





### High Performance Absorbent™ - 25 lbs.

- 25 lbs. bulk bag for industrial use
- Instant one step clean-up
- Safer than traditional absorbents

10201 - 1 pcs. Open Stock



### High Performance Absorbent™ - 3 lbs.

- Resealable bag for small spills
- Instant one step clean-up
- Safer than traditional absorbents

10200 - 8 pcs. Open Stock



### High Performance Absorbent™ - 3 oz.

- Convenient trial size bag for small spills
- Instant one step clean-up
- Safer than traditional absorbents

10202PDQ12 - 12 pcs. Cut Case

10202 - 12 pcs. Off Shelf/Clip Strip



# Absorb More For Less

FloTool® High Performance Absorbent™ can absorb up to 8 times more liquid than traditional absorbents. The secret is how we heat-treat our wood fibers. It makes them far more effective than traditional clay and diatomaceous earth products. That's why FloTool® High Performance Absorbent™ is the best value for the consumer. Our absorbent can be used on oil, grease, lubricant, paint, water, and other fluids and is safe to use on most surfaces including concrete, blacktop, turf, carpet, linoleum, tile, and more.



# FLOOR SQUEEGEES

## COMMERCIAL GRADE (Oil Resistant)

These oil-resistant rubber blades have a higher tolerance to oil and other chemicals resulting in a longer blade life

## GENERAL PURPOSE

These general-purpose rubber blades work on all surfaces and with all fluids, perfect for the DIYer

## FOAM

A foam blade is ideal for smooth surfaces such as decks, patios, driveways, sidewalks and ceramic floors

		KITS			HEADS ONLY		
		Part #	Description	Pcs.	Part #	Description	Pcs.
COMMERCIAL GRADE		841-24-116	24" Straight Red	2 pcs.	841-24	24" Straight Red	1 pc.
					841-30	30" Straight Red	1 pc.
					841-36	36" Straight Red	1 pc.
					844-24	24" Curved Red	1 pc.
		844-30-116	30" Curved Red	2 pcs.	844-30	30" Curved Red	1 pc.
					844-36	36" Curved Red	1 pc.
GENERAL PURPOSE		840-24-116	24" Straight Gray	2 pcs.	840-24	24" Straight Gray	1 pc.
					840-30	30" Straight Gray	1 pc.
					840-36	36" Straight Gray	1 pc.
		843-24-116	24" Curved Gray	2 pcs.	843-24	24" Curved Gray	1 pc.
					843-30	30" Curved Gray	1 pc.
		843-30-116	30" Curved Gray	2 pcs.	843-36	36" Curved Gray	1 pc.
FOAM		845-24-46	24" Straight	4 pcs.	845-24	24" Straight	4 pcs.
		846-30-54	30" Straight	3 pcs.	846-30	30" Straight	4 pcs.



## KITS

Top selling heads complete with handles make it easy for consumers to shop the planogram



## HEADS ONLY

- Thick, pliable, non-marking rubber blades with industrial-grade stamped steel sockets
- Thick foam blades with zinc-plated steel heads and adjustable handle socket



## BLADE REFILLS

- 24" and 36" rubber refill blades
- Not available as a separate part for foam



## HANDLES ONLY

- 54" hardwood handle with tapered tip
- 46" vinyl-coated steel handle with grip
- 54" vinyl-coated steel handle with grip and plastic threaded tip



### BLADE REFILLS

Part #	Description	Pcs.
841R-24	24" Red	10 pcs.
841R-36	36" Red	10 pcs.
840R-24	24" Gray	10 pcs.
840R-36	36" Gray	10 pcs.

Not Available for Foam

### HANDLES ONLY

Part #	Description	Pcs.
116	54" Wooden Handles	10 pcs.
116	54" Wooden Handles	10 pcs.
130-46 Blue	46" Vinyl Coated Handle	10 pcs.
154 Black	54" Vinyl Coated Handle	10 pcs.

# MERCHANDISERS

## OFF SHELF / WIRE FIXTURES

Adding an extra ring or basket in the automotive set can increase sales by 20%

Part #	Description	Attachment	Pcs.
10101WB	Anti-Freeze/Windshield Washer Spout	Wire Basket	18 pcs.
10106WB	Trans Fluid/Gear Oil Spout	Wire Basket	12 pcs.
10107WB	No Spill Oil Spout™	Wire Basket	18 pcs.
10701WR	Multi-Purpose Funnel™	Wire Ring	12 pcs.
10703WR	Radiator Funnel™	Wire Ring	12 pcs.
10709WR	Locking Oil Funnel™	Wire Ring	6 pcs.
10710WR	Multi-Task 5-in-1 Funnel™	Wire Ring	6 pcs.
10712WR	Super Multi-Purpose Funnel™	Wire Ring	12 pcs.
10716WR	Tight Spot Funnel™	Wire Ring	12 pcs.
10718WR	QuickFill® Funnel	Wire Ring	12 pcs.

10106WB



10718WR



## OFF SHELF / CLIP STRIPS

Increase sales with clip-strips during key promotional seasons

Part #	Description	Pcs.
10800X/6	Super Siphon™	6 pcs.
10111X/6	MixMizer® Injector	6 pcs.
10719	Capless Gas Tank Funnel™	12 pcs.
10732WR	Diesel Exhaust Fluid (DEF) Funnel™	10 pcs.



10800X/6

## FLOOR DISPLAYS

Multiple Configurations

Speak to your rep for more information



# CUT CASES

Organize your planogram and boost holding power

Part #	Description	Pcs.
05034MI	Extra Large Funnel	12 pcs.
10106B/6	Transmission Fluid/Gear Oil Spout	6 pcs.
10119B/24	Super Flexi-Spout™	24 pcs.
10701	Multi-Purpose Funnel™	12 pcs.
10701MX2	2-Piece Funnel Set	12 pcs.
10703	Radiator Funnel™	12 pcs.
10704	Measu-Funnel™	6 pcs.
10705	Giant QuickFill® Funnel	6 pcs.
10709	Locking Oil Funnel™	6 pcs.
10710WR	Multi-Task 5-in-1 Funnel™	6 pcs.
10711	Gas Gauge Funnel™	6 pcs.
10712PDQ	Super Multi-Purpose Funnel™	12 pcs.
10713	Big Mouth Funnel™	12 pcs.
10714MX3	Super Trio Funnel™	6 pcs.
10716PDQ	Tight Spot Funnel™	18 pcs.
10718	QuickFill® Funnel	10 pcs.
10719PDQ5	Capless Gas Tank Funnel™	5 pcs.
10732PDQ	Diesel Exhaust Fluid (DEF) Funnel™	10 pcs.
10202PDQ12	High Performance Absorbent™, 3 oz. Bag	12 pcs.
11935MI	Easy Lift Rider Ramps™	4 sets



10704



10701



10719PDQ5



10701MXPW

# SIDEKICKS

Add a sidekick during key promotional periods and increase sales by 40%

Part #	Description	Pcs.
10701MXPW	Multi-Purpose Funnel™	40 pcs.
10712MXPW	Super Multi-Purpose Funnel™	20 pcs.

# PROVIDING SAFER DRIVING SOLUTIONS



HELPING CUSTOMERS PREVENT ACCIDENTS

# SAFETY ACCESSORIES

## SAFETY TOP OF MIND

Creative innovation that has your safety top of mind. Accidents are just what they are, accidents, but we can help eliminate some of those with our products

## DRIVING AWARENESS SOLUTIONS™

Making drivers safer with easy-to-install innovative solutions to common driving hazards

## ALWAYS THERE

Smart and innovative products that are easy to use and there when you need it!





The Only High Definition  
Wireless Trailer Camera  
That Installs In Minutes!

# A SMART WAY TO SEE BEHIND YOUR TRAILER



## vueSMART™ Wireless Trailer Camera™

- Easy do-it-yourself installation uses existing trailer light for power and adapts to work on any trailer with universal bracket
- Wifi connection sends crystal clear video to smart device
- Hi-definition camera delivers 152° wide angle view behind trailer
- LED lights for night time backing
- Take a picture or record video
- Waterproof

50050 - 1 pc. Open Stock



# SMART HITCH™ CAMERA

Hitching up is a one person job!



50002  
SMART HITCH™  
Camera and Sensor System - 2 pcs. Open Stock

## TWO MODES ARE BETTER THAN ONE



### HITCH MODE

- Turns hitching into a one person job
- Helps align ball to trailer every time
- Provides a channel for perfect alignment
- Distance guides help determine how close objects are
- Audible alerts for proximity

### EVERYDAY MODE

- Works for everyday use when not towing
- Detects objects 5.5 feet away
- Sends audible alert for when you're not looking
- Utilizes ultra-sonic sensing

VEHICLE CAMERA

# GREAT PROMOTIONAL OPPORTUNITY



TRAILBLAZER ELECTRONIC



# DEER ALERT™

## Making Drivers Safer With Animal Alerts

**10X**  
SAFER  
than deer whistles

Deer accidents cause over \$1 Billion in damage every year. This premium Deer Alert is the perfect step-up

## 3 PROMO OPTIONS IN 1 SKU!

This product ships ready for display! Use the provided attractive tray or hang packages on the included clip strip



### Trailblazer Electronic Deer Alert™

- Powerful electronic signal
- More effective than traditional deer whistles
- 1,100 feet of reaction time warning
- Easy installation ... Hidden from view
- Won't clog ... Keeps working

27512VA – 8 pcs. Open Stock, Tray Pack, Clip Strip

**BELL**



### Deer Warnings Chrome

- Air flow activation
- Produces two separate, unique frequencies to help reduce vehicle-animal collisions
- Adhesive mount included

22-1-01001-8 - 3 pcs. Open Stock

**BELL**



### Deer Warnings Black

- Air flow activation
- Produces two separate, unique frequencies to help reduce vehicle-animal collisions
- Adhesive mount included

22-1-01000-8 - 3 pcs. Open Stock



# CUSTOMIZABLE KITS FOR ALL PROJECTS



MAKE IT ANY SIZE™



## **ANY SIZE, ANY SPACE, ANYWHERE!**

2x4 Basics® offers the most versatility and customization in garage organization as well as outdoor furniture kits. The flexibility of the product allows all customers the opportunity to get the most out of any space. 2x4 Basics® offers quick solutions that can be built ANY SIZE and fit ANY SPACE!

## **DIY SIMPLIFIED**

Only 90 degree cuts are required making 2x4 Basics® projects quick and easy even for novice DIY'ers. To simplify the process even more, only 2x4 lumber is needed for most projects

## **HIGH QUALITY**

Made of heavy gauge structural resin, all 2x4 Basics® brackets have a simple yet durable design allowing them to hold up to rough conditions. All 2x4 Basics® items come with 2-Year warranty

**2x4 basics**®

**DIY ORGANIZATION**



# GARAGE ORGANIZATION SOLUTIONS IN ANY SIZE



Made in USA



### L-Shaped Work Bench™

BLACK

- Heavy-duty L-shaped work bench fits in any corner workspace
  - Kit includes 5 work bench legs and hardware
- 90165ONLMI - 1 pc. Open Stock



### L-Shaped Work Bench Kit with Shelf Links®

BLACK

- Heavy-duty L-Shaped work bench and Shelf Links create the ultimate corner workspace
  - Kit includes five work bench legs, six 16" Shelf Links and hardware
- 90162ONLMI - 1 pc. Open Stock

\*Peg board not included



### Work Bench Kit

BLACK

- Build a heavy-duty work bench up to four feet wide and eight feet long
  - Middle shelf can be left out to store larger items
- 90158MI - 1 set Open Stock



### Work Bench Kit with Shelf Links®

BLACK

- Heavy-duty work bench and Shelf Links create the ultimate workspace
  - Kit includes four work bench legs, six 16" Shelf Links and hardware
- 90164MI - 1 set Catalog / Online

\*Peg board not included





### Shelf Links® - 6 pack

BLACK

- 16" deep shelves made of heavy gauge structural resin
- Can be modified or expanded as storage requirements change

90128MI - 6 pcs. Open Stock  
 90120MI - 30 pcs. Open Stock  
 90124MI - 1 pc. Catalog / Online



### Pro Brackets™ Sawhorse - 2 pack

BLACK

- Great for professionals or do-it-yourselfers
- Customize to fit your need - three, four or five feet

90194MI - 4 sets Open Stock  
 90196MI - 1 set Catalog / Online



\*2 kits shown



### Firewood Rack - 2 pack

BLACK

- Any size up to eight feet
- Use two kits and create a multi-layer or multi-section structure

90142MI - 12 pcs. Open Stock  
 90144MI - 1 set Catalog / Online



### Log Stacker™ - 2 pack

BLACK

- Any size up to eight feet
- Quick and easy assembly, no hardware needed
- Stacks up to one face cord of wood

PB40000 - 8 pcs. Open Stock



### StudTrack™

BLACK

- Organize long-handled tools, electric cords or sporting equipment
- Includes two end brackets and six universal hooks

90101MI - 4 sets Open Stock  
 901011MI - 1 set Catalog / Online



Made in USA

# DIY INSPIRATION

## Customized Outdoor Space



### Barn Roof Shed Kit

METAL

- No angled cuts — saves time and money!
- One kit builds a shed up to 10 feet, combine kits for a shed up to 22 feet
- Kit includes 55 metal brackets, hardware and plans

90190MI - 3 kits Open Stock  
901901MI - 1 kit Catalog / Online



### Peak Roof Shed Kit

METAL

- No angled cuts — saves time and money!
- One kit builds a shed up to 10 feet, combine kits for a shed up to 22 feet
- Kit includes 39 metal brackets, hardware and plans

90192MI - 4 kits Open Stock  
901921MI - 1 kit Catalog / Online



## CHAIRS/BENCHES



### Flip-Top Bench Table™

SAND

- Converts from bench to table using patented slide-lock feature
- Convert two benches to make table that seats eight

90110MI - 1 set Open Stock



### AnySize Chair®

SAND

- Build a two foot chair up to an eight foot bench
- Includes integrated beverage holders

90134MI - 1 set Open Stock



## TABLES



### Picnic Table Kit

- Makes a set of table and chairs up to eight feet
- Comes with Patio Table brackets and two AnySize™ Table sets

90182MI - 1 set Open Stock

SAND



### Patio Table

- Make a table of any length up to eight feet
- Made of durable and maintenance-free structural resin

90152MI - 1 set Open Stock

SAND



### AnySize Table™

- Determine the size to suit your needs
- Versatile application makes coffee table, foot rest, bench and more up to eight feet

90140MI - 1 set Open Stock

SAND



## DEKMATES™



### Dekmate® Bench Bracket

- Can be used with new and existing decks
- Space-saving packaging design

90166MI - 12 pcs. Open Stock

90168MI - 2 pc. set Catalog Online

SAND



### Dekmate® Bench Bracket

- Can be used with new and existing decks
- Space-saving packaging design

90170MI - 12 pcs. Open Stock

90172MI - 2 pc. set Catalog Online

BLACK



### Dekmate® Bench Bracket

- Can be used with new and existing decks
- Space-saving packaging design

90174MI - 12 pcs. Open Stock

90176MI - 2 pc. set Catalog Online

REDWOOD



# NORTH AMERICA'S

As the recognized automotive industry leader in

## TOWING ELECTRICAL AND LIGHTING PRODUCTS,

the Hopkins Towing Solutions® brand is synonymous with trust, while delivering superior value to both the consumer and you, our valued customers.

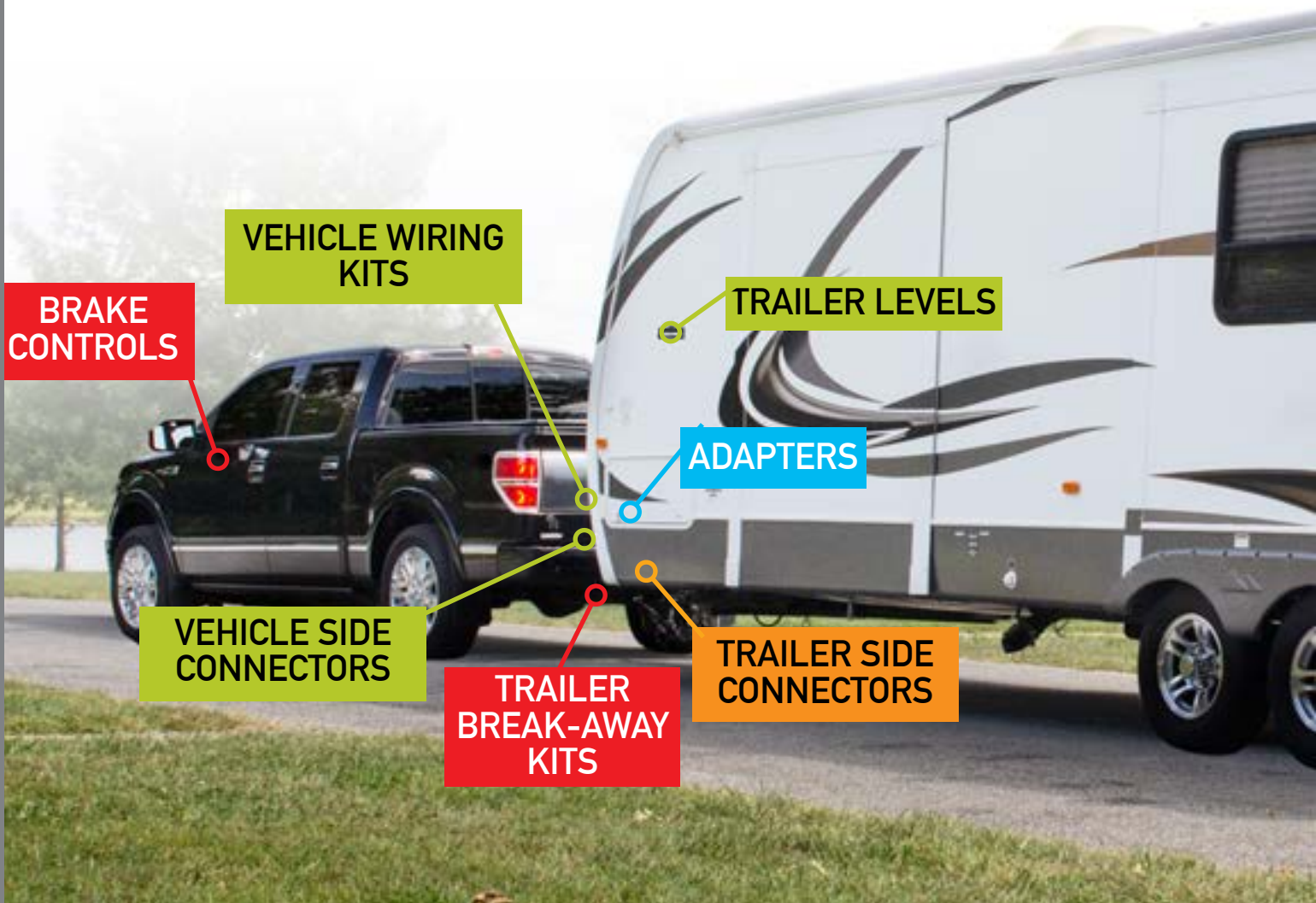

# #1 TOWING BRAND

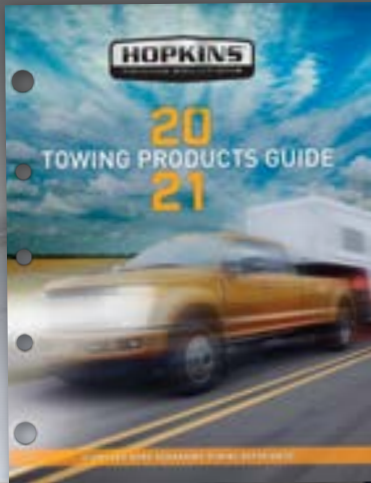

CAMERAS

MARKER/  
CLEARANCE  
LIGHTS

STOP/TAIL/  
TURN LIGHTS

REFLECTORS

LICENSE PLATE  
LIGHTS

TEST EQUIPMENT

RV TOW BRAKING



# INDEX

Part	Page	Part	Page	Part	Page	Part	Page
Numbers		22-1-00073-8	95	22-1-58255-9	84	22-1-97654-9	88
2-38	45	22-1-00337-8A	94	22-1-70007-9	81	22-1-97655-9	89
2-48	45	22-1-00371-8	96	22-1-70008-9	81	22-1-97656-9	89
2-108	45	22-1-01000-8	38, 94, 185	22-1-70009-9	81	22-1-97657-9	89
2-303M8	39	22-1-01001-8	94, 185	22-1-70011-9	81, 88	22-5-00088-8	64
2-338-7	45	22-1-05560-8	37, 95	22-1-70012-8	81	22-5-00101-8	65
2-668	45	22-1-05560-8P6	95	22-1-70013-8	81	22-5-00102-8	66
2-2548	45	22-1-05585-8	95	22-1-70231-9	77	22-5-00103-8	65
2-3548	45	22-1-05591-8	95	22-1-70239-9	78	22-5-00104-8	65
3-591-158	45	22-1-22235-8	97	22-1-70274-9	85	22-5-00108-8	65
3-685-58	45	22-1-22246-8	97	22-1-70296-9	85	22-5-00130-8	65
3-5018	43	22-1-24006-8	96	22-1-70329-8	79	22-5-00230-8	108
3-5028	43	22-1-29015-8	97	22-1-70330-8	79	22-5-00231-8	107, 108
3-5068	43	22-1-30230-8	96	22-1-70331-9	77	22-5-00234-8	107
3-5078	43	22-1-33225-8	94	22-1-70332-9	77	22-5-00370-VCT12	96
3-5088	43	22-1-33653-8	92, 93	22-1-70336-3	84	22-5-00370-VP6	96
3-5108	44	22-1-33671-8	94	22-1-70336-8	84	22-5-00401-8	66
3-5118	42	22-1-33943-8	94	22-1-70337-3	84	22-5-00402-8	66
3-5128	44	22-1-36707-8	39, 95	22-1-70337-8	84	22-5-00406-8A	66
3-5158	43	22-1-37014-8	96	22-1-70340-8	79	22-5-00411-8	66
3-5238	45	22-1-37015-8	96	22-1-70359-9	77	22-5-00419-8A	65
3-5278	45	22-1-39002-8	98	22-1-70381-9	77	22-5-00420-8	66
3-5288	45	22-1-39010-8	98	22-1-70382-9	77	22-5-00500-SZ	155
3-5288-7	45	22-1-39011-8	98	22-1-70383-9	77	22-5-00500-SZCS12	155
3-5308	45	22-1-39023-8	98	22-1-70387-9	79	22-5-00500-SZFB24	155
3-5368	45	22-1-39046-8	98	22-1-70395-9	77	22-5-00502-SZ	155
3-5368-5	45	22-1-39047-8	98	22-1-70411-8	79	22-5-00710-8	73
3-5378	45	22-1-39048-8	98	22-1-70412-8	79	22-5-00711-V	73
3-5418	42	22-1-39052-8	98	22-1-70416-9	85	22-5-00713-8	72
3-5428	45	22-1-39264-8	96	22-1-70417-9	85	22-5-00714-8	73
3-5588	45	22-1-39268-8	96	22-1-70418-9	77	22-5-00715-8	71
3-6068	42	22-1-39287-8	98	22-1-70445-9	76	22-5-00716-8	71
3-6828	45	22-1-44810-8	41	22-1-70448-9	77	22-5-00726-8	71
3-6848	45	22-1-46009-8	90	22-1-70450-9	77	22-5-00876-8	69
3-6848-7	45	22-1-46104-8	91	22-1-96126-9	88	22-5-00879-V	68
3-7438	45	22-1-46117-8	90	22-1-97023-9	89	22-5-00887-8	70
4-10NY-E	52, 53	22-1-46114-8	90	22-1-97029-9	89	22-5-00889-8	69
4B3208	38	22-1-46163-8	91	22-1-97032-9	89	22-5-00890-8	69
4B3278	38	22-1-46215-8	91	22-1-97037-9	88	22-5-00894-8	69
8NY-16A	53	22-1-46497-8	90	22-1-97038-9	87	22-5-00895-8	69
8NY-24A	53	22-1-46501-8	91	22-1-97039-9	87	22-5-00896-8	69
8NYE-48	52	22-1-46511-8	90	22-1-97049-9	87	22-5-00897-8	69
9-21M8	40	22-1-46565-8	90, 91	22-1-97114-9	87	22-5-00900-8	69
9-21M8-7	40	22-1-46573-8	90	22-1-97152-9	87	22-5-08700-8	64
9-27MC8	45	22-1-46601-8	91	22-1-97311-9	88	22-5-08770-8	69
9-28MC8	44	22-1-46714-8	90	22-1-97313-9	89	22-5-08826-8	66
9-38	41	22-1-46724-8	91	22-1-97315-9	88	22-5-16005-8	59
9-38-7	41	22-1-46725-8	85, 91	22-1-97443-9	79, 87	22-5-16010-8	61
9-198	44	22-1-46728-8	78	22-1-97478-8	85	22-5-16020-8	61
9-278	44	22-1-55302-A	84	22-1-97478-9	85, 87	22-5-16030-8	61
9-288	44	22-1-55303-A	84	22-1-97487-9	87	22-5-16040-8	61
9-368	40	22-1-55508-9	83	22-1-97492-9	79	22-5-16045-8	61
10NY-24A	53	22-1-56258-9	83	22-1-97505-9	79, 87	22-5-16055-8	60
12-8NY-48	53	22-1-56259-8	83	22-1-97596-9	87	22-5-16070-8	61
12-808NYU	54	22-1-58048-9	83	22-1-97616-9	88	22-5-16110-8	62
12-810NYU	54	22-1-58051-9	83	22-1-97651-9	89	22-5-16120-8	62
22-1-00051-8	95	22-1-58228-9	83	22-1-97652-9	88	22-5-16130-8	62
		22-1-58254-9	84	22-1-97653-9	88	22-5-16140-8	62

# INDEX

Part	Page	Part	Page	Part	Page	Part	Page
22-5-57109-8	59	22-5-70851-8	71	843-30	176	6403	109
22-5-57120-8	59	22-5-70874-8	68	843-30-116	176	6404	109
22-5-60012-8	68	22-5-70881-8	68	843-36	176	6416	109
22-5-60084-8	70	22-5-70902-8	70	844-24	176	6417	109
22-5-60087-8	70	22-5-70911-8	64	844-30	176	6418	109
22-5-60090-8	70	22-5-70925-8	63	844-30-116	176	7450FP	64
22-5-60096-8	70	22-5-70926-8	63	844-36	176	7500MA	64
22-5-60104-8	68	22-5-70927-8	63	845-24	176	7550GP	64
22-5-60105-8	69	22-5-71106-8	69	845-24-46	176	9000R	54
22-5-60116-8M	70	22-5-84042-8	70	846-30	176	9003R	54
22-5-60181-8	68	22-5-84043-8	70	846-30-54	176	9005R	54
22-5-60190-8	70	22-5-86724-VCD24	70	885	52	9007R	54
22-5-60195-8	70	24-808NY-30A	53	989-34	149	9008BLK	54
22-5-70003-8	68	50-203	151	994PKUS	156	9010R	53
22-5-70005-8	64, 65	110U	54	996-35	150	9014R	53
22-5-70008-8	64	111U	54	999CT	149	9020A	52
22-5-70023-8	69	112U	54	999-EPPV	149	9025CDF	52, 55
22-5-70083-8	64	116	177	1124F	152	9031R	53
22-5-70105-8	68	118-54	54	2000LV	165	9032R	53
22-5-70106-8	65	130-46	177	2005LV	165	9033R	54
22-5-70108-8	68	148	54	2248FD	151, 157	9037R	53
22-5-70110-8	65	154	177	2610FD	149, 157	9038	52
22-5-70111-8	66	160	54	2610XB	149	9039R	53
22-5-70112-8	68	203	151	2610XM	148	9045RA	52
22-5-70126-8	65	3720DM	141	2672XM	148	9046	53
22-5-70128-8	65	376BDM	141	3101	107	9047R	53
22-5-70132-8	64	376RDM	141	3102	107	9049	52
22-5-70141-8	73	376RSZ	155	3104	107	9050	54
22-5-70173-8	71	376RSZ-8	155	3304	111	9051	54
22-5-70174-8	73	376RSZ-24	155	3305	111	9053	53
22-5-70184-8	66	3810DM	141	3512PBT	146	9057	53
22-5-70200-8	72	3810SZ	155	3518FD	150, 157	9058	53
22-5-70204-8	67	3810SZ-4	155	3648	157	9217BIK	54
22-5-70207-8	67	3810SZ-24	155	4320	111	9221BIK	54
22-5-70260-8	71	3810SZ-72	155	4322	110	9260	54
22-5-70265-8	71	381YDM	141	4326	110	9262B	53
22-5-70266-8	71	511-E	149	4406	110	9263	53
22-5-70267-8	71	523	151	4649	110	9266	53
22-5-70341-8	71	532	150	4754	110	9267A	53
22-5-70405-8	66	580-EP	149	4766	110	9271X	50
22-5-70407-8	66	581-E	148	05007MI	170	9272X	50
22-5-70410-8	72	582-EPSZ9	148	05015MI	170	9274X	50
22-5-70413-8	72	583-EP	148	05034MI	170, 179	9275X	50, 55
22-5-70414-8	66	806NY	52	05060MI	170	9425CDX	50, 55
22-5-70415-8	72	840-24	176	5060TS	165	9438X	50, 55
22-5-70418-8	72	840-24-116	176	05062MI	168	9440X	51, 55
22-5-70525-8	64	840-30	176	05064MI	170	9500	52
22-5-70599-8	68	840-36	176	05068MI	170	9501	54
22-5-70600-8	68	840R-24	177	05080MI	167	9507	54
22-5-70707-8	72	840R-36	177	5100H	64	9508	54
22-5-70709-8	72	841-24	176	5441B	132	9514	54
22-5-70712-8	73	841-24-116	176	5442B	132	10101B/12	170
22-5-70718-8	72	841-30	176	5526	111	10101WB	170, 178
22-5-70721-8	72	841-36	176	5641B	132	10106B/6	170, 179
22-5-70722-8	71	841R-24	177	5642B	132	10106WB	170, 178
22-5-70731-8	72	841R-36	177	6018	38	10107B/12	170
22-5-70746-8	72	843-24	176	06064MI	169	10107WB	170, 178
22-5-70747-8	71	843-24-116	176	6400KT	109	10111/6	170

# INDEX

Part	Page	Part	Page	Part	Page	Part	Page
10111X/6	170, 178	11838MI	167	17505	153	40401AS	25
10119B/24	170, 179	11845MI	167	17511	153	40402AS	25
10200	175	11849MI	167	17529	153	40403AS	25
10201	175	11909MI	161	17540	153	40404AS	25
10202	175	11912MI	161	17541	153, 157	40405AS	25
10202PDQ12	175, 179	11930MI	161	18520	150	40406AS	25
10601B/12	163	11935MI	161, 179	18833	146	40407AS	25
10609B/12	163	12201	154	18837	146, 157	40408AS	25
10614	163	12324	155	18841	146	40409AS	25
10614B/6	163	12501	154	18845	146	40410AS	25
10615	163	12505	154	18847	146, 157	40411AS	25
10615B/6	163	12550	154	18849	146	42001MI	166
10617GT	162	13014	152	19520	151	42003MI	166
10619	163	13024	150	23110Q	150	42004MI	166
10620GT	162	13025	150	26120	149	42008MI	166
10621GT	162	13030	147, 150	27512VA	185	42010MI	167
10622GT	162	13044	152	40046	45	440010C	22
10627GT	163, 166	13050	147	40046D	45, 55	440020C	22
10631GT	162	13054	149	40047	45	440030C	22
10632GT	163	13059	149	40048	45	440040C	23
10633GT	162	13060	147	40050	45	440050C	23
10634GT	162	13781	150	40050D	45, 55	45054	45
10701	170, 179	13920	152	40051	45	45062	44
10701MX2	170, 179	13920CS	152	40052	45	45063	44
10701MXPW	170, 179	13929	152	40059AS	31	45066	42
10701WR	170, 178	14012	152	40061	42	45067	42
10703	169, 179	14014	150	40061D	42, 55	45069	43
10703WR	169, 178	14015	148	40062	42	45070	42
10704	169, 179	14035	145	40062D	42, 55	45078X	51, 55
10705	168, 179	14038	145	40065	45	45114	40
10709	169, 179	14039	145	40065D	45, 55	45116X	51, 55
10709WR	169, 178	14052	146	40067	45	45122X	51, 55
10710WR	170, 178, 179	14120	151	40069	45	45128AS	31
10711	169, 179	14120Y	151	40071	45	45133	30
10712MXPW	170, 179	14125	144, 151	40072	45	45135	30
10712PDQ	170, 179	14135	144, 149	40102	41	45137X	51
10712WR	170, 178	14151	144	40106	41	45211	43
10713	170, 179	14161	144	40110	40	45218	49
10714MX3	169, 179	14170	145	40112	40	45222X	51
10716PDQ	169, 179	14180	145	40118	44	45223X	51
10716WR	169, 178	14185	144, 145	40119	44	45225X	51
10718	168, 179	14403	146	40120	44	45320	39
10718WR	168, 178	14454	147	40122	44	45401AS	25
10719	169, 178	15511	151	40123	44	45544X	51, 55
10719PDQ5	169, 179	15613	150	40208	43	45602AS	30
10720	169	15781	148	40209	43	45604AS	30
10721	169	16024	151	40210	43	45606AS	31
10732PDQ	169, 179	16211	152	40211	43	45619X	51
10732WR	169, 178	16250	152, 154	40302	40	45625AS	31, 55
10800/6	171	16511	151	40304	40	45646AS	31
10800X/6	171, 178	16620	150	40305A	30	45651AS	25
10801	171	16621	152	40306	40	45652AS	25
10802	171	16721	152	40307	39	45704	48
10803	171	17211	154	40309	39	50002	184
10804	171	17222	154	40310	39	50050	182
10804/4	171	17222HT	154	40313	41	50863MI	171
10810	171	17228	154, 157	40314	41	571000C	23
11430MI	167	17297	154, 157	40400AS	25	571640C	23





# INDEX

Part	Page	Part	Page	Part	Page	Part	Page
C3073KFM.....	122	CWL620.....	126	F15-580-EP.....	149, 157	SP120623U.....	100
C3075K.....	123	CWL622.....	124	F15C.....	173	SP120623UFD.....	100
C4500AW.....	130	CWL623.....	124	F16-511-E.....	149, 157	SP120624U.....	100
C4842.....	131	CWL624.....	126	F20-532.....	150, 157	SP120624UFD.....	100
C4843.....	132	CWL625.....	126	F20-996-35.....	150, 157	SP130801U.....	100
C4850AW.....	130	CWL626.....	126	F24-523.....	151, 157	SP130901JFD.....	101
C4855AW.....	129	CWL627.....	126	<b>M</b>		SP130901SJD.....	101
C4855CAC.....	130	CWL630.....	127	MINIORG.....	93	SP240401JFD.....	101
C4855CAW.....	129	CWL631.....	127	MM510.....	135	SP240401SFD.....	101
C4856CAC.....	129	CWL636.....	127	MO13910PB.....	155	SP240401U.....	100
C4857CAC.....	129	CWL637.....	127	MO14011CB.....	155	SP240603JFD.....	101
C6350.....	132	CWL638.....	127	MO14020PB.....	155	SP240603SFD.....	101
C6350A.....	132	CWL639.....	127	MO14021CB.....	155	SP240612UFD.....	101
C6355.....	132	CWL692.....	127	MO14082CB.....	155	SP240618U.....	100
C8005W.....	138	CWL1116.....	121	MO14091CBFD.....	155	SP2605042.....	100
C8006W.....	138	CWL3071K.....	123	MO14092PBFD.....	155	SP2605042CS.....	100, 101
C8007W.....	138	CWL5042.....	136	MO14093FD.....	155	SP2605042SK.....	100
C8010.....	138	CWL5043.....	136			SPINNER-4W.....	157
C8011.....	138	CWL51222.....	125	<b>N</b>			
CNSLPLUS-BLA.....	93	CWL52210.....	116, 128	N005W.....	135	<b>T</b>	
CW8002K.....	135	CWL52450.....	125			TRASH10-BLA.....	94
CWL0006.....	121	<b>D</b>				TRASH13-BLA-CS.....	101
CWL0020.....	121	D8-577-EPKUS.....	156	<b>O</b>		TRASH13-BLA-PDQ.....	101
CWL0022.....	123	D8-577-EPKUS.....	157	OP-1.....	167	TRASH-BLA.....	94, 101
CWL113.....	118	D24-886PKUS.....	156, 157	OP-112.....	167	TRASH-BLA-PDQ.....	101
CWL118.....	118	DF1073KB.....	135	<b>Q</b>		TS10T6.....	47
CWL503.....	137	DF1075KB.....	135	QP48-14180.....	145, 157	TS20T6.....	47
CWL503TWP.....	137	DP-10.....	167	QP72-999CT.....	149, 157	TS40T6.....	47
CWL504TW.....	137	DS58-2BPKUS.....	157	QP72-1850.....	157	TS60T6.....	47
CWL505.....	138	DS58-3BHPKUS.....	156, 157			TS70T6.....	47
CWL507.....	138	DS72-532L.....	157	<b>S</b>		TS75T6.....	47
CWL507TW.....	137	DWR5D.....	157	S12-577-EPKUS.....	156	TS80T6.....	47
CWL508.....	138	DWR60A.....	157	S12-580-EP.....	149	TS90T6.....	47
CWL509.....	137	DWR112.....	157	S12-581-E.....	148	TS95T4.....	47
CWL510.....	137	DWR120.....	157	S16-511-E.....	149	<b>V</b>	
CWL511.....	122	DWR137.....	157	S16-999CT.....	149	VENT-05.....	93, 101
CWL512.....	122	DWRBRUSH2.....	157	S18-518.....	151	VENT-10.....	93, 101
CWL513.....	121	<b>E</b>		S24-523.....	151	VSR.....	40, 94
CWL514.....	118	E3.....	173	S24-527PKUS.....	156	<b>W</b>	
CWL515.....	121	EDWR-6.....	157	S24-532.....	150	WS1524.....	54
CWL518.....	121	EFF-BLA.....	93	S24-582-EPSZ9.....	148	WS1524A.....	53
CWL520.....	118	EFF-CHA.....	93	S24-994.....	152	WS1524U.....	53
CWL521.....	116	EFF-CHA-PDQ.....	101	S24-996-35.....	150	WS2024.....	54
CWL522.....	117, 128	EMIC-BLA.....	93	S30-886PKUS.....	156	WS2024A.....	53
CWL523.....	117, 139	EMIC-CHA.....	93	SC-BLA.....	93	WS2024U.....	53
CWL524D.....	119	<b>F</b>		SC-CHA.....	93	WS4212.....	54
CWL524S.....	119	F1C.....	173	SEJ.....	37, 95	WS4224U.....	53
CWL525.....	117, 139	F1NC.....	173	SMT.....	95	WSE-39A.....	53
CWL526.....	116, 139	F3C.....	173	SP120605U.....	100	WSH24.....	54
CWL527.....	117, 139	F3NC.....	173	SP120608U.....	100	<b>Z</b>	
CWL528.....	116, 139	F8C.....	173	SP120610U.....	100	ZE3.....	173
CWL529.....	117, 139	F12-581-E.....	148, 157	SP120610UFD.....	100		
CWL536D.....	119	F14-583-EP.....	148, 157	SP120612UFD.....	101		
CWL536S.....	119	F14-999CT.....	149, 157	SP120616UFD.....	101		
CWL552D.....	119			SP120621U.....	99		
CWL552S.....	119			SP120621UFD.....	99		
CWL610.....	126						
CWL615.....	126						

