

# 2017 F1 WORLD CHAMPIONS

**OMP**

SINCE 1978

2018  
COLLECTION

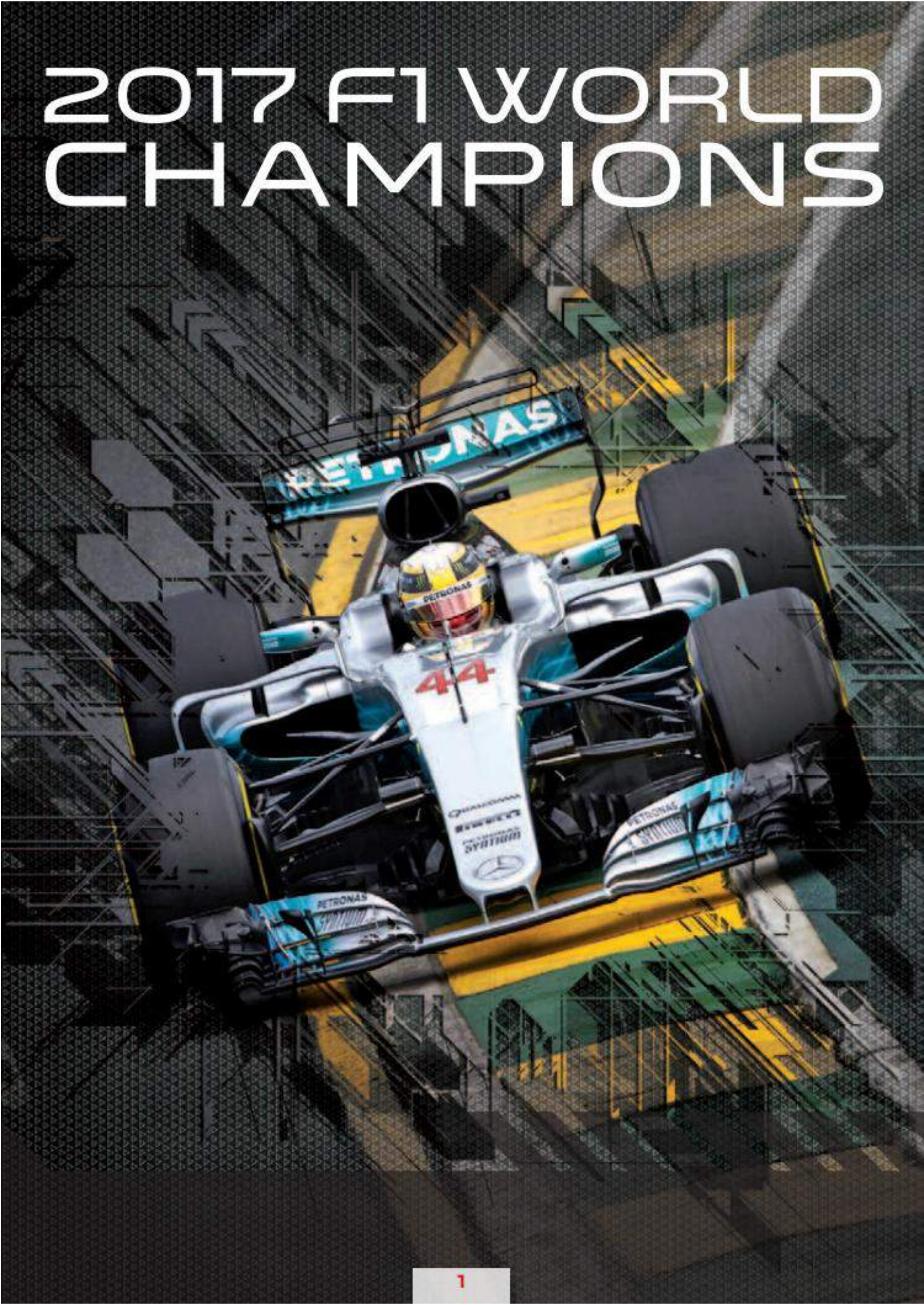

# 2017 WEC CHAMPIONS



**Ferrari-AF Corse FIA WEC GT Manufacturers Champions**

**James Calado and Alessandro Pier Guidi FIA WEC GT Drivers Champions**

# 2017 WRC CHAMPIONS



**Johan Kristoffersson FIA World Rallycross drivers' champion 2017**

**PSRX Volkswagen Team Sweden FIA World Rallycross teams' champion 2017**

# OMP Art WORLD

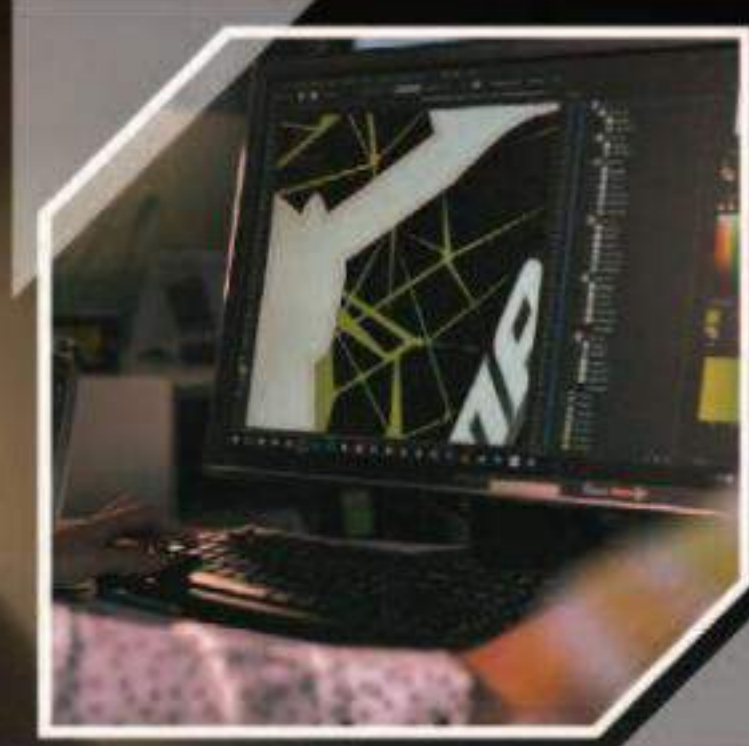



## SUITS

PAG 8



## UNDERWEAR

PAG 44



## GLOVES

PAG 52



## SHOES

PAG 66



## HELMETS

PAG 82

# DRIVER EQUIPMENT



# SUITS

# SUITS



 **RACING**  
PAG 10

 **VINTAGE**  
PAG 32

 **MECHANICS**  
PAG 36

 **KARTING**  
PAG 272

ONE

Art

# SUIT

# FOCUS ON



## TOTALLY PRINTED FIA TOP LEVEL SUIT

Regular fit with ultraflat antirubbing seams, soft knitted fabric inside.

*Unlimited customization way thanks to the totally printed design.*



IA01857

SIZES: 46-64  
sizing information  
on page 317



### FLOATING SLEEVES

Semi floating arm bellows.

### KNITTED MATERIAL

### STRETCH DRY SYSTEM

High breathability parts in Dry System 3D material on back, hips and under the sleeves.

IA01857178XX

Black/green/yellow

### INNER POCKET

One comfortable hidden inner pocket



MANUFACTURER: OMP  
MODEL: R-IA8-001  
HOM. NO.: RS.297.16  
FIA STANDARD: FIA 8856-2000



## STRETCH DRY SYSTEM

More comfort, less heat: a goal that OMP pursues since always, and now concretizes with STRETCH DRY SYSTEM. The maximum breathability of OMP Dry System is combined with the elasticity of 3D materials, to allow the best freedom in movements while reducing body temperature. Two fundamental elements to help drivers improve their performance.

The cooling effect of the inserts is improved when worn with the OMP ONE breathable underwear that now offers a cooling spray solution. OMP's Dry System is a registered utility model.



# Art SUITS

This model of suit can be customized through the use of images, photos and color blendings. This peculiar feature is possible thanks to our proprietary technology "OMP Print Art". In order to outline what spaces are at the customer's disposal for personalization, we show you the exploded view of those areas.



# FOCUS ON

INSPIRED BY OMP TOP DRIVERS



**NIGEL MANSELL**  
1989  
EASIER AND LIGHTER ARM  
BELLOW CONCEPT



**AYRTON SENNA**  
1991  
100% FLAT STITCHING



**M. SHUMACHER**  
2006  
FRONTAL STITCHING  
CALF ELASTIC INSERT



**M. SHUMACHER**  
2006  
KNEE PADS  
SMALL POCKETS



**KIMI RÄIKÖNEN**  
2012  
LOWERED COLLAR  
NO BELT



**TOMMI MÄKINEN**  
1996  
INNER COLLAR IN SOFT KNITTED FA-  
BRIC



**P. SOLBERG**  
2014  
INTEGRATED DRY SYSTEM



**S. OGIER**  
2015  
ULTRALIGHT FABRICS SMALLER AND  
LIGHTER ARM BELLOW CONSTRUCTION



**IA01852244XX**  
Dark blue/cyan/white



**IA01852076XX**  
Black/silver



**IA01852073XX**  
Black/anthracite/red



**IA01852083XX**  
Silver/black/anthracite



### TOP LEVEL SUIT

Fireproof top level overall. Developed for the highest lightness without sacrificing the comfort. Made of shiny Nomex® fabrics. Regular fit with antirubbing seams.



IA01853244XX  
Blu navy / cyan



### FLOATING SLEEVES

Semi floating arm bellows.

### DRY SYSTEM

High breathability parts in Dry System 3D material.

### INNER POCKET

One comfortable hidden inner pocket.

### KNITTED MATERIAL

IA01853

SIZES: 46-64  
sizing information  
on page 317



### DRY SYSTEM

To help drivers reduce body temperature and improve their performance, OMP has designed a range of underwear and breathable clothing to facilitate the body thermoregulation. The cooling effect of the inserts is improved when worn with the OMP ONE breathable underwear that now offers a cooling spray solution. OMP's Dry System is a registered utility model.

### STRETCH DRY SYSTEM

More comfort, less heat: a goal that OMP pursues since always, and now concretizes with STRETCH DRY SYSTEM. The maximum breathability of OMP Dry System is combined with the elasticity of 3D materials, to allow the best freedom in movements while reducing body temperature. Two fundamental elements to help drivers improve their performance.



IA01853071XX  
Black/white



IA01853083XX  
Silver/anthracite/black



MANUFACTURER: OMP  
MODEL: ONE S  
HOM. NO: R.S.224.12  
FIA STANDARD: FIA 8856-2000

# ONE-SL

# SUIT

IA01855  
CUSTOM MADE

## SUPERLIGHT SUIT

Super light fireproof overall. Made of shiny Nomex® fabrics. Developed for the highest lightness ever! Slim fit with ultralight antirubbing seams.



## FLOATING SLEEVES

Semi floating arm bellows.

## INNER POCKETS

One or two comfortable hidden inner pockets.

OMP SYSTEM  
FRESH AIR IN HOT AIR OUT  
OMP REVOLUTIONARY COOLING SYSTEM

## DETAILS

WEIGHT: 700 gr  
(For OMP 50 Size  
Man h 175 weight 75)



MANUFACTURER: OMP  
MODEL: ONE S  
HOM. NO: RS.224.12  
FIA STANDARD: FIA 8856-2000



KNITTED MATERIAL



STRETCH DRY SYSTEM



WHIRLUP AUSTRALIA



TEAM GRASSER BLANCPAIN

# ONE evo

# SUIT

# FOCUS ON

## ULTRALIGHT PROFESSIONAL SUIT

Made of shiny, High-Tech Nomex® fabrics and innovative new inner materials, allowing a significant weight reduction. Large and improved breathable areas. Slim fit.



**SHAPED COLLAR**  
with inner soft knitted material

**FLOATING ARMS**  
with elastic bellows

**PRE-CURVED SLEEVES**  
for maximum comfort



IA01851

SIZES: 46-64  
sizing information  
on page 317



## DRY SYSTEM

To help drivers reduce body temperature and improve their performance, OMP has designed a range of underwear and breathable clothing. The OMP ONE S line and TECNICA EVO breathable racing suits and underwear to facilitate the body thermo-regulation, thanks to the innovative weave of the inserts, strategically positioned, that allow for high breathability while still maintaining their own fire-retardant properties (according to the FIA standard 8856-2000).

The cooling effect of the inserts is improved when worn with the OMP ONE breathable underwear that now offers a cooling spray solution. OMP's Dry System is a registered utility model.

IA01851076XX

Black/white/red

**DRY SYSTEM**  
3D breathable material

**ULTRA-FLAT**  
anti rubbing seams

**INSIDE POCKETS**



**FIA APPROVED**

MANUFACTURER: OMP  
MODEL: ONE EVO  
HOM. NO: RS.224.12  
FIA STANDARD: FIA 8856-2000



IA01851244XX  
Navy blue/white/cyan



IA01851270XX  
Black/white/fluo green



IA01851178XX  
Black/white/fluo yellow



IA01851089XX  
Grey/black/white

# TECNICA evo SUIT



## DEVELOPED DIRECTLY FROM OMP'S TOP DRIVERS EXPERIENCE

Professional fire resistant suit featured by high-level fabrics. Floating arms with elastic bellows to increase freedom of movement, breathable fabric inserts to give the best comfort. Exclusive retractable belt. Inner fabric made in soft knitted fabric and practical front pocket on right side.

IA01859

SIZES: 44-64  
sizing information  
on page 317  
SFI 3.2A/5 on request



FLOATING ARMS  
with elastic bellows

**NEW!**

ULTRA-FLAT  
anti rubbing seams



EXCLUSIVE  
retractable belt

DRY SYSTEM  
3D breathable material

IA01859178XX  
Black/anthracite/fluo yellow



MANUFACTURER: OMP  
MODEL: R-IA8-003  
HOM. NO: RS.324.17  
FIA STANDARD: FIA 8856-2000



## DRY SYSTEM

To help drivers reduce body temperature and improve their performance, OMP has designed a range of underwear and breathable clothing. The OMP ONE S line and TECNICA EVO breathable racing suits and underwear to facilitate the body thermoregulation, thanks to the innovative weave of the inserts, strategically positioned, that allow for high breathability while still maintaining their own fire-retardant properties (according to the FIA standard 8856-2000).

The cooling effect of the inserts is improved when worn with the OMP ONE breathable underwear that now offers a cooling spray solution. OMP's Dry System is a registered utility model.



ADVANCED  
FASTENING  
SYSTEM  
Exclusive  
retractable belt



IA01859073XX  
Black/red

IA01859076XX  
Black/white

IA01859244XX  
Navy blue/white/cyan

IA01859373XX  
White/anthracite

# TECNICA-S

# SUIT

# FOCUS ON

## PROFESSIONAL SUIT

Made of shiny Nomex® fabrics.  
Modern and aggressive design.



**SHAPED COLLAR**  
with inner soft knitted material

**FLOATING ARMS**  
with elastic bellows

**IA01850063XX**  
Red/white/black

**ULTRA-FLAT**  
anti rubbing seams

**INSIDE POCKETS**

**IA01850**

SIZES: 44-64  
sizing information  
on page 317  
SFI 3.2A/5 on request



**KNITTED ELASTIC INSERT**  
on the back for maximum  
freedom of movement



MANUFACTURER: OMP  
MODEL: TECNICA-S  
HOM. NO: RS.132.07  
FIA STANDARD: FIA 8856-2000



**IA01850043XX**  
Blue/white/black



**IA01850089XX**  
Grey/white/black



**IA01850076XX**  
Black/white/silver

# FIRST evo SUIT

# FOCUS ON

## 2 LAYER SUIT

2 layer overall with modern two coloured design featuring an excellent quality/ comfort/price ratio.



IA01854

SIZES: 42-64  
sizing information  
on page 317  
SFI 3.2A/5 on request



### FLOATING SLEEVES

Floating arm bellows.

### BREATHABLE SYSTEM

breathable inserts  
on the sleeves.

### EXTERNAL POCKETS

### INSIDE POCKETS

### KNITTED MATERIAL

Elastic inserts  
on the back and  
on the groin  
for better comfort  
and flexibility.

**FIA APPROVED**

MANUFACTURER: OMP  
MODEL: FIRST S  
HOM. NO: RS.243.13  
FIA STANDARD: FIA 8856-2000



### BREATHABLE SYSTEM

Breathable inserts  
on the sleeves.

KNITTED ELASTIC INSERT  
on the back for maximum  
freedom of movement



IA01854046XX  
Blue navy/silver



IA01854063XX  
Red/white



IA01854076XX  
Black/white



IA01854089XX  
Silver/black

# FIRST-5

# SUIT

# FOCUS ON

### PROFESSIONAL RESISTANT AND COMFORTABLE SUIT

Entry level FIA homologated racing suit made with new lightweight fabrics and with an excellent price/quality/resistance/comfort ratio. Inner layer in soft knitted fire retardant fabric, modern design with "fishbone" quilting.



IA01828B

SIZES: 44-64  
sizing information  
on page 317  
SFI 3.2A/5 on request



FLOATING SLEEVES

Floating arm bellows.



ULTRAFLAT

antrubbing seams

LARGE POCKET



IA01828B083XX

Silver/black



MANUFACTURER: OMP  
MODEL: OS20  
HOM. NO: RS.247.13  
FIA STANDARD: FIA 8856-2000

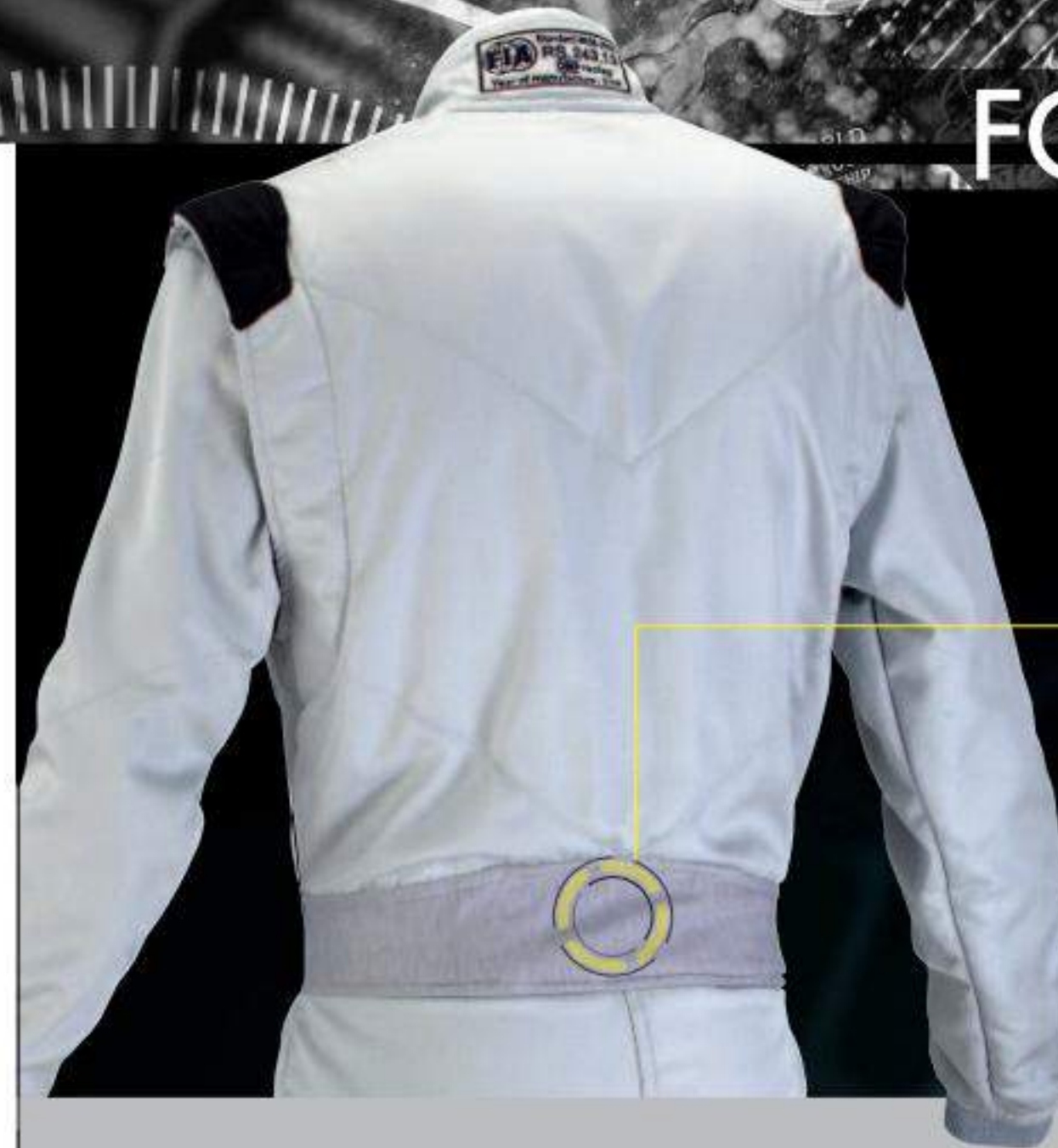

KNITTED ELASTIC INSERT  
on the back for maximum  
freedom of movement



IA01828B244XX  
Navy blue/cyan



IA01828B061XX  
Red/black



IA01828B184XX  
Anthracite/fluo yellow



IA01828B071XX  
Black/white

## ENTRY LEVEL RACING SUIT

OMP entry level suit with an excellent quality/ price ratio. Outer pockets.



MANUFACTURER: OMP  
MODEL: OS 20  
HOM. NO: RS.247.13  
FIA STANDARD: FIA 8856-2000



**FLOATING ARMS**  
with elastic bellows

**IA01847F041XX**

Blue



**LARGE POCKET**



**IA01847F061XX**

Red



**IA01847F071XX**

Black

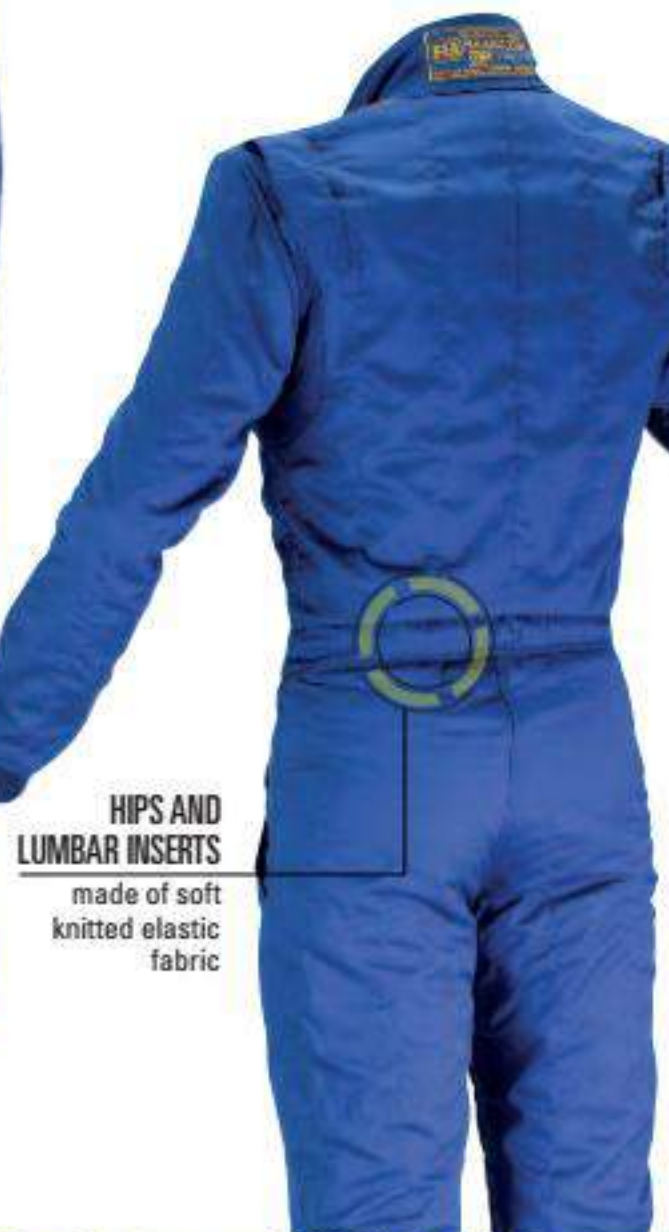

**HIPS AND LUMBAR INSERTS**  
made of soft knitted elastic fabric

**IA01847F**

SIZES: S/XXL  
sizing information  
on page 317

SFI 3.2A/5 on request

Corresponding  
suit sizes:

USA	EU
S	46/48
M	50/52
L	54/56
XL	58/60
XXL	62/64

## OS 10 SUIT

One layer OMP Sport racing suit in fire retardant cotton fabric.



**EXTRACTION HANDLES**

**ELASTIC STRETCH**

Lumbar elastic stretch.

**IA01904071XX**

Black

**EXTERNAL POCKETS**

**IA01904**

HOMOLOGATION  
SFI 3.2A/S1

SIZES: S/XXL  
sizing information  
on page 317

SFI 3.2A/5 on request

Corresponding  
suit sizes:

USA	EU
S	46/48
M	50/52
L	54/56
XL	58/60
XXL	62/64



# ONE VINTAGE SUIT

# LE MANS SUIT

## RETRO RACING SUIT STYLE

Typical style worn by the great champions of F1 in the mid 70s. Produced with the same ultra-light fabrics of the new ONE EVO and ONE-S suits.



MANUFACTURER: OMP  
MODEL: ONE BASIS  
HOM. NO: RS.224.12  
FIA STANDARD: FIA 8856-2000

### FLOATING ARMS

with elastic bellows



SHAPED COLLAR

PRE-CURVED SLEEVES

SLIM FIT

and ultra-flat,  
anti-rubbing seams.

OUTER POCKET

ELASTIC

IA01842071XX

Black with white stripes

IA01842020XX

White with red stripes

IA01842

SIZES: 46-64  
sizing information  
on page 317  
SFI 3.2A/5 on request

## CARE AND REFINEMENT TYPICAL OF THE 1960s

External layer made of satin Nomex®.  
Lining in a comfortable knit fabric.



MANUFACTURER: OMP  
MODEL: LE MANS  
HOM. NO: RS.163.08  
FIA STANDARD: FIA 8856-2000



### DETAILS OF THE BIAS CUT CLOSURE

and belt loops  
typical of the suits  
worn by the big names  
of F1 at the time.

OUTER POCKET

DOUBLE STITCHING

ELASTIC

### STITCHING AND DETAILS

in brown on cream satin  
fabric for real vintage style revival.

IA01823F

SIZES: 46-64  
sizing information  
on page 317  
SFI 3.2A/5 on request

MANUFACTURED  
UPON REQUEST

IA01823F022XX

Cream

# CLASSIC SUIT

## OVERALL IN TYPICAL '70s DESIGN

Outer layer in aramid fiber.  
Inner layer in comfortable  
breathable knitted fabric.



MANUFACTURER: OMP  
MODEL: FIRST 2  
HOM. NO: RS.088.05  
FIA STANDARD: FIA 8856-2000

### FLOATING ARMS

with elastic bellows.



### OUTER POCKET

IA01816F042XX

Navy blue



IA01816F028XX

Cream



### INNER COLLAR

in soft knitted fabric  
for maximum comfort.

### 2 VERTICAL STRIPES

on the chest

### ELASTIC

IA01816F

SIZES: 46-64  
sizing information  
on page 317  
SFI 3.2A/5 on request



### SUPER RESISTANT MECHANICS OVERALL

Polyester - cotton fabric resistant to repeated washing and most stubborn stains.

**NB1578**

1 LAYER  
SIZES: 44-64  
sizing information on page 317

### SUPER RESISTANT MECHANICS OVERALL

Lightweight and durable polyester - cotton fabric.

**NB1579**

**NB1579C FOR CHILDREN**

1 LAYER  
SIZES: 44-64

CHILDREN SIZES:  
height 120-130-140-150

sizing information on page 317

**ARMBELLOWS**  
in knitted elastic fabric

**ARMBELLOWS**  
in knit elastic fabric

**INNER POCKET**

**ALSO FOR CHILDREN!**

**NB1578041XX**  
Blue

**NB1579061XX**  
Red

**LARGE POCKETS**  
on the front

**POCKETS**  
for holding tools

**KNEE PADS**  
removable

**KNEE PADS**  
removable

**ELASTIC**

**ELASTIC**

**VELCRO**  
closure

**VELCRO**  
closure



**NB1578061XX**  
Red



**NB1578071XX**  
Black



**NB1579041XX**  
Blue



**NB1579071XX**  
Black

# ENDURANCE



AF CORSE

## LOOP HOLDER

NB/1892

Back loop holder for radio and tools, belt high (three loops).

NB/1891

Front loop holder for radio and tools (two loops).



## NUT HOLDER ON BELT

NB/1890R

NB/1890L

Right or left.



## RADIO CABLE SLOT

NB/1893R

NB/1893L

With flap coverage. Right or left.



## NUT HOLDER ON CHEST

NB/1889R

NB/1889L

Right or left.



## INSIDE POCKET

NB/1887R

NB/1887L

Right or left.



## BAND HOLDER

NB/1888R

NB/1888L

Right or left.



## ENDURANCE INSOLE for IC/791E

IC/100

Gel anatomic insole (spare parts) for ENDURANCE shoes. Guarantees higher comfort and stability, maximum cushioning against impact forces. Sizes: 37-46



## TECNICA-S GLOVE

IB/764

€ 89,00 (C)

Strong and comfortable professional glove

- Colours: black, red, blue/yellow, fluo yellow.
- Sizes: S-XL
- Homologation: FIA 8856-2000



\*SFI on request only for special production

## RACING SUITS TABLE

HOMOLOGATION	LAYERS	gr/m <sup>2</sup>	SIZES	
<b>ONE ART SUIT</b>				
FIA 8856/2000	3	295	46 64	 IA01857178XX
<b>ONE-S1 SUIT</b>				
FIA 8856/2000	3	235	46 64	     IA01852076XX IA01852083XX IA01852184XX IA01852073XX IA01852244XX
<b>ONE-S SUIT</b>				
FIA 8856/2000	3	235	46 64	   IA01853071XX IA01853083XX IA01853244XX
<b>ONE-SL SUIT</b>				
FIA 8856/2000	3	235	custom made	 IA01855
<b>ONE EVO SUIT</b>				
FIA 8856/2000	3	235	46 64	     IA01851089XX IA01851178XX IA01851076XX IA01851244XX IA01851270XX
<b>TECNICA EVO SUIT</b>				
FIA 8856/2000 SFI on request*	3	320	44 64	     IA01859076XX IA01859373XX IA01859178XX IA01859073XX IA01859244XX
<b>TECNICA-S SUIT</b>				
FIA 8856/2000 SFI on request*	2	350	44 64	    IA01850076XX IA01850089XX IA01850063XX IA01850043XX
<b>FIRST EVO SUIT</b>				
FIA 8856/2000 SFI on request*	2	400	42 64	     IA01854076XX IA01854089XX IA01854184XX IA01854063XX IA01854046XX
<b>FIRST-S SUIT</b>				
FIA 8856/2000 SFI on request*	2	400	44 64	     IA018288071XX IA018288083XX IA018288184XX IA018288061XX IA018288244XX
<b>OMP SPORT SUIT</b>				
FIA 8856/2000 SFI on request*	2	400	S XXL	   IA01847F071XX IA01847F041XX IA01847F061XX
<b>OS 10 SUIT</b>				
SFI 3.2	1	200	S XXL	 IA01904071XX

\*indicative values

PLEASE NOTE

The XX in each part number indicates the location of the size.

## VINTAGE SUITS TABLE

HOMOLOGATION	LAYERS	gr/m <sup>2</sup>	SIZES	
<b>ONE VINTAGE</b>				
FIA 8856/2000 SFI on request*	3	235	46 64	  IA01842020XX IA01842071XX
<b>LE MANS</b>				
FIA 8856/2000 SFI on request*	3	400	46 64	 IA01823F022XX
<b>CLASSIC</b>				
FIA 8856/2000 SFI on request*	2	400	46 64	  IA01816F028XX IA01816F042XX

PLEASE NOTE  
The XX in each part number indicates the location of the size.

## MECHANICS' SUITS TABLE

ALSO FOR CHILDREN	LAYERS	MATERIAL	SIZES	
<b>BLAST</b>				
	1	polyester cotton	44 64	   NB1578041XX NB1578061XX NB1578071XX
<b>SUMMER</b>				
✓	1	light polyester cotton	44 64	   NB1579041XX NB1579061XX NB1578071XX



EMIL GREY - AG TEAM

# "SU MISURA"

## CUSTOMIZE YOUR OWN SUIT

1

CHOOSE THE MODEL YOU WANT TO CUSTOMIZE FROM THE FOLLOWING:  
 ONE ART (IA01857) - ONE-S1 (IA01852) - ONE-S SUIT (IA01853) - ONE EVO SUIT (IA01851) - TECNICA  
 EVO SUIT (IA01859) - TECNICA-S SUIT (IA01850) - FIRST EVO (IA01854) - FIRST-S SUIT (IA01828B) -  
 ONE VINTAGE (IA01842) - LE MANS (IA01823F) - CLASSIC (IA01816F)

3

AREA BY AREA, CHOOSE AND APPLY THE COLORS FROM THE PALETTES

4

APPLY YOUR LOGOS AND GRAPHICS

5

DOWNLOAD THE ORDER FORM AND FILL IT IN EVERY PART

# UNDERWEAR

## UNDERWEAR



**RACING**

PAG 46



**KARTING**

PAG 282



M. ERICSSON - SAUBER F1

# ONE TOP

## ULTRA-LIGHT UNDERWEAR TOP WITH EXCLUSIVE FEATURES

Advanced technology knitted fabric with maximum breathability  
3D knitted inserts for maximum cooling in hot conditions that aligns with the breathable inserts of ONE ART ONE-S1, ONE-S, ONE-SL, ONE EVO, and TECNICA EVO suits.



MANUFACTURER: OMP  
MODEL: IAA/739  
FIA STANDARD: FIA 8856-2000

FOR MAXIMUM FRESHNESS  
USE INVIGORATING COOLING SPRAY  
(ref. PC02003)

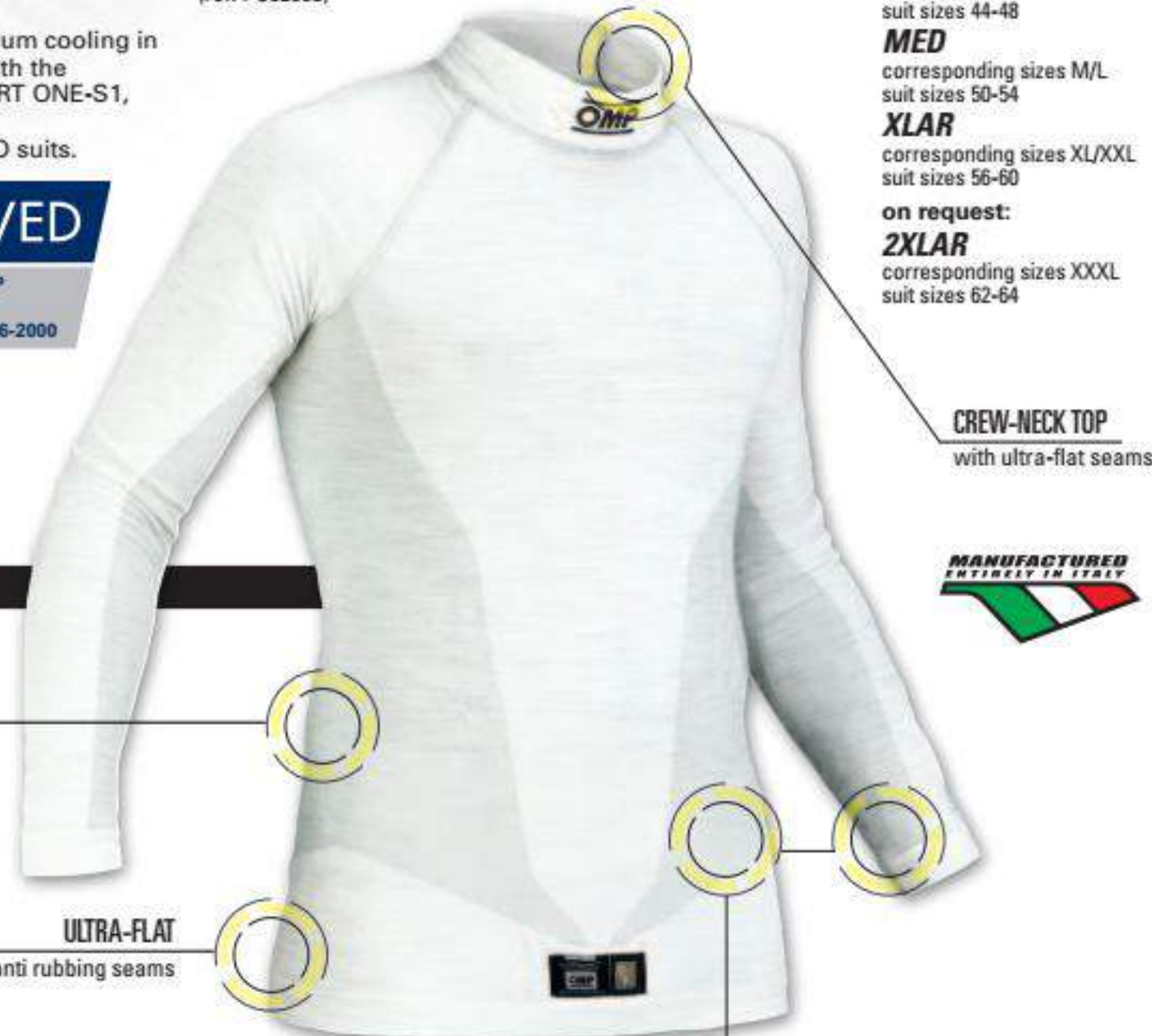

IAA/739E

SFI 3.3 on request

**SMA**  
corresponding sizes XS/S  
suit sizes 44-48  
**MED**  
corresponding sizes M/L  
suit sizes 50-54  
**XLAR**  
corresponding sizes XL/XXL  
suit sizes 56-60  
**on request:**  
**2XLAR**  
corresponding sizes XXXL  
suit sizes 62-64

CREW-NECK TOP  
with ultra-flat seams



IAA/739E020XX

White

SLIM FIT/ATHLETIC CUT

for increased driver comfort; extremely light, increased elasticity

ULTRA-FLAT  
anti rubbing seams



IAA/739E/CN/XX

Black

DRY SYSTEM  
3D breathable material



DRY SYSTEM  
UTILITY MODEL  
FRESH AIR IN HOT AIR OUT  
OMP REVOLUTIONARY COOLING SYSTEM

# ONE LONG JOHNS

## ULTRA-LIGHT PANTS WITH EXCLUSIVE FEATURES

Advanced technology knitted fabric with maximum breathability.  
3D knitted inserts for maximum cooling in hot conditions.

FOR MAXIMUM FRESHNESS  
USE INVIGORATING COOLING SPRAY  
(ref. PC02003)



MANUFACTURER: OMP  
MODEL: IAA/740P  
FIA STANDARD: FIA 8856-2000



IAA/740EP

SFI 3.3 on request

**SMA**  
corresponding sizes XS/S  
suit sizes 44-48  
**MED**  
corresponding sizes M/L  
suit sizes 50-54  
**XLAR**  
corresponding sizes XL/XXL  
suit sizes 56-60  
**on request:**  
**2XLAR**  
corresponding sizes XXXL  
suit sizes 62-64

DRY SYSTEM  
3D breathable material

ULTRA-FLAT  
and anti-rubbing seams



IAA/740EP/CN/XX

Black

DRY SYSTEM  
UTILITY MODEL  
FRESH AIR IN HOT AIR OUT  
OMP REVOLUTIONARY COOLING SYSTEM

IAA/740EP020XX

White

## INVIGORATING COOLING EFFECT SPRAY

PC02003



### BIO COSMETIC ITEM ACTIVE THERMOREGULATOR

Reduces the high temperatures inside the cockpits, controls perspiration and keeps a steady body temperature, offering an invigorating and cooling sensation.

OMP gives always particular attention to the wellness and comfort of the drivers all over the world.

## ONE BALACLAVA

IAA/741E

FOR MAXIMUM FRESHNESS  
USE INVIGORATING COOLING SPRAY

(ref. PC02003)



MANUFACTURER: OMP  
MODEL: IAA/741  
FIA STANDARD: FIA 8856-2000

FRESH AIR IN HOT AIR OUT  
OMP REVOLUTIONARY COOLING SYSTEM

IAA/741E/CN/X  
Black



IAA/741E020X  
White





## TECNICA TOP

**IAA/756**



**XS**  
corresponding  
sizes XS/S  
**ML**  
corresponding  
sizes M/L  
**XL**  
corresponding  
sizes XL/XXL  
**2XL**  
corresponding  
sizes XXXL

**IAA/756071XX**  
Black

**IAA/756020XX**  
White



**FIA APPROVED**

MANUFACTURER: OMP  
MODEL: R-IAA-001  
FIA STANDARD: FIA 8856-2000

Professional long sleeved underwear top with high neck for maximum protection made with a new comfortable fire retardant seamless fabric. The high breathability fabric inserts on main perspiration areas ensures the best comfort and a perfect fitting.

## TECNICA LONG JOHNS

**IAA/757**



**XS**  
corresponding  
sizes XS/S  
**ML**  
corresponding  
sizes M/L  
**XL**  
corresponding  
sizes XL/XXL  
**2XL**  
corresponding  
sizes XXXL

Professional underwear long johns made with a new comfortable fire retardant seamless fabric. The high breathability fabric inserts on main perspiration areas ensures the best comfort and a perfect fitting.

**IAA/757071XX**  
Black

**IAA/757020XX**  
White



**FIA APPROVED**

MANUFACTURER: OMP  
MODEL: R-IAA-002  
FIA STANDARD: FIA 8856-2000

## TECNICA BALACLAVA

**IAA/758071XX**

Black

**IAA/758020XX**  
White



**IAA/758**

SIZES: S/M - L/XL

**FIA APPROVED**

MANUFACTURER: OMP  
MODEL: R-IAA-003  
FIA STANDARD: FIA 8856-2000

Professional balaclava made with a new comfortable fire retardant seamless fabric that ensures the best comfort and a perfect fitting.



## FIRST TOP

**IAA/730**

SIZES: XS - XXL  
SFI 3.3



Viscose/aramid long sleeved top with external seams. Colour: cream.



**FIA APPROVED**

MANUFACTURER: OMP  
MODEL: IAA/730  
FIA STANDARD: FIA 8856-2000

## FIRST LONG JOHNS

**IAA/731P**

SIZES: XS - XXL  
SFI 3.3



Viscose/aramid long johns with external seams. Colour: cream.



**FIA APPROVED**

MANUFACTURER: OMP  
MODEL: IAA/731P  
FIA STANDARD: FIA 8856-2000

## FIRST BALACLAVA

Viscose/aramid balaclava with external seams. Colour: cream.



**IAA/729**

SIZES: S - M  
SFI 3.3

**FIA APPROVED**

MANUFACTURER: OMP  
MODEL: IAA/729  
FIA STANDARD: FIA 8856-2000

# SOCKS

**IAA/722 - IAA/724 - IAA/723**

Aramid knitted socks.  
FIA HOMOLOGATED  
SFI 3.3

SIZES: XS - L



**IAA/722** Cream



**IAA/724** Black



**IAA/723** Cream

**ONE SOCKS**

**IAA/749**

These socks make use of the same material of the One Underwear, coupled with advanced knitting techniques to provide differentiated pressure areas, with beneficial effect for blood circulation, reducing the feeling of fatigue in the legs while driving. FIA HOMOLOGATED

SIZES: S - M - L



**IAA/749/CN/X** Black



**IAA/749028X** White

# OMP COOL SHIRT

## OMP COOLSHIRT

Underwear long sleeved top with integrated water based cooling system.

**FOR MAXIMUM FRESHNESS  
USE INVIGORATING COOLING SPRAY**  
(ref. PC02003)



MANUFACTURER: OMP  
MODEL: COOL SHIRT  
FIA STANDARD: FIA 8856-2000



IAA/752028XX White

**WORLDWIDE  
EXCLUSIVE**

IAA/752071XX

Black



IAA/752 Back detail



**IAA/752**

SFI 3.3 on request

### SMA

corresponding sizes XS/S  
suit sizes 44-48

### MED

corresponding sizes M/L  
suit sizes 50-54

### XLAR

corresponding sizes XL/XXL  
suit sizes 56-60

### INTEGRATED QUICK CONNECTIONS

to be used with ID/793 system for short races;  
to be used with ID/794 system for longer races or go directly for top performances with the **COOLSHIRT PRO AIR AND WATER SYSTEM ID/795**, with additional ventilation for your helmet or seat (see page 57).

To be used only with quick connection in red colour.

## DUAL FLOW CONTROLLER

**ID/798**

(water and air)- Controls the amount of refrigerating effect and gives the driver control of his/her comfort while in the race car by controlling the flow of cooling water through the shirt and the flow of fresh air in the helmet. Available as replacement for Air & Water System dual controller.



## UNIVERSAL CONNECTOR AND DRAIN KIT

**ID/799**

Universal connectors for supply hose ID/797. Available as replacement of original parts.



## SAFETY PULL RELEASE CONNECTOR

**ID/800**

Safety pull release connectors that allow to connect the shirt to the supply hose ID/797. Available as replacement of original parts.



## BRACKET

**ID/801**

Spare mounting tray for Club System (ID/794). Comes with tie down strap.



## MAINTENANCE ADDITIVE

**PC02004**

This non-toxic bio-degradable solution contains a fungicide yet is safe to use in all Coolshirt water based cooling systems. Regular use of this additive will not only help clean the system but it will also improve the performance and life of the system pump.



## BAG SYSTEM

**ID/793**

**WATER COOLING SYSTEM PORTABLE FLEXIBLE BAG**  
Lightweight and waterproof canvas denier bag with an internal 12 V pump. For use in all types of racing. Cooling time: 1/2h - 1h More accessories available.  
**Supply hose ID/797 sold separately.**



## CLUB SYSTEM

**ID/794**

**WATER COOLING SYSTEM CLUB SYSTEM RIGID BOX**  
23 lt capacity cooling unit with an internal pump which supplies water to the cooling underwear through 3 mt of double insulated hose with automatic shutoff/quick disconnects. Perfect from road courses to oval track racing. Cooling time: 6h More accessories available. **Bracket ID/801 included. Supply hose ID/797 sold separately.**



## COOL SHIRT SYSTEM

**ID/795 COOL SHIRT PRO AIR & WATER SYSTEM**

Used in all levels of racing, it provides temperature controlled cooled water to the driver's Cooling Shirt and cooled filtered air to the helmet. 2,5 mt of double water hose with automatic shutoff/quick disconnects attach the shirt to the unit. The kit includes the box with internal pump and blower, supply water hose (2,5mt), dual flow controller (ID/798), mounting tray (ID/801), air hoses, connectors and filters. Cooling time: 4h More accessories available.



## FLOW CONTROLLER

**ID/796**

Controls the amount of refrigerating effect and gives the driver control of his/her comfort while in the race car by controlling the flow of cooling water through his/her shirt.



## SUPPLY HOSE

**ID/797**

CoolShirt 10ft (3 mt) supply hose enables the Cool Shirt Bag or Club System Box to be stored further away from the driver if required. Inherently flexible, the Hose Supply is an ideal accessory to ensure future flexibility for the Cooling system. Also available as replacement for CoolShirt water cooling system damaged hoses.



# GLOVES

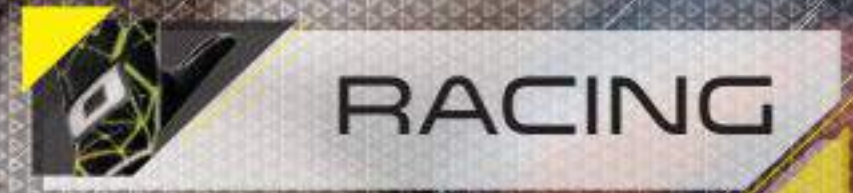

RACING

PAG 54



VINTAGE

PAG 63



MECHANICS

PAG 65



KARTING

PAG 286

**ONE** Art

# GLOVES

IB/763

SIZES: XS - XL  
sizing information  
on page 317

PRECURVED  
EXTERNAL SEAMS



TOP LEVEL RACING GLOVES WITH TOTALLY PRINTABLE DESIGN

AVAILABLE ONLY UPON REQUEST

It is possible to customize the gloves.

Unlimited customization ways thanks to the totally printed design.

EXTERNAL SEAMS

PALM WITH FIRE-RETARDANT,  
SILICONE RUBBER INSERTS

proven to give optimal grip,  
lightness and sensitivity

**NEW!**

SLANTED CUT

ELASTIC BAND  
on the wrists

**FIA APPROVED**

MANUFACTURER: OMP  
MODEL: TBD  
FIA STANDARD: FIA 8856-2000



# ONE Art RACING GLOVES

This model of glove can be customized through the use of images, photos and color blendings. This peculiar feature is possible thanks to our proprietary technology "OMP Print Art". In order to outline what spaces are at the customer's disposal for personalization, we show you the exploded view of those areas.



### SUPER PROFESSIONAL GLOVES

Professional fireproof HI - TECH gloves based on F1 technology. Precurved for best fitting. Diagonal cut on the wrists + elastic band on the wrists. Inside seams on thumbs and forefingers for highest precision on the controls, external seams on palm, middlefinger, ringfinger and pinkie for maximum comfort.



### IB/759

SIZES: XS - XL  
sizing information on page 317

PRECURVED  
MIXED INTERNAL/  
EXTERNAL SEAMS



HAND AND FINGERS  
SILICONE WEBBING

### INTERNAL SEAMS

in forefinger and thumb for highest precision on the controls

### ULTRA-GRIP

is used on the fingertips and forefingers for maximum grip on the steering wheels

### LEATHER INSERTS

ensuring the correct grip on the shift paddle, buttons or steering wheels

### EXTERNAL SEAMS

on pinkie, middle and ring finger for maximum comfort

### IB/759/GF/XX

Fluo yellow/black/silver



MANUFACTURER: OMP  
MODEL: ONE-EVO  
FIA STANDARD: FIA 8856-2000



IB/759/BW/XX Navy blue/white/cyan



IB/759/N/XX Black/white



IB/759/W/XX White/black/red

### LEATHER PALM

internal points in antislip silicone webbing

### DOUBLE ELASTIC

wrist closure for secure fit

### SLANTED CUT



### IB/755E

SIZES: XS - XL  
sizing information on page 317

PRECURVED  
EXTERNAL SEAMS  
SFI 3.3/5 on request

### SUPER PROFESSIONAL GLOVES

Fireproof precurved top level gloves. Diagonal cut on the wrists + elastic band on the wrists. Completely external seams for maximum comfort, fire retardant silicone rubber palm. Modern design.



MANUFACTURER: OMP  
MODEL: ONE-S ONE EVO 2015 MY  
FIA STANDARD: FIA 8856-2000



IB/755E/NW/XX Black/white/grey



IB/755E/NV/XX Black/white/grey



IB/755E/GF/XX Fluo yellow/black/grey



IB/755E/B/XX Navy blue/white/cyan



IB/755E/R/XX Red/white/black



IB/755E/W/XX White/black/red

### EXTERNAL SEAMS

for maximum comfort

### PRECURVED FINGER

design for optimal comfort

### SELECTED GRIP AREA

inserts are strategically located in order to decrease bunching



### PALM WITH FIRE-RETARDANT, SILICONE RUBBER INSERTS

proven to give optimal grip, lightness and sensitivity

### ELASTIC BAND on the wrists

### SLANTED CUT

# TECNICA **evo** GLOVES

# TECNICA-**S** GLOVES

## HIGH ADHERENCE GLOVES

Fire retardant silicone rubber palm for optimized grip and sensitivity, with localized leather inserts that provide impact protection to pressure points areas. Adjustable velcro strap closure for snug fitting at the wrist.



MANUFACTURER: OMP  
MODEL: TECNICA EVO  
FIA STANDARD: FIA 8856-2000



**NEW!**

**IB/756E**

SIZES: XS - XL  
sizing information  
on page 317  
PRECURVED  
EXTERNAL SEAMS

EXTERNAL SEAMS

ADJUSTABLE VELCRO  
STRAP CLOSURE

PALM IN SUEDE LEATHER  
and silicone rubber

ELASTIC WRIST STOP

SLANTED CUT

**IB/756E/R/XX**

Red/black/white



**IB/756E/NGI/XX** Black/anthracite/fluo yellow



**IB/756E/N/XX** Black/white



**IB/756E/BC/XX** Navy blue/cyan



**IB/756E/W/XX** White/black/red

## STRONG AND COMFORTABLE PROFESSIONAL GLOVE



**NEW!**

**IB/764**

SIZES: S - XL  
sizing information  
on page 317  
INTERNAL SEAMS

SUITABLE FOR  
DRIVERS AND  
MECHANICS'

INNER SEAMS

PADDED  
REINFORCEMENT

GRIP INSERTS

**IB/764/GF/XX**

Fluo yellow/black



**IB/764/N/XX** Black/white



**IB/764/R/XX** Red/white



**IB/764/BG1/XX** Royal blue / fluo yellow



MANUFACTURER: OMP  
MODEL: MISTRAL  
FIA STANDARD: FIA 8856-2000

# FIRST eVO GLOVES

# FIRST-S GLOVES

## PROFESSIONAL GLOVES

Light and resistant glove with elastic band on the wrist, straight cut design, inner seams. Leather reinforcements on the top of the fingers and silicone palm for best grip and sensitivity.



MANUFACTURER: OMP  
MODEL: FIRST EVO 2016 MY  
FIA STANDARD: FIA 8856-2000

**IB/757E/BC/XX**

Blue/cyan/grey



**IB/757E**

SIZES: S - XL  
sizing information  
on page 317

PRECURVED  
INTERNAL SEAMS

LEATHER INSERTS

for more  
resistance

ELASTIC BAND  
on the wrists

PALM WITH FIRE-RETARDANT,  
SILICONE RUBBER INSERTS

proven to give optimal grip,  
lightness and sensitivity



**IB/757E/NGI/XX** Black/fluo yellow/grey



**IB/757E/R/XX** Red/white/black/grey



**IB/757E/N/XX** Black/white/grey

## PROFESSIONAL GLOVES

Strong and comfortable racing gloves with internal seams. Palm in high grip silicon rubber, straight cut wrist. Excellent quality/price ratio, modern and fresh design.



**IB/761E**

SIZES: XS - XL  
sizing information  
on page 317

INTERNAL SEAMS



MANUFACTURER: OMP  
MODEL: FIRST EVO  
FIA STANDARD: FIA 8856-2000

**NEW!**

**IB/761E/N/XX**

Black



INTERNAL SEAMS



**IB/761E/R/XX** Red



**IB/761E/B/XX** Royal blue

PALM IN HIGH GRIP  
SILICONE RUBBER

ELASTIC BAND



In compliance with FIA  
Standard 8856-2000

**OMP**

Year of manufacture 2017

# NEW RALLY

## GLOVES

**STRONG AND DURABLE PROFESSIONAL GLOVE**  
Fireproof stretch fabric - suede leather. Ideal for use in harsh condition.

**IB/702/B/XX**  
Blue



**IB/702**

IN COMPLIANCE WITH ISO 6940  
SIZES: S - XL  
sizing information on page 317



**IB/702/R/XX**  
Red



**IB/702/N/XX**  
Black

# DIJON

## GLOVES

**IB/746**

SIZES: S - XL  
sizing information on page 317

**VINTAGE GLOVE**

'70s design with fabrics and quality of last generation gloves. Fire-resistant fabric with stretch suede inserts. Internal seams.



**SUEDE LEATHER INSERTS**  
on palm and fingers for very good grip



**IB/746/B/XX**  
Navy blue

**IB/746/N/XX**  
Black

**ELASTIC WRIST STOP**



**IB/746/M/XX**  
Cream/brown



# TAZIO

## GLOVES

**IB/747**

SIZES: S - XL  
sizing information on page 317

**VINTAGE GLOVE**

Smooth leather and cotton fabric.

**COTTON FISHNET FABRIC**

**IB/747/N/XX**  
Black

**SMOOTH LEATHER PALM**



**IB/747/M/XX**  
Brown



**STRAP WITH VELCRO**





\*SFI on request only for special production

## RACING GLOVES TABLE

HOMOLOGATION	PRECURVED	EXTERNAL SEAMS	PALM INSERT	SIZES	
<b>ONE ART</b>					
FIA 8856/2000	✓	external	flame retardant silicone	XS XL	 IB/763XX
<b>ONE EVO</b>					
FIA 8856/2000 HAND AND FINGERS SILICONE WEBBING	✓	mixed internal/external	flame retardant silicone	XS XL	 IB/759/BW/XX IB/759/GF/XX IB/759/N/XX IB/759/W/XX
<b>ONE-S</b>					
FIA 8856/2000 SFI on request*	✓	external	flame retardant silicone	XS XL	 IB/755E/NW/XX IB/755E/GF/XX IB/755E/B/XX IB/755E/R/XX IB/755E/W/XX IB/755E/NV/XX
<b>TECNICA EVO</b>					
FIA 8856/2000	✓	external	flame retardant silicone and leather	XS XL	 IB/756E/N/XX IB/756E/NGI/XX IB/756E/BC/XX IB/756E/R/XX IB/756E/W/XX
<b>TECNICA-S</b>					
FIA 8856/2000		internal	silicone	XS XL	 IB/764/N/XX IB/764/BGI/XX IB/764/R/XX IB/764/GF/XX
<b>FIRST EVO</b>					
FIA 8856/2000	✓	internal	leather and silicone	S XL	 IB/757E/BC/XX IB/757E/NGI/XX IB/757E/R/XX IB/757E/N/XX
<b>FIRST-S</b>					
FIA 8856/2000		internal	silicone	XS XL	 IB/761E/N/XX IB/761E/B/XX IB/761E/R/XX
<b>NEW RALLY</b>					
ISO 6940		internal		S XL	 IB/702/B/XX IB/702/R/XX IB/702/N/XX

**PLEASE NOTE**  
The XX in each part number indicates the location of the size.

## WORKSHOP GLOVE

NB/1886

TECHNICAL SHORT GLOVE FOR PROFESSIONAL USE  
With palm in suede leather for best fitting and adherence.



ADJUSTABLE STRAP

SIZES: S-XL  
sizing information on page 317

## PRO MEC GLOVES FLUO MECHANIC'S GLOVE

IB/758



INNER SEAMS

HIGH PROTECTION reinforcement  
ANTI SLIP silicon rubber palm

SIZES: S-XL HOMOLOGATION: FIA 8856-2000  
sizing information on page 317

## SHORT GLOVES

NB/1885

SHORT TECHNICAL GLOVE  
Polyester/cotton.



INSERTS  
PVC rubber dot

CLOSURE  
elastic slipout-proof

SIZES: M (S-M) - L (L/XL)  
sizing information on page 317

## LONG GLOVES

NB/1868

LONG MODEL GLOVES  
High heat resistance.  
Kevlar made.



SIZES: M (S-M) - L (L/XL)  
sizing information on page 317

# SHOES

RACING

PAG 68

VINTAGE

PAG 79

MECHANICS

PAG 68

KARTING

PAG 294

ONE Art

# SHOES

IC/819

SIZES: 37 - 48  
sizing information  
on page 317

HIGH LEVEL PROFESSIONAL RACE BOOTS WITH TOTALLY PRINTABLE DESIGN

AVAILABLE ONLY UPON REQUEST

It is possible to customize the shoes by adding/removing the inner foot support to get more comfort/sensibility. Unlimited customization ways thanks to the totally printed design.

**NEW!**



REAR BELLOW

NO-LACES

elastic fit with adjustable velcro strap to give the best comfort

PIVOT-LIKE HEEL DESIGN

for smooth pedal actuation

ONE PIECE OF SOFT FIRE RETARDANT FABRIC

HIGH RESISTANT SIDE protection on tip

FIA APPROVED

MANUFACTURER: OMP  
MODEL: TBD  
FIA STANDARD: FIA 8856-2000

# ONE Art RACING SHOES

This model of shoe can be customized through the use of images, photos and color blendings. This peculiar feature is possible thanks to our proprietary technology "OMP Print Art". In order to outline what spaces are at the customer's disposal for personalization, we show you the exploded view of those areas.



# ONE evo R

FORMULA

## SHOES



## ONE evo ROTOR LACING

### PROFESSIONAL ULTRA-SOFT AND ULTRA-LIGHT SHOES SOFT KANGAROO LEATHER

Racing boot in soft leather and fabric with exclusive micro adjustment **ROTOR LACING** that ensures an easy and quick lacing. Very light and comfortable. Structure designed to increase the sensitivity on the pedal. High resistance and best grip. The perforated leather permits best breathability.

IC/805

SIZES: 37 - 48  
sizing information  
on page 317



REAR BELLOW



**EXCLUSIVE ROTOR-LACING**  
for micro adjustment  
and a perfect fitting

**INJECTED SOLE**  
for maximum grip and  
resistance to wear

**PIVOT-LIKE HEEL DESIGN**  
for smooth pedal  
actuation



**PERFORATED LEATHER**  
for maximum  
breathability

**NEW FOOT SUPPORT**  
to reduce stress on the foot  
and provide maximum drive  
sensitivity

IC/805246XX  
Dark blue/silver/cyan

**EXCLUSIVE ROTOR-LACING**  
for micro adjustment  
and a perfect fitting

**COMFORT FOAM**  
for pressure reduction

**HIGH STIFFNESS INSERT**  
for load spreading and  
fatigue reduction coupled  
with thermal insulation layer

**HEEL SUPPORT**  
in low density material  
for minimum weight

**INJECTED SOLE**  
for maximum grip and  
resistance to wear



IC/805099XX  
Fluo yellow/black/white



IC/805370XX  
Black/silver/fluo yellow



IC/805230XX  
Fluo green/black/white



IC/805071XX  
Black/white



IC/805020XX  
White/black/silver



MANUFACTURER: OMP  
MODEL: ONE EVO FORMULA  
FIA STANDARD: FIA 8856-2000

### PROFESSIONAL TOP LEVEL

Perforated full grain leather for high breathability and fabric inserts. High resistant, injected sole, best grip. Velcro strap for best fitting. Structure designed to increase the sensitivity on the pedal. Thin laces to guarantee and permit a good sliding and a quick lacing of the boots.



MANUFACTURER: OMP  
MODEL: IC/769E ONE EVO-MY2013  
FIA STANDARD: FIA 8856-2000



### IC/806

SIZES: 36 - 48  
sizing information  
on page 317

#### REAR BELLOW



#### INJECTED SOLE

for maximum grip and resistance to wear

#### PIVOT-LIKE HEEL DESIGN

for smooth pedal actuation

#### THIN LACES

for high sliding and quick lacing

#### PERFORATED LEATHER

for maximum breathability

### IC/806099XX

Fluo yellow/black/white



### IC/806020XX

White/black/silver



### IC/806071XX

Black/white



### IC/806061XX

Red/black/white



#### NEW FOOT SUPPORT

to reduce stress on the foot and provide maximum drive sensivity

### IC/807

SIZES: 37 - 48  
sizing information  
on page 317  
SFI 3.3/5 on request

### PROFESSIONAL TOP LEVEL

Leather boot. Tecnical reinforcements on the tip and on the heel. Injected high resistant sole and best grip. Velcro strap for the best fitting of the ankle. Inner sole with plate reinforcement for highest sensitivity and reduction of the stress on the feet. Thin laces to guarantee and permit a good sliding and a quick lacing of the boots. Modern design.



MANUFACTURER: OMP  
MODEL: IC/801 ONE-S  
FIA STANDARD: FIA 8856-2000



#### VELCRO STRAP

for a best fitting of the ankle

#### SPECIAL VERSION: RED SOLE, WHITE UPPER



#### INJECTED SOLE

for maximum grip and resistance to wear



### IC/807020XX

White/black/silver/red laces and sole

#### THIN LACES

for high sliding and quick lacing

#### TECNICAL REINFORCEMENTS

on the tip and on the heel

#### INNER SOLE

with plate reinforcement for highest sensitivity and reduction of stress on the feet.



### IC/807061XX

Red/white/black



### IC/807244XX

Dark blue/white/cyan



### IC/807071XX

Black/white/silver



### IC/807099XX

Fluo yellow/black/anthracite

#### BLACK SOLE, 4 DIFFERENT UPPERS



## PROFESSIONAL BOOTS

Boots made of soft suede leather. High quality and resistant ultralight sole with inner reinforcement for maximum sensitivity and high protection. Made with a single piece of leather in order to guarantee maximum comfort and low weight. Features a new design and side protections on the tip.



## IC/803E

SIZES: 37 - 48  
 sizing information  
 on page 317  
 SFI 3.3/5 on request



**ULTRALIGHT OUTSOLE CONSTRUCTION**  
 with inner reinforcement

**SOFT MATERIAL**



**IC/803E073XX**  
 Black/red



**SOFT SUEDE**

**SIDE PROTECTIONS**  
 on the tip



**IC/803E044XX**  
 Blue/fluo yellow



**IC/803E071XX**  
 Black

## PROFESSIONAL MID CUT BOOTS

Made of suede leather with an excellent quality/price ratio. Resistant sole with a round cutted heel in order to ease the rotation of the feet while driving. Velcro strap on the ankle for best fitting. Inner black knitted fabric. Reinforcements on the tip. Available in modern colors with fluo inserts.



## IC/809

SIZES: 37 - 48  
 sizing information  
 on page 317



**ROUND CUTTED HEEL**  
 in order to ease the rotation of the feet while driving

**VELCRO STRAP**  
 for a best fitting of the ankle



**IC/809182XX**  
 Anthracite/fluo yellow

**SIDE PROTECTIONS**  
 on the tip



**IC/809086XX**  
 Anthracite/red



**IC/809244XX**  
 Dark blue/cyan

# FIRST-S

## SHOES

# OMP SPORT

## SHOES

### PROFESSIONAL MID CUT BOOTS

Made of suede leather with excellent quality/price ratio. Internal black knitted fabric.



MANUFACTURER: OMP  
MODEL: IC/802 FIRST-S  
FIA STANDARD: FIA 8856-2000



IC/802

SIZES: 37 - 48  
sizing information  
on page 317



**ROBUST AND RESISTANT**  
sole with heel support in order to help  
the rotation movement of the foot  
during driving

IC/802071XX  
Black



CONFORTABLE  
SOFT SUEDE LEATHER



IC/802041XX  
Blue



IC/799071XX  
Red/Black

### ENTRY LEVEL RACE BOOTS

Made in soft, comfortable and lightweight microfiber.  
Exclusive resistant antislip rubber sole inspired  
by car's tyres.



IC/816

SIZES: 36 - 47  
sizing information  
on page 317

**NEW!**



**RUBBER SOLE**  
high grip in every condition  
and long-time resistance

ADJUSTABLE STRAP

IC/816071XX  
Black



LIGHTWEIGHT  
MICROFIBER



MANUFACTURER: OMP  
MODEL: R-IC-001  
FIA STANDARD: FIA 8856-2000

# CO-DRIVER

## SHOES

### CO-DRIVER SHOES

Co-driver boot made of water-repellent suede leather with inner soft fabric. Sole made of hydrocarbon resistant rubber, lace closure, ankle velcro strap.

Compatible with IC/100 gel anatomic insole for mechanics (sold separately).



MANUFACTURER: OMP  
MODEL: IC/788 M+S  
FIA STANDARD: FIA 8856-2000



IC/791E061XX  
Red



IC/791E071XX  
Black



RAINPROOF LEATHER

IC/791E041XX  
Blue

SOLE MADE OF RESISTANT RUBBER,  
HYDROCARBON RESISTANT

IC/791E

SIZES: 37 - 48  
sizing information  
on page 317



# CARRERA HIGH

## BOOTS

### HIGH QUALITY VINTAGE BOOTS

Polished leather lined in soft jersey. Printed rubber sole resistant to hydrocarbons.

High quality treated leather for an ultra-soft feel.

Accurate hand-made production.



EMBOSSED  
with leather logo.



MANUFACTURER: OMP  
MODEL: CARRERA  
FIA STANDARD: FIA 8856-2000



IC/782015XX  
Brown

IC/782014XX  
Dark brown



HIGH SENSIVITY SOLE

IC/782

SIZES: 37 - 46  
sizing information  
on page 317

# RACING

# WORKSHOP

## SHOES



INNOVATIVE MECHANICS SHOES  
REALIZED IN COOPERATION  
WITH LOTTO SPORT ITALIA®



MIDSOLE IN EVA  
UPPER IN MESH

SYNTHETIC LEATHER INSERTS IN  
CARBON FIBER LOOK

ORC3404

SIZES:

38,5-39-40-40,5-41 42-42,5  
43-43,5-44 45-45,5-46-47



ORC3404076XX  
Black/white



ORC3404073XX  
Black/red



ORC3404084XX  
Grey/white

# CARRERA LOW

## BOOTS

### HIGH CLASSIC BOOTS

Polished leather lined in soft jersey. Printed rubber sole resistant to hydrocarbons.

High quality treated leather for an ultra-soft feel.

Accurate hand-made production.



EMBOSSED  
with leather logo.



MANUFACTURER: OMP  
MODEL: NURBURGRING  
FIA STANDARD: FIA 8856-2000



IC/784015XX  
Brown

IC/784079XX  
Black



IC/784

SIZES: 37 - 48  
sizing information  
on page 317



\*SFI on request only for special production

## RACING SHOES TABLE

HOMOLOGATION HYDRO CARBONS RESISTANT SOLE SHAPED BELLOWS NEW FOOT SUPPORT CONCEPT PERFORATED LEATHER SIZES

### ONE ART

FIA 8856/2000	✓	✓	✓	Maximum Sensitivity	37 48
---------------	---	---	---	---------------------	----------



### ONE EVO R FORMULA

FIA 8856/2000	✓	✓	✓	Maximum Sensitivity	37 48
---------------	---	---	---	---------------------	----------



### ONE EVO

FIA 8856/2000	✓	✓	✓	✓	36 48
---------------	---	---	---	---	----------



### ONE-S

FIA 8856/2000 SFI on request*	✓	✓	✓		37 48
----------------------------------	---	---	---	--	----------



### TECNICA EVO

FIA 8856/2000 SFI on request*	✓	✓	SOFT MATERIAL		37 48
----------------------------------	---	---	---------------	--	----------



### FIRST EVO

FIA 8856/2000	✓				37 48
---------------	---	--	--	--	----------



### FIRST-S

FIA 8856/2000	✓				37 48
---------------	---	--	--	--	----------



### CO-DRIVER

FIA 8856/2000	✓				37 48
---------------	---	--	--	--	----------



### OMP SPORT

FIA 8856/2000	✓				36 47
---------------	---	--	--	--	----------



The XX in each part number indicates the location of the size.

## VINTAGE SHOES TABLE

HOMOLOGATION HYDRO CARBONS RESISTANT SOLE SHAPED BELLOWS NEW FOOT SUPPORT CONCEPT PERFORATED LEATHER SIZES

### CARRERA HIGH

FIA 8856/2000	✓				37 46
---------------	---	--	--	--	----------



### CARRERA LOW

FIA 8856/2000	✓				37 48
---------------	---	--	--	--	----------



The XX in each part number indicates the location of the size.



# HELMETS



RACING

PAG 84



KARTING

PAG 302

# GP 8

## FULL FACE HELMET

Lightweight, made in composite material with soft and comfortable high breathability fire retardant internal lining, bordered strap with double ring closure and high precision adjustable visor with easy block system.



SC785

HOMOLOGATION:  
FIA 8859-2015  
SNELL 2015  
TWO SHELL SIZES  
SIZES: XS-XXL  
sizing information on page 317

LIGHT COMPOSITE SHELL

# J8 INTERCOM NEXUS

## OPEN FACE HELMET

Made in composite material. Lightweight, with soft and comfortable high breathability fire retardant internal lining, bordered strap with double ring closure and sun peak.



SC794

HOMOLOGATION:  
FIA 8859-2015  
SNELL 2015  
ONE SHELL SIZES  
SIZES: XS-XXL  
sizing information on page 317

LIGHT COMPOSITE SHELL



J8

SC787

HOMOLOGATION:  
FIA 8859-2015 - SNELL 2015

WITHOUT INTERCOM SYSTEM VERSION



J8 INTERCOM STEREO

SC788

HOMOLOGATION:  
FIA 8859-2015 - SNELL 2015

WITH INTERCOM KIT JA/854 (flexible microphone boom, speaker, Stereo plug)



# HELMET ACCESSORIES

## GP8 (SC785)

**AIR VENTS**  
 SC166 spare couple of front air vents  
 SC167 spare couple of rear air vents

**VISORS**  
 SC160 clear visor  
 SC174 short touring smoked visor (all included with the helmet)  
 SC163 iridium gold visor  
 SC161 dark visor  
 SC162 iridium blue visor

**SPOILER**  
 SC133 rear transparent spoiler  
 SC172 rear black spoiler (included with the helmet)

**SPARE VISOR**  
 movement pivot kit SC164

**SPARE SCREWS**  
 for tear off SC014

**SPARE VISOR LOCKING SYSTEM**  
 SC168

**TEAR OFF KIT 5 PIECES**  
 SC165

**SPARE CHEECK PADS**  
 size XXS-XXL SC169 (no picture).

**SPARE TOP INNER LINING**  
 size XXS-XXL SC170 (no picture).



## J8 (SC787) - J8 INT. STEREO (SC788) - J8 INT. NEXUS (SC794)

**SUN PEAK**  
 SC155 white sun peak (included with the helmet)  
 SC156 black sun peak

**SPARE SCREWS KIT**  
 to mounting sun peak SC157

**SPARE CHEECK PADS**  
 size XXS-XXL SC158 (no picture).

**SPARE TOP INNER LINING**  
 size XS-XXL SC159 (no picture).



# I-RACE NEXUS PLUG

JA/876

## SUPER PROFESSIONAL INTERCOM

**DIGITAL ELECTRONIC IMPROVED RELIABILITY.**  
 High quality sound and digital filtering.  
**FRAME:** aluminium case to shield electromagnetic interferences.

**DIMENSIONS**  
 110X60X30 MM  
**EASY MOUNTING**

**RACE MODE**  
 excludes phone connection, MP3 and VHF radio

**DB KILLER**  
 modify the control box's electronics enabling extra filters for loud environment

**OUTPUT**  
 RCA output for camera car

**SUPPLY**  
 12V power supply

**2 m cable length**

**2 m cable length**

**CONNECTIONS**  
 mobile phone via bluetooth

**MP3**  
 Jack connection.

**CO-DRIVER**  
 helmet connector

**DRIVER HELMET CONNECTOR**



WITH FEMALE NEXUS CONNECTOR IN ORDER TO BE COMPATIBLE WITH OMP AND PELTOR INTERCOM SYSTEMS

**CAN BE FIXED TO THE ROLLBAR**  
 in the preferred and most comfortable position; can be fixed to the dashboard by using the supplied brackets

**DIGITAL ELECTRONIC**

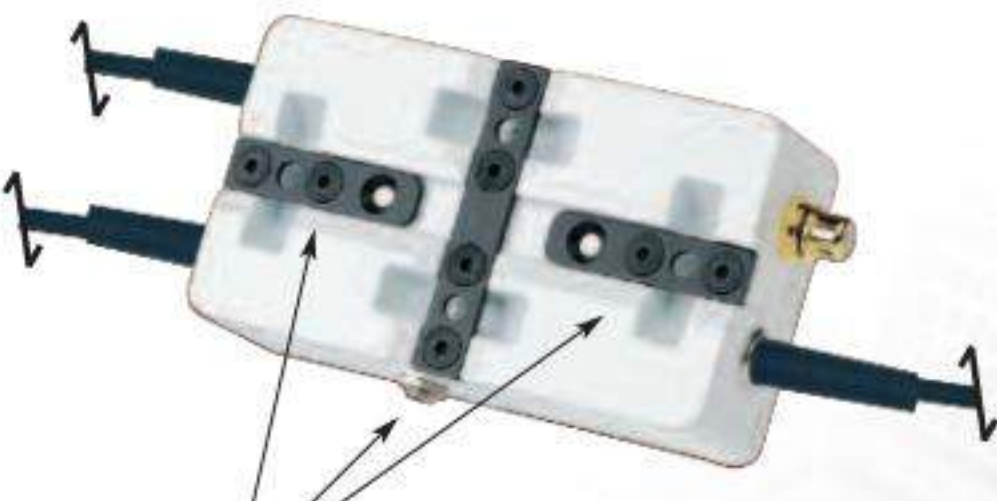

JA/856E

## PROFESSIONAL INTERCOM

**REDESIGNED ELECTRONIC FOR IMPROVED PERFORMANCE, INCREASED OUTPUT VOLUME (+30%) AND ELECTRONIC INTERFERENCES REDUCTION.**

Fixable on rollbar or dashboard.  
Powered by 9V PP3 (not supplied) or by car battery (through JA/834 cable).

**DIMENSIONS**  
125X60X35 MM  
EASY MOUNTING

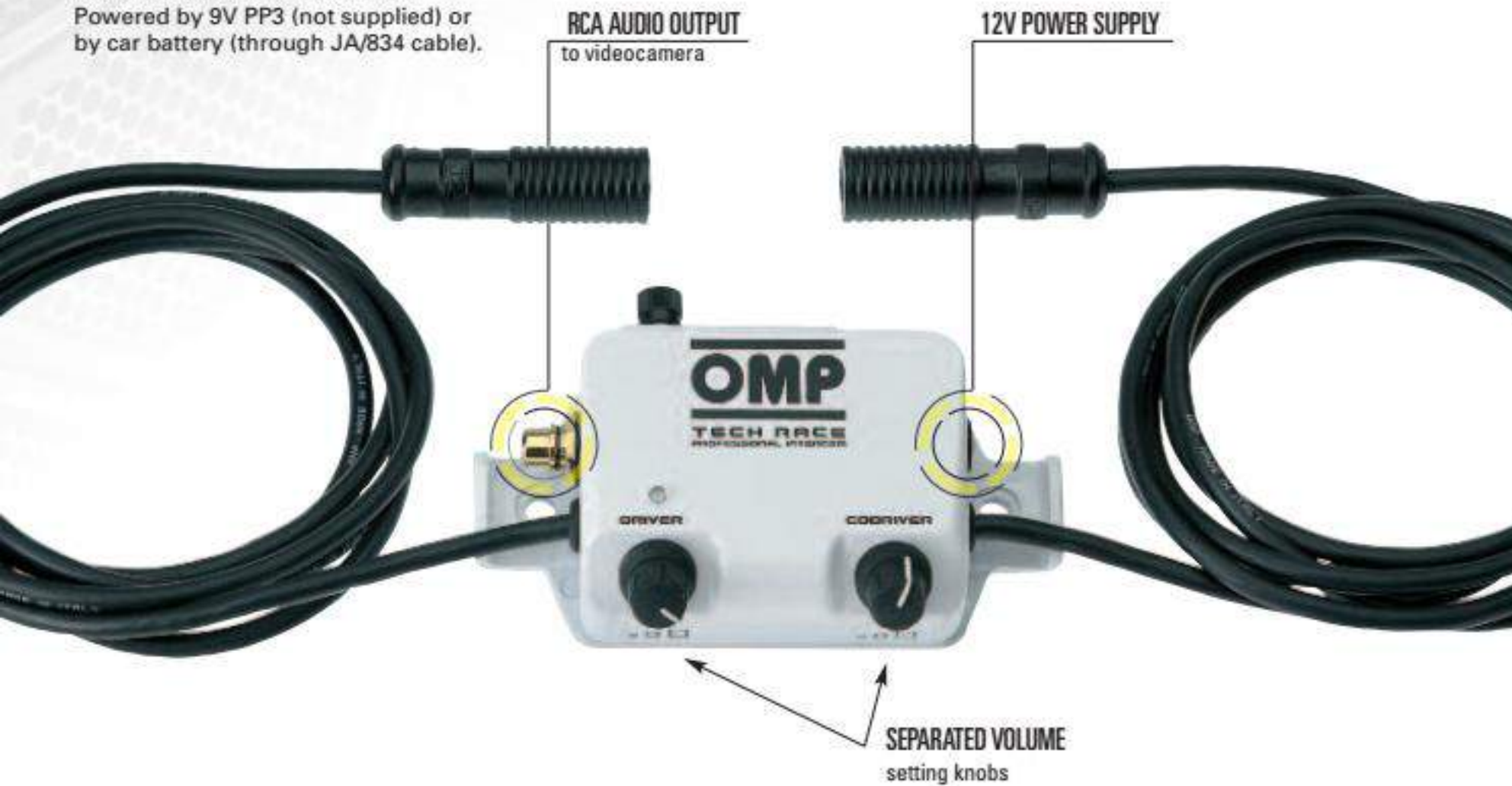

## HEADSET

JA/844

### HEADSET. EXCELLENT INSULATION FROM EXTERNAL NOISE

Flexible microphone boom. Dynamic microphone with integrated noise reduction. Designed to be used with TECH-RACE intercom JA/856 or JA/856E and I-RACE JA/876. Compatible with most intercom units available on the market (adaptors may be needed see on page 90).



## MICROPHONE

JA/877

### TECH-RACE SERIES: SPARE MICROPHONE BOOM

High quality microphone boom to be used as spare part for intercom kit JA/858, JA/858E, JA/878.



## INTERCOM KIT

JA/878



### TECH-RACE SERIES: INTERCOM KIT FOR OPEN FACE HELMETS WITH WIRE MOUNTED NEXUS CONNECTION

Excellent insulation from external noise. High quality flexible microphone boom. Dynamic microphone with integrated noise reduction. Designed to be used with TECH-RACE intercom JA/856, JA/856E, JA/876 and with J8 series helmets. Compatible with most Intercom units available on the market (adaptors may be needed see on page 114).

## AUDIO CABLE

JA/830



Audio cable to connect the control box JA/876, JA/855 or JA/855E and JA/856 or JA/856E to the camera car.

## WIRE EXTENSION

JA/829

**TECH-RACE SERIES: WIRE EXTENSION**  
1,5 m long extension cable with Nexus plug. Compatible with TECH-RACE and I-RACE units (JA/876, JA/856, JA/856E) and with helmets JET10 (SC761E) and J8 series (only and SC794).



## POWER SUPPLY CABLE

JA/834

**TECH-RACE SERIES: POWER SUPPLY CABLE.**  
Designed to connect the TECH-RACE JA/856 or JA/856E control box to the 12V car Power supply line.





# COMPATIBILITY WITH OTHER BRANDS

# COMPATIBILITY AMONG OMP PRODUCTS NEXUS PLUG

## OTHER BRANDS HELMETS + OMP NEXUS CONTROL BOX

**PELTOR HELMETS**  
male Nexus plug  **ALL OMP NEXUS PLUG CONTROL BOX**  
JA/856 - JA/856E - JA/876

**STILO HELMETS**  
female Nexus plug  **JA/865**  **ALL OMP NEXUS PLUG CONTROL BOX**  
JA/856 - JA/856E - JA/876

## OTHER BRANDS CONTROL BOX - OMP HELMETS

**PELTOR CONTROL BOX**  **ALL OMP NEXUS PLUG HELMETS**  
JET 8 (SC794)

**STILO CONTROL BOX**  
male Nexus plug  **JA/852**  **ALL OMP NEXUS PLUG HELMETS**  
JET 8 (SC794)

### STILO UNIT - OMP HELMET CONNECTING KIT

#### JA/852

Interface kit for connecting OMP helmets Jet 10 (SC761, SC761E) or J8 (SC794) and related headsets (JA/844, JA/857E, JA/858E, JA/878) to STILO intercom units



### OMP UNIT - STILO HELMET CONNECTING KIT

#### JA/865

Interface kit for connecting Stilo helmets to both TECH-RACE and I-RACE intercom units (JA/856, JA/856E, JA/855, JA/876).

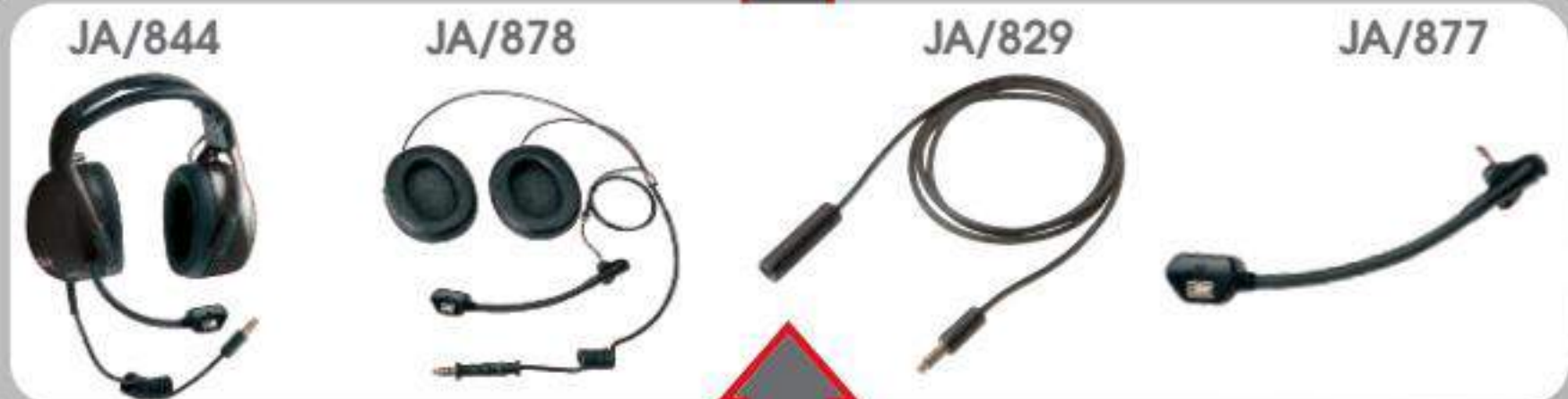

# B-RACE STEREO PLUG

JA/874

## INTERCOM CONTROL BOX RACER LINE

Without loudspeakers and microphone.  
One single driver/co-driver volume control. Powered by 9V PP3 battery (not supplied) or by car battery using JA/851 cable - can be fixed to rollbar and dashboard. Can be used with loudspeakers and microphone kit (JA/849E, JA/854E) or headsets JA/850E.

DIMENSIONS  
125X60X35 MM



## B-RACE ACCESSORIES

### HEADSET

JA/850E

Headset with adjustable microphone boom complete with loudspeakers and STEREO plug. Compatible with intercom control box JA/874.



### MICROPHONE KIT

JA/849E

Microphone kit for single helmet. To be used with control box JA/874. Compatible with GP7 and GP8 series helmets.



### ADAPTOR CABLE

JA/851

12V adaptor cable for intercom control box JA/874 for connection with the car (alternatively to battery 9V DC).

12V



### MICROPHONE KIT

JA/854

Microphone kit for single helmet. To be used with control box JA/874. Compatible with JET7 and J8 series helmets.



## STEREO PLUG COMPATIBLE CONTROL BOXES ACCESSORIES

SC788



JA/874



JA/850E

JA/854

JA/851



JA/849E



SC787



SC785



# CIRCUIT

## HELMET

SC611E

HOMOLOGATION  
ECE 22.05

SIZES: XS-XXL  
sizing information on page 317

### FULL FACE KARTING HELMET

Full face thermoplastic helmet, velvet lining (not fireproof), step setting visor.



# STAR

## HELMET

SC607E

HOMOLOGATION  
ECE 22.05

SIZES: S-XXL  
sizing information on page 317

### OPEN FACE KARTING HELMET

Open face helmet with ABS shell, velvet lining not fireproof, with revomable peak.





# HELMET SPARE PARTS

## CIRCUIT (SC611E)

### AIR VENTS

- SC150 spare couple of front air vents
- SC151 spare front air vent
- SC152 spare rear air vent

### VISORS

- SC148 clear visor (included with the helmet)
- SC149 dark visor



**SPARE VISOR**  
movement pivot kit  
SC154

## STAR (SC607E)

### SUN PEAK

- SC030 white sun peak (included with the helmet)
- SC031 black sun peak



# PROTECTIONS

## ELBOW PADS

ID/791

Aramid elbow pads with inner padding. One size.



## KNEE PADS

ID/790

Aramid knee pads with inner padding. In Nomex®. One size.



## RACING

## APRON

NB/1879

### COTTON APRON

Cotton apron, features a small tool pouch and large pockets.



NB/1879  
Black

NB/1879061  
Red

ONE SIZE

## APRON PLUS

NB/1894

### APRON PLUS

Professional apron for mechanics.



ONE SIZE - COLOR: Black

## SLEEVES

NB/1872

Aluminized sleeves, offering excellent protection against heat.



ONE SIZE

# ACCESSORIES

## NECK COLLAR

ID/789

Anatomic, round neck collar knit Nomex® for improved comfort. Inserts: Nomex® fabric. Padded: high density foam. One size.



## NECK SUPPORT

ID/787

Neck support in knit Nomex®. Padded: high density foam. One size.



## NA/1871



Helmet hook in steel. To be attached to the roll cage with supplied metal clamps.

## NA/1858



Helmet carrying net in polyester. Suitable for all cars, can hold 2 helmets.

## SD20



Hans strap holder in rubber (pair), with sticker.

## HELMET BAG

ORA/2972

Very resistant helmet carrying bag. Studied for holding also the Hans® helmet device. With a removable internal visor pocket, removable adjustable shoulder strap and a practical handle. H 33 x L 47 x W 29 Measures in cm



## HELMET BOX

NA/1864

Rally helmet box velvet, with wide side pockets. Internal sizes single box: 34x26x29 cm



## HANS® ACCESSORIES

### SC726

Hans® helmet anchor (male screw only - the female parts is inside the helmet). For one helmet (to be used exclusively with models SC754 - SC756 - SC761 - SC759 - SC769 - SC771 - SC772 - SC777K - SC785 - SC785K - SC787 - SC788 - SC794). According to FIA 8858-2010, 8860 and 8859-2015 rules.



### SC731

Hans® helmet anchor kit. For one helmet (to be used exclusively with pre-drilled models). According to FIA 8858-2002 rules, HANS® posts can be installed exclusively by the helmet manufacturer or by its authorised dealers.

Dealers authorised by OMP Racing for installing Hans® device



# ACCESSORIES

## REIMS

SC067

## VINTAGE CAP

Made entirely of soft smooth skin. Rear loop with button for fixing goggles.

SIZES: S-XL



## THRUXTON

SC066

## VINTAGE GOGGLES

Made of faux leather with metal details.



# CAR COMPONENTS

SKODA MOTORSPORT



## CAR COMPONENTS

100



### SEATS

PAG 102



### SAFETY HARNESSES

PAG 140



### ROLL BARS

PAG 168



### EXTINGUISHERS

PAG 174



### STEERING WHEELS

PAG 186

101

# SEATS

PETTER SOLBERG - PSRX VOLKSWAGEN SWEDEN

OMP



# SEATS



RACING

PAG 104



VINTAGE

PAG 130



OFF ROAD

PAG 133



TUNING

PAG 134



KARTING

PAG 310

# Art SEATS

This model of seat can be customized through the use of images, photos and color blendings. This peculiar feature is possible thanks to our proprietary technology "OMP Print Art". In order to outline what spaces are at the customer's disposal for personalization, we show you the exploded view of those areas.



## SAFETY LEVEL COMPARABLE TO FORMULA 1 CARS

**+300% INCREASED RESISTANCE** compared to standard 8858/99, with exclusive technology for maximum resistance and lightness. Upholstering customized on demand. HC/880E seat bracket required (not included).

LARGER SHOULDER  
harness slots



MANUFACTURER: OMP  
MODEL: HTE ONE  
HOM. NO: AS.007.10  
FIA STANDARD: FIA 8862-2009



REMOVABLE CUSHION  
split leg



### HA/761E

LIGHTWEIGHT  
CARBON FIBER  
SHELL

W SIDE FIXING  
POINTS

HANS® COMPATIBLE

FIA 8862-2009

REMOVABLE CUSHIONS  
back, base



Measure in mm  
sizing information on page 124-125

### HTE-ONE XL



### HA/798

Same characteristics  
as HA/761E  
HC/928 seat bracket required  
**XL VERSION**  
**LARGER AND HIGHER**



MANUFACTURER: OMP  
MODEL: HTE ONE XL  
HOM. NO: AS.067.17  
FIA STANDARD: FIA 8862-2009

### HTE-ONE S

### HA/801 NO PICTURE

Same characteristics  
as HA/761E  
**CARBON-FIBERGLASS  
VERSION**



MANUFACTURER: OMP  
MODEL: TBD  
HOM. NO: TBD  
FIA STANDARD: FIA 8862-2009

## SAFETY LEVEL COMPARABLE TO FORMULA 1 CARS

**+300% INCREASED RESISTANCE** compared to standard 8858/99, with exclusive technology for maximum resistance and lightness. Designed to allow installation and comfortable driving position also in GT cars with reduced internal room.

Fire resistant *Airnet* and velour upholstery (customized on demand).

HC/907 seat bracket required (not included).

LARGER SHOULDER  
harness slots



MANUFACTURER: OMP  
MODEL: HRC ONE  
HOM. NO: AS.033.14  
FIA STANDARD: FIA 8862-2009

REMOVABLE CUSHIONS  
back, base, split leg



### HA/789

CARBON FIBER  
SHELL

W SIDE FIXING  
POINTS

HANS® COMPATIBLE

FIA 8862-2009

SIDE HEAD  
protection



Measure in mm  
sizing information on page 152-153

Product financed in cooperation  
with resources POR CRO  
Region of Liguria 2007-2013

## PREIMPREGNATED CARBON FIBER VERSION

COMPLETE WITH NEW AIR COOLING KIT (HC/913) AND PREFORATED BACK CUSHION (HB/703)

Designed to allow installation and comfortable driving position also in GT cars with reduced internal room. Upholstered in high breathability *Airnet* material. Fits in vehicles with compact cockpits.

The velvet side is thought for the application of containment cushion, which are available in 2 sizes (M or S) see on page 127 ref. HB/701



HSC PATENT COMPATIBLE

HA/786/N

LIGHTWEIGHT CARBON FIBER SHELL

W SIDE FIXING POINTS

HANS® COMPATIBLE

HA/788

CARBON FIBER SHELL

W SIDE FIXING POINTS

HANS® COMPATIBLE



MANUFACTURER: OMP  
MODEL: HRC-R AIR  
HOM. NO: CS.293.13  
FIA STANDARD: FIA 8855-1999

PREFORATED CUSHION HB/703

SEAT CUSHION also available in thicker version (50mm) ref. HB/702

DOUBLE LEG CUSHION

Product financed in cooperation with resources POR CRO Region of Liguria 2007-2013



Measure in mm  
sizing information on page 152-153

## CARBON FIBER VERSION

Designed to allow installation and comfortable driving position also in GT cars with reduced internal room. Upholstered in high breathability *Airnet* material. Fits in vehicles with compact cockpits.

The velvet side is thought for the application of containment cushion, which are available in 2 sizes (M or S) see on page 127 ref. HB/701

The base cushion is also available in thicker version (50mm) see on page 127 ref. HB/702



HSC PATENT COMPATIBLE



MANUFACTURER: OMP  
MODEL: HRC-D  
HOM. NO: CS.296.13  
FIA STANDARD: FIA 8855-1999

SEAT CUSHION also available in thicker version (50mm) ref. HB/702

DOUBLE LEG CUSHION

Product financed in cooperation with resources POR CRO Region of Liguria 2007-2013



Measure in mm  
sizing information on page 124-125

## PROFESSIONAL FIBER SEAT

Designed to allow installation and comfortable driving position also in GT cars with reduced internal room. Fire resistant *Airnet* and velour upholstery.



PREDRILLED SHELL FOR AIR COOLING KIT HC/913



HSC PATENT COMPATIBLE

LARGER SHOULDER harness slots



MANUFACTURER: OMP  
MODEL: HRC FIBERGLASS AIR  
HOM, NO: CS.307.14  
FIA STANDARD: FIA 8855-1999

### SEAT CUSHION

also available in higher version (50mm) ref. HB/702

### DOUBLE LEG CUSHION



**HA/793**  
FIBERGLASS SHELL  
W SIDE FIXING POINTS  
HANS® COMPATIBLE

SIDE HEAD protection

REMOVABLE CUSHIONS  
back, base, split leg



Measure in mm  
sizing information on page 124-125

## HRC-R FIBERGLASS XL HA/794

Same characteristics as HA/793  
**XL VERSION LARGER AND HIGHER**



HSC PATENT COMPATIBLE



PREDRILLED SHELL FOR AIR COOLING KIT HC/913



MANUFACTURER: OMP  
MODEL: HRC FIBERGLASS AIR XL  
HOM, NO: CS.313.14  
FIA STANDARD: FIA 8855-1999

sizing information on page 124-125



## PROTOTIPO-R

Seat ideal for GT cars with ultralight carbon shell. Large shoulder harness slots to accommodate various heights. High side bolsters for lateral leg support and maximum protection. Head, back, side, base and splitted leg cushions are removable to allow maximum individual seating comfort. Upholstered entirely in velour. Compatible with Hans device.

LARGE SHOULDER HARNESS SLOTS  
to accommodate various heights



MANUFACTURER: OMP  
MODEL: MCC/PROTOTIPO  
HOM, NO: CS.119.04  
FIA STANDARD: FIA 8855-1999

### REMOVABLE

head - back - lateral and base cushions

HIGH SIDE BOLSTERS  
for lateral leg support

SPLIT LEG RESTS  
to allow maximum individual seating comfort



**HA/745**  
CARBON SHELL  
W SIDE FIXING POINTS  
HANS® COMPATIBLE



Measure in mm  
sizing information on page 124-125



# HTE-R

# HTE-R 400

## PROFESSIONAL RACING SEAT

Upholstered in high breathable *Airnet* material.

SHAPED SAFETY headrest



MANUFACTURER: OMP  
MODEL: HTE FIBERGLASS  
HOM. NO: CS.184.06  
FIA STANDARD: FIA 8855-1999

REMOVABLE CUSHIONS  
back, base, split leg

### HA/772E/N

GEL COATED FIBERGLASS SHELL  
W SIDE FIXING POINTS  
HANS® COMPATIBLE



HSC PATENT COMPATIBLE

IMPROVED BACK SUPPORT



Measure in mm  
sizing information on page 124-125

## PROFESSIONAL RACING SEAT

Upholstered in high breathable *Airnet* material.

SPECIAL VERSION FOR CARS WITH SMALL SPACE IN THE UPPER PART



MANUFACTURER: OMP  
MODEL: HTE 400  
HOM. NO: CS.253.12  
FIA STANDARD: FIA 8855-1999

### HA/780E/N

GEL COATED FIBERGLASS SHELL  
W SIDE FIXING POINTS  
HANS® COMPATIBLE



HSC PATENT COMPATIBLE

400



Measure in mm  
sizing information on page 124-125

### HTE-R XL

### HA/771E/N

Same characteristics as HA/772E  
XL VERSION  
LARGER AND HIGHER

sizing information on page 124-125



HSC PATENT COMPATIBLE



MANUFACTURER: OMP  
MODEL: HTE FIBERGLASS XL  
HOM. NO: CS.230.09  
FIA STANDARD: FIA 8855-1999



# HTE-**R** CARBON

## PROFESSIONAL RACING SEAT

Upholstered in high breathable *Airnet* material.

CARBON FIBER SHELL VERSION



HA/768E/N

CARBON FIBER SHELL  
W SIDE FIXING POINTS

HANS® COMPATIBLE



HSC PATENT COMPATIBLE



Measure in mm  
sizing information on page 124-125



MANUFACTURER: OMP  
MODEL: HTE CARBON  
HOM. NO: CS.146.05  
FIA STANDARD: FIA 8855-1999



# HTE-**R** CARBON XL

## PROFESSIONAL RACING SEAT

Upholstered in high breathable *Airnet* material.

CARBON FIBER SHELL XL VERSION



HA/779E/N

CARBON FIBER SHELL  
W SIDE FIXING POINTS

HANS® COMPATIBLE



HSC PATENT COMPATIBLE



Measure in mm  
sizing information on page 124-125



MANUFACTURER: OMP  
MODEL: HTE CARBON XL  
HOM. NO: CS.162.06  
FIA STANDARD: FIA 8855-1999



# WRC-**R** OMP

## PROFESSIONAL RACING SEAT

Upholstered in high breathable *Airnet* material.

LARGE HARNESS SLOTS



MANUFACTURER: OMP  
MODEL: WRC FIBERGLASS WRE  
HOM. NO: CS.183.06  
FIA STANDARD: FIA 8855-1999

HIGH SIDE BOLSTER  
for lateral leg support



REMOVABLE CUSHIONS



Measure in mm  
sizing information on page 124-125

HA/773E/N

GEL COATED FIBERGLASS SHELL  
W SIDE FIXING POINTS

HANS® COMPATIBLE



HSC PATENT COMPATIBLE



## WRC-**R** CARBON HA/769E/N



Same characteristics as HA/773E  
CARBON FIBER SHELL VERSION



HSC PATENT COMPATIBLE



MANUFACTURER: OMP  
MODEL: WRC CARBON  
HOM. NO: CS.177.06  
FIA STANDARD: FIA 8855-1999

sizing information on page 124-125

## WRC-**R** XL HA/778E/N



Same characteristics as HA/773E  
XL VERSION LARGER AND HIGHER

sizing information on page 124-125



MANUFACTURER: OMP  
MODEL: WRC FIBERGLASS WRE  
HOM. NO: CS.025.01  
FIA STANDARD: FIA 8855-1999



HA/762E/N

FIBERGLASS SHELL  
W SIDE FIXING POINTS  
HANS® COMPATIBLE

### RACING SEAT

Upholstered entirely in velour.

SHAPED SAFETY headrest

LARGE HARNESS SLOTS



HSC PATENT COMPATIBLE



MANUFACTURER: OMP  
MODEL: RS-PT  
HOM, NO: CS.229.09  
FIA STANDARD: FIA 8855-1999

REMOVABLE back and leg cushion

HIGH SIDE BOLSTER for lateral leg support



Measure in mm  
sizing information on page 124-125

HA/774E/N

GEL COATED FIBERGLASS SHELL  
W SIDE FIXING POINTS  
HANS® COMPATIBLE

### PROFESSIONAL RACING SEAT

Entirely upholstered in new high breathability *Airnet* material.



MANUFACTURER: OMP  
MODEL: ARS  
HOM, NO: CS.924.98  
FIA STANDARD: FIA 8855-1999

LARGE HARNESS SLOTS

MEDIUM HEIGHT SIDE BOLSTERS for lateral leg support for higher protection

REMOVABLE back - base - and leg cushion for maximum individual seating comfort

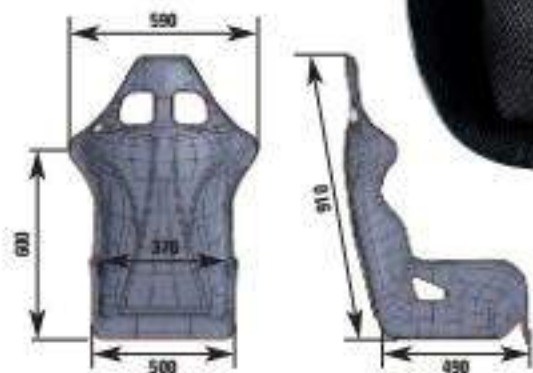

Measure in mm  
sizing information on page 124-125



HSC PATENT COMPATIBLE

## RACING SEAT

Upholstered entirely in velour.



**HA/766E/N**

GEL COATED  
FIBERGLASS SHELL  
W SIDE FIXING  
POINTS  
HANS® COMPATIBLE



HSC PATENT  
COMPATIBLE



MANUFACTURER: OMP  
MODEL: CHAMP  
HOM, NO: CS.826.97  
FIA STANDARD: FIA 8855-1999

### BASE AND SHOULDERS UPHOLSTERED

with anti-slip material to allow  
the maximum adherence to  
the seat

### REMOVABLE

back and leg cushion  
for maximum individ-  
ual seating comfort



Measure in mm  
sizing information on page 124-125

## ENTRY LEVEL SEAT

Made of fiberglass shell, large  
shoulder harness slots to  
accommodate various heights.  
Entirely upholstered.  
Excellent quality/price ratio.

### LARGE HARNESS SLOTS



MANUFACTURER: OMP  
MODEL: FIRST-R  
HOM, NO: CS.183.06  
FIA STANDARD: FIA 8855-1999

### FIBERGLASS SHELL

### REMOVABLE CUSHION

**HA/790/N**

FIBERGLASS  
SHELL  
W SIDE FIXING  
POINTS  
HANS® COMPATIBLE



HSC PATENT  
COMPATIBLE



Measure in mm  
sizing information on page 124-125

# TRS-X

## RACING SEAT

Tubular steel frame. Excellent quality/price ratio. Exclusive design thanks to modern shape and fresh fluo yellow details. The optimized dimensions allows to mounting the seat also in cars with reduced inner room and the ergonomic is designed to guarantee the best individual seat comfort and an high lateral support Upholstered entirely in velour.

**NEW!**

HA/803/NGI

TUBULAR  
STEEL FRAME

W SIDE AND Y  
BOTTOM FIXING  
POINTS

HANS® COMPATIBLE

**FIA APPROVED**

MANUFACTURER: OMP  
MODEL: TRS-X  
HOM. NO: TBD  
FIA STANDARD: FIA 8855-1999

LARGE HARNESS SLOTS

MEDIUM HEIGHT SIDE  
BOLSTERS

for lateral leg support  
for higher protection

REMOVABLE

back - base - and leg  
cushion for maximum  
individual seating comfort

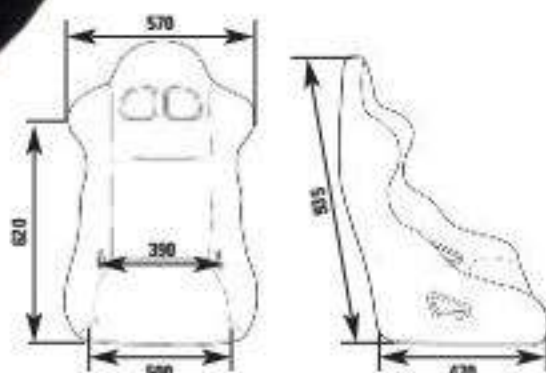

Measure in mm  
sizing information on page 124-125



# TR5-E PLUS

## VINYL RACING SEAT

Entirely upholstered in decorated vinyl. Excellent quality/price ratio.

LARGE HARNESS SLOTS

**FIA APPROVED**

MANUFACTURER: OMP  
MODEL: T-RS  
HOM. NO: CS.243.10  
FIA STANDARD: FIA 8855-1999



HA/744E/BW Blue/white



HA/744E/NW Black/white

### REMOVABLE LEG CUSHION

rests to allow maximum individual seating comfort



HA/744E/RW Red/white

MEDIUM HEIGHT SIDE BOLSTERS  
for lateral leg support for higher protection

## HA/744E

TUBULAR STEEL FRAME  
W SIDE AND Y BOTTOM FIXING POINTS

HANS® COMPATIBLE



HSC PATENT COMPATIBLE

# TR5-E

## RACING SEAT

Entirely upholstered in jacquard velour. Excellent quality/price ratio.

LARGE HARNESS SLOTS

**FIA APPROVED**

MANUFACTURER: OMP  
MODEL: T-RS  
HOM. NO: CS.243.10  
FIA STANDARD: FIA 8855-1999



HA/741E/R Red



HA/741E/N Black

### REMOVABLE LEG CUSHION

rests to allow maximum individual seating comfort



HA/741E/B Blue

MEDIUM HEIGHT SIDE BOLSTERS  
for lateral leg support for higher protection

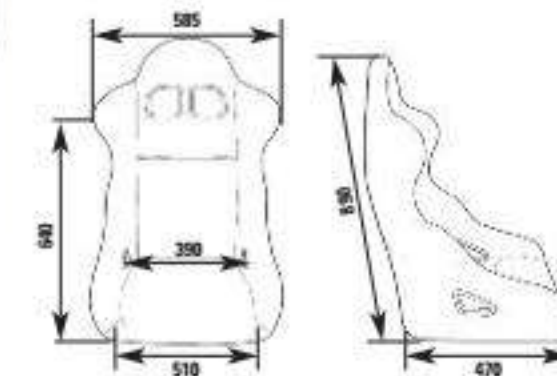

Measure in mm  
sizing information on page 124-125

## HA/741E

TUBULAR STEEL FRAME  
W SIDE AND Y BOTTOM FIXING POINTS

HANS® COMPATIBLE



HSC PATENT COMPATIBLE

## TR5-E SKY

## HA/760E/N



sizing information on page 124-125



HSC PATENT COMPATIBLE

Same characteristics as HA/744E  
**ONE COLOUR SKY VERSION**  
upholstered in black vinyl

**FIA APPROVED**

MANUFACTURER: OMP  
MODEL: T-RS  
HOM. NO: CS.243.10  
FIA STANDARD: FIA 8855-1999

## TR5-E XS

## HA/783E/N



sizing information on page 124-125



HSC PATENT COMPATIBLE

Same characteristics as HA/741E  
**SMALL SIZE APPROVED**

**FIA APPROVED**

MANUFACTURER: OMP  
MODEL: TRS-XS  
HOM. NO: CS.292.13  
FIA STANDARD: FIA 8855-1999

## TR5-E XL

## HA/781E/N



sizing information on page 124-125



HSC PATENT COMPATIBLE

Same characteristics as HA/741E  
(only W side fixing points)  
**LARGE SIZE APPROVED**

**FIA APPROVED**

MANUFACTURER: OMP  
MODEL: TRS-XL  
HOM. NO: CS.271.12  
FIA STANDARD: FIA 8855-1999

The following measurements are given as a guide. Actual measurements may vary to accommodate production. Seat fitting type: according to FIA regulations the seat must be fixed to the brackets by means of at least four bolts M8 class 8.8. The diagram shows the distances between the fixing points in mm. \*\* the weight refers to the complete seat (tolerance of 10%). \*\* referring to bottom fixing points of the sliding guide.

TYPE W: inner side int. 289 mm TYPE Y: bottom 345x270 mm

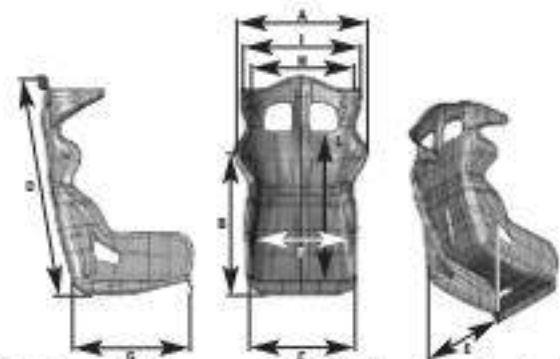
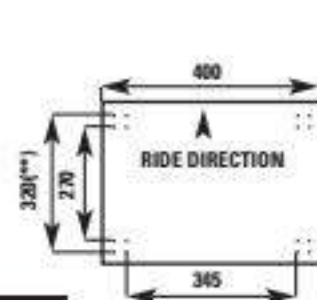

### LEGEND

- A external max width at shoulders
  - B seat bottom to mid shoulders
  - C seat bottom max external width
  - D total height of seat back
  - E external max width at seat fixing inserts
  - F seat inner width (belt holes area)
  - G bottom length
  - H internal width between side head protections
  - I external width between side head protections
  - L height from the bottom to the harness slot
- W = side fixing Y = bottom fixing

HOMOLOG.	SHELL	AIRNET MATERIAL	CUSHIONS SPLIT LEG	A	B	C	D	E	F	G	H	I	L	HARNES SLOTS	WEIGHT* (KG)	FIXING	
<b>HTE ONE HA/761E</b>																	
FIA 8862/2009	CARBON		✓	625	620	490	890	380	365	480	365	500	655	5	9.2	W	
<b>HTE ONE XL HA/798</b>																	
FIA 8862/2009	CARBON		✓	680	580	490	970	400	390	515	370	520	700	5	9.9	W	
<b>HRC-ONE HA/789</b>																	
FIA 8862/2000	CARBON	✓	✓	615	635	455	900	405	365	470	345	460	630	5	9.2	W	
<b>HRC-R CARBON AIR HA/786</b>																	
FIA 8855/1999	CARBON	✓	✓	615	635	460	890	395	365	470	345	490	620	5	6.2	W	
<b>HRC-R FIBERGLASS AIR HA/793</b>																	
FIA 8855/1999	FIBERGLASS	✓	✓	620	635	470	900	390	365	470	370	530	620	5	9.5	W	
<b>HRC-R FIBERGLASS AIR XL HA/794</b>																	
FIA 8855/1999	FIBERGLASS	✓	✓	610	680	490	980	425	400	480	360	520	675	5	10.3	W	
<b>HRC-R CARBON HA/788</b>																	
FIA 8855/1999	CARBON	✓	✓	615	635	460	890	395	365	470	345	490	620	5	5.8	W	
<b>PROTOTIPO HA/745</b>																	
FIA 8855/1999	CARBON	✓	✓	530	520	440	790	385	380	480	360	450	570	5	6.1	W	
<b>HTE-R HA/772E</b>																	
FIA 8855/1999	FIBERGLASS	✓	✓	560	570	515	880	420	390	490	315	480	665	5	9.4	W	
<b>HTE-R 400 HA/780E</b>																	
FIA 8855/1999	FIBERGLASS	✓	✓	560	570	515	880	420	390	490	310	420	665	5	10.2	W	
<b>HTE-R XL HA/771E</b>																	
FIA 8855/1999	FIBERGLASS	✓	✓	580	610	530	920	440	415	550	305	485	705	5	10.5	W	
<b>HTE-R CARBON HA/768E</b>																	
FIA 8855/1999	CARBON	✓	✓	545	560	465	880	390	370	470	330	490	665	5	6.6	W	
<b>HTE-R CARBON XL HA/779E</b>																	
FIA 8855/1999	CARBON	✓	✓	560	580	485	890	425	390	490	330	490	665	5	6.8	W	

HOMOLOGATION	SHELL	AIRTEX® MATERIAL	CUSHIONS SPLIT LEG	MEASURE IN MM												HARNES SLOTS	WEIGHT* (KG)	FIXING	
				A	B	C	D	E	F	G	H	I	L						
<b>WRC-R HA/773E</b>																			
FIA 8855/1999	FIBERGLASS	✓	✓	620	600	510	890	410	390	480	/	/	645	5	8.8	W			
<b>WRC-R CARBON HA/769E</b>																			
FIA 8855/1999	CARBON	✓	✓	590	600	495	890	400	365	490	/	/	645	5	5.6	W			
<b>WRC-R XL HA/778E</b>																			
FIA 8855/1999	FIBERGLASS	✓	✓	665	600	520	920	430	415	480	/	/	700	5	10.7	W			
<b>ARS-R HA/774E</b>																			
FIA 8855/1999	FIBERGLASS	✓		590	600	500	910	395	370	490	/	/	615	5	8.9	W			
<b>ARS-R CARBON HA/770E</b>																			
FIA 8855/1999	CARBON	✓		585	600	480	890	380	360	490	/	/	635	5	5.8	W			
<b>RS-PT. 2 HA/762E</b>																			
FIA 8855/1999	FIBERGLASS			565	560	510	880	420	395	480	340	510	675	5	10.4	W			
<b>CHAMP-R HA/766E</b>																			
FIA 8855/1999	FIBERGLASS			590	575	520	890	400	360	480	/	/	615	5	8.8	W			
<b>TRS-E PLUS HA/744E</b>																			
FIA 8855/1999	TUBULAR STEEL			585	640	510	890	410	390	470	/	/	600	5	10.3	W Y			
<b>TRS-E SKY HA/780E / TRS LEGEND HA/775</b>																			
FIA 8855/1999	TUBULAR STEEL			585	640	510	890	410	390	470	/	/	600	5	10.8	W Y			
<b>TRS-E HA/741E</b>																			
FIA 8855/1999	TUBULAR STEEL			585	640	510	890	410	390	470	/	/	600	5	10.3	W Y			
<b>TRS-E XS HA/783E</b>																			
FIA 8855/1999	TUBULAR STEEL			520	600	420	870	395	330	470	/	/	575	5	10.2	W Y			
<b>TRS-E XL HA/781E</b>																			
FIA 8855/1999	TUBULAR STEEL			625	680	540	950	450	415	520	/	/	655	5	12.3	W			
<b>FIRST-R HA/790</b>																			
FIA 8855/1999	FIBERGLASS			620	600	510	890	410	390	480	/	/	630	5	8.9	W			
<b>TRS-X HA/803</b>																			
FIA 8855/1999	TUBULAR STEEL			570	620	500	935	410	390	470	/	/	600	5	10.8	W Y			

# AIR COOLING KIT

HC/913

## COOLING COMFORT

New air cooling kit to be mounted on predrilled seat shell (all OMP "Air" seats). This system give a new level of cooling comfort to the drivers specially during long races in very hot condition.



The kit includes:

- a shell to be mounted on the the back of the seat with included shaped bihadesive tape (HC/913/G)
- a connection hose (1,5" x 2mt) with inner metal spiral (HC/913/T) that can be fixed to the shell and to the blower HC/914 or to others air sources (inner intake of the car)
- a connection junction in rubber (HC/913/R)
- 45° connection junction in rubber (HC/913/R45)

All components are sold also separately as spare parts.

## BACK CUSHION

HB/703

Preforated back cushion to allow the best cooling effect of OMP air cooling system HC/913. Airennet material.

2 SIZES:  
**M** for HRC Fiberglass (HA/793)  
**XL** for HRC Fiberglass XL (HA/794)



## AIR BLOWER

HC/914

for Air Cooling Kit HC/913



## RACING OPTIONS ACCESSORIES

### LATERAL PAIR CUSHIONS

HB/701 For HRC seats. Sizes: S, M  
 Velour material.



### LEG CUSHIONS

HB/698 Performed leg support cushions.  
 Airennet material.



### LEG CUSHIONS

HB/700 2 pieces flat leg support cushions.  
 Airennet material.



### SEAT CUSHIONS

HB/702 Thicker seat cushions for HRC seat.  
 Antislip velvet.



### SEAT CUSHIONS

REMOVABLE SEAT CUSHIONS to be set with velcro only on velour upholstered seats.

Foamed resin, velour upholstered.  
 Colour: black.

A Back support cushion, small HB/692

B Lumbar support cushion, medium HB/662

C Seat cushion HB/695

D Leg support cushion HB/693



### HSC PATENT

HC/893 Adjustable aluminium cover for 3 safety belt's positions setting.  
 PATENTED



### HEAD CUSHION

HB/699 Velour material.





# BRACKETS

## SIDE MOUNT BRACKET DIMENSIONS

The dimensions are in mm.

BRACKET	Lowest rear mounting hole "A"	Rear range "B"	Front range "C"	Lowest front mounting hole "D"	Type of bolt pattern	Length of mounting plate "E"	Width of mounting plate "F"	Longitudinal range "G"	Number of holes
HC/731E	110	34.5	93	70.5	B	380	45	75	4
HC/733E	109	17	94	70.5	A	350	52	25	3
HC/830	77	66	66	77	B	495	48.5	126	6
HC/833E	112	51	108	73.5	A	422.5	59	112.5	10
HC/922	85	81	81	85	B	400	52	75	4
HC/923	75,5	100	100	75,5	B	495	50	125	6
HC/924	85	81	81	85	B	400	52	75	4
HC/925	75,5	100	100	75,5	B	495	50	125	6

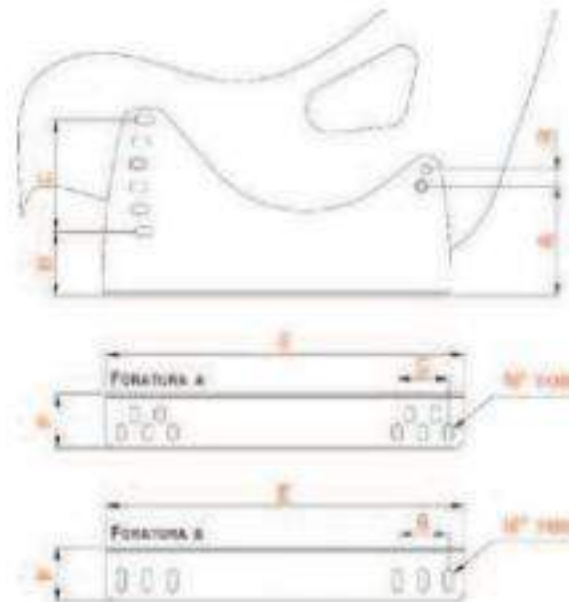

## DUAL ROW LOWER MOUNTING HOLES "A"

The contours of the OMP brackets have been designed so as not to interfere with the lap belt openings, edges or bottom of the seat.



## STEEL BRACKET FIA APPENDIX J art. 253

### HC/733E

Low model. Steel.  
Length: 350 mm  
Thickness: 3 mm  
Ultra strong material.



## STEEL BRACKET FIA APPENDIX J art. 253

### HC/923

Tall model. Steel.  
Length: 495 mm  
Thickness: 3 mm  
Ultra strong material.



## SINGLE ROW LOWER MOUNTING HOLES "B"

The multi-hole height/angle adjustment pattern of OMP brackets has been optimized to allow up to 21° of inclination, allowing for practically any height/angle mounting combination.

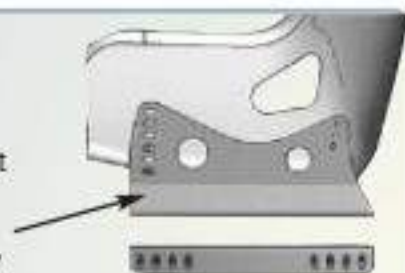

## ALUMINIUM BRACKET FIA APPENDIX J art. 253

### HC/925

Tall model. Aluminium.  
Length: 495 mm  
Thickness: 6 mm  
Ultra strong material.



## ALUMINIUM BRACKET FIA APPENDIX J art. 253

### HC/833E

Tall model. Aluminium.  
Length: 422.5 mm  
Thickness: 6 mm  
HC/833E Aluminium  
HC/833E/N Black



## SEAT BRACKET

### HC/880

In compliance with FIA 8862-2009 rule and mandatory for the mounting of the HTE-ONE E seat; supplied with bolts M12. Steel. Thickness: 5 mm (no picture)

## SEAT BRACKET Product financed in cooperation with resources POR CRO Region of Liguria 2007-2013

### HC/907

Pair of professional seat bracket in compliance with FIA 8862-2009 rule and mandatory for mounting new HRC-ONE seat (HA/789). Supplied with bolts and nuts. Entirely made of Ergal. (no picture)

## STEEL BRACKET FIA APPENDIX J art. 253

### HC/922

Tall model. Steel.  
Length: 400 mm  
Thickness: 3 mm  
Ultra strong material.



## STEEL BRACKET FIA APPENDIX J art. 253

### HC/731E

Tall model. Steel.  
Length: 380 mm  
Thickness: 3 mm  
Ultra strong material.



## ALUMINIUM BRACKET FIA APPENDIX J art. 253

### HC/924

Tall model. Aluminium.  
Length: 400 mm  
Thickness: 6 mm  
Ultra strong material.



## ALUMINIUM BRACKET FIA APPENDIX J art. 253

### HC/830

Tall model equipped with a damper. Aluminium. Patented model.  
Length: 495 mm  
Thickness: 6 mm



## DAMPING ELEMENT

to reduce vertical loads on the driver.  
Suitable for off-road.

## SEAT BRACKET

### HC/928 for HTE ONE XL

## LOWER MOUNTING HOLES "C"

## STEEL BRACKET

### HC/665

Sliding rail kit to be mounted between the brackets and the seat. Steel. Not FIA approved.



## STEEL BRACKET

### HC/660

Pair of "L" shaped brackets to fit seats with lower attachment points (type Y) to side brackets. Steel. Thickness: 3 mm



## UNIVERSAL SEAT SUBFRAME

### HC/879

€ 79,00 (C)

Weld-in universal seat subframe to be adapted to the shell of the vehicle.  
Two 35mm squared pipes.  
Length: 600 mm  
4 plates for direct welding to the body (80x60 thickness 3 mm).  
4 plates for direct welding to the tube (60x40 thickness 3 mm).  
4 buckles for welding M8.



## ALUMINIUM UNIVERSAL BRACKET

### HC/666

Universal couple of brackets for seat with lower attachments. Aluminium. Not FIA approved.



# CLASSIC

## SEAT

### '70s REVIVAL VINTAGE SEAT

Upholstered in faux leather and velvet.

ADJUSTABLE VELVET HEADREST  
for greater comfort

FAUX LEATHER SIDES



RAISED BACKREST  
and velvet seat

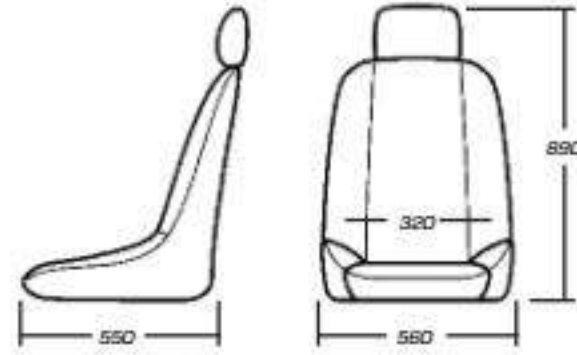

Measure in mm

HA/737E

TUBULAR STEEL FRAME  
M8 LOWER FIXING  
POINTS 345X270 MM Y

# SILVERSTONE

## SEAT

### VINTAGE SEAT SPECIFIC FOR OPEN CARS

Upholstered in faux leather.

FAUX LEATHER SEAT  
and back with  
horizontal quilting.

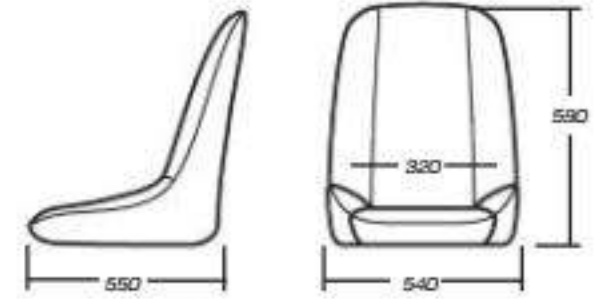

Measure in mm

HA/756/N

TUBULAR STEEL FRAME  
M8 LOWER FIXING  
POINTS 345X270 MM Y

# BRANDSHATCH

## SEAT

### VINTAGE '60s STYLE SEAT

Upholstered in faux leather and velvet.

ADJUSTABLE VELVET HEADREST  
for greater comfort

FAUX LEATHER SIDES



RAISED BACKREST  
and velvet seat

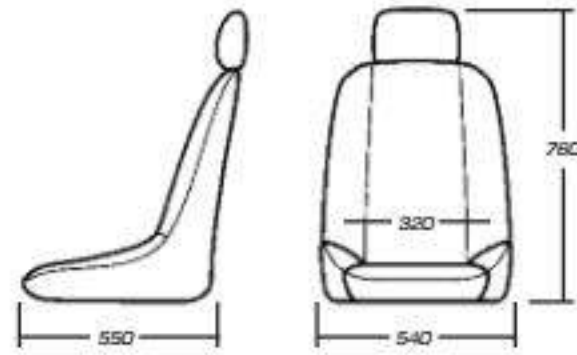

Measure in mm

HA/757/N

TUBULAR STEEL FRAME  
M8 LOWER FIXING  
POINTS 345X270 MM Y

# TRS - LEGEND

## SEAT

### SEAT FIA HOMOLOGATED

Completely covered in faux leather with contrast stitching.



MANUFACTURER: OMP  
MODEL: T-RS  
HOM. NO: CS.243.10  
FIA STANDARD: FIA 8855-1999

LEG CUSHION  
for greater comfort.



LARGE SHOULDER  
HARNES SLOTS  
to accommodate  
various heights.

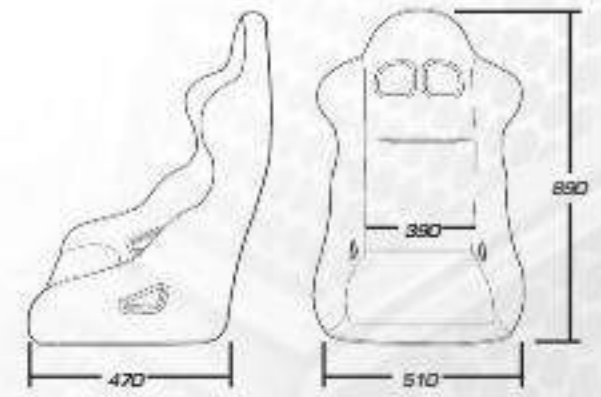

Measure in mm

HA/775/N

TUBULAR STEEL FRAME  
HOMOLOGATION  
FIA 8855-1999  
W SIDE AND Y BOTTOM  
FIXING POINT  
HANS® COMPATIBLE



# OMP RAID 2

# SEAT

HA/776T/N

**BREATHABLE FABRIC**  
 Reclinable seat for off-road cars. Quick-tilting mechanism for simple rear seat access.

STEEL FRAME Y BOTTOM  
 FIXING POINTS 345X270 MM  
 SYNTHETIC LEATHER INSERTS

SYNTHETIC CARBON LOOK LEATHER REINFORCEMENTS on the sides

UPHOLSTERED in texture fabric and synthetic leather.

HA/776E/N

**SKY VERSION**  
 Washable sky upholstery with synthetic carbon look leather reinforcements on the sides.



Measure in mm

## BRACKETS

HC/830

Aluminium brackets. Tall model equipped with a damper. Patented model. Length: 495 mm Thickness: 6 mm



DAMPING ELEMENT to reduce vertical loads on the driver

FIA APPENDIX J - ART. 253

## AIR CUSHION

HB/665/CA

Air cushion seat, upholstered in black synthetic leather, pressurizing valve on the front for easy adjustment. Adaptable to any seat, best in cases of high stress as in off-road and speedboat.



# STYLE

# SEAT

HA/719E/N

TESTED AND COMPLYING WITH  
DIRECTIVE 96/37/CE

TUBULAR STEEL

M8 Y BOTTOM FIXING POINTS

345X270 MM

3 SEAT BELT OPENINGS

UPHOLSTERED IN A TEXTURED FABRIC "A-TEX EVO"

abrasion resistant, comfortable  
in hot or cold conditions,  
thickness: 3 mm

ANATOMIC SHAPE



PRECISION RECLINING  
MECHANISM

and quick-tilting  
mechanism to facilitate  
rear seat access

# DESIGN 2

# SEAT

HA/736E/N

TESTED AND COMPLYING WITH  
DIRECTIVE 96/37/CE

TUBULAR STEEL

M8 Y BOTTOM FIXING POINTS

345X270 MM

2 SEAT BELT OPENINGS

UPHOLSTERED IN A TEXTURED FABRIC "A-TEX EVO"

abrasion resistant, comfortable  
in hot or cold conditions,  
thickness: 3 mm

HIGH SIDE



PRECISION RECLINING  
MECHANISM

and quick-tilting  
mechanism to facilitate  
rear seat access

# STRADA

# SEAT

HA/750/N

TUBULAR STEEL

M8 Y BOTTOM FIXING POINTS

345X270 MM

2 SEAT BELT OPENINGS

UPHOLSTERED IN A TEXTURED FABRIC "A-TEX EVO"

abrasion resistant, comfortable  
in hot or cold conditions,  
thickness: 3 mm



HIGH SIDE

PRECISION RECLINING  
MECHANISM

and quick-tilting  
mechanism to facilitate  
rear seat access

# RALLYE

# SEAT

HA/728E/N

TUBULAR STEEL

M8 FIXING POINTS Y BOTTOM

345X270 MM

W SIDE 289 MM

4 SEAT BELT OPENINGS

UPHOLSTERED IN A TEXTURED FABRIC "A-TEX EVO"

abrasion resistant, comfortable  
in hot or cold conditions,  
thickness: 3 mm



REMOVABLE LEG CUSHION

# SEATS TECHNICAL SPECIFICATIONS

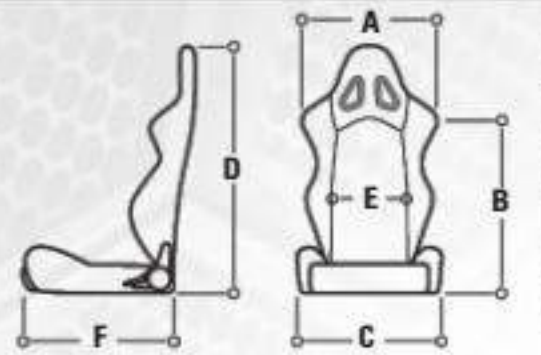

## LEGEND

- A ext. max width at shoulders
- B seat bottom to mid shoulders
- C ext. max width of side bolsters
- D tot. height of seat back
- E inner width between lateral torso protections
- F bottom length
- W = side fixing (289 mm)
- Y = bottom fixing (345x270 mm)

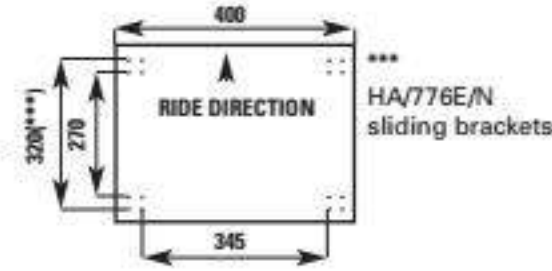

SHELL	MEASURE IN MM						HARNESSESLOT	FIXING	Image
	A	B	C	D	E	F			
<b>STYLE / RAID2</b>									
Tubular steel	560	630	510	970	300	560	3	Y	 HA/719E/N
<b>DESIGN 2</b>									
Tubular steel	540	640	510	950	310	560	3	Y	 HA/736E/N
<b>STRADA</b>									
Tubular steel	540	640	510	950	310	560	2	Y	 HA/750/N
<b>RALLYE</b>									
Tubular steel	580	610	490	900	350	480+22	4	W+Y	 HA/728E/N

# SEAT MOUNTING EXAMPLES

## Seat with lower attachments points

- 1 Sliding brackets (HC/665)
- 2 Optional seat bracket spacer (HC/857 or HC/858)
- 3 Seat mounting bracket (vehicle specific)

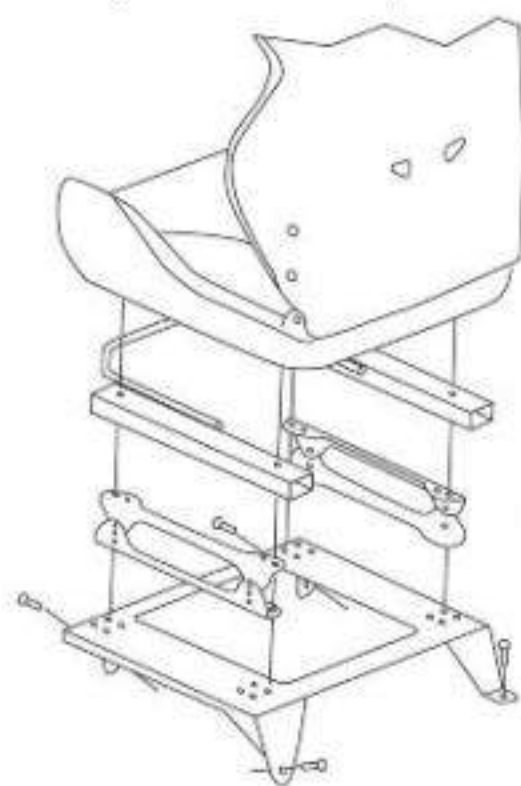

## Seat with side attachments points

- 1 Side mounting brackets (Racing)
- 2 Sliding brackets (HC/665)
- 3 Seat mounting bracket (vehicle specific)

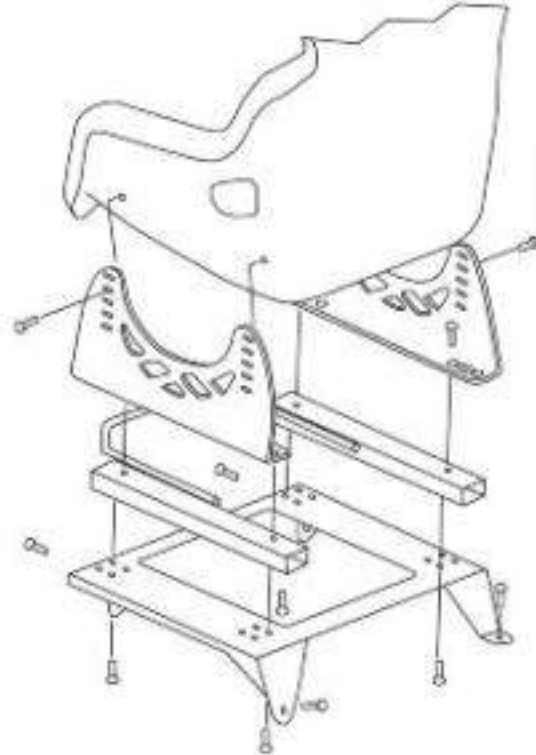

# SEAT BRACKETS

## HC/665

Universal sliding rail kit to be mounted between seat and seat bracket.



Seat mounting brackets.



## HC/857

Seat bracket spacer allows the seat height to be adjusted, depending on which side is used for mounting.

Height: + 25 mm or + 50 mm above the vehicle specific adaptor.

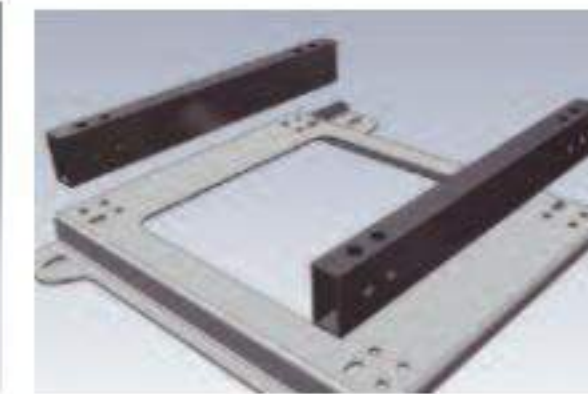

## HC/858

Seat bracket spacer to consent seat adjustment.

Height: + 50 mm, + 62 mm and + 75 mm respect to the vehicle specific adaptor.

Inclination: 2.5° or 5° seat angle adjustments.





# SAFETY HARNESSES





**RACING**

PAG 142



**OFF ROAD**

PAG 164



**TUNING**

PAG 165

# COMPETITION HARNESS TECHNICAL FEATURES



Lightweight buckle with anti-unwitting opening system. FIA 8853/2016



Lightweight buckle. FIA 8853/98



Lightweight steel snap hook



Lightweight steel carabiner.



Plate attachment.



Professional ultra lightweight quick release adjuster made of high strength forged aluminum, designed to minimize the weight and slipping of the webbing, ergonomic and compact.



Professional ultra lightweight quick release adjuster made of high strength forged aluminum, designed to minimize the weight and slipping of the webbing, ergonomic and compact.



Professional lightweight quick release adjuster made of high strength forged aluminum, designed to minimize the weight and slipping of the webbing, ergonomic and compact.



Snap hook attachment made of steel with high mechanical strength designed to improve performance and for optimum safety.



Webbing end sewn specifically for formula cars attach.



Homologated for direct attachment to roll bars.



Exclusive double pin T-bar crotch attachment.



Lightweight quick release adjuster made of steel and high strength aluminum, ergonomic and compact.



Professional adjuster made of high strength steel.



Buckle fixed to the lap strap.



Buckle fixed to the crotch strap.



Runner for fixing intercom connectors.



Ultra lightweight *Dyneema*®, the world strongest fiber™ straps with comfortable webbings.



Lightweight polyester straps with comfortable webbings.



Runner for use with rubber bands - specifically for GT cars.





# SALOON

## 0102 HSL

DA0102HSL

SALOON  
6 POINTS  
FHR ONLY



MANUFACTURER: OMP  
MODEL: DA0102  
HOM. NO. SH.025.17-T-6  
FIA STANDARD: FIA 8853/2016







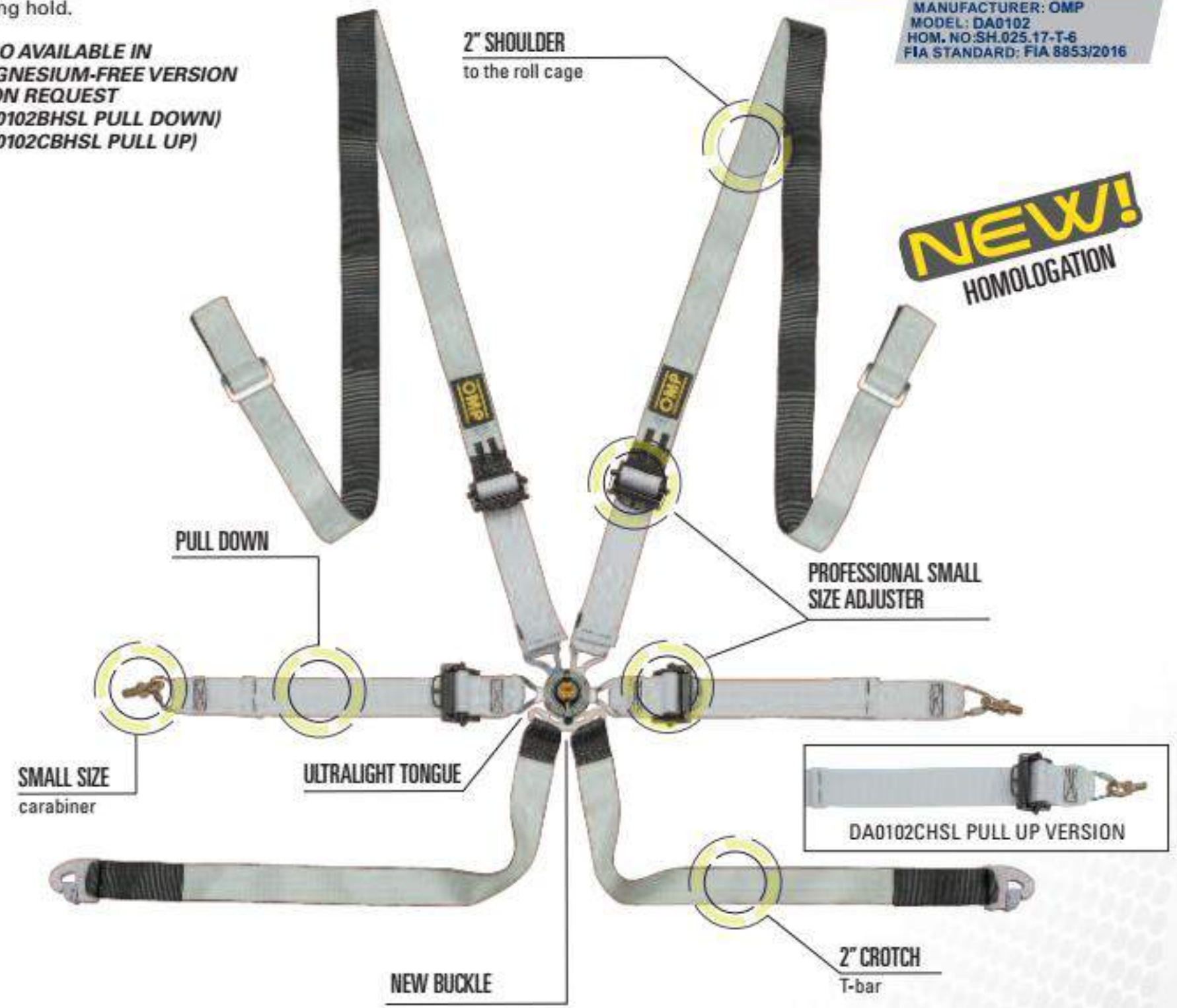

### SALOON PULL DOWN OR PULL UP

Ultralightweight and comfortable safety harness for saloon cars in *Dyneema*<sup>®</sup>, the world strongest fiber™. Forged aluminium ultralight adjusters, buckle in ergal machined from solid and magnesium. The Harness ensures best safety level ever thanks to the ultra-resistant buckle with an anti-unwitting opening system and exclusive double pin T-bar crotch attachments. Adjustable setting of shoulder and lap straps with exclusive F1-inspired "double fold" system for a practical and strong hold.

ALSO AVAILABLE IN  
MAGNESIUM-FREE VERSION  
UPON REQUEST  
(DA0102BHSL PULL DOWN)  
(DA0102CBHSL PULL UP)



**NEW!**  
HOMOLOGATION

-  ULTRALIGHT DYNEEMA **I**
-  PROFESSIONAL ULTRA LIGHTWEIGHT ADJUSTER **C**
-  LIGHTWEIGHT STEEL CARABINER **N**
-  NEW BUCKLE **A**
-  FIXING INTERCOM CONNECTORS **U**
-  LIGHTWEIGHT STEEL SNAP HOOK **M**
-  HOMOLOGATED FOR ROLL BAR **R**
-  EXCLUSIVE DOUBLE PIN T-BAR CROTCH ATTACHMENT **F**

# O203 HSL

SUPERLIGHT PROFESSIONAL SAFETY BELT

PULL UP

DA0203HSL061

Red



**FIA APPROVED**

MANUFACTURER: OMP  
MODEL: DA0203  
HOM. NO.SH.026.17-T-6  
FIA STANDARD: FIA 8853/2016



DA0203HSL071  
Black

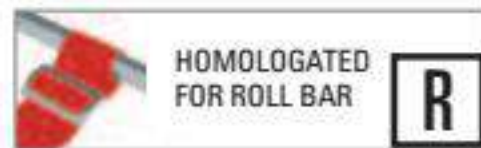

# O202 HSL

SUPERLIGHT PROFESSIONAL SAFETY BELT

PULL DOWN

DA0202HSL061

Red



**FIA APPROVED**

MANUFACTURER: OMP  
MODEL: DA0202  
HOM. NO.SH.012.17-T-6  
FIA STANDARD: FIA 8853/2016

NEW BUCKLE



DA0202HSL071  
Black



# 0204 H

## PROFESSIONAL SAFETY BELT - PULL UP

PLEASE SEE ALSO DA802HF MODEL ON PAGE 155  
SAME FEATURES, FIA 8853/98 HOMOLOGATION  
SAME QUALITY AT LOWER PRICE

2/3"  
shoulder straps to be  
used only with the FHR  
System

### DA0204H

SALOON  
6 POINTS  
FHR ONLY



**DA0204H178**  
Black/fluo yellow

**NEW!**  
HOMOLOGATION

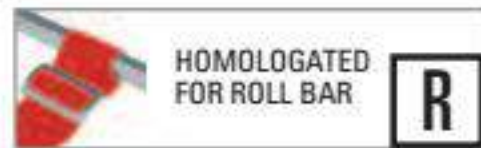

# 0204

## PROFESSIONAL SAFETY BELT

### PULL UP

### DA0204

SALOON  
6 POINTS  
FHR FRIENDLY

3"  
shoulder straps FHR  
System friendly



**DA0204061**  
Red

**NEW!**  
HOMOLOGATION



# 0027 HSL

DA0027HSL

## WRC BELTS

Ultra light, ultra comfortable webbing, making use of *Dyneema®*, the world strongest fiber™. While vehicle engineers will appreciate the weight saving, drivers appreciate the softness of the webbing and the comfort they offer. Lightened camlock buckle. For use with FHR.

ALSO AVAILABLE IN MAGNESIUM-FREE VERSION



SALOON  
6 POINTS  
FHR ONLY



ULTRALIGHT DYNEEMA <b>I</b>	ULTRA PROFESSIONAL LIGHTWEIGHT ADJUSTER <b>D</b>	ULTRALIGHT ADJUSTER, ENDURANCE VERSION <b>C</b>
SNAP HOOK <b>M</b>	SMALL SIZE CARABINER <b>N</b>	HOMOLOGATED FOR ROLL BAR <b>R</b>
PROFESSIONAL ULTRA LIGHTWEIGHT ADJUSTER <b>C</b>	LIGHTWEIGHT <b>B</b>	LIGHTWEIGHT POLYESTER STRAPS <b>L</b>
BUCKLE FIXED TO THE CROTCH STRAP <b>T</b>	FIXING INTERCOM CONNECTORS <b>U</b>	

# 0036 HSL

DA0036HSL

## WRC BELTS

Ultralight and comfortable saloon harness, ideal for rallies, making use of *Dyneema®*, the world strongest fiber™. Crotch and lap straps in Dyneema® fabric and shoulder straps in white polyester. For use with FHR.



SALOON  
6 POINTS  
FHR ONLY

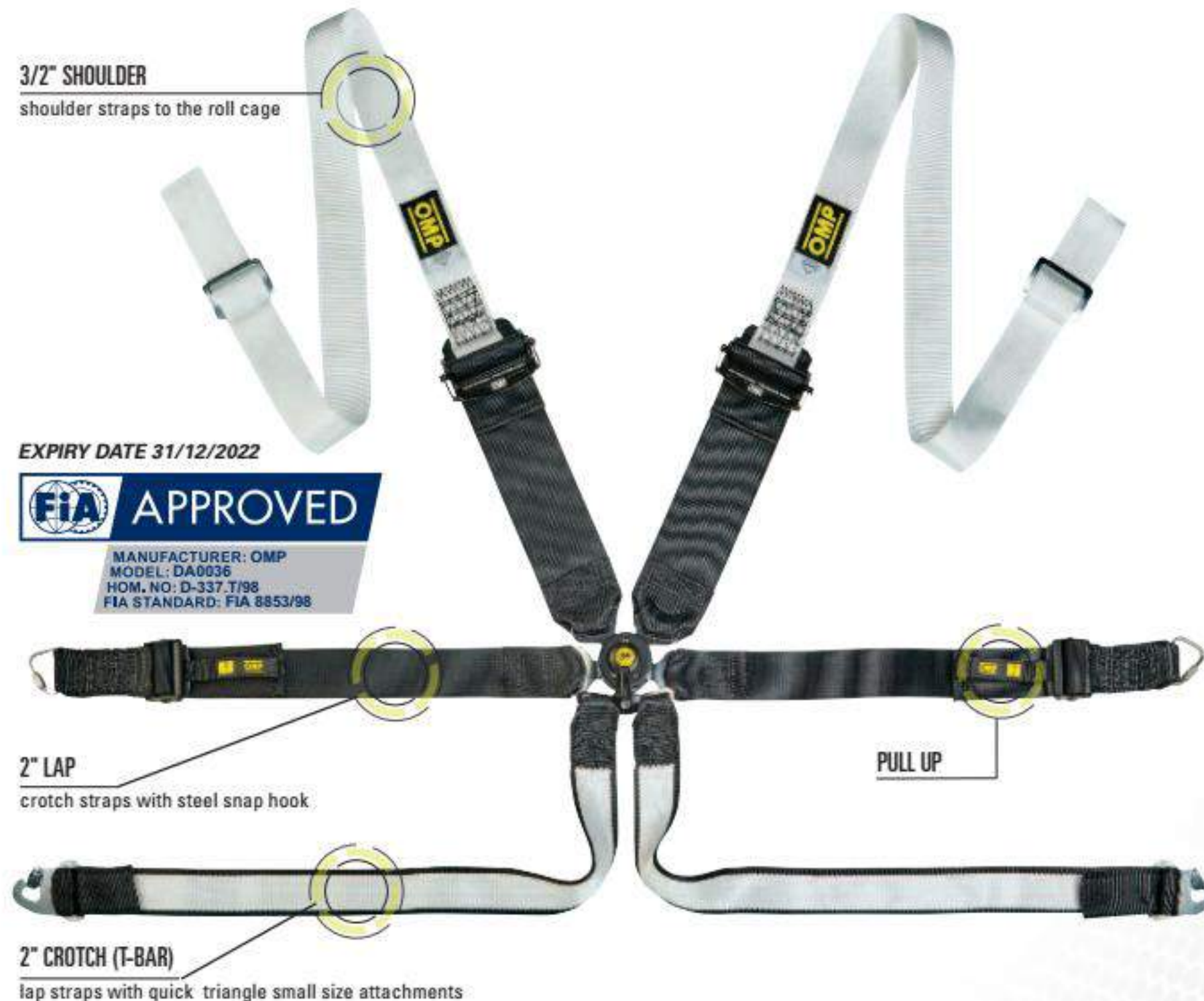

ULTRALIGHT DYNEEMA <b>I</b>	ULTRA PROFESSIONAL LIGHTWEIGHT ADJUSTER <b>D</b>	ULTRALIGHT ADJUSTER, ENDURANCE VERSION <b>C</b>
SNAP HOOK <b>M</b>	SMALL SIZE CARABINER <b>N</b>	HOMOLOGATED FOR ROLL BAR <b>R</b>
PROFESSIONAL ULTRA LIGHTWEIGHT ADJUSTER <b>C</b>	LIGHTWEIGHT BUCKLE <b>B</b>	LIGHTWEIGHT POLYESTER STRAPS <b>L</b>
BUCKLE FIXED TO THE CROTCH STRAP <b>T</b>	FIXING INTERCOM CONNECTORS <b>U</b>	

# 805 HLPF

# 806 F

**LIGHT PROFESSIONAL BELT**  
(pull-down convertible  
in pull-up)

**DA805HLPF**

SALOON  
6 POINTS  
FHR ONLY

**PROFESSIONAL  
LIGHTWEIGHT BELT**

**DA806F**

SALOON  
6 POINTS  
FHR ONLY

2/3"  
shoulder straps to be  
used only with the FHR  
System

2/3"  
shoulder straps to be  
used only with the FHR  
System

DA805HLPF61 Red

DA806F61  
Red

2"  
lap strap with ultrafast adjuster  
(pull-down convertible in pull-up)

2" T-TYPE  
crotch strap

PULL-UP 3"  
lap strap

2" T-TYPE  
crotch strap

EXPIRY DATE 31/12/2022



MANUFACTURER: OMP  
MODEL: DA805 LEGGERA  
HOM. NO: D-257.T/98  
FIA STANDARD: FIA 8853/98

DA805HLPF71  
Black



ALSO AVAILABLE WITH  
PLATE CROTCH STRAP  
ATTACHMENTS REF.  
DA/805HLPFGT71 (black)  
DA/805HLPFGT61 (red)

EXPIRY DATE 31/12/2022



MANUFACTURER: OMP  
MODEL: DA806  
HOM. NO: D-254.T/98  
FIA STANDARD: FIA 8853/98

DA806F71  
Black

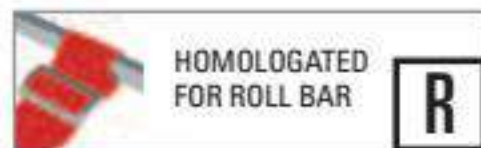

# 804 F

# 802 HF

PROFESSIONAL  
LIGHTWEIGHT BELT

PULL UP

DA804F  
SALOON  
6 POINTS  
FHR FRIENDLY

PROFESSIONAL BELT

PULL UP

DA802HF



EXPIRY DATE 31/12/2022



MANUFACTURER: OMP  
MODEL: DA804 LEGGERA  
HOM. NO: D-256.T/98  
FIA STANDARD: FIA 8853/98



DA804F71  
Black

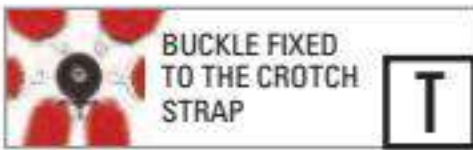
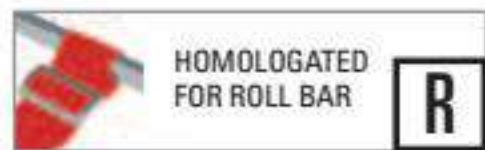
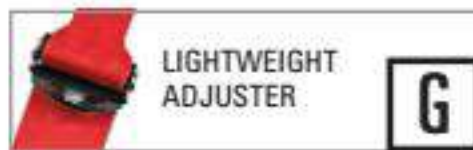

EXPIRY DATE 31/12/2022



MANUFACTURER: OMP  
MODEL: DA802  
HOM. NO: D-253.T/98  
FIA STANDARD: FIA 8853/98



DA802HF71  
Black



# 802 F

# 801 F

PROFESSIONAL BELT

PULL UP

DA802F

SALOON  
6 POINTS  
FHR ONLY

PROFESSIONAL BELT

PULL UP

DA801F

SALOON  
4 POINTS  
FHR FRIENDLY

3"  
shoulder straps

3"  
shoulder straps

DA802F61

Red

DA801F61

Red

PULL-UP 3"  
lap strap

PULL-UP 3"  
lap strap

EXPIRY DATE 31/12/2022



MANUFACTURER: OMP  
MODEL: DA802  
HOM. NO: D-253.T/98  
FIA STANDARD: FIA 8853/98



DA802F71  
Black

EXPIRY DATE 31/12/2022



MANUFACTURER: OMP  
MODEL: DA801  
HOM. NO: B-252.T/98  
FIA STANDARD: FIA 8853/98



DA801F71  
Black



PROFESSIONAL  
ADJUSTER

G



HOMOLOGATED  
FOR ROLL BAR

R



STEEL SNAP HOOK

P



BUCKLE FIXED  
TO THE CROTCH  
STRAP

T



LIGHTWEIGHT  
BUCKLE

B



LIGHTWEIGHT  
POLYESTER  
STRAPS

L



PROFESSIONAL  
ADJUSTER

G



HOMOLOGATED  
FOR ROLL BAR

R



STEEL SNAP HOOK

P



LIGHTWEIGHT  
BUCKLE

B



LIGHTWEIGHT  
POLYESTER  
STRAPS

L

# 515 HST

DA518061

2" V STRAP

Compatible with DA515.

PROFESSIONAL 5 POINTS HARNESS

DA515HST061

HOMOLOGATION  
SFI 16.1  
5 POINTS

HOMOLOGATION  
SFI 16.1

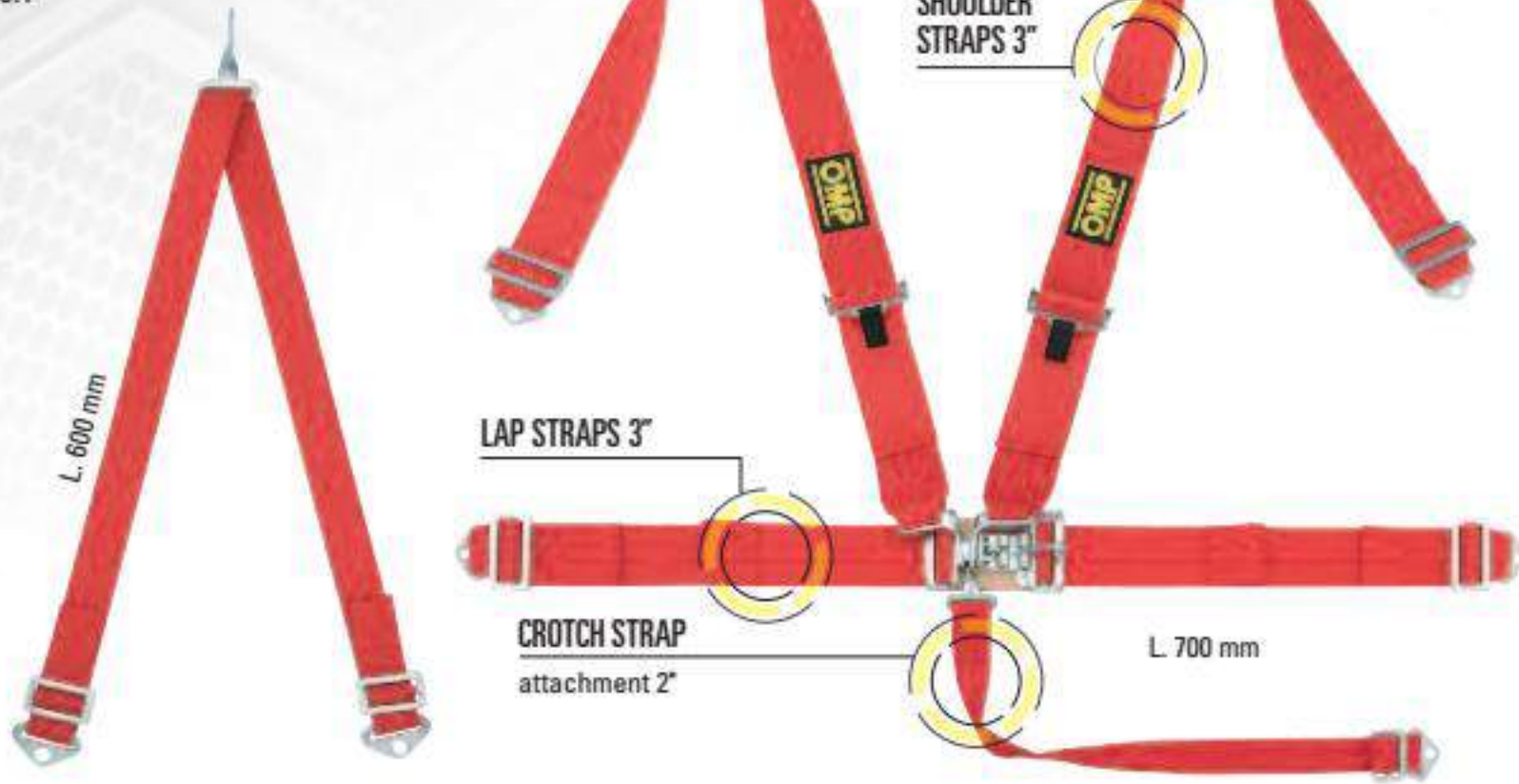

## V LEG STRAP

DA809

6 points.  
Strap: 2"  
Eyebolts for spring catch attachment.  
Fits to the whole OMP range of saloon car harnesses (no DA801L).



# SINGLE SEATER



# 0104 HSL

# 0206 HSL FORMULA

## FORMULA BELTS

Ultralightweight and comfortable safety harness for Formula cars in *Dyneema®*, the world strongest fiber™. Forged aluminium ultralight adjusters, buckle in ergal machined from solid and magnesium. The Harness ensures best safety level ever thanks to the ultra-resistant buckle with an anti-unwitting opening system. Adjustable setting of shoulder and lap straps with exclusive F1-inspired "double fold" system for a practical and strong hold.

DA0104HSL

FORMULA  
6 POINTS  
FHR ONLY



WEBBING AND SEWN specifically for Formula car attachments

**NEW!**  
HOMOLOGATION

**FIA APPROVED**

MANUFACTURER: OMP  
MODEL: DA0104  
HOM. NO. SH.018.17-T-6  
FIA STANDARD: FIA 8853/2016

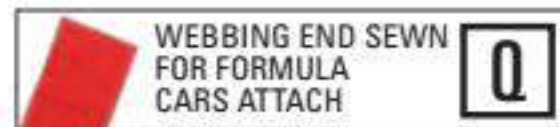
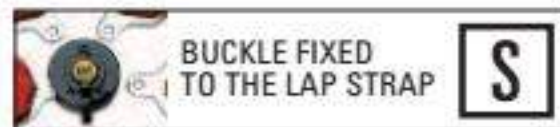
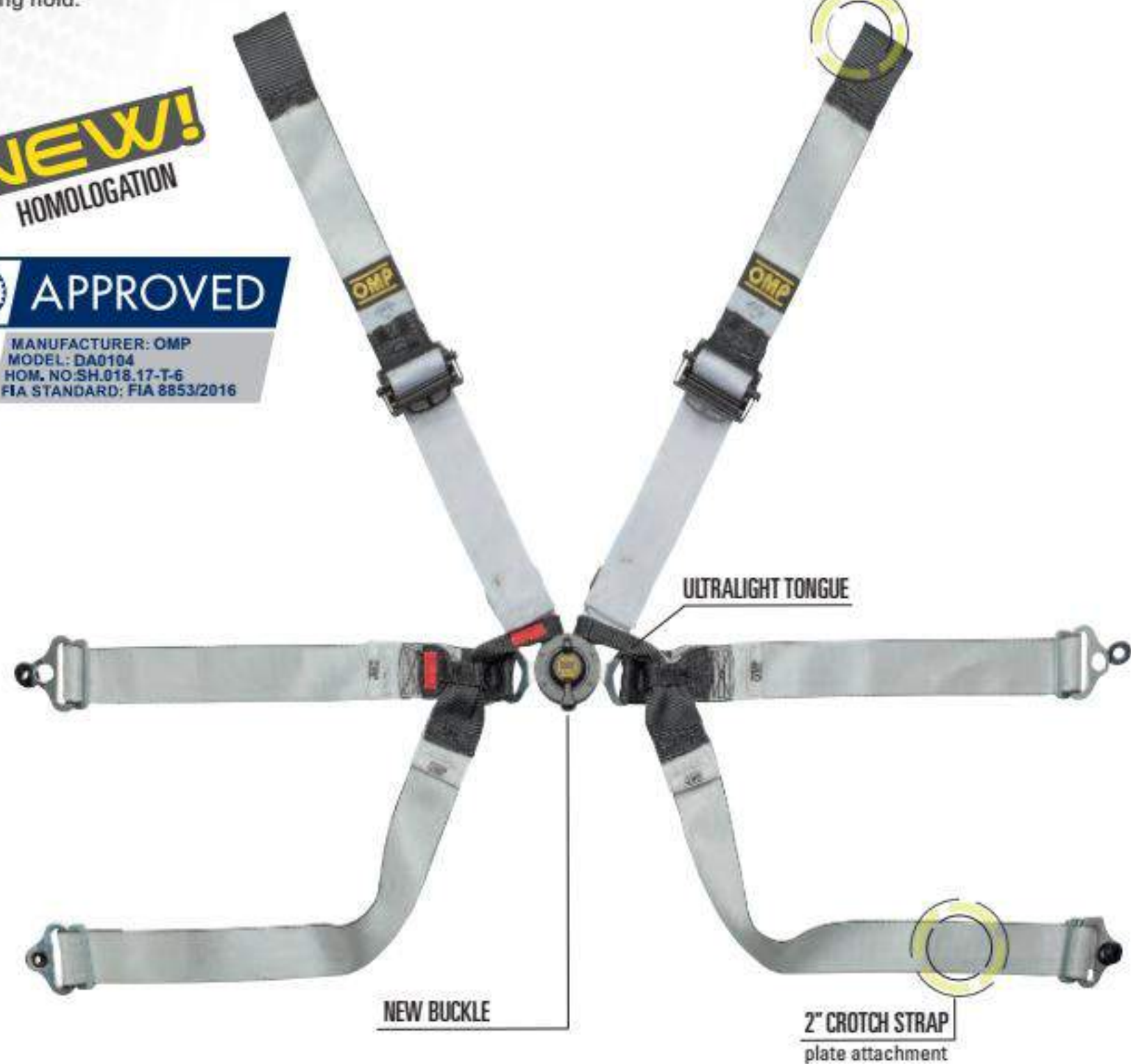

## SUPERLIGHT PROFESSIONAL BELT

ALSO AVAILABLE WITH PLATE ATTACHMENTS VERSION (DA0206BHSL)



PLATE ATTACHMENTS FOR DA0206BHSL

DA0206HSL

FORMULA  
6 POINTS  
FHR ONLY

**NEW!**  
HOMOLOGATION

**FIA APPROVED**

MANUFACTURER: OMP  
MODEL: DA0206  
HOM. NO. SH.037.17-T-6  
FIA STANDARD: FIA 8853-2016

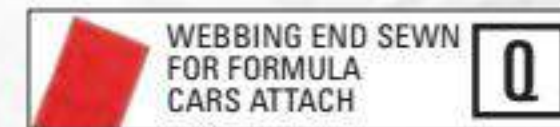





# ROAD 4M

# HARNESS

DA507

HOMOLOGATION ECE  
4 POINTS

Snap hook attachment.  
Adjusters: steel.  
Push button release: central.  
Supplied with 7/16" bolts.

SHOULDER STRAPS 2"

LAP STRAPS 2"

-  DA507041 Blue
-  DA507061 Red

DA507071 Black



# RACING 4M

# HARNESS

DA508

HOMOLOGATION ECE  
4 POINTS

Snap hook attachment.  
Adjusters: steel.  
Push button release: central.  
Supplied with 7/16" eye bolts.

DA508061 Red

LAP STRAPS 3"

LAP STRAPS 2"

-  DA508041 Blue
-  DA508071 Black



# ROAD 4

# HARNESS

DA505

HOMOLOGATION ECE  
4 POINTS

Bolt-in attachment.  
Adjusters: steel.  
Push button release: central.  
Supplied with 7/16" bolts.

SHOULDER STRAPS 2"

LAP STRAPS 2"

-  DA505041 Blue
-  DA505061 Red

DA505071 Black



# ROAD 3

# HARNESS

Bolt-in attachment.  
Adjusters: steel.  
Push button release: central.  
Supplied with 7/16" bolts.

SHOULDER STRAPS 2"

LAP STRAPS 2"



DA504

HOMOLOGATION ECE  
3 POINTS

DA504041  
Blue

DA504071  
Black

DA504061 Red

# STRADA 3

# HARNESS

Bolt-in attachment.  
Adjusters: steel.  
Push button release: central.  
Supplied with 7/16" bolts.

SHOULDER STRAPS 2"

LAP STRAPS 2"



DA509

HOMOLOGATION ECE  
3 POINTS

DA509071  
Black

DA509061 Red

# SAFETY BELTS ACCESSORIES

## HANS STRAP BOLDER

SD20

Hans strap bolder in rubber  
(pair), with sticker.



## PROFESSIONAL CUTTER

DB/460E

Professional safety belt  
cutter with hammer,  
light, emergency  
lamp and magnet.



## EYEBOLT

DB/420

7/16" eyebolt to  
attach harness  
snap-hook fittings.

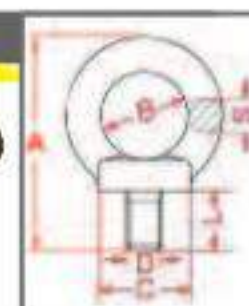

A: 57 mm / B: 15.5 mm / C: 20 mm  
D: 7/16" UNF / L: 22 mm / S: 8 mm

## PLATE FOR EYEBOLTS

DB/421

Reinforced threaded plate  
for eyebolts.



DIMENSIONS: 50x25x6 mm

## CUTTER

DB/459

Safety seat belt  
cutter.



## CUTTER

DB/461

Safety seat belt  
cutter.



## SEAT BELT PLATE

DB/418

FIA APPENDIX J art. 253

Seat belt plate with  
threaded 7/16" nut.  
DIMENSIONS: 50x80x3 mm



## SEAT BELT PADS

DB/450/3

In velour, use with  
3" seat belts.  
Closure: velcro.



DB/450/3/B  
Blue



DB/450/3/N  
Black



DB/450/3"/R Red

## SEAT BELT PADS

DB/454

In velour, used with  
2" seat belts.  
Closure: velcro.



DB/454/B  
Blue



DB/450/N Black

## SEAT BELT PADS

DB/450

In velour, used with  
2" seat belts.  
Closure: velcro.



DB/450/B  
Blue



DB/450/N  
Black



DB/450/R Red

# ROLL BARS

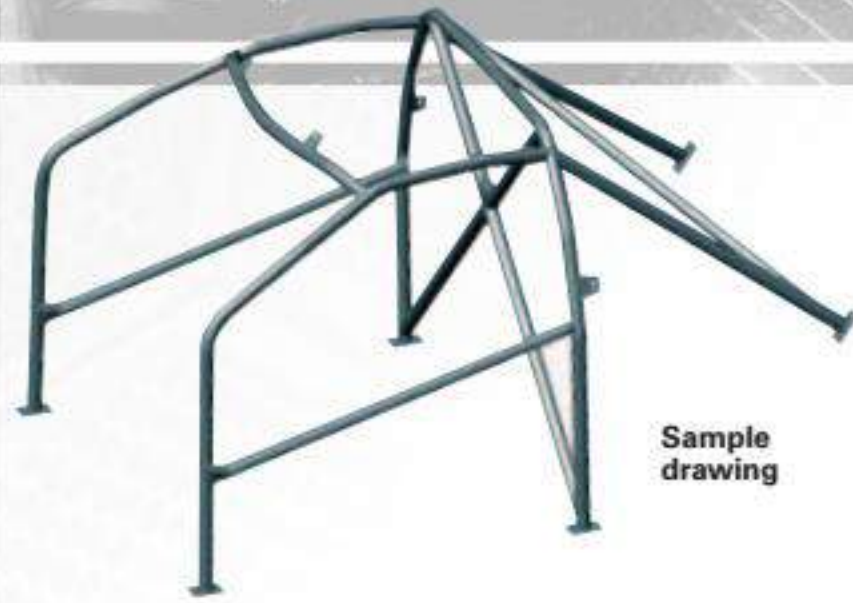
**FE 45 BOLT-IN****AB/100/...**

Sample drawing

FE45 steel bolt-in roll bars with Ø 40x2 & 50x2 tubing, connecting sleeve tubes and reinforced brace in the main hoop. Supplied with door bars and diagonal reinforcement at rear.

**FE 45 BOLT-IN****AA/104P/...**

Sample drawing

FE45 steel bolt-in roll bars with door bars. To be cut to measure and welded upon installation.

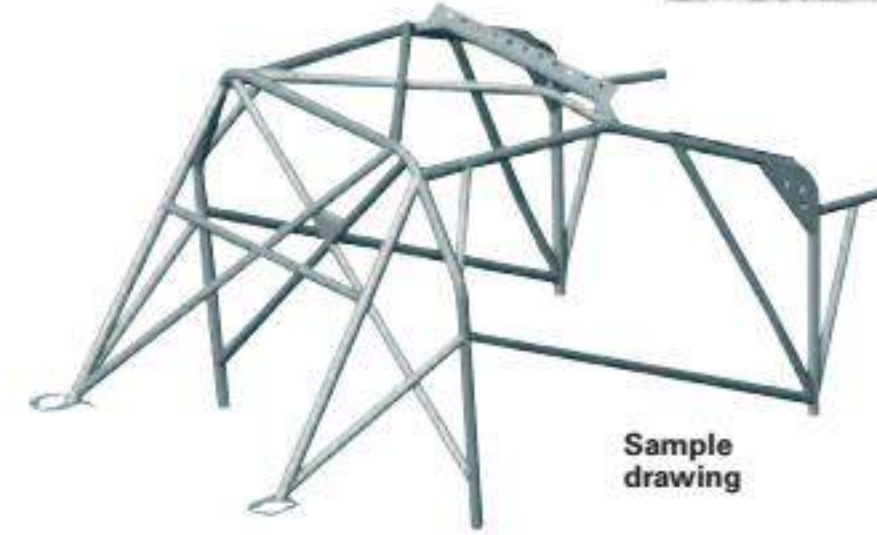
**MULTI-POINT WELD-IN****AB/106/...A**

Sample drawing

**AB/106/...A** supplied partially assembled.  
**AB/106/...AW** supplied not assembled.  
Multi-point weld-in chromoly (25CrMo4) roll bars. Reduced weight and improved rigidity compared with steel bolt-in roll bars.

Supplied partially assembled to facilitate and reduce installation cost.

**MULTI-POINT WELD-IN****AB/106/...B**

Sample drawing

Multi-point bolt-in chromoly (25CrMo4) roll bars. Reduced weight and improved torsional rigidity.

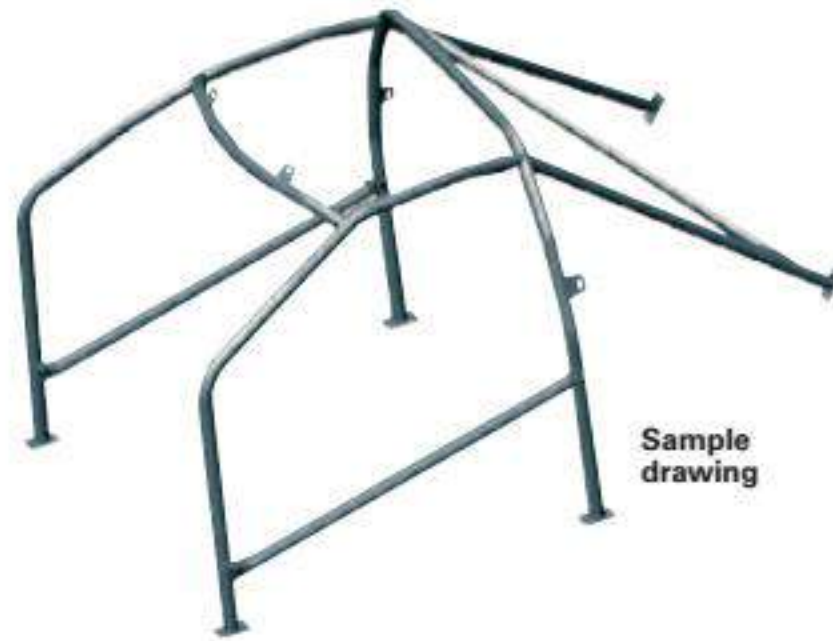
**FE 45 BOLT-IN****AB/105P/...**

Sample drawing

FE45 steel multi-point bolt-in roll bars with Ø 40x2 & 50x2 tubing, connecting sleeve tubes and door bars. To be cut to measure and welded upon installation.

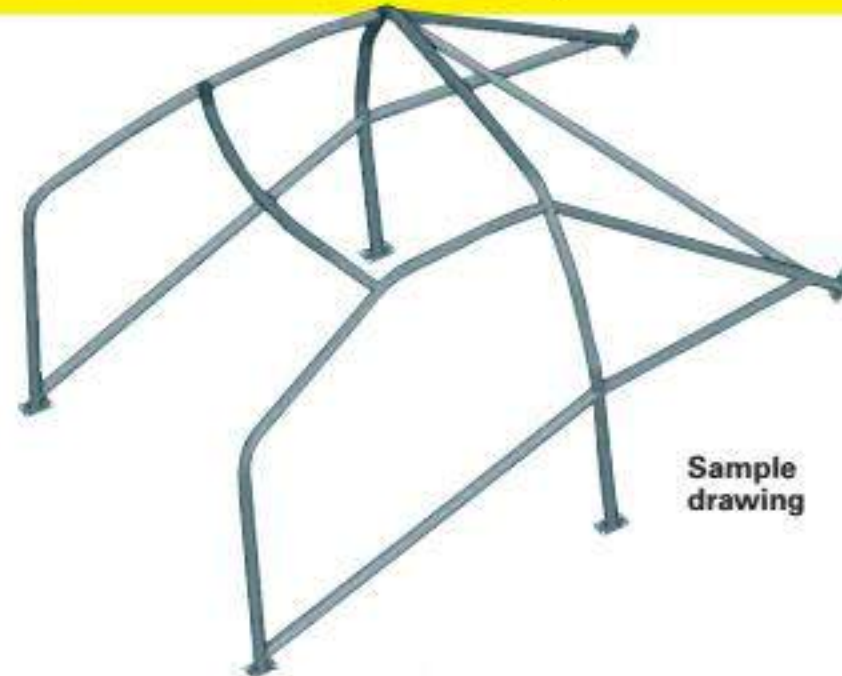
**FE 45 WELD-IN****AA/105/...A**

Sample drawing

FE45 steel weld-in roll bars with Ø 50x2 tubing on the main hoop and Ø 40x2 tubing elsewhere. It may be necessary to remove or cut interior panels to facilitate installation.

**OFF ROAD BOLT-IN****R/...**

Sample drawing

Off road Fe 45 steel bolt-in roll bars.

**REPLACEMENT HOOP****AA/103/...****AB/107/...****AA/102/...****AB/108/...**

Sample drawing

**AA/103/...** **AB/107/...**  
Replacement front hoop in FE45 steel (only for AA/104P and AB/105P).  
**AA/102/...** **AB/108/...**  
Replacement rear hoop in FE45 steel (only for AA/104P and AB/105P).

**ROLL BARS NOT DISTRIBUTED IN THE US**

**ROLL BARS NOT DISTRIBUTED IN THE US**

# ROLL CAGE ACCESSORIES

## RUBBER SLEEVING

**AA/113** FIA-J ALL

Foamed rubber sleeving for roll bar sold in pieces of 2 m.  
AA/113-40  
Ø 40 mm



AA/113-50  
Ø 50 mm

## REINFORCEMENT

**AA/175** FIA-J ALL

Universal "L" shaped reinforcement plate. Adjustable and suitable for any standard steel roll bar.  
Thickness: 3 mm



## CONNECTING TUBE

**AA/195**

Sleeve connecting tube in Fe45 steel. for tubing Ø 40 mm



## DOOR BARS

**AA/108** FIA-J ALL

Pair of door bars FE 45 steel, to be welded (no picture).

Length: 1.20 m  
Thickness: 2 mm  
Ø 40 mm



## CONNECTION

**AA/122** FIA-J ALL

Connection for roll bar, complete with hardware.  
AA/122 with tube Ø 40 mm



AA/122-50 with tube Ø 50 mm

## REINFORCEMENT

**AA/123** FIA-J ALL

Reinforcement to be used with connections AA/122 and AA/122-50.



## PLATE

**AA/175/S** FIA-J ALL

Flat plate lower reinforcement for standard roll bars.

Dimensions: 100x120x3 mm



## DOOR BARS

**AA/109** FIA-J ALL

Pair of door bars FE 45 steel, complete with connections.

Length: 1.25 m  
Thickness: 2 mm  
Ø 40 mm

## REINFORCE

**AA/200** FIA-J ALL DIS 253-24

Reinforce roll bar crosses.

Thickness: 1,5 mm  
Gusset: 80°



## REINFORCE

**AA/201** FIA-J ALL DIS 253-24

Reinforce roll bar crosses.

Thickness: 1,5 mm  
Gusset: 100°



## ENERGY ABSORBING

**AA115A**

TYPE A

Molded energy absorbing roll bar padding suitable for both.

Length: 490 mm  
For tube Ø 40/50 mm



MANUFACTURER: OMP  
MODEL: AA115A  
HOM. NO: CP.007.06.A  
FIA STANDARD: FIA 8857-2001



## REINFORCEMENT

**AA/111** FIA-J ANN

Pair assembled cross door reinforcement, connections included.



## REINFORCEMENT

**AA/202A** FIA-J ANN

Pair assembled cross door reinforcement, connections included. Ø 40x2 mm



## REINFORCEMENT

**AA/203** FIA-J ANN

Kit (2+2) of perforated plates for rollbar fixing in.



Front



Rear

## REINFORCEMENT

**AA/111A** FIA-J ANN

Pair not assembled cross door reinforcement, connections included. Ø 40x2 mm

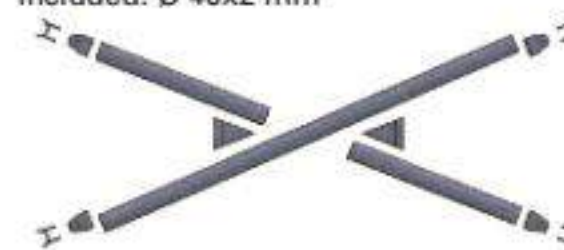

## COVER

**AA/113/FT** **AA/113/FP**



AA/113/FT/R (50 cm)  
AA/113/FP/R (100 cm)  
Red



AA/113/FT/B (50 cm)  
AA/113/FP/B (100 cm)  
Blue



AA/113/FT/N (50 cm)  
AA/113/FP/N (100 cm)  
Black

Pair of door bar covers in velour material (same as competition seats) to cover rubber sleeving Ref. AA/113 velcro closing.

## SUMPGUARDS, TANKGUARDS AND DIFFERENTIAL GUARDS

Made from a special aluminium alloy, these sumpguards have several functions: they protect the mechanical parts such as sump, gear-box, transmission etc. and they also contribute to stiffen the whole body and the front part of the car. For this reason they are suitable for every day use and are particularly useful for those driving on uneven roads.



# EXTINGUISHERS



**Bottle dimensions:**  
The dimensions of A, B, C are in mm.  
\*Total weight including: bottle, valve, dip tube, liquid, brackets.

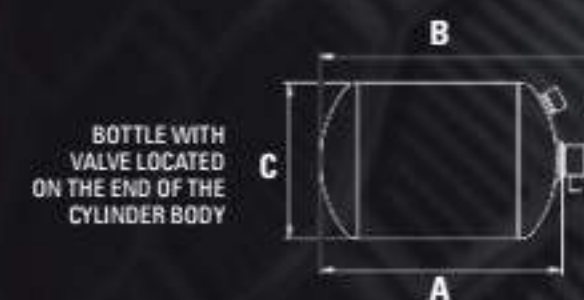

Ref.	Ecolife (lt.)	Empty (kg)	Total weight*	A	B	C
<b>PLATINUM COLLECTION</b>						
CEFAL3/B	0.9	0.4	1.8	194	235	100
CESAL3/B	1.3	0.7	2.5	204	246	130
CESAL3R/B	2.8	0.94	4.3	245	286	160
<b>WHITE COLLECTION</b>						
CEFAL2/B	2.8	0.94	4.3	245	286	160
CESAL2/B	4.25	1.3	6.2	315	210	160
<b>BLACK COLLECTION</b>						
CMSST1/B	4.25	2.4	8.1	330	420	160
CMFST1/B	2.8	1.97	5.6	295	385	130
CESST1/B	4.25	2.4	7.7	330	385	160
<b>OMP SPORT</b>						
CA/372/B	4.25	2.4	8.1	330	420	160
<b>HAND HELD</b>						
CAB/322	4 Kg powder	2.5	6.5	310	405	160
CAB/319	2.4	2.25	5.0	295	390	132
CAB/316	2 Kg powder	0.7	3.1	227	330	108
CBB/351	2.4	1.15	4.0	300	390	130



# CESAL4

## ONE COLLECTION

Very compact and ultralight fire extinguisher system, electrically activated, suitable for saloon cars. FIA 8865-2015 rules complying. Aluminium bottle, the extinguisher can turn off fire in few seconds injecting in the cockpit and in the engine bay different fire-extinguishing medium. The system gets pressurized when activated enabling the discharge of the extinguishant. 3 nozzles are for the engine bay in order to protect the most critical and dangerous parts depending on the type of vehicle, 2 nozzles are for the cockpit to ensure the driver front and rear protection. The system is available in two versions: "L" version (only for medium-large sized cockpit) and "S" version (suitable for small size cockpit). L and S systems have the same dimensions and weight, but different amount of fire extinguisher medium in way to be safe and efficient at the same time. Fixing brackets, clamps, tubing and connections are included.

**Total weight:** 5,2 kg (only bottle)  
5,5 kg (with stainless steel brackets and clamps).

**ULTRALIGHT**  
Ø 130 mm



MANUFACTURER: OMP  
MODEL: CESAL 4  
HOM. NO: TBD  
FIA STANDARD: FIA 8865-2015

- |  |  |  |  |  |  |  |  |  |  |  |
|--|--|--|--|--|--|--|--|--|--|--|
|  |  |  |  |  |  |  |  |  |  |  |
|  |  |  |  |  |  |  |  |  |  |  |

**CESAL4L**  
FROM 1.99 M3 UP TO 3.73 M3

**CESAL4S**  
FROM 1.2 M3 UP TO 2.2 M3

**NEW!**

Homologated for use on:

- Petrol
- Petrol + up to 30% ethanol or methanol
- Petrol + up to 85% ethanol or methanol (E85)



TOYOTA GAZOO RACING WRC

# CEFAL 3

## PLATINUM COLLECTION

Extinguisher system (engine compartment and cockpit) electrically activated, with control box, tubings, nozzles. Ultralight aluminium bottle with reduced dimensions.

0,9 lt of Ecolife

**Total weight:**  
1,8 kg (with stainless steel brackets and clamps).



MANUFACTURER: OMP  
MODEL: ECOLIFE GOLD ONE SEAT  
HOM. NO: EX.036.11  
FIA STANDARD: FIA 2000



LENGTH 194 mm



CEFAL3  
FORMULA  
CARS

THE SMALLEST  
IN THE WORLD

ULTRALIGHT  
Ø 100 mm



# CESAL 3R

## PLATINUM COLLECTION

Extinguisher system (engine compartment and cockpit) electrically activated, with control box, tubings, noozles, aluminium bottle.

3 lt of Ecolife.

**Total weight:**  
4,3 kg (with stainless steel brackets and clamps).



MANUFACTURER: OMP  
MODEL: ECOLIFE  
HOM. NO: EX.035.11  
FIA STANDARD: FIA 2000



LENGTH 245 mm

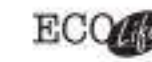

CESAL3R  
SALOON  
CARS  
SPECIAL FOR  
RALLY

Ø 160 mm



# CESAL 3

## PLATINUM COLLECTION

Extinguisher system (engine compartment and cockpit) electrically activated, with control box, tubings, nozzles. New ultralight aluminium bottle with reduced dimensions.

1,3 lt of Ecolife.

**Total weight:**  
2,5 kg (with stainless steel brackets and clamps).



MANUFACTURER: OMP  
MODEL: ECOLIFE GOLD SALOON  
HOM. NO: EX.035.11  
FIA STANDARD: FIA 2000



LENGTH 204 mm



CESAL3  
SALOON  
CARS

ULTRALIGHT  
Ø 130 mm



# CEFAL 2

## WHITE COLLECTION

Extinguisher system (engine compartment and cockpit) electrically activated, with control box, tubings, nozzles, aluminium bottle.

2,8 lt of Ecolife.

**Total weight:**  
4,3 kg (with stainless steel brackets and clamps).



MANUFACTURER: OMP  
MODEL: ECOLIFE  
HOM. NO: EX.009.00  
FIA STANDARD: FIA 2000



LENGTH 245 mm

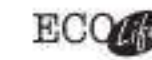

CEFAL2  
FORMULA  
CARS

Ø 160 mm



# CESAL 2

## WHITE COLLECTION

Extinguisher system (engine compartment and cockpit) electrically activated, with control box, tubings, nozzles, aluminium bottle.

4,25 lt of Ecolife.

**Total weight:**  
6,2 kg (with stainless steel brackets and clamps).



MANUFACTURER: OMP  
MODEL: ECOLIFE  
HOM. NO: EX.008.00  
FIA STANDARD: FIA 2000



LENGTH 315 mm

Ø 160 mm



CESAL2  
SALOON  
CARS



# CESST 1

## BLACK COLLECTION

Extinguisher system (engine compartment and cockpit) electrically activated, with control box, tubings, noozles, steel bottle.

4,25 lt of Ecolife.

**Total weight:**  
7,7 kg (with stainless steel brackets and clamps).



MANUFACTURER: OMP  
MODEL: ECOLIFE  
HOM. NO: EX.008.00  
FIA STANDARD: FIA 2000



LENGTH 330 mm

Ø 160 mm



CESST1  
SALOON  
CARS  
SPECIAL FOR  
RALLY



# CMSST 1

## BLACK COLLECTION

Extinguisher system (engine compartment and cockpit) mechanically activated, steel bottle, complete with tubings, nozzles, steel bottle.

4,25 lt of Ecolife.

**Total weight:**  
8,1 kg (with stainless steel brackets and clamps).



MANUFACTURER: OMP  
MODEL: ECOLIFE  
HOM. NO: EX.009.00  
FIA STANDARD: FIA 2000



LENGTH 330 mm

Ø 160 mm



CMSST1  
SALOON  
CARS



# CMFST 1

## BLACK COLLECTION

Extinguisher system (engine compartment and cockpit) mechanically activated, tubings, nozzles, steel bottle.

2,8 lt of Ecolife.

**Total weight:**  
5,6 kg (with stainless steel brackets and clamps).



MANUFACTURER: OMP  
MODEL: ECOLIFE  
HOM. NO: EX.009.00  
FIA STANDARD: FIA 2000



LENGTH 297 mm

Ø 130 mm



CMFST1  
FORMULA  
CARS



## OMP SPORT

Extinguisher system (engine compartment and cockpit) mechanically activated, steel bottle, complete with tubings, nozzles, steel bottle.

4,25 lt of Ecolife.

**Total weight:**  
8,1 kg (with stainless steel brackets and clamps).



MANUFACTURER: OMP  
MODEL: ECOLIFE  
HOM. NO: EX.026.08  
FIA STANDARD: FIA 2000



Ø 160 mm

- 4M AL TUBING 2x
- STICKERS 2x
- PULL CABLES 2x
- NOZZLES 6x
- T CONNECTIONS 4x
- 90° CONNECTIONS 2x
- 3 WAY CONNECTION 1x
- ANTI-TORPEDO TABS 2x



CA/372  
SALOON  
CARS

## ALUMINIUM EXTING.

CAB/316

Aluminium hand held extinguisher, 2 Kg powder. Complete with stainless steel brackets and quick release clamps.  
**Total weight:** 3,1 kg

Ø 108 mm



EN3

## STEEL EXTING.

CAB/322

Steel hand held extinguisher, 4 Kg powder, A/B/C classes. Complete with stainless steel brackets and quick release clamps.  
**Total weight:** 6 kg



Ø 160 mm



EN3

## STEEL EXTING.

CAB/319

Steel hand held extinguisher, 2,4 l Ecolife. Complete with aluminium brackets and stainless steel quick release clamps.  
**Total weight:** 5 kg

IN COMPLIANCE WITH FIA RULES

Ø 130 mm

CAB/319/R Red

CAB/319  
Black



## ALUMINIUM EXTING.

CBB/351

Aluminium hand held extinguisher, 2,4 l Ecolife. Complete with aluminium brackets and stainless steel quick release clamps.  
**Total weight:** 4 kg

IN COMPLIANCE WITH FIA RULES

Ø 130 mm

CBB/351/R Red

CBB/351/A Silver

CBB/351  
White



H. KÜHNLE - R. LEECKE - AT'S MOTORSPORT

# REPLACEMENT PARTS

## PLATINUM - WHITE - BLACK COLLECTION

**CD/393**

Atomiser nozzle specifically for Ecolife systems to be threaded onto "T" or "L" connectors.



**CD/398**

Control box for electrically activated units with wiring harness 1,5 m



**CD/360**

Control box for electrically activated extinguishing systems. With new advanced electronic unit complying with FIA 8856-2015 rules. Complying with IP55 waterproof standard.



**CD/324/10/N**

Fire resistant sheath 5 m roll,  $\phi$  10 mm (or  $\phi$  8mm ref. CD/324/8/N).



**X/363/E/CAV**

Electric extinguisher valve cable w. jack.



**X/398/CAV**

Control box cable.



**EA/467**

Water-proof push button for external control.



**X/181493**

Rubber ring for push button EA/467



## PLATINUM COLLECTION

**CD/395/N**

Straight connection  $\phi$  8 mm (1/8" junction).



**CD/392/N**

1/8" connection, "T" shaped with quick couplings.  $\phi$  8 mm



**CD/392/N/6**

1/8" connection, "T" shaped with quick couplings.  $\phi$  6 mm



**CD/390/N**

3-way connection with quick attachments,  $\phi$  8 mm.



**CD/399**

Reduction tube  $\phi$  6-8 mm.

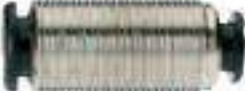

**CD/391/N**

90° end connection, 1/8" shaped with quick attachments.  $\phi$  8 mm



**CD/391/N/6**

90° end connection, 1/8" shaped with quick attachments.  $\phi$  6 mm



**CD/323/N/8**

Aluminium tubing  $\phi$  8 mm - L. 5 m



**CD/323/N/6**

Aluminium tubing  $\phi$  6 mm - L. 3 m



**CD/400**

Bracket for CEFAL3.



**CD/401**

Bracket for CESAL3.



**CD/407**

Y shaped connection with quick attachments  $\phi$  8mm (no picture)

## HAND HELD EXTINGUISHERS

**CD/312**

Bracket for HAND HELD STEEL extinguishers Ecolife: CAB/319,  $\phi$  132 mm



**CD/309**

Bracket for HAND HELD STEEL extinguishers Ecolife: CAB/319,  $\phi$  132 mm



**CD/356**

Bracket for ALUMINIUM HAND HELD extinguisher: CBB/351  $\phi$  130 mm



**CD/404**

Bracket for OMP Sport CA/372 (no picture)

**CD/311/S-AT**

Anti-torpedo tabs for double brackets extinguishers (e.g. CEFAL3).



**CD/300-AT**

Anti-torpedo tabs for mono brackets extinguishers (e.g. CEFAL3).



**CD/405**

Bracket for STEEL extinguisher CAB/322,  $\phi$  160 mm (no picture)

Support brackets are made according to the current FIA standard

## WHITE - BLACK COLLECTION - OMP SPORT

**CD/394**

Straight connection (1/4" junction).



**CD/395**

Straight connection (1/8" junction).



**CD/392**

1/8" connection, "T" shaped with quick couplings.



**CD/391**

90° end connection, 1/8" shaped with quick attachments.



**CD/390**

3-way connection with quick attachments.



**CD/323/A**

Aluminium tubing  $\phi$  6 mm - 4 m



**CD/314**

Bracket for SINGLE fixed bottles for systems in either STEEL  $\phi$  130 mm, or ALUMINIUM  $\phi$  132 mm



**CD/308**

Bracket for fixed bottles for systems in either STEEL or ALUMINIUM,  $\phi$  160 mm



**CD/309**

Bracket for HAND HELD STEEL extinguishers Ecolife: CAB/316,  $\phi$  108 mm (no picture)

**CD/404**

Bracket only for OMP Sport CA/372 (no picture)

## BLACK COLLECTION

**CD/335**

Pull cable for mechanically operated systems.



## ONE COLLECTION

**CD/415**

90° end connection, 1/8" with quick attachments.  $\phi$  8mm



**CD/408**

Fixing brackets with clamps for CESAL4. Anti-torpedo.



**CD/409**

Cockpit nozzle fixing bracket (for



**CD/410**

Nozzle (cockpit) specifically for CESAL4



**CD/393/N**

Atomizer nozzle (engine bay) specifically for Ecolife systems



**CD/416**

Straight connection, 1/8" with quick attachments.  $\phi$  8mm



**CD/412**

"T" shaped 3-way connection, 1/8" with quick attachments.  $\phi$  8mm



**X/CAB/CESAL4**

Electric wiring for CESAL4 extinguisher



**CD/414**

"Y" shaped connection, 1/8" with quick attachments.  $\phi$  8mm



**CD/360**

Control box for electrically activated extinguishing systems. With new advanced electronic unit complying with FIA 8856-2015 rules. Complying with IP55 waterproof standard.



**CD/324/10/N**

Fire resistant sheath 5 m roll,  $\phi$  10 mm (or  $\phi$  8mm ref. CD/324/8/N).



**CD/323/A**

Aluminium tubing  $\phi$  8 mm L 4 m



**X/855**

Sticker



**X/181493**

Rubber ring for push button EA/467



**EA/467**

Water-proof push button for external control.



# STEERING WHEELS



RACING

PAG 188



VINTAGE

PAG 202



OFF ROAD

PAG 06



TUNING

PAG 203

# 320 HYBRID S

OD/2048

## SUPER PROFESSIONAL RALLY STEERING WHEEL

Flat steering wheel made with a new exclusive composite technology (carbon fiber and Dyneema®) 300% more resistant than the carbon steering wheel and 20% lighter. Supplied with horn button. Prepared to install 4 bottoms (not included) Realized and developed in cooperation with Sébastien Ogier, WRC world champion with VW Motorsport.



**CARBON FIBER AND DYNEEMA®**  
FLAT  
SUPPLIED WITH HORN BUTTON

**OVER 20% LIGHTER**  
**300% MORE RESISTANT**  
IN COMPARISON WITH CARBON VERSION

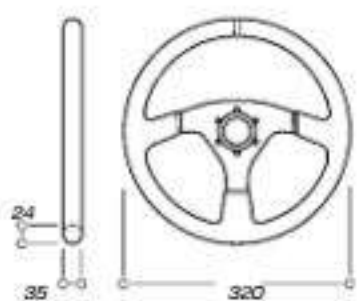
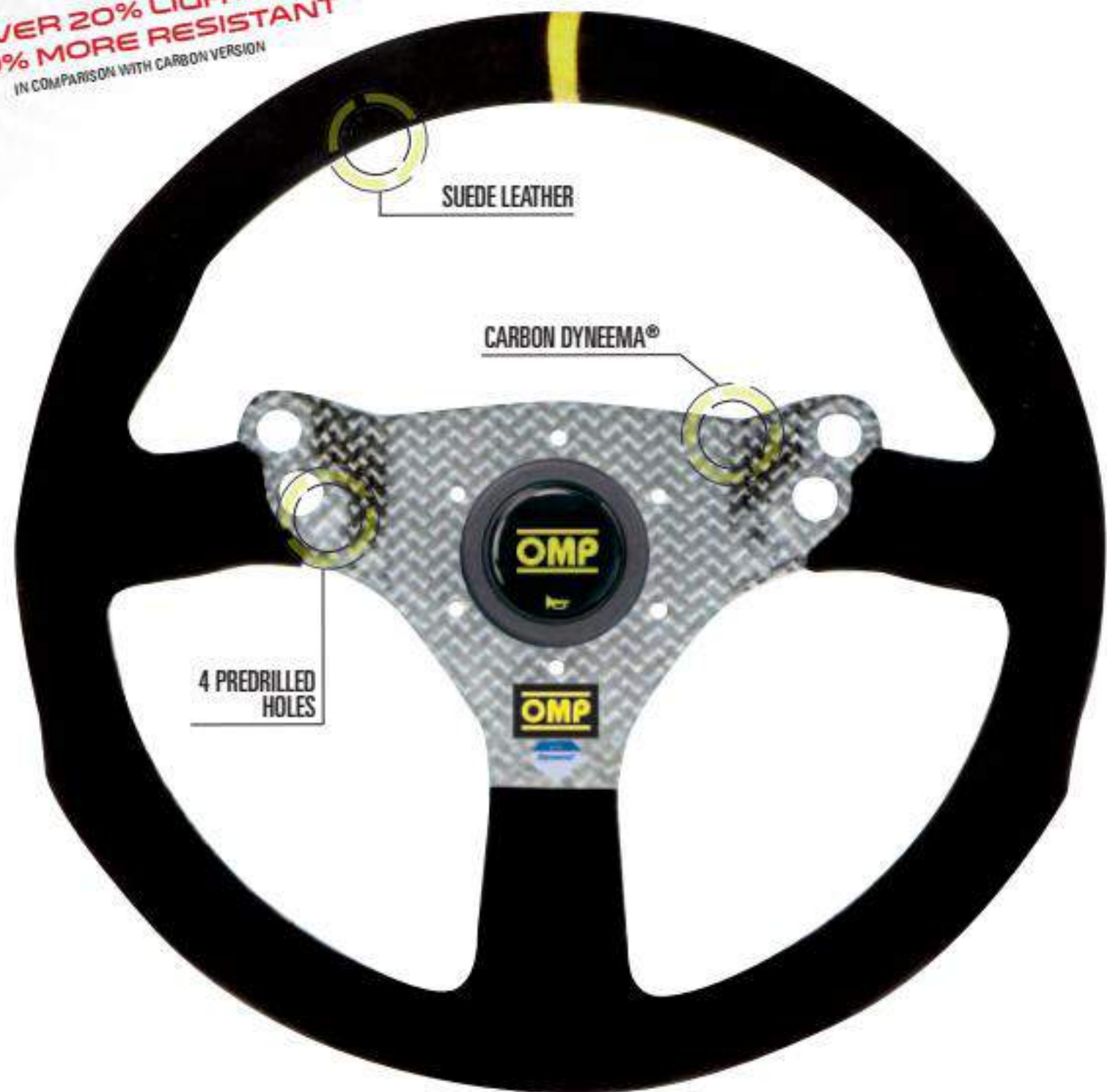

Diameter: 320 mm  
Handgrip: oval 35x24 mm

# 310 ALU GT

OD/2044/N

## SUPERLIGHT PROFESSIONAL GT STEERING WHEEL

Completely made in aluminium and suede leather. Studied and ready for the installation of most popular electronic display like: MoTec C125 and AiM MXL.



Sample image of MoTec C125 setup.

ALUMINIUM  
FLAT



SUEDE LEATHER



ITALIAN FLAG  
COLORED STITCHING

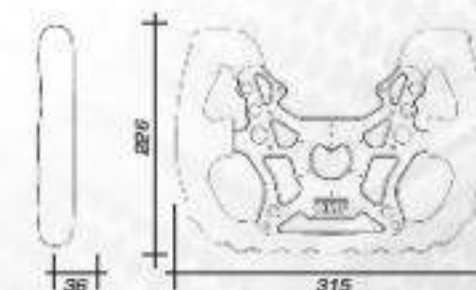

Diameter: 315 mm  
Handgrip: oval 36x30 mm

# 320 CARBON S

# 350 CARBON D

## SUPERLIGHT PROFESSIONAL STEERING WHEEL

Carbon steering wheel is constructed as one integral piece.

**50% LIGHTER  
15% MORE RESISTANT**  
IN COMPARISON WITH STANDARD VERSION

OD/2032/N

CARBON FIBER FLAT  
SUPPLIED WITH  
HORN BUTTON



SUEDE LEATHER

CARBON MADE SPOKES

BLACK STITCHING

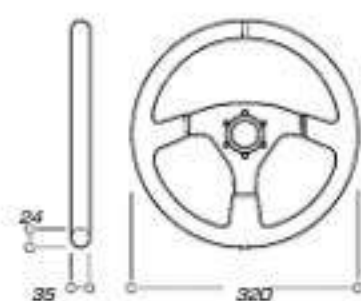

Diameter: 320 mm  
Handgrip: oval 35x24 mm



P. SOLBERG - P-SRX VOLKSWAGEN SWEDEN

**DESIGNED  
IN COOPERATION  
WITH P. SOLBERG**

OD/2028/N

## SUPERLIGHT PROFESSIONAL DISHED STEERING WHEEL

Carbon steering wheel is constructed as one integral piece.

**50% LIGHTER  
15% MORE RESISTANT**  
IN COMPARISON WITH STANDARD VERSION

CARBON FIBER DISHED  
SUPPLIED WITH  
HORN BUTTON



SUEDE LEATHER

CARBON MADE SPOKES

BLACK STITCHING

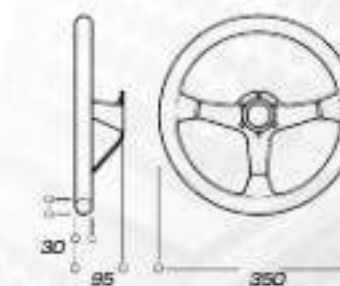

Diameter: 350 mm  
Handgrip: round 30 mm



# 320 ALU SP

# RECCE

## LIGHT PROFESSIONAL STEERING WHEEL

Made completely in aluminium and suede leather. **Preforated version** with central hole supplied with horn button.

This version has been derived from the model 320 Carbon S, which has been designed in cooperation with P. Solberg (FIA World RX 2014/21015 Winner)

OD/2042F

ALUMINIUM FLAT SUPPLIED WITH HORN BUTTON

SUEDE LEATHER



RED BUTTONS for controlling two separate accessory switches (e.g. one horn and the other for high beams)

BLACK ANODIZED SPOKES

BLACK STITCHING

320 ALU S

OD/2042

Same characteristics as OD/2042F. Standard version.

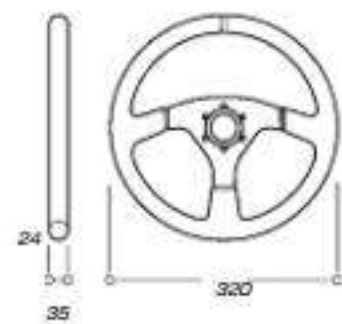

Diameter: 320 mm  
Handgrip: oval 35x24 mm

## SUPER PROFESSIONAL RALLY STEERING WHEEL

Flat steering wheel, in aluminium, 350 mm diameter, round 30 mm handgrip. With colored marks on the crown to indicate steering wheel angles (0° - 25° - 55° - 100° - 160°)

OD/2046

ALUMINIUM FLAT SUPPLIED WITH HORN BUTTON



BLACK STITCHING

SUEDE LEATHER

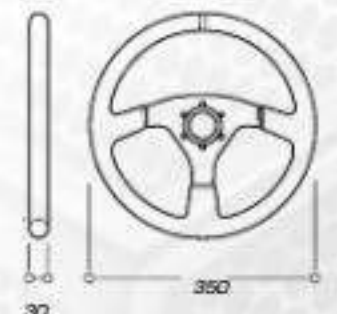

Diameter: 350 mm  
Handgrip: round 30 mm

# VELOCITA' SUPERLEGGERO

# CORSICA SUPERLEGGERO

MADE COMPLETELY FROM ALUMINIUM

40% lighter than equal model Velocità OD/1958.

OD/2020/N

ALUMINIUM FLAT SUPPLIED WITH HORN BUTTON

40% LIGHTER IN COMPARISON WITH STANDARD VERSION

SUEDE LEATHER



BLACK ANODIZED SPOKES

BLACK STITCHING

LIGHT PROFESSIONAL STEERING WHEEL

Made completely in aluminium. 40% lighter than equal model Corsica OD/1954.

OD/2021/N

ALUMINIUM DISHED SUPPLIED WITH HORN BUTTON

40% LIGHTER IN COMPARISON WITH STANDARD VERSION

SUEDE LEATHER



BLACK ANODIZED SPOKES

BLACK STITCHING

VELOCITA' OV SUPERLEGGERO

OD/2035/N

Same characteristics as OD/2020/N. Oval section version. Diameter: 320 mm

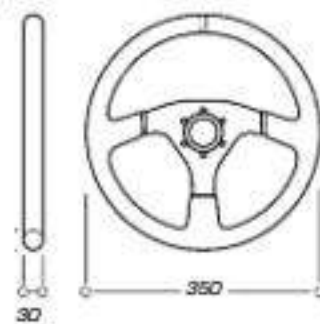

Diameter: 350 mm  
Handgrip: round 30 mm

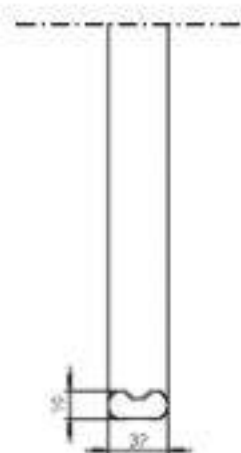

CORSICA OV SUPERLEGGERO

OD/2034/N

Same characteristics as OD/2021/N. Oval section version. Diameter: 350 mm

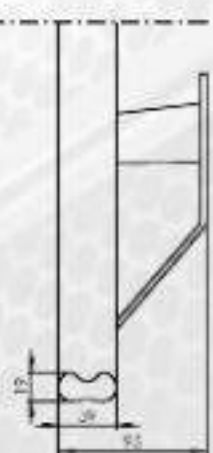
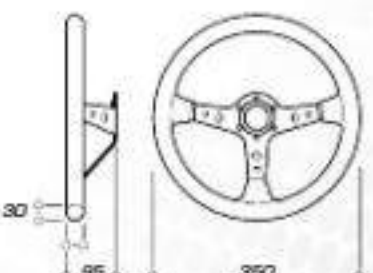

# CORSICA

## PROFESSIONAL STEERING WHEEL

Made in aluminium and steel.

OD/1954  
OD/1956

DISHED  
SUPPLIED WITH  
HORN BUTTON



OD/1954/TN

In suede leather.  
Titanium colour  
anodized spokes.  
Yellow stitching.



OD/1954/N

In suede leather.  
Black anodized  
spokes.  
Yellow stitching.



OD/1954/AN

In suede leather.  
Silver anodized  
spokes.  
Yellow stitching.



OD/1956/N

In smooth leather.  
Black anodized  
spokes.  
Yellow stitching.



OD/1956/NR

In smooth leather.  
Black anodized  
spokes.  
Red stitching.



OD/1956/AN

In smooth leather.  
Gray anodized  
spokes.  
Yellow stitching.

CORSICA 330

OD/2012/NN

In suede leather.  
Black anodized  
spokes. Yellow  
stitching.  
Diameter: 330 mm

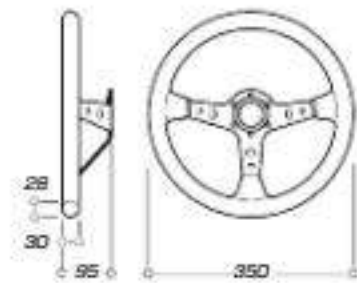

Diameter: 350 mm  
Handgrip: oval 30x28 mm  
Depth: 95 mm

# RALLY

## PROFESSIONAL STEERING WHEEL

Made in aluminium and steel.

OD/1950  
OD/1951

DISHED  
SUPPLIED WITH  
HORN BUTTON



YELLOW STITCHING

SMOOTH LEATHER

BLACK ANODIZED  
SPOKES



OD/1951

In suede leather.  
Black anodized  
spokes.  
Yellow stitching.



OD/1951/BN

In suede leather.  
Blue anodized  
spokes.  
Black stitching.

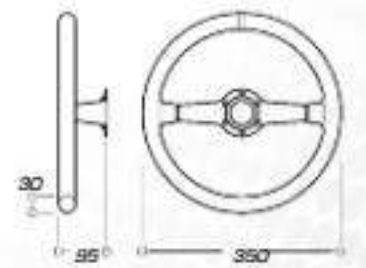

Diameter: 350 mm  
Handgrip: round 30 mm  
Depth: 95 mm

# WRC

# SUPERQUADRO

SUEDE LEATHER

BLACK ANODIZED SPOKES

OD/1979

OD/1980

MID-DEPTH DISHED  
SUPPLIED WITH HORN BUTTON

OD/1979/N



OD/1980/N

In smooth leather.  
Black anodized spokes.  
Yellow stitching.



OD/1980/NR

In smooth leather.  
Black anodized spokes.  
Red stitching.

BLACK STITCHING

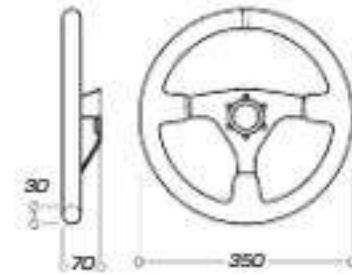

Diameter: 350 mm  
Handgrip: round 30 mm  
Depth: 70 mm



# VELOCITA'

SMOOTH LEATHER

BLACK ANODIZED SPOKES

OD/1957

OD/1958

FLAT  
SUPPLIED WITH HORN BUTTON

OD/1957



OD/1958

In suede leather.  
Black anodized spokes.  
Black stitching.

BLACK STITCHING

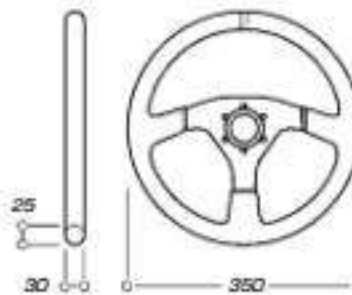

VELOCITA' 380



Handgrip:  
oval 35x30 mm



OD/2030/NN

In smooth leather. Black  
anodized spokes. Black  
stitching.



OD/1987/NN

In suede leather.  
Black anodized spokes.

OD/1990/NN

FLAT  
SUPPLIED WITH  
HORN BUTTON

SUEDE LEATHER

BLACK ANODIZED SPOKES



Diameter: 330x290 mm  
Handgrip: oval 35x27 mm

# TARGA

SUEDE LEATHER

BLACK ANODIZED SPOKES

OD/2005/NN

FLAT  
SUPPLIED WITH  
HORN BUTTON

BLACK STITCHING



Diameter: 330 mm  
Handgrip: oval 37x24 mm

# TRECENTO

OD/1975/N | OD/1976/N

SUEDE LEATHER

BLACK ANODIZED SPOKES

FLAT  
SUPPLIED WITH HORN BUTTON

OD/1975/N

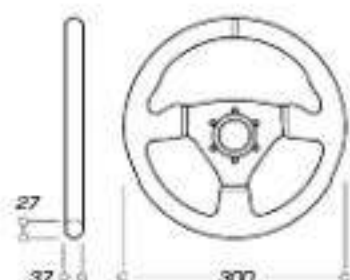

Diameter: 300 mm  
Handgrip: oval 37x27 mm



OD/1976/N

In smooth leather.  
Black anodized  
spokes.  
Black stitching.

# FORMULA QUADRO

OD/1972/N

SINGLE SEATER

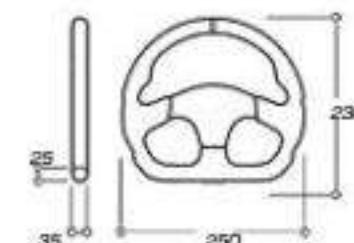

Diameter: 250x200 mm  
Handgrip: oval 35x25 mm

SUEDE LEATHER

BLACK ANODIZED SPOKES

# INDY

OD/2016/NN

SINGLE SEATER

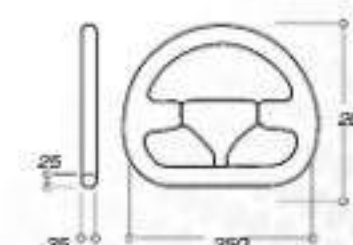

Diameter: 250x200 mm  
Handgrip: oval 35x25 mm

SUEDE LEATHER

BLACK ANODIZED SPOKES

BLACK STITCHING

INDY OPEN

OD/2017/NN

Same characteristics as OD/2016/NN.  
Open upper part version.

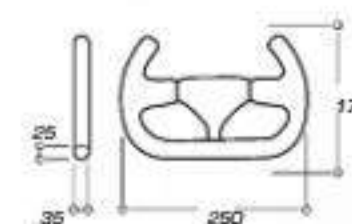

Diameter: 250x170 mm  
Handgrip: oval 35x25 mm

# KUBIK

OD/1985/NN

FLAT  
SUPPLIED WITH  
HORN BUTTON



Diameter: 310x265 mm  
Handgrip: oval 35x28 mm

SUEDE LEATHER

BLACK ANODIZED SPOKES

BLACK STITCHING

# MUGELLO

# STEERING WHEEL



OD/2023/LE

FLAT  
WOODEN

Diameter: 350 mm  
Handgrip: round 30 mm

# CROMO

# STEERING WHEEL



OD/2018/LN

FLAT SUPPLIED  
WITH HORN BUTTON

SMOOTH LEATHER

PERFORATED  
LEATHER INSERTS

BLACK STITCHING

CHROME SPOKES



Diameter: 350 mm  
Handgrip: oval 32x27 mm

# VINTAGE

# SAND

# STEERING WHEEL

Diameter: 380 mm  
Handgrip: round 30 mm



OD/2031/NN

IN POLYURETHANE FLAT  
SUPPLIED WITH  
HORN BUTTON

BLACK ANODIZED SPOKES

BLACK STITCHING

# ASSO

# STEERING WHEEL



OD/2019/LN

FLAT SUPPLIED  
WITH HORN BUTTON

SMOOTH LEATHER

BLACK STITCHING

CHROME SPOKES

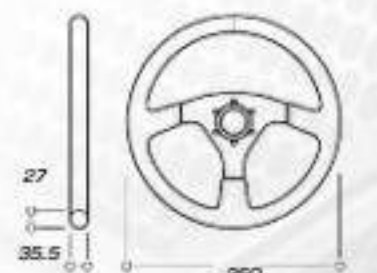

Diameter: 350 mm  
Handgrip: oval 35,5x27 mm

# RACING GP

# STEERING WHEEL

OD/1981/NN

POLYURETHANE

BLACK STITCHING

BLACK ANODIZED SPOKES

SIMULATING PERFORATED leather for enhanced grip



FLAT SUPPLIED WITH HORN BUTTON

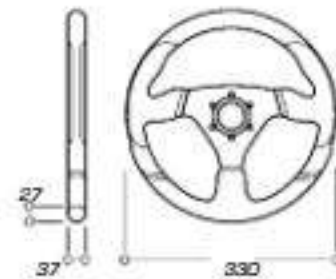

Diameter: 330 mm  
Handgrip: oval 32x27 mm

# TRECENTO UNO STEERING WHEEL

OD/1989/NN

POLYURETHANE

BLACK STITCHING

BLACK ANODIZED SPOKES

SIMULATING PERFORATED leather for enhanced grip



FLAT SUPPLIED WITH HORN BUTTON

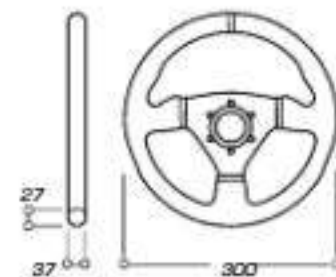

Diameter: 300 mm  
Handgrip: oval 37x27 mm

# STEERING WHEELS ACCESSORIES

## QUICK RELEASE HUB

Quick release hub in aluminium with 6 holes. Compatible with 3 or 6 holes steering wheel. Available in **to be welded version (ODS/024/W)** or in **to be bolted version (ODS/024/B)**. Recommended to use PTFE dry lube to get the best performance and preserve all components.

ODS/024/W

to be welded



ODS/024/WE

to be welded with connector included

Also available with 11 pin professional electrical connector included (this part is a high performance interconnection engineered with arc-shape metal guides, which ensure a rapid and precise alignment of the 11 contacts. Aluminium body, IP68 sealing, 10000 cycles guarantee, high temperature and chemical resistance)

ODS/024/B

to be bolted



ODS/024/BE

to be bolted with connector included

## FIXED STEERING WHEEL SPACERS

ODC023

ODC023181  
Anodized silver



ODC023171  
Anodized black

## WHEEL PLATE

OD/2029

Carbon fiber.  
Thickness: 2.5 mm  
For use of up to 2 buttons (included).  
2 drill points for attachment between steering wheel and hub. Fixing screws included.



Example of mounted plate

## WHEEL PLATE

OD/2026

Carbon fiber.  
Thickness: 2.5 mm  
For use of up to 4 buttons (not included).  
6 drill points for attachment. Fixing screws included.



## ADJUSTABLE STEERING WHEEL SPACERS

ODC022171

Adjustable in 4 positions:  
24 / 34 / 44 / 54 mm  
Suitable for use with a collapsible steering wheel hub (featuring a collapsible sheet metal frame).



Anodized black

## STEERING WHEEL HUBS

OD/1960/...

These steering wheel hubs have been designed so as to maintain the original steering wheel (flat model) position.  
When ordering a steering wheel hub you will be required to quote the product code as follows: OD/1960 + vehicle specific code.



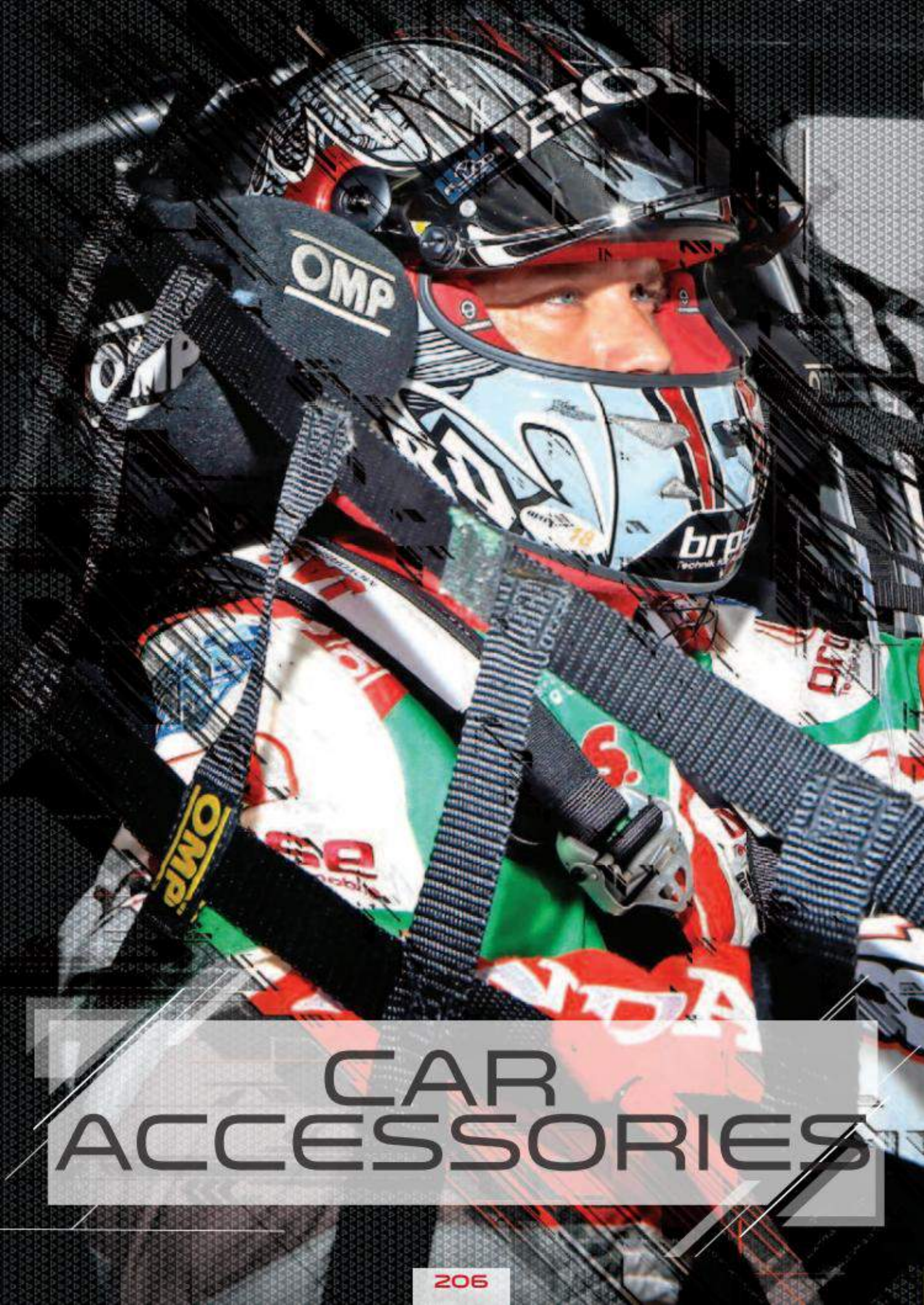

# CAR ACCESSORIES

## RACING NETS

### NA/1876

Professional entry level racing net with quick release and quick front strap adjustment to fit with several seat positions. Designed to be mounted on the left or on the right side of the driver.

FIA HOMOLOGATED  
8863-2013



MANUFACTURER: OMP  
MODEL: NA/1876  
HOM. NO: RN.010.17  
FIA STANDARD: FIA 8863-2013

### NA/1875

Professional racing net with small-sized quick release to improve driver's field of view and front strap adjustment to fit with several seat positions. Designed to be mounted on the left or on the right side of the driver.

FIA HOMOLOGATED  
8863-2013



MANUFACTURER: OMP  
MODEL: NA/1875  
HOM. NO: RN.006.16  
FIA STANDARD: FIA 8863-2013

### NA/1870/TN



Nylon window safety net.  
Attachment: velcro.  
Dimensions webbing: 60x60 mm  
FIA J 253.11 approved.

### NA/1877

Professional top level racing net with quick release, quick front strap adjustment to fit with several seat positions, large triangle to allow an easier mounting complying FIA rules and thinner straps to improve driver's field of view. Designed to be mounted on the left or on the right side of the driver.

FIA HOMOLOGATED  
8863-2013



MANUFACTURER: OMP  
MODEL: NA/1877  
HOM. NO: RN.009.16  
FIA STANDARD: FIA 8863-2013





LUCKY - E. PONS - RALLY CLUB TEAM

## NA/1700

-  NA/1700/R Red
-  NA/1700/B Blue
-  NA/1700 Trasparent



Polyethylene splash guard.  
**Dimensions:**  
 50x30 cm  
**Thick:** 1,5 mm

## NA/1819

Spare wheel support with quick release system.



## NA/1821

Combination steel cross wheel spanner and spare wheel support.



## NA/1820

Steel sheel spanner holder.



## NA/1564

Ear plugs.



## NA/1822



Nylon spare wheel down strap.

## CD/324/10/N

Fire resistant sheath.  
**Ø Internal:** 10 mm  
**Length:** 5 m

€ 11,10 (C)



## NA/1859

-  NA/1859081 Grey
-  NA/1859071 Black

Tank tape.  
**Wide:** 50 mm  
**Roll:** 50 m



## EB/489

Stainless steel pins with large slide pins.



## EB/480

M10 aluminium pins with small sliding pins in stainless steel.



## EB/492

-  EB/492/R Red
-  EB/492/A Aluminium
-  EB/492/N Black

Quick release bonnet pins aluminium W 7/16" with stainless steel hardware.



EB/492/B Blue

## EB/491

Stainless steel spring clips. Suitable for hatchbacks.



## EB/490

M10 stainless steel pins slide with large cast aluminium washers.



## EB/482

Rubber hooks (small).



## EB/487/N

Leather straps.



## EB/483

Rubber hooks (large).



## EB/571

FIA APPENDIX J art. 253

Tow hook, stainless steel painted finish.  
**Stud:** M 12  
**Internal Ø:** 50 mm  
**Thickness:** 8 mm  
**Complete:** locking nut and washers.



## EB/578/R

FIA APPENDIX J art. 253

**Straps:** 2"  
**Ø ring:** 14 mm  
**Chassis fixing:** two hole 8 mm and 14 mm



## EB/580

FIA APPENDIX J art. 253

**Straps:** 2"  
 With restraint elastic strap. Compliant with FIA rules.



## EB/576

FIA APPENDIX J art. 253

Tow hook, stainless steel painted finish.  
**Stud:** M 12  
**Internal Ø:** 80 mm  
**Thickness:** 8 mm  
**Complete:** locking nut and washers.



OA/1010



Complete 3 pedal in sandblasted aluminium, with a long accelerator pedal. Supplied with steel bolts.  
**Dimensions brake:** 60x100 mm  
**Dimensions accelerator:** 60x210 mm

OA/1000



Complete 3 pedal in sandblasted aluminium, with standard accelerator pedal. Supplied with steel bolts.  
**Dimensions brake:** 60x100 mm  
**Dimensions accelerator:** 60x100 mm

OA/2070



Driver's left footrest in knurled aluminium.  
**Dimensions:** 285x120 mm

OA/1867



Driver's left footrest for left foot, in sandblasted aluminium. Supplied with steel bolts and brackets.  
**Dimensions:** 260x100 mm

OA/1020



Complete 3 pedal in sandblasted aluminium, with a long accelerator pedal. Supplied with steel bolts.  
**Dimensions brake:** 60x70 mm  
**Dimensions accelerator:** 60x210 mm

OA/1863



Complete 3 pedal in sandblasted aluminium, with standard accelerator pedal. Supplied with steel bolts.  
**Dimensions brake:** 60x70 mm  
**Dimensions accelerator:** 85x120 mm

OA/2060



Co-driver's footrest in knurled aluminium.  
**Dimensions:** 335x300 mm

OA/2080

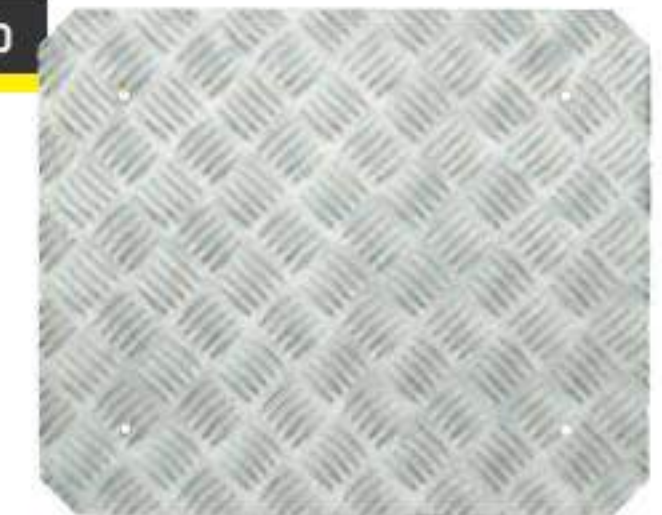

Universal flat footrest in knurled aluminium.  
**Dimensions brake:** 365x418 mm

OA/1030



Complete 3 smooth aluminium pedal, suitable for rally use, already drilled and countersunk. Supplied with steel bolts.  
**Thick:** 3 mm

OA/1050



Same features as partnumber OA/1030, but the surface of the pedals is in knurled aluminium and can be shaped as needed.  
**Thick:** 2,5 mm

OA/1866

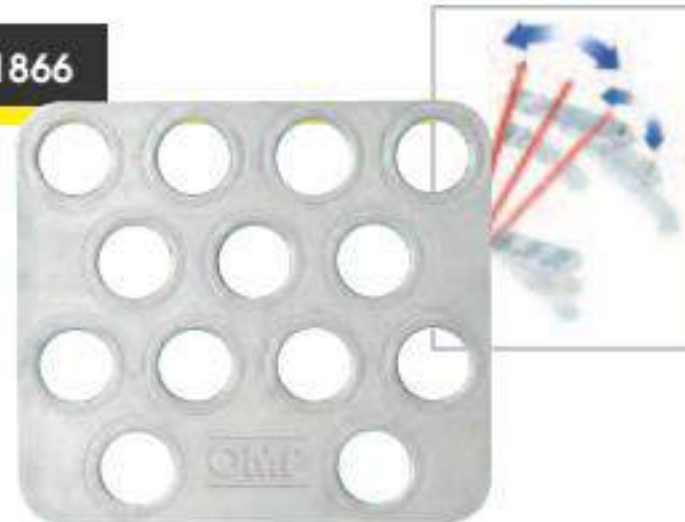

Co-driver's footrest in sandblasted aluminium. Supplied with steel bolts and brackets.  
**Dimensions:** 320x280 mm

ODA/2002



Light racing gear knob in silver anodized aluminium. Threaded coupling M8-M10.  
**Dimensions:** high 65 mm  
 Ø 50 mm

## PIT BOARDS

KC/1068

### PROFESSIONAL

Aluminium frame.  
**Dimensions:** 100x72 cm  
 Complete with 42 cards of numbers, letters and symbols measuring 23x14 cm and one customizable plate 23x65 cm supplied in a synthetic leather bag, which stores sidely on the aluminium frame when not being used.



KC/1067

### TRIPLA

Aluminium frame.  
**Dimensions:** 72x72 cm  
 Complete with 24 cards of numbers, letters and symbols measuring 23x14 cm



KC/1069

42 spare cards for pit boards KC/1067 and KC/1068, supplied in a synthetic leather carrying pouch.



## TYRE WARMERS

A line of tyre warmers available in 4 different standard sizes, offering greater versatility across a wider range of tyre sizes and now available in two types: with a standard temperature control thermostat or with a central electronic temperature control box.

**Interior:** Nomex®.

**Exterior:** Cordura® which improves transpiration allowing moisture to escape away from the tyre.

**Electrical cables and connectors are compliant with EEC electrical standards.**

Upon request, tyre warming blankets can be made to measure. Tyre warmers for motorcycles are also available upon request.

**Tyre warmers models with a Central Electronic Temperature Control Box (part number T200)** allows each of the 4 tyres to have individual temperature settings. The control box features an electronic control device controlled by software preventing overheating. The external case of the control box is ABS plastic with an electrical protection rating of IP44.

**Tyre warmers models with a Standard Temperature Control** allows the tyre surface to reach 80/85 °C. The time required to reach this temperature is depends on ambient temperature, tyre dimensions and operating conditions.

T1957C

Width: 190/220 mm Ø 570/220 mm

T1963C

Width: 190/200 mm Ø 630/640 mm

T2363C

Width: 230/260 mm Ø 630/645 mm

T2360C

Width: 230/260 mm Ø 600/620 mm

T1957

Width: 190/220 mm Ø 570/585 mm

T1963

Width: 190/200 mm Ø 630/640 mm

T2363

Width: 230/260 mm Ø 630/645 mm

T2360

Width: 230/260 mm Ø 600/620 mm

THE MEASUREMENTS REFER TO THE TYRE SIZES.

CUSTOM MADE MEASURE ON REQUEST



REMOVABLE WITH VELCRO  
 choose your colour

**NEW!**

## ELECTRICAL ACCESSORIES

### MASTER SWITCHES



FIA APPENDIX J art. 253

EA/462

6 poles with removable key disconnecting battery and alternator.

EA/464

Spare key for EA/462 model.

EA/460

2 poles with removable key disconnecting battery only.

EA/463

Spare key for EA/460 model.

### CO-DRIVER' MAP LIGHTS



KA/1035

Professional model, flexible led. Long: 50 cm

KA/1036

Professional model, flexible led. Long: 40 cm

### STAY-BARS



EB/570

Stay-bars, pair of zinc plated steel stay-bars for spotlights. **Variable length:** 130/195 mm

### PUSH-BUTTON SWITCHES

With threaded fixing nut, 2 poles.

EA/466

For interior use.

EA/467

For exterior use, water resistant.

X/181493

Rubber ring for push button EA/467.

## HANDHELD STOPWATCH

KB/1041

**CHRONOGRAPH:** with partial and total elapsed times up to 9h 59'59"99, lap times.  
**CLOCK:** with alarm clock and Pacer dater.  
**TIMER:** with countdown function.



## CO-DRIVER'S PAD

NA/1863

NA/1862



NA/1863 Size: A4  
 Pages: 130

NA/1862 Size: 17,3x22 cm  
 Pages: 130

## PENHOLDER

OC/1063



Spring penholder, 4 penholders each.

## LIQUID CRYSTAL HANDHELD STOPWATCH

KB/1040

**CHRONOGRAPH:** with split, total elapsed times up to 9h, 59', 59", 99 seconds.  
**CLOCK:** displays hours, minutes, seconds, alarm clock with 12/24h option.  
**TIMER:** with presettable countdown timer. 60 lap memory and lap counter. Shows fastest lap, slowest lap and average lap times.

60 MEMORY



## CO-DRIVER PLUS

ORA/2966

Lightweight backpack with organizational features included plenty of internal and external accessory pockets.

DIMENSIONS:  
 40x34x20 cm



## CO-DRIVER BAG

ORA/2967

Light weight sporty brief bag with removable shoulder strap.  
 DIMENSIONS: 44,5x6x25 cm



# TUNING PEDALS SETS



## OA/1067

Complete 3 pedal set in anodized aluminium and sandblasted aluminium, with short accelerator pedal; anti-slip design.  
**Dimens. brake:** 60x85 mm  
**Dimens. accelerator:** 55x106 mm  
 Supplied with steel bolts.

3 PEDALS



OA/1067/R Red



OA/1067/A Silver

OA/1067/A Silver

## OA/1069

Complete 3 pedal set, in anodized aluminium and sandblasted aluminium, with long accelerator pedal; anti-slip design.  
**Dimens. brake:** 60x90 mm  
**Dimens. accelerator:** 65x180 mm  
 Supplied with steel bolts.

3 PEDALS



OA/1069/B Blue



OA/1069/A Silver

OA/1069/R Red

## OA/1072

Complete 2 pedal set with long accelerator pedal; anodized aluminium and pressure die-caster sandblasted aluminium with anti-slip design, brake pedal for automatic transmission.  
**Dimens. brake:** 140x79 mm  
**Dimens. accelerator:** 65x180 mm  
 Supplied with steel bolts.

2 PEDALS



OA/1072/A Silver



OA/1072/N Black

## OA/1068

Complete 2 pedal set in anodized aluminium and pressure die-caster sandblasted aluminium with anti-slip design with short accelerator pedal and brake pedal for automatic transmission.  
**Dimens. brake:** 140x70 mm  
**Dimens. accelerator:** 55x106 mm  
 Supplied with steel bolts.

2 PEDALS



OA/1068/N Black



OA/1068/A Silver



## TUNING PEDALS SETS

### OA/1040

Complete 3 pedal set with short accelerator pedal in silver anodized aluminium.  
Inserts: rubber anti-slip.  
**Dimens. brake:** 60x80 mm  
**Dimens. accelerator:** 60x105 mm  
Supplied with steel bolts.

PRECURVED



## TOW HOOK

### EB/572

Aluminium tow hook, flat.  
**Thickness:** 6 mm



### EB/573

Aluminium tow hook, angled.  
**Thickness:** 6 mm



## STRUT BRACES



Steel strut brace with hardened resin paint finish and adjustable coupling.

We are the leading European manufacturer of strut braces, offering over 1000 vehicle specific applications. Our strut braces are engineered to keep suspension geometry unaltered in hard cornering, while improving feedback to the drive.



Extruded aluminium strut brace with adjustable ends and steel flanges.

## CHEMICAL PRODUCTS

### PC01001

#### FINE WHEELS

Concentrated detergent for steel wheels, alloy wheels and brake calipers.  
**Contents:** 750 ml



### PC02002

#### BLACK LIGHT

Transparent black acrylic paint for personalization of indicator lights.  
**Colours:** black, green, blue.  
**Contents:** 400 ml



### PC02001

#### FIRE PAINT

Special high temperature paint for exhaust systems, brake calipers, engines, etc.  
**Colours:** red, blue, yellow, black, silver, gold.  
**Contents:** 400 ml



# OMP STYLE

220



ADVANCED RACING TECHNOLOGY



## SPORTSWEAR

PAG 222

## BAGS

PAG 233



## ACCESSORIES

PAG 236



## PROMOTIONAL

PAG 245

221

# RACING SPIRIT SOFTSHELL

# RACING SPIRIT SOFTSHELL

## LONG SLEEVED SOFTSHELL JACKET

94% polyester 6% spandex, windproof, breathable, inner fabric in mesh, front zip, two lateral pockets with zip closure, adjustable velco wrist's closure, inner pocket with zip closure, inner adjustable string with stopper. Easy customization thanks to the zip clouser at the lining bottom.

**OR5910**

SIZES: S-XXL

€ 77,00 (P)

## NO SLEEVED SOFTSHELL JACKET

94% polyester 6% spandex, windproof, breathable, inner fabric in mesh, front zip, two lateral pockets with zip closure, inner pocket with zip closure, inner adjustable string with stopper. Easy customization thanks to the zip clouser at the lining bottom.

**OR5913**

SIZES: S-XXL

€ 69,00 (P)

**OR5910089XX**

Anthracite/black



**INNER FABRIC**  
in mesh

**TWO POCKETS**  
with zip closure

**INNER ADJUSTABLE STRING**  
with stopper

**ADJUSTABLE VELCRO**  
wrist's closure

**OR5913089XX**

Anthracite/black



**INNER FABRIC**  
in mesh

**TWO POCKETS**  
with zip closure

**INNER ADJUSTABLE STRING**  
with stopper





# RACING SPIRIT HOODIE

OR5903

SIZES: S-XXL

## ONE EVO STYLE DESIGN

Round-neck sweater with hood made of cotton fabric. Also available in neutral version without logos for team customizations upon request (OR5903N).

HOODIE

OR5903080XX

Grey

TWO POCKETS

TWO POCKETS



SET OF STRINGS (FLUO YELLOW AND FLUO GREEN) INCLUDED IN THE PACKAGE



OR5903020XX

White

# RACING SPIRIT POLO

OR5905

SIZES: S-XXL

## ONE EVO STYLE DESIGN

Short sleeved polo shirt made of cotton fabric. Also available in neutral version without logos for team customizations upon request (OR5905N).

OR5905020XX

White



OR5905080XX

Grey

# RALLY T-SHIRT

RALLY T-SHIRT  
In cotton fabric.



OR5915

ONE COLOUR:  
BLACK  
SIZE: XS-XXXL

# SENNA T-SHIRT

SENNA T-SHIRT  
In cotton fabric.



OR5916020XX White

OR5916

SIZES: XS-XXXL



OR5916071XX  
Black

# KART T-SHIRT

# STRIPED LOGO T-SHIRT

KART T-SHIRT  
In cotton fabric.

OR5917  
ONE COLOUR:  
WHITE  
SIZE: XS-XXXL

STRIPED LOGO T-SHIRT  
In cotton fabric.

OR5918  
SIZES: XS-XXXL



# RACING SPIRIT T-SHIRT

OR5904

SIZES: XS-XXXL

## SHORT SLEEVED T-SHIRT

Made in cotton fabric with "OMP" and "Racing spirit" logos.

OR5904080XX

Grey



OR5904020XX

White



# BLACK T-SHIRT

OR5907

## SHORT SLEEVED T-SHIRT

Made in cotton fabric with yellow "OMP" logo.

ONE COLOUR:  
BLACK  
SIZE: XS-XXL



CHILDREN SIZES:  
2 YEARS - 4 YEARS

ALSO FOR  
CHILDREN!



# RACING SPIRIT SHIRT

## LONG SLEEVED SHIRT

Made in cotton fabric with embroidered "OMP" logos.

OR5902

SIZES:  
38-39-40-41-42-43-44

OR5902020XX

White



OR5902080XX

Grey

# OMP BAGS

## ONE BACKPACK

ORA/2964

Tech backpack with several external pockets and inner organizer compartments. Adjustable waist, chest and shoulder belts. Made of lightweight and durable material.

COLOUR: Black

DIMENSIONS: 45 x 38 x 20 cm



## FIRST BACKPACK

ORA/2965

Sportswear backpack in resistant nylon fabric, with external pocket and a pratic handle. Length adjustable shoulder straps.

COLOUR: Black

DIMENSIONS: 40 x 30 x 18 cm



# OMP BAGS

## CO-DRIVER PLUS BACKPACK

ORA/2966

## CO-DRIVER BAG

ORA/2967

Light weight sporty brief bag with removable shoulder strap.  
DIMENSIONS: 44,5x6x25 cm

Lightweight backpack with organizational features included plenty of internal and external accessory pockets.



COLOUR: Black

DIMENSIONS: 40 x 34 x 20 cm



## TRAVEL BAG

ORA/2969

Generous dimensioned travel bag made in nylon, provided with trolley. Large central compartment, big pockets and side padded compartment. Provided with a practical adjustable shoulder strap. New anti-rollover rigid base and new fresh design.

COLOUR: Black

DIMENSIONS: 90 x 38 x 40 cm



# OMP BAGS

## RACEWEAR TROLLEY

ORA/2973

Compact trolley in lightweight and resistance fabric, with practical handles and plenty of useful pockets and inserts. Ideal for easily carry a racewear driver kit and several accessories.



COLOUR: Black

DIMENSIONS: 67 x 45 x 22 cm



## CABIN TROLLEY

ORA/2968

Ultra compact trolley. Lightweight construction, provided with trolley, with handle and several compartments and pockets. Ideal for hand-held luggage in flight.



COLOUR: Black

DIMENSIONS: 55 x 40 x 20 cm



# ACCESSORIES

## OMP UMBRELLA

PR923



Diameter: 1 m.

## SHIFT BELT

OR5883071



COLOUR: Black

ONE SIZE

## RACING SPIRIT CAP

OR5919



Cotton cap.

COLOUR: Grey OR5919080

ONE SIZE

## CAP

PR918



Cap in lightweight cotton, velcro back closure.

Racing design. COLOURS: PR918020 white, PR918071 black

PR918C

Also for children.  
One size

COLOURS: PR918C020 white,  
PR918C071 black



# WHEELED CHAIR

HA/777E

## OMP WHEELED CHAIR

Wheeled chair in synthetic leather with reclining mechanism, pneumatic seat height adjustment and adjustable armrests.



HA/777E/NR Black/red

COMFORTABLE  
seat and backrest

RECLINING MECHANISM



HA/777E/NB Black/blue



HA/777E/AIR Black with breathable airnet fabric



HA/777E/NW Black/white



HA/777E/NG Black/yellow



HA/777E/NN Black

# OMP CHAIR CUSTOMIZATION BY

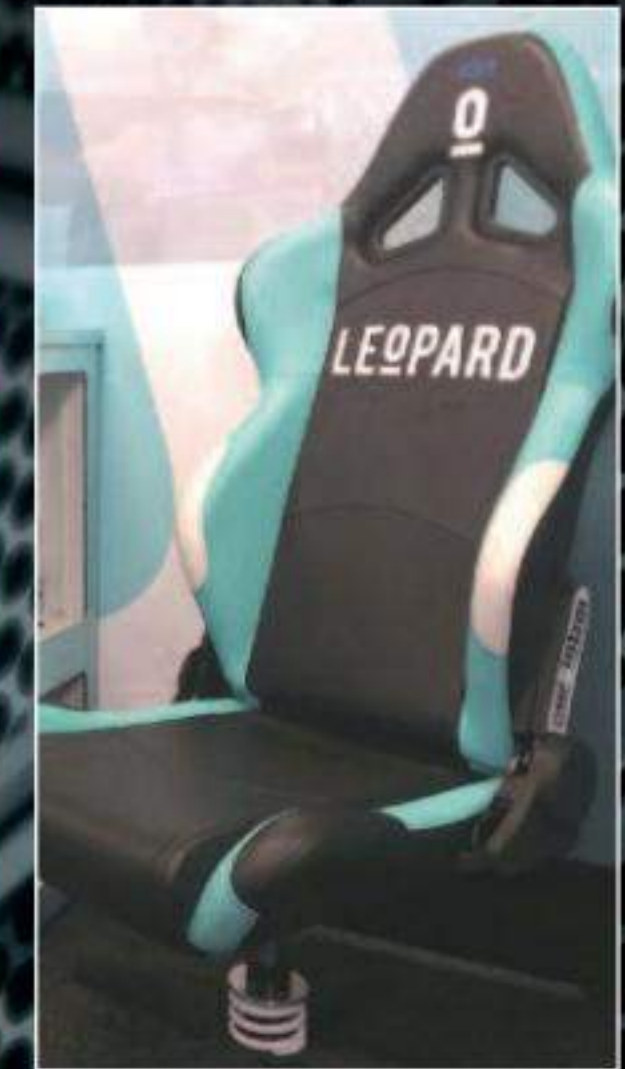

MOTO GP / MX1 / WRX





# RC-T CHILD SEAT

HA/804

## HIGH LEVEL CHILD SEAT

Adjustable inclination with practical knob, ISOFIX ready. Removable and washable upholstery in soft fabric. Waiting for ECE R129 and CCC Homolations.

**NEW!**

ADJUSTABLE HEADREST



**HA/804/NGI Black/fluo yellow**  
HOMOLOGATION  
ECE R44/04  
GROUPS 1, 2, 3  
(from 9 to 36 kg)

ADJUSTABLE BELT POSITIONING

3 points comfortable and high security harness



FEEDING BOTTLE SUPPORT

ADJUSTABLE INCLINATION  
with practical knob



**HA/804/NR**  
Black/red

# RC-S CHILD SEAT

HA/797

## HIGH LEVEL CHILD SEAT

ISOFIX attachments included. Airnet covering for the air transpiration. Quick and safe installation.

ADJUSTABLE HEADREST  
with shock absorber

ISOFIX CONNECTOR



**HA/797/BC Dark blue/cyan**  
HOMOLOGATION  
ECE R44/04  
GROUPS 1, 2, 3  
(from 9 to 36 kg)

5 POINTS SAFETY  
HARNESS WITH  
ADJUSTABLE  
POSITIONING



**HA/797/NGI**  
Black/fluo yellow

SIDE PROTECTION  
SYSTEM



**HA/797/NR**  
Black/red



REDUCER

MANUFACTURED AND DISTRIBUTED  
BY C. K. EUROPE ® S.R.L.S.

PRACTICAL TO CARRY AND PERFECT TO MOVE  
QUICKLY AROUND THE Paddock OR  
EVERYWHERE YOU WANT



### ELECTRIC SCOOTER IN CARBON FIBER 250W 24V

Electric scooter made of superlight carbon fiber  
Weight: 6.8 Kg  
Top speed: 25 Km/h  
3 version available: 10km/20km/30km  
Max load: 150 Kg  
Available colors: black carbon



### ELECTRIC SCOOTER WITH SEAT 500W 36V

Electric scooter with seat, for adults and boys  
from 14 years old. High quality materials and  
modern design, with 10" wheels, disc brake and  
chain drive. Space-saving folding chassis for an  
easier carriage  
Weight: 28 Kg  
Top speed: 25 Km/h  
Max range: 25-30 km  
Max load: 120 Kg  
Available colors: White, Black  
Homologated for road use with a mandatory  
registration.

### ELECTRIC SCOOTER FOR CHILDREN 100W 24V

Electric scooter for 4 to 15 years old children.  
Space-saving folding chassis for an easier  
carriage.  
Weight: 12 Kg  
Top speed: 12 Km/h  
Max range: 10 km with a 4 hours of recharge  
Max load: 55 Kg  
Available colors: Blue, Black, Green



### HOVERBOARD 500W

2-wheeled electric hoverboard for boys and  
adults. Suitable for moving also on long  
distance, it can be used on sidewalk, inside  
malls and around the paddock.  
Samsung Litium batteries (2x36V 4.4Ah)  
6,5" wheels.  
Recharge time 4-6 hours  
Maximum load 90 kg  
Net weight 10 kg  
Top speed: 17 Km/h  
Max range: 20 km  
Available in different colors.

# PROMOTIONAL ITEMS

PR925

A futuristic foosball table with OMP colors, ideal for your paddock hospitality. 9 balls included. Dimensions: 144x73x92 cm



PR922

Paddock stool with height adjustment, footstool, customized yellow spring.



X/963/CINT

Safety harnesses fasten structure to be matched with the seat support X/963.



X/694E/80TNT

Racing design TNT band, sold per meter. Height: 80 cm Roll: 24 m



X/694E/15

Racing design nylon band with OMP logo. Height: 15 cm Roll: 7 kg.



PR880

Lanyard.



X/867

Flag. Dimensions: 1000x1500 mm



PR921

Mechanic stool with air-operated adjustment in height, base with 5 wheels, small basket and tool case.



X/963

Steel seat display base with two bolt patterns to accommodate mounting of OMP seats.



Both bottom mounting or side mounting models with side brackets.

PR927

USB Flash Drive with case. 8 GB



PR919

Racing design mouse pad. Dimensions: 230x200 cm



PR908

Pen with pen holder.



HC/801

Wheeled office chair base. Dimensions: 345x270 mm



X/683/BR

Racing suit bag.



X/683/BK

Karting suit bag.



X/846

Assorted sticker sheet with: tow hooks, extinguisher and master switch stickers.



X/889

Assorted OMP stickers.



# CUSTOMIZED PROJECT



SQUADRA CORSE

ONE Art

# SUIT

ONE Art

# SUIT

## ONE ART SUIT "RECORD" LIMITED EDITION

Totally printed FIA top level suit.  
Regular fit with ultraflat antirubbing  
seams, soft knitted fabric inside.

MANUFACTURED  
ENTIRELY IN ITALY

NEW!

IA857LAMB-C179XX  
Black/green/yellow



INNER POCKET  
One comfortable  
hidden  
inner pocket.

IA857LAMB-C

SIZES: 46-64  
COLOR:  
ORANGE/BLACK  
sizing information  
on page 317

FRESH AIR IN HOT AIR OUT  
OMP REVOLUTIONARY COOLING SYSTEM

FLOATING SLEEVES

Semi floating arm bellows.

KNITTED MATERIAL

STRETCH DRY SYSTEM

High breathability parts  
in Dry System 3D material  
on back, hips and under  
the sleeves.



FIA APPROVED

MANUFACTURER: OMP  
MODEL: R-IA8-001  
HOM, NO: RS.297.16  
FIA STANDARD: FIA 8856-2000

## ONE ART SUIT "SPEED" EDITION

Totally printed FIA top level suit.  
Regular fit with ultraflat antirubbing  
seams, soft knitted fabric inside.

NEW!

FIA APPROVED

MANUFACTURER: OMP  
MODEL: R-IA8-001  
HOM, NO: RS.297.16  
FIA STANDARD: FIA 8856-2000



IA857LAMB-A

SIZES: 46-64  
COLOR:  
BLACK/YELLOW  
sizing information  
on page 317

MANUFACTURED  
ENTIRELY IN ITALY

IA857LAMB-A178XX  
Black/yellow

ONE Art

# SUIT

## ONE ART SUIT "SPEED" EDITION

Totally printed FIA top level suit.  
Regular fit with ultraflat antirubbing  
seams, soft knitted fabric inside.

NEW!

FIA APPROVED

MANUFACTURER: OMP  
MODEL: R-IA8-001  
HOM, NO: RS.297.16  
FIA STANDARD: FIA 8856-2000



IA857LAMB-B

SIZES: 46-64  
COLOR:  
GREY/GREEN  
sizing information  
on page 317

MANUFACTURED  
ENTIRELY IN ITALY

IA857LAMB-B188XX  
Grey/green

# ONE-S

# SUIT

IA837LAMB

SFI 3-2A/5 on request  
3 LAYERS  
SIZES: 46-64  
sizing information on page 317  
WEIGHT: 235 gr/m<sup>2</sup>



## DEVELOPED DIRECTLY FROM OMP'S TOP DRIVERS EXPERIENCE

Made of shiny, High-Tech Nomex® fabrics and innovative new inner materials, allowing a significant weight reduction. Outer pockets.

**ULTRA-FLAT**  
anti rubbing seams

**FLOATING ARMS**  
with elastic bellows

**DRY SYSTEM**  
3D breathable material

**SLIM FIT CUT**

**PRE-CURVED SLEEVES**  
for maximum comfort

**DRY SYSTEM**  
3D breathable material

**dry system**  
FRESH AIR IN HOT AIR OUT  
OMP REVOLUTIONARY COOLED SYSTEM

**FIA APPROVED**

MANUFACTURER: OMP  
MODEL: ONE S  
HOM. NO: RS.224.12  
FIA STANDARD: FIA 8856-2000



**HIPS AND LUMBAR INSERTS**  
made of soft knitted elastic fabric

# ONE-S

FOR CHILDREN!

# SUIT

IA837LAMBC2

SIZES:  
7-9 YEARS (120-140 CM)  
10-11 YEARS (140-160 CM)



## ONE-S REPLICA SUIT FOR CHILDREN FROM 7 TO 11 YEARS OLD

ONE-S replica suit for Automobili Lamborghini Squadra Corse designed for young motorsport enthusiasts, like all the tracksuits worn by the Squadra Corse racing drivers. Not FIA approved.



**NEW!**

# ONE-S

FOR CHILDREN!

# SUIT

IA837LAMBC1

SIZES:  
2-3 YEARS (80-100 CM)  
4-6 YEARS (100-110 CM)



## ONE-S REPLICA SUIT FOR CHILDREN FROM 2 TO 6 YEARS OLD

ONE-S replica suit for Automobili Lamborghini Squadra Corse designed for young motorsport enthusiasts, like all the tracksuits worn by the Squadra Corse racing drivers. Not FIA approved.



**NEW!**

# ONE VINTAGE SUIT

## RETRO RACING SUIT STYLE

Typical style worn by the great champions of F1 in the mid 70s. Produced with the same ultra-light fabrics of the new ONE EVO and ONE-S suits.

## VINTAGE STYLE

FLOATING ARMS  
with elastic bellws



OUTER POCKETS

SHAPED COLLAR  
with inner soft knitted material and pre-curved sleeves for maximum comfort

SLIM FIT  
and ultra-flat, anti-rubbing seams

IA842LAMB

SFI 3-2A/5 on request  
3 LAYERS  
SIZES: 46-64  
sizing information on page 317  
WEIGHT: 235 gr/m<sup>2</sup>

FIA APPROVED

MANUFACTURER: OMP  
MODEL: ONE BASIS  
HOM, NO: RS.224.12  
FIA STANDARD: FIA 8856-2000



ELASTIC

# ONE VINTAGE

FOR CHILDREN!

# SUIT

## ONE-S REPLICA SUIT FOR CHILDREN FROM 7 TO 11 YEARS OLD

OMP Vintage replica suit for Automobili Lamborghini Squadra Corse designed for young motorsport enthusiasts, like all the tracksuits worn by the Squadra Corse racing drivers. Not FIA approved.



NEW!

IA842LAMBC2

SIZES:  
7-9 YEARS (120-140 CM)  
10-11 YEARS (140-160 CM)

MANUFACTURED ENTIRELY IN ITALY

# ONE VINTAGE

FOR CHILDREN!

# SUIT

## ONE-S REPLICA SUIT FOR CHILDREN FROM 2 TO 6 YEARS OLD

OMP Vintage replica suit for Automobili Lamborghini Squadra Corse designed for young motorsport enthusiasts, like all the tracksuits worn by the Squadra Corse racing drivers. Not FIA approved.



NEW!

IA842LAMBC1

SIZES:  
2-3 YEARS (80-100 CM)  
4-6 YEARS (100-110 CM)

MANUFACTURED ENTIRELY IN ITALY

# ONE TOP

## ULTRA-LIGHT UNDERWEAR TOP WITH EXCLUSIVE FEATURES

Advanced technology knitted fabric with maximum breathability  
3D knitted inserts for maximum cooling in hot conditions that aligns with the breathable inserts of ONE EVO, ONE-S and TECNICA EVO suits.



ULTRA-FLAT  
and anti-rubbing  
seams



CREW-NECK TOP  
with ultra-flat seams

SLIM FIT/ATHLETIC CUT  
for increased driver  
comfort; extremely  
light, increased  
elasticity

DRY SYSTEM  
3D breathable  
material



MANUFACTURER: OMP  
MODEL: IAA/739  
FIA STANDARD: FIA 8856-2000

## IAA/739ELA

SFI on request

**SMA**

corresponding sizes XS/S  
suit sizes 44-48

**MED**

corresponding sizes M/L  
suit sizes 50-54

**XLAR**

corresponding sizes XL/XXL  
suit sizes 56-60

on request:

**2XLAR**

corresponding sizes XXXL  
suit sizes 62-64



# ONE LONG JOHNS

## ULTRA-LIGHT PANTS AND BALACLAVA WITH EXCLUSIVE FEATURES

Advanced technology knitted fabric with maximum breathability.  
3D knitted inserts for maximum cooling in hot conditions.



## IAA/740EPLA

SFI on request

**SMA**

corresponding sizes XS/S  
suit sizes 44-48

**MED**

corresponding sizes M/L  
suit sizes 50-54

**XLAR**

corresponding sizes XL/XXL  
suit sizes 56-60

on request:

**2XLAR**

corresponding sizes XXXL  
suit sizes 62-64



DRY SYSTEM  
3D breathable  
material

ULTRA-FLAT  
and anti-rubbing  
seams



MANUFACTURER: OMP  
MODEL: IAA/740P  
FIA STANDARD: FIA 8856-2000

## SOCKS

## IAA/724LAMB

SFI3.3  
SIZES:  
XS-S-M-L



MANUFACTURER: OMP  
MODEL: IAA/723  
FIA STANDARD: FIA 8856-2000

## ONE BALACLAVA

## IAA/741ELA

SIZES: S - M



DRY SYSTEM  
3D breathable  
material



MANUFACTURER: OMP  
MODEL: IAA/741  
FIA STANDARD: FIA 8856-2000



# ONE eVO

## GLOVES

IB/759/LAMB

### DEVELOPED DIRECTLY FROM OMP'S TOP DRIVERS EXPERIENCE

Ultra-light fire-retardant elastic fabric with high adhesion inserts for maximum grip.



HAND AND FINGERS SILICON WEBBING

PRECURVED  
MIXED INTERNAL/ EXTERNAL SEAMS  
SIZES: XS - XL  
sizing information on page 317



MANUFACTURER: OMP  
MODEL: ONE-EVO  
FIA STANDARD: FIA 8856-2000



INTERNAL SEAMS on the palm

LEATHER PALM internal points in antislip silicon rubber

ELASTIC WRIST STOP



# DIJON

IB/746/LAMB

### VINTAGE GLOVE

'70s design with fabrics and quality of last generation gloves. Fire-resistant fabric with stretch suede inserts. Internal seams.



MANUFACTURER: OMP  
MODEL: DIJON  
FIA STANDARD: FIA 8856-2000

ELASTIC WRIST STOP

VINTAGE STYLE



PRECURVED  
SIZES: S - XL  
sizing information on page 317

SUEDE LEATHER INSERTS on palm and fingers for very good grip



# HARNES PAD

### PAIR OF HARNES PADS

In velour, to be used with 2" seat belts or child seat's belts, velcro fastening.

**NEW!**

DB/454/LAMB



# TAZIO

IB/747/LAMB

### VINTAGE GLOVE

Smooth leather and cotton fabric.

INTERNAL SEAMS in forefinger and thumb for maximum accuracy on commands

PRECURVED  
SIZES: S - XL  
sizing information on page 317



STRAP WITH VELCRO

VINTAGE STYLE

# ONE-S

## SHOES

IC/807LAMB

SFI 3-2A/5 on request

SIZES: 37-48

sizing information on page 317

### ONE-S SHOES

Top level leather boot. Technical reinforcements on the tip and on the heel. Injected high resistant sole and best grip. Velcro strap for a best fitting of the ankle. Inner sole with plate reinforcement for highest sensitivity and reduction of the stress on the feet. Thin laces to guarantee and permit a good sliding and a quick lacing of the boots.

VELCRO STRAP

for a best fitting of the ankle



THIN LACES

for high sliding and quick lacing

INJECTED SOLE

for maximum grip and resistance to wear

INNER SOLE

with plate reinforcement for highest sensitivity and reduction of stress on the feet.

TECNICAL REINFORCEMENTS

on the tip and on the heel

FIA APPROVED

MANUFACTURER: OMP  
MODEL: IC/801 ONE S  
FIA STANDARD: FIA 8856-2000

# CARRERA

## SHOES

IC/784LAMB

SIZES: 37-48

sizing information on page 317

### VINTAGE CLASSIC BOOTS

Polished leather lined in soft jersey. Molded rubber sole resistant to hydrocarbons.

High quality treated leather for an ultra-soft feel. Accurate hand-made production.

EMBOSSED

with leather logo



VINTAGE STYLE

FIA APPROVED

MANUFACTURER: OMP  
MODEL: NURBURGRING  
FIA STANDARD: FIA 8856-2000

# OMP CHAIR

HA/777/LAMB

Wheeled chair in synthetic leather with reclining mechanism, pneumatic seat height adjustment and adjustable armrests.



COMFORTABLE seat and backrest

RECLINING MECHANISM

# BLAST

# SUIT

## SUPER RESISTANT MECHANICS OVERALL

Polyester - cotton fabric resistant to repeated washing and most stubborn stains.



ARMBELLOWS  
in knit elastic fabric

MECHANICS'

### TECHNICAL INFORMATION

1 LAYER  
SIZES: 44-64  
sizing information on page 317

NB1578LAMB

# KS-1R

# SUIT

## ULTRA LIGHT TOTALLY PRINTED SUIT

High comfort due to the new soft and light fabrics, elastic crotch insert, new semi-floating stretch sleeves with mesh inserts for best ventilation. Stretch inserts on lower back and inner knee pads for protection.



KK720LAMB

HOMOLOGATION  
CIK - FIA level 2  
SIZES: 44-62  
for children:  
120/130/140/150/160  
height  
sizing information on page 317

MESH INSERTS

SEMI FLOATING SLEEVES

**NEW!**



ELASTIC CROTCH INSERTS



ALSO FOR CHILDREN!

FIA APPROVED

MANUFACTURER: OMP  
MODEL: K-KK-001  
HOM. NO: CIK-FIA 20B/026  
FIA STANDARD: 2013-1

PADDED INSERTS

# WORKSHOP GLOVE

## TECHNICAL SHORT GLOVE

Not fire resistant, for professional use. Back in technical elastic fabric with leather inserts. Palm in suede leather for best fitting and adherence. Elastic bend and technical velcro closure.



MECHANICS'

# GLOVE

NB/1886/LAMB

# KS-1R

## GLOVE

KK02740LAMB

SIZES: XXS - XL  
sizing information on page 317



### KS-1 R GLOVES

Elasticized super top karting glove. Silicone inserts on the palm, precurved for maximum grip. External seams for maximum sensitivity.

**NEW!**



# KS-1R

## SHOES

IC/810LAMB

SIZES: 34-47  
sizing information on page 317



### TOP LEVEL KARTING SHOES

Super top boots with new generation sole which guarantees highest sensitivity, featuring Rotor lacing inspired by the fireproof ONE EVO R boots. Made of perforated microfiber with technical protection on the tip.



**NEW!**

## KS SUMMER SHIRT

KK03016LAMB

Stretch fabric, hydrophobic highly hygienic hollow fiber. Ultra-low density jacquard weaving for high breathability. Ideal in hot conditions.

SIZES:  
XS-S (44-48)  
M-L (50-54)  
XL (56-60)  
XXL



**NEW!**



## KS SUMMER SHORTS

KK03017LAMB

Stretch fabric, hydrofobic highly hygienic hollow fiber. Low density jacquard weaving for high breathability for use in hot conditions.

SIZES:  
XS-S (44-48)  
M-L (50-54)  
XL (56-60)  
XXL



**NEW!**

## KS SUMMER BALACLAVA

KK03018LAMB

Hydrofobic highly hygienic hollow fiber. Low density jacquard weaving for high breathability for use in hot conditions.

ONE SIZE

**NEW!**



## KS SOCKS

KK03019LAMB

Technical socks with differentiated weave. Mid length.

SIZE S-M-L



**NEW!**



# FOOTBALL TEAMS

Standard OMP products or designed on specific customer requests are also used in areas different from the motorsport, for example in football stadiums (benches), on ultralight airplanes and military aircrafts.



Genoa CFC office chairs  
(blue/red HA/777/GEN/BR -  
red/blue HA/777/GEN/RB)



Sampdoria office  
chair (HA/777E/SAM/BW)



# KART WORLD



# K5 Art SUITS

This model of suit can be customized through the use of images, photos and color blendings. This peculiar feature is possible thanks to our proprietary technology "OMP Print Art". In order to outline what spaces are at the customer's disposal for personalization, we show you the exploded view of those areas.



TONY KART



FZA



KOSMIC



RACING KART



EXPRIT



IPKarting S.r.l.



IPKarting S.r.l.



IPKarting S.r.l.



Lentzokart



IPKarting S.r.l.



LUXOR



PAROLIN



Kart



JESOLO



CKA



**K5**

*Art*

# SUIT

**KK01726**

**KK01726C**  
FOR CHILDREN

HOMOLOGATION  
CIK - FIA level 2  
SIZES: 44-62  
for children:  
120/130/140/150/160  
height

sizing information on page 317

## TOTALLY PRINTED KART TOP LEVEL SUIT

Developed with the most important karting teams and drivers. Available in three colors with a modern printed graphic.

*Unlimited customization way thanks to the totally printed design.*

**NEW!**

MANUFACTURED  
ENTIRELY IN ITALY

ELASTIC INSERTS

SEMI FLOATING ARMS

WITHOUT SEAMS  
on waist

STRETCH INSERTS

**KK01726073XX**  
Black/red/white

ELASTIC INSERTS

PADDED INSERTS

**ALSO FOR  
CHILDREN!**

**FIA APPROVED**

MANUFACTURER: OMP  
MODEL: K-KK-001  
HOM. NO: CIK-FIA 20B/026  
FIA STANDARD: 2013-1



D. VIDALES - TONY KART RACING TEAM



**IA01720232XX**  
Black/green/yellow



**IA01726242XX**  
Navy blue/white/cyan

# KS-1R

# SUIT

KK01720

KK01720C  
FOR CHILDREN

HOMOLOGATION  
CIK - FIA level 2  
SIZES: 44-62  
for children:  
120/130/140/150/160  
height  
sizing information on page 317

## ULTRA LIGHT TOTALLY PRINTED SUIT

High comfort due to the soft and light fabrics, elastic crotch insert, new semi-floating stretch sleeves with mesh inserts for best ventilation. Stretch inserts on lower back and inner knee pads for protection.



SEMI FLOATING SLEEVES

ALSO FOR CHILDREN!

STRETCH INSERTS



ELASTIC INSERTS

KK01720370XX

Black/grey/fluo yellow



KK01720244XX Blue navy/cyan

PADDED INSERTS



MANUFACTURER: OMP  
MODEL: K-KK-001  
HOM. NO: CIK-FIA 20B/026  
FIA STANDARD: 2013-1



R. GREGORINI



P. PIACSEK JR. - FK

# KS-2R

# SUIT

## TOP LEVEL KARTING SUIT TOTALLY PRINTED

Without seams on waist to increase driver's comfort. Elastics insert on groin, underfoot retainer, comfortable padding on knees, high breathability inserts under the sleeves, mesh inserts on shoulder and pockets to improve ventilation, low cut neck and velcro wrist closure.



FLOATING SLEEVES

Floating arm bellows.

MESH INSERTS

FLOATING SLEEVES

ELASTIC CROTCH INSERTS

PADDED INSERTS



KK01725

KK01725C  
FOR CHILDREN

HOMOLOGATION

CIK - FIA level 2

SIZES: 44-62

for children:

120/130/140/150/160

height

sizing information on page 317

KK01725247XX

Blue/yellow

ALSO FOR  
CHILDREN!



KK01725172XX Black/silver/red



MANUFACTURER: OMP  
MODEL: OMP KS-1 KARTING  
HOM. NO: CIK-FIA 2013/004  
FIA STANDARD: 2013-1

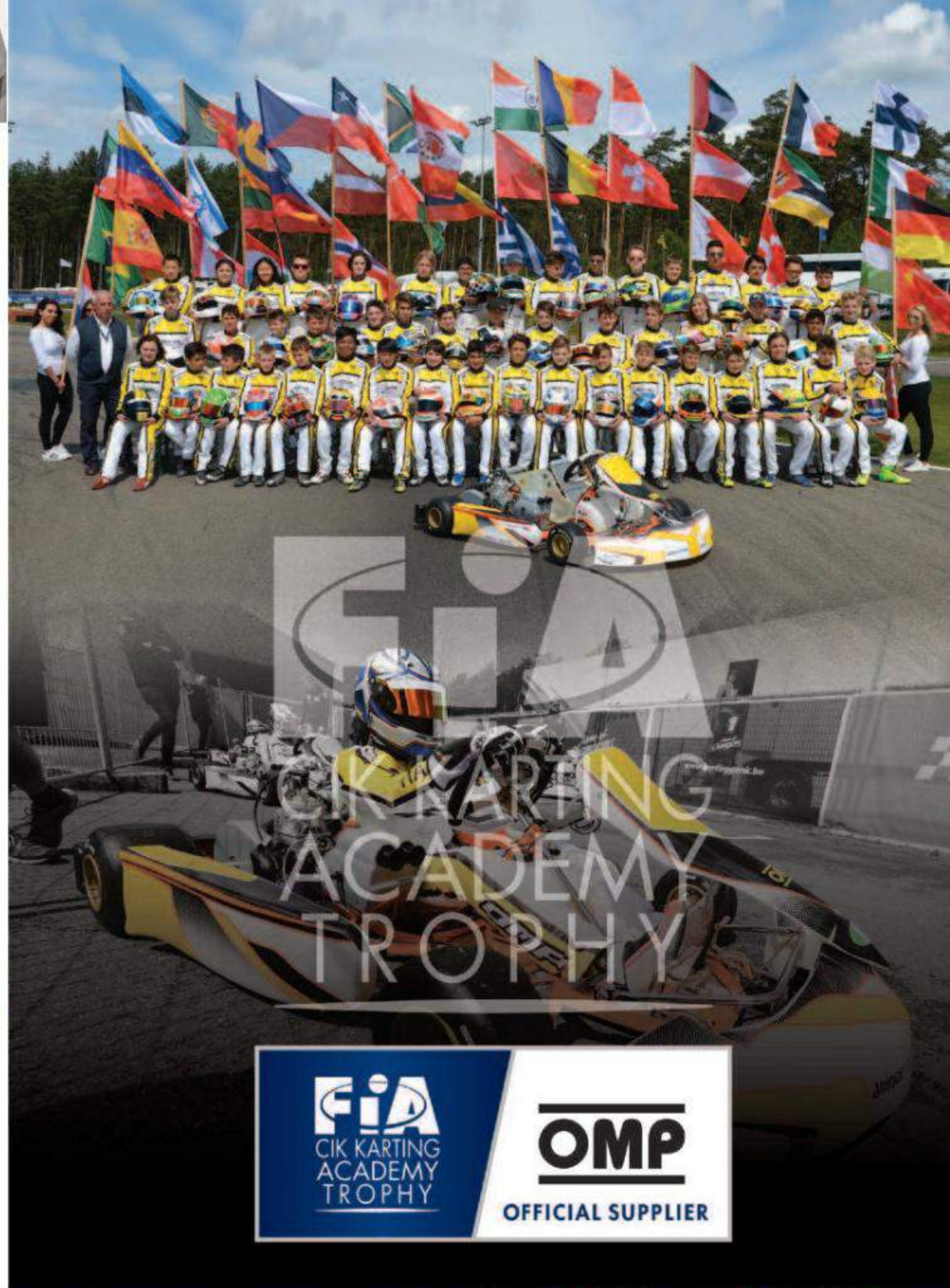



# KS-3

# SUIT

# KS-4

# SUIT

### CLASSIC AND FLUO COLOURS SUIT

Karting suit with exterior in cordura, interior in soft cotton sponge. Revised fit for improved comfort and ergonomic driving position. Outer pockets.

**ALSO FOR CHILDREN!**



KK01723L179XX Black/fluo orange



KK01723L178XX Black/fluo yellow



KK01723L275XX Black/fluo cyan



KK01723089XX Grey/black



KK01723043XX Blue/white



KK01723063XX Red/white



KK01723076XX Black/white



LOW CUT COLLAR

KK01723L274XX

Black/fluo green

FULL FLOATING ARMS



MANUFACTURER: OMP  
MODEL: OMP KS-3 KARTING  
HOM. NO: CIK-FIA 2013/007  
FIA STANDARD: 2013-1

MESH INSERTS

on thighs area to improve ventilation



KK01723

KK01723C  
FOR CHILDREN

KK01723L  
FLUO

KK01723LC  
FLUO FOR CHILDREN

HOMOLOGATION

CIK - FIA level 2

3 LAYERS

SIZES: 42-62

for children:

120/130/140/150/160 height

sizing information on page 317

### HARDY KARTING SUIT

Outer layer in polyester, interior in soft cotton sponge. Outer pockets.

**ALSO FOR CHILDREN!**



KK01724061XX

Red



KK01724071XX

Black



MANUFACTURER: OMP  
MODEL: OMP KS-4 KARTING  
HOM. NO: CIK-FIA 2013/16  
FIA STANDARD: 2013-1



LOW CUT COLLAR

ARM BELLOW

in elastic knitted fabric for maximum freedom of movement

KK01724041XX

Blue

KK01724

KK01724C  
FOR CHILDREN

HOMOLOGATION

CIK - FIA level 1

4 LAYERS

SIZES: S-XXL

for children:

120/130/140/150

height

sizing information on page 317

# SUMMER K

# SUIT

# RAIN K

# SUIT

## ONE LAYER KARTING SUIT

Made of lightweight and durable cotton fabric, ideal for indoor karting. Outer pockets.



### ARM BELLOW

in elastic knitted fabric for maximum freedom of movement

**KK01719061XX**

Red



**ALSO FOR CHILDREN!**



**KK01719041XX**

Blue



**KK01719071XX**

Black



**KK01719**

**KK01719C  
FOR CHILDREN**

1 LAYERS  
SIZES: S-XXL  
for children:  
120/130/140/150 height

sizing information  
on page 317

## RAIN SUIT

Rainproof kart over suit made in transparent PVC (0,2mm thick). Waterproof suit sack included.

**ALSO FOR CHILDREN!**

**KK03102**

SIZES: XXS-XXL



HEAT WELDED SEAMS

DOUBLE CLOSURE  
with zip and clips

ELASTIC BELLOWS

COMFORTABLE  
STRETCH BAND

ELASTIC ANKLE BELLOWS  
with zip closure improve fitting

# KS WINTER

## KS WINTER-R SHIRT

KK03021E



KK03021E071XX

Black

Long sleeved underwear shirt for winter use made of new stretch fabric. Realized with "3D" seamless technology for the best freedom of movement and comfort.

SIZES:

S/M (corresponding suit sizes 44-48)

L/XL (corresponding suit sizes 50-54)

XXL/XXXL (corresponding suit sizes 56-60)

## KS WINTER-R PANTS

KK03022E



KK03022E071XX

Black

Long johns for winter use made of new stretch fabric. "3D" seamless technology for the best freedom of movement and comfort.

SIZES:

S/M (corresponding suit sizes 44-48)

L/XL (corresponding suit sizes 50-54)

XXL/XXXL

(corresponding suit sizes 56-60)

## KS WINTER-R BALACLAVA

Kart balaclava for winter use made of new stretch fabric. Made with "3D" seamless technology for the best comfort.  
Size: one size fits all.



KK03020E



KK03020E071XX

Black

# KS SPRING

## SHIRT

KK03012

### LONG SLEEVED KART TOP

Long sleeved shirt, hydrofobic highly hygienic hollow fiber. Crew neck top with ultra flat seams. Compact weaving for thermal insulation.

HIGH BREATHABLE fabric inserts



SLIM FIT DESIGN extremely light and stretchy

KK03012020XX

White

SIZES:

SMA

(corresponding sizes XS/S - suit sizes 44-48)

MED

(corresponding sizes M/L - suit sizes 50-54)

XLAR

(corresponding sizes XL/XXL - suit sizes 56-60)



KK03012071XX

Black

# KS SUMMER

## SHIRT

KK03016

### SHORT SLEEVED T-SHIRT

Stretch fabric, hydrophobic highly hygienic hollow fiber. Ultra-low density jacquard weaving for high breathability. Ideal in hot conditions.

LOW DENSITY JACQUARD



ULTRA-FLAT

anti rubbing seams

KK03016020XX

White

SIZES:

SMA

(corresponding sizes XS/S - suit sizes 44-48)

MED

(corresponding sizes M/L - suit sizes 50-54)

XLAR

(corresponding sizes XL/XXL - suit sizes 56-60)



## KS SUMMER BALACLAVA

KK03018

Hydrofobic highly hygienic hollow fiber. Low density jacquard weaving for high breathability for use in hot conditions.

KK03018020 White  
ONE SIZE

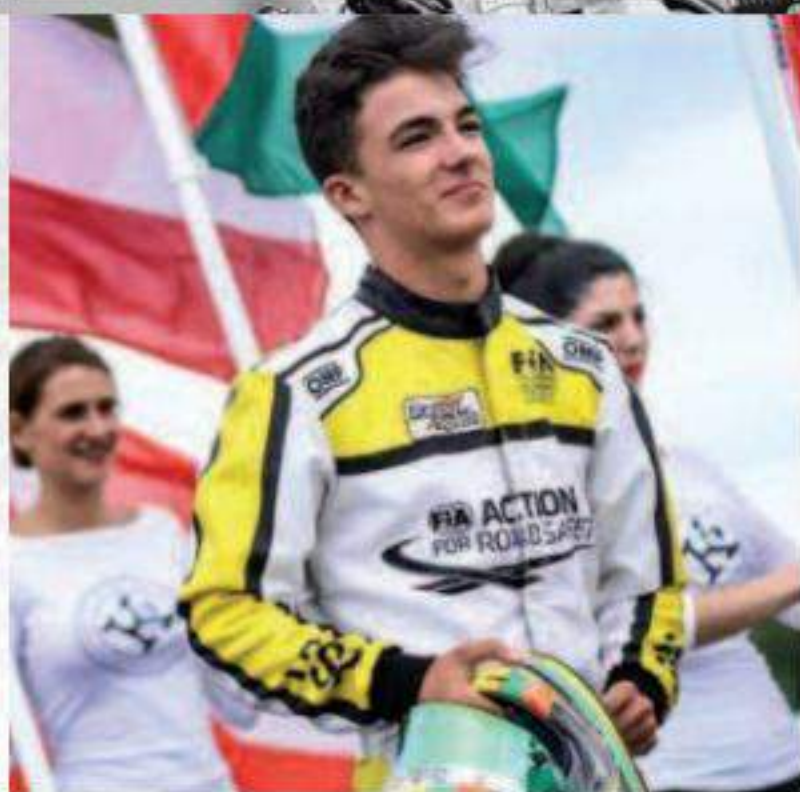

OK FIA ACADEMY TROPHY

## BALACLAVA

KK03005

Knit cotton, open face balaclava.

KK03005020 White  
ONE SIZE

KK03005061 Red

KK03005041 Blue

KK03005071 Black



## KS SUMMER SHORTS

KK03017

Stretch fabric, hydrofobic highly hygienic hollow fiber. Low density jacquard weaving for high breathability for use in hot conditions.



KK03017020XX White

SIZES:

SMA (corresponding sizes XS/S - suit sizes 44-48)

MED (corresponding sizes M/L - suit sizes 50-54)

XLAR (corresponding sizes XL/XXL - suit sizes 56-60)



## BALACLAVAS

KK03004

Open face disposable balaclavas. Anallergenic. Packages: 25 pieces.

ONE SIZE



## KS SOCKS

KK03019



KK03019020XX White

KK03019071XX Black

Technical socks with differentiated weave. Mid lenght.

SIZE S-M-L



D. MDALES - TONY KART RACING TEAM



OK FIA ACADEMY TROPHY

**K5**

*Art*

# GLOVES

KK02746

SIZES: XS-XL  
sizing information on page 317

## TOP LEVEL KART GLOVES WITH TOTALLY PRINTABLE DESIGN

AVAILABLE ONLY UPON REQUEST

Made in stretch fabric, it is possible to customize the gloves. Unlimited customization ways thanks to the totally printed design.

**NEW!**

MANUFACTURED ENTIRELY IN ITALY



**K5**

*Art*

# GLOVES

This model of glove can be customized through the use of images, photos and color blendings. This peculiar feature is possible thanks to our proprietary technology "OMP Print Art". In order to outline what spaces are at the customer's disposal for personalization, we show you the exploded view of those areas.





# KS-1R

## GLOVES

KK02740

SIZES: XXS - XL  
sizing information on page 317



### KS-1 R GLOVES

Elasticized super top glove. Silicone inserts on the palm, precurved for maximum grip. External seams for maximum sensitivity.

EXTERNAL SEAMS



KK02740071XX Black/white/silver

ULTRA-GRIP

is used on the fingertips and forefingers for maximum grip on the steering wheels



SILICONE INSERTS

ELASTIC BAND on the wrists

SLANTED CUT

# KS-2R

## GLOVES

KK02747

SIZES: XXS-XL  
sizing information on page 317

CHILDREN SIZES: 4-6

4	XXXXXS
5	XXXXS
6	XXXS

### PROFESSIONAL KART GLOVE

Kart gloves made of resistant and comfortable stretch fabric. Bellows on knuckles and fingers for best freedom of movement and breathable inserts in mesh fabric to increase comfort. Fresh design and modern color range.

EXTERNAL SEAMS

**NEW!**

KK02747058XX

Yellow fluo/green fluo



KK02747060XX Red/black



KK02747242XX Navy blue/white/cyan



KK02747120XX White/red/black



KK02747071XX Black



RUBBER PROTECTION

**ALSO FOR CHILDREN!**

SILICONE RUBBER INSERTS

NEOPRENE INSERT ON THE WRIST for easy fitting

ELASTIC WRIST STOP

# KS-3

## GLOVES

KK02743E

### PROFESSIONAL KART GLOVE

Kart gloves made of resistant and comfortable stretch fabric. Synthetic leather palm with silicon rubber inserts for the best grip. Elastic wrist stop to increase comfort and rubber protection on knuckles.

SIZES: XXS-XL  
sizing information on page 317  
CHILDREN SIZES: 4-6

4	XXXXXS
5	XXXXS
6	XXXS

**ALSO FOR CHILDREN!**

**NEW!**

INTERNAL SEAMS

RUBBER PROTECTION

RUBBER INSERTS

SYNTHETIC LEATHER PALM  
with antiskid rubber inserts

ELASTIC WRIST STOP

KK02743E096XX  
Black/orange fluo



KK02743E076XX Black/white



KK02743E175XX Black/blue/white



KK02743E270XX Black/fluo green/white



KK02743E060XX Black/red



KK02743E059XX Black/fluo yellow

# KS-4

## GLOVES

KK02744E

### PROFESSIONAL KART GLOVE

Kart gloves made of resistant and comfortable stretch fabric. Palm in suede leather, elastic wrist stop to increase comfort, adjustable leather strap on wrist with velcro closure.

SIZES: XXS-XL  
sizing information on page 317  
CHILDREN SIZES: 4-6

4	XXXXXS
5	XXXXS
6	XXXS

**NEW!**

**ALSO FOR CHILDREN!**

INTERNAL SEAMS

KK02744E178XX Yellow fluo/black



KK02744E060XX Red/black



KK02744E277XX Purple/black



KK02744E146XX Blue/black



KK02744E071XX Black



KK02744E274XX  
Green fluo/black



ADJUSTABLE LEATHER STRAP

ELASTIC WRIST STOP

SYNTHETIC LEATHER PALM



# GLOVES

# RAIN K

## ARP - ADVANCED RAIN PROOF GLOVES WATER REPELLENT EXTERNAL TREATMENT

Rainproof kart gloves with waterproof membrane to protect hands against rain and bad weather.

**KK02745**

SIZES: XXS-XXL  
sizing information on page 317



## NEOPRENE KARTING GLOVE

Water and wind resistant.

**KK02739**

SIZES: XXS-XL  
sizing information on page 317

CHILDREN SIZES: 4-5



4	XXXXXS
5	XXXXS

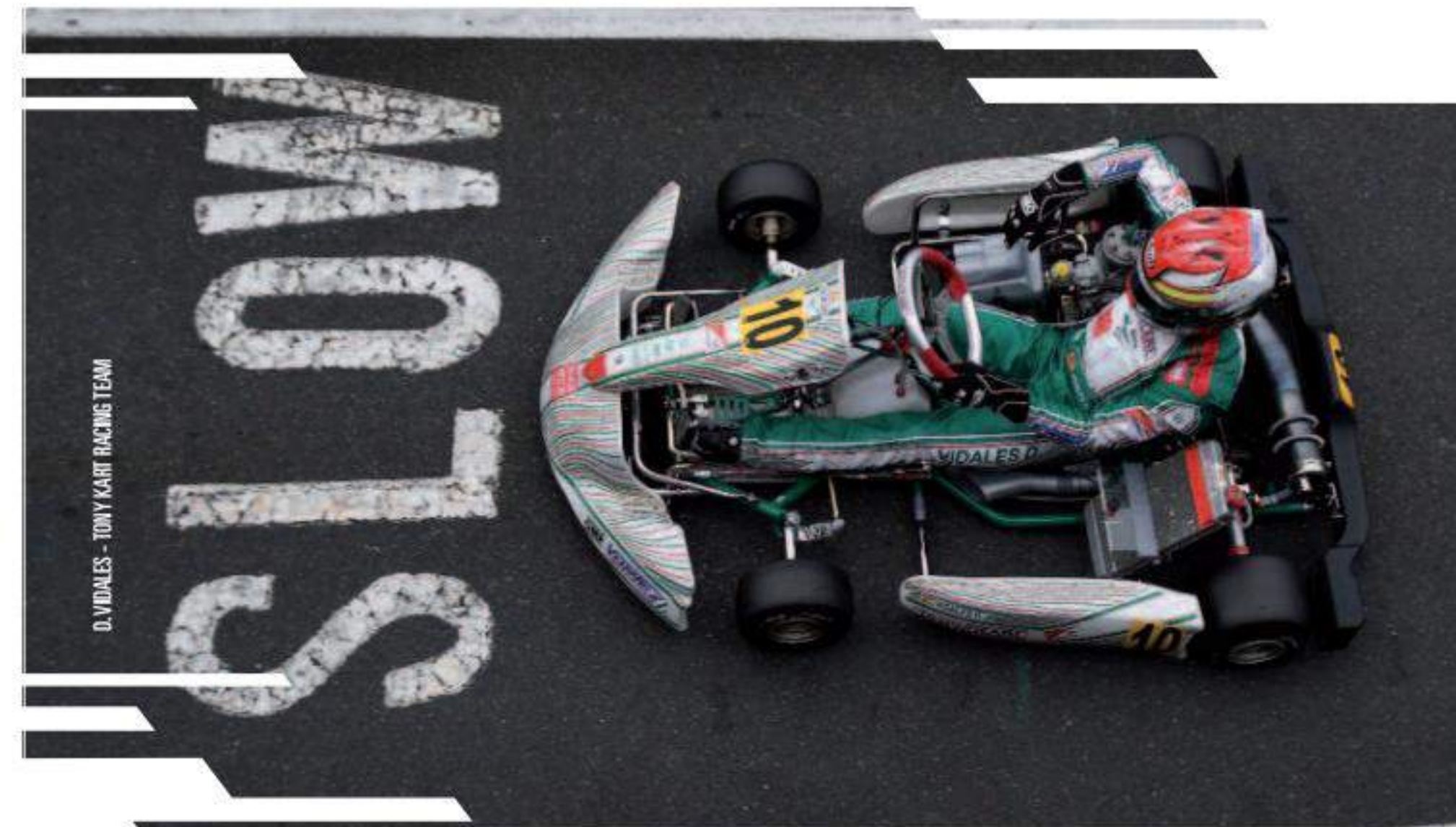

**K5**

*Art*

# SHOES

IC/818

SIZES: 34-48  
sizing information on page 317

## HIGH LEVEL PROFESSIONAL KART BOOTS WITH TOTALLY PRINTABLE DESIGN

### AVAILABLE ONLY UPON REQUEST

It's possible to customize the shoes by adding/removing the inner foot support to get more comfort/sensibility. Unlimited customization ways thanks to the totally printed design.



REAR BELLOW

**NEW!**



PIVOT-LIKE HEEL DESIGN

for smooth pedal actuation

NO-LACES

elastic fit with adjustable velcro strap to give the best comfort



ONE PIECE OF SOFT FABRIC

HIGH RESISTANT SIDE protection on tip

# K5 *Art* SHOES

This model of shoes can be customized through the use of images, photos and color blendings. This peculiar feature is possible thanks to our proprietary technology "OMP Print Art". In order to outline what spaces are at the customer's disposal for personalization, we show you the exploded view of those areas.



IC/810

SIZES: 34-47  
sizing information on page 317

### TOP LEVEL KARTING SHOES

Super top boots with new generation sole which guarantees highest sensitivity, featuring Rotor lacing inspired by the fireproof ONE EVO R boots. Made of perforated microfiber with technical protection on the tip.



**INJECTED SOLE**  
for maximum grip and resistance to wear



REAR BELLOW

**EXCLUSIVE ROTOR-LACING**  
for micro adjustment and a perfect fitting

**PIVOT-LIKE HEEL DESIGN**  
for smooth pedal actuation

**IC/810071XX**  
Black/silver

**PERFORATED MICROFIBER**  
for maximum breathability



**SIDE REINFORCEMENT ON THE TIP**

IC/815

SIZES: 37-48  
34-46 ONLY FLUO YELLOW  
sizing information on page 317

### TOP LEVEL KARTING SHOES

Top level karting shoes, derived directly from F1&WRC racing shoes. Realized in polyurethane, with ultralight outsole specifically designed for karting that guarantees the highest sensitivity when driving. Rear inserts in elastic padded material for improved comfort, separate ankle adjustment with velcro strap, pivot heel design for smooth actuation. Large areas in mesh fabric for best breathability.



**REAR INSERTS**  
in elastic padded material for improved comfort



**INJECTED SOLE**  
for maximum grip and resistance to wear

**PIVOT-LIKE HEEL DESIGN**  
for smooth pedal actuation

**IC/815058XX**  
Fluo yellow/fluo green

**DRILLED AREA**  
for best breathability



**IC/815070XX**  
Black/white/grey

**NEW FOOT SUPPORT**  
to reduce stress on the foot and provide maximum drive sensitivity



**IC/815120XX**  
White/black/red



**IC/815270XX**  
Black/white/fluo green



**IC/815244XX**  
Blue navy/white/cyan

# KS-2

## SHOES

IC/812

SIZES: 32-47  
sizing information on page 317

### MICROFIBER SHOES



with black, fluo yellow, anthracite and white strings in the same package

IC/812059XX  
Fluo yellow/black/white



SEPARATE ANKLE ADJUSTMENT  
with velcro strap

OUTSOLE  
specifically designed for karting

MESH INSERTS

ALSO FOR CHILDREN!



IC/812120XX  
White/black/red



IC/812273XX  
Black/white/red



IC/812242XX  
Blue/black/white



with black, red and white strings in the same package



with black, red and white strings in the same package



with black, cyan and white strings in the same package

# KS-3

## SHOES

IC/813

SIZES: 32-47  
sizing information on page 317

### SUEDE LEATHER SHOES



with black, fluo yellow, anthracite and white strings in the same package

IC/813184XX  
Anthracite/white/fluo yellow

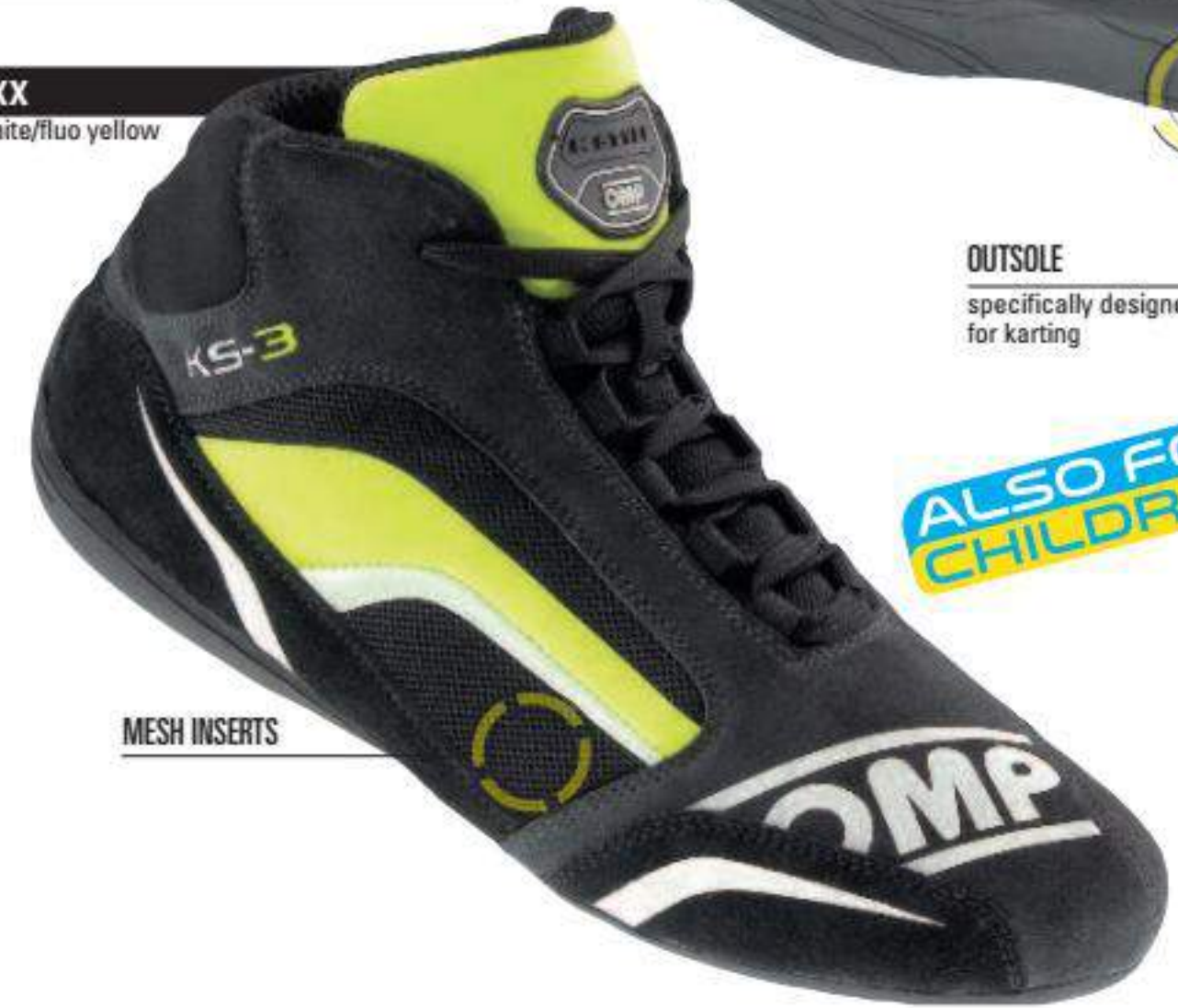

OUTSOLE  
specifically designed for karting

MESH INSERTS

ALSO FOR CHILDREN!



IC/813077XX  
Black/white/anthracite



NEW COLOUR  
SPARE LACES



with black, fluo yellow, fluo green, fluo orange, cyan, red, magenta and anthracite strings in the same package



with black, magenta and cyan strings in the same package

IC/813241XX  
Blue/white/cyan

NEW COLOUR  
SPARE LACES





# SHOES

IC/817

SIZES: 34-48  
sizing information on page 317

## ARP - ADVANCED RAIN PROOF SHOES SUITABLE FOR DRIVING IN ALL WEATHER CONDITIONS, NOT ONLY WHILE RAINING

High-height kart boots in polyurethane with waterproof membrane under the laces and high ankle height ankle to protect feet against rain and bad weather.



### INJECTED SOLE

for maximum grip and resistance to wear

**NEW!**

### REAR BELLOW



### PIVOT-LIKE HEEL DESIGN

for smooth pedal actuation

### ADJUSTABLE DOUBLE STRAP

with velcro closure



IC/81707XX

Black

# HOME AND DRY



## THE ULTIMATE ANTI-RAIN TECHNOLOGY



# GP 8K

## HELMET

SC785K

HOMOLOGATION:

SNELL 2015

FIA 8859-2015 mounting Hans® safety device clips (not included)

TWO SHELL SIZES

SIZES: XS-XXL

sizing information on page 317

### FULL FACE KARTING HELMET

Made in composite material. Lightweight, with soft and comfortable high breathability fire retardant internal lining, bordered strap with double ring clousure and high precision adjustable visor with easy block system.

AIR VENTS

and intakes to ensure the best air ducting

REAR SPOILER

EASY BLOCK SYSTEM



# KJ-8

## HELMET

SC790

HOMOLOGATION:

CMR 2016

TWO SHELL SIZES

SIZES: XXS-L

sizing information on page 317

### FULL FACE KARTING HELMET

CMR helmet made in composite material. Lightweight, with soft and comfortable high breathability internal lining, bordered strap with double ring clousure and high precision adjustable visor with easy block system.

AIR VENTS

and intakes to ensure the best air ducting

EASY BLOCK SYSTEM



FOR CHILDREN!





# CIRCUIT

## HELMET

SC611E

HOMOLOGATION  
ECE 22.05

SIZES: XS-XXL  
sizing information on page 317

### FULL FACE KARTING HELMET

Full face thermoplastic helmet, velvet lining (not fireproof), step setting visor.



# STAR

## HELMET

SC607E

HOMOLOGATION  
ECE 22.05

SIZES: S-XXL  
sizing information on page 317

### OPEN FACE KARTING HELMET

Open face helmet with ABS shell, velvet lining not fireproof, with revomable peak.



# HELMET ACCESSORIES

## GP 8K (SC785K)

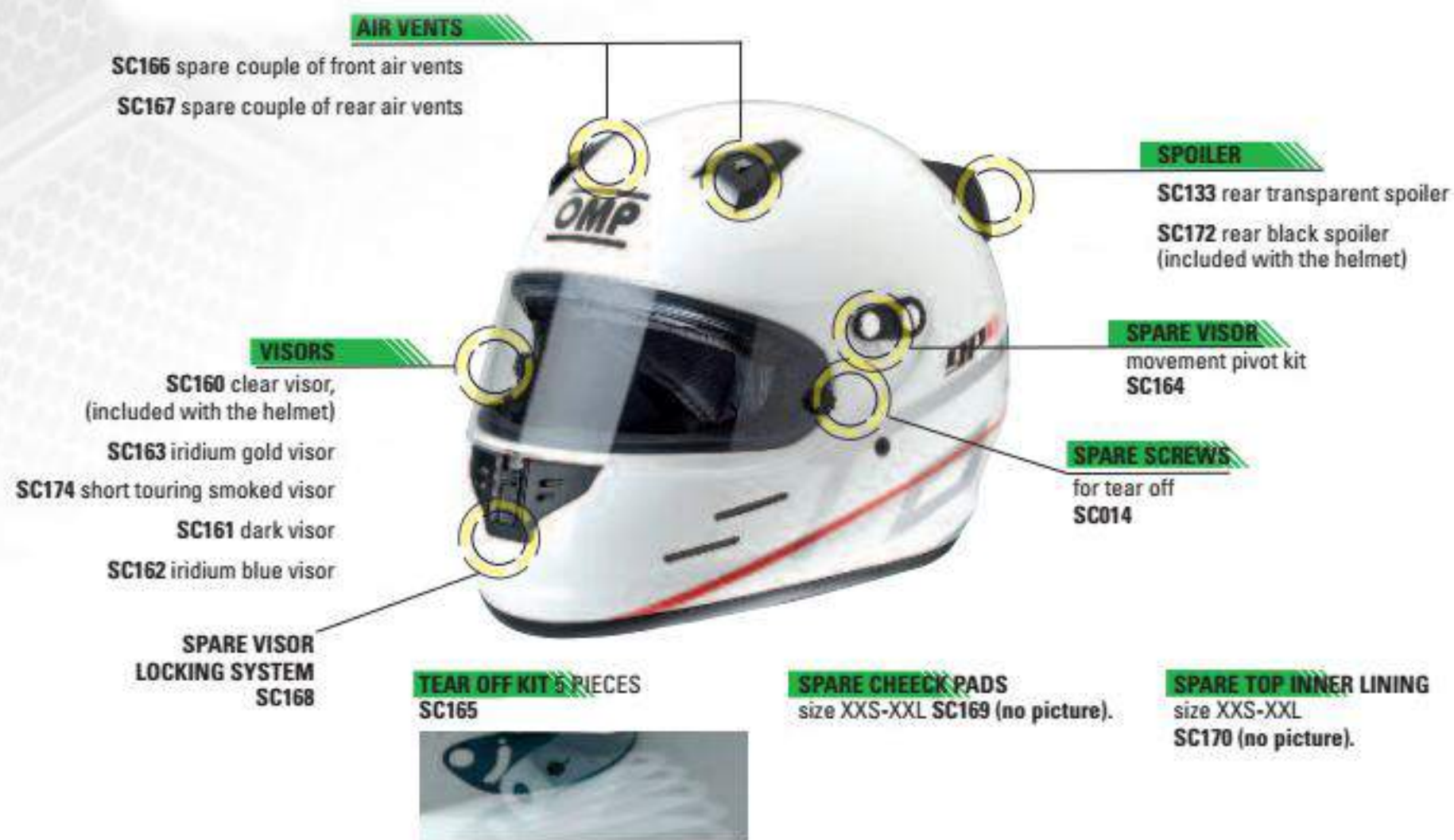

# HELMET SPARE PARTS

## CIRCUIT (SC611E)



## KJ 8 (SC790)



## STAR (SC607E)



# ACCESSORIES

# PROTECTIONS

## COLLAR

KK04003

Anatomic homologated collar in expanded polyurethane multi density foam with increased rigidity at the rear "fin" of the collar. One size.

F DE K 1997  
HOMOLOGATED

-  KK04003000073 Red/black
-  KK04003000075 Blue/black
-  KK04003000071 Black



## COLLAR

KK04009

New waterproof kart neck support collar, modern K STYLE design. One size.



## ELBOW AND KNEE PADS

KK04XXX

KK04006071  
Padded elbow pads.

KK04005071  
Padded knee pads.

ONE SIZE



## KS BODY PROTECTION

KK048

In polycarbonate material. Provides support and protection to ribs and back. Adjustable straps to improve comfort fittings. Properly shaped and stuffed to have ultra-comfort

LIGHTWEIGHT AND  
RESISTANT

SOFT AREA

KK048071XX Black



KK048178XX Yellow

SIZES:

XS/S (lower chest 70-89 cm / height 160-170 cm)  
M/L (lower chest 89-110 cm / height 170-190 cm)

## RIB PROTECTION VEST

KK04001

**Material:** shock absorbing.  
**Inserts:** high vibration absorption.  
**Straps:** double adjustable.  
**Cover:** stretch fabric.

KK04001XXX041 Blue

-  KK04001XXX061 Red
-  KK04001XXX071 Black

SIZES: XS - XL



ALSO FOR CHILDREN!

## SHOE COVER

KK08071XX

Nylon rainproof shoe-cover. **Seams:** heat welded. **Sole:** ultra soft reinforced rubber.

Sizes:  
XS (32/34)  
S (35/37)  
M (38/40)  
L (41/43)  
XL (44/47)



SIZES: XS - XL

## CARBON RIB PROTECTION VEST

KK047E



ALSO FOR CHILDREN!

Carbon fiber rib protection vest. **Straps:** adjustable.

SIZES: XS - L

## FLAT KART SEAT

KK05032

REF.	WIDTH
KK0503227	27 cm
KK0503229	29 cm
KK0503230	30 cm
KK0503231	31 cm
KK0503232	32 cm
KK0503233	33 cm
KK0503236	36 cm
KK0503238	38 cm



8 SIZES

## SEMITRANSSPARENT SEAT

KK05030XX

KK05030LXX



Semitransparent fiber glass.

8 SIZES

REF.	WIDTH
KK0503027	27 cm
KK0503029	29 cm
KK0503030	30 cm
KK0503031	31 cm
KK0503032	32 cm
KK0503033	33 cm
KK0503036	36 cm
KK0503038	38 cm

## FIBERGLASS SHELL

KK05031

REF.	WIDTH
KK0503127	27 cm
KK0503129	29 cm
KK0503130	30 cm
KK0503131	31 cm
KK0503132	32 cm
KK0503133	33 cm
KK0503136	36 cm
KK0503138	38 cm

Fiberglass shell.  
Upholstery: grey carpet.



8 SIZES

## SEAT PADDING

KK036

Polyethylene seat padding kit (5 piece kit) pre-cut pads for kart seats. All components are self adhesive to facilitate positioning on any seat shell. Thickness: 8 mm



## TYRE BAG

KK03300



Polyamide nylon tyre bag (suitable for 4 tyres), tear resistant waterproof fabric.

## DIGITAL TYRE PRESSURE

NC/072

Digital tyre pressure gauge. Resolution: 0.05 bar. Range: 0-7 bar.



0,6 CLASS

## KS COVER

KK03201

Waterproof kart cover, modern K-STYLE design.



## ANALOG TYRE PRESSURE

NC081

Analog tyre pressure gauge. Resolution: 0.1 bar. Range: 0-40 psi, 0-2.7 bar.



0,1 CLASS

## KART TROLLEY

KK05012



Steel frame kart trolley, easily disassembles for storage.

## NUMBER PLATE

X/892

Adhesive front number plate. Dimensions: 200x200 mm



## HOMOLOGATION LAYERS SIZES ALSO FOR CHILDREN **KART SUITS TABLE**

KS-ART SUIT			
CIK - FIA Level 2	2	44 62	✓







The XX in each part number indicates the location of the size.

KS-1R SUIT			
CIK - FIA Level 2	2	44 62	✓



KS-2R SUIT			
CIK - FIA Level 2	2	44 62	✓



KS-3 SUIT			
CIK - FIA Level 2	3	42 62	✓











KS-4 SUIT			
CIK - FIA Level 1	4	S XXL	✓





SUMMER K SUIT			
	1	S XXL	✓





## PALM INSERT EXTERNAL SEAMS VELCRO STRAP ALSO FOR CHILDREN SIZES **KART GLOVES TABLE**

KS ART				
silicone palm	✓			XS XL



The XX in each part number indicates the location of the size.

KS-1R GLOVES				
silicone palm	✓			XXS XL



KS-2R					
rubber application	✓		✓	XXS XL	







KS-3					
synthetic leather			✓	XXS XL	







KS-4					
suede leather		✓	✓	XXS XL	







ARP				
rubber applications	✓			XXS XXL



RAIN K				
neoprene			✓	XXS XL



## OUTSOLE REAR INSERTS VELCRO STRAP ALSO FOR CHILDREN SIZES **KART SHOES TABLE**

KS ART				
ultralight	✓			34 47



KS-1R SHOES			
ultralight	✓		34 47



KS-1 SHOES					
ultralight	✓	✓		37/48 34/48 yellow	







KS-2 SHOES				
light	✓	✓	✓	32 47





KS-3 SHOES				
light	✓		✓	32 47







The XX in each part number indicates the location of the size.

ARP				
ultralight	✓	✓		34 48



# RACING COLLECTIONS

## ONE COLLECTION

### ONE-ART SUIT



IA01857XX

### ONE-ART GLOVE



IA01857XX

### ONE-ART SHOES



IA01857XX

### ONE EVO SUIT



IA01851089XX IA01851076XX IA01851178XX IA01851244XX IA01851270XX

### ONE EVO GLOVES



IB/759/BW/XX IB/759/GF/XX IB/759/N/XX IB/759/W/XX

### ONE EVO R FORMULA SHOES



IC/805246XX IC/805099XX IC/805230XX IC/805071XX IC/805020XX IC/805370XX

### ONE EVO SHOES



IC/806061XX IC/806020XX IC/806071XX IC/806099XX

### ONE-S1 SUIT



IA01852076XX IA01852083XX IA01852184XX IA01852073XX IA01852244XX

### ONE-S SUIT



IA01853071XX IA01853083XX IA01853244XX

### ONE-S GLOVES



IB/755E/NW/XX IB/755E/GF/XX IB/755E/B/XX IB/755E/R/XX IB/755E/W/XX IB/755E/NW/XX

### ONE-SL SUIT



IA01855

### ONE-S SHOES



IC/807020XX IC/807061XX IC/807071XX IC/807244XX IC/807099XX

## TECNICA COLLECTION

### TECNICA EVO SUIT



IA01859076XX IA01859373XX IA01859178XX IA01859073XX IA01859244XX

### TECNICA EVO GLOVES



IB/756E/N/XX IB/756E/NGI/XX IB/756E/BC/XX IB/756E/R/XX IB/756E/W/XX

### TECNICA EVO SHOES



IC/803E071XX IC/803E073XX IC/803E044XX

### TECNICA-S SUIT



IA01850076XX IA01850089XX IA01850063XX IA01850043XX

### TECNICA-S GLOVES



IB/764/N/XX IB/764/BGI/XX IB/764/R/XX IB/764/GF/XX

## FIRST COLLECTION

### FIRST EVO SUIT



IA01854076XX IA01854089XX IA01854184XX IA01854063XX IA01854046XX

### FIRST EVO GLOVES



IB/757E/BC/XX IB/757E/NGI/XX IB/757E/R/XX IB/757E/N/XX

### FIRST EVO SHOES



IC/809182XX IC/809086XX IC/809244XX

### FIRST-S SUIT



IA01828B071XX IA01828B083XX IA01828B184XX IA01828B061XX IA01828B244XX

### FIRST-S GLOVES



IB/761E/N/XX IB/761E/B/XX IB/761E/R/XX

### FIRST-S SHOES



IC/802071XX IC/802041XX IC/802061XX

## KS-ART COLLECTION

### KS-ART SUITS



KK01726073XX KK01726073XX KK01720242XX

### KS-ART GLOVES



KK02746XX

### KS-ART SHOES



IC/818

## KS-1 COLLECTION

### KS-1R SUITS



KK01720370XX KK01720244XX

### KS-1R GLOVES



KK02740071XX

### KS-1 SHOES



IC/815058XX IC/815070XX IC/815120XX IC/815270XX IC/815244XX

## KS-2 COLLECTION

### KS-2 SUITS



KK01725172XX KK01725247XX

### KS-2 GLOVES



KK02747071XX KK02747120XX KK02747242XX KK02747060XX KK02747058XX

### KS-2 SHOES



IC/812120XX IC/812273XX IC/812242XX IC/812059XX

## KS-3 COLLECTION

### KS-3 SUIT



KK017231274XX KK01723179XX KK01723178XX KK017231275XX KK01723089XX KK01723043XX KK01723063XX KK01723076XX

### KS-3 GLOVES



KK02743E076XX KK02743E175XX KK02743E270XX KK02743E060XX KK02743E096XX KK02743E099XX

### KS-3 SHOES



IC/813077XX IC/813184XX IC/813241XX

### SUIT BODY MEASUREMENTS TABLE

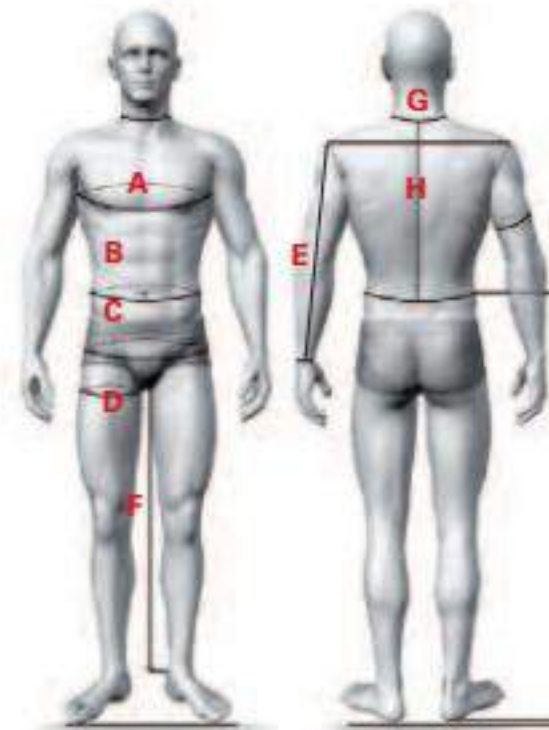

	S		M		L		XL		XXL			
	42	44	46	48	50	52	54	56	58	60	62	64
WEIGHT (kg)	50/60	55/65	60/70	65/75	70/80	75/85	83/88	85/92	87/95	90/100	95/110	105/115
HEIGHT (cm)	150/160	155/165	160/170	165/175	170/180	173/183	177/187	182/190	185/195	187/198	190/200	190/200
A - CHEST (cm)	83/86	87/90	91/94	95/98	99/102	103/106	107/110	111/114	115/118	119/122	123/126	127/130
B - WAISTLINE (cm)	71/74	75/78	79/82	83/86	87/90	91/94	95/98	99/102	103/106	107/110	111/114	115/119
C - HIPS (cm)	83/86	87/90	91/94	95/98	99/102	103/106	107/110	111/114	115/118	119/122	123/126	127/130
D - THIGH (cm)	47/50	49/52	51/54	53/56	55/58	57/60	59/62	61/63	63/66	65/68	67/70	68/72
E - ARM (cm)	54/58	56/60	58/62	60/64	62/66	64/68	66/70	68/72	70/74	71/75	72/76	72/76
F - INSIDE LEG (cm)	68/72	70/74	72/76	74/78	76/80	78/82	80/84	82/86	84/88	85/89	85/89	87/91
G - SHOULDERS (cm)	35/38	37/40	39/42	41/45	43/47	45/50	46/51	46/52	47/53	48/54	49/55	50/56
H - BACK (cm)	45/49	44/48	45/49	46/50	47/51	48/52	48/53	49/54	49/55	50/56	51/56	52/58

### SHOES COMPARISON SIZE TABLE

EUROPEAN SIZES	34	35	36	37	38	39	40	41	42	43	44	45	46	47	48
USA SIZES	2	2 1/2	3 1/2	4	5	6	6 1/2	7 1/2	8	9	10	10 1/2	11 1/2	12	13
LENGTH CM	23	23 1/2	24	24 1/2	25 1/2	26	27	27 1/2	28	28 1/2	29	30	30 1/2	31 1/2	32

### FIA HELMETS COMPARISON SIZE TABLE

Valid for: GP8 - GP8K - J8 series

Circumference cm	53	54	55	56	57	58	59	60	61	62	63	64
Helmets	XS	S	M	L	XL	XXL						

### CMR HELMETS COMPARISON SIZE TABLE

Valid for: KJ-8 series

Circumference cm	52	53	54	55	56	57	58	59
Helmets	XXS	XS	S	M	L			

### ECE HELMETS COMPARISON SIZE TABLE

Valid for: CIRCUIT - STAR series

Circumference cm	53	55	56	57	58	59	60	61
Helmets	XS	S	M	L	XL	XXL		

### GLOVES COMPARISON SIZE TABLE

EUROPEAN SIZES	XXS	XS	S	M	L	XL
USA SIZES	7	8	9	10	11	12
CM	12 1/2	16 1/2	18 1/2	20/24	23/26 1/2	25 1/2/30

### WARNING

Motorsport is an intrinsically dangerous activity, that can result in serious or lethal injuries. The items described in this catalogue provide for protection on specific parts of the body for a limited period of time in controlled test conditions, in accordance with the FIA standard specified on each item's label. No device can provide a complete protection from every injury in case of accident or fire. The user, at the time when he uses the products, relieves the manufacturer, the distributor, the owner, the employees, the agents, the sales representatives from any responsibility. It is the user's responsibility to become familiar with all available informations about the correct use and maintenance of the products. If uncertain of the correct use and maintenance, the user must not use the products. The manufacturer, the distributor and their respective owners, employees, agents and representatives are not responsible for mistakes or omissions.

### DISCLAIMER

- Each personal safety device is part of a complete safety system including the other racewear products, protections, the vehicle, the racetrack, the event organization.
- Personal safety products are not conceived to provide the same performance level or protection through the whole specific product. Different parts or areas of the product can provide different levels of protection, in spite of the fact that they may appear the same.
- Personal safety products must always be inspected before use and replaced after any evidence of wear, and after exposure to chemicals, excessive heat or any unusual condition.
- Products are sold to be used in legally sanctioned autosport events only, and are not intended to be used and/or installed for regular street use, as street use safety products are subject to different homologations and laws depending on the State or country.
- It is the user's responsibility to become familiar with all available informations about the correct use and maintenance of the products. If uncertain of the correct use and maintenance, the user must not use the products. The manufacturer, the distributor and their respective owners, employees, agents and representatives are not responsible for mistakes or omissions.
- Every single modification or customization of the products, and every operation on them may reduce their security features. Thus, the user is responsible at his own risk for the reduction of security features caused by modification or customization.

### BY THE USE OF THESE PRODUCTS, THE USER ACKNOWLEDGES:

That each personal safety device is part of a complete safety system including the other racewear products, protections, the vehicle, the racetrack, the event organization; that personal safety products are not conceived to provide the same performance level or protection through the whole specific product. Different parts or areas of the product can provide different levels of protection, in spite of the fact that they may appear the same; that personal safety products must always be inspected before use and replaced after any evidence of wear, and after exposure to chemicals, excessive heat or any unusual condition. That the helmet is conceived and designed to reduce the risk of cranial and facial injuries only in case of impact. That no helmet can protect against any possible and foreseeable impact.



The quality OMP system is certified since the year 1999

OMP achieved the ISO 9001:2015 quality system certification, awarded by TÜV, the world's biggest inspection service.

The certification is valid for design, manufacture and trade of accessories for racing and car application, sportswear and racewear.

ISO 9001:2015 is the strictest international standard for company quality so far, and it demonstrates the ability to use processes that meet customer, partner and regulatory requirements, to reach a high level of product quality and customer's satisfaction.

- A** \_\_\_\_\_
- 206 Accessories (car)
- 98 Accessories (universal)
- 126 Air cooling kit

- B** \_\_\_\_\_
- 233 Bags
- 209 Bonnet pins

- C** \_\_\_\_\_
- 218 Chemical products
- 214 Chronometers
- 215 Co-driver accessories
- 212 Co-driver map lights
- 246 Customized Project

- E** \_\_\_\_\_
- 212 Electrical accessories
- 174 Extinguishers
- 184 Extinguisher accessories

- G** \_\_\_\_\_
- 211 Gear knob
- 286 Gloves - kart
- 65 Gloves - mechanics'
- 54 Gloves - racing
- 63 Gloves - vintage

- H** \_\_\_\_\_
- 302 Helmets - kart
- 84 Helmets - racing

- I** \_\_\_\_\_
- 87 Intercoms

- K** \_\_\_\_\_
- 311 Karting accessories

- M** \_\_\_\_\_
- 311 Manometers - kart
- 212 Master switches

- N** \_\_\_\_\_
- 207 Nets - racing

- O** \_\_\_\_\_
- 220 OMP Style

- P** \_\_\_\_\_
- 210 Pedalsets and footrest - racing
- 217 Pedalsets and footrest - tuning
- 212 Pit boards
- 245 Promotional items

- R** \_\_\_\_\_
- 208 Racing accessories
- 168 Roll bars
- 172 Roll bars - accessories

- S** \_\_\_\_\_
- 164 Safety belts - off road
- 142 Safety belts - racing
- 165 Safety belts - tuning
- 127 Seats - accessories
- 240 Seats - children
- 310 Seats - kart
- 133 Seats - off road
- 133 Seats - off road brackets
- 104 Seats - racing
- 128 Seats - racing brackets
- 134 Seats - tuning
- 139 Seats - tuning brackets
- 132 Seats - vintage
- 294 Shoes - kart
- 68 Shoes - mechanics'
- 68 Shoes - racing
- 79 Shoes - vintage

- 222 Sportswear
- 212 Stay bars
- 205 Steering wheel - accessories
- 205 Steering wheel - hubs
- 202 Steering wheels - off road
- 188 Steering wheels - racing
- 205 Steering wheel - spacers
- 203 Steering wheels - tuning
- 202 Steering wheels - vintage
- 219 Strut braces
- 42 Suits - customization "SU MISURA"
- 272 Suits - kart
- 36 Suits - mechanics'
- 10 Suits - racing
- 32 Suits - vintage
- 173 Sumpguards

- T** \_\_\_\_\_
- 209 Tow hook - racing
- 218 Tow hook - tuning
- 213 Tyre warmers

- U** \_\_\_\_\_
- 282 Underwear - kart
- 50 Underwear Cool Shirt and accessories
- 46 Underwear - racing

- W** \_\_\_\_\_
- 238 Wheeled chair





**RACING SPIRIT** IS A NEW AUTO-INSPIRED LIFESTYLE BRAND THAT CELEBRATES THE FASCINATING WORLD OF CAR RACING ALONG WITH DRIVERS AND ENTHUSIASTS ALIKE.

*Win or lose tomorrow is another day and we will start over again. It's not how many times we fall, it's about how many times we stand up: this is what we do everyday, it's in our blood.*

*The only goal is winning, second place is first place loser. At all times we're ready to solve problems, we're for teamwork, we love competition and we're born to race.*

*We push ourselves for milliseconds, to save fuel or weight... we engineer, design, manufacture, tweek, test, tweek some more, test again, race and push ourselves to the limit. Great is not enough because tomorrow someone will be better than us, and we need to work harder to stay ahead of the curve.*

*The Racing Spirit is a never-ending quest to be the best on and off the track!*



AN **OMP** PROJECT

Discover various steering wheels in our online store.