

# Steinjäger

## When Bad is Good

Universal Suspension Parts,  
Kits and Assemblies



# Steinjäger

## TABLE OF CONTENTS BY PAGE ORDER



Pgs 4-5 Male Spherical Rod Ends



Pgs 6-7 Female Spherical Rod Ends



Pgs 8-11 Male Rod End Kits



Pgs 12-13 Uniballs & COM Bearings



Pgs 14-15 Male Poly Bushing Rod Ends



Pgs 16-21 Male Poly Bushing Kits

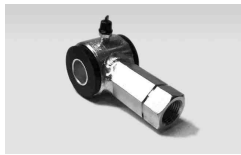

Pgs 22-23 Female Poly Bushings



Pgs 24-29 Poly Double Adjustable Links



Pgs 30-33 Cut Tubes & Bush Kits

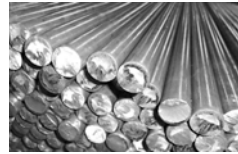

Pgs 34-35 Cut Bars, Flats and Squares



Pgs 36-39 Cut, Welded, Painted Tubes



Pgs 40-46 Tab Kits for Suspensions



Pg 47 Fasteners



Pgs 48-51 End Links for Sway Bars



Pgs 52-59 End Links with Drop Clevises



Pgs 60-63 Hex Bar Tubes





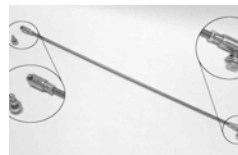































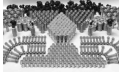





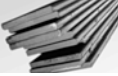

Pgs 64-65 Cables, Bunges, Ball Joints



Pg 66-67 Shifters, Carb Links, Swag

# TABLE OF CONTENTS - INDEX

	Ball Joints, Disconnect	65		Inserts, High Misalignment	64		Rod Ends, Male Stainless	5
	Bar, Cut-to-Length	34		Ladder Bar Adjusters	65		Rod Ends, Solid	65
	Bungs, Thread	64		Poly Bushing Kits	16		Shift Linkage	66
	Bushing Kits	30		Poly Bushings, Double Adj	24		Snap Rings for Uniballs	13
	Cables, Parachute	65		Poly Bushings, Female	22		Spacers for Rod Ends	65
	Cables, Shifter	65		Poly Bushings, Male	14		Strut Rods, Track Spoiler	66
	Carburetor Linkage Kits	66		Rod End Kits, Simple	8		Studs - Install Your Own	12
	Clevis Kits for End Links	55		Rod End Kits, Insets/Boots	10		Suspension Clevises & Tabs	40
	Clevises, Brake Cylinder	65		Rod End Kits, Spacers/Seals	9		Swag	67
	End Links with Drop Clevises	53		Rod End Kits, Monster	11		Tubes, Cut/Welded/Painted	36
	End Links for Sway Bars	48		Rod Ends, Female 4130 Moly	6		Tubes, Hex Bar, Threaded	60
	Fasteners, Bulk	47		Rod Ends, Female PTFE	7		Tubes, Round, Cut/Notched	30
	Flat Bar, Cut to Length	35		Rod Ends, Female Stainless	7		Tubes, Round, Cut-to-Length	32
	Hex Bar Tubes	60		Rod Ends, Female Studded	6		Tubes, Square, Cut-to-Length	35
	Hood Prop Rod	66		Rod Ends, Male 4130 Moly	4		Uniball Cups	13
				Rod Ends, Male PTFE	5		Uniballs	12





## Chrome Moly Spherical Rod Ends



Steinjäger's chrome molys include *Steinjäger* brand rod ends sold as one piece per pack, and Midwest Controls MXM (inch) and DXTM (metric) series sold in larger quantities.

Housing: 4130 Heat Treated Chrome Moly  
 Finish: Bright Chrome Plated  
 Race: Slotted Nylon, Prelubricated  
 Ball: 52100 Steel, Ground, Heat Treated, Chrome Plated

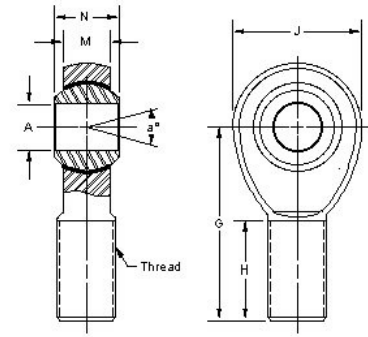

Thread	A (Bore)	RH Part#	Qty	LH Part#	Qty	RH Part#	Qty	LH Part#	Qty	a°	G	H	J	M	N
1/4-28	1/4	J0014666	1	J0014649	1	J0014677	10	J0014656	10	50°	1.562	1.000	0.750	0.281	0.375
5/16-24	5/16	J0014869	1	J0014850	1	J0014883	25	J0014863	25	48°	1.875	1.250	0.875	0.344	0.437
3/8-24	3/8	J0014813	1	J0014793	1	J0014828	10	J0014800	10	44°	1.938	1.250	1.000	0.406	0.500
7/16-20	7/16	J0014945	1	J0014938	1	J0014950	10	J0014952	10	40°	2.125	1.375	1.125	0.437	0.562
1/2-20	1/2	J0014614	1	J0014589	1	J0014621	10	J0014595	10	44°	2.438	1.500	1.312	0.453	0.625
5/8-18	1/2	J0014910	1	J0014891	1	J0014992	25	J0014898	25	50°	2.625	1.625	1.500	0.484	0.750
5/8-18	5/8	J0014911	1	J0014892	1	J0014923	25	J0014899	25	44°	2.625	1.625	1.500	0.484	0.750
3/4-16	1/2	J0014743	1	-	-	J0014773	2	-	-	50°	2.875	1.750	1.755	0.593	0.875
3/4-16	5/8	J0014742	1	-	-	J0014772	2	-	-	36°	2.875	1.750	1.750	0.562	0.750
3/4-16	5/8	J0014717	1	J0014717	1	J0014771	2	J0014729	2	50°	2.875	1.750	1.755	0.593	0.875
3/4-16	3/4	J0014744	1	J0014718	1	J0014774	2	J0014730	2	44°	2.875	1.750	1.755	0.593	0.875
3/4-16	0.757"	J0014740	1	-	-	J0014770	2	-	-	44°	2.875	1.750	1.755	0.593	0.875
7/8-14	3/4	J0014962	1	J0014956	1	J0014964	12	J0014958	12	40°	3.375	1.875	2.000	0.687	0.875
7/8-14	7/8	J0014963	1	J0014957	1	J0014965	12	J0014959	12	20°	3.375	2.000	2.000	0.765	0.875
1"-12	3/4	J0014573	1	J0014567	1	J0014577	4	J0014571	4	50°	4.125	2.125	2.750	1.000	1.375
1"-12	1	J0014574	1	J0014568	1	J0014578	4	J0014572	4	40°	4.125	2.125	2.750	1.000	1.375
1"-14	1	J0014585	1	J0014580	1	J0014588	4	J0014583	4	34°	4.125	2.125	2.750	1.000	1.375
1.25"-12	1	J0014557	1	J0014551	1	J0014561	4	J0014555	4	46°	4.125	2.125	2.750	1.000	1.375
1.25"-12	1.250"	J0014558	1	J0014552	1	J0014562	4	J0014556	4	30°	4.125	2.125	2.750	1.000	1.375
1.50"-12	1.250"	J0014563	1	J0014564	1	-	-	-	-	26°	4.125	2.250	2.750	0.937	1.093
1.75"-12	1.500"	J0014565	1	J0014566	1	-	-	-	-	26°	5.375	3.000	3.500	1.125	1.312
M6 x 1.00	6mm	-	-	-	-	J0015016	10	-	-	50°	36mm	21mm	20mm	6.75mm	9mm
M8 x 1.25	8mm	-	-	-	-	J0015137	5	J0015123	2	48°	42mm	25mm	24mm	9.00mm	12mm
M10 x 1.25	10mm	-	-	-	-	J0014973	2	-	-	48°	48mm	29mm	28mm	10.50mm	14mm
M10 x 1.50	10mm	J0014989	1	J0014974	1	J0015001	2	J0014984	2	48°	48mm	29mm	28mm	10.50mm	14mm
M10 x 1.50	10mm	J0014975	1	J0015025	1	-	-	-	-	48°	73mm	54mm	28mm	10.50mm	14mm
M12 x 1.75	12mm	J0015025	1	J0015014	1	J0015034	5	J0015020	5	48°	54mm	33mm	32mm	12.00mm	16mm
M12 x 1.75	12mm	J0015026	1	J0015015	1	-	-	-	-	48°	79mm	58mm	32mm	12.00mm	16mm
M14 x 1.50	14mm	-	-	-	-	J0015044	2	J0015040	2	48°	60mm	36mm	36mm	13.50mm	19mm
M16 x 2.00	16mm	-	-	-	-	J0015068	2	J0015062	2	50°	66mm	40mm	42mm	15.00mm	21mm
M18 x 1.50	18mm	-	-	-	-	J0015076	2	-	-	50°	72mm	41mm	46mm	16.50mm	23mm
M20 x 1.50	20mm	-	-	-	-	J0015081	2	-	-	46°	78mm	45mm	50mm	18.00mm	25mm
M24 x 2.00	24mm	-	-	-	-	J0015082	4	-	-	46°	94mm	55mm	60mm	22.00mm	31mm
M30 x 2.00	30mm	-	-	-	-	J0015083	4	-	-	46°	110mm	66mm	70mm	25.00mm	37mm



## Spherical Rod Ends



Steinjäger offers a number of bulk-packed spherical rod ends from Midwest Control Products Corp.

Other quantities, sizes and styles are available - refer to our website.

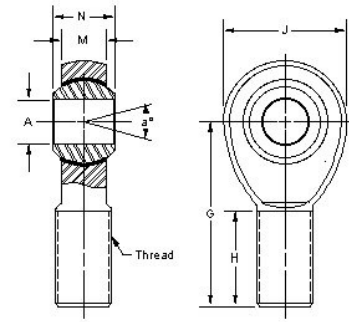

Thread	Housing ->	Plated Steel				Plated Steel				Stainless *		a°	G	H	J	M	N
	Bearing ->	Steel (the housing itself)				PTFE				PTFE							
	A (Bore)	RH Part#	Qty	LH Part#	Qty	RH Part#	Qty	LH Part#	Qty	RH Part#	Qty						
10-32	3/16	J0014709	10	J0014699	10	J0014712	25	J0014703	25	-	-	50°	1.250	0.750	0.625	0.250	0.312
1/4-28	1/4	J0014674	10	J0014653	10	J0014676	10	J0014655	10	J0014692	4	50°	1.562	1.000	0.750	0.281	0.375
5/16-24	5/16	J0014887	5	J0014867	5	J0014888	5	J0014868	5	J0014849	25	48°	1.875	1.250	0.875	0.344	0.437
3/8-24	3/8	J0014836	4	J0014804	4	J0014825	10	J0014799	10	J0014835	4	44°	1.938	1.250	1.000	0.406	0.500
7/16-20	7/16	J0014947	10	J0014940	10	J0014951	2	J0014943	2	-	-	40°	2.125	1.375	1.125	0.437	0.562
1/2-20	1/2	J0014618	10	J0014593	10	J0014620	10	J0014594	10	J0014623	2	44°	2.438	1.500	1.312	0.453	0.625
5/8-18	5/8	J0014913	10	J0014893	10	J0014931	5	J0014903	5	J0014916	2	44°	2.625	1.625	1.500	0.484	0.750
3/4-16	3/4	J0014765	2	J0014725	2	J0014791	4	J0014738	4	J0014756	2	44°	2.875	1.750	1.755	0.593	0.875
3/4-16	0.757"	J0014764	2	-	-	J0014768	2	-	-	-	-	44°	2.875	1.750	1.755	0.593	0.875
1"-14	1.0"	-	-	-	-	J0014584	1	J0014579	1	-	-	34°	4.125	2.125	2.750	1.000	1.375
<b>METRIC SIZES - Dimensions in mm</b>																	
M5 x 0.80	5mm	-	-	-	-	J0015089	10	J0015085	10	-	-	50°	33	20	18	6.0	8
M6 x 1.00	6mm	-	-	-	-	J0015105	10	J0015095	10	J0015102	10	50°	36	22	20	6.75	9
M8 x 1.25	8mm	-	-	-	-	J0015127	10	J0015115	10	J0015125	10	44°	42	25	24	9.0	12
M10 x 1.50	10mm	-	-	-	-	J0014996	10	J0014980	10	J0015000	2	48°	73	54	28	10.5	14
M12 x 1.75	12mm	-	-	-	-	J0015033	5	J0015019	5	J0015032	5	50°	79	58	32	12.0	16
M14 x 1.50	14mm	-	-	-	-	J0015050	2	J0015047	2	-	-	46°	60	36	36	13.5	19
M16 x 2.00	16mm	-	-	-	-	J0015074	5	-	-	-	-	44°	66	40	42	15.0	21
M20 x 1.50	20mm	-	-	-	-	-	-	-	-	J0015080	2	44°	78	45	50	18.0	25

\* Note: Inch Stainless Rod Ends are 17-4 Stainless Steel. Metric sizes are 304 series Stainless Steel.

Rod End Strengths		Ultimate Radial Static Loads (in pounds)													
Housing	Race	10-32	1/4	5/16	3/8	7/16	1/2	5/8	5/8 x 1/2	3/4	3/4 x 1/2	3/4 x 5/8	7/8 x 3/4	1" x 1"	1.25" x 1."
Plated Steel	Steel	2,080	3,015	4,375	5,521	6,407	8,293	10,454	-	13,483	-	-	-	-	-
Plated Steel	PTFE	1,865	1,953	3,875	5,310	7,568	8,470	10,350	-	13,588	-	-	-	-	-
17-4 Stainless	PTFE	2,679	3,956	5,621	7,335	-	10,347	-	-	21,853	-	-	-	-	-
4130 Chrome Moly	Nylon	-	3,900	7,455	9,771	11,795	16,223	19,751	14,356	27,019	22,468	25,489	34,060	37,354	50,843

### Special Spherical Rod Ends



### Tapered Stud

3/4-16 x 5/8-18



### Bump Steer

3/4-16 RH x 3/4-16 RH  
1.798" Wide Ball



### Grease Zerked Steel



Plated Housing, No Race

J0014619: 1/2-20 RH, 5/pack  
J0014929: 5/8-18 RH, 5/pack  
J0014901: 5/8-18 LH, 5/pack  
J0014790: 3/4-16 RH, 4/pack  
J0014737: 3/4-16 LH, 4/pack

## Spherical Rod Ends - Inch



Steinjäger offers a number of bulk-packed spherical rod ends from Midwest Control Products Corp.

Other quantities, sizes and styles are available - refer to our website.

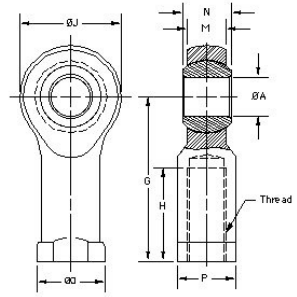

Thread	Housing:	Plated Steel				Plated Steel				Chrome Moly		a°	G	H	J	M	N	O	P
	Bearing:	Steel (the housing itself)				PTFE				Nylon									
	A (Bore)	RH Part#	Qty	LH Part#	Qty	RH Part#	Qty	LH Part#	Qty	RH Part#	Qty								
6-32	1/8	J0014937	50	-	-	-	-	-	-	-	-	50°	0.812	0.375	0.469	0.187	0.250	0.328	0.250
10-32	3/16	J0014706	10	J0014697	10	J0014715	10	J0014701	10	-	-	50°	1.062	0.562	0.625	0.250	0.312	0.406	0.312
10-32	1/4	J0014708	10	-	-	-	-	-	-	-	-	50°	1.312	0.750	0.750	0.281	0.375	0.469	0.375
1/4-28	3/16	J0014667	10	-	-	-	-	-	-	-	-	50°	1.312	0.750	0.750	0.281	0.375	0.469	0.375
1/4-28	1/4	J0014669	10	J0014651	10	J0014693	5	J0014663	5	J0014689	25	50°	1.312	0.750	0.750	0.281	0.375	0.469	0.375
1/4-28	5/16	J0014671	10	-	-	-	-	-	-	-	-	50°	1.375	0.750	0.875	0.344	0.437	0.500	0.437
1/4-28	3/8	J0014672	10	-	-	-	-	-	-	-	-	46°	1.625	0.937	1.000	0.406	0.500	0.687	0.562
5/16-24	5/16	J0014878	25	J0014858	25	J0014881	25	J0014861	25	J0014885	30	50°	1.375	0.750	0.875	0.344	0.437	0.500	0.437
5/16-24	3/8	J0014872	10	-	-	-	-	-	-	-	-	46°	1.625	0.937	1.000	0.406	0.500	0.687	0.562
3/8-24	5/16	J0014814	10	-	-	-	-	-	-	-	-	46°	1.625	0.937	1.000	0.406	0.500	0.687	0.562
3/8-24	3/8	J0014817	10	J0014794	10	J0014824	10	J0014798	10	J0014826	10	46°	1.625	0.937	1.000	0.406	0.500	0.687	0.562
3/8-24	1/2	-	-	-	-	-	-	-	-	J0014831	2	34°	1.250	0.500	1.312	0.453	0.625	0.875	0.750
7/16-20	7/16	J0014946	10	J0014939	10	J0014949	10	J0014941	10	-	-	46°	1.812	1.062	1.125	0.437	0.562	0.750	0.625
1/2-20	1/2	J0014636	5	J0014605	5	J0014639	5	J0014608	5	J0014640	5	46°	2.125	1.187	1.312	0.500	0.625	0.875	0.750
5/8-18	5/8	J0014896	2	J0014896	2	J0014930	5	J0014902	5	J0014932	5	46°	2.500	1.500	1.500	0.562	0.750	1.000	0.875
5/8-18	3/4	J0014909	1	-	-	-	-	-	-	-	-	48°	2.875	1.562	1.750	0.687	0.875	1.125	1.000
3/4-16	3/4	J0014761	2	J0014724	2	J0014767	2	J0014727	2	J0014769	2	48°	2.875	1.562	1.750	0.687	0.875	1.125	1.000

### Studded Rod Ends



Steinjäger offers the plated steel, steel raced rod ends with factory fitted rod ends studs.

Part#	Housing Thds	Stud Threads	Qty
J0014707	10-32 RH	10-32 RH	10
J0014698	10-32 LH	10-32 LH	10
J0014670	1/4-28 RH	1/4-28 RH	10
J0014652	1/4-28 LH	1/4-28 RH	10
J0014871	5/16-24 RH	5/16-24 RH	10
J0014852	5/16-24 LH	5/16-24 LH	10
J0014819	3/8-24 RH	3/8-24 RH	10

Part#	Housing Thds	Stud Threads	Qty
J0014805	3/8-24 LH	3/8-24 RH	5
J0014953	7/16-20 RH	7/16-20 RH	5
J0014637	1/2-20 RH	1/2-20 RH	5
J0014606	1/2-20 LH	1/2-20 RH	5
J0014921	5/8-18 RH	5/8-18 RH	25
J0014918	5/8-18 LH	5/8-18 RH	2
J0014672	3/4-16 RH	3/4-16 RH	2

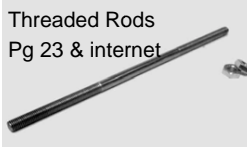

Threaded Rods  
Pg 23 & internet

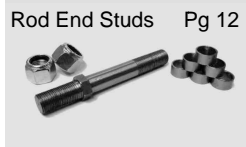

Rod End Studs Pg 12



Quick Disconnect  
Pg 65

Grease Zerkered Steel	Plated Housing, No Race
	J0014820: 3/8-24 RH, 10/pack J0014616: 1/2-20 RH, 10/pack J0014591: 1/2-20 LH, 10/pack J0014763: 3/4-16 RH, 2/pack

## Spherical Rod Ends - Metric



Steinjäger offers a number of bulk-packed spherical rod ends from Midwest Control Products Corp.

Other quantities, sizes and styles are available - refer to our website.

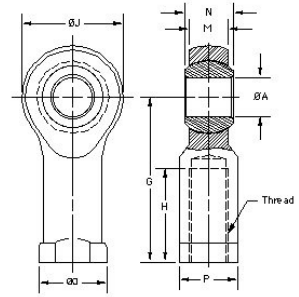

Thread	Housing:	Plated Steel				Plated Steel				304 Stainless		All Dimensions are in millimeters (metric)							
	Bearing:	Steel (the housing itself)				PTFE				PTFE		a°	G	H	J	M	N	O	P
	A (Bore)	RH Part#	Qty	LH Part#	Qty	RH Part#	Qty	LH Part#	Qty	RH Part#	Qty								
M5x0.80	5	-	-	-	-	J0015088	10	J0015084	10	J0015090	5	26°	27	9	18	6	8	11	9
M6x1.00	6	J0015101	10	J0015093	10	J0015104	10	J0015094	10	J0015109	5	26°	30	9	20.5	6.75	9	13	10
M8x1.25	8	J0015124	10	J0015114	10	J0015130	20	J0015117	20	J0015136	5	26°	36	12	24.5	9	12	16	12.5
M10x1.25	10	-	-	-	-	J0014970	10	J0014968	10	J0014972	2	26°	43	15	28.5	10.5	14	19	15
M10x1.50	10	J0014991	10	J0014976	10	J0014995	10	J0014979	10	J0014999	2	26°	43	15	28.5	10.5	14	19	15
M12x1.25	12	J0015010	2	J0015007	2	J0015009	10	-	-	J0015011	2	26°	50	18	32.5	12	16	22	17.5
M12x1.75	12	-	-	-	-	J0015028	10	J0015016	10	J0015030	2	26°	50	18	32.5	12	16	22	17.5
M14x1.50	14	-	-	-	-	J0015043	2	J0015039	2	-	-	24°	57	20	36.5	13.5	19	25	20
M16x1.25	16	-	-	-	-	J0015053	2	-	-	J0015055	2	30°	64	24	42.5	15	21	27	22
M16x1.50	16	-	-	-	-	J0015056	2	-	-	-	-	30°	64	24	42.5	15	21	27	22
M16x2.00	16	-	-	-	-	J0015067	2	J0015061	2	J0015066	2	30°	64	24	42.5	15	21	27	22

Rod End Strengths		Ultimate Radial Static Loads (in pounds)													
Housing	Race	10-32	1/4	5/16	3/8	7/16	1/2	5/8	3/4	M5	M6	M8	M10	M12	M16
Plated Steel	Steel	1,825	2,934	3,529	5,824	5,993	8,628	9,478	12,880	-	2,895	3,400	5,824	8,628	-
Plated Steel	PTFE	1,572	1,660	2,593	3,613	4,641	6,165	7,185	10,337	2,020	2,404	3,400	4,208	5,313	6,649
304 Stainless Steel	PTFE	-	-	-	-	-	-	-	-	956	1,466	2,041	2,618	3,018	5,492
4130 Chrome Moly	Nylon	-	5,231	7,610	11,178	-	13,632	19,401	26,520	-	-	-	-	-	-



Connect your linkage with a Jack Screw Turnbuckle Kit. Jack screws have a wrench flat and are threaded LH/RH. The kit includes jam nuts.

Threads	Length	Material	Plated	Part#
10-32	1.402"	Steel	Zinc Yellow	J0028418
1/4-28	1.776"	Steel	Zinc Yellow	J0028419
5/16-24	2.309"	Steel	Zinc Yellow	J0028420
3/8-24	2.125"	Steel	Zinc Yellow	J0028422
	2.589"	Steel	Zinc Yellow	J0028421
	2.860"	Steel	Zinc Clear	J0028423
7/16-20	2.870"	Steel	Zinc Yellow	J0028424
1/2-20	2.938"	Steel	Zinc Yellow	J0028426
	3.433"	Steel	Zinc Yellow	J0028425
5/8-18	3.745"	Steel	Zinc Yellow	J0028416





Threads	Length	Material	Plated	Part#
5/8-18	4.075"	4130 Moly	Chrome	J0028433
3/4-16	4.042"	Steel	Zinc Yellow	J0028417
	4.638"	4130 Moly	Chrome	J0028434
	8.638"	4130 Moly	Chrome	J0028435
M6 x 1.00	45 mm	Steel	Zinc Yellow	J0028430
M8 x 1.25	57 mm	Steel	Zinc Yellow	J0028431
	57 mm	Steel	Zinc Clear	J0028432
M10 x 1.50	69 mm	Steel	Zinc Yellow	J0028427
M12 x 1.75	83 mm	Steel	Zinc Yellow	J0028428
M16 x 2.00	109 mm	Steel	Zinc Yellow	J0028429



## ROD END KITS - SIMPLE

### Simple Rod End Kits

Steinjäger offers a number of different rod end kits. This series of kits is the simplest of these. The thread bungs are chrome moly. Rod End options include a chromed, chrome moly housing with a slotted nylon race, or a plated steel commercial rod end with a PTFE race.

				
Each kit includes...				
<ul style="list-style-type: none"> <li>• 1 Rod End</li> <li>• 1 Nut</li> <li>• 1 Bung</li> <li>• 2 Misaligning Inserts</li> </ul>	<ul style="list-style-type: none"> <li>• 1 RH Rod End</li> <li>• 1 LH Rod End</li> <li>• 2 Nuts, 2 Bungs</li> <li>• 4 Misaligning Inserts</li> </ul>	<ul style="list-style-type: none"> <li>• 2 RH Rod Ends</li> <li>• 2 LH Rod Ends</li> <li>• 4 Nuts, 4 Bungs</li> <li>• 8 Misaligning Inserts</li> </ul>	<ul style="list-style-type: none"> <li>• 3 RH Rod Ends</li> <li>• 3 LH Rod Ends</li> <li>• 6 Nuts, 6 Bungs</li> <li>• 12 Misaligning Inserts</li> </ul>	<ul style="list-style-type: none"> <li>• 4 RH Rod Ends</li> <li>• 4 LH Rod Ends</li> <li>• 8 Nuts, 8 Bungs</li> <li>• 16 Misaligning Inserts</li> </ul>

Thread	Rod End	Fits Tube	RH Part#	LH Part#	Kit Part#	Kit Part#	Kit Part#	Kit Part#
3/8-24	PTFE	0.625 x 0.058	J0017987	J0017991	J0019257	J0019275	J0029293	J0019311
	Moly		J0017965	J0017969	J0019246	J0019264	J0019282	J0019300
	PTFE	0.750 x 0.058	J0017986	J0017990	J0019256	J0019274	J0019292	J0019310
	Moly		J0017964	J0017968	J0019245	J0019263	J0019281	J0019299
	PTFE	0.875 x 0.065	J0017985	J0017989	J0019255	J0019273	J0019291	J0019309
	Moly		J0017963	J0017967	J0019244	J0019262	J0019280	J0019298
	PTFE	1.000 x 0.095	J0017984	J0017988	J0019254	J0019272	J0019290	J0019308
	Moly		J0017962	J0017966	J0019243	J0019261	J0019279	J0019297
1/2-20	Moly	1.000 x 0.095	J0017895	J0017896				
5/8-18	Moly	1.000 x 0.095	J0017897	J0017898				
	Moly	1.250 x 0.095	J0017899	J0017900				
	Moly	1.250 x 0.120	J0017901	J0017902				
3/4-16	Moly	1.250 x 0.095	J0017905	J0017924				
	Moly	1.250 x 0.120	J0017903	J0017904				
	Moly	1.500 x 0.120	J0017906	J0017907				
	Moly	1.500 x 0.250	J0017908	J0017909				
	Moly	1.750 x 0.120	J0017910	J0017911				
	Moly	1.750 x 0.250	J0017912	J0017913				
7/8-14	Moly	1.750 x 0.120	J0017970	J0017973	J0019249	J0019267	J0019285	J0019303
	Moly	1.750 x 0.250	J0017971	J0017974	J0019247	J0019265	J0019283	J0019301
	Moly	1.750 x 0.375	J0017972	J0017975	J0019248	J0019266	J0019284	J0019302
1"-12	Moly	1.750 x 0.120	J0017914	J0017915				
	Moly	1.750 x 0.250	J0017916	J0017917				
1.25"-12 x 1"	Moly	1.750 x 0.120	J0017918	J0017919				
	Moly	2.000 x 0.250	J0017920	J0017921				
1.25"-12	Moly	1.750 x 0.120	J0017922	J0017923				
M10 x 1.50	PTFE	0.750 x 0.095	J0017992	J0017993	J0019258	J0019276	J0019294	J0019132
	Moly		J0017976	J0017977	J0019250	J0019268	J0019286	J0019304
M12 x 1.75	PTFE	1.000 x 0.250	J0017994	J0017995	J0019259	J0019277	J0019295	J0019313
	Moly		J0017978	J0017979	J0019251	J0019269	J0019287	J0019305
M14 x 2.00	Moly	1.000 x 0.120	J0017980	J0017981	J0019252	J0019270	J0019288	J0019306
M16 x 2.00	PTFE	1.000 x 0.095	J0017996	J0017997	J0019260	J0019278	J0019296	J0019314
	Moly		J0017982	J0017983	J0019253	J0019271	J0019289	J0019307



## ROD END KITS - STYLE: Y

Each Kit contains spacers, face seals, thread bungs, nuts, bolts and washers suitable to the quantity of rod ends in the kit. Three rod end choices are available.



Rod End Construction					1 RH Kit	1 LH Kit	2 Rod Ends	4 Rod Ends	6 Rod Ends	8 Rod Ends
Thread	Bore	Housing	Bearing Race	Tube Size						
1/2-20	1/2	Plated Steel	PTFE	1.000 x 0.095	J0000733	J0000727	J0001246	J0001252	J0001258	J0001264
		Chromed	PTFE	1.000 x 0.095	J0000731	J0000725	J0001244	J0001250	J0001256	J0001262
		Chrome Moly	Nylon	1.000 x 0.095	J0000735	J0000729	J0001242	J0001248	J0001254	J0001260
5/8-18	5/8	Plated Steel	PTFE	1.000 x 0.095	J0008966	J0008948	J0009707	J0009713	J0009719	J0009725
				1.250 x 0.095	J0008972	J0008954	J0009731	J0009737	J0009743	J0009749
				1.250 x 0.120	J0008978	J0008960	J0009755	J0009761	J0009767	J0009773
		Chrome Plated Steel Housing	PTFE	1.000 x 0.095	J0008964	J0008946	J0009705	J0009711	J0009717	J0009723
				1.250 x 0.095	J0008970	J0008952	J0009729	J0009735	J0009741	J0009747
				1.250 x 0.120	J0008976	J0008958	J0009753	J0009759	J0009765	J0009722
		Chrome Plated Chrome Moly	Slotted Nylon	1.000 x 0.095	J0008968	J0008950	J0009703	J0009709	J0009715	J0009721
				1.250 x 0.095	J0008974	J0008956	J0009727	J0009733	J0009739	J0009745
				1.250 x 0.120	J0008980	J0008962	J0009751	J0009757	J0009763	J0009769
3/4-16	3/4	Plated Steel	PTFE	1.250 x 0.095	J0005878	J0005852	J0005913	J0005917	J0005921	J0005925
				1.250 x 0.120	J0005884	J0005856	J0005931	J0005935	J0005939	J0005943
				1.500 x 0.120	J0005890	J0005860	J0005947	J0005951	J0005955	J0005959
				1.500 x 0.250	J0005896	J0005864	J0005963	J0005967	J0005971	J0005975
				1.750 x 0.120	J0005902	J0005868	J0005979	J0005983	J0005987	J0005991
				1.750 x 0.250	J0005908	J0005872	J0005995	J0005999	J0006003	J0006007
		Chrome Plated Chrome Moly	Slotted Nylon	1.250 x 0.095	J0005880	J0005854	J0005912	J0005916	J0005920	J0005924
				1.250 x 0.120	J0005886	J0005858	J0005929	J0005933	J0005937	J0005941
				1.500 x 0.120	J0005892	J0005862	J0005945	J0005949	J0005953	J0005957
				1.500 x 0.250	J0005898	J0005866	J0005961	J0005965	J0005969	J0005973
				1.750 x 0.120	J0005904	J0005870	J0005977	J0005981	J0005985	J0005989
				1.750 x 0.250	J0005910	J0005874	J0005993	J0005997	J0006001	J0006005
1"-12	1.0"	Plated Steel	PTFE	1.750 x 0.120	J0000597	J0000589	J0000560	J0000564	J0000568	J0000572
				1.750 x 0.250	J0000601	J0000593	J0000576	J0000580	J0000584	J0000588
1"-12	1.0"	Chrome Pltd Chrome Moly	Slotted Nylon	1.750 x 0.120	J0000599	J0000591	J0000558	J0000562	J0000566	J0000570
				1.750 x 0.250	J0000603	J0000595	J0000574	J0000578	J0000582	J0000586
1.25"-12	1.0"	Chrome Pltd Chrome Moly	Slotted Nylon	1.750 x 0.120	J0000553	J0000549	J0000534	J0000536	J0000538	J0000540
				2.000 x 0.250	J0000555	J0000551	J0000542	J0000544	J0000546	J0000548
1.25"-12	1.25"	Chrome Pltd Chrome Moly	Slotted Nylon	1.750 x 0.120	J0000531	J0000529	J0000522	J0000524	J0000526	J0000528
				2.000 x 0.250	J0017927	J0017928	J0017938	J0017940	J0017942	J0017944

Style "Y" Rod End Kits Feature...

Rod End Washers



Rubber Face Seals



## ROD END KITS - STYLE: Z

Each Kit contains misalignment inserts, rubber boots, thread bungs, nuts, bolts and washers suitable to the quantity of rod ends in the kit. Three rod end choices are available.



Rod End Construction										
Thread	Bore	Housing	Bearing Race	Tube Size	1 RH Kit	1 LH Kit	2 Rod Ends	4 Rod Ends	6 Rod Ends	8 Rod Ends
1/2-20	1/2	Plated Steel	PTFE	1.000 x 0.095	J0000734	J0000728	J0001245	J0001251	J0001257	J0001263
		Chromed	PTFE	1.000 x 0.095	J0000732	J0000726	J0001243	J0001249	J0001255	J0001261
		Chrome Moly	Nylon	1.000 x 0.095	J0000736	J0000730	J0001241	J0001247	J0001253	J0001259
5/8-18	5/8	Plated Steel	PTFE	1.000 x 0.095	J0008967	J0008949	J0009706	J0009712	J0009718	J0009724
				1.250 x 0.095	J0008973	J0008955	J0009730	J0009736	J0009742	J0009748
				1.250 x 0.120	J0008979	J0008961	J0009754	J0009760	J0009766	J0009772
		Chrome Plated Steel Housing	PTFE	1.000 x 0.095	J0008965	J0008947	J0009704	J0009710	J0009716	J0009722
				1.250 x 0.095	J0008971	J0008953	J0009728	J0009734	J0009740	J0009746
				1.250 x 0.120	J0008977	J0008959	J0009752	J0009758	J0009764	J0009770
		Chrome Plated Chrome Moly	Slotted Nylon	1.000 x 0.095	J0008969	J0008951	J0009702	J0009708	J0009714	J0009720
				1.250 x 0.095	J0008975	J0008957	J0009726	J0009732	J0009738	J0009744
				1.250 x 0.120	J0008981	J0008963	J0009750	J0009756	J0009762	J0009768
3/4-16	3/4	Plated Steel	PTFE	1.250 x 0.095	J0005879	J0005853	J0005915	J0005919	J0005923	J0005927
				1.250 x 0.120	J0005885	J0005857	J0005930	J0005934	J0005938	J0005942
				1.500 x 0.120	J0005891	J0005861	J0005946	J0005950	J0005954	J0005958
				1.500 x 0.250	J0005897	J0005865	J0005962	J0005966	J0005970	J0005974
				1.750 x 0.120	J0005903	J0005869	J0005978	J0005982	J0005986	J0005990
				1.750 x 0.250	J0005909	J0005873	J0005994	J0005998	J0006002	J0006006
		Chrome Plated Chrome Moly	Slotted Nylon	1.250 x 0.095	J0005881	J0005855	J0005914	J0005918	J0005922	J0005926
				1.250 x 0.120	J0005887	J0005859	J0005928	J0005932	J0005936	J0005940
				1.500 x 0.120	J0005893	J0005863	J0005944	J0005948	J0005942	J0005956
				1.500 x 0.250	J0005899	J0005867	J0005960	J0005964	J0005968	J0005972
				1.750 x 0.120	J0005905	J0005871	J0005976	J0005980	J0005984	J0005988
				1.750 x 0.250	J0005911	J0005875	J0005992	J0005996	J0006000	J0006004
1"-12	1.0"	Plated Steel	PTFE	1.750 x 0.120	J0000598	J0000590	J0000559	J0000563	J0000567	J0000571
				1.750 x 0.250	J0000602	J0000594	J0000575	J0000579	J0000583	J0000587
1"-12	1.0"	Chrome Pltd Chrome Moly	Slotted Nylon	1.750 x 0.120	J0000600	J0000592	J0000557	J0000561	J0000565	J0000569
				1.750 x 0.250	J0000604	J0000596	J0000573	J0000577	J0000581	J0000585
1.25"-12	1.0"	Chrome Pltd Chrome Moly	Slotted Nylon	1.750 x 0.120	J0000554	J0000550	J0000533	J0000535	J0000537	J0000539
				2.000 x 0.250	J0000556	J0000552	J0000541	J0000543	J0000545	J0000547
1.25"-12	1.25"	Chrome Pltd Chrome Moly	Slotted Nylon	1.750 x 0.120	J0000532	J0000530	J0000521	J0000523	J0000525	J0000527
				2.000 x 0.250	J0017925	J0017926	J0017937	J0017939	J0017941	J0017943

Style "Z" Rod End Kits Feature...

Misalignment Inserts



Rubber Boots



## MONSTER KITS

855 pc kit

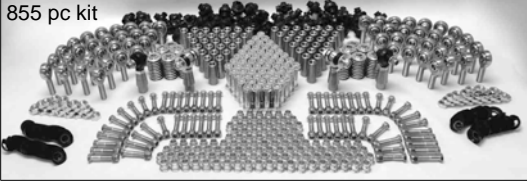

Steinjäger *Monster Kits* provide great value based on standard pack quantities. Rod Ends are 4130 Heat Treated Chrome Moly, with a bright chrome finish, and a slotted nylon bearing race. Thread bungs are also 4130 chrome moly. Kits include all the components needed for both high misalignment insert and spacer-type suspension systems.

Part#	Pcs in Kit	4130 Chrome Moly Rod Ends		Qty of Rod Ends		Fits Tubing Size	Qty of Bungs		Qty of Inserts	Qty of Spacers	Qty of		Qty of	
		Thread	Bore	RH	LH		RH	LH			Seals	Boots	Nuts	Bolts
J0015180	855	1/2-20	1/2	30	30	0.875" x 0.065"	30	30	120	120	120	60	180	120
J0015181	855	1/2-20	1/2	30	30	1.000" x 0.083"	30	30	120	120	120	60	180	120
J0015182	855	1/2-20	1/2	30	30	1.000" x 0.095"	30	30	120	120	120	60	180	120
J0015176	700	5/8-18	5/8	25	25	1.000" x 0.095"	25	25	100	100	100	50	150	100
J0015177	700	5/8-18	5/8	25	25	1.125" x 0.083"	25	25	100	100	100	50	150	100
J0015178	700	5/8-18	5/8	25	25	1.250" x 0.095"	25	25	100	100	100	50	150	100
J0015179	700	5/8-18	5/8	25	25	1.250" x 0.120"	25	25	100	100	100	50	150	100
J0015170	560	3/4-16	3/4	20	20	1.250" x 0.095"	20	20	80	80	80	40	120	80
J0015171	560	3/4-16	3/4	20	20	1.250" x 0.120"	20	20	80	80	80	40	120	80
J0015172	560	3/4-16	3/4	20	20	1.375" x 0.095"	20	20	80	80	80	40	120	80
J0015173	560	3/4-16	3/4	20	20	1.500" x 0.120"	20	20	80	80	80	40	120	80
J0015174	560	3/4-16	3/4	20	20	1.500" x 0.250"	20	20	80	80	80	40	120	80
J0015175	560	3/4-16	3/4	20	20	1.750" x 0.120"	20	20	80	80	80	40	120	80
J0015161	280	3/4-16	5/8	10	10	1.250" x 0.095"	10	10	40	40	40	20	60	40
J0015162	280	3/4-16	5/8	10	10	1.250" x 0.120"	10	10	40	40	40	20	60	40
J0015168	312	7/8-14	7/8	12	12	1.500" x 0.120"	12	12	48	48	48	0	72	48
J0015169	312	7/8-14	7/8	12	12	1.750" x 0.120"	12	12	48	48	48	0	72	48
J0015166	312	7/8-14	3/4	12	12	1.500" x 0.120"	12	12	48	48	48	0	72	48
J0015167	312	7/8-14	3/4	12	12	1.750" x 0.120"	12	12	48	48	48	0	72	48
J0015164	312	1"-12	1.0"	12	12	1.750" x 0.250"	12	12	48	48	48	0	72	48
J0015165	312	1"-14	1.0"	12	12	1.750" x 0.250"	12	12	48	48	48	0	72	48
J0015163	312	1.25"-12	1.0"	12	12	1.750" x 0.120"	12	12	48	48	48	0	72	48

The Monster Kit line up...

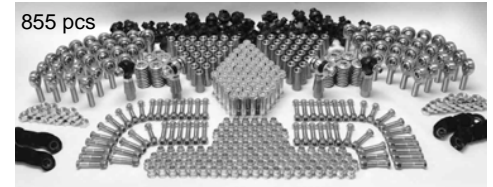
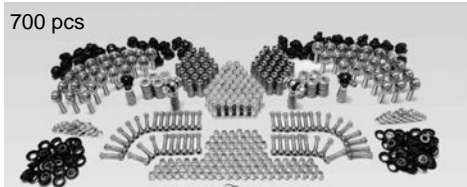
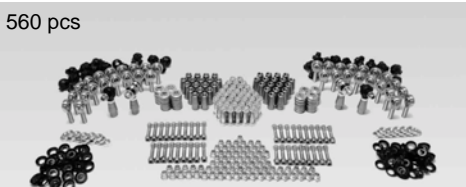
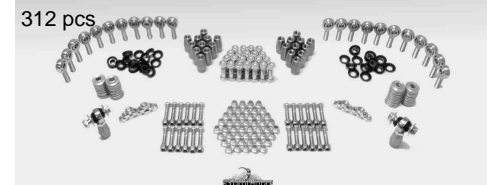

Our *Monster* kits contain **both** inserts & spacers, **and** boots and seals.



### Bulk Uniballs (COM's, Spherical Plain Bearings)



Steinjäger Uniballs (also called 'COM Bearings' or 'Spherical Plain Bearings') come in a variety of sizes, materials and bearing races. Other quantity options available - refer to our website.

On the plated series of Uniballs, the ball is made from 52100 alloy steel, and is heat treated and hard chrome plated. On the stainless series, the ball is 440C stainless.

Part#	Bore (ID)	Qty/ Pack	Housing Material	Bearing Race	Housing Diameter	Housing Width	Ball Width
J0014545	8mm	10	Plated Steel	Steel	22mm	9mm	12mm
J0014508	10mm	5			26mm	10.5mm	14mm
J0014510	12mm	10			30mm	12mm	16mm
J0014514	16mm	10			38mm	15mm	21mm
J0014499	0.2500"	10	Plated Steel	Steel	0.6562"	0.250"	0.343"
J0014532	0.3125"	25			0.7500"	0.281"	0.375"
J0014525	0.3750"	10			0.8125"	0.312"	0.406"
J0014497	0.5000"	5			1.0000"	0.390"	0.500"
J0014542	0.6250"	4			1.1875"	0.500"	0.625"
J0014517	0.7500"	10			1.4375"	0.593"	0.750"
J0014485	1.0000"	5			1.7500"	0.797"	1.000"
J0014547	6mm	10			Plated Steel	PTFE	18mm
J0014509	10mm	5	26mm	10.5mm			14mm
J0014511	12mm	10	30mm	12mm			16mm
J0014515	16mm	10	38mm	15mm			21mm
J0014500	0.2500"	10	Plated Steel	PTFE	0.6562"	0.250"	0.343"
J0014533	0.3125"	25			0.7500"	0.281"	0.375"
J0014527	0.3750"	10			0.8125"	0.312"	0.406"

Part#	Bore (ID)	Qty/ Pack	Housing Material	Bearing Race	Housing Diameter	Housing Width	Ball Width	
J0014498	0.5000"	5	Plated Steel	PTFE	1.0000"	0.390"	0.500"	
J0014538	0.6250"	10			1.1875"	0.500"	0.625"	
J0014519	0.7500"	10			1.4375"	0.593"	0.750"	
J0014489	1.0000"	5			1.7500"	0.797"	1.000"	
J0014546	8mm	10	Plated Steel	Nylon	22mm	9mm	12mm	
J0014507	10mm	4			26mm	10.5mm	14mm	
J0014512	12mm	4			30mm	12mm	16mm	
J0014530	0.3125"	10	Plated Steel	Nylon	0.7500"	0.281"	0.375"	
J0014526	0.3750"	10			0.8125"	0.312"	0.406"	
J0014491	0.5000"	10			1.0000"	0.390"	0.500"	
J0014537	0.6250"	10			1.1875"	0.500"	0.625"	
J0014518	0.7500"	10		1.4375"	0.593"	0.750"		
J0014486	1.0000"	5		1.7500"	0.797"	1.000"		
J0014531	0.3125"	10		Stainless 17-4	PTFE	0.7500"	0.281"	0.375"
J0014528	0.3750"	5				0.8125"	0.312"	0.406"
J0014544	0.6250"	5	1.1875"			0.500"	0.625"	
J0014522	0.7500"	5	1.4375"			0.593"	0.750"	
J0014487	1.0000"	5			1.7500"	0.797"	1.000"	

### Control Arm Studs



Use Steinjäger Control Arm Studs to provide a ball joint stud in uniballs (COM bearings) and spherical rod ends.

Stud: Grade 8, Chrome Plated  
Bushings: Zinc Plated  
Nuts: Locking, Zinc Plated

Fits Rod End Size of...	Steinjäger Part#
1/4-28	J0028799
5/16-24	J0028800
3/8-24	J0028801
1/2-20	J0028802
9/16-18	J0028803

Fits Rod End Size of...	Steinjäger Part#
5/8-18	J0028804
3/4-16	J0028805
M6 x 1.00	J0028806
M8 x 1.25	J0028807
M10 x 1.50	J0028808

### Other Unique Products...

#### Notched Tubes



#### Weldable Kits



#### Contract Manufacturing





**UNIBALL OPTIONS**

Snap Ring Only	Cup Only	Snap Ring & Cup Kit	Uniball, Snap Ring & Cup Kit
			
Steinjäger retaining rings ('snap rings') are made from steel and are plated zinc black.	Our Uniball Cups are machined from 4130 Chrome Moly and are designed to contain the Uniball via a machined lip on one side, and a snap ring on the other.	This kit includes the matching steel Cup and plated steel Snap Ring.	This kit includes a PTFE race Uniball (also called 'COM Bearing' or 'Spherical Plain Bearing'), a steel Cup and a plated steel Snap Ring.

Nominal	Part#	OD	Thickness	Part#	Cup OD	Cup ID	Cup Length	Part#	Part#
1/4"	J0024003	0.720"	0.040"	J0024099	0.875"	0.656"	0.674"	J0024063	J0024081
3/8"	J0024005	0.901"	0.042"	J0024100	1.000"	0.813"	0.716"	J0024064	J0024082
1/2"	J0024006	1.111"	0.042"	J0024101	1.250"	1.000"	0.864"	J0024065	J0024083
9/16"	J0024007	1.180"	0.050"	J0024102	1.312"	1.094"	0.919"	J0024066	J0024084
5/8"	J0024008	1.319"	0.050"	J0024103	1.437"	1.188"	1.014"	J0024067	J0024085
3/4" A	J0024009	1.596"	0.050"	J0024104	1.750"	1.438"	1.169"	J0024068	J0024086
3/4" B	J0024010	1.804"	0.062"	J0024105	1.875"	1.625"	1.161"	J0024069	J0024087
1.0" A	J0024011	1.942"	0.062"	J0024106	2.125"	1.750"	1.491"	J0024070	J0024088
1.0" B	J0024012	2.210"	0.062"	J0024107	2.312"	2.000"	1.411"	J0024071	J0024089
1-3/16"	J0024013	2.630"	0.078"	J0024108	2.750"	2.375"	1.715"	J0024072	J0024090
1-1/4"	J0024013	2.630"	0.078"	J0024109	2.750"	2.375"	1.715"	J0024073	J0024091
1-1/2" A	J0024014	3.050"	0.093"	J0024110	3.125"	2.750"	1.948"	J0024074	J0024092
1-1/2" B	J0024019	3.130"	0.098"	J0024111	3.250"	2.917"	1.950"	J0024075	J0024093
8mm	J0024016	23.5mm	1.0mm	J0024112	26mm	22mm	18.3mm	J0024076	J0024094
10mm	J0024017	27.9mm	1.2mm	J0024113	31mm	26mm	21.7mm	J0024077	J0024095
12mm	J0024018	32.1mm	1.2mm	J0024114	36mm	30mm	24.2mm	J0024078	J0024096
14mm	J0024019	36.5mm	1.5mm	J0024115	40mm	34mm	27.0mm	J0024079	J0024097
16mm	J0024020	40.8mm	1.5mm	J0024116	44mm	38mm	28.5mm	J0024080	J0024098

**Steinjäger Jobber & Dealer Programs**



Steinjäger offers a four tiered pricing system for *Jobbers*, and *Dealers* who install or resell motorsport products. Choose from over 20,000 universal products and a growing list of vehicle-specific products.

**JOBBER Program**

Buy In	None
Requirements	Must be (1) a traditional brick-and-mortar business, or (2) an online shop or (3) have a relevant business license/tax id.
Drop Ship Allowed	Yes
Steinjäger Discount	27%
Private Labeling	Yes

**DEALER Program**

Buy In	\$5,000 <i>annual</i> buy-in. Annual buy-in requirement is waived in any 12 month period during which sales exceed \$25,000. Midwest Control Products sales count toward \$25,000 calc.
Drop Ship Allowed	Yes
Steinjäger Discount	33%
Private Labeling	Yes

## Male Polyurethane Bushings



Steinjäger Male Poly Bushings come in a variety of finishes (zinc plated, black powdered, or chrome plated) and feature a **grade 8** threaded male stem.

- Each kit includes the following:
- (1) DOM Steel Housing with grade 8 threaded Stem
  - (2) Black Polyurethane Bushings
  - (1) Plated Steel DOM Sleeve
  - (1) Grease Zerk with plastic cap
  - (1) Jam Nut

1/2-20 Threads		Zinc Clear (Silver) Plated				Black Powder Paint (threads are bare)				Polished Chrome (threads are bare)				
Thread	Bore	1.50" wide	1.75"	2.50"	3.00"	1.50"	1.75"	2.50"	3.00"	1.50"	1.75"	2.50"	3.00"	
1/2-20	3/8	RH	J0012180	J0012444	J0012708	J0012972	J0012179	J0012443	J0012707	J0012971	J0012178	J0012442	J0012706	J0012970
		LH	J0012177	J0012441	J0012705	J0012969	J0012176	J0012440	J0012704	J0012968	J0012175	J0012439	J0012703	J0012967
	1/2	RH	J0012120	J0012384	J0012648	J0012912	J0012119	J0012383	J0012647	J0012911	J0012118	J0012382	J0012646	J0012910
		LH	J0012117	J0012381	J0012645	J0012909	J0012116	J0012380	J0012644	J0012908	J0012115	J0012379	J0012643	J0012907
	9/16	RH	J0012300	J0012564	J0012828	J0013092	J0012299	J0012563	J0012827	J0013091	J0012298	J0012562	J0012826	J0013090
		LH	J0012297	J0012561	J0012825	J0013089	J0012296	J0012560	J0012824	J0013088	J0012295	J0012559	J0012823	J0013087
	5/8	RH	J0012240	J0012504	J0012768	J0013032	J0012239	J0012503	J0012767	J0013031	J0012238	J0012502	J0012766	J0013030
		LH	J0012237	J0012501	J0012765	J0013029	J0012236	J0012500	J0012764	J0013028	J0012235	J0012499	J0012763	J0013027

5/8-18 Threads		Zinc Clear (Silver) Plated				Black Powder Paint (threads are bare)				Polished Chrome (threads are bare)				
Thread	Bore	1.50" wide	1.75"	2.50"	3.00"	1.50"	1.75"	2.50"	3.00"	1.50"	1.75"	2.50"	3.00"	
5/8-18	3/8	RH	J0012192	J0012456	J0012720	J0012984	J0012191	J0012455	J0012719	J0012983	J0012190	J0012454	J0012718	J0012982
		LH	J0012189	J0012453	J0012717	J0012981	J0012188	J0012452	J0012716	J0012980	J0012187	J0012451	J0012715	J0012979
	1/2	RH	J0012132	J0012396	J0012660	J0012924	J0012131	J0012395	J0012659	J0012923	J0012130	J0012394	J0012658	J0012922
		LH	J0012129	J0012393	J0012657	J0012921	J0012128	J0012392	J0012656	J0012920	J0012127	J0012391	J0012655	J0012919
	9/16	RH	J0012312	J0012576	J0012840	J0013104	J0012311	J0012575	J0012839	J0013103	J0012310	J0012574	J0012838	J0013102
		LH	J0012309	J0012573	J0012837	J0013101	J0012308	J0012572	J0012836	J0013100	J0012307	J0012571	J0012835	J0013099
	5/8	RH	J0012252	J0012516	J0012780	J0013044	J0012251	J0012515	J0012779	J0013043	J0012250	J0012514	J0012778	J0013042
		LH	J0012249	J0012513	J0012777	J0013041	J0012248	J0012512	J0012776	J0013040	J0012247	J0012511	J0012775	J0013039

3/4-16 Threads		Zinc Clear (Silver) Plated				Black Powder Paint (threads are bare)				Polished Chrome (threads are bare)				
Thread	Bore	1.50" wide	1.75"	2.50"	3.00"	1.50"	1.75"	2.50"	3.00"	1.50"	1.75"	2.50"	3.00"	
3/4-16	3/8	RH	J0012186	J0012450	J0012714	J0012978	J0012185	J0012449	J0012713	J0012977	J0012184	J0012448	J0012712	J0012976
		LH	J0012183	J0012447	J0012711	J0012975	J0012182	J0012446	J0012710	J0012974	J0012181	J0012445	J0012709	J0012973
	1/2	RH	J0012126	J0012390	J0012654	J0012918	J0012125	J0012389	J0012653	J0012917	J0012124	J0012388	J0012652	J0012916
		LH	J0012123	J0012387	J0012651	J0012915	J0012122	J0012386	J0012650	J0012914	J0012121	J0012385	J0012649	J0012913
	9/16	RH	J0012306	J0012570	J0012834	J0013098	J0012305	J0012569	J0012833	J0013097	J0012304	J0012568	J0012832	J0013096
		LH	J0012303	J0012567	J0012831	J0013095	J0012302	J0012566	J0012830	J0013094	J0012301	J0012565	J0012829	J0013093
	5/8	RH	J0012246	J0012510	J0012774	J0013038	J0012245	J0012509	J0012773	J0013037	J0012244	J0012508	J0012772	J0013036
		LH	J0012243	J0012507	J0012771	J0013035	J0012242	J0012506	J0012770	J0013034	J0012241	J0012505	J0012769	J0013033

Other Unique Products...

Notched Tubes

Weldable Kits

TBF Series Female Poly Bushings



## Male Polyurethane Bushings



Steinjäger Male Poly Bushings come in a variety of finishes (zinc plated, black powdered, or chrome plated) and feature a **grade 8** threaded male stem.

Each kit includes the following:

- (1) DOM Steel Housing with grade 8 threaded Stem
- (2) Black Polyurethane Bushings
- (1) Plated Steel DOM Sleeve
- (1) Grease Zerk with plastic cap
- (1) Jam Nut

7/8-14 Threads		Zinc Clear (Silver) Plated				Black Powder Paint (threads are bare)				Polished Chrome (threads are bare)				
Thread	Bore	1.50" wide	1.75"	2.50"	3.00"	1.50"	1.75"	2.50"	3.00"	1.50"	1.75"	2.50"	3.00"	
7/8-14	3/8	RH	J0012198	J0012462	J0012726	J0012990	J0012197	J0012461	J0012725	J0012989	J0012196	J0012460	J0012724	J0012988
		LH	J0012195	J0012459	J0012723	J0012987	J0012194	J0012458	J0012722	J0012986	J0012193	J0012457	J0012721	J0012985
	1/2	RH	J0012138	J0012402	J0012666	J0012930	J0012137	J0012401	J0012665	J0012929	J0012136	J0012400	J0012664	J0012928
		LH	J0012135	J0012399	J0012663	J0012927	J0012134	J0012398	J0012662	J0012926	J0012133	J0012397	J0012661	J0012925
	9/16	RH	J0012318	J0012582	J0012846	J0013110	J0012317	J0012581	J0012845	J0013109	J0012316	J0012580	J0012844	J0013108
		LH	J0012315	J0012579	J0012843	J0013107	J0012314	J0012578	J0012842	J0013106	J0012313	J0012577	J0012841	J0013105
	5/8	RH	J0012258	J0012522	J0012786	J0013050	J0012257	J0012521	J0012785	J0013049	J0012256	J0012520	J0012784	J0013048
		LH	J0012255	J0012519	J0012783	J0013047	J0012254	J0012518	J0012782	J0013046	J0012253	J0012517	J0012781	J0013045

1"-12 Threads		Zinc Clear (Silver) Plated				Black Powder Paint (threads are bare)				Polished Chrome (threads are bare)				
Thread	Bore	1.50" wide	1.75"	2.50"	3.00"	1.50"	1.75"	2.50"	3.00"	1.50"	1.75"	2.50"	3.00"	
1"-12	3/8	RH	J0012174	J0012438	J0012702	J0012966	J0012173	J0012437	J0012701	J0012965	J0012172	J0012436	J0012700	J0012964
		LH	J0012171	J0012435	J0012699	J0012963	J0012170	J0012434	J0012698	J0012962	J0012169	J0012433	J0012697	J0012961
	1/2	RH	J0012114	J0012378	J0012642	J0012906	J0012113	J0012377	J0012641	J0012905	J0012112	J0012376	J0012640	J0012904
		LH	J0012111	J0012375	J0012639	J0012903	J0012110	J0012374	J0012638	J0012902	J0012109	J0012373	J0012637	J0012901
	9/16	RH	J0012294	J0012558	J0012822	J0013086	J0012293	J0012557	J0012821	J0013085	J0012292	J0012556	J0012820	J0013084
		LH	J0012291	J0012555	J0012819	J0013083	J0012290	J0012554	J0012818	J0013082	J0012289	J0012553	J0012817	J0013081
	5/8	RH	J0012234	J0012498	J0012762	J0013026	J0012233	J0012497	J0012761	J0013025	J0012232	J0012496	J0012760	J0013024
		LH	J0012231	J0012495	J0012759	J0013023	J0012230	J0012494	J0012758	J0013022	J0012229	J0012493	J0012757	J0013021

1.25"-12 Threads		Zinc Clear (Silver) Plated				Black Powder Paint (threads are bare)				Polished Chrome (threads are bare)				
Thread	Bore	1.50" wide	1.75"	2.50"	3.00"	1.50"	1.75"	2.50"	3.00"	1.50"	1.75"	2.50"	3.00"	
1.25"-12	3/8	RH	J0012168	J0012432	J0012696	J0012960	J0012167	J0012431	J0012695	J0012959	J0012166	J0012430	J0012694	J0012958
		LH	J0012165	J0012429	J0012693	J0012957	J0012164	J0012428	J0012692	J0012956	J0012163	J0012427	J0012691	J0012955
	1/2	RH	J0012108	J0012372	J0012636	J0012900	J0012107	J0012371	J0012635	J0012632	J0012106	J0012370	J0012634	J0012898
		LH	J0012105	J0012369	J0012633	J0012897	J0012104	J0012368	J0012899	J0012896	J0012103	J0012367	J0012631	J0012895
	9/16	RH	J0012288	J0012552	J0012816	J0013080	J0012287	J0012551	J0012815	J0012812	J0012286	J0012550	J0012814	J0013078
		LH	J0012285	J0012549	J0012813	J0013077	J0012284	J0012548	J0013079	J0013076	J0012283	J0012547	J0012811	J0013075
	5/8	RH	J0012228	J0012492	J0012756	J0013020	J0012227	J0012491	J0012755	J0012752	J0012226	J0012490	J0012754	J0013018
		LH	J0012225	J0012489	J0012753	J0013017	J0012224	J0012488	J0013019	J0013016	J0012223	J0012487	J0012751	J0013015

### Hex Bar Tubes



Pages 60-63

### Double Adjustable Poly Assys



Pages 24-29

### Tab Kits



Pages 40-46

### Male Kits



Pages 16-21

## 1/2" Male Poly Bushing Kits



Steinjäger Male Poly Bushings Kits come in a variety of finishes (zinc plated, black powdered, or chrome plated) and feature a **grade 8** threaded male stem. Kits come with 1, 2, 4, 6 or 8 poly ends.

Each kit includes the following

- (1) DOM Steel Housing with grade 8 threaded Stem
- (2) Black Poly Bushings
- (1) Plated Steel DOM Sleeve
- (1) Grease Zerk
- (1) Grease Zerk Cap
- (1) Jam Nut
- (1) Grade 8 Bolt
- (1) Lock Nut & (2) Washers
- (1) Thread Bung for 1.000" x 0.095" Tubing

1 Rod End/Kit		Zinc Clear (Silver) Plated				Black Powder Paint (threads are bare)				Polished Chrome (threads are bare)				
Thread	Bore	1.50" wide	1.75"	2.50"	3.00"	1.50"	1.75"	2.50"	3.00"	1.50"	1.75"	2.50"	3.00"	
1/2-20	3/8	RH	J0006118	J0006121	J0006124	J0006127	J0006116	J0006119	J0006122	J0006125	J0006117	J0006120	J0006123	J0006126
		LH	J0006106	J0006109	J0006112	J0006115	J0006104	J0006107	J0006110	J0006113	J0006105	J0006108	J0006111	J0006114
	1/2	RH	J0000715	J0000718	J0000721	J0000724	J0000713	J0000716	J0000719	J0000712	J0000714	J0000717	J0000720	J0000723
		LH	J0000703	J0000706	J0000709	J0000712	J0000701	J0000704	J0000707	J0000710	J0000702	J0000705	J0000708	J0000711
	9/16	RH	J0010942	J0010945	J0010948	J0010951	J0010940	J0010943	J0010946	J0010949	J0010941	J0010944	J0010947	J0010950
		LH	J0010930	J0010933	J0010936	J0010939	J0010928	J0010931	J0010934	J0010937	J0010929	J0010932	J0010935	J0010938
	5/8	RH	J0008720	J0008723	J0008726	J0008729	J0008718	J0008721	J0008724	J0008727	J0008719	J0008722	J0008725	J0008728
		LH	J0008708	J0008711	J0008714	J0008717	J0008706	J0008709	J0008712	J0008715	J0008707	J0008710	J0008713	J0008716

2 Rod Ends/Kit		Zinc Clear (Silver) Plated				Black Powder Paint (threads are bare)				Polished Chrome (threads are bare)			
Thread	Bore	1.50" wide	1.75"	2.50"	3.00"	1.50"	1.75"	2.50"	3.00"	1.50"	1.75"	2.50"	3.00"
1/2-20	3/8	J0006584	J0006587	J0006590	J0006593	J0006585	J0006588	J0006591	J0006594	J0006586	J0006589	J0006592	J0006595
	1/2	J0001193	J0001196	J0001199	J0001202	J0001194	J0001197	J0001200	J0001203	J0001195	J0001198	J0001201	J0001204
(1) RH (1) LH	9/16	J0011408	J0011411	J0011414	J0011417	J0011409	J0011412	J0011415	J0011418	J0011410	J0011413	J0011416	J0011419
	5/8	J0009222	J0009225	J0009228	J0009231	J0009223	J0009226	J0009229	J0009232	J0009224	J0009227	J0009230	J0009233

4 Rod Ends/Kit		Zinc Clear (Silver) Plated				Black Powder Paint (threads are bare)				Polished Chrome (threads are bare)			
Thread	Bore	1.50" wide	1.75"	2.50"	3.00"	1.50"	1.75"	2.50"	3.00"	1.50"	1.75"	2.50"	3.00"
1/2-20	3/8	J0006596	J0006599	J0006602	J0006605	J0006597	J0006600	J0006603	J0006606	J0006598	J0006601	J0006604	J0006607
	1/2	J0001205	J0001208	J0001211	J0001214	J0001206	J0001209	J0001212	J0001215	J0001207	J0001210	J0001213	J0001216
(2) RH (2) LH	9/16	J0011420	J0011423	J0011426	J0011429	J0011421	J0011424	J0011427	J0011430	J0011422	J0011425	J0011428	J0011431
	5/8	J0009234	J0009237	J0009240	J0009243	J0009235	J0009238	J0009241	J0009244	J0009236	J0009239	J0009242	J0009245

6 Rod Ends/Kit		Zinc Clear (Silver) Plated				Black Powder Paint (threads are bare)				Polished Chrome (threads are bare)			
Thread	Bore	1.50" wide	1.75"	2.50"	3.00"	1.50"	1.75"	2.50"	3.00"	1.50"	1.75"	2.50"	3.00"
1/2-20	3/8	J0006608	J0006611	J0006614	J0006617	J0006609	J0006612	J0006615	J0006618	J0006610	J0006613	J0006616	J0006619
	1/2	J0001217	J0001220	J0001223	J0001226	J0001218	J0001221	J0001224	J0001227	J0001219	J0001222	J0001225	J0001228
(3) RH (3) LH	9/16	J0011432	J0011435	J0011438	J0011441	J0011433	J0011436	J0011439	J0011442	J0011434	J0011437	J0011440	J0011443
	5/8	J0009246	J0009249	J0009252	J0009255	J0009247	J0009250	J0009253	J0009256	J0009248	J0009251	J0009254	J0009257

8 Rod Ends/Kit		Zinc Clear (Silver) Plated				Black Powder Paint (threads are bare)				Polished Chrome (threads are bare)			
Thread	Bore	1.50" wide	1.75"	2.50"	3.00"	1.50"	1.75"	2.50"	3.00"	1.50"	1.75"	2.50"	3.00"
1/2-20	3/8	J0006620	J0006623	J0006626	J0006629	J0006621	J0006624	J0006627	J0006630	J0006622	J0006625	J0006628	J0006631
	1/2	J0001229	J0001232	J0001235	J0001238	J0001230	J0001233	J0001236	J0001239	J0001231	J0001234	J0001237	J0001240
(4) RH (4) LH	9/16	J0011444	J0011447	J0011450	J0011453	J0011445	J0011448	J0011451	J0011454	J0011446	J0011449	J0011452	J0011455
	5/8	J0009258	J0009261	J0009264	J0009267	J0009259	J0009262	J0009265	J0009268	J0009260	J0009263	J0009266	J0009269

2 per kit ->



4 per kit ->



6 per kit ->



8 per kit ->





### 5/8" Male Poly Bushing Kits



Steinjäger Male Poly Bushings Kits come in a variety of finishes (zinc plated, black powdered, or chrome plated) and feature a **grade 8** threaded male stem. Kits come with 1, 2, 4, 6 or 8 poly ends.

Each kit includes the following

- (1) DOM Steel Housing with grade 8 threaded Stem
- (2) Black Poly Bushings
- (1) Plated Steel DOM Sleeve
- (1) Grease Zerk
- (1) Grease Zerk Cap
- (1) Jam Nut
- (1) Grade 8 Bolt
- (1) Lock Nut & (2) Washers
- (1) Thread Bung

fits 1.000 x 0.095		Zinc Clear (Silver) Plated				Black Powder Paint (threads are bare)				Polished Chrome (threads are bare)				
Thread	Bore	1.50" wide	1.75"	2.50"	3.00"	1.50"	1.75"	2.50"	3.00"	1.50"	1.75"	2.50"	3.00"	
5/8-18	3/8	RH	J0006310	J0006313	J0006316	J0006319	J0006308	J0006311	J0006314	J0006317	J0006309	J0006312	J0006315	J0006318
		LH	J0006274	J0006277	J0006280	J0006283	J0006272	J0006275	J0006278	J0006281	J0006273	J0006276	J0006279	J0006282
	1/2	RH	J0000919	J0000922	J0000925	J0000928	J0000917	J0000920	J0000923	J0000926	J0000918	J0000921	J0000924	J0000927
		LH	J0000883	J0000886	J0000889	J0000892	J0000881	J0000884	J0000887	J0000890	J0000882	J0000885	J0000888	J0000891
	9/16	RH	J0011134	J0011137	J0011140	J0011143	J0011132	J0011135	J0011138	J0011141	J0011133	J0011136	J0011139	J0011142
		LH	J0011098	J0011101	J0011104	J0011107	J0011096	J0011099	J0011102	J0011105	J0011097	J0011100	J0011103	J0011106
	5/8	RH	J0008912	J0008915	J0008918	J0008921	J0008910	J0008913	J0008916	J0008919	J0008911	J0008914	J0008917	J0008920
		LH	J0008876	J0008879	J0008882	J0008885	J0008874	J0008877	J0008880	J0008883	J0008875	J0008878	J0008881	J0008884

fits 1.250 x 0.095		Zinc Clear (Silver) Plated				Black Powder Paint (threads are bare)				Polished Chrome (threads are bare)				
Thread	Bore	1.50" wide	1.75"	2.50"	3.00"	1.50"	1.75"	2.50"	3.00"	1.50"	1.75"	2.50"	3.00"	
5/8-18	3/8	RH	J0006322	J0006325	J0006328	J0006331	J0006320	J0006323	J0006326	J0006329	J0006321	J0006324	J0006327	J0006330
		LH	J0006286	J0006289	J0006292	J0006295	J0006284	J0006287	J0006290	J0006293	J0006285	J0006288	J0006291	J0006294
	1/2	RH	J0000931	J0000934	J0000937	J0000940	J0000929	J0000932	J0000935	J0000938	J0000930	J0000933	J0000936	J0000939
		LH	J0000895	J0000898	J0000901	J0000904	J0000893	J0000896	J0000899	J0000902	J0000894	J0000897	J0000900	J0000903
	9/16	RH	J0011146	J0011149	J0011152	J0011155	J0011144	J0011147	J0011150	J0011153	J0011145	J0011148	J0011151	J0011154
		LH	J0011110	J0011113	J0011116	J0011119	J0011108	J0011111	J0011114	J0011117	J0011109	J0011112	J0011115	J0011118
	5/8	RH	J0008924	J0008927	J0008930	J0008933	J0008922	J0008925	J0008928	J0008931	J0008923	J0008926	J0008927	J0008930
		LH	J0008888	J0008891	J0008894	J0008897	J0008886	J0008889	J0008892	J0008895	J0008887	J0008890	J0008893	J0008896

fits 1.250 x 0.120		Zinc Clear (Silver) Plated				Black Powder Paint (threads are bare)				Polished Chrome (threads are bare)				
Thread	Bore	1.50" wide	1.75"	2.50"	3.00"	1.50"	1.75"	2.50"	3.00"	1.50"	1.75"	2.50"	3.00"	
5/8-18	3/8	RH	J0006334	J0006337	J0006340	J0006343	J0006332	J0006335	J0006338	J0006341	J0006333	J0006336	J0006339	J0006342
		LH	J0006298	J0006301	J0006304	J0006307	J0006296	J0006299	J0006302	J0006305	J0006297	J0006300	J0006303	J0006306
	1/2	RH	J0000943	J0000946	J0000949	J0000952	J0000941	J0000944	J0000947	J0000950	J0000942	J0000945	J0000948	J0000951
		LH	J0000907	J0000910	J0000913	J0000916	J0000905	J0000908	J0000911	J0000914	J0000906	J0000909	J0000912	J0000915
	9/16	RH	J0011158	J0011161	J0011164	J0011167	J0011156	J0011159	J0011162	J0011165	J0011157	J0011160	J0011163	J0011166
		LH	J0011122	J0011125	J0011128	J0011131	J0011120	J0011123	J0011126	J0011129	J0011121	J0011124	J0011127	J0011130
	5/8	RH	J0008936	J0008939	J0008942	J0008945	J0008934	J0008937	J0008940	J0008943	J0008935	J0008938	J0008941	J0008944
		LH	J0008900	J0008903	J0008906	J0008909	J0008898	J0008901	J0008904	J0008907	J0008899	J0008902	J0008905	J0008908

Steinjäger offers 1,500+ different pre-cut tube diameters, styles and lengths in quantities of...

1 per



2 per



3 per



4 per



### 3/4" Male Poly Bushing Kits



Steinjäger Male Poly Bushings Kits come in a variety of finishes (zinc plated, black powdered, or chrome plated) and feature a **grade 8** threaded male stem. Kits come with 1, 2, 4, 6 or 8 poly ends.

Each kit includes the following

- (1) DOM Steel Housing with grade 8 threaded Stem
- (2) Black Poly Bushings
- (1) Plated Steel DOM Sleeve
- (1) Grease Zerk
- (1) Grease Zerk Cap
- (1) Jam Nut
- (1) Grade 8 Bolt
- (1) Lock Nut & (2) Washers
- (1) Thread Bung

fits 1.250 x 0.095		Zinc Clear (Silver) Plated				Black Powder Paint (threads are bare)				Polished Chrome (threads are bare)				
Thread	Bore	1.50" wide	1.75"	2.50"	3.00"	1.50"	1.75"	2.50"	3.00"	1.50"	1.75"	2.50"	3.00"	
3/4-16	3/8	RH	J0006202	J0006205	J0006208	J0006211	J0006200	J0006203	J0006206	J0006209	J0006201	J0006204	J0006207	J0006210
		LH	J0006130	J0006133	J0006136	J0006139	J0006128	J0006131	J0006134	J0006137	J0006129	J0006132	J0006135	J0006138
	1/2	RH	J0000811	J0000814	J0000817	J0000820	J0000809	J0000812	J0000815	J0000818	J0000810	J0000813	J0000816	J0000819
		LH	J0000739	J0000742	J0000745	J0000748	J0000737	J0000740	J0000743	J0000746	J0000738	J0000741	J0000744	J0000747
	9/16	RH	J0011026	J0011029	J0011032	J0011035	J0011024	J0011027	J0011030	J0011033	J0011025	J0011028	J0011031	J0011034
		LH	J0010954	J0010957	J0010960	J0010963	J0010952	J0010955	J0010958	J0010961	J0010953	J0010956	J0010959	J0010962
	5/8	RH	J0008804	J0008807	J0008810	J0008813	J0008802	J0008805	J0008808	J0008811	J0008803	J0008806	J0008809	J0008812
		LH	J0008732	J0008735	J0008738	J0008741	J0008730	J0008733	J0008736	J0008739	J0008731	J0008734	J0008737	J0008740

fits 1.250 x 0.120		Zinc Clear (Silver) Plated				Black Powder Paint (threads are bare)				Polished Chrome (threads are bare)				
Thread	Bore	1.50" wide	1.75"	2.50"	3.00"	1.50"	1.75"	2.50"	3.00"	1.50"	1.75"	2.50"	3.00"	
3/4-16	3/8	RH	J0006214	J0006217	J0006220	J0006223	J0006212	J0006215	J0006218	J0006221	J0006213	J0006216	J0006219	J0006222
		LH	J0006142	J0006145	J0006148	J0006151	J0006140	J0006143	J0006146	J0006149	J0006141	J0006144	J0006147	J0006150
	1/2	RH	J0000823	J0000826	J0000829	J0000832	J0000821	J0000824	J0000827	J0000830	J0000822	J0000825	J0000828	J0000831
		LH	J0000751	J0000754	J0000757	J0000760	J0000749	J0000752	J0000755	J0000758	J0000750	J0000753	J0000756	J0000759
	9/16	RH	J0011038	J0011041	J0011044	J0011047	J0011036	J0011039	J0011042	J0011045	J0011037	J0011040	J0011043	J0011046
		LH	J0010966	J0010969	J0010972	J0010975	J0010964	J0010967	J0010970	J0010973	J0010965	J0010968	J0010971	J0010974
	5/8	RH	J0008816	J0008819	J0008822	J0008825	J0008814	J0008817	J0008820	J0008823	J0008815	J0008818	J0008821	J0008824
		LH	J0008744	J0008747	J0008750	J0008753	J0008742	J0008745	J0008748	J0008751	J0008743	J0008746	J0008749	J0008752

fits 1.500 x 0.120		Zinc Clear (Silver) Plated				Black Powder Paint (threads are bare)				Polished Chrome (threads are bare)				
Thread	Bore	1.50" wide	1.75"	2.50"	3.00"	1.50"	1.75"	2.50"	3.00"	1.50"	1.75"	2.50"	3.00"	
3/4-16	3/8	RH	J0006226	J0006229	J0006232	J0006235	J0006224	J0006227	J0006230	J0006233	J0006225	J0006228	J0006231	J0006234
		LH	J0006154	J0006157	J0006160	J0006163	J0006152	J0006155	J0006158	J0006161	J0006153	J0006156	J0006159	J0006162
	1/2	RH	J0000835	J0000838	J0000841	J0000844	J0000833	J0000836	J0000839	J0000842	J0000834	J0000837	J0000840	J0000843
		LH	J0000763	J0000766	J0000769	J0000772	J0000761	J0000764	J0000767	J0000770	J0000762	J0000765	J0000768	J0000771
	9/16	RH	J0011050	J0011053	J0011056	J0011059	J0011048	J0011051	J0011054	J0011057	J0011049	J0011052	J0011055	J0011058
		LH	J0010978	J0010981	J0010984	J0010987	J0010976	J0010979	J0010982	J0010985	J0010977	J0010980	J0010983	J0010986
	5/8	RH	J0008828	J0008831	J0008834	J0008837	J0008826	J0008829	J0008832	J0008835	J0008827	J0008830	J0008833	J0008836
		LH	J0008756	J0008759	J0008762	J0008765	J0008754	J0008757	J0008760	J0008763	J0008755	J0008758	J0008761	J0008764

Steinjäger also offers all of the above combinations in kits with 2 rod ends, 4 rod ends, 6 rod ends or 8 rod ends.

2 per kit ->



4 per kit ->



6 per kit ->



8 per kit ->



fits 1.500 x 0.250		Zinc Clear (Silver) Plated				Black Powder Paint (threads are bare)				Polished Chrome (threads are bare)				
Thread	Bore	1.50" wide	1.75"	2.50"	3.00"	1.50"	1.75"	2.50"	3.00"	1.50"	1.75"	2.50"	3.00"	
3/4-16	3/8	RH	J0006238	J0006241	J0006244	J0006247	J0006236	J0006239	J0006242	J0006245	J0006237	J0006240	J0006243	J0006246
		LH	J0006166	J0006169	J0006172	J0006175	J0006164	J0006167	J0006170	J0006173	J0006165	J0006168	J0006171	J0006174
	1/2	RH	J0000847	J0000850	J0000853	J0000856	J0000845	J0000848	J0000851	J0000854	J0000846	J0000849	J0000852	J0000855
		LH	J0000775	J0000778	J0000781	J0000784	J0000773	J0000776	J0000779	J0000782	J0000774	J0000777	J0000780	J0000783
	9/16	RH	J0011062	J0011065	J0011068	J0011071	J0011060	J0011063	J0011066	J0011069	J0011061	J0011064	J0011067	J0011070
		LH	J0010990	J0010993	J0010996	J0010999	J0010988	J0010991	J0010994	J0010997	J0010989	J0010992	J0010995	J0010998
	5/8	RH	J0008840	J0008843	J0008846	J0008849	J0008838	J0008841	J0008844	J0008847	J0008839	J0008842	J0008845	J0008848
		LH	J0008768	J0008771	J0008774	J0008777	J0008766	J0008769	J0008772	J0008775	J0008767	J0008770	J0008773	J0008776

fits 1.750 x 0.120		Zinc Clear (Silver) Plated				Black Powder Paint (threads are bare)				Polished Chrome (threads are bare)				
Thread	Bore	1.50" wide	1.75"	2.50"	3.00"	1.50"	1.75"	2.50"	3.00"	1.50"	1.75"	2.50"	3.00"	
3/4-16	3/8	RH	J0006250	J0006253	J0006256	J0006259	J0006248	J0006251	J0006254	J0006257	J0006249	J0006252	J0006255	J0006258
		LH	J0006178	J0006181	J0006184	J0006187	J0006176	J0006179	J0006182	J0006185	J0006177	J0006180	J0006183	J0006186
	1/2	RH	J0000859	J0000862	J0000865	J0000868	J0000857	J0000860	J0000863	J0000866	J0000858	J0000861	J0000864	J0000867
		LH	J0000787	J0000790	J0000793	J0000796	J0000785	J0000788	J0000791	J0000794	J0000786	J0000789	J0000792	J0000795
	9/16	RH	J0011074	J0011077	J0011080	J0011083	J0011072	J0011075	J0011078	J0011081	J0011073	J0011076	J0011079	J0011082
		LH	J0011002	J0011005	J0011008	J0011011	J0011000	J0011003	J0011006	J0011009	J0011001	J0011004	J0011007	J0011010
	5/8	RH	J0008852	J0008855	J0008858	J0008861	J0008850	J0008853	J0008856	J0008859	J0008851	J0008854	J0008857	J0008860
		LH	J0008780	J0008783	J0008786	J0008789	J0008778	J0008781	J0008784	J0008787	J0008779	J0008782	J0008785	J0008788

fits 1.750 x 0.250		Zinc Clear (Silver) Plated				Black Powder Paint (threads are bare)				Polished Chrome (threads are bare)				
Thread	Bore	1.50" wide	1.75"	2.50"	3.00"	1.50"	1.75"	2.50"	3.00"	1.50"	1.75"	2.50"	3.00"	
3/4-16	3/8	RH	J0006262	J0006265	J0006268	J0006271	J0006260	J0006263	J0006266	J0006269	J0006261	J0006264	J0006267	J0006270
		LH	J0006190	J0006193	J0006196	J0006199	J0006188	J0006191	J0006194	J0006197	J0006189	J0006192	J0006195	J0006198
	1/2	RH	J0000871	J0000874	J0000877	J0000880	J0000869	J0000872	J0000875	J0000878	J0000870	J0000873	J0000876	J0000879
		LH	J0000799	J0000802	J0000805	J0000808	J0000797	J0000800	J0000803	J0000806	J0000798	J0000801	J0000804	J0000807
	9/16	RH	J0011086	J0011089	J0011092	J0011095	J0011084	J0011087	J0011090	J0011093	J0011085	J0011088	J0011091	J0011094
		LH	J0011014	J0011017	J0011020	J0011023	J0011012	J0011015	J0011018	J0011021	J0011013	J0011016	J0011019	J0011022
	5/8	RH	J0008864	J0008867	J0008870	J0008873	J0008862	J0008865	J0008868	J0008871	J0008863	J0008866	J0008869	J0008872
		LH	J0008792	J0008795	J0008798	J0008801	J0008790	J0008793	J0008796	J0008799	J0008791	J0008794	J0008797	J0008800

Steinjäger also sells all of the other components and materials needed to build a 1, 2, 3, 4, or 5 link suspension.



Tab Kits



Clevis Kits



Tubes



Rod Ends



## 7/8" Male Poly Bushing Kits



Steinjäger Male Poly Bushings Kits come in a variety of finishes (zinc plated, black powdered, or chrome plated) and feature a **grade 8** threaded male stem. Kits come with 1, 2, 4, 6 or 8 poly ends.

Each kit includes the following

- (1) DOM Steel Housing with grade 8 threaded Stem
- (2) Black Poly Bushings
- (1) Plated Steel DOM Sleeve
- (1) Grease Zerk
- (1) Grease Zerk Cap
- (1) Jam Nut
- (1) Grade 8 Bolt
- (1) Lock Nut & (2) Washers
- (1) Thread Bung

fits 1.750 x 0.120		Zinc Clear (Silver) Plated				Black Powder Paint (threads are bare)				Polished Chrome (threads are bare)				
Thread	Bore	1.50" wide	1.75"	2.50"	3.00"	1.50"	1.75"	2.50"	3.00"	1.50"	1.75"	2.50"	3.00"	
7/8-14	3/8	RH	J0006370	J0006373	J0006376	J0006379	J0006368	J0006371	J0006374	J0006377	J0006369	J0006372	J0006375	J0006378
		LH	J0006346	J0006349	J0006352	J0006355	J0006344	J0006347	J0006350	J0006353	J0006345	J0006348	J0006351	J0006354
	1/2	RH	J0000979	J0000982	J0000985	J0000988	J0000977	J0000980	J0000983	J0000986	J0000978	J0000981	J0000984	J0000987
		LH	J0000955	J0000958	J0000961	J0000964	J0000953	J0000956	J0000959	J0000962	J0000954	J0000957	J0000960	J0000963
	9/16	RH	J0011194	J0011197	J0011200	J0011203	J0011192	J0011195	J0011198	J0011201	J0011193	J0011196	J0011199	J0011202
		LH	J0011170	J0011173	J0011176	J0011179	J0011168	J0011171	J0011174	J0011177	J0011169	J0011172	J0011175	J0011178
	5/8	RH	J0009008	J0009011	J0009014	J0009017	J0009006	J0009009	J0009012	J0009015	J0009007	J0009010	J0009013	J0009016
		LH	J0008984	J0008987	J0008990	J0008993	J0008982	J0008985	J0008988	J0008991	J0008983	J0008986	J0008989	J0008992

fits 1.750 x 0.250		Zinc Clear (Silver) Plated				Black Powder Paint (threads are bare)				Polished Chrome (threads are bare)				
Thread	Bore	1.50" wide	1.75"	2.50"	3.00"	1.50"	1.75"	2.50"	3.00"	1.50"	1.75"	2.50"	3.00"	
7/8-14	3/8	RH	J0006382	J0006385	J0006388	J0006391	J0006380	J0006383	J0006386	J0006389	J0006381	J0006384	J0006387	J0006390
		LH	J0006358	J0006361	J0006364	J0006367	J0006356	J0006359	J0006362	J0006365	J0006357	J0006360	J0006363	J0006366
	1/2	RH	J0000991	J0000994	J0000997	J0001000	J0000989	J0000992	J0000995	J0000998	J0000990	J0000993	J0000996	J0000999
		LH	J0000967	J0000970	J0000973	J0000976	J0000965	J0000968	J0000971	J0000974	J0000966	J0000969	J0000972	J0000975
	9/16	RH	J0011206	J0011209	J0011212	J0011215	J0011204	J0011207	J0011210	J0011213	J0011205	J0011208	J0011211	J0011214
		LH	J0011182	J0011185	J0011188	J0011191	J0011180	J0011183	J0011186	J0011189	J0011181	J0011184	J0011187	J0011190
	5/8	RH	J0009020	J0009023	J0009026	J0009029	J0009018	J0009021	J0009024	J0009027	J0009019	J0009022	J0009025	J0009028
		LH	J0008996	J0008999	J0009002	J0009005	J0008994	J0008997	J0009000	J0009003	J0008995	J0008998	J0009001	J0009004

Hex Bar Tubes



Pages 60-63

Double Adjustable Poly Assys



Pages 24-29

Tab Kits



Pages 40-46

Replacement Poly Kits



refer to our website.

Rod End Kits



Pages 8-11

Male Polys



Pages 14-15

Unibal Kits



Pages 12-13

End Link Kits



Pages 48-59



fits 1.750 x 0.120		Zinc Clear (Silver) Plated				Black Powder Paint (threads are bare)				Polished Chrome (threads are bare)				
Thread	Bore	1.50" wide	1.75"	2.50"	3.00"	1.50"	1.75"	2.50"	3.00"	1.50"	1.75"	2.50"	3.00"	
1"-12	3/8	RH	J0006082	J0006085	J0006088	J0006091	J0006080	J0006083	J0006086	J0006089	J0006081	J0006084	J0006087	J0006090
		LH	J0006058	J0006061	J0006064	J0006067	J0006056	J0006059	J0006062	J0006065	J0006057	J0006060	J0006063	J0006066
	1/2	RH	J0000679	J0000682	J0000685	J0000688	J0000677	J0000680	J0000683	J0000686	J0000678	J0000681	J0000684	J0000687
		LH	J0000655	J0000658	J0000661	J0000664	J0000653	J0000656	J0000659	J0000662	J0000654	J0000657	J0000660	J0000663
	9/16	RH	J0010906	J0010909	J0010912	J0010915	J0010904	J0010907	J0010910	J0010913	J0010905	J0010908	J0010911	J0010914
		LH	J0010882	J0010885	J0010888	J0010891	J0010880	J0010883	J0010886	J0010889	J0010881	J0010884	J0010887	J0010890
	5/8	RH	J0008684	J0008687	J0008690	J0008693	J0008682	J0008685	J0008688	J0008691	J0008683	J0008686	J0008689	J0008692
		LH	J0008660	J0008663	J0008666	J0008669	J0008658	J0008661	J0008664	J0008667	J0008659	J0008662	J0008665	J0008668

fits 1.750 x 0.250		Zinc Clear (Silver) Plated				Black Powder Paint (threads are bare)				Polished Chrome (threads are bare)				
Thread	Bore	1.50" wide	1.75"	2.50"	3.00"	1.50"	1.75"	2.50"	3.00"	1.50"	1.75"	2.50"	3.00"	
1"-12	3/8	RH	J0006094	J0006097	J0006100	J0006103	J0006092	J0006095	J0006098	J0006101	J0006093	J0006096	J0006099	J0006102
		LH	J0006070	J0006073	J0006076	J0006079	J0006068	J0006071	J0006074	J0006077	J0006069	J0006072	J0006075	J0006078
	1/2	RH	J0000691	J0000694	J0000697	J0000700	J0000689	J0000692	J0000695	J0000698	J0000690	J0000693	J0000696	J0000699
		LH	J0000667	J0000670	J0000673	J0000676	J0000665	J0000668	J0000671	J0000674	J0000666	J0000669	J0000672	J0000675
	9/16	RH	J0010918	J0010921	J0010924	J0010927	J0010916	J0010919	J0010922	J0010925	J0010917	J0010920	J0010923	J0010926
		LH	J0010894	J0010897	J0010900	J0010903	J0010892	J0010895	J0010898	J0010901	J0010893	J0010896	J0010899	J0010902
	5/8	RH	J0008696	J0008699	J0008702	J0008705	J0008694	J0008697	J0008700	J0008703	J0008695	J0008698	J0008701	J0008704
		LH	J0008672	J0008675	J0008678	J0008681	J0008670	J0008673	J0008676	J0008679	J0008671	J0008674	J0008677	J0008680

fits 1.750 x 0.120		Zinc Clear (Silver) Plated				Black Powder Paint (threads are bare)				Polished Chrome (threads are bare)				
Thread	Bore	1.50" wide	1.75"	2.50"	3.00"	1.50"	1.75"	2.50"	3.00"	1.50"	1.75"	2.50"	3.00"	
1.25"-12	3/8	RH	J0006034	J0006037	J0006040	J0006043	J0006032	J0006035	J0006038	J0006041	J0006033	J0006036	J0006039	J0006042
		LH	J0006010	J0006013	J0006016	J0006019	J0006008	J0006011	J0006014	J0006017	J0006009	J0006012	J0006015	J0006018
	1/2	RH	J0000631	J0000634	J0000637	J0000640	J0000629	J0000632	J0000635	J0000638	J0000630	J0000633	J0000636	J0000639
		LH	J0000607	J0000610	J0000613	J0000616	J0000605	J0000608	J0000611	J0000614	J0000606	J0000609	J0000612	J0000615
	9/16	RH	J0010858	J0010861	J0010864	J0010867	J0010856	J0010859	J0010862	J0010865	J0010857	J0010860	J0010863	J0010866
		LH	J0010834	J0010837	J0010840	J0010843	J0010832	J0010835	J0010838	J0010841	J0010833	J0010836	J0010839	J0010842
	5/8	RH	J0008636	J0008639	J0008642	J0008645	J0008634	J0008637	J0008640	J0008643	J0008635	J0008638	J0008641	J0008644
		LH	J0008612	J0008615	J0008618	J0008621	J0008610	J0008613	J0008616	J0008619	J0008611	J0008614	J0008617	J0008620

fits 2.000 x 0.250		Zinc Clear (Silver) Plated				Black Powder Paint (threads are bare)				Polished Chrome (threads are bare)				
Thread	Bore	1.50" wide	1.75"	2.50"	3.00"	1.50"	1.75"	2.50"	3.00"	1.50"	1.75"	2.50"	3.00"	
1.25"-12	3/8	RH	J0006046	J0006049	J0006052	J0006055	J0006044	J0006047	J0006050	J0006053	J0006045	J0006048	J0006051	J0006054
		LH	J0006022	J0006025	J0006028	J0006031	J0006020	J0006023	J0006026	J0006029	J0006021	J0006024	J0006027	J0006030
	1/2	RH	J0000643	J0000646	J0000649	J0000652	J0000641	J0000644	J0000647	J0000650	J0000642	J0000645	J0000648	J0000651
		LH	J0000619	J0000622	J0000625	J0000628	J0000617	J0000620	J0000623	J0000626	J0000618	J0000621	J0000624	J0000627
	9/16	RH	J0010870	J0010873	J0010876	J0010879	J0010868	J0010871	J0010874	J0010877	J0010869	J0010872	J0010875	J0010878
		LH	J0010846	J0010849	J0010852	J0010855	J0010844	J0010847	J0010850	J0010853	J0010845	J0010848	J0010851	J0010854
	5/8	RH	J0008648	J0008651	J0008654	J0008657	J0008646	J0008649	J0008652	J0008655	J0008647	J0008650	J0008653	J0008656
		LH	J0008624	J0008627	J0008630	J0008633	J0008622	J0008625	J0008628	J0008631	J0008623	J0008626	J0008629	J0008632

## Female Poly Bushings



Steinjäger Female Poly Bushings come in a variety of finishes (zinc plated or chrome plated) and feature a hex shaped female threaded housing.

- Each kit includes the following:
- (1) DOM Steel Housing with welded hex tube threads
  - (2) Black Polyurethane Bushings
  - (1) Plated Steel DOM Sleeve
  - (1) Grease Zerk with plastic cap

Thread	Bore		Zinc Clear (Silver) Plated				Polished Chrome			
			1.50" wide	1.75" wide	2.50" wide	3.00" wide	1.50" wide	1.75" wide	2.50" wide	3.00" wide
M10 x 1.50	3/8	RH	J0012157	J0012421	J0012685	J0012949	J0012158	J0012422	J0012686	J0012950
		LH	J0012155	J0012419	J0012683	J0012947	J0012156	J0012420	J0012684	J0012948
	1/2	RH	J0012097	J0012361	J0012625	J0012889	J0012098	J0012362	J0012626	J0012890
		LH	J0012095	J0012359	J0012623	J0012887	J0012096	J0012360	J0012624	J0012888
	9/16	RH	J0012277	J0012541	J0012805	J0013069	J0012278	J0012542	J0012806	J0013070
		LH	J0012275	J0012539	J0012803	J0013067	J0012276	J0012540	J0012804	J0013068
	5/8	RH	J0012217	J0012481	J0012745	J0013009	J0012218	J0012482	J0012746	J0013010
		LH	J0012215	J0012479	J0012743	J0013007	J0012216	J0012480	J0012744	J0013008
Thread	Bore		1.50" wide	1.75" wide	2.50" wide	3.00" wide	1.50" wide	1.75" wide	2.50" wide	3.00" wide
M12 x 1.75	3/8	RH	J0012161	J0012425	J0012689	J0012953	J0012162	J0012426	J0012690	J0012954
		LH	J0012159	J0012423	J0012687	J0012951	J0012160	J0012424	J0012688	J0012952
	1/2	RH	J0012101	J0012365	J0012629	J0012893	J0012102	J0012366	J0012630	J0012894
		LH	J0012099	J0012363	J0012627	J0012891	J0012100	J0012364	J0012628	J0012892
	9/16	RH	J0012281	J0012545	J0012809	J0013073	J0012282	J0012546	J0012810	J0013074
		LH	J0012279	J0012543	J0012807	J0013071	J0012280	J0012544	J0012808	J0013072
	5/8	RH	J0012221	J0012485	J0012749	J0013013	J0012222	J0012486	J0012750	J0013014
		LH	J0012219	J0012483	J0012747	J0013011	J0012220	J0012484	J0012748	J0013012
Thread	Bore		1.50" wide	1.75" wide	2.50" wide	3.00" wide	1.50" wide	1.75" wide	2.50" wide	3.00" wide
3/8-24	3/8	RH	J0012150	J0012414	J0012678	J0012942	J0012149	J0012413	J0012677	J0012941
		LH	J0012148	J0012412	J0012676	J0012940	J0012147	J0012411	J0012675	J0012939
	1/2	RH	J0012090	J0012354	J0012618	J0012882	J0012089	J0012353	J0012617	J0012881
		LH	J0012088	J0012352	J0012616	J0012880	J0012087	J0012351	J0012615	J0012879
	9/16	RH	J0012270	J0012534	J0012798	J0013062	J0012269	J0012533	J0012797	J0013061
		LH	J0012268	J0012532	J0012796	J0013060	J0012267	J0012531	J0012795	J0013059
	5/8	RH	J0012210	J0012474	J0012738	J0013002	J0012209	J0012473	J0012737	J0013001
		LH	J0012208	J0012472	J0012736	J0013000	J0012207	J0012471	J0012735	J0012999
Thread	Bore		1.50" wide	1.75" wide	2.50" wide	3.00" wide	1.50" wide	1.75" wide	2.50" wide	3.00" wide
1/2-20	3/8	RH	J0012142	J0012406	J0012670	J0012934	J0012141	J0012405	J0012669	J0012933
		LH	J0012140	J0012404	J0012668	J0012932	J0012139	J0012403	J0012667	J0012931
	1/2	RH	J0012082	J0012346	J0012610	J0012874	J0012081	J0012345	J0012609	J0012873
		LH	J0012080	J0012344	J0012608	J0012872	J0012079	J0012343	J0012607	J0012871
	9/16	RH	J0012262	J0012526	J0012790	J0013054	J0012261	J0012525	J0012789	J0013053
		LH	J0012260	J0012524	J0012788	J0013052	J0012259	J0012523	J0012787	J0013051
	5/8	RH	J0012202	J0012466	J0012730	J0012994	J0012201	J0012465	J0012729	J0012993
		LH	J0012200	J0012464	J0012728	J0012992	J0012199	J0012463	J0012727	J0012991



Thread	Bore	Zinc Clear (Silver) Plated				Polished Chrome				
		1.50" wide	1.75" wide	2.50" wide	3.00" wide	1.50" wide	1.75" wide	2.50" wide	3.00" wide	
5/8-18	3/8	RH	J0012154	J0012418	J0012682	J0012946	J0012153	J0012417	J0012681	J0012945
		LH	J0012152	J0012416	J0012680	J0012944	J0012151	J0012415	J0012679	J0012943
	1/2	RH	J0012094	J0012538	J0012622	J0012886	J0012093	J0012537	J0012621	J0012885
		LH	J0012092	J0012536	J0012620	J0012884	J0012091	J0012535	J0012619	J0012883
	9/16	RH	J0012274	J0012538	J0012802	J0013066	J0012273	J0012537	J0012801	J0013065
		LH	J0012272	J0012536	J0012800	J0013064	J0012271	J0012535	J0012799	J0013063
	5/8	RH	J0012214	J0012478	J0012742	J0013006	J0012213	J0012477	J0012741	J0013005
		LH	J0012212	J0012476	J0012740	J0013004	J0012211	J0012475	J0012739	J0013003
Thread	Bore	1.50" wide	1.75" wide	2.50" wide	3.00" wide	1.50" wide	1.75" wide	2.50" wide	3.00" wide	
3/4-16	3/8	RH	J0012146	J0012410	J0012674	J0012938	J0012145	J0012409	J0012673	J0012937
		LH	J0012144	J0012408	J0012672	J0012936	J0012143	J0012407	J0012671	J0012935
	1/2	RH	J0012086	J0012350	J0012614	J0012878	J0012085	J0012349	J0012613	J0012877
		LH	J0012084	J0012348	J0012612	J0012876	J0012083	J0012347	J0012611	J0012875
	9/16	RH	J0012266	J0012530	J0012794	J0013058	J0012265	J0012529	J0012793	J0013057
		LH	J0012264	J0012528	J0012792	J0013056	J0012263	J0012527	J0012791	J0013055
	5/8	RH	J0012206	J0012470	J0012734	J0012998	J0012205	J0012469	J0012733	J0012997
		LH	J0012204	J0012468	J0012732	J0012996	J0012203	J0012467	J0012731	J0012995



Connect your linkage with a Jack Screw Turnbuckle Kit. Jack screws have a wrench flat and are threaded LH/RH. The kit includes jam nuts.

Threads	Length	Material	Plated	Part#
10-32	1.402"	Steel	Zinc Yellow	J0028418
1/4-28	1.776"	Steel	Zinc Yellow	J0028419
5/16-24	2.309"	Steel	Zinc Yellow	J0028420
3/8-24	2.125"	Steel	Zinc Yellow	J0028422
	2.589"	Steel	Zinc Yellow	J0028421
	2.860"	Steel	Zinc Clear	J0028423
7/16-20	2.870"	Steel	Zinc Yellow	J0028424
1/2-20	2.938"	Steel	Zinc Yellow	J0028426
	3.433"	Steel	Zinc Yellow	J0028425
5/8-18	3.745"	Steel	Zinc Yellow	J0028416

Threads	Length	Material	Plated	Part#
5/8-18	4.075"	4130 Moly	Chrome	J0028433
3/4-16	4.042"	Steel	Zinc Yellow	J0028417
	4.638"	4130 Moly	Chrome	J0028434
	8.638"	4130 Moly	Chrome	J0028435
M6 x 1.00	45 mm	Steel	Zinc Yellow	J0028430
M8 x 1.25	57 mm	Steel	Zinc Yellow	J0028431
	57 mm	Steel	Zinc Clear	J0028432
M10 x 1.50	69 mm	Steel	Zinc Yellow	J0028427
M12 x 1.75	83 mm	Steel	Zinc Yellow	J0028428
M16 x 2.00	109 mm	Steel	Zinc Yellow	J0028429



Steinjäger Linkage Rods are made from 1018 steel, are plated zinc yellow, and are threaded LH/RH. The kit includes jam nuts.

The first column shows length.

Hundreds of other thread sizes, materials, finishes, and lengths are available - please refer to our website.

3/8-24 LH/RH Threads	
3.00"	J0028611
3.75"	J0028612
4.50"	J0028613
5.25"	J0028614
6.00"	J0028615
7.50"	J0028617
9.00"	J0028619
10.50"	J0028621
12.00"	J0028623
15.00"	J0028626
18.00"	J0028630
21.00"	J0028634
27.00"	J0028639
33.00"	J0028645

1/2-20 LH/RH Threads	
4.00"	J0028650
5.00"	J0028651
6.00"	J0028652
7.00"	J0028653
8.00"	J0028654
9.00"	J0028655
10.00"	J0028656
12.00"	J0028658
15.00"	J0028661
18.00"	J0028664
21.00"	J0028667
24.00"	J0028670
30.00"	J0028676
36.00"	J0028682

M10 x 1.50 LH/RH Thds	
80mm	J0028683
90mm	J0028684
100mm	J0028685
110mm	J0028686
120mm	J0028687
130mm	J0028688
140mm	J0028689
150mm	J0028690
180mm	J0028691
190mm	J0028692
210mm	J0028693
220mm	J0028694
230mm	J0028695
240mm	J0028696

M12 x 1.75 LH/RH Thds	
100mm	J0028703
110mm	J0028704
130mm	J0028705
150mm	J0028706
160mm	J0028707
200mm	J0028708
210mm	J0028709
220mm	J0028710
230mm	J0028711
240mm	J0028712
250mm	J0028713
260mm	J0028714
280mm	J0028715
450mm	J0028716

## Double Adjustable Links

Steinjäger double adjustable poly links are suitable for control arms and other motorsport applications. Parts shown below are silver powder coated. Other finishes are available (polished chrome, black) - see our full listing online. These links feature grade 8 male studs and your choice of steel or aluminum hex connecting tubes.

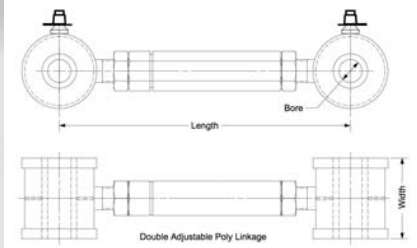

1/2-20 Threads		1.50" Wide			
Length	Material	3/8 Bore	1/2 Bore	9/16 Bore	5/8 Bore
7.56"	Alum	J0020691	J0020692	J0020693	J0020694
	Steel	J0020771	J0020772	J0020773	J0020774
8.06"	Steel	J0020775	J0020776	J0020777	J0020778
8.56"	Alum	J0020695	J0020696	J0020697	J0020698
	Steel	J0020779	J0020780	J0020781	J0020782
9.56"	Alum	J0020699	J0020700	J0020701	J0020702
	Steel	J0020783	J0020784	J0020785	J0020786
10.56"	Alum	J0020703	J0020704	J0020705	J0020706
	Steel	J0020787	J0020788	J0020789	J0020790
11.56"	Alum	J0020707	J0020708	J0020709	J0020710
	Steel	J0020791	J0020792	J0020793	J0020794
12.56"	Alum	J0020711	J0020712	J0020713	J0020714
	Steel	J0020795	J0020796	J0020797	J0020798
13.56"	Alum	J0020715	J0020716	J0020717	J0020718
	Steel	J0020799	J0020800	J0020801	J0020802
14.56"	Alum	J0020719	J0020720	J0020721	J0020722
	Steel	J0020803	J0020804	J0020805	J0020806
15.56"	Alum	J0020723	J0020724	J0020725	J0020726
	Steel	J0020807	J0020808	J0020809	J0020810
16.56"	Alum	J0020727	J0020728	J0020729	J0020730
	Steel	J0020811	J0020812	J0020813	J0020814
17.56"	Alum	J0020731	J0020732	J0020733	J0020734
	Steel	J0020815	J0020816	J0020817	J0020818
18.56"	Alum	J0020735	J0020736	J0020737	J0020738
	Steel	J0020819	J0020820	J0020821	J0020822
19.56"	Alum	J0020739	J0020740	J0020741	J0020742
	Steel	J0020823	J0020824	J0020825	J0020826
20.56"	Alum	J0020743	J0020744	J0020745	J0020746
	Steel	J0020827	J0020828	J0020829	J0020830
21.56"	Alum	J0020747	J0020748	J0020749	J0020750
	Steel	J0020831	J0020832	J0020833	J0020834
22.56"	Alum	J0020751	J0020752	J0020753	J0020754
	Steel	J0020835	J0020836	J0020837	J0020838
23.56"	Alum	J0020755	J0020756	J0020757	J0020758
	Steel	J0020839	J0020840	J0020841	J0020842
24.56"	Alum	J0020759	J0020760	J0020761	J0020762
	Steel	J0020843	J0020844	J0020845	J0020846
25.56"	Alum	J0020763	J0020764	J0020765	J0020766
	Steel	J0020847	J0020848	J0020849	J0020850
26.56"	Alum	J0020767	J0020768	J0020769	J0020770
	Steel	J0020851	J0020852	J0020853	J0020854

1/2-20 Threads (cont)		1.75" Wide			
Length	Material	3/8 Bore	1/2 Bore	9/16 Bore	5/8 Bore
7.81"	Alum	J0020863	J0020864	J0020865	J0020866
	Steel	J0020943	J0020944	J0020945	J0020946
8.31"	Steel	J0020947	J0020948	J0020949	J0020950
8.81"	Alum	J0020867	J0020868	J0020869	J0020870
	Steel	J0020951	J0020952	J0020953	J0020954
9.81"	Alum	J0020871	J0020872	J0020873	J0020874
	Steel	J0020955	J0020956	J0020957	J0020958
10.81"	Alum	J0020875	J0020876	J0020877	J0020878
	Steel	J0020959	J0020960	J0020961	J0020962
11.81"	Alum	J0020879	J0020880	J0020881	J0020882
	Steel	J0020963	J0020964	J0020965	J0020966
12.81"	Alum	J0020883	J0020884	J0020885	J0020886
	Steel	J0020967	J0020968	J0020969	J0020970
13.81"	Alum	J0020887	J0020888	J0020889	J0020890
	Steel	J0020971	J0020972	J0020973	J0020974
14.81"	Alum	J0020891	J0020892	J0020893	J0020894
	Steel	J0020975	J0020976	J0020977	J0020978
15.81"	Alum	J0020895	J0020896	J0020897	J0020898
	Steel	J0020979	J0020980	J0020981	J0020982
16.81"	Alum	J0020899	J0020900	J0020901	J0020902
	Steel	J0020983	J0020984	J0020985	J0020986
17.81"	Alum	J0020903	J0020904	J0020905	J0020906
	Steel	J0020987	J0020988	J0020989	J0020990
18.81"	Alum	J0020907	J0020908	J0020909	J0020910
	Steel	J0020991	J0020992	J0020993	J0020994
19.81"	Alum	J0020911	J0020912	J0020913	J0020914
	Steel	J0020995	J0020996	J0020997	J0020998
20.81"	Alum	J0020915	J0020916	J0020917	J0020918
	Steel	J0020999	J0021000	J0021001	J0021002
21.81"	Alum	J0020919	J0020920	J0020921	J0020922
	Steel	J0021003	J0021004	J0021005	J0021006
22.81"	Alum	J0020923	J0020924	J0020925	J0020926
	Steel	J0021007	J0021008	J0021009	J0021010
23.81"	Alum	J0020927	J0020928	J0020929	J0020930
	Steel	J0021011	J0021012	J0021013	J0021014
24.81"	Alum	J0020931	J0020932	J0020933	J0020934
	Steel	J0021015	J0021016	J0021017	J0021018
25.81"	Alum	J0020935	J0020936	J0020937	J0020938
	Steel	J0021019	J0021020	J0021021	J0021022
26.81"	Alum	J0020939	J0020940	J0020941	J0020942
	Steel	J0021023	J0021024	J0021025	J0021026

1/2-20 Threads		2.50" Wide			
Length	Material	3/8 Bore	1/2 Bore	9/16 Bore	5/8 Bore
8.06"	Alum	J0021035	J0021036	J0021037	J0021038
	Steel	J0021115	J0021116	J0021117	J0021118
8.56"	Alum	-	-	-	-
	Steel	J0021119	J0021120	J0021121	J0021122
9.06"	Alum	J0021039	J0021040	J0021041	J0021042
	Steel	J0021123	J0021124	J0021125	J0021126
10.06"	Alum	J0021043	J0021044	J0021045	J0021046
	Steel	J0021127	J0021128	J0021129	J0021130
11.06"	Alum	J0021047	J0021048	J0021049	J0021050
	Steel	J0021131	J0021132	J0021133	J0021134
12.06"	Alum	J0021051	J0021052	J0021053	J0021054
	Steel	J0021135	J0021136	J0021137	J0021138
13.06"	Alum	J0021055	J0021056	J0021057	J0021058
	Steel	J0021139	J0021140	J0021141	J0021142
14.06"	Alum	J0021059	J0021060	J0021061	J0021062
	Steel	J0021143	J0021144	J0021145	J0021146
15.06"	Alum	J0021063	J0021064	J0021065	J0021066
	Steel	J0021147	J0021148	J0021149	J0021150
16.06"	Alum	J0021067	J0021068	J0021069	J0021070
	Steel	J0021151	J0021152	J0021153	J0021154
17.06"	Alum	J0021071	J0021072	J0021073	J0021074
	Steel	J0021155	J0021156	J0021157	J0021158
18.06"	Alum	J0021075	J0021076	J0021077	J0021078
	Steel	J0021159	J0021160	J0021161	J0021162
19.06"	Alum	J0021079	J0021080	J0021081	J0021082
	Steel	J0021163	J0021164	J0021165	J0021166
20.06"	Alum	J0021083	J0021084	J0021085	J0021086
	Steel	J0021167	J0021168	J0021169	J0021170
21.06"	Alum	J0021087	J0021088	J0021089	J0021090
	Steel	J0021171	J0021172	J0021173	J0021174
22.06"	Alum	J0021091	J0021092	J0021093	J0021094
	Steel	J0021175	J0021176	J0021177	J0021178
23.06"	Alum	J0021095	J0021096	J0021097	J0021098
	Steel	J0021179	J0021180	J0021181	J0021182
24.06"	Alum	J0021099	J0021100	J0021101	J0021102
	Steel	J0021183	J00211784	J0021185	J0021186
25.06"	Alum	J0021103	J0021104	J0021105	J0021106
	Steel	J0021187	J0021188	J0021189	J0021190
26.06"	Alum	J0021107	J0021108	J0021109	J0021110
	Steel	J0021191	J0021192	J0021193	J0021194
27.06"	Alum	J0021111	J0021112	J0021113	J0021114
	Steel	J0021195	J0021196	J0021197	J0021198
28.06"	Alum	-	-	-	-
	Steel	J0021199	J0021200	J0021201	J0021202
29.06"	Alum	-	-	-	-
	Steel	J0021203	J0021204	J0021205	J0021206

1/2-20 Threads (cont)		3.00" Wide			
Length	Material	3/8 Bore	1/2 Bore	9/16 Bore	5/8 Bore
8.06"	Alum	J0021207	J0021208	J0021209	J0021210
	Steel	J0021287	J0021288	J0021289	J0021290
8.56"	Alum	-	-	-	-
	Steel	J0021291	J0021292	J0021293	J0021294
9.06"	Alum	J0021211	J0021212	J0021213	J0021214
	Steel	J0021295	J0021296	J0021297	J0021298
10.06"	Alum	J0021215	J0021216	J0021217	J0021218
	Steel	J0021299	J0021300	J0021301	J0021302
11.06"	Alum	J0021219	J0021220	J0021221	J0021222
	Steel	J0021303	J0021304	J0021305	J0021306
12.06"	Alum	J0021223	J0021224	J0021225	J0021226
	Steel	J0021307	J0021308	J0021309	J0021310
13.06"	Alum	J0021227	J0021228	J0021229	J0021230
	Steel	J0021311	J0021312	J0021313	J0021314
14.06"	Alum	J0021231	J0021232	J0021233	J0021234
	Steel	J0021315	J0021316	J0021317	J0021318
15.06"	Alum	J0021235	J0021236	J0021237	J0021238
	Steel	J0021319	J0021320	J0021321	J0021322
16.06"	Alum	J0021239	J0021240	J0021241	J0021242
	Steel	J0021323	J0021324	J0021325	J0021326
17.06"	Alum	J0021243	J0021244	J0021245	J0021246
	Steel	J0021327	J0021328	J0021329	J0021330
18.06"	Alum	J0021247	J0021248	J0021249	J0021250
	Steel	J0021331	J0021332	J0021333	J0021334
19.06"	Alum	J0021251	J0021252	J0021253	J0021254
	Steel	J0021335	J0021336	J0021337	J0021338
20.06"	Alum	J0021255	J0021256	J0021257	J0021258
	Steel	J0021339	J0021340	J0021341	J0021342
21.06"	Alum	J0021259	J0021260	J0021261	J0021262
	Steel	J0021343	J0021344	J0021345	J0021346
22.06"	Alum	J0021263	J0021264	J0021265	J0021266
	Steel	J0021347	J0021348	J0021349	J0021350
23.06"	Alum	J0021267	J0021268	J0021269	J0021270
	Steel	J0021351	J0021352	J0021353	J0021354
24.06"	Alum	J0021271	J0021272	J0021273	J0021274
	Steel	J0021355	J0021356	J0021357	J0021358
25.06"	Alum	J0021275	J0021276	J0021277	J0021278
	Steel	J0021359	J0021360	J0021361	J0021362
26.06"	Alum	J0021279	J0021280	J0021281	J0021282
	Steel	J0021363	J0021364	J0021365	J0021366
27.06"	Alum	J0021283	J0021284	J0021285	J0021286
	Steel	J0021367	J0021368	J0021369	J0021370
28.06"	Alum	-	-	-	-
	Steel	J0021371	J0021372	J0021373	J0021374
29.06"	Alum	-	-	-	-
	Steel	J0021375	J0021376	J0021377	J0021378



## Double Adjustable Links

Steinjäger double adjustable poly links are suitable for control arms and other motorsport applications. Parts shown below are silver powder coated. Other finishes are available (polished chrome, black) - see our full listing online. These links feature grade 8 male studs and your choice of steel or aluminum hex connecting tubes.

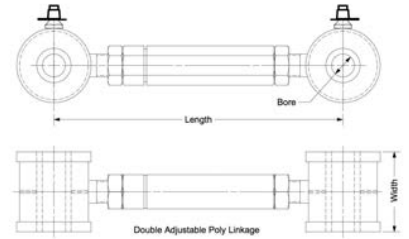

5/8-18 Threads		1.50" Wide			
Length	Material	3/8 Bore	1/2 Bore	9/16 Bore	5/8 Bore
8.56"	Steel	J0022239	J0022240	J0022241	J0022242
9.56"	Alum	J0022179	J0022180	J0022181	J0022182
	Steel	J0022243	J0022244	J0022245	J0022246
10.56"	Alum	J0022183	J0022184	J0022185	J0022186
	Steel	J0022247	J0022248	J0022249	J0022250
11.56"	Alum	J0022187	J0022188	J0022189	J0022190
	Steel	J0022251	J0022252	J0022253	J0022254
12.56"	Alum	-	-	-	-
	Steel	J0022255	J0022256	J0022257	J0022258
13.56"	Alum	J0022191	J0022192	J0022193	J0022194
	Steel	J0022259	J0022260	J0022261	J0022262
15.56"	Alum	J0022195	J0022196	J0022197	J0022198
	Steel	J0022263	J0022264	J0022265	J0022266
16.56"	Alum	J0022199	J0022200	J0022201	J0022202
	Steel	-	-	-	-
17.56"	Alum	J0022203	J0022204	J0022205	J0022206
	Steel	J0022267	J0022268	J0022269	J0022270
18.56"	Alum	J0022207	J0022208	J0022209	J0022210
	Steel	-	-	-	-
19.56"	Alum	J0022211	J0022212	J0022213	J0022214
	Steel	-	-	-	-
20.56"	Alum	J0022215	J0022216	J0022217	J0022218
	Steel	J0022271	J0022272	J0022273	J0022274
21.56"	Alum	J0022219	J0022220	J0022221	J0022222
	Steel	-	-	-	-
22.56"	Alum	J0022223	J0022224	J0022225	J0022226
	Steel	J0022275	J0022276	J0022277	J0022278
23.56"	Alum	J0022227	J0022228	J0022229	J0022230
	Steel	-	-	-	-
24.56"	Alum	J0022231	J0022232	J0022233	J0022234
	Steel	-	-	-	-
25.56"	Alum	J0022235	J0022236	J0022237	J0022238
	Steel	-	-	-	-

5/8-18 Threads (cont)		1.75" Wide			
Length	Material	3/8 Bore	1/2 Bore	9/16 Bore	5/8 Bore
8.81"	Steel	J0022339	J0022340	J0022341	J0022342
9.81"	Alum	J0022279	J0022280	J0022281	J0022282
	Steel	J0022343	J0022344	J0022345	J0022346
10.81"	Alum	J0022283	J0022284	J0022285	J0022286
	Steel	J0022347	J0022348	J0022349	J0022350
11.81"	Alum	J0022287	J0022288	J0022289	J0022290
	Steel	J0022351	J0022352	J0022353	J0022354
12.81"	Alum	-	-	-	-
	Steel	J0022355	J0022356	J0022357	J0022358
13.81"	Alum	J0022291	J0022292	J0022293	J0022294
	Steel	J0022359	J0022360	J0022361	J0022362
15.81"	Alum	J0022295	J0022296	J0022297	J0022298
	Steel	J0022363	J0022364	J0022365	J0022366
16.81"	Alum	J0022299	J0022300	J0022301	J0022302
	Steel	-	-	-	-
17.81"	Alum	J0022303	J0022304	J0022305	J0022306
	Steel	J0022367	J0022368	J0022369	J0022370
18.81"	Alum	J0022307	J0022308	J0022309	J0022310
	Steel	-	-	-	-
19.81"	Alum	J0022311	J0022312	J0022313	J0022314
	Steel	-	-	-	-
20.81"	Alum	J0022315	J0022316	J0022317	J0022318
	Steel	J0022371	J0022372	J0022373	J0022374
21.81"	Alum	J0022319	J0022320	J0022321	J0022322
	Steel	-	-	-	-
22.81"	Alum	J0022323	J0022324	J0022325	J0022326
	Steel	J0022375	J0022376	J0022377	J0022378
23.81"	Alum	J0022327	J0022328	J0022329	J0022339
	Steel	-	-	-	-
24.81"	Alum	J0022331	J0022332	J0022333	J0022334
	Steel	-	-	-	-
25.81"	Alum	J0022335	J0022336	J0022337	J0022338
	Steel	-	-	-	-

### Hex Bar Tubes



Pages 60-63

### Male Polys



Pages 14-15

### Tab Kits



Pages 40-46

### Replacement Poly Kits



refer to our website.

5/8-18 Threads		2.50" Wide			
Length	Material	3/8 Bore	1/2 Bore	9/16 Bore	5/8 Bore
9.06"	Alum	-	-	-	-
	Steel	J0022440	J0022441	J0022442	J0022443
10.06"	Alum	J0022379	J0022380	J0022381	J0022382
	Steel	J0022443	J0022444	J0022445	J0022446
11.06"	Alum	J0022383	J0022384	J0022385	J0022386
	Steel	J0022447	J0022448	J0022449	J0022450
12.06"	Alum	J0022387	J0022388	J0022389	J0022390
	Steel	J0022451	J0022452	J0022453	J0022454
13.06"	Alum	-	-	-	-
	Steel	J0022455	J0022456	J0022457	J0022458
14.06"	Alum	J0022391	J0022392	J0022393	J0022394
	Steel	J0022459	J0022460	J0022461	J0022462
16.06"	Alum	J0022395	J0022396	J0022397	J0022398
	Steel	J0022463	J0022464	J0022465	J0022466
17.06"	Alum	J0022399	J0022400	J0022401	J0022402
	Steel	-	-	-	-
18.06"	Alum	J0022403	J0022404	J0022405	J0022406
	Steel	J0022467	J0022468	J0022469	J0022470
19.06"	Alum	J0022407	J0022408	J0022409	J0022410
	Steel	-	-	-	-
20.06"	Alum	J0022411	J0022412	J0022413	J0022414
	Steel	-	-	-	-
21.06"	Alum	J0022415	J0022416	J0022417	J0022418
	Steel	J0022471	J0022472	J0022473	J0022474
22.06"	Alum	J0022419	J0022420	J0022421	J0022422
	Steel	-	-	-	-
23.06"	Alum	J0022423	J0022424	J0022425	J0022426
	Steel	J0022475	J0022476	J0022477	J0022478
24.06"	Alum	J0022427	J0022428	J0022429	J0022439
	Steel	-	-	-	-
25.06"	Alum	J0022431	J0022432	J0022433	J0022434
	Steel	-	-	-	-
26.06"	Alum	J0022435	J0022436	J0022437	J0022438
	Steel	-	-	-	-

5/8-18 Threads (cont)		3.00" Wide			
Length	Material	3/8 Bore	1/2 Bore	9/16 Bore	5/8 Bore
9.06"	Alum	-	-	-	-
	Steel	J0022539	J0022540	J0022541	J0022542
10.06"	Alum	J0022479	J0022480	J0022481	J0022482
	Steel	J0022543	J0022544	J0022545	J0022546
11.06"	Alum	J0022483	J0022484	J0022485	J0022486
	Steel	J0022547	J0022548	J0022549	J0022550
12.06"	Alum	J0022487	J0022488	J0022489	J0022490
	Steel	J0022551	J0022552	J0022553	J0022554
13.06"	Alum	-	-	-	-
	Steel	J0022555	J0022556	J0022557	J0022558
14.06"	Alum	J0022491	J0022492	J0022493	J0022494
	Steel	J0022559	J0022560	J0022561	J0022562
16.06"	Alum	J0022495	J0022496	J0022497	J0022498
	Steel	J0022563	J0022564	J0022565	J0022566
17.06"	Alum	J0022499	J0022500	J0022501	J0022502
	Steel	-	-	-	-
18.06"	Alum	J0022503	J0022504	J0022505	J0022506
	Steel	J0022567	J0022568	J0022569	J0022570
19.06"	Alum	J0022507	J0022508	J0022509	J0022510
	Steel	-	-	-	-
20.06"	Alum	J0022511	J0022512	J0022513	J0022514
	Steel	-	-	-	-
21.06"	Alum	J0022515	J0022516	J0022517	J0022518
	Steel	J0022571	J0022572	J0022573	J0022574
22.06"	Alum	J0022519	J0022520	J0022521	J0022522
	Steel	-	-	-	-
23.06"	Alum	J0022523	J0022524	J0022525	J0022526
	Steel	J0022575	J0022576	J0022577	J0022578
24.06"	Alum	J0022527	J0022528	J0022529	J0022530
	Steel	-	-	-	-
25.06"	Alum	J0022531	J0022532	J0022533	J0022534
	Steel	-	-	-	-
26.06"	Alum	J0022535	J0022536	J0022537	J0022538
	Steel	-	-	-	-

**Rod End Kits**



Pages 8-11

**Cut Tubes**



Pages 32-33

**Contract Manufacturing**



Contact Us

**Sway Bar End Links**



Pages 48-52

**Unibal Kits**



Pages 12-13

**Private Labeling**



Contact Us

**End Link Kits**



Pages 48-59

**Bulk Unibals**



Page 12

## Double Adjustable Links

Steinjäger double adjustable poly links are suitable for control arms and other motorsport applications. Parts shown below are silver powder coated. Other finishes are available (polished chrome, black) - see our full listing online. These links feature grade 8 male studs and your choice of steel or aluminum hex connecting tubes.

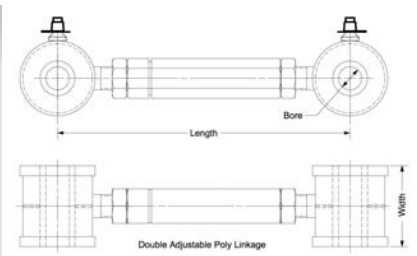

3/4-16 Threads		1.50" Wide			
Length	Material	3/8 Bore	1/2 Bore	9/16 Bore	5/8 Bore
8.54"	Alum	J0023507	J0023508	J0023509	J0023510
	Steel	J0023599	J0023600	J0023601	J0023602
9.54"	Alum	J0023511	J0023512	J0023513	J0023514
	Steel	J0023603	J0023604	J0023605	J0023606
10.54"	Alum	J0023515	J0023516	J0023517	J0023518
	Steel	J0023607	J0023608	J0023609	J0023610
11.54"	Alum	J0023519	J0023520	J0023521	J0023522
	Steel	J0023611	J0023612	J0023613	J0023614
12.54"	Alum	J0023523	J0023524	J0023525	J0023526
13.54"	Alum	J0023527	J0023528	J0023529	J0023530
	Steel	J0023615	J0023616	J0023617	J0023618
14.54"	Alum	J0023531	J0023532	J0023533	J0023534
	Steel	-	-	-	-
15.54"	Alum	J0023535	J0023536	J0023537	J0023538
	Steel	-	-	-	-
16.54"	Alum	J0023539	J0023540	J0023541	J0023542
	Steel	-	-	-	-
17.54"	Alum	J0023543	J0023544	J0023545	J0023546
	Steel	J0023619	J0023620	J0023621	J0023622
18.54"	Alum	J0023547	J0023548	J0023549	J0023550
	Steel	-	-	-	-
19.54"	Alum	J0023551	J0023552	J0023553	J0023554
	Steel	-	-	-	-
20.54"	Alum	J0023555	J0023556	J0023557	J0023558
	Steel	-	-	-	-
21.54"	Alum	J0023559	J0023560	J0023561	J0023562
	Steel	-	-	-	-
22.54"	Alum	J0023563	J0023564	J0023565	J0023566
	Steel	-	-	-	-
23.54"	Alum	J0023567	J0023568	J0023569	J0023570
	Steel	-	-	-	-
24.54"	Alum	J0023571	J0023572	J0023573	J0023574
	Steel	-	-	-	-
25.54"	Alum	J0023575	J0023576	J0023577	J0023578
	Steel	-	-	-	-
26.54"	Alum	J0023579	J0023580	J0023581	J0023582
	Steel	-	-	-	-
27.54"	Alum	J0023583	J0023584	J0023585	J0023586
	Steel	-	-	-	-
28.54"	Alum	J0023587	J0023588	J0023589	J0023590
	Steel	-	-	-	-





3/4-16 Threads (cont)		1.75" Wide			
Length	Material	3/8 Bore	1/2 Bore	9/16 Bore	5/8 Bore
8.79"	Alum	J0023623	J0023624	J0023625	J0023626
	Steel	J0023715	J0023716	J0023717	J0023718
9.79"	Alum	J0023627	J0023628	J0023629	J0023630
	Steel	J0023719	J0023720	J0023721	J0023722
10.79"	Alum	J0023631	J0023632	J0023633	J0023634
	Steel	J0023723	J0023724	J0023725	J0023726
11.79"	Alum	J0023635	J0023636	J0023637	J0023638
	Steel	J0023727	J0023728	J0023729	J0023730
12.79"	Alum	J0023639	J0023640	J0023641	J0023642
13.79"	Alum	J0023643	J0023644	J0023645	J0023646
	Steel	J0023731	J0023732	J0023733	J0023734
14.79"	Alum	J0023647	J0023648	J0023649	J0023650
	Steel	-	-	-	-
15.79"	Alum	J0023651	J0023652	J0023653	J0023654
	Steel	-	-	-	-
16.79"	Alum	J0023655	J0023656	J0023657	J0023658
	Steel	-	-	-	-
17.79"	Alum	J0023659	J0023660	J0023661	J0023662
	Steel	J0023735	J0023736	J0023737	J0023738
18.79"	Alum	J0023663	J0023664	J0023665	J0023666
	Steel	-	-	-	-
19.79"	Alum	J0023667	J0023668	J0023669	J0023670
	Steel	-	-	-	-
20.79"	Alum	J0023671	J0023672	J0023673	J0023674
	Steel	-	-	-	-
21.79"	Alum	J0023675	J0023676	J0023677	J0023678
	Steel	-	-	-	-
22.79"	Alum	J0023679	J0023680	J0023681	J0023682
	Steel	-	-	-	-
23.79"	Alum	J0023683	J0023684	J0023685	J0023686
	Steel	-	-	-	-
24.79"	Alum	J0023687	J0023688	J0023689	J0023690
	Steel	-	-	-	-
25.79"	Alum	J0023691	J0023692	J0023693	J0023694
	Steel	-	-	-	-
26.79"	Alum	J0023695	J0023696	J0023697	J0023698
	Steel	-	-	-	-
27.79"	Alum	J0023699	J0023700	J0023701	J0023702
	Steel	-	-	-	-
28.79"	Alum	J0023703	J0023704	J0023705	J0023706
	Steel	-	-	-	-

3/4-16 Threads		2.50" Wide			
Length	Material	3/8 Bore	1/2 Bore	9/16 Bore	5/8 Bore
9.04"	Alum	J0023739	J0023740	J0023741	J0023742
	Steel	J0023831	J0023832	J0023833	J0023834
10.04"	Alum	J0023743	J0023744	J0023745	J0023746
	Steel	J0023835	J0023836	J0023837	J0023838
11.04"	Alum	J0023747	J0023748	J0023749	J0023750
	Steel	J0023839	J0023840	J0023841	J0023842
12.04"	Alum	J0023751	J0023752	J0023753	J0023754
	Steel	J0023843	J0023844	J0023845	J0023846
13.04"	Alum	J0023755	J0023756	J0023757	J0023758
	Steel	-	-	-	-
14.04"	Alum	J0023759	J0023760	J0023761	J0023762
	Steel	J0023847	J0023848	J0023849	J0023850
15.04"	Alum	J0023763	J0023764	J0023765	J0023766
	Steel	-	-	-	-
16.04"	Alum	J0023767	J0023768	J0023769	J0023770
	Steel	-	-	-	-
17.04"	Alum	J0023771	J0023772	J0023773	J0023774
	Steel	-	-	-	-
18.04"	Alum	J0023775	J0023776	J0023777	J0023778
	Steel	J0023851	J0023852	J0023853	J0023854
19.04"	Alum	J0023779	J0023780	J0023781	J0023782
	Steel	-	-	-	-
20.04"	Alum	J0023783	J0023784	J0023785	J0023786
	Steel	-	-	-	-
21.04"	Alum	J0023787	J0023788	J0023789	J0023790
	Steel	-	-	-	-
22.04"	Alum	J0023791	J0023792	J0023793	J0023794
	Steel	-	-	-	-
23.04"	Alum	J0023795	J0023796	J0023797	J0023798
	Steel	-	-	-	-
24.04"	Alum	J0023799	J0023800	J0023801	J0023802
	Steel	-	-	-	-
25.04"	Alum	J0023803	J0023804	J0023805	J0023806
	Steel	-	-	-	-
26.04"	Alum	J0023807	J0023808	J0023809	J0023810
	Steel	-	-	-	-
27.04"	Alum	J0023811	J0023812	J0023813	J0023814
	Steel	-	-	-	-
28.04"	Alum	J0023815	J0023816	J0023817	J0023818
	Steel	-	-	-	-
29.04"	Alum	J0023819	J0023820	J0023821	J0023822
	Steel	-	-	-	-
30.04"	Alum	J0023823	J0023824	J0023825	J0023826
	Steel	-	-	-	-
31.04"	Alum	J0023827	J0023828	J0023829	J0023830
	Steel	-	-	-	-

3/4-16 Threads (cont)		3.00" Wide			
Length	Material	3/8 Bore	1/2 Bore	9/16 Bore	5/8 Bore
9.04"	Alum	J0023855	J0023856	J0023857	J0023858
	Steel	J0023947	J0023948	J0023949	J0023950
10.04"	Alum	J0023859	J0023860	J0023861	J0023862
	Steel	J0023951	J0023952	J0023953	J0023954
11.04"	Alum	J0023863	J0023864	J0023865	J0023866
	Steel	J0023955	J0023956	J0023957	J0023958
12.04"	Alum	J0023867	J0023868	J0023869	J0023870
	Steel	J0023959	J0023960	J0023961	J0023962
13.04"	Alum	J0023871	J0023872	J0023873	J0023874
	Steel	-	-	-	-
14.04"	Alum	J0023875	J0023876	J0023877	J0023878
	Steel	J0023963	J0023964	J0023965	J0023966
15.04"	Alum	J0023879	J0023880	J0023881	J0023882
	Steel	-	-	-	-
16.04"	Alum	J0023883	J0023884	J0023885	J0023886
	Steel	-	-	-	-
17.04"	Alum	J0023887	J0023888	J0023889	J0023890
	Steel	-	-	-	-
18.04"	Alum	J0023891	J0023892	J0023893	J0023894
	Steel	J0023967	J0023968	J0023969	J0023970
19.04"	Alum	J0023895	J0023896	J0023897	J0023898
	Steel	-	-	-	-
20.04"	Alum	J0023899	J0023900	J0023901	J0023902
	Steel	-	-	-	-
21.04"	Alum	J0023903	J0023904	J0023905	J0023906
	Steel	-	-	-	-
22.04"	Alum	J0023907	J0023908	J0023909	J0023910
	Steel	-	-	-	-
23.04"	Alum	J0023911	J0023912	J0023913	J0023914
	Steel	-	-	-	-
24.04"	Alum	J0023915	J0023916	J0023917	J0023918
	Steel	-	-	-	-
25.04"	Alum	J0023919	J0023920	J0023921	J0023922
	Steel	-	-	-	-
26.04"	Alum	J0023923	J0023924	J0023925	J0023926
	Steel	-	-	-	-
27.04"	Alum	J0023927	J0023928	J0023929	J0023930
	Steel	-	-	-	-
28.04"	Alum	J0023931	J0023932	J0023933	J0023934
	Steel	-	-	-	-
29.04"	Alum	J0023935	J0023936	J0023937	J0023938
	Steel	-	-	-	-
30.04"	Alum	J0023939	J0023940	J0023941	J0023942
	Steel	-	-	-	-
31.04"	Alum	J0023943	J0023944	J0023945	J0023946
	Steel	-	-	-	-

Bushings Kits		Red Polyurethane Bushings: Nominal Width				Black Polyurethane Bushings: Nominal Width			
	Bore Size	1.50"	1.75"	2.50"	3.00"	1.50"	1.75"	2.50"	3.00"
	3/8 bore	J0012329	J0012593	J0012857	J0013121	J0012330	J0012594	J0012858	J0013122
	1/2 bore	J0012323	J0012587	J0012851	J0013115	J0012324	J0012588	J0012852	J0013116
	9/16 bore	J0012341	J0012605	J0012869	J0013133	J0012342	J0012606	J0012870	J0013134
	5/8 bore	J0012335	J0012599	J0012863	J0013127	J0012336	J0012600	J0012864	J0013128

Kit includes (1) DOM tubular housing, (1) DOM plated steel insert, (1) grease zerk, (1) grease zerk cap, (2) polyurethane flanged bushings

	<b>Notched Tubes</b> - Steinjäger notched tubes come in a variety of lengths and diameters. Custom sizes and arrangements are available as well. Notched on <b>ONE END</b> only.	Also Available (see website) ->			
--	--	---------------------------------	---	---	---

Notched Tube Size	DOM TUBING (Length is notch bottom to tube end)			4130 CHROME MOLY (Length is notch bottom to tube end)		
	1.50" Ø Notch	1.75" Ø Notch	2.00" Ø Notch	1.50" Ø Notch	1.75" Ø Notch	2.00" Ø Notch
1.250 x 0.120	23.665" J0004258	23.737" J0004260	23.781" J0004262	23.665" J0004259	23.737" J0004261	23.781" J0004263
	29.665" J0004595	29.737" J0004597	29.781" J0004599	29.665" J0004596	29.737" J0004598	29.781" J0004600
	35.665" J0007345	35.737" J0007347	35.781" J0007349	35.665" J0007346	35.737" J0007348	35.781" J0007350
	41.665" J0008199	41.737" J0008201	41.781" J0008203	41.665" J0008200	41.737" J0008202	41.781" J0008204
	47.665" J0008383	47.737" J0008385	47.781" J0008387	47.665" J0008384	47.737" J0008386	47.781" J0008388
	53.665" J0009896	53.737" J0009898	53.781" J0009900	53.665" J0009897	53.737" J0009899	53.781" J0009901
	59.665" J0010080	59.737" J0010082	59.781" J0010084	59.665" J0010081	59.737" J0010083	59.781" J0010085
	65.665" J0010335	65.737" J0010337	65.781" J0010339	65.665" J0010336	65.737" J0010338	65.781" J0010340
	71.665" J0010520	71.737" J0010522	71.781" J0010524	71.665" J0010521	71.737" J0010523	71.781" J0010525
1.500 x 0.120	23.250" J0004240	23.576" J0004251	23.661" J0004255	23.250" J0004239	23.576" J0004250	23.661" J0004254
	29.250" J0004577	29.576" J0004588	29.661" J0004592	29.250" J0004576	29.576" J0004587	29.661" J0004591
	35.250" J0007327	35.576" J0007338	35.661" J0007342	35.250" J0007326	35.576" J0007337	35.661" J0007341
	41.250" J0008181	41.576" J0008192	41.661" J0008196	41.250" J0008180	41.576" J0008191	41.661" J0008195
	47.250" J0008365	47.576" J0008376	47.661" J0008380	47.250" J0008364	47.576" J0008375	47.661" J0008379
	53.250" J0009878	53.576" J0009889	53.661" J0009893	53.250" J0009877	53.576" J0009888	53.661" J0009892
	59.250" J0010062	59.576" J0010073	59.661" J0010077	59.250" J0010061	59.576" J0010072	59.661" J0010076
	65.250" J0010317	65.576" J0010328	65.661" J0010332	65.250" J0010316	65.576" J0010327	65.661" J0010331
	71.250" J0010502	71.576" J0010513	71.661" J0010517	71.250" J0010501	71.576" J0010512	71.661" J0010516
1.500 x 0.250	23.250" J0004241	23.576" J0004252	23.661" J0004256	23.250" J0004242	23.576" J0004253	23.661" J0004257
	29.250" J0004578	29.576" J0004589	29.661" J0004593	29.250" J0004579	29.576" J0004590	29.661" J0004594
	35.250" J0007328	35.576" J0007339	35.661" J0007343	35.250" J0007329	35.576" J0007340	35.661" J0007344
	41.250" J0008182	41.576" J0008193	41.661" J0008197	41.250" J0008183	41.576" J0008194	41.661" J0008198
	47.250" J0008366	47.576" J0008377	47.661" J0008381	47.250" J0008367	47.576" J0008378	47.661" J0008382
	53.250" J0009879	53.576" J0009890	53.661" J0009894	53.250" J0009880	53.576" J0009891	53.661" J0009895
	59.250" J0010063	59.576" J0010074	59.661" J0010078	59.250" J0010064	59.576" J0010075	59.661" J0010079
	65.250" J0010318	65.576" J0010329	65.661" J0010333	65.250" J0010319	65.576" J0010330	65.661" J0010334
	71.250" J0010503	71.576" J0010514	71.661" J0010518	71.250" J0010504	71.576" J0010515	71.661" J0010519



Notched Tube Size	DOM TUBING (Length is notch bottom to tube end)			4130 CHROME MOLY (Length is notch bottom to tube end)		
	1.50" Ø Notch	1.75" Ø Notch	2.00" Ø Notch	1.50" Ø Notch	1.75" Ø Notch	2.00" Ø Notch
1.750 x 0.120	23.250" J0004243	23.125" J0004232	23.844" J0004264	23.250" J0004244	23.125" J0004231	23.844" J0004263
	29.250" J0004580	29.125" J0004569	29.844" J0004601	29.250" J0004581	29.125" J0004568	29.844" J0004600
	35.250" J0007330	35.125" J0007319	35.844" J0007351	35.250" J0007329	35.125" J0007318	35.844" J0007350
	41.250" J0008184	41.125" J0008173	41.844" J0008205	41.250" J0008183	41.125" J0008172	41.844" J0008204
	47.250" J0008368	47.125" J0008357	47.844" J0008389	47.250" J0008367	47.125" J0008356	47.844" J0008388
	53.250" J0009881	53.125" J0009870	53.844" J0009902	53.250" J0009880	53.125" J0009869	53.844" J0009901
	59.250" J0010065	59.125" J0010054	59.844" J0010086	59.250" J0010064	59.125" J0010053	59.844" J0010085
	65.250" J0010320	65.125" J0010309	65.844" J0010341	65.250" J0010319	65.125" J0010308	65.844" J0010340
	71.250" J0010505	71.125" J0010494	71.844" J0010526	71.250" J0010504	71.125" J0010493	71.844" J0010525
1.750 x 0.250	23.250" J0004246	23.125" J0004235	23.844" J0004267	23.250" J0004245	23.125" J0004234	23.844" J0004266
	29.250" J0004583	29.125" J0004572	29.844" J0004604	29.250" J0004582	29.125" J0004571	29.844" J0004603
	35.250" J0007333	35.125" J0007322	35.844" J0007354	35.250" J0007332	35.125" J0007321	35.844" J0007353
	41.250" J0008187	41.125" J0008176	41.844" J0008208	41.250" J0008186	41.125" J0008175	41.844" J0008207
	47.250" J0008371	47.125" J0008363	47.844" J0008392	47.250" J0008370	47.125" J0008362	47.844" J0008391
	53.250" J0009884	53.125" J0009873	53.844" J0009905	53.250" J0009883	53.125" J0009872	53.844" J0009904
	59.250" J0010068	59.125" J0010057	59.844" J0010089	59.250" J0010067	59.125" J0010056	59.844" J0010088
	65.250" J0010323	65.125" J0010312	65.844" J0010344	65.250" J0010322	65.125" J0010311	65.844" J0010343
	71.250" J0010508	71.125" J0010497	71.844" J0010529	71.250" J0010507	71.125" J0010496	71.844" J0010528
2.000 x 0.250	23.250" J0004247	23.125" J0004236	23.000" J0004358	23.250" J0004248	23.125" J0004237	23.000" J0004359
	29.250" J0004584	29.125" J0004573	29.000" J0004605	29.250" J0004585	29.125" J0004574	29.000" J0004606
	35.250" J0007334	35.125" J0007323	35.000" J0007355	35.250" J0007335	35.125" J0007324	35.000" J0007356
	41.250" J0008188	41.125" J0008177	41.000" J0008209	41.250" J0008189	41.125" J0008178	41.000" J0008210
	47.250" J0008372	47.125" J0008361	47.000" J0008393	47.250" J0008373	47.125" J0008362	47.000" J0008394
	53.250" J0009885	53.125" J0009874	53.000" J0009906	53.250" J0009886	53.125" J0009875	53.000" J0009907
	59.250" J0010069	59.125" J0010058	59.000" J0010090	59.250" J0010070	59.125" J0010059	59.000" J0010091
	65.250" J0010324	65.125" J0010313	65.000" J0010345	65.250" J0010325	65.125" J0010314	65.000" J0010346
	71.250" J0010509	71.125" J0010498	71.000" J0010530	71.250" J0010510	71.125" J0010499	71.000" J0010531
2.500 x 0.250	<i>long lead time item contact us if interested</i>			23.250" J0004249	23.125" J0004238	23.000" J0004360
				29.250" J0004586	29.125" J0004575	29.000" J0004607
				35.250" J0007336	35.125" J0007325	35.000" J0007357
				41.250" J0008190	41.125" J0008179	41.000" J0008211
				47.250" J0008374	47.125" J0008363	47.000" J0008395
				53.250" J0009887	53.125" J0009876	53.000" J0009908
				59.250" J0010071	59.125" J0010060	59.000" J0010092
				65.250" J0010326	65.125" J0010315	65.000" J0010347
				71.250" J0010511	71.125" J0010500	71.000" J0010532

	Straight Cut Tubes	Tube Outer Diameter and Wall Thickness							
		1.000 x 0.095		1.250 x 0.095		1.250 x 0.120		1.500 x 0.120	
Length	Tubes/Kit	DOM	4130 Moly	DOM	4130 Moly	DOM	4130 Moly	DOM	4130 Moly
12"	1 tube/kit	J0002143	J0002139	J0002177	J0002172	J0002185	J0002181	J0002215	J0002211
	2 tubes/kit	J0002144	J0002140	J0002178	J0002173	J0002186	J0002182	J0002216	J0002212
	3 tubes/kit	J0002145	J0002141	J0002179	J0002174	J0002187	J0002183	J0002217	J0002213
	4 tubes/kit	J0002146	J0002142	J0002180	J0002175	J0002188	J0002184	J0002218	J0002214
18"	1 tube/kit	J0003029	J0003025	J0003060	J0003055	J0003068	J0003064	J0003097	J0003093
	2 tubes/kit	J0003030	J0003026	J0003061	J0003056	J0003069	J0003065	J0003098	J0003094
	3 tubes/kit	J0003031	J0003027	J0003062	J0003057	J0003070	J0003066	J0003099	J0003095
	4 tubes/kit	J0003032	J0003028	J0003063	J0003058	J0003071	J0003067	J0003100	J0003096
24"	1 tube/kit	J0004438	J0004434	J0002177	J0004467	J0004479	J0004475	J0004509	J0004505
	2 tubes/kit	J0004439	J0004435	J0004472	J0004468	J0004480	J0004476	J0004510	J0004506
	3 tubes/kit	J0004440	J0004436	J0004473	J0004469	J0004481	J0004477	J0004511	J0004507
	4 tubes/kit	J0004441	J0004437	J0004474	J0004470	J0004482	J0004478	J0004512	J0004508
30"	1 tube/kit	J0007193	J0007189	J0007223	J0007219	J0007231	J0007227	J0007260	J0007256
	2 tubes/kit	J0007194	J0007190	J0007224	J0007220	J0007232	J0007228	J0007261	J0007257
	3 tubes/kit	J0007195	J0007191	J0007225	J0007221	J0007233	J0007229	J0007262	J0007258
	4 tubes/kit	J0007196	J0007192	J0007226	J0007222	J0007234	J0007230	J0007263	J0007259
36"	1 tube/kit	J0007442	J0007438	J0007475	J0007471	J0007483	J0007479	J0007513	J0007509
	2 tubes/kit	J0007443	J0007439	J0007476	J0007472	J0007484	J0007480	J0007514	J0007510
	3 tubes/kit	J0007444	J0007440	J0007477	J0007473	J0007485	J0007481	J0007515	J0007511
	4 tubes/kit	J0007445	J0007441	J0007478	J0007474	J0007486	J0007482	J0007516	J0007512
42"	1 tube/kit	J0008231	J0008227	J0008261	J0008257	J0008269	J0008265	J0008298	J0008294
	2 tubes/kit	J0008232	J0008228	J0008262	J0008258	J0008270	J0008266	J0008299	J0008295
	3 tubes/kit	J0008233	J0008229	J0008263	J0008259	J0008271	J0008267	J0008300	J0008296
	4 tubes/kit	J0008234	J0008230	J0008264	J0008260	J0008272	J0008268	J0008301	J0008297
48"	1 tube/kit	J0008480	J0008476	J0008512	J0008508	J0008520	J0008516	J0008550	J0008546
	2 tubes/kit	J0008481	J0008477	J0008513	J0008509	J0008521	J0008517	J0008551	J0008547
	3 tubes/kit	J0008482	J0008478	J0008514	J0008510	J0008522	J0008518	J0008552	J0008548
	4 tubes/kit	J0008483	J0008479	J0008515	J0008511	J0008523	J0008519	J0008553	J0008549
60"	1 tube/kit	J0010178	J0010174	J0010211	J0010207	J0010219	J0010215	J0010249	J0010245
	2 tubes/kit	J0010179	J0010175	J0010212	J0010208	J0010222	J0010216	J0010250	J0010246
	3 tubes/kit	J0010180	J0010176	J0010213	J0010209	J0010223	J0010217	J0010251	J0010247
	4 tubes/kit	J0010181	J0010177	J0010214	J0010210	J0010224	J0010218	J0010252	J0010248
72"	1 tube/kit	J0010617	J0010613	J0010650	J0010646	J0010658	J0010654	J0010688	J0010684
	2 tubes/kit	J0010618	J0010614	J0010651	J0010647	J0010659	J0010655	J0010689	J0010685
	3 tubes/kit	J0010619	J0010615	J0010652	J0010648	J0010660	J0010666	J0010690	J0010686
	4 tubes/kit	J0010620	J0010616	J0010653	J0010649	J0010661	J0010667	J0010691	J0010687

\*\*\* This is not a complete list - Please see our website for other lengths, and other tube diameters/wall thicknesses \*\*\*\*

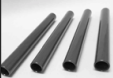
	Straight Cut Tubes	Tube Outer Diameter and Wall Thickness							
		1.500 x 0.250		1.750 x 0.120		1.750 x 0.250		2.000 x 0.250	
Length	Tubes/Kit	DOM	4130 Moly	DOM	4130 Moly	DOM	4130 Moly	DOM	4130 Moly
12"	1 tube/kit	J0002223	J0002219	J0002242	J0002238	J0002251	J0002247	J0002268	J0002263
	2 tubes/kit	J0002224	J0002220	J0002243	J0002239	J0002252	J0002248	J0002269	J0002264
	3 tubes/kit	J0002225	J0002221	J0002244	J0002240	J0002253	J0002249	J0002270	J0002265
	4 tubes/kit	J0002226	J0002222	J0002245	J0002241	J0002254	J0002250	J0002271	J0002266
18"	1 tube/kit	J0003105	J0003101	J0003124	J0003120	J0003133	J0003129	J0003150	J0003145
	2 tubes/kit	J0003106	J0003102	J0003125	J0003121	J0003134	J0003130	J0003151	J0003146
	3 tubes/kit	J0003107	J0003103	J0003126	J0003122	J0003135	J0003131	J0003152	J0003147
	4 tubes/kit	J0003108	J0003104	J0003127	J0003123	J0003136	J0003132	J0003153	J0003148
24"	1 tube/kit	J0004517	J0004513	J0004536	J0004532	J0004544	J0004540	J0004559	J0004555
	2 tubes/kit	J0004518	J0004514	J0004537	J0004533	J0004545	J0004541	J0004560	J0004556
	3 tubes/kit	J0004519	J0004515	J0004538	J0004534	J0004546	J0004542	J0004561	J0004557
	4 tubes/kit	J0004520	J0004516	J0004539	J0004535	J0004547	J0004543	J0004562	J0004558
30"	1 tube/kit	J0007268	J0007264	J0007287	J0007283	J0007295	J0007291	J0007310	J0007306
	2 tubes/kit	J0007269	J0007265	J0007288	J0007284	J0007296	J0007292	J0007311	J0007307
	3 tubes/kit	J0007270	J0007266	J0007289	J0007285	J0007297	J0007293	J0007312	J0007308
	4 tubes/kit	J0007271	J0007267	J0007290	J0007286	J0007298	J0007294	J0007313	J0007309
36"	1 tube/kit	J0007521	J0007517	J0007540	J0007536	J0007548	J0007544	J0007563	J0007559
	2 tubes/kit	J0007522	J0007518	J0007541	J0007537	J0007549	J0007545	J0007564	J0007560
	3 tubes/kit	J0007523	J0007519	J0007542	J0007538	J0007550	J0007546	J0007565	J0007561
	4 tubes/kit	J0007524	J0007520	J0007543	J0007539	J0007551	J0007547	J0007566	J0007562
42"	1 tube/kit	J0008306	J0008302	J0008325	J0008321	J0008333	J0008329	J0008348	J0008344
	2 tubes/kit	J0008307	J0008303	J0008326	J0008322	J0008334	J0008330	J0008349	J0008345
	3 tubes/kit	J0008308	J0008304	J0008327	J0008323	J0008335	J0008331	J0008350	J0008346
	4 tubes/kit	J0008309	J0008305	J0008328	J0008324	J0008336	J0008332	J0008351	J0008347
48"	1 tube/kit	J0008558	J0008554	J0008577	J0008573	J0008585	J0008581	J0008600	J0008596
	2 tubes/kit	J0008559	J0008555	J0008578	J0008574	J0008586	J0008582	J0008601	J0008597
	3 tubes/kit	J0008560	J0008556	J0008579	J0008575	J0008587	J0008583	J0008602	J0008598
	4 tubes/kit	J0008561	J0008557	J0008580	J0008576	J0008588	J0008584	J0008603	J0008599
60"	1 tube/kit	J0010257	J0010253	J0010276	J0010272	J0010284	J0010280	J0010299	J0010295
	2 tubes/kit	J0010258	J0010254	J0010277	J0010273	J0010285	J0010281	J0010300	J0010296
	3 tubes/kit	J0010259	J0010255	J0010288	J0010274	J0010286	J0010282	J0010301	J0010297
	4 tubes/kit	J0010260	J0010256	J0010289	J0010275	J0010287	J0010283	J0010302	J0010298
72"	1 tube/kit	J0010696	J0010692	J0010715	J0010711	J0010723	J0010719	J0010738	J0010734
	2 tubes/kit	J0010697	J0010693	J0010716	J0010712	J0010724	J0010720	J0010739	J0010735
	3 tubes/kit	J0010698	J0010694	J0010717	J0010713	J0010725	J0010721	J0010740	J0010736
	4 tubes/kit	J0010699	J0010695	J0010718	J0010714	J0010726	J0010722	J0010741	J0010737

\*\*\* This is not a complete list - Please see our website for other lengths, and other tube diameters/wall thicknesses \*\*\*\*

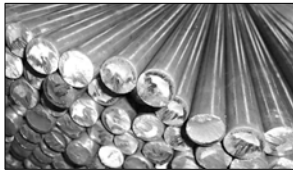

## Cut Bar Lengths - 1', 2', 3', 4', 5' and 6' cut lengths of common 1018 bar, 1045 bar, 304 Stainless Steel, and 4140 alloy steel

In addition to offering cut lengths of bar, Steinjäger also offers flat bar, and tubing cut to length, as well as custom fabricated private-label parts per your specifications.

C1018 Bar	0.1563" Ø	0.1875" Ø	5mm Ø	6mm Ø	0.2500" Ø	0.2790" Ø	0.2812" Ø	0.3125" Ø	0.3410" Ø	0.3750" Ø	10mm Ø
12" long	J0002070	J0002071	J0002078	J0002080	J0002089	J0002091	J0002092	J0002096	J0002098	J0002101	J0002102
24" long	J0004365	J0004366	J0004373	J0004375	J0004384	J0004386	J0004387	J0004391	J0004393	J0004396	J0004397
36" long	J0007362	J0007364	J0007371	J0007373	J0007383	J0007385	J0007386	J0007391	J0007393	J0007397	J0007398
48" long	J0008400	J0008402	J0008409	J0008411	J0008421	J0008423	J0008424	J0008429	J0008431	J0008435	J0008436
60" long	J0010098	J0010100	J0010107	J0010109	J0010119	J0010121	J0010122	J0010127	J0010129	J0010133	J0010134
72" long	J0010537	J0010539	J0010546	J0010548	J0010558	J0010560	J0010561	J0010566	J0010568	J0010572	J0010573

C1018 Bar	0.4375" Ø	0.4630" Ø	0.4680" Ø	12mm Ø	0.5000" Ø	0.5625" Ø	0.6250" Ø	0.6560" Ø	0.6875" Ø	0.7500" Ø	20mm Ø
12" long	J0002104	J0002105	J0002106	J0002107	J0002113	J0002116	J0002122	J0002124	J0002125	J0002133	J0002135
24" long	J0004399	J0004400	J0004401	J0004402	J0004408	J0004411	J0004417	J0004419	J0004420	J0004428	J0004430
36" long	J0007400	J0007401	J0007402	J0007403	J0007410	J0007413	J0007419	J0007421	J0007422	J0007431	J0007433
48" long	J0008438	J0008439	J0008440	J0008441	J0008448	J0008451	J0008457	J0008459	J0008460	J0008469	J0008471
60" long	J0010136	J0010137	J0010138	J0010139	J0010146	J0010149	J0010155	J0010157	J0010158	J0010167	J0010169
72" long	J0010575	J0010576	J0010577	J0010578	J0010585	J0010588	J0010594	J0010596	J0010597	J0010606	J0010608

C1018 Bar	1.000" Ø	1.1875" Ø	C1035 Bar	0.5000" Ø	C1045 Bar	0.2500" Ø	0.3125" Ø	10mm Ø	12mm Ø	0.5000" Ø	0.6250" Ø
12" long	J0002165	J0002170	12" long	J0002114	12" long	J0002090	J0002097	J0002103	J0002108	J0002115	J0002123
24" long	J0004460	J0004465	24" long	J0004409	24" long	J0004385	J0004392	J0004398	J0004403	J0004410	J0004418
36" long	J0007464	J0007469	36" long	J0007411	36" long	J0007384	J0007392	J0007399	J0007404	J0007412	J0007420
48" long	J0008502	J0008507	48" long	J0008449	48" long	J0008422	J0008430	J0008437	J0008442	J0008450	J0008458
60" long	J0010200	J0010205	60" long	J0010147	60" long	J0010120	J0010128	J0010135	J0010140	J0010148	J0010156
72" long	J0010639	J0010644	72" long	J0010586	72" long	J0010599	J0010567	J0010574	J0010579	J0010587	J0010595

C1045 Bar	0.7500" Ø	Aluminum	0.2500" Ø	0.5000" Ø	0.6250" Ø	304 SS	0.1875" Ø	0.2500" Ø	0.3125" Ø	0.3750" Ø	0.5000" Ø
12" long	J0002134	12" long	J0002088	J0002112	J0002121	12" long	J0007160	J0007162	J0007164	J0007166	J0007170
24" long	J0004429	24" long	J0004383	J0004407	J0004416	24" long	J0007161	J0007163	J0007165	J0007167	J0007171
36" long	J0007432	36" long	J0007382	J0007409	J0007418	36" long	J0007363	J0007381	J0007390	J0007396	J0007408
48" long	J0008470	48" long	J0008420	J0008447	J0008456	48" long	J0008401	J0008419	J0008428	J0008434	J0008446
60" long	J0010168	60" long	J0010118	J0010145	J0010154	60" long	J0010099	J0010117	J0010126	J0010132	J0010144
72" long	J0010607	72" long	J0010557	J0010584	J0010593	72" long	J0010538	J0010556	J0010565	J0010571	J0010583

304 SS	0.7500" Ø	0.8125" Ø	4140 AS	0.8750" Ø
12" long	J0007183	J0007185	12" long	J0002138
24" long	J0007184	J0007186	24" long	J0004433
36" long	J0007430	J0007434	36" long	J0007437
48" long	J0008468	J0008472	48" long	J0008475
60" long	J0010166	J0010170	60" long	J0010173
72" long	J0010605	J0010609	72" long	J0010612

Contract Fabricating



Private Labeling



**Flat Bar, Cut to Length**

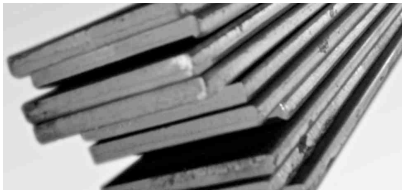

Steinjäger offers standard cut lengths of 1018 flat bar steel.

Wire, bar and tubing are also available.

Contract Manufacturing

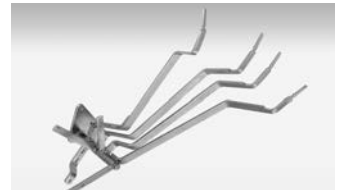

Length	0.125" x 0.750"	0.125" x 1.000"	0.125" x 1.250"	0.125" x 2.000"	0.188" x 0.500"	0.188" x 0.625"	0.188" x 0.750"	0.188" x 1.000"	0.188" x 1.500"
12"	J0002066	J0002067	J0002068	J0002069	J0002072	J0002073	J0002074	J0002075	J0002076
24"	J0004361	J0004362	J0004363	J0004364	J0004367	J0004368	J0004369	J0004370	J0004371
36"	J0007358	J0007359	J0007360	J0007361	J0007365	J0007366	J0007367	J0007368	J0007369
48"	J0008396	J0008397	J0008398	J0008399	J0008403	J0008404	J0008405	J0008406	J0008407
60"	J0010094	J0010095	J0010096	J0010097	J0010101	J0010102	J0010103	J0010104	J0010105
72"	J0010533	J0010534	J0010535	J0010536	J0010540	J0010541	J0010542	J0010543	J0010544

Length	0.188" x 1.750"	0.250" x 0.750"	0.250" x 0.875"	0.250" x 1.000"	0.250" x 1.250"	0.250" x 1.500"	0.250" x 2.000"	0.250" x 2.500"	0.312" x 0.750"
12"	J0002077	J0002081	J0002082	J0002083	J0002084	J0002085	J0002086	J0002087	J0002093
24"	J0004372	J0004376	J0004377	J0004378	J0004379	J0004380	J0004381	J0004382	J0004388
36"	J0007370	J0007374	J0007375	J0007376	J0007377	J0007378	J0007379	J0007380	J0007387
48"	J0008408	J0008412	J0008413	J0008414	J0008415	J0008416	J0008417	J0008418	J0008425
60"	J0010106	J0010110	J0010111	J0010112	J0010113	J0010114	J0010115	J0010116	J0010123
72"	J0010545	J0010549	J0010550	J0010551	J0010552	J0010553	J0010554	J0010555	J0010562

Length	0.312" x 1.000"	0.312" x 1.500"	0.375" x 0.750"	0.375" x 1.000"	0.500" x 1.250"	1.250" x 0.079"
12"	J0002094	J0002095	J0002099	J0002100	J0002111	J0002207
24"	J0004389	J0004390	J0004394	J0004395	J0004406	J0004501
36"	J0007388	J0007389	J0007394	J0007395	J0007407	J0007505
48"	J0008426	J0008427	J0008432	J0008433	J0008445	J0008542
60"	J0010124	J0010125	J0010130	J0010131	J0010143	J0010241
72"	J0010563	J0010564	J0010569	J0010570	J0010582	J0010680

Contract Manufacturing



**Rectangular Tubes, Cut to Length**

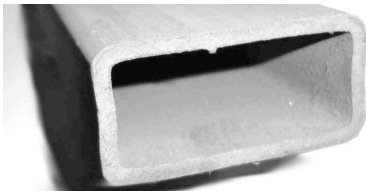

Steinjäger offers standard cut lengths of HREW rectangular/square tubing.

Size of Tubing	Cut Lengths											
	12"	24"	36"	48"	60"	72"	84"	96"	108"	120"	132"	144"
1.000" x 1.000" x 0.109"	J0002164	J0004459	J0007463	J0008501	J0010199	J0010638	J0010788	J0012023	J0001922	J0002303	J0002475	J0002647
2.000" x 1.000" x 0.112"	J0002273	J0004566	J0007570	J0008607	J0010306	J0010745	J0010829	J0012064	J0001963	J0002344	J0002516	J0002688



**Welded & Painted Tubes**



Silver Painted Finish Shown

Steinjäger offers over 4,200 different suspension and linkage tubes. These tubes are welded and painted and ready for installation. The Black Powder finished part numbers are shown below. **Refer to our website for Silver Powder Painted and Chrome Plated finishes.** Tubes shown below are DOM ASTM A513-5 Tubing. Refer to our website for Chrome Moly and HREW designs.

Thread Bungs are 4130 Chrome Moly.  
Tubes come with LH and RH threads.  
Lengths are listed as inches refer to the overall length.

Inch Lgth	Tubing Size	Painted Black Part#
3/8-24 Thread Sizes		
4.82	0.875 x 0.065	J0024168
7.82	0.875 x 0.065	J0024169
10.82	0.875 x 0.065	J0024170
13.82	0.875 x 0.065	J0024171
16.82	0.875 x 0.065	J0024172
19.82	0.875 x 0.065	J0024173
22.82	0.875 x 0.065	J0024174
25.82	0.875 x 0.065	J0024175
31.82	0.875 x 0.065	J0024176
37.82	0.875 x 0.065	J0024177
43.82	0.875 x 0.065	J0024178
49.82	0.875 x 0.065	J0024179
55.82	0.875 x 0.065	J0024180
61.82	0.875 x 0.065	J0024181
67.82	0.875 x 0.065	J0024182
73.82	0.875 x 0.065	J0024183
4.82	1.000 x 0.083	J0024184
7.82	1.000 x 0.083	J0024185
10.82	1.000 x 0.083	J0024186
13.82	1.000 x 0.083	J0024187
16.82	1.000 x 0.083	J0024188
19.82	1.000 x 0.083	J0024189
22.82	1.000 x 0.083	J0024190
25.82	1.000 x 0.083	J0024191
31.82	1.000 x 0.083	J0024192
37.82	1.000 x 0.083	J0024193
43.82	1.000 x 0.083	J0024194
49.82	1.000 x 0.083	J0024195
55.82	1.000 x 0.083	J0024196
61.82	1.000 x 0.083	J0024197
67.82	1.000 x 0.083	J0024198
73.82	1.000 x 0.083	J0024199
4.82	1.000 x 0.095	J0024200
7.82	1.000 x 0.095	J0024201
8.82	1.000 x 0.095	J0024202
9.82	1.000 x 0.095	J0024203
10.82	1.000 x 0.095	J0024204

Inch Lgth	Tubing Size	Painted Black Part#
3/8-24 Thread Sizes (continued)		
11.82	1.000 x 0.095	J0024205
12.82	1.000 x 0.095	J0024206
13.82	1.000 x 0.095	J0024207
14.82	1.000 x 0.095	J0024208
15.82	1.000 x 0.095	J0024209
16.82	1.000 x 0.095	J0024210
17.82	1.000 x 0.095	J0024211
18.82	1.000 x 0.095	J0024212
19.82	1.000 x 0.095	J0024213
20.82	1.000 x 0.095	J0024214
21.82	1.000 x 0.095	J0024215
22.82	1.000 x 0.095	J0024216
23.82	1.000 x 0.095	J0024217
24.82	1.000 x 0.095	J0024218
25.82	1.000 x 0.095	J0024219
31.82	1.000 x 0.095	J0024220
37.82	1.000 x 0.095	J0024221
43.82	1.000 x 0.095	J0024222
49.82	1.000 x 0.095	J0024223
55.82	1.000 x 0.095	J0024224
61.82	1.000 x 0.095	J0024225
67.82	1.000 x 0.095	J0024226
73.82	1.000 x 0.095	J0024227

1/2-20 Thread Sizes		
5.57	0.875 x 0.065	J0024367
8.57	0.875 x 0.065	J0024368
11.57	0.875 x 0.065	J0024369
14.57	0.875 x 0.065	J0024370
17.57	0.875 x 0.065	J0024371
20.57	0.875 x 0.065	J0024372
23.57	0.875 x 0.065	J0024373
26.57	0.875 x 0.065	J0024374
32.57	0.875 x 0.065	J0024375
38.57	0.875 x 0.065	J0024376
44.57	0.875 x 0.065	J0024377
50.57	0.875 x 0.065	J0024378

Inch Lgth	Tubing Size	Painted Black Part#
1/2-20 Thread Sizes (continued)		
56.57	0.875 x 0.065	J0024379
62.57	0.875 x 0.065	J0024380
68.57	0.875 x 0.065	J0024381
74.57	0.875 x 0.065	J0024382
5.57	1.000 x 0.083	J0024383
8.57	1.000 x 0.083	J0024384
11.57	1.000 x 0.083	J0024385
14.57	1.000 x 0.083	J0024386
17.57	1.000 x 0.083	J0024387
20.57	1.000 x 0.083	J0024388
23.57	1.000 x 0.083	J0024389
26.57	1.000 x 0.083	J0024390
32.57	1.000 x 0.083	J0024391
38.57	1.000 x 0.083	J0024392
44.57	1.000 x 0.083	J0024393
50.57	1.000 x 0.083	J0024394
56.57	1.000 x 0.083	J0024395
62.57	1.000 x 0.083	J0024396
68.57	1.000 x 0.083	J0024397
74.57	1.000 x 0.083	J0024398
5.57	1.000 x 0.095	J0024399
8.57	1.000 x 0.095	J0024400
9.57	1.000 x 0.095	J0024401
10.57	1.000 x 0.095	J0024402
11.57	1.000 x 0.095	J0024403
12.57	1.000 x 0.095	J0024404
13.57	1.000 x 0.095	J0024405
14.57	1.000 x 0.095	J0024406
15.57	1.000 x 0.095	J0024407
16.57	1.000 x 0.095	J0024408
17.57	1.000 x 0.095	J0024409
18.57	1.000 x 0.095	J0024410
19.57	1.000 x 0.095	J0024411
20.57	1.000 x 0.095	J0024412
21.57	1.000 x 0.095	J0024413
22.57	1.000 x 0.095	J0024414
23.57	1.000 x 0.095	J0024415

Inch Lgth	Tubing Size	Painted Black Part#
1/2-20 Thread Sizes (continued)		
24.57	1.000 x 0.095	J0024416
25.57	1.000 x 0.095	J0024417
26.57	1.000 x 0.095	J0024418
32.57	1.000 x 0.095	J0024419
38.57	1.000 x 0.095	J0024420
44.57	1.000 x 0.095	J0024421
50.57	1.000 x 0.095	J0024422
56.57	1.000 x 0.095	J0024423
62.57	1.000 x 0.095	J0024424
68.57	1.000 x 0.095	J0024425
74.57	1.000 x 0.095	J0024426

5/8-18 Thread Sizes		
5.32	1.000 x 0.083	J0024604
8.32	1.000 x 0.083	J0024605
11.32	1.000 x 0.083	J0024606
14.32	1.000 x 0.083	J0024607
17.32	1.000 x 0.083	J0024608
20.32	1.000 x 0.083	J0024609
23.32	1.000 x 0.083	J0024610
26.32	1.000 x 0.083	J0024611
32.32	1.000 x 0.083	J0024612
38.32	1.000 x 0.083	J0024613
44.32	1.000 x 0.083	J0024614
50.32	1.000 x 0.083	J0024615
56.32	1.000 x 0.083	J0024616
62.32	1.000 x 0.083	J0024617
68.32	1.000 x 0.083	J0024618
74.32	1.000 x 0.083	J0024619
5.32	1.000 x 0.095	J0024636
8.32	1.000 x 0.095	J0024637
9.32	1.000 x 0.095	J0024638
10.32	1.000 x 0.095	J0024639
11.32	1.000 x 0.095	J0024640
12.32	1.000 x 0.095	J0024641
13.32	1.000 x 0.095	J0024642
14.32	1.000 x 0.095	J0024643

Inch Lgth	Tubing Size	Painted Black Part#
5/8-18 Thread Sizes (continued)		
15.32	1.000 x 0.095	J0024644
16.32	1.000 x 0.095	J0024645
17.32	1.000 x 0.095	J0024646
18.32	1.000 x 0.095	J0024647
19.32	1.000 x 0.095	J0024648
20.32	1.000 x 0.095	J0024649
21.32	1.000 x 0.095	J0024650
22.32	1.000 x 0.095	J0024651
23.32	1.000 x 0.095	J0024652
24.32	1.000 x 0.095	J0024653
25.32	1.000 x 0.095	J0024654
26.32	1.000 x 0.095	J0024655
32.32	1.000 x 0.095	J0024656
38.32	1.000 x 0.095	J0024657
44.32	1.000 x 0.095	J0024658
50.32	1.000 x 0.095	J0024659
56.32	1.000 x 0.095	J0024660
62.32	1.000 x 0.095	J0024661
68.32	1.000 x 0.095	J0024662
74.32	1.000 x 0.095	J0024663
5.32	1.250 x 0.083	J0024620
8.32	1.250 x 0.083	J0024621
11.32	1.250 x 0.083	J0024622
14.32	1.250 x 0.083	J0024623
17.32	1.250 x 0.083	J0024624
20.32	1.250 x 0.083	J0024625
23.32	1.250 x 0.083	J0024626
26.32	1.250 x 0.083	J0024627
32.32	1.250 x 0.083	J0024628
38.32	1.250 x 0.083	J0024629
44.32	1.250 x 0.083	J0024630
50.32	1.250 x 0.083	J0024631
56.32	1.250 x 0.083	J0024632
62.32	1.250 x 0.083	J0024633
68.32	1.250 x 0.083	J0024634
74.32	1.250 x 0.083	J0024635
8.32	1.250 x 0.095	J0024664
9.32	1.250 x 0.095	J0024665
10.32	1.250 x 0.095	J0024666
11.32	1.250 x 0.095	J0024667
12.32	1.250 x 0.095	J0024668
13.32	1.250 x 0.095	J0024669
14.32	1.250 x 0.095	J0024670
15.32	1.250 x 0.095	J0024671
16.32	1.250 x 0.095	J0024672

Inch Lgth	Tubing Size	Painted Black Part#
5/8-18 Thread Sizes (continued)		
17.32	1.250 x 0.095	J0024673
18.32	1.250 x 0.095	J0024674
19.32	1.250 x 0.095	J0024675
20.32	1.250 x 0.095	J0024676
21.32	1.250 x 0.095	J0024677
22.32	1.250 x 0.095	J0024678
23.32	1.250 x 0.095	J0024679
24.32	1.250 x 0.095	J0024680
25.32	1.250 x 0.095	J0024681
26.32	1.250 x 0.095	J0024682
32.32	1.250 x 0.095	J0024683
38.32	1.250 x 0.095	J0024684
44.32	1.250 x 0.095	J0024685
50.32	1.250 x 0.095	J0024686
56.32	1.250 x 0.095	J0024687
62.32	1.250 x 0.095	J0024688
68.32	1.250 x 0.095	J0024689
74.32	1.250 x 0.095	J0024690
5.32	1.250 x 0.120	J0024691
8.32	1.250 x 0.120	J0024692
9.32	1.250 x 0.120	J0024693
10.32	1.250 x 0.120	J0024694
11.32	1.250 x 0.120	J0024695
12.32	1.250 x 0.120	J0024696
13.32	1.250 x 0.120	J0024697
14.32	1.250 x 0.120	J0024698
15.32	1.250 x 0.120	J0024699
16.32	1.250 x 0.120	J0024700
17.32	1.250 x 0.120	J0024701
18.32	1.250 x 0.120	J0024702
19.32	1.250 x 0.120	J0024703
20.32	1.250 x 0.120	J0024704
21.32	1.250 x 0.120	J0024705
22.32	1.250 x 0.120	J0024706
23.32	1.250 x 0.120	J0024708
24.32	1.250 x 0.120	J0024709
25.32	1.250 x 0.120	J0024710
26.32	1.250 x 0.120	J0024711
32.32	1.250 x 0.120	J0024712
38.32	1.250 x 0.120	J0024713
44.32	1.250 x 0.120	J0024714
50.32	1.250 x 0.120	J0024715
56.32	1.250 x 0.120	J0024716
62.32	1.250 x 0.120	J0024717
68.32	1.250 x 0.120	J0024718

Inch Lgth	Tubing Size	Painted Black Part#
3/4-16 Thread Sizes		
8.32	1.250 x 0.095	J0025012
9.32	1.250 x 0.095	J0025013
10.32	1.250 x 0.095	J0025014
11.32	1.250 x 0.095	J0025015
12.32	1.250 x 0.095	J0025016
13.32	1.250 x 0.095	J0025017
14.32	1.250 x 0.095	J0025018
15.32	1.250 x 0.095	J0025019
16.32	1.250 x 0.095	J0025020
17.32	1.250 x 0.095	J0025021
18.32	1.250 x 0.095	J0025022
19.32	1.250 x 0.095	J0025023
20.32	1.250 x 0.095	J0025024
21.32	1.250 x 0.095	J0025025
22.32	1.250 x 0.095	J0025026
23.32	1.250 x 0.095	J0025027
24.32	1.250 x 0.095	J0025028
25.32	1.250 x 0.095	J0025029
26.32	1.250 x 0.095	J0025030
32.32	1.250 x 0.095	J0025031
38.32	1.250 x 0.095	J0025032
44.32	1.250 x 0.095	J0025033
50.32	1.250 x 0.095	J0025034
56.32	1.250 x 0.095	J0025035
62.32	1.250 x 0.095	J0025036
68.32	1.250 x 0.095	J0025037
74.32	1.250 x 0.095	J0025038
5.32	1.250 x 0.120	J0025039
8.32	1.250 x 0.120	J0025040
9.32	1.250 x 0.120	J0025041
10.32	1.250 x 0.120	J0025042
11.32	1.250 x 0.120	J0025043
12.32	1.250 x 0.120	J0025044
13.32	1.250 x 0.120	J0025045
14.32	1.250 x 0.120	J0025046
15.32	1.250 x 0.120	J0025047
16.32	1.250 x 0.120	J0025048
17.32	1.250 x 0.120	J0025049
18.32	1.250 x 0.120	J0025050
19.32	1.250 x 0.120	J0025051
20.32	1.250 x 0.120	J0025052
21.32	1.250 x 0.120	J0025053
22.32	1.250 x 0.120	J0025054
23.32	1.250 x 0.120	J0025056
24.32	1.250 x 0.120	J0025057

Inch Lgth	Tubing Size	Painted Black Part#
3/4-16 Thread Sizes (continued)		
25.32	1.250 x 0.120	J0025058
26.32	1.250 x 0.120	J0025059
32.32	1.250 x 0.120	J0025060
38.32	1.250 x 0.120	J0025061
44.32	1.250 x 0.120	J0025062
50.32	1.250 x 0.120	J0025063
56.32	1.250 x 0.120	J0025064
62.32	1.250 x 0.120	J0025065
68.32	1.250 x 0.120	J0025066
74.32	1.250 x 0.120	J0025067
5.32	1.500 x 0.120	J0025068
8.32	1.500 x 0.120	J0025069
9.32	1.500 x 0.120	J0025070
10.32	1.500 x 0.120	J0025071
11.32	1.500 x 0.120	J0025072
12.32	1.500 x 0.120	J0025073
13.32	1.500 x 0.120	J0025074
14.32	1.500 x 0.120	J0025075
15.32	1.500 x 0.120	J0025076
16.32	1.500 x 0.120	J0025077
17.32	1.500 x 0.120	J0025078
18.32	1.500 x 0.120	J0025079
19.32	1.500 x 0.120	J0025080
20.32	1.500 x 0.120	J0025081
21.32	1.500 x 0.120	J0025082
22.32	1.500 x 0.120	J0025083
23.32	1.500 x 0.120	J0025085
24.32	1.500 x 0.120	J0025086
25.32	1.500 x 0.120	J0025087
26.32	1.500 x 0.120	J0025088
32.32	1.500 x 0.120	J0025089
38.32	1.500 x 0.120	J0025090
44.32	1.500 x 0.120	J0025091
50.32	1.500 x 0.120	J0025092
56.32	1.500 x 0.120	J0025093
62.32	1.500 x 0.120	J0025094
68.32	1.500 x 0.120	J0025095
74.32	1.500 x 0.120	J0025096
5.32	1.500 x 0.250	J0025097
8.32	1.500 x 0.250	J0025098
9.32	1.500 x 0.250	J0025099
10.32	1.500 x 0.250	J0025100
11.32	1.500 x 0.250	J0025101
12.32	1.500 x 0.250	J0025102
13.32	1.500 x 0.250	J0025103

**Welded & Painted Tubes**



Silver Painted Finish Shown

Steinjäger offers over 4,200 different suspension and linkage tubes. These tubes are welded and painted and ready for installation. The Black Powder finished part numbers are shown below. **Refer to our web-site for Silver Powder Painted and Chrome Plated finishes.** Tubes shown below are DOM ASTM A513-5 Tubing. Refer to our website for Chrome Moly and HREW designs.

Thread Bungs are 4130 Chrome Moly.  
Tubes come with LH and RH threads.  
Lengths are listed as inches are refer to the overall length.

Inch Lgth	Tubing Size	Painted Black Part#
3/4-16 Thread Sizes (continued)		
14.32	1.500 x 0.250	J0025104
15.32	1.500 x 0.250	J0025105
16.32	1.500 x 0.250	J0025106
17.32	1.500 x 0.250	J0025107
18.32	1.500 x 0.250	J0025108
19.32	1.500 x 0.250	J0025109
20.32	1.500 x 0.250	J0025110
21.32	1.500 x 0.250	J0025111
22.32	1.500 x 0.250	J0025112
23.32	1.500 x 0.250	J0025114
24.32	1.500 x 0.250	J0025115
25.32	1.500 x 0.250	J0025116
26.32	1.500 x 0.250	J0025117
32.32	1.500 x 0.250	J0025118
38.32	1.500 x 0.250	J0025119
44.32	1.500 x 0.250	J0025120
50.32	1.500 x 0.250	J0025121
56.32	1.500 x 0.250	J0025122
62.32	1.500 x 0.250	J0025123
68.32	1.500 x 0.250	J0025124
74.32	1.500 x 0.250	J0025125
5.32	1.750 x 0.120	J0025126
8.32	1.750 x 0.120	J0025127
9.32	1.750 x 0.120	J0025128
10.32	1.750 x 0.120	J0025129
11.32	1.750 x 0.120	J0025130
12.32	1.750 x 0.120	J0025131
13.32	1.750 x 0.120	J0025132
14.32	1.750 x 0.120	J0025133
15.32	1.750 x 0.120	J0025134
16.32	1.750 x 0.120	J0025135
17.32	1.750 x 0.120	J0025136
18.32	1.750 x 0.120	J0025137
19.32	1.750 x 0.120	J0025138
20.32	1.750 x 0.120	J0025139
21.32	1.750 x 0.120	J0025140
22.32	1.750 x 0.120	J0025141

Inch Lgth	Tubing Size	Painted Black Part#
3/4-16 Thread Sizes (continued)		
23.32	1.750 x 0.120	J0025143
24.32	1.750 x 0.120	J0025144
25.32	1.750 x 0.120	J0025145
26.32	1.750 x 0.120	J0015146
32.32	1.750 x 0.120	J0015147
38.32	1.750 x 0.120	J0015148
44.32	1.750 x 0.120	J0015149
50.32	1.750 x 0.120	J0025150
56.32	1.750 x 0.120	J0025151
62.32	1.750 x 0.120	J0025152
68.32	1.750 x 0.120	J0025153
74.32	1.750 x 0.120	J0025154
5.32	1.750 x 0.250	J0025155
8.32	1.750 x 0.250	J0025156
9.32	1.750 x 0.250	J0025157
10.32	1.750 x 0.250	J0025158
11.32	1.750 x 0.250	J0025159
12.32	1.750 x 0.250	J0025160
13.32	1.750 x 0.250	J0025161
14.32	1.750 x 0.250	J0025162
15.32	1.750 x 0.250	J0025163
16.32	1.750 x 0.250	J0025164
17.32	1.750 x 0.250	J0025165
18.32	1.750 x 0.250	J0025166
19.32	1.750 x 0.250	J0025167
20.32	1.750 x 0.250	J0025168
21.32	1.750 x 0.250	J0025169
22.32	1.750 x 0.250	J0025170
23.32	1.750 x 0.250	J0025172
24.32	1.750 x 0.250	J0025173
25.32	1.750 x 0.250	J0025174
26.32	1.750 x 0.250	J0025175
32.32	1.750 x 0.250	J0025176
38.32	1.750 x 0.250	J0025177
44.32	1.750 x 0.250	J0025178
50.32	1.750 x 0.250	J0025179
56.32	1.750 x 0.250	J0025180

Inch Lgth	Tubing Size	Painted Black Part#
3/4-16 Thread Sizes (continued)		
62.32	1.750 x 0.250	J0025181
68.32	1.750 x 0.250	J0025182
74.32	1.750 x 0.250	J0025183
7/8-14 Thread Sizes		
5.82	1.750 x 0.120	J0025268
8.82	1.750 x 0.120	J0025269
9.82	1.750 x 0.120	J0025270
10.82	1.750 x 0.120	J0025271
11.82	1.750 x 0.120	J0025272
12.82	1.750 x 0.120	J0025273
13.82	1.750 x 0.120	J0025274
14.82	1.750 x 0.120	J0025275
15.82	1.750 x 0.120	J0025276
16.82	1.750 x 0.120	J0025277
17.82	1.750 x 0.120	J0025278
18.82	1.750 x 0.120	J0025279
19.82	1.750 x 0.120	J0025280
20.82	1.750 x 0.120	J0025281
21.82	1.750 x 0.120	J0025282
22.82	1.750 x 0.120	J0025283
23.82	1.750 x 0.120	J0025285
24.82	1.750 x 0.120	J0025286
25.82	1.750 x 0.120	J0025287
26.82	1.750 x 0.120	J0025288
32.82	1.750 x 0.120	J0025289
38.82	1.750 x 0.120	J0025290
44.82	1.750 x 0.120	J0025291
50.82	1.750 x 0.120	J0025292
56.82	1.750 x 0.120	J0025293
62.82	1.750 x 0.120	J0025294
68.82	1.750 x 0.120	J0025295
74.82	1.750 x 0.120	J0025296
5.82	1.750 x 0.250	J0025297
8.82	1.750 x 0.250	J0025298
9.82	1.750 x 0.250	J0025299
10.82	1.750 x 0.250	J0025300

Inch Lgth	Tubing Size	Painted Black Part#
7/8-14 Thread Sizes (continued)		
11.82	1.750 x 0.250	J0025301
12.82	1.750 x 0.250	J0025302
13.82	1.750 x 0.250	J0025303
14.82	1.750 x 0.250	J0025304
15.82	1.750 x 0.250	J0025305
16.82	1.750 x 0.250	J0025306
17.82	1.750 x 0.250	J0025307
18.82	1.750 x 0.250	J0025308
19.82	1.750 x 0.250	J0025309
20.82	1.750 x 0.250	J0025310
21.82	1.750 x 0.250	J0025311
22.82	1.750 x 0.250	J0025312
23.82	1.750 x 0.250	J0025314
24.82	1.750 x 0.250	J0025315
25.82	1.750 x 0.250	J0025316
26.82	1.750 x 0.250	J0025317
32.82	1.750 x 0.250	J0025318
38.82	1.750 x 0.250	J0025319
44.82	1.750 x 0.250	J0025320
50.82	1.750 x 0.250	J0025321
56.82	1.750 x 0.250	J0025322
62.82	1.750 x 0.250	J0025323
68.82	1.750 x 0.250	J0025324
74.82	1.750 x 0.250	J0025325
1"-12 Thread Sizes		
6.32	1.750 x 0.120	J0025382
9.32	1.750 x 0.120	J0025383
10.32	1.750 x 0.120	J0025384
11.32	1.750 x 0.120	J0025385
12.32	1.750 x 0.120	J0025386
13.32	1.750 x 0.120	J0025387
14.32	1.750 x 0.120	J0025388
15.32	1.750 x 0.120	J0025389
16.32	1.750 x 0.120	J0025390
17.32	1.750 x 0.120	J0025391
18.32	1.750 x 0.120	J0025392

Inch Lgth	Tubing Size	Painted Black Part#
1"-12 Thread Sizes (continued)		
19.32	1.750 x 0.120	J0025393
20.32	1.750 x 0.120	J0025394
21.32	1.750 x 0.120	J0025395
22.32	1.750 x 0.120	J0025396
23.32	1.750 x 0.120	J0025397
24.32	1.750 x 0.120	J0025399
25.32	1.750 x 0.120	J0025400
26.32	1.750 x 0.120	J0025401
27.32	1.750 x 0.120	J0025402
33.32	1.750 x 0.120	J0025403
39.32	1.750 x 0.120	J0025404
45.32	1.750 x 0.120	J0025405
51.32	1.750 x 0.120	J0025406
57.32	1.750 x 0.120	J0025407
63.32	1.750 x 0.120	J0025408
69.32	1.750 x 0.120	J0025409
75.32	1.750 x 0.120	J0025410
6.32	1.750 x 0.250	J0025411
9.32	1.750 x 0.250	J0025412
10.32	1.750 x 0.250	J0025413
11.32	1.750 x 0.250	J0025414
12.32	1.750 x 0.250	J0025415
13.32	1.750 x 0.250	J0025416
14.32	1.750 x 0.250	J0025417
15.32	1.750 x 0.250	J0025418
16.32	1.750 x 0.250	J0025419

Inch Lgth	Tubing Size	Painted Black Part#
1"-12 Thread Sizes (continued)		
17.32	1.750 x 0.250	J0025420
18.32	1.750 x 0.250	J0025421
19.32	1.750 x 0.250	J0025422
20.32	1.750 x 0.250	J0025423
21.32	1.750 x 0.250	J0025424
22.32	1.750 x 0.250	J0025425
23.32	1.750 x 0.250	J0025426
24.32	1.750 x 0.250	J0025428
25.32	1.750 x 0.250	J0025429
26.32	1.750 x 0.250	J0025430
27.32	1.750 x 0.250	J0025431
33.32	1.750 x 0.250	J0025432
39.32	1.750 x 0.250	J0025433
45.32	1.750 x 0.250	J0025434
51.32	1.750 x 0.250	J0025435
57.32	1.750 x 0.250	J0025436
63.32	1.750 x 0.250	J0025437
69.32	1.750 x 0.250	J0025438
75.32	1.750 x 0.250	J0025439

1.25"-12 Thread Sizes		
7.32	1.750 x 0.120	J0025494
10.32	1.750 x 0.120	J0025495
11.32	1.750 x 0.120	J0025496
12.32	1.750 x 0.120	J0025497
13.32	1.750 x 0.120	J0025498

Inch Lgth	Tubing Size	Painted Black Part#
1.25"-12 Thread Sizes (continued)		
14.32	1.750 x 0.120	J0025499
15.32	1.750 x 0.120	J0025500
16.32	1.750 x 0.120	J0025501
17.32	1.750 x 0.120	J0025502
18.32	1.750 x 0.120	J0025503
19.32	1.750 x 0.120	J0025504
20.32	1.750 x 0.120	J0025505
21.32	1.750 x 0.120	J0025506
22.32	1.750 x 0.120	J0025507
23.32	1.750 x 0.120	J0025508
24.32	1.750 x 0.120	J0025509
25.32	1.750 x 0.120	J0025511
26.32	1.750 x 0.120	J0025512
27.32	1.750 x 0.120	J0025513
28.32	1.750 x 0.120	J0025514
34.32	1.750 x 0.120	J0025515
40.32	1.750 x 0.120	J0025516
46.32	1.750 x 0.120	J0025517
52.32	1.750 x 0.120	J0025518
58.32	1.750 x 0.120	J0025519
64.32	1.750 x 0.120	J0025520
70.32	1.750 x 0.120	J0025521
76.32	1.750 x 0.120	J0025522
10.32	2.000 x 0.250	J0025523
11.32	2.000 x 0.250	J0025524
12.32	2.000 x 0.250	J0025525

Inch Lgth	Tubing Size	Painted Black Part#
1.25"-12 Thread Sizes (continued)		
13.32	2.000 x 0.250	J0025526
14.32	2.000 x 0.250	J0025527
15.32	2.000 x 0.250	J0025528
16.32	2.000 x 0.250	J0025529
17.32	2.000 x 0.250	J0025530
18.32	2.000 x 0.250	J0025531
19.32	2.000 x 0.250	J0025532
20.32	2.000 x 0.250	J0025533
21.32	2.000 x 0.250	J0025534
22.32	2.000 x 0.250	J0025535
23.32	2.000 x 0.250	J0025536
24.32	2.000 x 0.250	J0025537
25.32	2.000 x 0.250	J0025538
26.32	2.000 x 0.250	J0025539
27.32	2.000 x 0.250	J0025540
28.32	2.000 x 0.250	J0025541
34.32	2.000 x 0.250	J0025542
40.32	2.000 x 0.250	J0025543
46.32	2.000 x 0.250	J0025544
52.32	2.000 x 0.250	J0025545
58.32	2.000 x 0.250	J0025546
64.32	2.000 x 0.250	J0025547
70.32	2.000 x 0.250	J0025548
76.32	2.000 x 0.250	J0025549

**Rod End Kits**



Pages 8-11

**Cut Tubes**



Pages 32-33

**Private Labeling**



Contact Us

**Contract Manufacturing**



Contact Us

**Sway Bar End Links**



Pages 48-52

**Chrome Moly**



Page 4

**Unibal Kits**



Pages 12-13

**Private Labeling**



Contact Us

**Male Polys**



Pgs 14-15

**End Link Kits**



Pages 48-59

**Bulk Unibals**



Page 12

**Mounting Tabs & Clevises**





Pages 40-46





1 Link Tab Kits	Frame Mount	Bore Ø	Part#
	Length: 4" from base to center of hole Material: 1/4" carbon steel Tabs per Kit: 4	1/2"	J0008157
		9/16"	J0008169
		5/8"	J0008165
		3/4"	J0008161

3 Link Tab Kit	Frame Mount	Bore Ø	Part#
	Length: 4" from base to center of hole Material: 1/4" carbon steel Tabs per Kit: 12	1/2"	J0008159
		9/16"	J0008171
		5/8"	J0008167
		3/4"	J0008163

2 Link Tab Kits	Frame Mount	Bore Ø	Part#
	Length: 4" from base to center of hole Material: 1/4" carbon steel Tabs per Kit: 8	1/2"	J0008158
		9/16"	J0008170
		5/8"	J0008166
		3/4"	J0008162

4 Link Tab Kit	Frame Mount	Bore Ø	Part#
	Length: 4" from base to center of hole Material: 1/4" carbon steel Tabs per Kit: 16	1/2"	J0008160
		9/16"	J0008172
		5/8"	J0008168
		3/4"	J0008164

1 Link Tab & Clevis	Frame Mount	Bore Ø	2.5" Jaw	3.0" Jaw
	1/4" carbon steel Tabs 4" base-to-hole Clevis Depth: 2.25" Clevises per Kit: 1 Tabs per Kit: 2	1/2"	J0003246	J0005776
		9/16"	J0003303	J0005833
		5/8"	J0003284	J0005814
		3/4"	J0003265	J0005795

3 Link Tab & Clevis	Frame Mount	Bore Ø	2.5" Jaw	3.0" Jaw
	1/4" carbon steel Tabs 4" base-to-hole Clevis Depth: 2.25" Clevises per Kit: 1 Tabs per Kit: 10	1/2"	J0003250	J0005780
		9/16"	J0003307	J0005837
		5/8"	J0003288	J0005818
		3/4"	J0003269	J0005799

2 Link Tab & Clevis	Frame Mount	Bore Ø	2.5" Jaw	3.0" Jaw
	1/4" carbon steel Tabs 4" base-to-hole Clevis Depth: 2.25" Clevises per Kit: 2 Tabs per Kit: 4	1/2"	J0003248	J0005778
		9/16"	J0003305	J0005835
		5/8"	J0003286	J0005816
		3/4"	J0003267	J0005797

3 Link Tab & Clevis	Frame Mount	Bore Ø	2.5" Jaw	3.0" Jaw
	1/4" carbon steel Tabs 4" base-to-hole Clevis Depth: 2.25" Clevises per Kit: 4 Tabs per Kit: 4	1/2"	J0003253	J0005783
		9/16"	J0003310	J0005840
		5/8"	J0003291	J0005821
		3/4"	J0003272	J0005802

1 Link Clevis Kits	Frame Mount	Bore Ø	2.5" Jaw	3.0" Jaw
	Material: 1/4" carbon steel Depth: 2.25" Clevises per Kit: 2	1/2"	J0003247	J0005777
		9/16"	J0003304	J0005834
		5/8"	J0003285	J0005815
		3/4"	J0003266	J0005796

3 Link Clevis Kits	Frame Mount	Bore Ø	2.5" Jaw	3.0" Jaw
	Material: 1/4" carbon steel Depth: 2.25" Clevises per Kit: 6	1/2"	J0003255	J0005785
		9/16"	J0003312	J0005842
		5/8"	J0003293	J0005823
		3/4"	J0003274	J0005804

2 Link Clevis Kits	Frame Mount	Bore Ø	2.5" Jaw	3.0" Jaw
	Material: 1/4" carbon steel Depth: 2.25" Clevises per Kit: 4	1/2"	J0003249	J0005779
		9/16"	J0003306	J0005836
		5/8"	J0003287	J0005817
		3/4"	J0003268	J0005798

4 Link Clevis Kits	Frame Mount	Bore Ø	2.5" Jaw	3.0" Jaw
	Material: 1/4" carbon steel Depth: 2.25" Clevises per Kit: 8	1/2"	J0003264	J0005794
		9/16"	J0003321	J0005851
		5/8"	J0003302	J0005832
		3/4"	J0003283	J0005813

3 Link Tab & Clevis	Frame Mount	Bore Ø	2.5" Jaw	3.0" Jaw
	1/4" carbon steel Tabs 4" base-to-hole Clevis Depth: 2.25" Clevises per Kit: 2 Tabs per Kit: 8	1/2"	J0003251	J0005781
		9/16"	J0003308	J0005838
		5/8"	J0003289	J0005819
		3/4"	J0003270	J0005800

3 Link Tab & Clevis	Frame Mount	Bore Ø	2.5" Jaw	3.0" Jaw
	1/4" carbon steel Tabs 4" base-to-hole Clevis Depth: 2.25" Clevises per Kit: 5 Tabs per Kit: 2	1/2"	J0003254	J0005784
		9/16"	J0003311	J0005841
		5/8"	J0003292	J0005822
		3/4"	J0003273	J0005803

3 Link Tab & Clevis	Frame Mount	Bore Ø	2.5" Jaw	3.0" Jaw
	1/4" carbon steel Tabs 4" base-to-hole Clevis Depth: 2.25" Clevises per Kit: 3 Tabs per Kit: 6	1/2"	J0003252	J0005782
		9/16"	J0003309	J0005839
		5/8"	J0003290	J0005820
		3/4"	J0003271	J0005801

4 Link Parallel Kits	Bore				
	Axle Ø	1/2	9/16	5/8	3/4
	2.75"	J0003322	J0003325	J0003324	J0003323
	3.00"	J0005772	J0005775	J0005774	J0005773
3.50"	J0005188	J0005191	J0005190	J0005189	
4 Par Tabs, 8 Str Tabs	4.00"	J0008153	J0008156	J0008155	J0008154



**2 Link Axle Tab and Mounting Tab Kits**

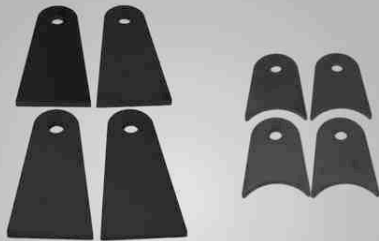

Material: 1/4" carbon steel  
 Straight Tabs are 4" long from base-to-hole  
 Axle Tabs per Kit: 4  
 Straight Tabs per Kit: 4

Fits Axle Ø	Bore	Axle Tab Length (inside of radius to center of hole)				
		2.0"	2.5"	3.0"	3.5"	4.0"
2.75" Ø	1/2	J0003328	J0003331	J0003334	J0003337	J0003340
	9/16	J0003763	J0003766	J0003769	J0003772	J0003775
	5/8	J0003618	J0003621	J0003624	J0003627	J0003630
	3/4	J0003473	J0003476	J0003479	J0003482	J0003485
3.00" Ø	1/2	J0004610	J0004613	J0004616	J0004619	J0004622
	9/16	J0005045	J0005048	J0005051	J0005054	J0005057
	5/8	J0004900	J0004903	J0004906	J0004909	J0004912
	3/4	J0004755	J0004758	J0004761	J0004764	J0004767
3.50" Ø	1/2	J0005194	J0005197	J0005200	J0005203	J0005206
	9/16	J0005629	J0005632	J0005635	J0005638	J0005641
	5/8	J0005484	J0005487	J0005490	J0005493	J0005496
	3/4	J0005339	J0005342	J0005345	J0005348	J0005351
4.00" Ø	1/2	J0007575	J0007578	J0007581	J0007584	J0007587
	9/16	J0008010	J0008013	J0008016	J0008019	J0008022
	5/8	J0007865	J0007868	J0007871	J0007874	J0007877
	3/4	J0007720	J0007723	J0007726	J0007729	J0007732

**3 Link Axle Tab and Mounting Tab Kits**

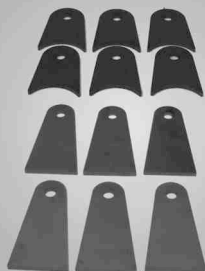

Material: 1/4" carbon steel  
 Straight Tabs are 4" long from base-to-hole  
 Axle Tabs per Kit: 6  
 Straight Tabs per Kit: 6

2.75" Ø	1/2	J0003390	J0003395	J0003400	J0003405	J0003410
	9/16	J0003825	J0003830	J0003835	J0003840	J0003845
	5/8	J0003680	J0003685	J0003690	J0003695	J0003700
	3/4	J0003535	J0003540	J0003545	J0003550	J0003555
3.00" Ø	1/2	J0004672	J0004677	J0004682	J0004687	J0004692
	9/16	J0005107	J0005112	J0005117	J0005122	J0005127
	5/8	J0004962	J0004967	J0004972	J0004977	J0004982
	3/4	J0004817	J0004822	J0004827	J0004832	J0004837
3.50" Ø	1/2	J0005256	J0005261	J0005266	J0005271	J0005276
	9/16	J0005691	J0005696	J0005701	J0005706	J0005711
	5/8	J0005546	J0005551	J0005556	J0005561	J0005566
	3/4	J0005401	J0005406	J0005411	J0005416	J0005421
4.00" Ø	1/2	J0007637	J0007642	J0007647	J0007652	J0007657
	9/16	J0008072	J0008077	J0008082	J0008087	J0008092
	5/8	J0007927	J0007932	J0007937	J0007942	J0007947
	3/4	J0007782	J0007787	J0007792	J0007797	J0007802

**3 Link Axle Tab and Mounting Tab Kits**

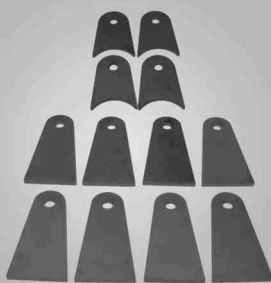

Material: 1/4" carbon steel  
 Straight Tabs are 4" long from base-to-hole  
 Axle Tabs per Kit: 4  
 Straight Tabs per Kit: 8

2.75" Ø	1/2	J0003349	J0003358	J0003367	J0003376	J0003385
	9/16	J0003784	J0003793	J0003802	J0003811	J0003820
	5/8	J0003639	J0003648	J0003657	J0003666	J0003675
	3/4	J0003494	J0003503	J0003512	J0003521	J0003530
3.00" Ø	1/2	J0004631	J0004640	J0004649	J0004658	J0004667
	9/16	J0005066	J0005075	J0005084	J0005093	J0005102
	5/8	J0004921	J0004930	J0004939	J0004948	J0004957
	3/4	J0004776	J0004785	J0004794	J0004803	J0004812
3.50" Ø	1/2	J0005215	J0005224	J0005233	J0005242	J0005251
	9/16	J0005650	J0005659	J0005668	J0005677	J0005686
	5/8	J0005505	J0005514	J0005523	J0005532	J0005541
	3/4	J0005360	J0005369	J0005378	J0005387	J0005396
4.00" Ø	1/2	J0007596	J0007605	J0007614	J0007623	J0007632
	9/16	J0008031	J0008040	J0008049	J0008058	J0008067
	5/8	J0007886	J0007895	J0007904	J0007913	J0007922
	3/4	J0007741	J0007750	J0007759	J0007768	J0007777

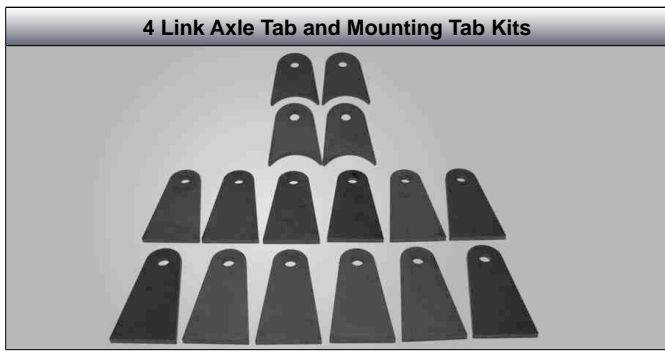

Material: 1/4" carbon steel  
 Straight Tabs are 4" long from base-to-hole  
 Axle Tabs per Kit: 4  
 Straight Tabs per Kit: 12

		Axle Tab Length (inside of radius to center of hole)				
Fits Axle Ø	Bore	2.0"	2.5"	3.0"	3.5"	4.0"
2.75" Ø	1/2	J0003411	J0003418	J0003425	J0003432	J0003439
	9/16	J0003846	J0003853	J0003860	J0003867	J0003874
	5/8	J0003701	J0003708	J0003715	J0003722	J0003729
	3/4	J0003556	J0003563	J0003570	J0003577	J0003584
3.00" Ø	1/2	J0004693	J0004700	J0004707	J0004714	J0004721
	9/16	J0005128	J0005135	J0005142	J0005149	J0005156
	5/8	J0004983	J0004990	J0004997	J0005004	J0005011
	3/4	J0004838	J0004845	J0004852	J0004859	J0004866
3.50" Ø	1/2	J0005277	J0005284	J0005291	J0005298	J0005305
	9/16	J0005712	J0005719	J0005726	J0005733	J0005740
	5/8	J0005567	J0005574	J0005581	J0005588	J0005595
	3/4	J0005422	J0005429	J0005436	J0005443	J0005450
4.00" Ø	1/2	J0007658	J0007665	J0007672	J0007679	J0007686
	9/16	J0008093	J0008100	J0008107	J0008114	J0008121
	5/8	J0007948	J0007955	J0007962	J0007969	J0007976
	3/4	J0007803	J0007810	J0007817	J0007824	J0007831
2.75" Ø	1/2	J0003450	J0003455	J0003460	J0003465	J0003470
	9/16	J0003885	J0003890	J0003895	J0003900	J0003905
	5/8	J0003740	J0003745	J0003750	J0003755	J0003760
	3/4	J0003595	J0003600	J0003605	J0003610	J0003615
3.00" Ø	1/2	J0004732	J0004737	J0004742	J0004747	J0004752
	9/16	J0005167	J0005172	J0005177	J0005182	J0005187
	5/8	J0005022	J0005027	J0005032	J0005037	J0005042
	3/4	J0004877	J0004882	J0004887	J0004892	J0004897
3.50" Ø	1/2	J0005316	J0005321	J0005326	J0005331	J0005336
	9/16	J0005751	J0005756	J0005761	J0005766	J0005771
	5/8	J0005606	J0005611	J0005616	J0005621	J0005626
	3/4	J0005461	J0005466	J0005471	J0005476	J0005481
4.00" Ø	1/2	J0007697	J0007702	J0007707	J0007712	J0007717
	9/16	J0008132	J0008137	J0008142	J0008147	J0008152
	5/8	J0007987	J0007992	J0007997	J0008002	J0008007
	3/4	J0007842	J0007847	J0007852	J0007857	J0007862

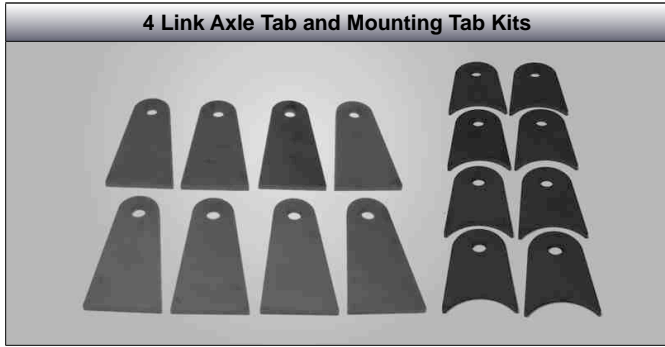

Material: 1/4" carbon steel  
 Straight Tabs are 4" long from base-to-hole  
 Axle Tabs per Kit: 8  
 Straight Tabs per Kit: 8

**4 Link Parallel Tab & Clevis Kits**

Mtrl: 1/4" steel  
 Jaw Dims are inside  
 Straight Tabs 4"  
 Clevises per Kit: 2  
 Straight Tabs/Kit: 4  
 Parallel Tabs/Kit: 4

Axle Ø	2.5" Clevis Jaw				3.0" Clevis Jaw			
	1/2 Bore	9/16 Bore	5/8 Bore	3/4 Bore	1/2 Bore	9/16 Bore	5/8 Bore	3/4 Bore
2.75"	J0003256	J0003313	J0003294	J0003275	J0005786	J0005843	J0005824	J0005805
3.00"	J0003257	J0003314	J0003295	J0003276	J0005787	J0005844	J0005825	J0005806
3.50"	J0003258	J0003315	J0003296	J0003277	J0005788	J0005845	J0005826	J0005807
4.00"	J0003259	J0003316	J0003297	J0003278	J0005789	J0005846	J0005827	J0005808

**4 Link Parallel Tab & Clevis Kits**

Mtrl: 1/4" steel  
 Jaw Dims are inside  
 Clevises per Kit: 4  
 Parallel Tabs/Kit: 4

Axle Ø	2.5" Clevis Jaw				3.0" Clevis Jaw			
	1/2 Bore	9/16 Bore	5/8 Bore	3/4 Bore	1/2 Bore	9/16 Bore	5/8 Bore	3/4 Bore
2.75"	J0003260	J0003317	J0003298	J0003279	J0005790	J0005847	J0005828	J0005809
3.00"	J0003261	J0003318	J0003299	J0003280	J0005791	J0005848	J0005829	J0005810
3.50"	J0003262	J0003319	J0003300	J0003281	J0005792	J0005849	J0005830	J0005811
4.00"	J0003263	J0003320	J0003301	J0003282	J0005793	J0005850	J0005831	J0005812



Material: 1/4" carbon steel

Axle Tab lengths are measured from the center of the hole to the far inside radius. Clevis Jaw Widths are based on the inside dimension.

Axle Tabs per Kit: 4  
Clevises per Kit: 2

2.5" Clevis Jaw - Axle Tab Lengths of...		3.0" Clevis Jaw - Axle Tab Lengths of...									
Axle Ø	Bore	2.0"	2.5"	3.0"	3.5"	4.0"	2.0"	2.5"	3.0"	3.5"	4.0"
2.75"	1/2	J0003326	J0003329	J0003332	J0003335	J0003338	J0003327	J0003330	J0003333	J0003336	J0003339
	9/16	J0003761	J0003764	J0003767	J0003770	J0003773	J0003762	J0003765	J0003768	J0003771	J0003774
	5/8	J0003616	J0003619	J0003622	J0003625	J0003628	J0003617	J0003620	J0003623	J0003626	J0003629
	3/4	J0003471	J0003474	J0003477	J0003480	J0003483	J0003472	J0003475	J0003478	J0003481	J0003484
3.00"	1/2	J0004608	J0004611	J0004614	J0004617	J0004620	J0004609	J0004612	J0004615	J0004618	J0004621
	9/16	J0005043	J0005046	J0005049	J0005052	J0005055	J0005044	J0005047	J0005050	J0005053	J0005056
	5/8	J0004898	J0004901	J0004904	J0004907	J0004910	J0004899	J0004902	J0004905	J0004908	J0004911
	3/4	J0004753	J0004756	J0004759	J0004762	J0004765	J0004754	J0004757	J0004760	J0004763	J0004766
3.50"	1/2	J0005192	J0005195	J0005198	J0005201	J0005204	J0005193	J0005196	J0005199	J0005202	J0005205
	9/16	J0005627	J0005630	J0005633	J0005636	J0005639	J0005628	J0005631	J0005634	J0005637	J0005640
	5/8	J0005482	J0005485	J0005488	J0005491	J0005494	J0005483	J0005486	J0005489	J0005492	J0005495
	3/4	J0005337	J0005340	J0005343	J0005346	J0005349	J0005338	J0005341	J0005344	J0005347	J0005350
4.00"	1/2	J0007573	J0007576	J0007579	J0007582	J0007585	J0007574	J0007577	J0007580	J0007583	J0007586
	9/16	J0008008	J0008011	J0008014	J0008017	J0008020	J0008009	J0008012	J0008015	J0008018	J0008021
	5/8	J0007863	J0007866	J0007869	J0007872	J0007875	J0007864	J0007867	J0007870	J0007873	J0007876
	3/4	J0007718	J0007721	J0007724	J0007727	J0007730	J0007719	J0007722	J0007725	J0007728	J0007731



Material and dimensioning same as above.

Axle Tabs per Kit: 4  
Clevises per Kit: 4

2.75"	1/2	J0003347	J0003356	J0003365	J0003374	J0003383	J0003348	J0003357	J0003366	J0003375	J0003384
	9/16	J0003782	J0003791	J0003800	J0003809	J0003818	J0003783	J0003792	J0003801	J0003810	J0003819
	5/8	J0003637	J0003646	J0003655	J0003664	J0003673	J0003638	J0003647	J0003656	J0003665	J0003674
	3/4	J0003492	J0003501	J0003510	J0003519	J0003528	J0003493	J0003502	J0003511	J0003520	J0003529
3.00"	1/2	J0004629	J0004638	J0004647	J0004656	J0004665	J0004630	J0004639	J0004648	J0004657	J0004666
	9/16	J0005064	J0005073	J0005082	J0005091	J0005100	J0005065	J0005074	J0005083	J0005092	J0005101
	5/8	J0004919	J0004928	J0004937	J0004946	J0004955	J0004920	J0004929	J0004938	J0004947	J0004956
	3/4	J0004774	J0004783	J0004792	J0004801	J0004810	J0004775	J0004784	J0004793	J0004802	J0004811
3.50"	1/2	J0005213	J0005222	J0005231	J0005240	J0005249	J0005214	J0005223	J0005232	J0005241	J0005250
	9/16	J0005648	J0005657	J0005666	J0005675	J0005684	J0005649	J0005658	J0005667	J0005676	J0005685
	5/8	J0005503	J0005512	J0005521	J0005530	J0005539	J0005504	J0005513	J0005522	J0005531	J0005540
	3/4	J0005358	J0005367	J0005376	J0005385	J0005394	J0005359	J0005368	J0005377	J0005386	J0005395
4.00"	1/2	J0007594	J0007603	J0007612	J0007621	J0007630	J0007595	J0007604	J0007613	J0007622	J0007631
	9/16	J0008029	J0008038	J0008047	J0008056	J0008065	J0008030	J0008039	J0008048	J0008057	J0008066
	5/8	J0007884	J0007893	J0007902	J0007911	J0007920	J0007885	J0007894	J0007903	J0007912	J0007921
	3/4	J0007739	J0007748	J0007757	J0007766	J0007775	J0007740	J0007749	J0007758	J0007767	J0007776



Material and dimensioning same as above.

Axle Tabs per Kit: 4  
Clevises per Kit: 6

2.75"	1/2	J0003416	J0003423	J0003430	J0003437	J0003444	J0003417	J0003424	J0003431	J0003438	J0003445
	9/16	J0003851	J0003858	J0003865	J0003872	J0003879	J0003852	J0003859	J0003866	J0003873	J0003880
	5/8	J0003706	J0003713	J0003720	J0003727	J0003734	J0003707	J0003714	J0003721	J0003728	J0003735
	3/4	J0003561	J0003568	J0003575	J0003582	J0003589	J0003562	J0003569	J0003576	J0003583	J0003590
3.00"	1/2	J0004698	J0004705	J0004712	J0004719	J0004726	J0004699	J0004706	J0004713	J0004720	J0004727
	9/16	J0005133	J0005140	J0005147	J0005154	J0005161	J0005134	J0005141	J0005148	J0005155	J0005162
	5/8	J0004988	J0004995	J0005002	J0005009	J0005016	J0004989	J0004996	J0005003	J0005010	J0005017
	3/4	J0004843	J0004850	J0004857	J0004864	J0004871	J0004844	J0004851	J0004858	J0004865	J0004872
3.50"	1/2	J0005282	J0005289	J0005296	J0005303	J0005310	J0005283	J0005290	J0005297	J0005304	J0005311
	9/16	J0005717	J0005724	J0005731	J0005738	J0005745	J0005718	J0005725	J0005732	J0005739	J0005746
	5/8	J0005572	J0005579	J0005586	J0005593	J0005600	J0005573	J0005580	J0005587	J0005594	J0005601
	3/4	J0005427	J0005434	J0005441	J0005448	J0005455	J0005428	J0005435	J0005442	J0005449	J0005456
4.00"	1/2	J0007663	J0007670	J0007677	J0007684	J0007691	J0007664	J0007671	J0007678	J0007685	J0007692
	9/16	J0008098	J0008105	J0008112	J0008119	J0008126	J0008099	J0008106	J0008113	J0008120	J0008127
	5/8	J0007953	J0007960	J0007967	J0007974	J0007981	J0007954	J0007961	J0007968	J0007975	J0007982
	3/4	J0007808	J0007815	J0007822	J0007829	J0007836	J0007809	J0007816	J0007823	J0007830	J0007837



Material: 1/4" carbon steel

Axle Tab lengths are measured from the center of the hole to the far inside radius. Clevis Jaw Widths are based on the inside dimension.

Axle Tabs per Kit: 8  
Clevises per Kit: 4

		2.5" Clevis Jaw - Axle Tab Lengths of...					3.0" Clevis Jaw - Axle Tab Lengths of...				
Axle Ø	Bore	2.0"	2.5"	3.0"	3.5"	4.0"	2.0"	2.5"	3.0"	3.5"	4.0"
2.75"	1/2	J0003448	J0003453	J0003458	J0003463	J0003468	J0003449	J0003454	J0003459	J0003464	J0003469
	9/16	J0003883	J0003888	J0003893	J0003898	J0003903	J0003884	J0003889	J0003894	J0003899	J0003904
	5/8	J0003738	J0003743	J0003748	J0003753	J0003758	J0003739	J0003744	J0003749	J0003754	J0003759
	3/4	J0003593	J0003598	J0003603	J0003608	J0003613	J0003594	J0003599	J0003604	J0003609	J0003614
3.00"	1/2	J0004730	J0004735	J0004740	J0004745	J0004750	J0004731	J0004736	J0004741	J0004746	J0004751
	9/16	J0005165	J0005170	J0005175	J0005180	J0005185	J0005166	J0005171	J0005176	J0005181	J0005186
	5/8	J0005020	J0005025	J0005030	J0005035	J0005040	J0005021	J0005026	J0005031	J0005036	J0005041
	3/4	J0004875	J0004880	J0004885	J0004890	J0004895	J0004876	J0004881	J0004886	J0004891	J0004896
3.50"	1/2	J0005314	J0005319	J0005324	J0005329	J0005334	J0005315	J0005320	J0005325	J0005330	J0005335
	9/16	J0005749	J0005754	J0005759	J0005764	J0005769	J0005750	J0005755	J0005760	J0005765	J0005770
	5/8	J0005604	J0005609	J0005614	J0005619	J0005624	J0005605	J0005610	J0005615	J0005620	J0005625
	3/4	J0005459	J0005464	J0005469	J0005474	J0005479	J0005460	J0005465	J0005470	J0005475	J0005480
4.00"	1/2	J0007695	J0007700	J0007705	J0007710	J0007715	J0007696	J0007701	J0007706	J0007711	J0007716
	9/16	J0008130	J0008135	J0008140	J0008145	J0008150	J0008131	J0008136	J0008141	J0008146	J0008151
	5/8	J0007985	J0007990	J0007995	J0008000	J0008005	J0007986	J0007991	J0007996	J0008001	J0008006
	3/4	J0007840	J0007845	J0007850	J0007855	J0007860	J0007841	J0007846	J0007851	J0007856	J0007861



Material and dimensioning same as above.

Straight Tabs are 4" Long as measured from base to center of the eye.

Axle Tabs per Kit: 4  
Clevises per Kit: 2  
Straight Tabs per Kit: 4

2.75"	1/2	J0003343	J0003352	J0003361	J0003370	J0003379	J0003344	J0003353	J0003362	J0003371	J0003380
	9/16	J0003778	J0003787	J0003796	J0003805	J0003814	J0003779	J0003788	J0003797	J0003806	J0003815
	5/8	J0003633	J0003642	J0003651	J0003660	J0003669	J0003634	J0003643	J0003652	J0003661	J0003670
	3/4	J0003488	J0003497	J0003506	J0003515	J0003524	J0003489	J0003498	J0003507	J0003516	J0003525
3.00"	1/2	J0004625	J0004634	J0004643	J0004652	J0004661	J0004624	J0004633	J0004642	J0004651	J0004660
	9/16	J0005060	J0005069	J0005078	J0005087	J0005096	J0005061	J0005070	J0005079	J0005088	J0005097
	5/8	J0004915	J0004924	J0004933	J0004942	J0004951	J0004916	J0004925	J0004934	J0004943	J0004952
	3/4	J0004770	J0004779	J0004788	J0004797	J0004806	J0004771	J0004780	J0004789	J0004798	J0004807
3.50"	1/2	J0005209	J0005218	J0005227	J0005236	J0005245	J0005210	J0005219	J0005228	J0005237	J0005246
	9/16	J0005644	J0005653	J0005662	J0005671	J0005680	J0005645	J0005654	J0005663	J0005672	J0005681
	5/8	J0005499	J0005508	J0005517	J0005526	J0005535	J0005500	J0005509	J0005518	J0005527	J0005536
	3/4	J0005354	J0005363	J0005372	J0005381	J0005390	J0005355	J0005364	J0005373	J0005382	J0005391
4.00"	1/2	J0007590	J0007599	J0007608	J0007617	J0007626	J0007591	J0007600	J0007609	J0007618	J0007627
	9/16	J0008025	J0008034	J0008043	J0008052	J0008061	J0008026	J0008035	J0008044	J0008053	J0008062
	5/8	J0007880	J0007889	J0007898	J0007907	J0007916	J0007881	J0007900	J0007899	J0007908	J0007917
	3/4	J0007735	J0007744	J0007753	J0007762	J0007771	J0007736	J0007745	J0007754	J0007763	J0007772



Material and dimensioning same as above.

Axle Tabs per Kit: 6  
Clevises per Kit: 2  
Straight Tabs per Kit: 2

2.75"	1/2	J0003388	J0003393	J0003398	J0003403	J0003408	J0003389	J0003394	J0003399	J0003404	J0003407
	9/16	J0003823	J0003828	J0003833	J0003838	J0003843	J0003824	J0003829	J0003834	J0003839	J0003844
	5/8	J0003678	J0003683	J0003688	J0003693	J0003698	J0003679	J0003684	J0003689	J0003694	J0003699
	3/4	J0003533	J0003538	J0003543	J0003548	J0003553	J0003534	J0003539	J0003544	J0003549	J0003554
3.00"	1/2	J0004670	J0004675	J0004680	J0004685	J0004690	J0004671	J0004676	J0004681	J0004686	J0004691
	9/16	J0005105	J0005110	J0005115	J0005120	J0005125	J0005106	J0005111	J0005116	J0005121	J0005126
	5/8	J0004960	J0004965	J0004970	J0004975	J0004980	J0004961	J0004966	J0004971	J0004976	J0004981
	3/4	J0004815	J0004820	J0004825	J0004830	J0004835	J0004816	J0004821	J0004826	J0004831	J0004836
3.50"	1/2	J0005254	J0005259	J0005264	J0005269	J0005274	J0005255	J0005260	J0005265	J0005270	J0005275
	9/16	J0005689	J0005694	J0005699	J0005704	J0005709	J0005690	J0005695	J0005700	J0005705	J0005710
	5/8	J0005544	J0005549	J0005554	J0005559	J0005564	J0005545	J0005550	J0005555	J0005560	J0005565
	3/4	J0005399	J0005404	J0005409	J0005414	J0005419	J0005400	J0005405	J0005410	J0005415	J0005420
4.00"	1/2	J0007635	J0007640	J0007645	J0007650	J0007655	J0007636	J0007641	J0007646	J0007651	J0007656
	9/16	J0008070	J0008075	J0008080	J0008085	J0008090	J0008071	J0008076	J0008081	J0008086	J0008091
	5/8	J0007925	J0007930	J0007935	J0007940	J0007945	J0007926	J0007931	J0007936	J0007941	J0007946
	3/4	J0007780	J0007785	J0007790	J0007795	J0007800	J0007781	J0007786	J0007791	J0007796	J0007801





Material: 1/4" carbon steel  
 Straight Tabs are 4" Long as measured from base to center of the eye.  
 Axle Tab lengths are measured from the center of the hole to the far inside radius.  
 Clevis Jaw Widths are based on the inside dimension.

Axle Tabs per Kit: 4  
 Clevises per Kit: 3  
 Straight Tabs per Kit: 2

		2.5" Clevis Jaw - Axle Tab Lengths of...					3.0" Clevis Jaw - Axle Tab Lengths of...				
Axle Ø	Bore	2.0"	2.5"	3.0"	3.5"	4.0"	2.0"	2.5"	3.0"	3.5"	4.0"
2.75"	1/2	J0003345	J0003354	J0003363	J0003372	J0003381	J0003346	J0003355	J0003364	J0003373	J0003382
	9/16	J0003780	J0003789	J0003798	J0003807	J0003816	J0003781	J0003790	J0003799	J0003808	J0003817
	5/8	J0003635	J0003644	J0003653	J0003662	J0003671	J0003636	J0003645	J0003654	J0003663	J0003672
	3/4	J0003490	J0003499	J0003508	J0003517	J0003526	J0003491	J0003500	J0003509	J0003518	J0003527
3.00"	1/2	J0004627	J0004636	J0004645	J0004654	J0004663	J0004628	J0004637	J0004646	J0004655	J0004664
	9/16	J0005062	J0005071	J0005080	J0005089	J0005098	J0005063	J0005072	J0005081	J0005090	J0005099
	5/8	J0004917	J0004926	J0004935	J0004944	J0004953	J0004918	J0004927	J0004936	J0004945	J0004954
	3/4	J0004772	J0004781	J0004790	J0004799	J0004808	J0004773	J0004782	J0004791	J0004800	J0004809
3.50"	1/2	J0005211	J0005220	J0005229	J0005238	J0005247	J0005212	J0005221	J0005230	J0005239	J0005248
	9/16	J0005646	J0005655	J0005664	J0005673	J0005682	J0005647	J0005656	J0005665	J0005674	J0005683
	5/8	J0005501	J0005510	J0005519	J0005528	J0005537	J0005502	J0005511	J0005520	J0005529	J0005538
	3/4	J0005356	J0005365	J0005374	J0005383	J0005392	J0005357	J0005366	J0005375	J0005384	J0005393
4.00"	1/2	J0007592	J0007601	J0007610	J0007619	J0007628	J0007593	J0007602	J0007611	J0007620	J0007629
	9/16	J0008027	J0008036	J0008045	J0008054	J0008063	J0008028	J0008037	J0008046	J0008055	J0008064
	5/8	J0007882	J0007891	J0007900	J0007909	J0007918	J0007883	J0007892	J0007901	J0007910	J0007919
	3/4	J0007737	J0007746	J0007755	J0007764	J0007773	J0007738	J0007747	J0007756	J0007765	J0007774



Material and dimensioning same as above.

Axle Tabs per Kit: 4  
 Clevises per Kit: 1  
 Straight Tabs per Kit: 6

2.75"	1/2	J0003341	J0003350	J0003359	J0003368	J0003377	J0003342	J0003351	J0003360	J0003369	J0003378
	9/16	J0003776	J0003785	J0003794	J0003803	J0003812	J0003777	J0003786	J0003795	J0003804	J0003813
	5/8	J0003631	J0003640	J0003649	J0003658	J0003667	J0003632	J0003641	J0003650	J0003659	J0003668
	3/4	J0003486	J0003495	J0003504	J0003513	J0003522	J0003487	J0003496	J0003505	J0003514	J0003523
3.00"	1/2	J0004623	J0004632	J0004641	J0004650	J0004659	J0004624	J0004633	J0004642	J0004651	J0004660
	9/16	J0005058	J0005067	J0005076	J0005085	J0005094	J0005059	J0005068	J0005077	J0005086	J0005095
	5/8	J0004913	J0004922	J0004931	J0004940	J0004949	J0004914	J0004923	J0004932	J0004941	J0004950
	3/4	J0004768	J0004777	J0004786	J0004795	J0004804	J0004769	J0004778	J0004787	J0004796	J0004805
3.50"	1/2	J0005207	J0005216	J0005225	J0005234	J0005243	J0005208	J0005217	J0005226	J0005235	J0005244
	9/16	J0005642	J0005651	J0005660	J0005669	J0005678	J0005643	J0005652	J0005661	J0005670	J0005679
	5/8	J0005497	J0005506	J0005515	J0005524	J0005533	J0005498	J0005507	J0005516	J0005525	J0005534
	3/4	J0005352	J0005361	J0005370	J0005379	J0005388	J0005353	J0005362	J0005371	J0005380	J0005389
4.00"	1/2	J0007588	J0007597	J0007606	J0007615	J0007624	J0007589	J0007598	J0007607	J0007616	J0007625
	9/16	J0008023	J0008032	J0008041	J0008050	J0008059	J0008024	J0008033	J0008042	J0008051	J0008060
	5/8	J0007878	J0007887	J0007896	J0007905	J0007914	J0007879	J0007888	J0007897	J0007906	J0007915
	3/4	J0007733	J0007742	J0007751	J0007760	J0007769	J0007734	J0007743	J0007752	J0007761	J0007770



Material and dimensioning same as above.

Axle Tabs per Kit: 6  
 Clevises per Kit: 1  
 Straight Tabs per Kit: 4

2.75"	1/2	J0003386	J0003391	J0003396	J0003401	J0003406	J0003387	J0003392	J0003397	J0003402	J0003407
	9/16	J0003821	J0003826	J0003831	J0003836	J0003841	J0003822	J0003827	J0003832	J0003837	J0003842
	5/8	J0003676	J0003681	J0003686	J0003691	J0003696	J0003677	J0003682	J0003687	J0003692	J0003697
	3/4	J0003531	J0003536	J0003541	J0003546	J0003551	J0003532	J0003537	J0003542	J0003547	J0003552
3.00"	1/2	J0004668	J0004673	J0004678	J0004683	J0004688	J0004669	J0004674	J0004679	J0004684	J0004689
	9/16	J0005103	J0005108	J0005113	J0005118	J0005123	J0005104	J0005109	J0005114	J0005119	J0005124
	5/8	J0004958	J0004963	J0004968	J0004973	J0004978	J0004959	J0004964	J0004969	J0004974	J0004979
	3/4	J0004813	J0004818	J0004823	J0004828	J0004833	J0004814	J0004819	J0004824	J0004829	J0004834
3.50"	1/2	J0005252	J0005257	J0005262	J0005267	J0005272	J0005253	J0005258	J0005263	J0005268	J0005273
	9/16	J0005687	J0005692	J0005697	J0005702	J0005707	J0005688	J0005693	J0005698	J0005703	J0005708
	5/8	J0005542	J0005547	J0005552	J0005557	J0005562	J0005543	J0005548	J0005553	J0005558	J0005563
	3/4	J0005397	J0005402	J0005407	J0005412	J0005417	J0005398	J0005403	J0005408	J0005413	J0005418
4.00"	1/2	J0007633	J0007638	J0007643	J0007648	J0007653	J0007634	J0007639	J0007644	J0007649	J0007654
	9/16	J0008068	J0008073	J0008078	J0008083	J0008088	J0008069	J0008074	J0008079	J0008084	J0008089
	5/8	J0007923	J0007928	J0007933	J0007938	J0007943	J0007924	J0007929	J0007934	J0007939	J0007944
	3/4	J0007778	J0007783	J0007788	J0007793	J0007798	J0007779	J0007784	J0007789	J0007794	J0007799





Material: 1/4" carbon steel  
 Straight Tabs are 4" Long as measured from base to center of the eye.  
 Axle Tab lengths are measured from the center of the hole to the far inside radius.  
 Clevis Jaw Widths are based on the inside dimension.

Axle Tabs per Kit: 4  
 Clevises per Kit: 2  
 Straight Tabs per Kit: 8

4 Link Tab & Clevis Kit		2.5" Clevis Jaw - Axle Tab Lengths of...					3.0" Clevis Jaw - Axle Tab Lengths of...				
Axle Ø	Bore	2.0"	2.5"	3.0"	3.5"	4.0"	2.0"	2.5"	3.0"	3.5"	4.0"
2.75"	1/2	J0003412	J0003419	J0003426	J0003433	J0003440	J0003413	J0003420	J0003427	J0003434	J0003441
	9/16	J0003847	J0003854	J0003861	J0003868	J0003875	J0003848	J0003855	J0003862	J0003869	J0003876
	5/8	J0003702	J0003709	J0003716	J0003723	J0003730	J0003703	J0003710	J0003717	J0003724	J0003731
	3/4	J0003557	J0003564	J0003571	J0003578	J0003585	J0003558	J0003565	J0003572	J0003579	J0003586
3.00"	1/2	J0004694	J0004701	J0004708	J0004715	J0004722	J0004695	J0004702	J0004709	J0004716	J0004723
	9/16	J0005129	J0005136	J0005143	J0005150	J0005157	J0005130	J0005137	J0005144	J0005151	J0005158
	5/8	J0004984	J0004991	J0004998	J0005005	J0005012	J0004985	J0004992	J0004999	J0005006	J0005013
	3/4	J0004839	J0004846	J0004853	J0004860	J0004867	J0004840	J0004847	J0004854	J0004861	J0004868
3.50"	1/2	J0005278	J0005285	J0005292	J0005299	J0005306	J0005279	J0005286	J0005293	J0005300	J0005307
	9/16	J0005713	J0005720	J0005727	J0005734	J0005741	J0005714	J0005721	J0005728	J0005735	J0005742
	5/8	J0005568	J0005575	J0005582	J0005589	J0005596	J0005569	J0005576	J0005583	J0005590	J0005597
	3/4	J0005423	J0005430	J0005437	J0005444	J0005451	J0005424	J0005431	J0005438	J0005445	J0005452
4.00"	1/2	J0007659	J0007666	J0007673	J0007680	J0007687	J0007660	J0007667	J0007674	J0007681	J0007688
	9/16	J0008094	J0008101	J0008108	J0008115	J0008122	J0008095	J0008102	J0008109	J0008116	J0008123
	5/8	J0007949	J0007956	J0007963	J0007970	J0007977	J0007950	J0007957	J0007964	J0007971	J0007978
	3/4	J0007804	J0007811	J0007818	J0007825	J0007832	J0007805	J0007812	J0007819	J0007826	J0007833



Material and dimensioning same as above.

Axle Tabs per Kit: 4  
 Clevises per Kit: 4  
 Straight Tabs per Kit: 4

2.75"	1/2	J0003414	J0003421	J0003428	J0003435	J0003442	J0003415	J0003422	J0003429	J0003436	J0003443
	9/16	J0003849	J0003856	J0003863	J0003870	J0003877	J0003850	J0003857	J0003864	J0003871	J0003878
	5/8	J0003704	J0003711	J0003718	J0003725	J0003732	J0003705	J0003712	J0003719	J0003726	J0003733
	3/4	J0003559	J0003566	J0003573	J0003580	J0003587	J0003560	J0003567	J0003574	J0003581	J0003588
3.00"	1/2	J0004696	J0004703	J0004710	J0004717	J0004724	J0004697	J0004704	J0004711	J0004718	J0004725
	9/16	J0005131	J0005138	J0005145	J0005152	J0005159	J0005132	J0005139	J0005146	J0005153	J0005160
	5/8	J0004986	J0004993	J0005000	J0005007	J0005014	J0004987	J0004994	J0005001	J0005008	J0005015
	3/4	J0004841	J0004848	J0004855	J0004862	J0004869	J0004842	J0004849	J0004856	J0004863	J0004870
3.50"	1/2	J0005280	J0005287	J0005294	J0005301	J0005308	J0005281	J0005288	J0005295	J0005302	J0005309
	9/16	J0005715	J0005722	J0005729	J0005736	J0005743	J0005716	J0005723	J0005730	J0005737	J0005744
	5/8	J0005570	J0005577	J0005584	J0005591	J0005598	J0005571	J0005578	J0005585	J0005592	J0005599
	3/4	J0005425	J0005432	J0005439	J0005446	J0005453	J0005426	J0005433	J0005440	J0005447	J0005454
4.00"	1/2	J0007661	J0007668	J0007675	J0007682	J0007689	J0007662	J0007669	J0007676	J0007683	J0007690
	9/16	J0008096	J0008103	J0008110	J0008117	J0008124	J0008097	J0008104	J0008111	J0008118	J0008125
	5/8	J0007951	J0007958	J0007965	J0007972	J0007979	J0007952	J0007959	J0007966	J0007973	J0007980
	3/4	J0007806	J0007813	J0007820	J0007827	J0007834	J0007807	J0007814	J0007821	J0007828	J0007835



Material and dimensioning same as above.

Axle Tabs per Kit: 8  
 Clevises per Kit: 2  
 Straight Tabs per Kit: 4

2.75"	1/2	J0003446	J0003451	J0003456	J0003461	J0003466	J0003447	J0003452	J0003457	J0003462	J0003467
	9/16	J0003881	J0003886	J0003891	J0003896	J0003901	J0003882	J0003887	J0003892	J0003897	J0003902
	5/8	J0003736	J0003741	J0003746	J0003751	J0003756	J0003737	J0003742	J0003747	J0003752	J0003757
	3/4	J0003591	J0003596	J0003601	J0003606	J0003611	J0003592	J0003597	J0003602	J0003607	J0003612
3.00"	1/2	J0004728	J0004733	J0004738	J0004743	J0004748	J0004729	J0004734	J0004739	J0004744	J0004749
	9/16	J0005163	J0005168	J0005173	J0005178	J0005183	J0005164	J0005169	J0005174	J0005179	J0005184
	5/8	J0005018	J0005023	J0005028	J0005033	J0005038	J0005019	J0005024	J0005029	J0005034	J0005039
	3/4	J0004873	J0004878	J0004883	J0004888	J0004893	J0004874	J0004879	J0004884	J0004889	J0004894
3.50"	1/2	J0005312	J0005317	J0005322	J0005327	J0005332	J0005313	J0005318	J0005323	J0005328	J0005333
	9/16	J0005747	J0005752	J0005757	J0005762	J0005767	J0005748	J0005753	J0005758	J0005763	J0005768
	5/8	J0005602	J0005607	J0005612	J0005617	J0005622	J0005603	J0005608	J0005613	J0005618	J0005623
	3/4	J0005457	J0005462	J0005467	J0005472	J0005477	J0005458	J0005463	J0005468	J0005473	J0005478
4.00"	1/2	J0007693	J0007698	J0007703	J0007708	J0007713	J0007694	J0007699	J0007704	J0007709	J0007714
	9/16	J0008128	J0008133	J0008138	J0008143	J0008148	J0008129	J0008134	J0008139	J0008144	J0008149
	5/8	J0007983	J0007988	J0007993	J0007998	J0008003	J0007984	J0007989	J0007994	J0007999	J0008004
	3/4	J0007838	J0007843	J0007848	J0007853	J0007858	J0007839	J0007844	J0007849	J0007854	J0007859

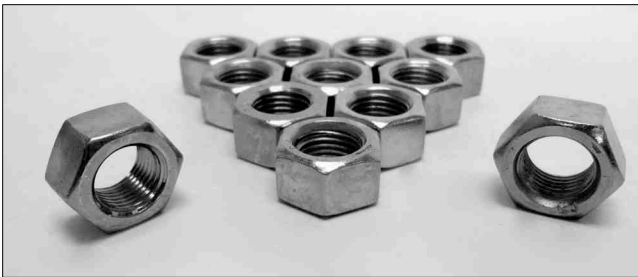

## Nuts - Bulk

Steinjäger offers hundreds of different thread, material and finish options with bulk packaged nuts. Only a partial listing is shown here.

### Key

ZC = plated zinc clear

ZY = plated zinc yellow

Description	Part#	Qty
M4 x 0.70 RH Jam Class 4 ZC	J0014423	10
M5 x 0.80 RH Jam Class 4 ZC	J0014425	100
M5 x 0.80 RH Jam Stainless Steel	J0014426	25
M6 x 1.00 RH Jam Class 4 ZC	J0014430	100
M6 x 1.00 RH Jam Class 10 ZY	J0014428	100
M6 x 1.00 RH Jam Stainless Steel	J0014432	50
M6 x 1.00 LH Jam Class 4 ZC	J0014432	50
M8 x 1.25 RH Jam Class 4 ZC	J0014446	50
M8 x 1.25 RH Jam Class 10 ZC	J0014444	50
M8 x 1.25 RH Jam Class 10 ZY	J0014445	50
M8 x 1.25 RH Stainless Steel	J0014443	25
M8 x 1.25 LH Jam Class 4 ZC	J0014435	50
M8 x 1.25 LH Jam Class 4 ZY	J0014436	50
M10 x 1.50 RH Jam Class 4 ZC	J0014397	50
M10 x 1.50 RH Jam Class 4 ZY	J0014400	50
M10 x 1.50 RH Jam Class 8 ZY	J0014401	50
M10 x 1.50 RH Stainless Steel	J0014395	10
M10 x 1.50 LH Jam Class 4 ZC	J0014392	100
M10 x 1.50 LH Jam Class 4 ZY	J0014394	25
M12 x 1.25 RH Jam Class 4 ZY	J0014402	10
M12 x 1.50 RH Jam Class 4 ZY	J0014404	10
M12 x 1.75 RH Jam Class 4 ZC	J0014409	10
M12 x 1.75 RH Jam Stainless Steel	J0014410	10
M12 x 1.75 LH Jam Class 4 ZY	J0014405	10
M12 x 1.75 LH Jam Stainless Steel	J0014406	10
M14 x 1.50 RH Jam Class 4 ZC	J0014412	10
M16 x 1.50 RH Jam Class 4 ZC	J0014414	10
M16 x 2.00 RH Jam Class 4 ZC	J0014417	10
M18 x 1.50 RH Jam Class 4 ZC	J0014418	20
M20 x 1.50 RH Jam Class 4 ZC	J0014421	5
M20 x 1.50 RH Jam Class 4 ZC	J0014420	10
M20 x 1.50 LH Jam Class 4 ZY	J0014419	10
M22 x 1.50 RH Jam Class 4 ZC	J0014422	10
10-32 RH Jam Grade 2 ZC	J0014306	100
10-32 RH Jam Grade 2 ZY	J0014307	100
10-32 RH Jam Aluminum	J0014305	100
10-32 RH Jam Stainless Steel	J0014308	100

Description	Part#	Qty
10-32 LH Jam Grade 2 ZY	J0014303	10
1/4-20 RH Jam Grade 8 ZY	J0014286	100
1/4-20 RH Jam Stainless Steel	J0014287	100
1/4-28 RH Jam Grade 2 ZC	J0014296	100
1/4-28 RH Jam Grade 2 ZY	J0014297	100
1/4-28 RH Jam Chrome Plated	J0014294	10
1/4-28 RH Jam Stainless Steel	J0014298	25
1/4-28 RH Full Grade 5 ZY	J0014295	100
1/4-28 LH Jam Grade 5 ZC	J0014290	100
1/4-28 LH Jam Grade 2 ZY	J0014289	100
1/4-28 LH Full Grade 2 ZY	J0014288	100
5/16-18 RH Jam Grade 2 ZY	J0014345	100
5/16-24 RH Jam Grade 2 ZC	J0014353	100
5/16-24 RH Jam Chrome Plated	J0014352	10
5/16-24 RH Jam Stainless Steel	J0014354	100
5/16-24 LH Jam Grade 2 ZC	J0014347	100
5/16-24 LH Jam Grade 2 ZY	J0014348	100
5/16-24 LH Jam Grade 5 ZY	J0014349	100
3/8-16 RH Jam Grade 2 ZY	J0014328	10
3/8-24 RH Jam Grade 2 ZC	J0014342	50
3/8-24 RH Jam Grade 2 ZY	J0014344	75
3/8-24 RH Jam Chrome Plated	J0014336	10
3/8-24 RH Lock Grade 2 ZY	J0014337	100
3/8-24 LH Jam Grade 2 ZC	J0014334	50
3/8-24 LH Jam Grade 2 ZY	J0014335	75
3/8-24 LH Jam Stainless Steel	J0014329	10
7/16-20 RH Jam Grade 2 ZC	J0014381	100
7/16-20 RH Jam Grade 2 ZY	J0014382	100
7/16-20 RH Jam Stainless Steel	J0014380	10
7/16-20 LH Jam Grade 2 ZC	J0014378	10
1/2-13 RH Jam Grade 5 ZY	J0014271	100
1/2-20 RH Jam Grade 2 ZC	J0014279	100
1/2-20 RH Jam Grade 5 ZY	J0014280	100
1/2-20 RH Jam Chrome Plated	J0014277	10
1/2-20 RH Jam Stainless Steel	J0014281	20
1/2-20 RH Full Grade 5 ZY	J0014278	100
1/2-20 LH Jam Grade 2 ZC	J0014273	100

Description	Part#	Qty
1/2-20 LH Jam Grade 2 ZY	J0014270	10
1/2-20 LH Jam Grade 5 ZC	J0014272	10
9/16-12 LH Jam Grade 2 ZY	J0014391	10
5/8-11 RH Jam Grade 2 ZY	J0014361	50
5/8-11 RH Jam Stainless Steel	J0014360	10
5/8-18 RH Jam Grade 2 ZC	J0014368	10
5/8-18 RH Jam Grade 2 ZY	J0014377	50
5/8-18 RH Jam Chrome Plated	J0014374	25
5/8-18 RH Stainless Steel	J0014369	10
5/8-18 RH Full Grade 5 ZY	J0014373	25
5/8-18 LH Jam Grade 5 ZC	J0014362	10
5/8-18 LH Jam Grade 2 ZY	J0014367	50
5/8-18 LH Jam Chrome Plated	J0014365	25
11/16-16 RH Jam Grade 2 ZY	J0014310	10
3/4-10 RH Jam Grade 2 ZY	J0014313	25
3/4-10 RH Jam Stainless Steel	J0014314	5
3/4-10 LH Jam Grade 2 ZY	J0014312	25
3/4-16 RH Jam Grade 2 ZC	J0014320	10
3/4-16 RH Jam Grade 2 ZY	J0014321	20
3/4-16 RH Jam Stainless Steel	J0014327	5
3/4-16 LH Jam Grade 5 ZC	J0014315	10
3/4-16 LH Jam Grade 2 ZY	J0014316	25
7/8-14 RH Jam Grade 2 ZC	J0014388	12
7/8-14 RH Jam Stainless Steel	J0014389	2
7/8-14 LH Jam Grade 2 ZC	J0014385	12
1"-8 RH Jam Grade 5 ZY	J0014269	8
1"-12 RH Jam Grade 2 ZC	J0014262	2
1"-14 RH Jam Grade 2 ZC	J0014264	12
1"-14 RH Jam Grade 2 ZY	J0014267	8
1"-14 RH Jam Stainless Steel	J0014265	2
1"-14 LH Jam Grade 2 ZC	J0014263	12
1.25"-12 RH Jam Grade 5 ZC	J0014254	4
1.25"-12 RH Jam Grade 5 ZY	J0014255	4
1.25"-12 LH Jam Grade 5 ZC	J0014248	4
1.25"-12 LH Jam Grade 5 ZY	J0014249	4
1.375"-12 RH Jam Grade 5 ZC	J0014258	4
1.50"-12 RH Jam Grade 5 ZY	J0014259	4

### Universal Sway Bar End Link Kits - 3/8"



Black Power Painted Option

End Link Kits comes as a set which includes two tubes, four rod ends, and all attaching hardware. Choose from steel or aluminum tubes, black or chromed finishes, and standard (PTFE) or heavy duty chrome moly nylon raced rod ends. End Links are double adjustable to  $\pm 0.46"$  of nominal lengths.



Bright Chrome Plated Option

Length	Steel Rod Ends with PTFE Bearing				Chrome Moly Rod Ends			
	Steel Tube		Aluminum Tube		Steel Tube		Aluminum Tube	
	Black Powder Painted	Bright Chrome Plated	Black Powder Painted	Bright Chrome Plated	Black Powder Painted	Bright Chrome Plated	Black Powder Painted	Bright Chrome Plated
5.25" Long	J0014084	J0014085	J0013995	J0013996	J0014129	J0014130	J0014039	J0014040
6.25" Long	J0014086	J0014087	J0013997	J0013998	J0014131	J0014132	J0014041	J0014042
7.25" Long	J0014088	J0014089	J0013999	J0013400	J0014133	J0014134	J0014043	J0014044
8.25" Long	J0014090	J0014091	J0014001	J0013402	J0014135	J0014136	J0014045	J0014046
9.25" Long	J0014092	J0014093	J0014003	J0013404	J0014137	J0014138	J0014047	J0014048
10.25" Long	J0014094	J0014095	J0014005	J0013406	J0014139	J0014140	J0014049	J0014050
11.25" Long	J0014096	J0014097	J0014007	J0013408	J0014141	J0014142	J0014051	J0014052
12.25" Long	J0014098	J0014099	J0014009	J0013410	J0014143	J0014144	J0014053	J0014054
13.25" Long	J0014100	J0014101	J0014011	J0013412	J0014145	J0014146	J0014055	J0014056
14.25" Long	J0014102	J0014103	J0014013	J0013414	J0014147	J0014148	J0014057	J0014058
15.25" Long	J0014104	J0014105	J0014015	J0013416	J0014149	J0014150	J0014059	J0014060
16.25" Long	J0014106	J0014107	J0014017	J0013418	J0014151	J0014152	J0014061	J0014062
17.25" Long	J0014108	J0014109	J0014019	J0013420	J0014153	J0014154	J0014063	J0014064
18.25" Long	J0014110	J0014111	J0014021	J0013422	J0014155	J0014156	J0014065	J0014066
19.25" Long	J0014112	J0014113	J0014023	J0013424	J0014157	J0014158	J0014067	J0014068
20.25" Long	J0014114	J0014115	J0014025	J0013426	J0014159	J0014160	J0014069	J0014070
21.25" Long	J0014116	J0014117	J0014027	J0013428	J0014161	J0014162	J0014071	J0014072
22.25" Long	J0014118	J0014119	J0014029	J0013430	J0014163	J0014164	J0014073	J0014074
23.25" Long	J0014120	J0014121	J0014031	J0013432	J0014165	J0014166	J0014075	J0014076
24.25" Long	J0014122	J0014123	J0014033	J0013434	J0014167	J0014168	J0014077	J0014078
25.25" Long	J0014124	J0014125	J0014035	J0013436	J0014169	J0014170	J0014079	J0014080
26.25" Long	J0014126	J0014127	J0014037	J0013438	J0014171	J0014172	J0014081	J0014082

### Sway Bar End Links - Short Universal Adjustable



Lengths are based on center-to-center lengths from rod end bore to rod end bore. Chrome Moly rod ends are 4130 Heat Treated Chrome Moly with a slotted nylon race. Standard rod ends are zinc plated with a PTFE race.

Bore	Length	Standard Rod Ends	Chrome Moly Rod Ends
3/8"	2.75"	J0014083	J0014128
1/2"	3.50"	J0013319	J0013362
10mm	73mm	J0013520	J0013618
10mm	99mm	J0013521	J0013619
12mm	84mm	J0013775	J0013873
12mm	109mm	J0013776	J0013874



**Universal Sway Bar End Link Kits - 1/2"**



Black Power Painted Option

End Link Kits comes as a set which includes two tubes, four rod ends, and all attaching hardware. Choose from steel or aluminum tubes, black or chromed finishes, and standard (PTFE) or heavy duty chrome moly nylon raced rod ends. End Links are double adjustable to  $\pm 0.43"$  of nominal lengths.



Bright Chrome Plated Option

Length	Steel Rod Ends with PTFE Bearing				Chrome Moly Rod Ends			
	Steel Tube		Aluminum Tube		Steel Tube		Aluminum Tube	
	Black Powder Painted	Bright Chrome Plated	Black Powder Painted	Bright Chrome Plated	Black Powder Painted	Bright Chrome Plated	Black Powder Painted	Bright Chrome Plated
6" Long	J0013354	J0013355	-	-	-	-	J0013311	J0013312
7" Long	J0013356	J0013357	J0013273	J0013274	J0013397	J0013398	J0013313	J0013314
8" Long	J0013358	J0013359	J0013275	J0013276	J0013399	J0013400	J0013315	J0013316
9" Long	J0013360	J0013361	J0013277	J0013278	J0013401	J0013402	J0013317	J0013318
10" Long	J0013320	J0013321	J0013279	J0013280	J0013403	J0013404	J0013281	J0013282
11" Long	J0013322	J0013323	J0013243	J0013244	J0013363	J0013364	J0013283	J0013284
12" Long	J0013324	J0013325	J0013245	J0013246	J0013365	J0013366	J0013285	J0013286
13" Long	J0013326	J0013327	J0013247	J0013248	J0013367	J0013368	J0013287	J0013288
14" Long	J0013328	J0013329	J0013249	J0013250	J0013369	J0013370	J0013289	J0013290
15" Long	J0013330	J0013331	J0013251	J0013252	J0013371	J0013372	J0013291	J0013292
16" Long	J0013332	J0013333	J0013253	J0013254	J0013373	J0013374	J0013293	J0013294
17" Long	J0013334	J0013335	J0013255	J0013256	J0013375	J0013376	J0013295	J0013296
18" Long	J0013336	J0013337	J0013257	J0013258	J0013377	J0013378	J0013297	J0013298
19" Long	J0013338	J0013339	J0013259	J0013260	J0013379	J0013380	J0013299	J0013300
20" Long	J0013340	J0013341	J0013261	J0013262	J0013381	J0013382	J0013301	J0013302
21" Long	J0013342	J0013343	J0013263	J0013264	J0013383	J0013384	J0013303	J0013304
22" Long	J0013344	J0013345	J0013265	J0013266	J0013385	J0013386	J0013305	J0013306
23" Long	J0013346	J0013347	J0013267	J0013268	J0013387	J0013388	J0013307	J0013308
24" Long	J0013348	J0013349	J0013269	J0013270	J0013389	J0013390	J0013309	J0013310
25" Long	J0013350	J0013351	J0013271	J0013272	J0013391	J0013392	-	-
26" Long	J0013352	J0013353	-	-	J0013393	J0013394	-	-
27" Long	-	-	-	-	J0013395	J0013396	-	-

**Rod End Kits**



Pages 8-11

**Cut Tubes**



Pages 32-33

**Contract Manufacturing**



Contact Us

**Double Adjustable Poly Assys**



Pages 24-29

**Unibal Kits**



Pages 12-13

**Private Labeling**



Contact Us

**End Link Kits**



Pages 48-59

**Bulk Unibals**



Page 12

### Universal Sway Bar End Link Kits - 10mm

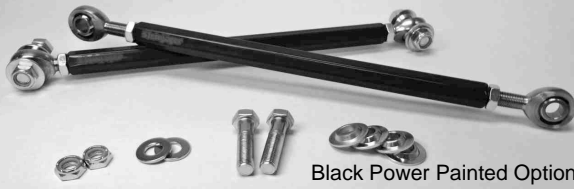

Black Power Painted Option

End Link Kits comes as a set which includes two tubes, four rod ends, and all attaching hardware. Choose from steel or aluminum tubes, black or chromed finishes, and standard (PTFE) or heavy duty chrome moly nylon raced rod ends. End Links are double adjustable to  $\pm 9$ mm of nominal lengths. Threads are M10 x 1.50.



Bright Chrome Plated Option

Length in millimeters	Steel Rod Ends with PTFE Bearing				Chrome Moly Rod Ends			
	Steel Tube		Aluminum Tube		Steel Tube		Aluminum Tube	
	Black Powder Painted	Bright Chrome Plated	Black Powder Painted	Bright Chrome Plated	Black Powder Painted	Bright Chrome Plated	Black Powder Painted	Bright Chrome Plated
127	J0013522	J0013523	J0013408	J0013409	J0013620	J0013621	J0013464	J0013465
137	J0013524	J0013525	J0013410	J0013411	J0013622	J0013623	J0013466	J0013467
147	J0013526	J0013527	J0013412	J0013413	J0013624	J0013625	J0013468	J0013469
157	J0013528	J0013529	J0013414	J0013415	J0013626	J0013627	J0013470	J0013471
167	J0013530	J0013531	J0013416	J0013417	J0013628	J0013629	J0013472	J0013473
177	J0013532	J0013533	J0013418	J0013419	J0013630	J0013631	J0013474	J0013475
187	J0013534	J0013535	J0013420	J0013421	J0013632	J0013633	J0013476	J0013477
197	J0013536	J0013537	J0013422	J0013423	J0013634	J0013635	J0013478	J0013479
207	J0013538	J0013539	J0013424	J0013425	J0013636	J0013637	J0013480	J0013481
217	J0013540	J0013541	J0013426	J0013427	J0013638	J0013639	J0013482	J0013483
227	J0013542	J0013543	J0013428	J0013429	J0013640	J0013641	J0013484	J0013485
237	J0013544	J0013545	J0013430	J0013431	J0013642	J0013643	J0013486	J0013487
247	J0013546	J0013547	J0013432	J0013433	J0013644	J0013645	J0013488	J0013489
257	J0013548	J0013549	J0013434	J0013435	J0013646	J0013647	J0013490	J0013491
267	J0013550	J0013551	J0013436	J0013437	J0013648	J0013649	J0013492	J0013493
277	J0013552	J0013553	J0013438	J0013439	J0013650	J0013651	J0013494	J0013495
287	J0013554	J0013555	J0013440	J0013441	J0013652	J0013653	J0013496	J0013497
297	J0013556	J0013557	J0013442	J0013443	J0013654	J0013655	J0013498	J0013499
307	J0013558	J0013559	J0013444	J0013445	J0013656	J0013657	J0013500	J0013501
317	J0013560	J0013561	J0013446	J0013447	J0013658	J0013659	J0013502	J0013503
327	J0013562	J0013563	J0013448	J0013449	J0013660	J0013661	J0013504	J0013505
337	J0013564	J0013565	J0013450	J0013451	J0013662	J0013663	J0013506	J0013507
347	J0013566	J0013567	J0013452	J0013453	J0013664	J0013665	J0013508	J0013509
357	J0013568	J0013569	J0013454	J0013455	J0013666	J0013667	J0013510	J0013511
367	J0013570	J0013571	J0013456	J0013457	J0013668	J0013669	J0013512	J0013513
377	J0013572	J0013573	J0013458	J0013459	J0013670	J0013671	J0013514	J0013515
387	J0013574	J0013575	J0013460	J0013461	J0013672	J0013673	J0013516	J0013517
397	J0013576	J0013577	J0013462	J0013463	J0013674	J0013675	J0013518	J0013519

More 10mm End Links shown on next page ->





Length in millimeters	Steel Tubes				Steel Tubes				
	Steel Rod Ends with PTFE Bearing		Chrome Moly Rod Ends		Steel Rod Ends with PTFE Bearing		Chrome Moly Rod Ends		
	Black Powder Painted	Bright Chrome Plated	Black Powder Painted	Bright Chrome Plated	Length in mm	Black Powder Painted	Bright Chrome Plated	Black Powder Painted	Bright Chrome Plated
407	J0013578	J0013579	J0013676	J0013677	507	J0013598	J0013599	J0013696	J0013697
417	J0013580	J0013581	J0013678	J0013679	517	J0013600	J0013601	J0013698	J0013699
427	J0013582	J0013583	J0013680	J0013681	527	J0013602	J0013603	J0013700	J0013701
437	J0013584	J0013585	J0013682	J0013683	537	J0013604	J0013605	J0013702	J0013703
447	J0013586	J0013587	J0013684	J0013685	547	J0013606	J0013607	J0013704	J0013705
457	J0013588	J0013589	J0013686	J0013687	557	J0013608	J0013609	J0013706	J0013707
467	J0013590	J0013591	J0013688	J0013689	567	J0013610	J0013611	J0013708	J0013709
477	J0013592	J0013593	J0013690	J0013691	577	J0013612	J0013613	J0013710	J0013711
487	J0013594	J0013595	J0013692	J0013693	587	J0013614	J0013615	J0013712	J0013713
497	J0013596	J0013597	J0013694	J0013695	597	J0013616	J0013617	J0013714	J0013715

**Sway Bar End Links - Short Universal Adjustable**



Lengths are based on center-to-center lengths from rod end bore to rod end bore. Chrome Moly rod ends are 4130 Heat Treated Chrome Moly with a slotted nylon race. Standard rod ends are zinc plated with a PTFE race.

Bore	Length	Standard Rod Ends	Chrome Moly Rod Ends
3/8"	2.75"	J0014083	J0014128
1/2"	3.50"	J0013319	J0013362
10mm	73mm	J0013520	J0013618
10mm	99mm	J0013521	J0013619
12mm	84mm	J0013775	J0013873
12mm	109mm	J0013776	J0013874

**Steinjäger's Growing Family of Vehicle Parts...**

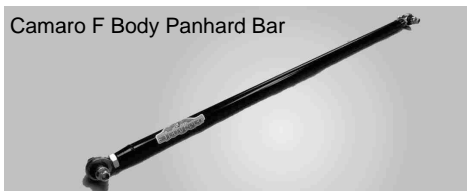

**Universal Sway Bar End Link Kits - 12mm**

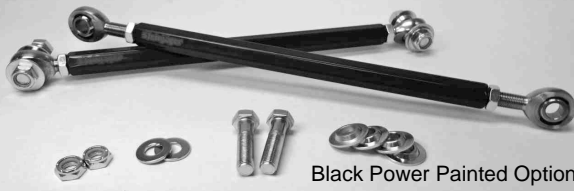

Black Power Painted Option

End Link Kits comes as a set which includes two tubes, four rod ends, and all attaching hardware. Choose from steel or aluminum tubes, black or chromed finishes, and standard (PTFE) or heavy duty chrome moly nylon raced rod ends. End Links are double adjustable to  $\pm 9\text{mm}$  of nominal lengths. Threads are M12 x 1.75.



Bright Chrome Plated Option

Steel Hex Bar Connecting Tube					Steel Hex Bar Connecting Tube				
Steel Rod Ends with PTFE Bearing			Chrome Moly Rod Ends		Steel Rod Ends with PTFE Bearing			Chrome Moly Rod Ends	
Length in mm	Black Powder Painted	Bright Chrome Plated	Black Powder Painted	Bright Chrome Plated	Length in mm	Black Powder Painted	Bright Chrome Plated	Black Powder Painted	Bright Chrome Plated
133	J0013777	J0013778	J0013875	J0013876	493	J0013849	J0013850	J0013947	J0013948
143	J0013779	J0013780	J0013877	J0013878	503	J0013851	J0013852	J0013949	J0013950
153	J0013781	J0013782	J0013879	J0013880	513	J0013853	J0013854	J0013951	J0013952
163	J0013783	J0013784	J0013881	J0013882	523	J0013855	J0013856	J0013953	J0013954
173	J0013785	J0013786	J0013883	J0013884	533	J0013857	J0013858	J0013955	J0013956
183	J0013787	J0013788	J0013885	J0013886	543	J0013859	J0013860	J0013957	J0013958
193	J0013789	J0013790	J0013889	J0013890	553	J0013861	J0013862	J0013959	J0013960
203	J0013791	J0013792	J0013889	J0013890	563	J0013863	J0013864	J0013961	J0013962
213	J0013793	J0013794	J0013891	J0013892	573	J0013865	J0013866	J0013963	J0013964
223	J0013795	J0013796	J0013893	J0013894	583	J0013867	J0013868	J0013965	J0013966
233	J0013797	J0013798	J0013895	J0013896	593	J0013869	J0013870	J0013967	J0013968
243	J0013799	J0013800	J0013897	J0013898	603	J0013871	J0013872	J0013969	J0013970
253	J0013801	J0013802	J0013899	J0013900	Aluminum Hex Bar Connecting Tube				
263	J0013803	J0013804	J0013901	J0013902					
					Aluminum Hex Bar Connecting Tube				
					Steel Rod Ends with PTFE Bearing			Chrome Moly Rod Ends	
					Length in mm	Black Powder Painted	Bright Chrome Plated	Black Powder Painted	Bright Chrome
273	J0013805	J0013806	J0013903	J0013904	213	J0013719	J0013720	J0013747	J0013748
283	J0013807	J0013808	J0013905	J0013906	223	J0013721	J0013722	J0013749	J0013750
293	J0013809	J0013810	J0013907	J0013908	233	J0013723	J0013724	J0013751	J0013752
303	J0013811	J0013812	J0013909	J0013910	243	J0013725	J0013726	J0013753	J0013754
313	J0013813	J0013814	J0013911	J0013912	253	J0013727	J0013728	J0013755	J0013756
323	J0013815	J0013816	J0013913	J0013914	263	J0013729	J0013730	J0013757	J0013758
333	J0013817	J0013818	J0013915	J0013916	273	J0013731	J0013732	J0013759	J0013760
343	J0013819	J0013820	J0013917	J0013918	283	J0013733	J0013734	J0013761	J0013762
353	J0013821	J0013822	J0013919	J0013920	293	J0013735	J0013736	J0013763	J0013764
363	J0013823	J0013824	J0013921	J0013922	303	J0013737	J0013738	J0013765	J0013766
373	J0013825	J0013826	J0013923	J0013924	313	J0013739	J0013740	J0013767	J0013768
383	J0013827	J0013828	J0013925	J0013926	323	J0013741	J0013742	J0013769	J0013770
393	J0013829	J0013830	J0013927	J0013928	333	J0013743	J0013744	J0013771	J0013772
403	J0013831	J0013832	J0013929	J0013930	343	J0013745	J0013746	J0013773	J0013774
413	J0013833	J0013834	J0013931	J0013932					
423	J0013835	J0013836	J0013933	J0013934					
433	J0013837	J0013838	J0013935	J0013936					
443	J0013839	J0013840	J0013937	J0013938					
453	J0013841	J0013842	J0013939	J0013940					
463	J0013843	J0013844	J0013941	J0013942					
473	J0013845	J0013846	J0013943	J0013944					
483	J0013847	J0013848	J0013945	J0013946					

### 3/8 Universal Sway Bar End Links & Clevises

The term *Moly End* means chrome moly, chrome polished, slotted nylon spherical rod end bearings. *PTFE End* means steel housing PTFE raced spherical rod end bearings. The PTFE housing is zinc plated if paired with a black tube, or chrome plated if paired with a chromed tube.



Nominal lengths have  $\pm 0.467$  adjustment and are measured as follows:  
 For 2 clevis kits: from the inside flat of the clevis to the eye of the far spherical rod end.  
 for 4 clevis kits: from the inside of the clevis flat to the inside of the clevis flat

3/8 Sizes		Steel Hex Connecting Tube						Aluminum Hex Connecting Tube			
		Black Tube & Clevis		Chromed Tube/Clevis		Black Tube/Silver Clevis		Black Tube & Clevis		Chromed Tube/Clevis	
Length	Clevises Per Kit	Moly End	PTFE End	Moly End	PTFE End	Moly End	PTFE End	Moly End	PTFE End	Moly End	PTFE End
6.50"	2	J0015516	J0015517	J0015520	J0015521	J0015524	J0015525	J0015528	J0015529	J0015532	J0015533
7.50"	2	J0015556	J0015557	J0015560	J0015561	J0015564	J0015565	J0015568	J0015569	J0015572	J0015573
7.75"	4	J0015518	J0015519	J0015522	J0015523	J0015526	J0015527	J0015530	J0015531	J0015534	J0015535
8.50"	2	J0015608	J0015609	J0015612	J0015613	J0015616	J0015617	J0015620	J0015621	J0015624	J0015625
8.75"	4	J0015558	J0015559	J0015562	J0015563	J0015566	J0015567	J0015570	J0015571	J0015574	J0015575
9.50"	2	J0015652	J0015653	J0015656	J0015657	J0015660	J0015661	J0015664	J0015665	J0015668	J0015669
9.75"	4	J0015610	J0015611	J0015614	J0015615	J0015618	J0015619	J0015622	J0015623	J0015626	J0015627
10.50"	2	J0015704	J0015705	J0015708	J0015709	J0015712	J0015713	J0015716	J0015717	J0015720	J0015721
10.75"	4	J0015654	J0015655	J0015658	J0015659	J0015662	J0015663	J0015666	J0015667	J0015670	J0015671
11.50"	2	J0015756	J0015757	J0015760	J0015761	J0015764	J0015765	J0015768	J0015769	J0015772	J0015773
11.75"	4	J0015706	J0015707	J0015710	J0015711	J0015714	J0015715	J0015718	J0015719	J0015722	J0015723
12.50"	2	J0015808	J0015809	J0015812	J0015813	J0015816	J0015817	J0015820	J0015821	J0015824	J0015825
12.75"	4	J0015758	J0015759	J0015762	J0015763	J0015766	J0015767	J0015770	J0015771	J0015774	J0015775
13.50"	2	J0015852	J0015853	J0015856	J0015857	J0015860	J0015861	J0015864	J0015865	J0015868	J0015869
13.75"	4	J0015810	J0015811	J0015814	J0015815	J0015818	J0015819	J0015822	J0015823	J0015826	J0015827
14.50"	2	J0015904	J0015905	J0015908	J0015909	J0015912	J0015913	J0015916	J0015917	J0015920	J0015921
14.75"	4	J0015854	J0015855	J0015858	J0015859	J0015862	J0015863	J0015866	J0015867	J0015870	J0015871
15.50"	2	J0015944	J0015945	J0015948	J0015949	J0015952	J0015953	J0015956	J0015957	J0015960	J0015961
15.75"	4	J0015906	J0015907	J0015910	J0015911	J0015914	J0015915	J0015918	J0015919	J0015922	J0015923
16.50"	2	J0015996	J0015997	J0016000	J0016001	J0016004	J0016005	J0016008	J0016009	J0016012	J0016013
16.75"	4	J0015946	J0015947	J0015950	J0015951	J0015954	J0015955	J0015958	J0015959	J0015962	J0015963
17.50"	2	J0016044	J0016045	J0016048	J0016049	J0016052	J0016053	J0016056	J0016057	J0016060	J0016061
17.75"	4	J0015998	J0015999	J0016002	J0016003	J0016006	J0016007	J0016010	J0016011	J0016014	J0016015
18.50"	2	J0016096	J0016097	J0016100	J0016101	J0016104	J0016105	J0016108	J0016109	J0016112	J0016113
18.75"	4	J0016046	J0016047	J0016050	J0016051	J0016054	J0016055	J0016058	J0016059	J0016062	J0016063
19.50"	2	J0016144	J0016145	J0016148	J0016149	J0016180	J0016181	-	-	-	-
19.75"	4	J0016098	J0016099	J0016102	J0016103	J0016106	J0016107	J0016110	J0016111	J0016114	J0016115
20.50"	2	-	-	-	-	-	-	J0016180	J0016181	J0016184	J0016185
20.75"	4	-	-	-	-	-	-	J0016146	J0016147	J0016150	J0016151
21.50"	2	J0016220	J0016221	J0016224	J0016225	J0016228	J0016229	J0016232	J0016233	J0016236	J0016237
21.75"	4	-	-	-	-	-	-	J0016182	J0016183	J0016186	J0016187
22.50"	2	J0016268	J0016269	J0016272	J0016273	J0016276	J0016277	J0016280	J0016281	J0016284	J0016285
22.75"	4	J0016222	J0016223	J0016226	J0016227	J0016230	J0016231	J0016234	J0016235	J0016238	J0016239
23.50"	2	-	-	-	-	-	-	J0016320	J0016321	J0016324	J0016325
23.75"	4	J0016270	J0016271	J0016274	J0016275	J0016278	J0016279	J0016282	J0016283	J0016286	J0016287
24.50"	2	-	-	-	-	-	-	J0016348	J0016349	J0016352	J0016353
24.75"	4	-	-	-	-	-	-	J0016322	J0016323	J0016326	J0016327
25.75"	4	-	-	-	-	-	-	J0016350	J0016351	J0016354	J0016355

Other lengths available - please refer to our website.

## 1/2 Universal Sway Bar End Links & Clevises



The term *Moly End* means chrome moly, chrome polished, slotted nylon spherical rod end bearings. *PTFE End* means steel housing PTFE raced spherical rod end bearings. The PTFE housing is zinc plated if paired with a black tube, or chrome plated if paired with a chromed tube.

Nominal lengths have  $\pm 0.430$  adjustment and are measured as follows: For 2 clevis kits: from the inside flat of the clevis to the eye of the far spherical rod end. for 4 clevis kits: from the inside of the clevis flat to the inside of the clevis flat

1/2 Sizes		Steel Hex Connecting Tube						Aluminum Hex Connecting Tube			
		Black Tube & Clevis		Chromed Tube/Clevis		Black Tube/Silver Clevis		Black Tube & Clevis		Chromed Tube/Clevis	
Length	Clevises Per Kit	Moly End	PTFE End	Moly End	PTFE End	Moly End	PTFE End	Moly End	PTFE End	Moly End	PTFE End
7.30"	2	J0015536	J0015537	J0015540	J0015541	J0015544	J0015545	J0015548	J0015549	J0015552	J0015553
7.80"	2	J0015576	J0015577	J0015580	J0015581	J0015584	J0015585	-	-	-	-
8.30"	2	J0015588	J0015589	J0015592	J0015593	J0015596	J0015597	J0015600	J0015601	J0015604	J0015605
8.60"	4	J0015538	J0015539	J0015542	J0015543	J0015546	J0015547	J0015550	J0015551	J0015554	J0015555
9.10"	4	J0015578	J0015579	J0015582	J0015583	J0015586	J0015587	-	-	-	-
9.30"	2	J0015632	J0015633	J0015636	J0015637	J0015640	J0015641	J0015644	J0015645	J0015648	J0015649
9.60"	4	J0015590	J0015591	J0015594	J0015595	J0015598	J0015599	J0015602	J0015603	J0015606	J0015607
10.30"	2	J0015684	J0015685	J0015688	J0015689	J0015692	J0015693	J0015696	J0015697	J0015700	J0015701
10.60"	4	J0015634	J0015635	J0015638	J0015639	J0015642	J0015643	J0015646	J0015647	J0015650	J0015651
11.30"	2	J0015736	J0015737	J0015740	J0015741	J0015744	J0015745	J0015748	J0015749	J0015752	J0015753
11.60"	4	J0015686	J0015687	J0015690	J0015691	J0015694	J0015695	J0015698	J0015699	J0015702	J0015703
12.30"	2	J0015788	J0015789	J0015792	J0015793	J0015796	J0015797	J0015800	J0015801	J0015804	J0015805
12.60"	4	J0015738	J0015739	J0015742	J0015743	J0015746	J0015747	J0015750	J0015751	J0015754	J0015755
13.30"	2	J0015832	J0015833	J0015836	J0015837	J0015840	J0015841	J0015844	J0015845	J0015848	J0015849
13.60"	4	J0015790	J0015791	J0015794	J0015795	J0015798	J0015799	J0015802	J0015803	J0015806	J0015807
14.30"	2	J0015884	J0015885	J0015888	J0015889	J0015892	J0015893	J0015896	J0015897	J0015900	J0015901
14.60"	4	J0015834	J0015835	J0015838	J0015839	J0015842	J0015843	J0015846	J0015847	J0015850	J0015851
15.30"	2	J0015924	J0015925	J0015928	J0015929	J0015932	J0015933	J0015936	J0015937	J0015940	J0015941
15.60"	4	J0015886	J0015887	J0015890	J0015891	J0015894	J0015895	J0015898	J0015899	J0015902	J0015903
16.30"	2	J0015976	J0015977	J0015980	J0015981	J0015984	J0015985	J0015988	J0015989	J0015992	J0015993
16.60"	4	J0015926	J0015927	J0015930	J0015931	J0015934	J0015935	J0015938	J0015939	J0015942	J0015943
17.30"	2	J0016024	J0016025	J0016028	J0016029	J0016032	J0016033	J0016036	J0016037	J0016040	J0016041
17.60"	4	J0015978	J0015979	J0015982	J0015983	J0015986	J0015987	J0015990	J0015991	J0015994	J0015995
18.30"	2	J0016076	J0016077	J0016080	J0016081	J0016084	J0016085	J0016088	J0016089	J0016092	J0016093
18.60"	4	J0016026	J0016027	J0016030	J0016031	J0016034	J0016035	J0016038	J0016039	J0016042	J0016043
19.30"	2	J0016124	J0016125	J0016128	J0016129	J0016132	J0016133	J0016136	J0016137	J0016140	J0016141
19.60"	4	J0016078	J0016079	J0016082	J0016083	J0016086	J0016087	J0016090	J0016091	J0016094	J0016095
20.30"	2	J0016160	J0016161	J0016164	J0016165	J0016168	J0016169	J0016172	J0016173	J0016176	J0016177
20.60"	4	J0016126	J0016127	J0016130	J0016131	J0016134	J0016135	J0016138	J0016139	J0016142	J0016143
21.30"	2	J0016200	J0016201	J0016204	J0016205	J0016208	J0016209	J0016212	J0016213	J0016216	J0016217
21.60"	4	J0016162	J0016163	J0016166	J0016167	J0016170	J0016171	J0016174	J0016175	J0016178	J0016179
22.30"	2	J0016248	J0016249	J0016252	J0016253	J0016256	J0016257	J0016260	J0016261	J0016264	J0016265
22.60"	4	J0016202	J0016203	J0016206	J0016207	J0016210	J0016211	J0016214	J0016215	J0016218	J0016219
23.30"	2	J0016300	J0016301	J0016304	J0016305	J0016308	J0016309	J0016312	J0016313	J0016316	J0016317
23.60"	4	J0016250	J0016251	J0016254	J0016255	J0015258	J0015259	J0016262	J0016263	J0016266	J0016267
24.30"	2	J0016328	J0016329	J0016332	J0016333	J0016336	J0016337	J0016340	J0016341	J0016344	J0016345
24.60"	4	J0016302	J0016303	J0016306	J0016307	J0016310	J0016311	J0016314	J0016315	J0016318	J0016319
25.60"	4	J0016330	J0016331	J0016334	J0016335	J0016338	J0016339	J0016342	J0016343	J0016346	J0016347

## 5/8 Universal Sway Bar End Links & Clevises





The term *Moly End* means chrome moly, chrome polished, slotted nylon spherical rod end bearings. *PTFE End* means steel housing PTFE raced spherical rod end bearings. The PTFE housing is zinc plated if paired with a black tube, or chrome plated if paired with a chromed tube.

Nominal lengths have  $\pm 0.313$  adjustment and are measured as follows: For 2 clevis kits: from the inside flat of the clevis to the eye of the far spherical rod end. for 4 clevis kits: from the inside of the clevis flat to the inside of the clevis flat

5/8 Sizes		Aluminum Hex Connecting Tube			
		Black Tube & Clevis		Chromed Tube/Clevis	
Length	Clevis Per Kit	Moly End	PTFE End	Moly End	PTFE End
10.13"	2	J0015676	J0015677	J0015680	J0015681
11.13"	2	J0015728	J0015729	J0015732	J0015733
11.88"	4	J0015678	J0015679	J0015682	J0015683
12.13"	2	J0015780	J0015781	J0015784	J0015785
12.88"	4	J0015730	J0015731	-	-
13.88"	4	J0015782	J0015783	J0015786	J0015787
14.13"	2	J0015876	J0015877	J0015880	J0015881
15.88"	4	J0015878	J0015879	J0015882	J0015883
16.13"	2	J0015968	J0015969	J0015972	J0015973
17.13"	2	J0016016	J0016017	J0016020	J0016021
17.88"	4	J0015970	J0015971	J0015974	J0015975
18.13"	2	J0016068	J0016069	J0016072	J0016073
18.88"	4	J0016018	J0016019	J0016022	J0016023
19.13"	2	J0016116	J0016117	J0016120	J0016121
19.88"	4	J0016070	J0016071	J0016074	J0016075
20.13"	2	J0016152	J0016153	J0016156	J0016157
20.88"	4	J0016118	J0016119	J0016122	J0016123
21.13"	2	J0016192	J0016193	J0016196	J0016197
21.88"	4	J0016154	J0016155	J0016158	J0016159
22.13"	2	J0016240	J0016241	J0016244	J0016245
22.88"	4	J0016194	J0016195	J0016198	J0016199
23.13"	2	J0016292	J0016293	J0016296	J0016297
23.88"	4	J0016242	J0016243	J0016246	J0016247
24.88"	4	J0016294	J0016295	J0016298	J0016299

5/8 Sizes		Steel Hex Connecting Tube	
		Black Tube & Clevis	
Length	Clevises Per Kit	Moly End	PTFE End
9.13"	2	J0015628	J0015629
10.13"	2	J0015672	J0015673
10.88"	4	J0015630	J0015631
11.13"	2	J0015724	J0015725
11.88"	4	J0015674	J0015675
12.88"	4	J0015726	J0015727
13.13"	2	J0015828	J0015829
13.88"	4	J0015778	J0015779
14.13"	2	J0015872	J0015873
14.88"	4	J0015830	J0015831
15.88"	4	J0015874	J0015875
16.13"	2	J0015964	J0015965
17.88"	4	J0015966	J0015967
18.13"	2	J0016064	J0016065
19.88"	4	J0016066	J0016067
21.13"	2	J0016188	J0016189
22.88"	4	J0016190	J0016191
23.13"	2	J0016288	J0016289
24.88"	4	J0016290	J0016291

End Link Clevis Kits													
		2 Clevises Per Kit. No Spacers.			2 Clevises per Kit. Includes Spacers			4 Clevises per Kit. Includes Spacers			8 Clevises per Kit. Includes Spacers		
Bore	Inside Jaw	Black Powder	Zinc Silver	Chrome Plate	Black Powder	Zinc Silver	Chrome Plate	Black Powder	Zinc Silver	Chrome Plate	Black Powder	Zinc Silver	Chrome Plate
3/8	1.375"	J0014173	J0014175	J0014174	J0015470	J0015475	J0015480	J0015485	J0015490	J0015495	J0015500	J0015505	J0015510
1/2	1.625"	J0013405	J0013407	J0013406	J0015471	J0015476	J0015481	J0015486	J0015491	J0015496	J0015501	J0015506	J0015511
5/8	1.875"	J0014176	J0014178	J0014177	J0015472	J0015477	J0015482	J0015487	J0015492	J0015497	J0015502	J0015507	J0015512
M10	34mm	J0013716	J0013718	J0013717	J0015473	J0015478	J0015483	J0015488	J0015493	J0015498	J0015503	J0015508	J0015513
M12	39mm	J0013971	J0013973	J0013972	J0015474	J0015479	J0015484	J0015489	J0015494	J0015499	J0015504	J0015509	J0015514



## M10 Universal Sway Bar End Links & Clevises



The term *Moly End* means chrome moly, chrome polished, slotted nylon spherical rod end bearings. *PTFE End* means steel housing PTFE raced spherical rod end bearings. The PTFE housing is zinc plated if paired with a black tube, or chrome plated if paired with a chromed tube.

Nominal lengths have  $\pm 9\text{mm}$  adjustment and are measured as follows: For 2 clevis kits: from the inside flat of the clevis to the eye of the far spherical rod end. for 4 clevis kits: from the inside of the clevis flat to the inside of the clevis flat

10mm Sizes		Steel Hex Connecting Tube						Aluminum Hex Connecting Tube			
		Black Tube & Clevis		Chromed Tube/Clevis		Black Tube/Silver Clevis		Black Tube & Clevis		Chromed Tube/Clevis	
Length	Clevises Per Kit	Moly End	PTFE End	Moly End	PTFE End	Moly End	PTFE End	Moly End	PTFE End	Moly End	PTFE End
162mm	2	J0016469	J0016475	J0016468	J0016474	J0016470	J0016476	J0016480	J0016484	J0016481	J0016485
172mm	2	J0016501	J0016507	J0016509	J0016506	J0016502	J0016508	J0016512	J0016516	J0016513	J0016517
182mm	2	J0016533	J0016539	J0016532	J0016538	J0016534	J0016540	J0016544	J0016548	J0016545	J0016549
192mm	2	J0016565	J0016571	J0016564	J0016570	J0016566	J0016572	J0016576	J0016580	J0016577	J0016581
197mm	4	J0016472	J0016478	J0016471	J0016477	J0016473	J0016479	J0016482	J0016486	J0016483	J0016486
202mm	2	J0016597	J0016603	J0016596	J0016602	J0016598	J0016604	J0016608	J0016612	J0016609	J0016613
207mm	4	J0016504	J0016510	J0016503	J0016509	J0016505	J0016511	J0016514	J0016518	J0016515	J0016519
212mm	2	J0016629	J0016635	J0016628	J0016634	J0016630	J0016636	J0016640	J0016644	J0016641	J0016645
217mm	4	J0016536	J0016542	J0016535	J0016541	J0016537	J0016543	J0016546	J0016550	J0016547	J0016551
222mm	2	J0016661	J0016667	J0016660	J0016659	J0016662	J0016668	J0016672	J0016676	J0016673	J0016677
227mm	4	J0016568	J0016574	J0016567	J0016566	J0016569	J0016575	J0016578	J0016582	J0016579	J0016583
232mm	2	J0016693	J0016699	J0016692	J0016691	J0016694	J0016700	J0016704	J0016708	J0016705	J0016709
237mm	4	J0016600	J0016606	J0016599	J0016598	J0016601	J0016607	J0016610	J0016614	J0016611	J0016615
242mm	2	J0016725	J0016731	J0016724	J0016723	J0016726	J0016732	J0016736	J0016740	J0016737	J0016741
247mm	4	J0016632	J0016638	J0016631	J0016637	J0016633	J0016639	J0016642	J0016646	J0016643	J0016647
252mm	2	J0016765	J0016771	J0016764	J0016770	J0016766	J0016772	J0016776	J0016780	J0016777	J0016781
257mm	4	J0016664	J0016670	J0016663	J0016669	J0016665	J0016671	J0016674	J0016678	J0016675	J0016679
262mm	2	J0016805	J0016811	J0016804	J0016810	J0016806	J0016812	J0016816	J0016820	J0016817	J0016821
267mm	4	J0016696	J0016702	J0016695	J0016701	J0016697	J0016703	J0016706	J0016710	J0016707	J0016711
272mm	2	J0016845	J0016851	J0016844	J0016850	J0016846	J0016852	J0016856	J0016860	J0016857	J0016861
277mm	4	J0016728	J0016734	J0016727	J0016733	J0016729	J0016735	J0016738	J0016742	J0016739	J0016743
282mm	2	J0016885	J0016891	J0016884	J0016890	J0016886	J0016892	J0016896	J0016900	J0016897	J0016901
287mm	4	J0016768	J0016774	J0016767	J0016773	J0016769	J0016775	J0016778	J0016782	J0016778	J0016783
292mm	2	J0016925	J0016931	J0016924	J0016930	J0016926	J0016932	J0016936	J0016940	J0016937	J0016941
297mm	4	J0016808	J0016814	J0016807	J0016813	J0016809	J0016815	J0016818	J0016822	J0016819	J0016823
302mm	2	J0016965	J0016971	J0016964	J0016970	J0016966	J0016972	J0016976	J0016980	J0016977	J0016981
307mm	4	J0016848	J0016854	J0016847	J0016853	J0016849	J0016855	J0016858	J0016862	J0016859	J0016863
312mm	2	J0017005	J0017011	J0017004	J0017010	J0017006	J0017012	J0017016	J0017020	J0017017	J0017021
317mm	4	J0016888	J0016894	J0016887	J0016893	J0016889	J0016895	J0016898	J0016902	J0016899	J0016903
322mm	2	J0017045	J0017051	J0017044	J0017050	J0017046	J0017052	J0017056	J0017060	J0017057	J0017061
327mm	4	J0016928	J0016934	J0016927	J0016933	J0016929	J0016935	J0016938	J0016942	J0016939	J0016943
332mm	2	J0017085	J0017091	J0017084	J0017090	J0017086	J0017092	J0017096	J0017100	J0017097	J0017101
337mm	4	J0016968	J0016974	J0016967	J0016973	J0016969	J0016975	J0016978	J0016982	J0016979	J0016983
342mm	2	J0017125	J0017131	J0017124	J0017130	J0017126	J0017132	J0017136	J0017140	J0017137	J0017141
347mm	4	J0017008	J0017014	J0017007	J0017013	J0017009	J0017015	J0017018	J0017022	J0017019	J0017023
352mm	2	J0017165	J0017171	J0017164	J0017170	J0017166	J0017172	J0017176	J0017180	J0017177	J0017181
357mm	4	J0017048	J0017054	J0017047	J0017053	J0017049	J0017055	J0017058	J0017062	J0017059	J0017063
362mm	2	J0017205	J0017211	J0017204	J0017210	J0017206	J0017212	J0017216	J0017220	J0017217	J0017221

10mm sizes continued		Steel Hex Connecting Tube						Aluminum Hex Connecting Tube			
		Black Tube & Clevis		Chromed Tube/Clevis		Black Tube/Silver Clevis		Black Tube & Clevis		Chromed Tube/Clevis	
Length	Clevises Per Kit	Moly End	PTFE End	Moly End	PTFE End	Moly End	PTFE End	Moly End	PTFE End	Moly End	PTFE End
367mm	4	J0017088	J0017094	J0017087	J0017093	J0017089	J0017095	J0017098	J0017102	J0017099	J0017103
372mm	2	J0017245	J0017251	J0017244	J0017250	J0017246	J0017252	J0017256	J0017260	J0017257	J0017261
377mm	4	J0017128	J0017134	J0017127	J0017133	J0017129	J0017135	J0017138	J0017142	J0017139	J0017143
382mm	2	J0017285	J0017291	J0017284	J0017290	J0017286	J0017292	J0017296	J0017300	J0017297	J0017301
387mm	4	J0017168	J0017174	J0017167	J0017173	J0017169	J0017175	J0017178	J0017182	J0017179	J0017183
392mm	2	J0017317	J0017323	J0017316	J0017322	J0017318	J0017324	J0017328	J0017332	J0017329	J0017333
397mm	4	J0017208	J0017214	J0017207	J0017213	J0017209	J0017215	J0017218	J0017222	J0017219	J0017223
402mm	2	J0017349	J0017355	J0017348	J0017354	J0017350	J0017356	J0017360	J0017364	J0017361	J0017365
407mm	4	J0017248	J0017254	J0017247	J0017251	J0017249	J0017255	J0017258	J0017262	J0017259	J0017263
412mm	2	J0017381	J0017387	J0017380	J0017386	J0017382	J0017388	J0017392	J0017396	J0017393	J0017397
417mm	4	J0017288	J0017294	J0017287	J0017293	J0017289	J0017295	J0017298	J0017302	J0017299	J0017303
422mm	2	J0017413	J0017419	J0017412	J0017418	J0017414	J0017420	J0017424	J0017428	J0017425	J0017429
427mm	4	J0017320	J0017326	J0017319	J0017325	J0017321	J0017327	J0017330	J0017334	J0017331	J0017335
432mm	2	J0017445	J0017451	J0017444	J0017450	J0017446	J0017452	J0017456	J0017460	J0017457	J0017461
437mm	4	J0017352	J0017358	J0017351	J0017357	J0017353	J0017359	J0017362	J0017366	J0017363	J0017367
442mm	2	J0017477	J0017483	J0017476	J0017482	J0017478	J0017484	-	-	-	-
447mm	4	J0017384	J0017390	J0017383	J0017389	J0017385	J0017391	J0017394	J0017398	J0017395	J0017399
452mm	2	J0017501	J0017507	J0017500	J0017506	J0017502	J0017508	-	-	-	-
457mm	4	J0017416	J0017422	J0017415	J0017421	J0017417	J0017423	J0017426	J0017430	J0017427	J0017431
462mm	2	J0017525	J0017531	J0017524	J0017530	J0017526	J0017532	-	-	-	-
467mm	4	J0017448	J0017454	J0017447	J0017453	J0017449	J0017455	J0017458	J0017462	J0017459	J0017463
472mm	2	J0017549	J0017555	J0017548	J0017554	J0017550	J0017556				
477mm	4	J0017480	J0017486	J0017479	J0017485	J0017481	J0017486				
482mm	2	J0017573	J0017579	J0017572	J0017578	J0017574	J0017580				
487mm	4	J0017504	J0017510	J0017503	J0017509	J0017505	J0017511				
492mm	2	J0017597	J0017603	J0017596	J0017602	J0017598	J0017604				
497mm	4	J0017528	J0017534	J0017527	J0017533	J0017529	J0017535				
502mm	2	J0017621	J0017627	J0017620	J0017626	J0017622	J0017628				
507mm	4	J0017552	J0017558	J0017551	J0017557	J0017553	J0017559				
512mm	2	J0017645	J0017651	J0017644	J0017650	J0017646	J0017652				
517mm	4	J0017576	J0017582	J0017575	J0017581	J0017577	J0017582				
527mm	4	J0017600	J0017606	J0017599	J0017604	J0017601	J0017607				
537mm	4	J0017624	J0017630	J0017623	J0017629	J0017625	J0017631				
547mm	4	J0017648	J0017654	J0017647	J0017653	J0017649	J0017655				
552mm	2	J0017705	J0017711	J0017704	J0017710	J0017706	J0017712				
587mm	4	J0017708	J0017714	J0017707	J0017713	J0017709	J0017715				
602mm	2	J0017777	J0017783	J0017776	J0017782	J0017778	J0017784				
612mm	2	J0017801	J0017807	J0017800	J0017806	J0017802	J0017808				
637mm	4	J0017780	J0017786	J0017779	J0017785	J0017781	J0017787				
647mm	4	J0017804	J0017810	J0017803	J0017809	J0017805	J0017811				

Steinjäger offers private labeling



**M12 Universal Sway Bar End Links & Clevises**



The term *Moly End* means chrome moly, chrome polished, slotted nylon spherical rod end bearings. *PTFE End* means steel housing PTFE raced spherical rod end bearings. The PTFE housing is zinc plated if paired with a black tube, or chrome plated if paired with a chromed tube.

Nominal lengths have  $\pm 9\text{mm}$  adjustment and are measured as follows: For 2 clevis kits: from the inside flat of the clevis to the eye of the far spherical rod end. for 4 clevis kits: from the inside of the clevis flat to the inside of the clevis flat

12mm sizes		Steel Hex Connecting Tube						Aluminum Hex Connecting Tube			
		Black Tube & Clevis		Chromed Tube/Clevis		Black Tube/Silver Clevis		Black Tube & Clevis		Chromed Tube/Clevis	
Length	Clevises Per Kit	Moly End	PTFE End	Moly End	PTFE End	Moly End	PTFE End	Moly End	PTFE End	Moly End	PTFE End
173mm	2	J0016489	J0016495	J0016488	J0016494	J0016490	J0016496				
183mm	2	J0016521	J0016527	J0016520	J0016526	J0016522	J0016528				
193mm	2	J0016553	J0016559	J0016552	J0016558	J0016554	J0016560				
203mm	2	J0016585	J0016591	J0016584	J0016590	J0016586	J0016592				
213mm	2	J0016617	J0016623	J0016616	J0016622	J0016618	J0016624				
213mm	4	J0016492	J0016498	J0016491	J0016497	J0016493	J0016499				
223mm	2	J0016649	J0016655	J0016648	J0016654	J0016650	J0016656				
223mm	4	J0016524	J0016530	J0016523	J0016529	J0016525	J0016531				
233mm	2	J0016681	J0016687	J0016680	J0016686	J0016682	J0016688				
233mm	4	J0016556	J0016562	J0016555	J0016561	J0016557	J0016563				
243mm	2	J0016713	J0016719	J0016712	J0016718	J0016714	J0016720				
243mm	4	J0016588	J0016594	J0016587	J0016593	J0016589	J0016595				
253mm	2	J0016745	J0016751	J0016744	J0016750	J0016746	J0016752	J0016756	J0016760	J0016757	J0016761
253mm	4	J0016620	J0016626	J0016619	J0016625	J0016621	J0016627	-	-	-	-
263mm	2	J0016875	J0016791	J0016874	J0016790	J0016876	J0016792	J0016796	J0016800	J0016797	J0016801
263mm	4	J0016652	J0016658	J0016651	J0016657	J0016653	J0016659	-	-	-	-
273mm	2	J0016825	J0016831	J0016824	J0016830	J0016826	J0016832	J0016836	J0016840	J0016837	J0016841
273mm	4	J0016684	J0016690	J0016683	J0016689	J0016685	J0016691	-	-	-	-
283mm	2	J0016865	J0016871	J0016864	J0016870	J0016866	J0016872	J0016876	J0016880	J0016877	J0016881
283mm	4	J0016716	J0016722	J0016715	J0016721	J0016717	J0016723	-	-	-	-
293mm	2	J0016905	J0016911	J0016904	J0016910	J0016906	J0016912	J0016916	J0016920	J0016917	J0016921
293mm	4	J0016748	J0016754	J0016747	J0016753	J0016749	J0016755	J0016758	J0016762	-	-
303mm	2	J0016945	J0016951	J0016944	J0016950	J0016946	J0016952	J0016956	J0016960	J0016957	J0016961
303mm	4	J0016788	J0016794	J0016787	J0016793	J0016789	J0016795	J0016798	J0016802	J0016799	J0016803
313mm	2	J0016985	J0016991	J0016984	J0016990	J0016986	J0016992	J0016996	J0017000	J0016997	J0017001
313mm	4	J0016828	J0016834	J0016827	J0016833	J0016829	J0016835	J0016838	J0016842	J0016839	J0016843
323mm	2	J0017025	J0017031	J0017024	J0017030	J0017026	J0017032	J0017036	J0017040	J0017037	J0017041
323mm	4	J0016868	J0016874	J0016867	J0016873	J0016869	J0016875	J0016878	J0016882	J0016879	J0016883
333mm	2	J0017065	J0017071	J0017064	J0017070	J0017066	J0017072	J0017076	J0017080	J0017077	J0017081
333mm	4	J0016908	J0016914	J0016907	J0016913	J0016909	J0016915	J0016918	J0016922	J0016919	J0016923
343mm	2	J0017105	J0017111	J0017104	J0017110	J0017106	J0017112	J0017116	J0017120	J0017117	J0017121
343mm	4	J0016948	J0016954	J0016947	J0016953	J0016949	J0016955	J0016958	J0016962	J0016959	J0016963
353mm	2	J0017145	J0017151	J0017144	J0017150	J0017146	J0017152	J0017156	J0017160	J0017157	J0017161
353mm	4	J0016988	J0016994	J0016987	J0016993	J0016989	J0016995	J0016998	J0017002	J0016999	J0017003
363mm	2	J0017185	J0017191	J0017184	J0017190	J0017186	J0017192	J0017196	J0017200	J0017197	J0017201
363mm	4	J0017028	J0017034	J0017027	J0017033	J0017029	J0017035	J0017038	J0017042	J0017039	J0017043
373mm	2	J0017225	J0017231	J0017224	J0017230	J0017226	J0017232	J0017236	J0017240	J0017137	J0017241
373mm	4	J0017068	J0017074	J0017067	J0017073	J0017069	J0017075	J0017078	J0017082	J0017079	J0017083

*long lead time items - contact us if interested*

12mm sizes continued		Steel Hex Connecting Tube						Aluminum Hex Connecting Tube			
		Black Tube & Clevis		Chromed Tube/Clevis		Black Tube/Silver Clevis		Black Tube & Clevis		Chromed Tube/Clevis	
Length	Clevises Per Kit	Moly End	PTFE End	Moly End	PTFE End	Moly End	PTFE End	Moly End	PTFE End	Moly End	PTFE End
383mm	2	J0017265	J0017271	J0017264	J0017270	J0017266	J0017272	J0017276	J0017280	J0017277	J0017281
383mm	4	J0017108	J0017114	J0017107	J0017113	J0017109	J0017115	J0017118	J0017122	J0017119	J0017123
393mm	2	J0017305	J0017311	J0017304	J0017310	J0017306	J0017312	-	-	-	-
393mm	4	J0017148	J0017154	J0017147	J0017153	J0017149	J0017155	J0017158	J0017162	J0017159	J0017163
403mm	2	J0017337	J0017343	J0017336	J0017342	J0017338	J0017344	-	-	-	-
403mm	4	J0017188	J0017194	J0017187	J0017193	J0017189	J0017195	J0017198	J0017202	J0017199	J0017203
413mm	2	J0017369	J0017375	J0017368	J0017374	J0017370	J0017376	-	-	-	-
413mm	4	J0017228	J0017234	J0017227	J0017233	J0017229	J0017235	J0017238	J0017242	J0017239	J0017243
423mm	2	J0017401	J0017407	J0017400	J0017406	J0017402	J0017408	-	-	-	-
423mm	4	J0017268	J0017274	J0017267	J0017273	J0017269	J0017275	J0017278	J0017282	J0017279	J0017283
433mm	2	J0017433	J0017439	J0017432	J0017438	J0017434	J0017440				
433mm	4	J0017308	J0017314	J0017307	J0017313	J0017309	J0017315				
443mm	2	J0017465	J0017471	J0017464	J0017470	J0017466	J0017472				
443mm	4	J0017340	J0017346	J0017339	J0017345	J0017341	J0017347				
453mm	2	J0017489	J0017495	J0017488	J0017494	J0017490	J0017496				
453mm	4	J0017372	J0017378	J0017371	J0017377	J0017373	J0017379				
463mm	2	J0017513	J0017519	J0017512	J0017518	J0017514	J0017520				
463mm	4	J0017404	J0017410	J0017403	J0017409	J0017405	J0017411				
473mm	2	J0017537	J0017543	J0017536	J0017542	J0017538	J0017544				
473mm	4	J0017436	J0017442	J0017435	J0017441	J0017437	J0017443				
483mm	2	J0017561	J0017567	J0017560	J0017566	J0017562	J0017568				
483mm	4	J0017468	J0017474	J0017467	J0017473	J0017469	J0017475				
493mm	2	J0017585	J0017591	J0017584	J0017590	J0017586	J0017592				
493mm	4	J0017492	J0017498	J0017491	J0017497	J0017493	J0017499				
503mm	2	J0017609	J0017615	J0017608	J0017614	J0017610	J0017616				
503mm	4	J0017516	J0017522	J0017515	J0017521	J0017517	J0017523				
513mm	2	J0017633	J0017639	J0017632	J0017638	J0017634	J0017640				
513mm	4	J0017540	J0017546	J0017539	J0017545	J0017541	J0017547				
523mm	2	J0017657	J0017663	J0017656	J0017662	J0017658	J0017664				
523mm	4	J0017564	J0017570	J0017563	J0017569	J0017565	J0017571				
533mm	2	J0017669	J0017675	J0017668	J0017674	J0017770	J0017676				
533mm	4	J0017588	J0017594	J0017587	J0017593	J0017589	J0017595				
543mm	2	J0017681	J0017687	J0017680	J0017686	J0017682	J0017688				
543mm	4	J0017612	J0017618	J0017611	J0017617	J0017613	J0017619				
553mm	2	J0017693	J0017699	J0017692	J0017698	J0017694	J0017700				
553mm	4	J0017636	J0017642	J0017635	J0017641	J0017637	J0017643				
563mm	2	J0017717	J0017723	J0017716	J0017722	J0017718	J0017724				
563mm	4	J0017660	J0017666	J0017659	J0017665	J0017661	J0017667				
573mm	2	J0017729	J0017735	J0017728	J0017734	J0017730	J0017736				
573mm	4	J0017672	J0017678	J0017671	J0017677	J0017673	J0017679				
583mm	2	J0017741	J0017747	J0017740	J0017746	J0017742	J0017748				
583mm	4	J0017684	J0017690	J0017683	J0017689	J0017685	J0017691				
593mm	2	J0017753	J0017759	J0017752	J0017758	J0017754	J0017760				
593mm	4	J0017696	J0017702	J0017695	J0017701	J0017697	J0017703				

also available



Pages 4-5



Page 30



Page 65

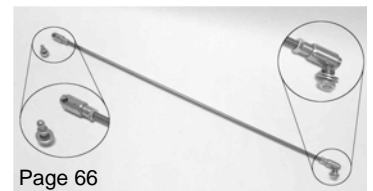

Page 66



Pages 24-29

**Hex Connecting Tubes**

Steinjäger hex bar tubes, threaded LH/RH are suitable for suspension linkages, shifting linkages, strut rods, spoiler rods and more. Available in multiple lengths, threads, materials and finishes.

Other length options shown online.



Length	Mtrl	Black Powder	Chrome Plated	Silver Powder
<b>10-32 Threads (in 3/8 Hex Bar)</b>				
2.00"	Alum	J0017998	J0018413	J0018828
	Steel	J0018133	J0018548	J0018963
2.75"	Alum	J0017999	J0018414	J0018829
	Steel	J0018134	J0018549	J0018964
3.50"	Alum	J0018000	J0018415	J0018830
	Steel	J0018135	J0018550	J0018965
4.25"	Alum	J0018001	J0018416	J0018831
	Steel	J0018136	J0018551	J0018966
5.00"	Alum	J0018002	J0018417	J0018832
	Steel	J0018137	J0018552	J0018967
5.75"	Alum	J0018003	J0018418	J0018833
	Steel	J0018138	J0018553	J0018968
6.50"	Alum	J0018004	J0018419	J0018834
	Steel	-	-	-
7.25"	Alum	J0018005	J0018420	J0018835
	Steel	J0018139	J0018554	J0018969
8.00"	Alum	J0018006	J0018421	J0018836
	Steel	J0018140	J0018555	J0018970
8.75"	Alum	J0018007	J0018422	J0018837
	Steel	J0018141	J0018556	J0018971
9.50"	Alum	J0018008	J0018423	J0018838
	Steel	J0018142	J0018557	J0018972
10.25"	Alum	J0018009	J0018424	J0018839
	Steel	J0018143	J0018558	J0018973
11.00"	Alum	J0018010	J0018425	J0018840
	Steel	-	-	-
11.75"	Alum	J0018011	J0018426	J0018841
	Steel	J0018144	J0018559	J0018974
12.50"	Alum	J0018012	J0018427	J0018842
	Steel	-	-	-
13.25"	Alum	J0018013	J0018428	J0018843
	Steel	J0018145	J0018560	J0018975
14.00"	Alum	J0018014	J0018429	J0018844
	Steel	-	-	-
14.75"	Alum	J0018015	J0018430	J0018845
	Steel	-	-	-
15.50"	Alum	J0018016	J0018431	J0018846
	Steel	-	-	-

Length	Mtrl	Black Powder	Chrome Plated	Silver Powder
<b>1/4-28 Threads (in 7/16 Hex Bar)</b>				
3.00"	Alum	J0018020	J0018435	J0018850
	Steel	J0018147	J0018562	J0018977
4.00"	Alum	J0018021	J0018436	J0018851
	Steel	J0018148	J0018563	J0018978
5.00"	Alum	J0018022	J0018437	J0018852
	Steel	J0018149	J0018564	J0018979
6.00"	Alum	J0018023	J0018438	J0018853
	Steel	J0018150	J0018565	J0018980
7.00"	Alum	J0018024	J0018439	J0018854
	Steel	J0018151	J0018566	J0018981
8.00"	Alum	J0018025	J0018440	J0018855
	Steel	J0018152	J0018567	J0018982
9.00"	Alum	J0018026	J0018441	J0018856
	Steel	J0018153	J0018568	J0018983
10.00"	Alum	J0018027	J0018442	J0018857
	Steel	J0018154	J0018569	J0018984
11.00"	Alum	J0018028	J0018443	J0018858
	Steel	J0018155	J0018570	J0018985
12.00"	Alum	J0018029	J0018444	J0018859
	Steel	J0018156	J0018571	J0018986
13.00"	Alum	J0018030	J0018445	J0018860
	Steel	J0018157	J0018572	J0018987
14.00"	Alum	-	-	-
	Steel	J0018158	J0018573	J0018988
15.00"	Alum	J0018031	J0018446	J0018861
	Steel	J0018159	J0018574	J0018989
16.00"	Alum	-	-	-
	Steel	J0018160	J0018575	J0018990
17.00"	Alum	-	-	-
	Steel	J0018161	J0018576	J0018991
18.00"	Alum	J0018032	J0018447	J0018862
	Steel	J0018162	J0018577	J0018992
19.00"	Alum	-	-	-
	Steel	J0018163	J0018578	J0018993
20.00"	Alum	-	-	-
	Steel	J0018164	J0018579	J0018994
21.00"	Alum	-	-	-
	Steel	J0018165	J0018580	J0018995

Length	Mtrl	Black Powder	Chrome Plated	Silver Powder
<b>5/16-24 Threads (in 1/2 Hex Bar)</b>				
3.00"	Alum	J0018033	J0018448	J0018863
	Steel	J0018168	J0018583	J0018998
4.00"	Alum	J0018034	J0018449	J0018864
	Steel	J0018169	J0018584	J0018999
5.00"	Alum	J0018035	J0018450	J0018865
	Steel	J0018170	J0018585	J0019000
6.00"	Alum	J0018036	J0018451	J0018866
	Steel	J0018171	J0018586	J0019001
7.00"	Alum	J0018037	J0018452	J0018867
	Steel	J0018172	J0018588	J0019002
8.00"	Alum	J0018038	J0018453	J0018868
	Steel	J0018173	J0018588	J0019003
9.00"	Alum	J0018039	J0018454	J0018869
	Steel	J0018175	J0018590	J0019005
10.00"	Alum	J0018040	J0018455	J0018870
	Steel	J0018176	J0018591	J0019006
11.00"	Alum	J0018041	J0018456	J0018871
	Steel	J0018177	J0018592	J0019007
12.00"	Alum	J0018042	J0018457	J0018872
	Steel	J0018178	J0018593	J0019008
13.00"	Alum	J0018043	J0018458	J0018873
	Steel	J0018179	J0018594	J0019009
14.00"	Alum	J0018044	J0018459	J0018874
	Steel	J0018180	J0018595	J0019010
15.00"	Alum	J0018045	J0018460	J0018875
	Steel	J0018181	J0018596	J0019011
16.00"	Alum	J0018046	J0018461	J0018876
	Steel	J0018182	J0018597	J0019012
17.00"	Alum	J0018047	J0018462	J0018877
	Steel	J0018183	-	-
18.00"	Alum	J0018048	J0018463	J0018878
	Steel	-	-	-
19.00"	Alum	J0018049	J0018464	J0018879
	Steel	-	-	-
20.00"	Alum	J0018050	J0018465	J0018880
	Steel	-	-	-
21.00"	Alum	J0018051	J0018466	J0018881
	Steel	-	-	-



## Hex Connecting Tubes

Steinjäger hex bar tubes, threaded LH/RH are suitable for suspension linkages, shifting linkages, strut rods, spoiler rods and more. Available in multiple lengths, threads, materials and finishes.

Other length options shown online.



Length	Mtrl	Black Powder	Chrome Plated	Silver Powder
<b>3/8-24 Threads (in 9/16 Hex Bar)</b>				
3.00"	Alum	J0018053	J0018468	J0018883
	Steel	J0018184	J0018599	J0019014
4.00"	Alum	J0018054	J0018469	J0018884
	Steel	J0018185	J0018600	J0019015
5.00"	Alum	J0018055	J0018470	J0018885
	Steel	J0018186	J0018601	J0019016
6.00"	Alum	J0018056	J0018471	J0018886
	Steel	J0018187	J0018602	J0019017
7.00"	Alum	J0018057	J0018472	J0018887
	Steel	J0018188	J0018603	J0019018
8.00"	Alum	J0018058	J0018473	J0018888
	Steel	J0018189	J0018604	J0019019
9.00"	Alum	J0018059	J0018474	J0018889
	Steel	J0018190	J0018605	J0019020
10.00"	Alum	J0018060	J0018475	J0018890
	Steel	J0018191	J0018606	J0019021
11.00"	Alum	J0018061	J0018476	J0018891
	Steel	J0018192	J0018607	J0019022
12.00"	Alum	J0018062	J0018477	J0018892
	Steel	J0018193	J0018608	J0019023
13.00"	Alum	J0018063	J0018478	J0018893
	Steel	J0018194	J0018609	J0019024
14.00"	Alum	J0018064	J0018479	J0018894
	Steel	J0018195	J0018610	J0019025
15.00"	Alum	J0018065	J0018480	J0018895
	Steel	J0018196	J0018611	J0019026
16.00"	Alum	J0018066	J0018481	J0018896
	Steel	J0018197	J0018612	J0019027
17.00"	Alum	J0018067	J0018482	J0018897
	Steel	J0018198	J0018613	J0019028
18.00"	Alum	J0018068	J0018483	J0018898
	Steel	J0018199	J0018614	J0019029
19.00"	Alum	J0018069	J0018484	J0018899
	Steel	J0018200	J0018615	J0019030
20.00"	Alum	J0018070	J0018485	J0018900
	Steel	J0018201	J0018616	J0019031
21.00"	Alum	J0018071	J0018486	J0018901
	Steel	J0018202	J0018617	J0019032

Length	Mtrl	Black Powder	Chrome Plated	Silver Powder
<b>1/2-20 Threads (in 3/4 Hex Bar)</b>				
3.00"	Alum	J0018075	J0018490	J0018905
	Steel	J0018206	J0018621	J0019036
3.50"	Alum	-	-	-
	Steel	J0018207	J0018622	J0019037
4.00"	Alum	J0018076	J0018491	J0018906
	Steel	J0018208	J0018623	J0019038
5.00"	Alum	J0018077	J0018492	J0018907
	Steel	J0018209	J0018624	J0019039
6.00"	Alum	J0018078	J0018493	J0018908
	Steel	J0018210	J0018625	J0019040
7.00"	Alum	J0018079	J0018494	J0018909
	Steel	J0018211	J0018626	J0019041
8.00"	Alum	J0018080	J0018495	J0018910
	Steel	J0018212	J0018627	J0019042
9.00"	Alum	J0018081	J0018496	J0018911
	Steel	J0018213	J0018628	J0019043
10.00"	Alum	J0018082	J0018497	J0018912
	Steel	J0018214	J0018629	J0019044
11.00"	Alum	J0018083	J0018498	J0018913
	Steel	J0018215	J0018630	J0019045
12.00"	Alum	J0018084	J0018499	J0018914
	Steel	J0018216	J0018631	J0019046
13.00"	Alum	J0018085	J0018500	J0018915
	Steel	J0018217	J0018632	J0019047
14.00"	Alum	J0018086	J0018501	J0018916
	Steel	J0018218	J0018633	J0019048
15.00"	Alum	J0018087	J0018502	J0018917
	Steel	J0018219	J0018634	J0019049
16.00"	Alum	J0018088	J0018503	J0018918
	Steel	J0018220	J0018635	J0019050
17.00"	Alum	J0018089	J0018504	J0018919
	Steel	J0018221	J0018636	J0019051
18.00"	Alum	J0018090	J0018505	J0018920
	Steel	J0018222	J0018637	J0019052
19.00"	Alum	J0018091	J0018506	J0018921
	Steel	J0018223	J0018638	J0019053
20.00"	Alum	J0018092	J0018507	J0018922
	Steel	J0018224	J0018639	J0019054

Length	Mtrl	Black Powder	Chrome Plated	Silver Powder
<b>5/8-18 Threads (in 7/8 Hex Bar)</b>				
4.00"	Alum	-	-	-
	Steel	J0018229	J0018644	J0019059
5.00"	Alum	J0018095	J0018510	J0018925
	Steel	J0018230	J0018645	J0019060
6.00"	Alum	J0018096	J0018511	J0018926
	Steel	J0018231	J0018646	J0019061
7.00"	Alum	J0018097	J0018512	J0018927
	Steel	J0018232	J0018647	J0019062
8.00"	Alum	-	-	-
	Steel	J0018233	J0018648	J0019063
9.00"	Alum	J0018098	J0018513	J0018928
	Steel	J0018234	J0018649	J0019064
10.00"	Alum	-	-	-
	Steel	-	-	-
11.00"	Alum	J0018099	J0018514	J0018929
	Steel	J0018235	J0018650	J0019065
12.00"	Alum	J0018100	J0018515	J0018930
	Steel	-	-	-
13.00"	Alum	J0018101	J0018516	J0018931
	Steel	J0018236	J0018651	J0019066
14.00"	Alum	J0018102	J0018517	J0018932
	Steel	-	-	-
15.00"	Alum	J0018103	J0018518	J0018933
	Steel	-	-	-
16.00"	Alum	J0018104	J0018519	J0018934
	Steel	J0018237	J0018652	J0019067
17.00"	Alum	J0018105	J0018520	J0018935
	Steel	-	-	-
18.00"	Alum	J0018106	J0018521	J0018936
	Steel	J0018238	J0018653	J0019068
19.00"	Alum	J0018107	J0018522	J0018937
	Steel	-	-	-
20.00"	Alum	J0018108	J0018523	J0018938
	Steel	-	-	-
21.00"	Alum	J0018109	J0018524	J0018939
	Steel	-	-	-



## Hex Connecting Tubes

Steinjäger hex bar tubes, threaded LH/RH are suitable for suspension linkages, shifting linkages, strut rods, spoiler rods and more. Available in multiple lengths, threads, materials and finishes.

Other length options shown online.



Length	Mtrl	Black Powder	Chrome Plated	Silver Powder
<b>3/4-16 Threads (in 1" Hex Bar)</b>				
4.00"	Alum	J0018110	J0018525	J0018940
	Steel	J0018239	J0018654	J0019069
5.00"	Alum	J0018111	J0018526	J0018941
	Steel	J0018240	J0018655	J0019070
6.00"	Alum	J0018112	J0018527	J0018942
	Steel	J0018241	J0018656	J0019071
7.00"	Alum	J0018113	J0018528	J0018943
	Steel	J0018242	J0018657	J0019072
8.00"	Alum	J0018114	J0018529	J0018944
	Steel	-	-	-
9.00"	Alum	J0018115	J0018530	J0018945
	Steel	J0018243	J0018658	J0019073
10.00"	Alum	J0018116	J0018531	J0018946
	Steel	-	-	-
11.00"	Alum	J0018117	J0018532	J0018947
	Steel	-	-	-
12.00"	Alum	J0018118	J0018533	J0018948
	Steel	-	-	-
13.00"	Alum	J0018119	J0018534	J0018949
	Steel	J0018244	J0018659	J0019074
14.00"	Alum	J0018120	J0018535	J0018950
	Steel	-	-	-
15.00"	Alum	J0018121	J0018536	J0018951
	Steel	-	-	-
16.00"	Alum	J0018122	J0018537	J0018952
	Steel	-	-	-
17.00"	Alum	J0018123	J0018538	J0018953
	Steel	-	-	-
18.00"	Alum	J0018124	J0018539	J0018954
	Steel	-	-	-
19.00"	Alum	J0018125	J0018540	J0018955
20.00"	Alum	J0018126	J0018541	J0018956
21.00"	Alum	J0018127	J0018542	J0018957
22.00"	Alum	J0018128	J0018543	J0018958
23.00"	Alum	J0018129	J0018544	J0018959
24.00"	Alum	J0018130	J0018545	J0018960
25.00"	Alum	J0018131	J0018546	J0018961
26.00"	Alum	J0018132	J0018547	J0018962

Length	Mtrl	Black Powder	Chrome Plated	Silver Powder
<b>M6 x 1.00 Threads (in 11mm Hex Bar)</b>				
40mm	Steel	J0018375	J0018790	J0019205
60mm	Steel	J0018376	J0018791	J0019206
80mm	Steel	J0018377	J0018792	J0019207
110mm	Steel	J0018378	J0018793	J0019208
120mm	Steel	J0018379	J0018794	J0019209
130mm	Steel	J0018380	J0018795	J0019210
140mm	Steel	J0018381	J0018796	J0019211
150mm	Steel	J0018382	J0018797	J0019212
160mm	Steel	J0018383	J0018798	J0019213
170mm	Steel	J0018384	J0018799	J0019214
180mm	Steel	J0018385	J0018800	J0019215
190mm	Steel	J0018386	J0018801	J0019216
200mm	Steel	J0018387	J0018802	J0019217
210mm	Steel	J0018388	J0018803	J0019218
220mm	Steel	J0018389	J0018804	J0019219
230mm	Steel	J0018390	J0018805	J0019220
240mm	Steel	J0018391	J0018806	J0019221
250mm	Steel	J0018392	J0018807	J0019222
<b>M8 x 1.25 Threads (in 13mm Hex Bar)</b>				
50mm	Steel	J0018393	J0018808	J0019223
60mm	Steel	J0018394	J0018809	J0019224
70mm	Steel	J0018395	J0018810	J0019225
80mm	Steel	J0018396	J0018811	J0019226
90mm	Steel	J0018397	J0018812	J0019227
100mm	Steel	J0018398	J0018813	J0019228
110mm	Steel	J0018399	J0018814	J0019229
120mm	Steel	J0018400	J0018815	J0019230
130mm	Steel	J0018401	J0018816	J0019231
140mm	Steel	J0018402	J0018817	J0019232
150mm	Steel	J0018403	J0018818	J0019233
160mm	Steel	J0018404	J0018819	J0019234
170mm	Steel	J0018405	J0018820	J0019235
180mm	Steel	J0018406	J0018821	J0019236
190mm	Steel	J0018407	J0018822	J0019237
200mm	Steel	J0018408	J0018823	J0019238
210mm	Steel	J0018409	J0018824	J0019239
220mm	Steel	J0018410	J0018825	J0019240

Length	Mtrl	Black Powder	Chrome Plated	Silver Powder
<b>M10 x 1.50 Threads (in 16mm Hex Bar)</b>				
70mm	Alum	J0018245	J0018660	J0019075
	Steel	J0018287	J0018702	J0019117
80mm	Alum	J0018246	J0018661	J0019076
	Steel	J0018288	J0018703	J0019118
90mm	Alum	J0018247	J0018662	J0019077
	Steel	J0018289	J0018704	J0019119
100mm	Alum	J0018248	J0018663	J0019078
	Steel	J0018290	J0018705	J0019120
110mm	Alum	J0018249	J0018664	J0019079
	Steel	J0018291	J0018706	J0019121
120mm	Alum	J0018250	J0018665	J0019080
	Steel	J0018292	J0018707	J0019122
130mm	Alum	J0018251	J0018666	J0019081
	Steel	J0018293	J0018708	J0019123
140mm	Alum	J0018252	J0018667	J0019082
	Steel	J0018294	J0018709	J0019124
150mm	Alum	J0018253	J0018668	J0019083
	Steel	J0018295	J0018710	J0019125
160mm	Alum	J0018254	J0018669	J0019084
	Steel	J0018296	J0018711	J0019126
170mm	Alum	J0018255	J0018670	J0019085
	Steel	J0018297	J0018712	J0019127
180mm	Alum	J0018256	J0018671	J0019086
	Steel	J0018298	J0018713	J0019128
190mm	Alum	J0018257	J0018672	J0019087
	Steel	J0018299	J0018714	J0019129
200mm	Alum	J0018258	J0018673	J0019088
	Steel	J0018300	J0018715	J0019130
210mm	Alum	J0018259	J0018674	J0019089
	Steel	J0018301	J0018716	J0019131
220mm	Alum	J0018260	J0018675	J0019090
	Steel	J0018302	J0018717	J0019132
230mm	Alum	J0018261	J0018676	J0019091
	Steel	J0018303	J0018718	J0019133
240mm	Alum	J0018262	J0018677	J0019092
	Steel	J0018304	J0018719	J0019134
<b>M10 x 1.50 Threads - More on Next Page -&gt;</b>				

## Hex Connecting Tubes

Steinjäger hex bar tubes, threaded LH/RH are suitable for suspension linkages, shifting linkages, strut rods, spoiler rods and more. Available in multiple lengths, threads, materials and finishes.

Other length options shown online.



Length	Mtrl	Black Powder	Chrome Plated	Silver Powder
<b>M10 x 1.50 Threads (in 16mm Hex Bar) Continued from Previous Page</b>				
250mm	Alum	J0018263	J0018678	J0019093
	Steel	J0018305	J0018720	J0019135
260mm	Alum	J0018264	J0018679	J0019094
	Steel	J0018306	J0018721	J0019136
270mm	Alum	J0018265	J0018680	J0019095
	Steel	J0018307	J0018722	J0019137
280mm	Alum	J0018266	J0018681	J0019096
	Steel	J0018308	J0018723	J0019138
290mm	Alum	J0018267	J0018682	J0019097
	Steel	J0018309	J0018724	J0019139
300mm	Alum	J0018268	J0018683	J0019098
	Steel	J0018310	J0018725	J0019140
310mm	Alum	J0018269	J0018684	J0019099
	Steel	J0018311	J0018726	J0019141
320mm	Alum	J0018270	J0018685	J0019100
	Steel	J0018312	J0018727	J0019142
330mm	Alum	J0018271	J0018686	J0019101
	Steel	J0018313	J0018728	J0019143
340mm	Alum	J0018272	J0018687	J0019102
	Steel	J0018314	J0018729	J0019144
350mm	Steel	J0018315	J0018730	J0019145
360mm	Steel	J0018316	J0018731	J0019146
370mm	Steel	J0018317	J0018732	J0019147
380mm	Steel	J0018318	J0018733	J0019148
390mm	Steel	J0018319	J0018734	J0019149
400mm	Steel	J0018320	J0018735	J0019150
410mm	Steel	J0018321	J0018736	J0019151
420mm	Steel	J0018322	J0018737	J0019152
460mm	Steel	J0018323	J0018738	J0019153
510mm	Steel	J0018324	J0018739	J0019154
520mm	Steel	J0018325	J0018740	J0019155

Length	Mtrl	Black Powder	Chrome Plated	Silver Powder
<b>M12 x 1.75 Threads (in 19mm Hex Bar)</b>				
55mm	Steel	J0018326	J0018741	J0019156
70mm	Steel	J0018327	J0018742	J0019157
80mm	Steel	J0018328	J0018743	J0019158
90mm	Steel	J0018329	J0018744	J0019159
100mm	Steel	J0018330	J0018745	J0019160
110mm	Steel	J0018331	J0018746	J0019161
120mm	Steel	J0018332	J0018747	J0019162
130mm	Steel	J0018333	J0018748	J0019163
140mm	Steel	J0018334	J0018749	J0019164
150mm	Alum	J0018273	J0018688	J0019103
	Steel	J0018335	J0018750	J0019165
160mm	Alum	J0018274	J0018689	J0019104
	Steel	J0018336	J0018751	J0019166
170mm	Alum	J0018275	J0018690	J0019105
	Steel	J0018337	J0018752	J0019167
180mm	Alum	J0018276	J0018691	J0019106
	Steel	J0018338	J0018753	J0019168
190mm	Alum	J0018277	J0018692	J0019107
	Steel	J0018339	J0018754	J0019169
200mm	Alum	J0018278	J0018693	J0019108
	Steel	J0018340	J0018755	J0019170
210mm	Alum	J0018279	J0018694	J0019109
	Steel	J0018341	J0018756	J0019171
220mm	Alum	J0018280	J0018695	J0019110
	Steel	J0018342	J0018757	J0019172
230mm	Alum	J0018281	J0018696	J0019111
	Steel	J0018343	J0018758	J0019173
240mm	Alum	J0018282	J0018697	J0019112
	Steel	J0018344	J0018759	J0019174
250mm	Alum	J0018283	J0018698	J0019113
	Steel	J0018345	J0018760	J0019175

Length	Mtrl	Black Powder	Chrome Plated	Silver Powder
<b>M12 x 1.75 Threads (in 19mm Hex Bar) Continued from Previous Column</b>				
260mm	Alum	J0018284	J0018699	J0019114
	Steel	J0018346	J0018761	J0019176
270mm	Alum	J0018285	J0018700	J0019115
	Steel	J0018347	J0018762	J0019177
280mm	Alum	J0018286	J0018701	J0019116
	Steel	J0018348	J0018763	J0019178
290mm	Steel	J0018349	J0018764	J0019179
300mm	Steel	J0018350	J0018765	J0019180
310mm	Steel	J0018351	J0018766	J0019181
320mm	Steel	J0018352	J0018767	J0019182
330mm	Steel	J0018353	J0018768	J0019183
340mm	Steel	J0018354	J0018769	J0019184
350mm	Steel	J0018355	J0018770	J0019185
360mm	Steel	J0018356	J0018771	J0019186
370mm	Steel	J0018357	J0018772	J0019187
380mm	Steel	J0018358	J0018773	J0019188
390mm	Steel	J0018359	J0018774	J0019189
400mm	Steel	J0018360	J0018775	J0019190
410mm	Steel	J0018361	J0018776	J0019191
420mm	Steel	J0018362	J0018777	J0019192
430mm	Steel	J0018363	J0018778	J0019193
440mm	Steel	J0018364	J0018779	J0019194
450mm	Steel	J0018365	J0018780	J0019195
460mm	Steel	J0018366	J0018781	J0019196
470mm	Steel	J0018367	J0018782	J0019197
480mm	Steel	J0018368	J0018783	J0019198
490mm	Steel	J0018369	J0018784	J0019199
500mm	Steel	J0018370	J0018785	J0019200
510mm	Steel	J0018371	J0018786	J0019201
520mm	Steel	J0018372	J0018787	J0019202
530mm	Steel	J0018373	J0018788	J0019203
540mm	Steel	J0018374	J0018789	J0019204



### THREAD BUNGS



Steinjäger thread bungs are made from 4130 Chrome Moly and are available as prepackaged quantities. See website for other sizes and styles.

Thread	fits Tubing	Part#	Qty
3/8-24 RH	0.625 x 0.058	J0015323	10
3/8-24 LH	0.625 x 0.058	J0015311	10
3/8-24 RH	0.750 x 0.058	J0015324	10
3/8-24 LH	0.750 x 0.058	J0015312	10
3/8-24 RH	0.875 x 0.058	J0015331	12
3/8-24 LH	0.875 x 0.058	J0015319	12
3/8-24 RH	0.875 x 0.065	J0015330	12
3/8-24 LH	0.875 x 0.065	J0015318	12
3/8-24 RH	0.875 x 0.083	J0015329	12
3/8-24 LH	0.875 x 0.083	J0015317	12
3/8-24 RH	1.000 x 0.058	J0015328	10
3/8-24 LH	1.000 x 0.058	J0015316	10
3/8-24 RH	1.000 x 0.065	J0015327	10
3/8-24 LH	1.000 x 0.065	J0015315	10
3/8-24 RH	1.000 x 0.083	J0015326	10
3/8-24 LH	1.000 x 0.083	J0015314	10
3/8-24 RH	1.000 x 0.095	J0015325	10
3/8-24 LH	1.000 x 0.095	J0015313	10
1/2-20 RH	0.875 x 0.058	J0015246	10
1/2-20 LH	0.875 x 0.058	J0015227	10
1/2-20 RH	0.875 x 0.065	J0015245	10
1/2-20 LH	0.875 x 0.065	J0015226	10
1/2-20 RH	0.875 x 0.083	J0015244	10
1/2-20 LH	0.875 x 0.083	J0015225	10
1/2-20 RH	1.000 x 0.058	J0015258	5
1/2-20 LH	1.000 x 0.058	J0015239	5
1/2-20 RH	1.000 x 0.065	J0015257	5
1/2-20 LH	1.000 x 0.065	J0015238	5
1/2-20 RH	1.000 x 0.083	J0015256	5
1/2-20 LH	1.000 x 0.083	J0015237	5
1/2-20 RH	1.000 x 0.095	J0015247	10
1/2-20 LH	1.000 x 0.095	J0015228	10
1/2-20 RH	1.125 x 0.058	J0015251	10
1/2-20 LH	1.125 x 0.058	J0015232	10
1/2-20 RH	1.125 x 0.065	J0015250	10
1/2-20 LH	1.125 x 0.065	J0015231	10
1/2-20 RH	1.125 x 0.083	J0015249	10
1/2-20 LH	1.125 x 0.083	J0015230	10

Thread	fits Tubing	Part#	Qty
1/2-20 RH	1.125 x 0.095	J0015248	10
1/2-20 LH	1.125 x 0.095	J0015229	10
5/8-18 RH	1.000 x 0.058	J0015386	5
5/8-18 LH	1.000 x 0.058	J0015360	5
5/8-18 RH	1.000 x 0.065	J0015385	5
5/8-18 LH	1.000 x 0.065	J0015359	5
5/8-18 RH	1.000 x 0.083	J0015384	5
5/8-18 LH	1.000 x 0.083	J0015358	5
5/8-18 RH	1.000 x 0.095	J0015369	10
5/8-18 LH	1.000 x 0.095	J0015343	10
5/8-18 RH	1.125 x 0.058	J0015390	5
5/8-18 LH	1.125 x 0.058	J0015364	5
5/8-18 RH	1.125 x 0.065	J0015389	5
5/8-18 LH	1.125 x 0.065	J0015363	5
5/8-18 RH	1.125 x 0.083	J0015388	5
5/8-18 LH	1.125 x 0.083	J0015362	5
5/8-18 RH	1.125 x 0.095	J0015387	5
5/8-18 LH	1.125 x 0.095	J0015361	5
5/8-18 RH	1.250 x 0.085	J0015382	4
5/8-18 LH	1.250 x 0.085	J0015356	4
5/8-18 RH	1.250 x 0.095	J0015371	2
5/8-18 LH	1.250 x 0.095	J0015345	2
5/8-18 RH	1.250 x 0.120	J0015370	2
5/8-18 LH	1.250 x 0.120	J0015344	2
5/8-18 RH	1.375 x 0.095	J0015392	5
5/8-18 LH	1.375 x 0.095	J0015366	5
5/8-18 RH	1.375 x 0.120	J0015391	5
5/8-18 RH	1.375 x 0.120	J0015365	5
3/4-16 RH	1.125 x 0.083	J0015290	10
3/4-16 LH	1.125 x 0.083	J0015268	10
3/4-16 RH	1.125 x 0.095	J0015289	10
3/4-16 LH	1.125 x 0.095	J0015267	10
3/4-16 RH	1.250 x 0.095	J0015300	20
3/4-16 LH	1.250 x 0.095	J0015278	20
3/4-16 RH	1.250 x 0.120	J0015299	20
3/4-16 LH	1.250 x 0.120	J0015277	20
3/4-16 RH	1.375 x 0.095	J0015308	5
3/4-16 LH	1.375 x 0.095	J0015286	5
3/4-16 RH	1.750 x 0.120	J0015298	2
3/4-16 LH	1.750 x 0.120	J0015276	2
3/4-16 RH	1.750 x 0.250	J0015297	2
3/4-16 LH	1.750 x 0.250	J0015275	2
7/8-14 RH	1.500 x 0.120	J0015403	2
7/8-14 LH	1.500 x 0.120	J0015395	2
7/8-14 RH	1.500 x 0.250	J0015406	4
7/8-14 LH	1.500 x 0.250	J0015398	4
7/8-14 RH	1.750 x 0.120	J0015408	4
7/8-14 LH	1.750 x 0.120	J0015400	4

Thread	fits Tubing	Part#	Qty
7/8-14 RH	1.750 x 0.250	J0015402	2
1-12 RH	1.750 x 0.120	J0015220	2
1-12 LH	1.750 x 0.120	J0015211	2
1-14 RH	1.750 x 0.120	J0015221	2
1-14 LH	1.750 x 0.120	J0015212	2
1-14 RH	1.750 x 0.250	J0015219	2
1-14 LH	1.750 x 0.250	J0015210	2
1.25-12 RH	1.750 x 0.120	J0015206	2
1.25-12 LH	1.750 x 0.120	J0015204	2
M6x1.00 RH	fits 10mm id	J0015426	25
M6x1.00 LH	fits 10mm id	J0015425	25
M8x1.25 RH	fits 12mm id	J0015428	10
M8x1.25 LH	fits 12mm id	J0015427	10
M10x1.50 RH	fits 15mm id	J0015413	5
M10x1.50 LH	fits 15mm id	J0015411	5
M12x1.75 RH	fits 17mm id	J0015416	10
M12x1.75 LH	fits 17mm id	J0015414	10
M14x2.00 RH	fits 10mm id	J0015419	2
M16x2.00 RH	fits 21mm id	J0015423	2
M16x2.00 LH	fits 21mm id	J0015421	2

### INSERTS - PLATED STEEL



Rod End Bore	ID of Insert	Part#	Qty
3/8	5/16	J0014227	10
1/2	3/8	J0014191	10
5/8	1/2	J0014239	4
3/4	1/2	J0014215	4
3/4	5/8	J0014214	4
7/8	5/8	J0014242	12
7/8	3/4	J0014243	12
1.0"	1/2	J0014185	4
1.0"	9/16	J0014188	8
1.0"	5/8	J0014184	4
1.0"	3/4	J0014187	8
10mm	8mm	J0014199	10
12mm	8mm	J0014203	20
12mm	10mm	J0014202	20

INSERTS - STAINLESS STEEL			
Rod End Bore	ID of Insert	Part#	Qty
5/8	1/2	J0014238	4
3/4	1/2	J0014213	4
3/4	5/8	J0014212	4
1.0"	5/8	J0014182	4
1.0"	3/4	J0014183	4
12mm	10mm	J0014205	8



**Parachute Cables**

- 10-32 Threads
- Grooved Style on one end, bar wire on the other
- 3" travel



**Spherical Rod End Output End**

J0013139 144" overall length  
 J0013143 180" overall length  
 J0013145 216" overall length



**Forged Clevis Output End**

J0013141 144" overall length  
 J0013144 180" overall length  
 J0013147 216" overall length



**Disconnect Ball Joint Output End**

J0013140 144" overall length  
 J0013143 180" overall length  
 J0013146 216" overall length

**Shifter Cables Bulkhead**



1/4-28 thds

J0013156	44"	J0013165	64"	J0013173	77"	J0013149	108"
J0013157	46"	J0013166	65"	J0013174	78"	J0013151	112"
J0013158	48"	J0013167	66"	J0013176	84"	J0013152	120"
J0013160	54"	J0013169	69"	J0013177	90"	J0013154	132"
J0013162	56"	J0013170	72"	J0013178	96"		
J0013163	60"	J0013172	76"	J0013148	102"		

**Shifter Cables Grooved**



1/4-28 thds

J0013159	48"	J0013175	78"
J0013161	54"	J0013179	96"
J0013164	60"	J0013150	108"
J0013168	66"	J0013153	120"
J0013171	72"	J0013155	144"

**Ladder Bar Adjuster**



Steinjäger Ladder Bar Adjusters are plated zinc silver and come as C1045 or 4130 chrome moly steel.

1/2-20 C1045		5/8-18 C1045		3/4-16 C1045		1"-12 C1045		5/8-18 Moly		3/4-16 Moly	
Part#	Qty	Part#	Qty	Part#	Qty	Part#	Qty	Part#	Qty	Part#	Qty
J0015185	5	J0015191	2	J0015189	2	J0015183	4	J0015190	2	J0015188	2
J0015184	30	J0015193	25	J0015187	12			J0015192	25	J0015186	12
OAL: 3.625"		OAL: 3.875"		OAL: 4.125"		OAL: 6.125"		OAL: 3.875"		OAL: 4.125"	

**Spacer Washers**



plated

1/4" Bore		5/16" Bore		3/8" Bore		7/16" Bore		1/2" Bore		5/8" Bore		3/4" Bore	
Part#	Qty	Part#	Qty	Part#	Qty	Part#	Qty	Part#	Qty	Part#	Qty	Part#	Qty
J0015451	10	J0015460	10	J0015457	10	J0015465	10	J0015446	10	J0015463	4	J0015456	4
J0015452	100	J0015461	100	J0015458	100	J0015466	100	J0015450	60	J0015464	50	J0015454	20
0.142" Thick		0.168" Thick		0.184" Thick		0.220" Thick		0.228" Thick		0.270" Thick		0.300" Thick	

**Ball Joints Disconnect**

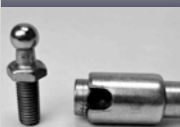

Plated Steel Housing and Stud. The studs can be easily removed by sliding back the spring loaded housing. Great for throttle cables and light duty linkages.

10-32 House & Stud		10-32 Hs'g 1/4-28 Stud		1/4-28 House & Stud		3/8-24 House & Stud	
Part#	Qty	Part#	Qty	Part#	Qty	Part#	Qty
J0012069	1	J0012071	10	J0012068	5	J0012076	10
J0012070	10	J0012075	50	J0012067	25	J0012077	50
J0012074	50	J0012073	250	J0012066	150		
J0012072	250						

**Solid Rod Ends**



Made from low carbon steel, bright chrome plated. Length is base to center of eye.

1/2-20 x 1/2		5/8-18 x 5/8		3/4-16 x 3/4		3/4-16 x 1/2		3/4-16 x 5/8		3/4-16 x 5/8 XL	
Part#	Qty	Part#	Qty	Part#	Qty	Part#	Qty	Part#	Qty	Part#	Qty
J0014624	2	J0014927	5	J0014760	2	J0014759	2	J0014758	2	J0014757	2
J0014629	30	J0014920	10	J0014789	4	J0014788	4	J0014787	4	J0014786	4
2.437" Long		2.625" Long		2.875" Long		2.875" Long		2.500" Long		2.875" Long	







Steinjäger shifter linkages are made from 9/16" steel hex bar and are powder painted silver. The spherical rod ends are zinc plated with a PTFE bearing race. Linkages come with LH/RH threads and have ±0.563" adjustment to nominal.

Length	Part#	Length	Part#
5.00"	J0014478	16.00"	J0014467
6.00"	J0014479	17.00"	J0014468
7.00"	J0014480	18.00"	J0014469
8.00"	J0014481	19.00"	J0014470
9.00"	J0014482	20.00"	J0014471
10.00"	J0014461	21.00"	J0014472
11.00"	J0014462	22.00"	J0014473
12.00"	J0014463	23.00"	J0014474
13.00"	J0014464	24.00"	J0014475
14.00"	J0014465	25.00"	J0014476
15.00"	J0014466	26.00"	J0014477



Our shifter linkages are made from 3/8" aluminum hex bar and are powder painted black. The spherical rod ends are aluminum with a nylon bearing race. Linkages come with LH/RH threads and have +0.438/-0.500" adjustment to nominal.

Length	Part#	Length	Part#
3.50"	J0015150	11.75"	J0015139
4.25"	J0015151	12.50"	J0015140
5.00"	J0015152	13.25"	J0015141
5.75"	J0015153	14.00"	J0015142
6.50"	J0015154	14.75"	J0015143
7.25"	J0015156	15.50"	J0015144
8.00"	J0015155	16.25"	J0015145
8.75"	J0015157	17.00"	J0015146
9.50"	J0015158	17.75"	J0015147
10.25"	J0015159	18.50"	J0015148
11.00"	J0015160	19.25"	J0015149

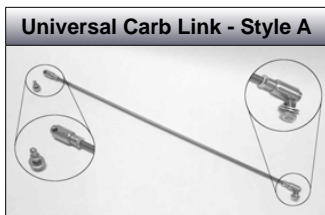

This family of carb linkages is made from 1/4" Ø steel, zinc plated, and is threaded 1/4-28 RH/LH. Assembly has ±0.125" overall adjustment. Both ends have spring loaded quick disconnect plated ball joints.

Length	Part#	Length	Part#
22.00"	J0013180	24.00"	J0013188
22.50"	J0013182	24.50"	J0013190
23.00"	J0013184	25.00"	J0013192
23.50"	J0013186	26.00"	J0013194



This family of carb linkages is made from 1/4" Ø steel, zinc plated, and is threaded 1/4-28 RH/LH. Assembly has ±0.250" overall adjustment. One end has a plated steel female rod end, and the other has a spring loaded quick disconnect ball joint.

Length	Part#	Length	Part#
22.25"	J0013181	24.25"	J0013189
22.75"	J0013183	24.75"	J0013191
23.25"	J0013185	25.25"	J0013193
23.75"	J0013187	26.25"	J0013195



Part# J0013196: This multicarb kit will give your Offenhauser Triple Intake Manifold (5205) a cleaner look and better functionality. Four shorter links are 10-32 threads. The longest link is 1/4-28.



Color	Part#
Silver	J0023973
Black	J0023974

This 3/4" Ø steel bar is 26" long, powder painted, assembled to rubber bumpers, has a reusable netting cover.

