



United Pacific

1947-1987 CHEVY & GMC



As leaders in the industry, it is our mission to ensure the best fitment and function when it comes to your custom build. We understand the rigors and stresses that our products are subjected to on the road, so we partner with top manufacturing facilities that conform to our strict requirements and must perform quality assurance tests. It is our duty to provide our customers with products of superior quality and reliability.



QUALITY

With over 30 years of experience in the automotive aftermarket industry, United Pacific Industries understands the rigors and stresses that our products are subjected to on the road. It is our mission to provide our customers with products of superior quality and reliability. In achieving this goal, United Pacific only partners with manufacturing facilities that conforms to our quality control requirements and standards. Our manufacturing partners meet or exceed ISO-9001 requirements. In addition, United Pacific's manufacturing partners must be equipped on site to perform the following quality assurance tests and maintain a track record of consistent quality and low product failure rate.

- Aging Test
- Air Tight Test
- Dust Test
- Flux Test
- Photometric Test
- Pull Force Test
- Rain Test
- Salt Spray Test
- Shock Test
- Temperature Test
- Humidity Test
- Vibration Test

Furthermore, our internal quality control structure allows us to function as the final quality control station prior to shipping. With the assistance of 3D computer technology, United Pacific can adhere to strict quality control standards during prototype creation and the production process. Our engineers and technicians perform a battery of tests to ensure that our products meet the demands of today's drivers and our goal to be first in quality.

INNOVATION

Known as the leader in innovation, United Pacific is dedicated to be the first to bring new and exciting products to the market. United Pacific's global expertise allows us to search the globe for new ideas and concepts. Not only do we search the globe for new products, United Pacific invest a significant amount of resources into our own research and development efforts. With the assistance of advance 3D scanning technology, our engineers and designers can acquire accurate and precise data in seconds. The 3D data allows United Pacific to verify designs, perform quality assurance tests, and reverse engineer with unprecedented speed and accuracy. Digital inspection contributes to the early detection of shape problems, provides rapid feedback on design, and eliminates unnecessary work in downstream processes. Our rapid prototyping facility permits us to have a concept-to-shelf time of less than 5 months. In addition, United Pacific's 3D printing capabilities permit our designers to have physical models of their design concepts in hours. The physical models allow our designers and marketing staff to evaluate and test the viability of different design ideas. Our rapid prototyping facility allow United Pacific to compress design cycles, improve manufacturing planning, shorten concept-to-shelf time, most importantly, generate new and innovative products.

DESIGN

Located near some of the nation's most progressive automotive design centers, United Pacific established the UP Design Studio in 2002 to consolidate our position as the design leader in the automotive industry. UP Design Studio utilizes the latest generation of computer aided design (CAD) and studio/graphic software. The design studio is equipped with the newest computers and rapid prototyping systems. In addition, UP Design Studio is staffed by graduates from the nation's most prestigious design colleges. Unlike our competitors, United Pacific's design and manufacturing capabilities mean that we carry more new and original items than our competitors. The establishment of the design studio will enable us to generate even more new products with significant shorter concept-to-shelf time. The reduction in development cost mean that we can develop products utilizing design based development processes. Design based product development allows United Pacific to create new product concepts based on designs incorporating driver demands and needs instead of economic considerations. United Pacific's emphasis on design distinguishes and positions us ahead of our competitors.

INVENTORY AND SHIPPING

United Pacific carries over 20,000 items in our California distribution center. No other company in the heavy duty trucking industry can match United Pacific in the variety and range of in-stock inventories. With an order fill rate of over 98.5%, United Pacific is the largest and most reliable supplier in the industry. Our shipping department ships 96.8% of all orders within 24 hours and 98.9% within 48 hours. United Pacific's vast inventory and prompt shipping has made United Pacific the only source for our customer's chrome and lighting needs.



HARD AT WORK FOR THE ENVIRONMENT



United Pacific
132,000 sq ft
Distribution Center
Long Beach, CA

100% reduction in potable water used for landscaping

40% reduction in total energy use due to high-efficiency mechanical and lighting systems

82% of construction waste was diverted from landfills

LEED ACCOMPLISHMENTS

Sustainable Sites

- On-site bicycle storage, showers and changing areas for company employees.
- Preferred parking for low-emitting, fuel-efficient and carpool vehicles.
- Stormwater is infiltrated on-site and treated to remove contaminants to reduce environmental impact on local waterways.

Water Efficiency

- In addition to using reclaimed water, drought-tolerant plants and a high-efficiency irrigation system were installed to reduce the use of potable water for irrigation by 100%.

Energy and Atmosphere

- Efficient HVAC equipment and a lighting system with daylight controls reduces energy consumption by over 30%.
- Enhanced commission verifies that the building's energy and water-related systems are performing as intended by the initial design.

Indoor Environmental Quality

- Building ventilation systems was designed to provide enhanced levels of fresh outside air to building occupants.
- Interior finishes (plants, sealants, adhesives, coatings, carpet systems and composite wood) were selected with low levels of volatile organic compounds (VOCs) to reduce indoor air contamination.



TABLE OF CONTENTS

Week To Wicked	7-8	Glove Box / Hand Brake Covers / Pedals	95
Shortbed Body Panels	9-10	AC Vents / Defrost Ducts	96
Headlights	11-24	Vent Windows / Glass Channels	97-98
Headlight Bulbs / Adapters / Relay	25	Door Handles	99-100
LED Control Module	26	Window Regulators	101
Misc. Headlight Parts	27-28	Door Sill / Door Latch Relay	102
Headlight Visors	29-30	Door Latches / Striker Plates	103-104
Tail Lights	31-43	Running Boards / Bedside Steps	105-106
Tail Light Bezels	44	Gas Caps	107
Tail Light Housings / Brackets	45	Fuel Tanks	108
Tail Light Gasket / Backup Lights	46	Fuel Sending Units	109-110
Parking Lights	48-52	Hood Emblem	111
Parking Light Bezels / Gaskets	53-54	Hub Caps / Exhaust Deflector	112
Side Marker Lights	55-56	License Plate Frames	113-114
Misc. Lights	57-58	Horns / Compressor	115-116
License Light / Bracket w/ Light	59-60	Terms and Conditions	117-118
Bumpers	61-64	Warranty Policy / Returns	119-120
Grilles	65-66	Index	121-124
Hood Parts	67-68		
Battery Hold Downs / Trays Etc.	69-70		
Exterior Mirrors	71-78		
Wiper Blades / Arms	79-80		
Rear View Mirrors	81-84		
Gauge Packages	85-86		
Dash Knobs / Cables	87-88		
Switches / Shift knobs	89-90		
Steering Columns / Hub / Horn	91-92		
Steering Wheels	93-94		



**UNITED PACIFIC
WEEK TO WICKED 1971 CHEVY C10 BUILD**



In the most recent installment of Week to Wicked presented by Classic Trucks Magazine, United Pacific and the team over at the MotorTrend Tech Center in Santa Ana, California, banded together to transform a stock 1971 Chevy C10 Pick-up truck to a WICKED street performance ride...in just ONE WEEK! The build started off with the usual wrenches and sparks flying as the guys stripped the truck down in preparation for the complete restoration. Things motored along as we raced towards the final days updating the build with a new suspension, drivetrain, brakes, and steering components, a fresh set of wheels and tires, and some interior redecorating. As we finally reached the finish line, it was time to fire up the C10's ZZ6 small-block. The engine came to life on the first crank leaving the crew excited for the test drive and of course, the obligatory burnout.

THANKS TO ALL THAT HELPED WITH THE BUILD



United Pacific Industries:

Sheetmetal, Lighting, Restoration Products

Classic Performance Products:

Presenting (Steering, Dual Adjustable Coilover Suspension, 6 Piston Modular Brakes, EFI Fuel Tank)

Covercraft:

Official Car Cover

Dakota Digital:

Official Gauges (HDX Series)

Holley Performance:

Dual Quad Terminator EFI, Exhaust (Hooker Blackheart) & Radiator (Frostbite)

Strange Engineering:

Strange Bolt-In Housing for 67-72 c10, 3.70 Ratio, 31 Spline Axles

Gandrud Chevrolet:

Crate Engine- ZZ6 Chevy Small Block 405 horsepower and 406 lb.-ft. of torque

Old Air Products:

Air Conditioning- Hurricane Bolt in kit

American Legend:

Wheels- Racer series wheels 18x8 Front, 18X9 Rear

Gearstar Transmission:

200-4R Transmission

Custom Auto Sound Mfg:

Official Product (Bluetooth Audio System)

American Autowire:

Official Product (Classic Update Series Wiring Harness)

Odyssey Battery/Ha B&M Sports:

Official Product (Performance Series AGM Battery)

Procar by Scat:

Official Product (Seats)

Yank Performance:

Torque Converter

SHORTBED BODY PANELS

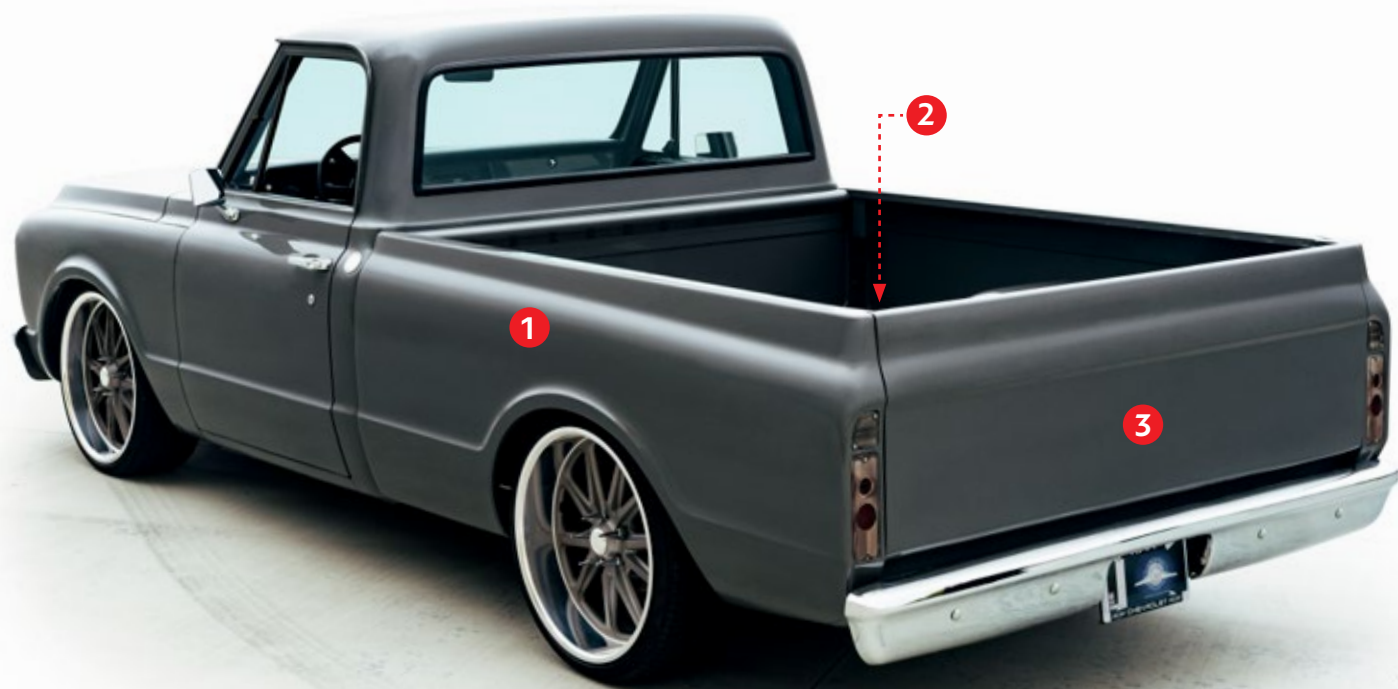

Bedside exterior

1968-72 Chevy & GMC Fleetside Truck

SHORTBED BEDSIDE PANELS

- Reproduced exactly like the original with high quality 20-gauge steel, stamped with all the original contour and detail
- Complete bedside, includes installed and spot welded 17 gauge inner liner
- Features 3/8-16 and 5/16-18 threads welded in between exterior steel panel and inner reinforcement
- Black EDP Coated
- Includes rubber tailgate bumpers
- Has side marker cutout for 1968-72, but can be used on 1967 if side marker is desired
- Packed in heavy-duty cardboard box

110829 | LH/Driver | 1Pc. / Box

110830 | RH/Passenger | 1Pc. / Box



Bedside interior

--- Pre-welded wheel well nuts

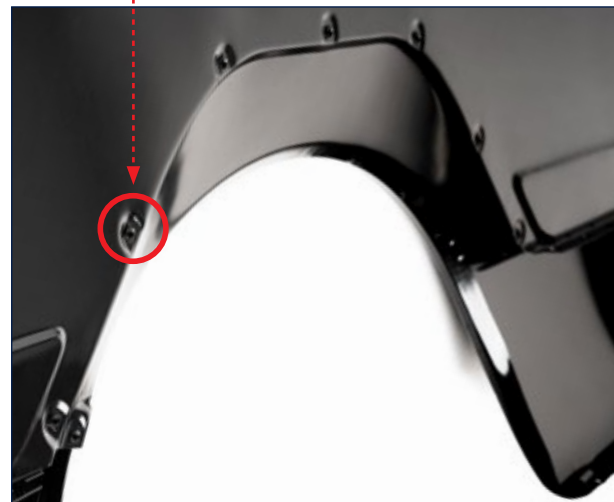

UNITED PACIFIC BODY PANELS

United Pacific is the source for quality body panels for long bed to short bed conversions. By reverse engineering each panel with exact specifications and modern technology, we are able to create a complete replica of short bed C10 bedside, bed floor pan and tailgate panels. Our high-quality heavy steel panels are manufactured with mounting holes and feature our exclusive welded nut inserts for the wheel well, tailgate pivot trunnion, tailgate support and striker.

United Pacific's goal is to ensure that our parts have the best possible fit and make sure installation is a breeze. We are here to help the C10 community restore and rebuild the truck of their dreams.

SHORTBED BODY PANELS

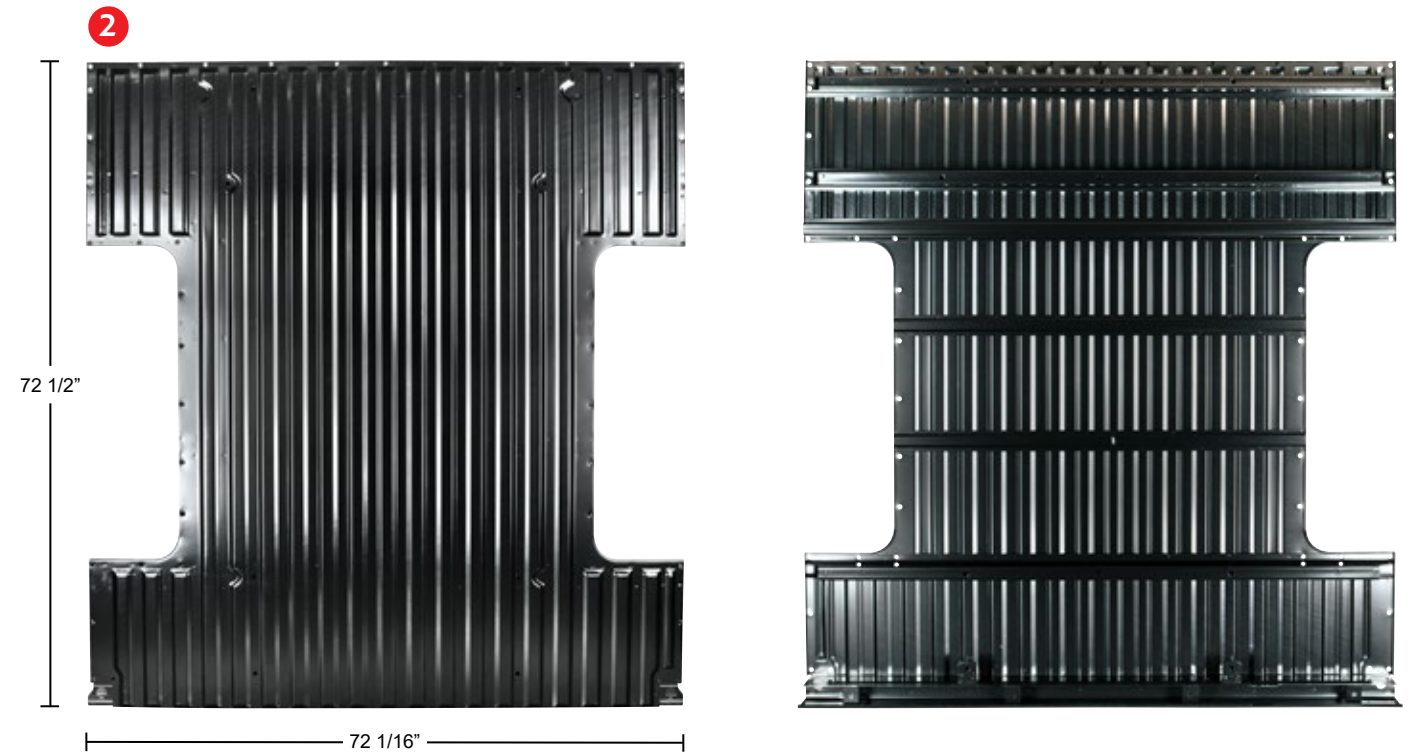

1967-72 Chevy & GMC Fleetside Shortbed Truck

6-1/2' BED FLOOR PAN

- 6-1/2' Bed Floor Pan For 1967-72 Chevy & GMC Truck Fleetside Shortbed
- Excellent stamped sheet metal reproduction with all of the original contour detail
- Quality 18 gauge floor panel with spot welded heavy 14 gauge crossmembers
- Features precision punched mounting holes for easy bed front, bed side, and wheel well installation
- Finished with black EDP protective coating

110839



1967-72 Chevy & GMC Fleetside Truck

TAILGATES

- Die stamped quality 17 gauge steel
- Precision cut latch handle pocket with mounting holes
- Two welded 5/16-18 nuts on each side for latch mounting
- Includes tailgate linkage posts and tailgate trunnion pockets
- Finish with black EDP protective coating to keep your new steel fresh and rust-free
- Official GM licensed for GMC lettering

110845 | Plain

110846 | Recessed Chevrolet Lettering

110847 | Recessed GMC Lettering

LED HEADLIGHTS



Universal

7" LED HEADLIGHT W/ POSITION LIGHT

- High power LED headlight with LED turn signal and position light bar
- Reinforced aluminum reflector with rugged anti-vibration construction
- Easy connection, fits OEM housing or fender, plugs into existing wiring harness, position light requires additional wiring
- DOT/SAE approved, sold individually

31458 | Amber LED Position Light Bar

31459 | White LED Position Light Bar



Universal

7" LED HEADLIGHT-BLACK

- 5 high power LED 7" headlight, Philips Lumileds
- Reinforced aluminum reflector with rugged anti-vibration construction
- Sold individually

31289



Universal

7" LED HEADLIGHT-CHROME

- 5 high power LED 7" headlight, Philips Lumileds
- Reinforced aluminum reflector with rugged anti-vibration construction
- DOT/SAE compliant, sold individually

31391

LED HEADLIGHTS



Universal

7" LED HEADLIGHT W/ POSITION LIGHT BAR

- High power LED headlight with 2 LED position light bar
- Dual function headlight with high and low beam
- Reinforced aluminum reflector with rugged anti-vibration construction
- Easy connection, fits OEM housing or fender, plugs into existing wiring harness, position light requires additional wiring
- DOT/SAE approved, sold individually

31200



Universal

7" LED HEADLIGHT W/ POSITION LIGHT BAR

- 3 high power LED headlight with 10 LED dual function position light bar
- 900 lumen output on low, 1,600 lumen output on high
- White position light bar can be wired as daytime running light and amber position light bar can be wired as turn signal
- Easy installation, fits OEM housing, plugs into existing wiring harness
- DOT/SAE approved, sold individually

31513 | White LED Position Light Bar

31514 | Amber LED Position Light Bar

LED HEADLIGHTS



LED HEADLIGHTS



Universal

7" LED CRYSTAL HEADLIGHT-CHROME

- 11 high power LED 7" headlight, impact resistant polycarbonate lens provides unparalleled protection from road hazards
- Die-cast aluminum housing provides maximum protection from the elements
- DOT/SAE compliant, sold individually

31355



Universal

7" LED PROJECTION HEADLIGHT W/ LED HALO

- 7" high power projection headlight with dual function LED halo ring
- Dual color white/amber auxiliary LED halo ring with amber automatic override feature
- Die-cast housing and polycarbonate lens provide maximum protection and durability
- Solid state design resists shock and vibration, IP67 weatherproof rating
- DOT/SAE compliant, sold individually

31496



Universal

7" LED HEADLIGHT

- 7" high power LED headlight
- Durable corrosion resistant polycarbonate lens & housing
- Solid state design resists shock and vibration, DOT/SAE headlight compliant
- Easy connection, fits OEM housing, plugs into existing wiring harness, position light requires additional wiring
- Low beam 500 lumens, high beam 950 lumens

31084

HEADLIGHTS W/ LED POSITION



Universal

7" CRYSTAL HEADLIGHT W/ LED HALO RING

- 7" crystal headlight with LED halo ring and 9007 bulb
- Reinforced aluminum reflector with rugged anti-vibration construction
- Sold individually

31284 | Amber LED Halo Ring

31285 | White LED Halo Ring



Universal

7" CRYSTAL HEADLIGHT W/ AUXILIARY LED

- High power LED 7" headlight with clear lens, 34 auxiliary LED
- Reinforced aluminum reflector with rugged anti-vibration construction
- H4/HB2/9003 halogen bulb: 12V 65/55W, replaces H6017/H6024
- HB2/9003 DOT/SAE code: DOT SAE-HR1-01
- DOT/SAE compliant, sold individually

31378 | Amber Auxiliary LED

31379 | White Auxiliary LED

Universal

7" CRYSTAL HEADLIGHT W/ LED POSITION LT

- 7" crystal headlight with 6 hi/low function amber LED position lights
- Reinforced aluminum reflector with rugged anti-vibration construction
- DOT/SAE Hr 15, LED for auxiliary/utility purposes, sold individually
- Includes 9007 halogen bulb and seal beam/H4 plug adapter
- 12V, dual function auxiliary LEDs have three wire hookup

31247



HEADLIGHTS



Universal

7" SEALED BEAM HEADLIGHT

- 7" regular 6014 sealed beam headlight
- Replaces H6014/H6024, high and low beam

30356



Universal

7" CRYSTAL HEADLIGHT

- Reinforced multi-surfaced, aluminum reflector
- Rugged anti-vibration construction
- Sylvania halogen bulb: H4/HB2 12V 65/55W
- Replaces H6014/H6024, SAE & ECE approved

31387



Universal

7" GLASS LENS HEADLIGHT

- 7" round headlight with glass lens & replaceable H4 bulb
- Replaces H6014/H6024, high and low beam, H4 bulb included

A5023-3



Universal

7" SEALED BEAM HEADLIGHT

- 7" regular 6014 sealed beam headlight
- Replaces H6014/H6024, high and low beam

30354



Universal

7" GLASS HEADLIGHT W/ 1893 Accent Socket

- 7" round glass headlight with 1893 accent socket
- High beam only

31393

LED HEADLIGHTS



Universal

5 3/4" LED HEADLIGHT W/ POSITION LIGHT

- 9 high power 5 3/4" LED headlight with LED position light bar
- High power bright LED high and low beam
- Reinforced aluminum reflector with rugged anti-vibration construction

31259 | Amber LED Position Light Bar

31267 | White LED Position Light Bar



Universal

5 3/4" LED HEADLIGHT

- 8 high power 5 3/4" LED headlight
- Replaces H5001 and H5006 bulb, DOT/SAE and FMVSS 108 compliant
- Easy connection, fits OEM housing or fender, plugs into existing wiring harness
- Low beam 1,020 lumens, high beam 1,600 lumens

31201 | Silver

31202 | Black



Universal

5 3/4" CRYSTAL HEADLIGHT

- Beautiful crystal clear front lens
- Reinforced multi-surfaced, aluminum reflector, rugged anti-vibration construction
- Sylvania halogen bulb: SAE 9007 12V 65/55W
- Replaces H5001/H5006, SAE & ECE approved
- 9007 bulb adapter plug included, item # 34207V

31386

Universal

5 3/4" SEALED BEAM HEADLIGHT

- 5 3/4" round sealed beam Philips headlight
- High beam and low beam

H5006

LED HEADLIGHTS



Universal

5"x7" LED HEADLIGHT

- 9 high power LED rectangular headlight with 6 white LED light bar
- Reinforced aluminum reflector, rugged anti-vibration construction
- IP67 weatherproof rating
- High beam 3,700 lumens, low beam 1,800 lumens

34122



Universal

5"x7" LED HEADLIGHT

- 12 High power LED rectangular headlight with durable corrosion resistant polycarbonate lens & housing
- Solid state design resists shock and vibration
- Easy connection, fits OEM housing, plugs into existing wiring harness, position light requires additional wiring
- High beam 1,100 lumens, low beam 600 lumens

31087



Universal

5"x7" LED CRYSTAL HEADLIGHT

- 5 high power LED crystal headlight with high and low beam function
- Reinforced aluminum reflector and rugged anti-vibration construction

31297

LED HEADLIGHTS



Universal

4"x6" LED HEADLIGHT W/ AMBER AUXILIARY

- High power LED headlight with quality crystal clear polycarbonate lens
- Center light bar with 9 super bright amber LEDs
- Waterproof die-cast housing provides maximum protection and durability
- OEM fit, plugs into existing wiring harness
- Sold individually, please specify low beam or high beam

31150 | Low Beam

31151 | High Beam



Universal

4"x6" LED HEADLIGHT W/ WHITE AUXILIARY

- High power LED headlight with quality crystal clear polycarbonate lens
- Center light bar with 9 super bright white LEDs
- Waterproof die-cast housing provides maximum protection and durability
- OEM fit, plugs into existing wiring harness
- Sold individually, please specify low beam or high beam

31152 | Low Beam

31153 | High Beam



Universal

4"x6" LED CRYSTAL HEADLIGHT

- High power 5 LED rectangular crystal headlight with high and low beam function
- Reinforced aluminum reflector, rugged anti-vibration construction
- Replaces H4651/H4656
- SAE approved

31365

LED HEADLIGHTS



Universal

4"x6" LED HEADLIGHT-HIGH BEAM

- Durable corrosion resistant polycarbonate lens & housing
- Solid state design resists shock and vibration
- Easy connection, fits OEM housing, plugs into existing wiring harness, position light requires additional wiring
- High beam 1000 lumens, 6500kelvin, 12-24v DC input

31089



Universal

4"x6" LED HEADLIGHT-LOW BEAM

- Durable corrosion resistant polycarbonate lens & housing
- Solid state design resists shock and vibration
- Easy connection, fits OEM housing, plugs into existing wiring harness, position light requires additional wiring
- Low beam 750 lumens, 6500kelvin, 12-24v DC input

31088



Universal

4"x6" BLACKOUT LED HEADLIGHT-HIGH BEAM

- 4"x6" rectangular crystal headlight with 1 high power LED and 6 high power LED position lights
- Solid state design resists shock and vibration
- Durable corrosion resistant polycarbonate lens & housing
- Load resistor may be required for proper installation
- DOT/SAE FMVSS 108

31299

LED HEADLIGHTS



Universal

4"x6" LED HEADLIGHT W/ POSITION LIGHT

- Rectangular 1 high power LED headlight with 6 amber LED dual function position lights
- Solid state design resists shock and vibration
- Die-cast aluminum housing, impact resistant polycarbonate lens for protection from road hazards
- 12-24v DC input, -.35 Amps / 8.5 Watt, FMVSS 108
- Sold individually, please specify low beam or high beam

31237 | Low Beam
31238 | High Beam



Universal

4"x6" LED HEADLIGHT W/ POSITION LIGHT

- Rectangular 1 high power LED headlight with 6 white LED dual function position lights
- Solid state design resists shock and vibration, DOT/SAE headlight compliant
- Die-cast aluminum housing, impact resistant polycarbonate lens for protection from road hazards
- Low beam 600 lumens, high beam 1,000 lumens
- Sold individually, please specify low beam or high beam

31168 | Low Beam
31169 | High Beam



Universal

4"x6" CRYSTAL PROJECTION HEADLIGHT

- Crystal projection headlight with 6 white LED position lights
- Reinforced aluminum reflector, rugged anti-vibration construction
- Low beam includes two 9005 adapter plugs (one 3 wire to 2 wire plug and one 2 wire plug)
- High beam has 2 wires and 9005 adapter plug
- Sold individually, please specify low beam or high beam

31375 | Low Beam
31376 | High Beam

LED HEADLIGHTS



Universal

4"x6" LED PROJECTION HEADLIGHT

- 11 high power LED projection headlight with white LED position light bar
- Die-cast aluminum housing, impact resistant polycarbonate lens for protection from road hazards
- Solid state design resists shock and vibration, DOT/SAE FMVSS 108

31274 | Low Beam
31275 | High Beam



Universal

4"x6" LED HEADLIGHT W/ LED LIGHT BAR

- 9 high power LED dual function light with 6 white LED light bar
- Reinforced aluminum reflector, rugged anti-vibration construction
- Headlight fits OEM housing, plugs into existing wiring harness
- For off-road use only

34125



Universal

4"x6" CREE LED HEADLIGHT

- 1 high power Cree LED headlight
- Solid state design resists shock and vibration, DOT/SAE FMVSS 108
- Improves visibility with whiter light output that is closer to daylight
- Durable corrosion resistant polycarbonate lens & housing
- Load resistor may be required for proper installation, SAE/DOT FMVSS108
- Sold individually, please specify low beam or high beam

31396 | Low Beam
31397 | High Beam

HEADLIGHTS W/ LED POSITION



Universal

4"x6" LED CRYSTAL HEADLIGHT

- Crystal headlight with 9 amber LED position lights
- Reinforced aluminum reflector
- Rugged anti-vibration construction
- Sold individually, please specify low beam or high beam

31373 | Low Beam

31374 | High Beam



Universal

4"x6" CRYSTAL HL W/ LED POSITION LIGHT

- Crystal headlight with 9 white LED position lights
- Reinforced aluminum reflector
- Rugged anti-vibration construction
- Sold individually, please specify low beam or high beam

31368 | Low Beam

31369 | High Beam

HEADLIGHTS



Universal

4"x6" RECTANGULAR CRYSTAL HEADLIGHT

- Reinforced aluminum reflector, rugged anti-vibration construction
- Replaceable bulb, Sylvania halogen bulb: SEA-9007 12V 65/55W
- Replaces H4651/H4556, SAE & ECE approved
- High and low beam, 9007 bulb adapter plug included

31388



Universal

4"x6" RECTANGULAR CRYSTAL HEADLIGHT

- Reinforced aluminum reflector, rugged anti-vibration construction
- Replaceable bulb, Sylvania halogen bulb: SEA-9007 12V 65/55W
- Replaces H4651/H4556, SAE & ECE approved
- High beam only, 2 wire 9007 bulb adapter plug included

31390



Universal

5"x7" RECTANGULAR CRYSTAL HEADLIGHT

- Reinforced aluminum reflector, rugged anti-vibration construction
- Replaceable bulb, Sylvania halogen bulb: H4/HB2, 12V 65/55W
- Replaces H6054

31389

BULBS / ADAPTERS / ETC.



Universal

9005/HB3 LED HEADLAMP BULB

- 2 Cree high power white LED headlamp bulb
- 10W low beam application, bright 1,200 lumen output, 6,000k
- Fan-less design, proprietary heat sink dissipates excess heat
- Sold individually

36888



Universal

XENON WHITE 9007 HALOGEN BULB

- 12V, Hi/Low function
- High beam 100 watt/low beam 80 watt
- Sold in pairs

39132

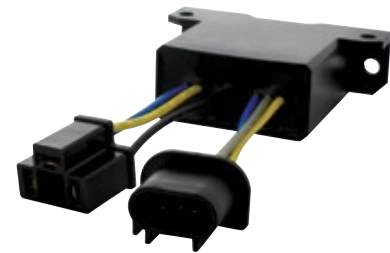

Universal

LED HL ANTI FLICKER MODULE & ADAPTER

- LED headlight PWM anti flicker module & adapter for most vehicles using pulse width modulated electrical systems
- Eliminates flicker on LED headlamps
- Adapts common H13 plug to H4 plug used by most LED headlights

34217B

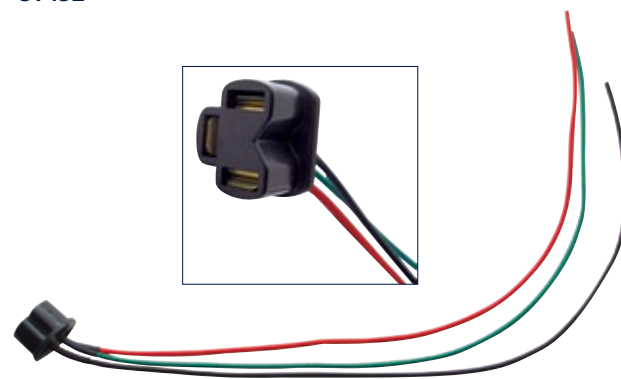

Universal

HEADLIGHT PIGTAIL

- 3 contact female pigtail for H4 halogen bulbs
- Head resistant wire, OEM #: 01A-13076
- Sealed beam or halogen bulb socket with 3 high heat resistant nylon wires, black, green and red

34222

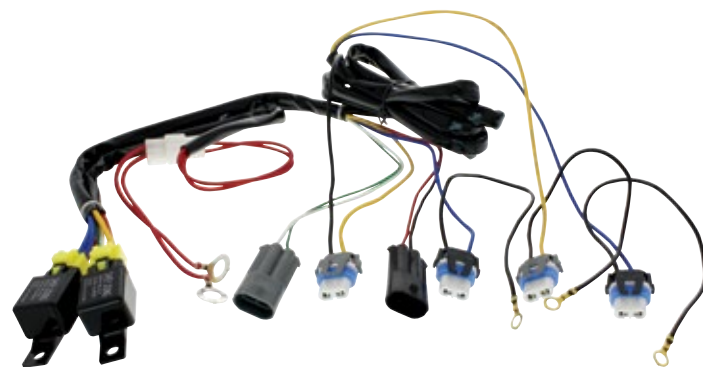

Universal

9005/9006 HEADLIGHT RELAY HARNESS KIT

- Sends high amperage to headlamps and corrects dim lights
- 12 volt

34264

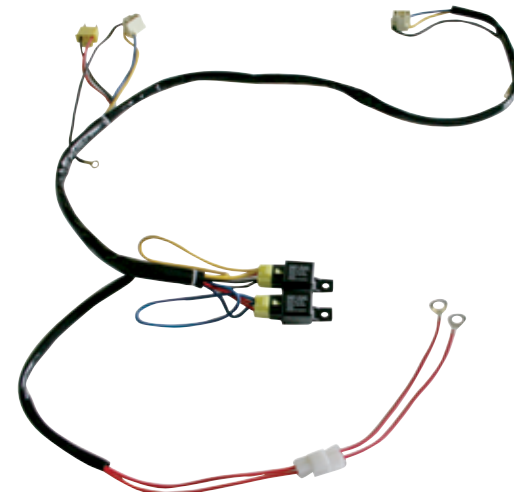

Universal

H4 HEADLIGHT RELAY HARNESS KIT

- Sends high amperage to headlamps and corrects dim lights
- Works on original style 6014 sealed beams

34263

LED CONTROL MODULE

Universal

DUAL FUNCTION LED CONTROL MODULE

- Add dual function high/low brightness to 31378 and 31379 headlamps with 34 LED accent lights
- Built in split operation for motorcycle application
- Easy plug & play hookup, wiring instructions included
- Sold individually, for 12 Volt LED use only

31372

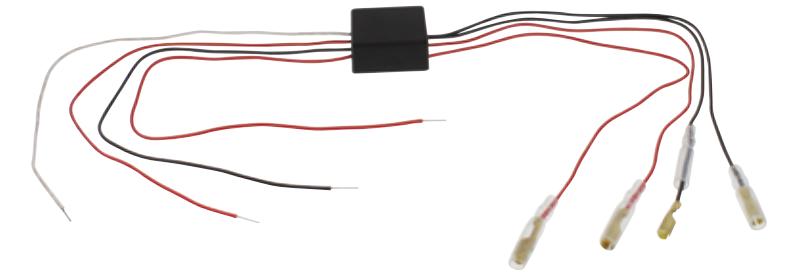

For Cars & Trucks

- Red wires 12+ for turn signal (high brightness). Connect BOTH red wires together.
- Black wire 12+ for parking/running light (lower brightness).
- White wire negative (ground-).

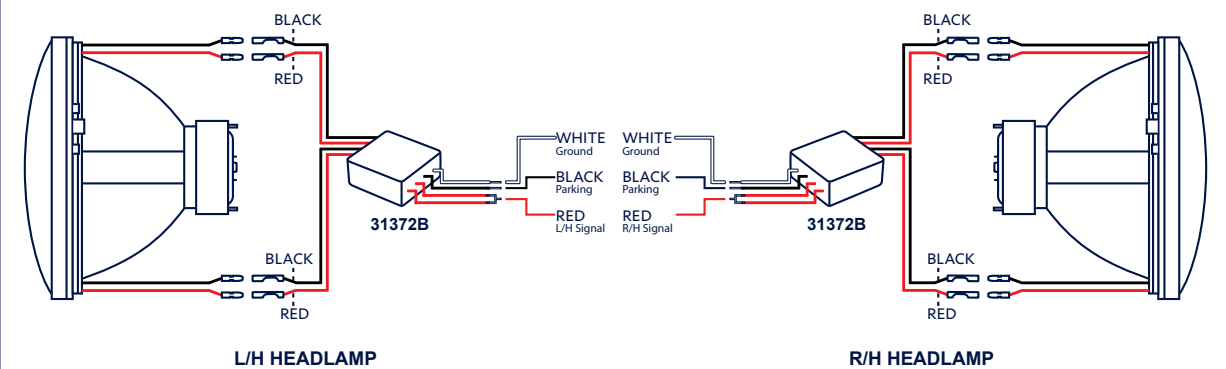

For Motorcycles

- Red wires 12+ for R/H and L/H turn signal (high brightness).
- Black wire 12+ for parking/running light (lower brightness).
- White wire negative (ground-).

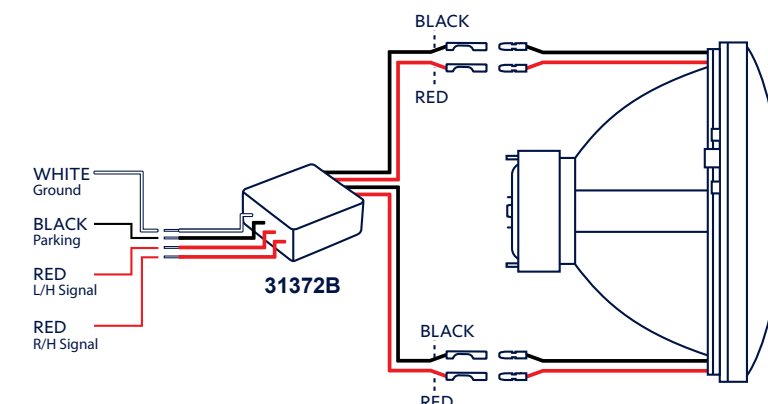

HEADLIGHT PARTS



1947-54 Chevy Truck

HEADLIGHT RIM KIT

- Includes 2 polished stainless steel headlight bezels, 2 rubber "o" ring gaskets, 2 set clips
- Headlight bezels, "o" rings, and clip set also available separately

C7011-KIT

C7011 | Headlight Bezel Only

C7012 | Bezel "O" Ring Only

C7013 | Headlight Clip Set Only



1963 Chevrolet Truck

CHROME HEADLIGHT BEZEL

- Beautiful triple chrome plating
- 8 oval head sheet metal screws included
- Sold in pairs

110429



1955-57 Chevy Truck

CHROME HEADLAMP BEZEL SET

- Beautiful chrome plating
- High quality rubber seals included
- Sold as a set

110705



1958-59 Chevy Truck

CHROME HEADLIGHT BEZEL

- Sold in pairs

C585981

HEADLIGHT PARTS

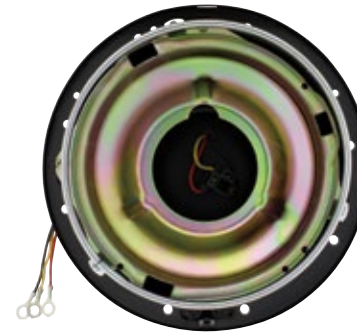

1947-54 Chevy & GMC Truck

HEADLIGHT BUCKET

- Steel reproduction like original
- Includes inner headlamp cradle, aiming adjusters, springs, chrome headlamp retainer ring and screws
- Headlamp wiring pigtail with ring terminals like original
- Fits LH/Driver and RH/Passenger

110282



1955-57 Chevy & GMC Truck

HEADLIGHT BUCKET

- Steel reproduction like original
- Includes headlamp bulb retaining ring and electrical pigtail
- Fits LH/Driver and RH/Passenger

110283



1967-72 GMC Truck

HEADLIGHT MOUNTING BUCKET SET

- High quality 19 gauge sheet metal stamped buckets, 8 piece set
- Each bucket is properly trimmed with grooves for specific bulbs
- Chrome plated headlight retainer rings
- 6-32 screws included for mounting retainer ring to bucket

110358

HEADLIGHT VISORS



Universal

7" ROUND HEADLIGHT DROP VISOR

- Sold individually
- 10532 | Stainless Steel



Universal

7" ROUND HEADLIGHT VISOR

- Sold individually
- 10468 | Stainless Steel
- 10467 | Chrome



Universal

CHROME HALF MOON HEADLIGHT SHIELDS

- Stick out style headlight visor
- Fits 5 3/4" headlights or dual round headlight systems
- Sold in pairs
- 10476 | 7 1/2" | Chrome | Fits 6014, 6015, 6016
- 10477 | 5 3/4" | Chrome | Fits 4000, 4001, 4040, 5001
- 21476 | 7 1/2" | Stainless Steel | Fits 6014, 6015, 6016
- 21477 | 5 3/4" | Stainless Steel | Fits 4000, 4001, 4040, 5001



Universal

HEADLIGHT VISORS WITH GLASS DOTS

- 7 1/2" round headlight visor
- Sold individually
- 10444 | Blue Dot | Chrome
- 10445 | Blue Dot | Stainless Steel
- 10448 | Red Dot | Chrome
- 10449 | Red Dot | Stainless Steel



Universal

OUTSIDE MOUNTING HEADLIGHT VISORS

- Stainless steel
- Fits 7 1/2" headlights
- Sold in pairs
- C5010



Universal

TRANSPARENT PLASTIC VISORS

- 7 1/2" headlight visor
- Sold in pairs
- C2001A | Amber
- C2001B | Blue
- C2001G | Green
- C2001R | Red



Universal

OUTSIDE MOUNTING HEADLIGHT VISORS

- Stainless steel
- Fits 7 1/2" headlights
- Sold in pairs
- C5006

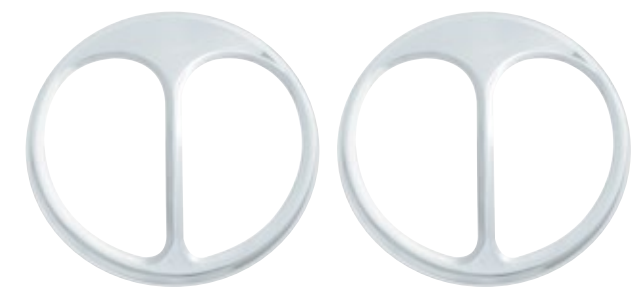

Universal

CHROME CATS EYE HEADLIGHT COVERS

- Also fits Volkswagen 67-68 Beetle, 67-73 Type LII, 68/69 Bus, 74-77 Dasher, and 75-79 Rabbit
- Sold in pairs
- 10466 | 7" Headlights
- 10461 | 5 3/4" Headlights



LED TAIL LIGHTS



LED TAIL LIGHTS



1940-53 Chevy Truck

23 LED TAIL LIGHT ASSEMBLY W/ BLUE DOT

- 23 super bright red LEDs, with LED blue dot, 6 super white LEDs for license light, polycarbonate lens
- Blue dot can be controlled independently with additional wiring
- Sold individually please specify LH/Driver or RH/Passenger

C7031RLBD | Black Housing | LH/Driver

C7031RRBD | Black Housing | RH/Passenger

C7033RLBD | Stainless Housing | LH/Driver

C7033RRBD | Stainless Housing | RH/Passenger

1940-53 Chevy & GMC Truck

27 LED SEQUENTIAL TAIL LIGHT ASSEMBLY

- 27 super bright red LEDs, 6 super white LEDs for license light
- Features sequential operation with selector switch to select sequential left, sequential right, or sequential function off
- Features sequential once brake attention function
- LH/Driver side includes 6 super bright white LED license light
- Recommended to upgrade with LED flasher 90652
- Sold individually please specify LH/Driver or RH/Passenger

110415 | Black Housing | LH/Driver

110416 | Black Housing | RH/Passenger

110419 | Stainless Housing | LH/Driver

110420 | Stainless Housing | RH/Passenger

«« SEQUENTIAL »»
(((BRAKE ATTENTION)))

LED TAIL LIGHTS



C7031RL C7033RL C7001L C7028L-1

1940-53 Chevy & GMC Truck

45 LED TAIL LIGHT ASSEMBLY

- 45 super bright LED tail light, 6 super bright white LED license light
- Recommended to upgrade with LED flasher 90652 (2-Terminal) Or 90651 (3-Terminal)
- Sold individually please specify LH/Driver or RH/Passenger

- C7031RL | Black Housing | LH/Driver
 C7031RR | Black Housing | RH/Passenger
 C7033RL | Stainless Housing | LH/Driver
 C7033RR | Stainless Housing | RH/Passenger

1940-53 Chevy & GMC Truck

TAIL LIGHT ASSEMBLY W/ RED GLASS LENS

- High quality chrome plated bezel with black or chrome housing
- Sold individually please specify LH/Driver or RH/Passenger

- C7001L | Black Housing | LH/Driver
 C7001R | Black Housing | RH/Passenger
 C7001L-1 | Black / Blue Dot | LH/Driver
 C7001R-1 | Black / Blue Dot | RH/Passenger
 C7002R | Stainless Housing | RH/Passenger
 C7028L | Stainless Housing | LH/Driver
 C7028R | Stainless Housing | RH/Passenger
 C7028L-1 | Stainless / Blue Dot | LH/Driver
 C7028R-1 | Stainless / Blue Dot | RH/Passenger



1940-53 Chevy & GMC Truck

27 LED SEQUENTIAL TAIL LIGHT LENS

- 27 super bright red LEDs, 6 super white LEDs for license light
- Features sequential operation with selector switch to select sequential left, sequential right, or sequential function off
- Features sequential once brake attention function
- LH/Driver includes LED license illuminator lens with 6 super bright white LEDs
- Recommended to upgrade with LED flasher 90652
- Sold individually please specify LH/Driver or RH/Passenger

- 110110 | LH/Driver
 110111 | RH/Passenger

SEQUENTIAL
F.L.A.S.H.

(((BRAKE ATTENTION)))



LED TAIL LIGHTS



1940-53 Chevy & GMC Truck / 1937-38 Chevy Car



1940-53 Chevy & GMC Truck / 1937-38 Chevy Car

23 LED TAIL LIGHT W/ BLUE DOT

- 23 LED tail light w/ LED blue dot, with polycarbonate lens
- Dual function with tail light and bright stop/turn signal
- Left hand includes 6 super white LED license plate lights
- Epoxy coated, fully sealed electronics
- Energy efficient solid-state circuit board engineered for 7.7-14.0 VDC systems
- Recommended to upgrade with LED flasher 90652

- CTL4053LED-LBD | LH/Driver
 CTL4053LED-RBD | RH/Passenger



1940-53 Chevy & GMC Truck / 1937-38 Chevy Car



1940-53 Chevy & GMC Truck / 1937-38 Chevy Car

23 LED TAIL LIGHT W/ BLUE DOT SET

- 23 LED tail light w/ LED blue dot, with polycarbonate lens
- Dual function with tail light and bright stop/turn signal
- Left hand includes 6 super white LED license plate light
- Epoxy coated, fully sealed electronics
- Energy efficient solid-state circuit board engineered for 7.7-14.0 VDC systems
- Recommended to upgrade with LED flasher 90652
- Set includes: CTL4053LED-LBD & CTL4053LED-RBD

110750



1940-53 Truck / 1937-38 Chevy Passenger Car

27 LED TAIL LIGHT LENS

- 27 super bright red LEDs for tail light and 6 white LEDs for license plate light
- Epoxy coated, fully sealed electronics
- Solid state circuit boards are designed for 7.7-14.0 VDC

- CTL4053LED-L | LH/Driver
 CTL4053LED-R | RH/Passenger



1940-53 Chevy & GMC Truck

RED GLASS TAIL LIGHT LENS

- Beautiful red glass lens
- Identical shape and size as the original
- Sold individually

- C4009 | Red Lens
 C4009-1 | Red Lens w/ Blue Dot

LED TAIL LIGHTS



1954-59 Chevy & GMC Truck

LED SEQUENTIAL TAIL LIGHT ASSEMBLY

- Super bright red LED light with housing
- Features sequential operation with selector switch to select sequential left, sequential right, or sequential function off
- Features sequential once brake attention function
- Requires use of United Pacific LED turn signal flasher, item number: 90652 or 90649
- DOT & SAE approved

110767 | Black Housing

110768 | Chrome Housing



1954-59 Chevy & GMC Truck

29 LED TAIL LIGHT ASSEMBLY

- 29 super bright red LED light with housing
- Epoxy coated, fully sealed electronics
- 1157 double connector with off set pins, plugs into existing tail lamp socket
- Requires use of United Pacific LED turn signal flasher, item number: 90652 or 90649
- DOT & SAE approved

110765 | Black Housing

110766 | Chrome Housing



1954-59 Chevy Truck

41 LED TAIL LIGHT ASSEMBLY

- 41 super bright red LED light with polycarbonate lens
- Epoxy coated, fully sealed electronics, 1157 plug
- Recommended upgrade with LED flasher No. 90652 (2-terminal) or 90651 (3-terminal)

CTL5459BR | Black Housing | Red Lens

CTL5459BC | Black Housing | Clear Lens

CTL5459SR | Stainless Steel Housing | Red Lens

CTL5459SC | Stainless Steel Housing | Clear Lens

TAIL LIGHTS



1960-66 Chevy Stepside Truck

41 LED TAIL LIGHT ASSEMBLY

- 41 super bright red LED light with polycarbonate lens
- Epoxy coated, fully sealed electronics

CTL6066BR | Black Housing | Red Lens

CTL6066BC | Black Housing | Clear Lens

CTL6066SR | Stainless Steel Housing | Red Lens

CTL6066SC | Stainless Steel Housing | Clear Lens



1954-55 Chevy 1st Series Truck

TAIL LIGHT ASSEMBLY

- Injection molded high quality polycarbonate plastic with chrome plated bezel
- Sold individually

C545505 | W/O Blue Dot

C545507 | W/ Blue Dot



1954-55 Chevy Truck

TAIL LIGHT ASSEMBLY

- Injection molded high quality polycarbonate plastic with chrome plated bezel
- Sold individually

C545504BK | Black Housing

C545504SS | Stainless Housing



1955-59 Chevy Truck

TAIL LIGHT ASSEMBLY

- Injection molded high quality polycarbonate plastic
- Sold individually

C555910 | Black Housing

C555911 | Stainless Housing



1960-66 Chevy Stepside Truck

TAIL LIGHT ASSEMBLY

- Injection molded high quality polycarbonate plastic
- Sold individually

C606607 | Black Housing

C606608 | Stainless Steel Housing

LED TAIL LIGHTS



1955-59 Chevy Stepside Truck

TAIL LIGHT LENS

- Injection molded from high quality polycarbonate plastic
- Sold individually

C555908 | Red Lens

C555912 | Red lens w/ Blue Dot



1958-59 Chevy Fleetside Truck

TAIL LIGHT LENS

- Injection molded from high quality polycarbonate plastic
- Sold individually

C585901 | Red Lens

C585902 | Red Lens w/ Blue Dot

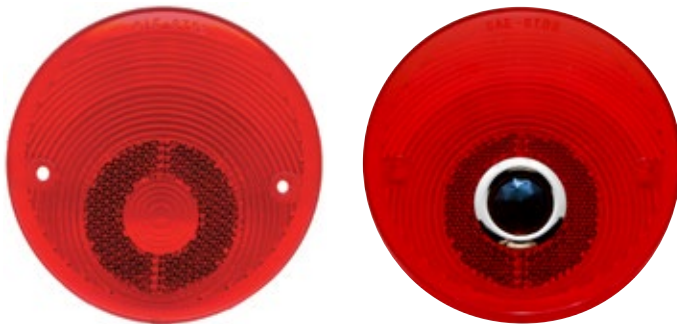

1960-66 Chevy Stepside Truck

TAIL LIGHT LENS

- Injection molded from high quality polycarbonate plastic
- Sold individually

C606605 | Red Lens

C606610 | Red Lens w/ Blue Dot



1954-59 Chevy Truck

41 LED TAIL LIGHT

- 41 super bright red LEDs
- Epoxy coated, fully sealed electronics
- Solid state circuit boards are designed for 7.7-14.0 VDC

CTL5459LED | Red Lens

CTL5459C | Clear Lens



1958-59 Chevy Truck

41 LED TAIL LIGHT

- 41 super bright red LEDs
- Epoxy coated, fully sealed electronics
- Solid state circuit boards are designed for 7.7-14.0 VDC

CTL5859LED | Red Lens

CTL5859C | Clear Lens



1960-66 Chevy Truck

41 LED TAIL LIGHT

- 41 super bright red LEDs
- Epoxy coated, fully sealed electronics
- Solid state circuit boards are designed for 7.7-14.0 VDC

CTL6066LED | Red Lens

CTL6066C | Clear Lens

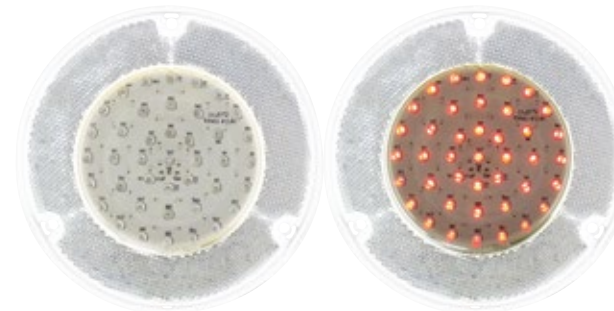

1967-72 Chevy Stepside Truck

41 LED TAIL LIGHT

- 41 Super bright red LEDs with clear lens
- Polycarbonate lens, epoxy coated, fully sealed electronics
- 1157 plug
- Energy efficient solid state circuit board engineered for 7.7-14.0 VDC systems
- Recommended under dash flasher is item no. 90652 (2-Terminal) or 90651 (3-terminal)
- Sold individually

CTL6722CL

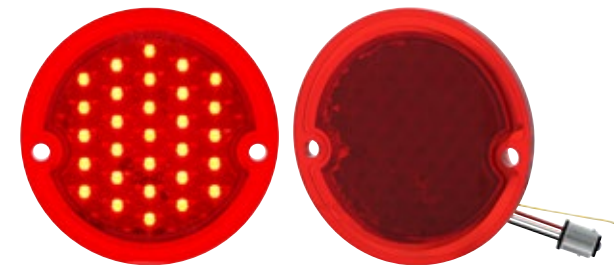

1954-59 Chevy & GMC 2nd Series Stepside Truck

29 LED TAIL LIGHT

- 29 LED red tail light
- Sold individually

110404



1955-58 Chevy Cameo Truck

TAIL LIGHT LENS

- Injection molded from high quality polycarbonate plastic
- Sold individually

C7006 | Red Lens

C7006-1 | Red Lens w/ Blue Dot

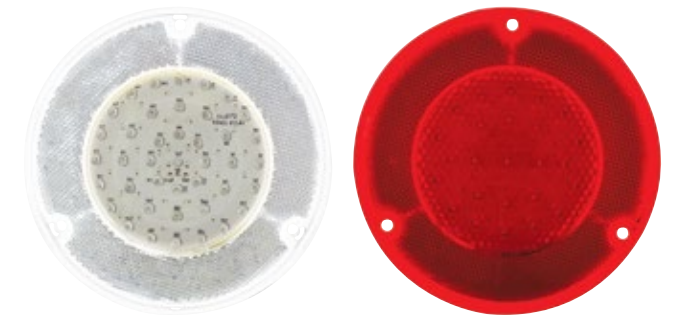

1967-72 Chevy Truck

41 LED TAIL LIGHT

- 41 super bright red LEDs
- Epoxy coated, fully sealed electronics
- Solid state circuit boards are designed for 7.7-14.0 VDC

CTL6772LED | Red Lens

CTL6772C | Clear Lens

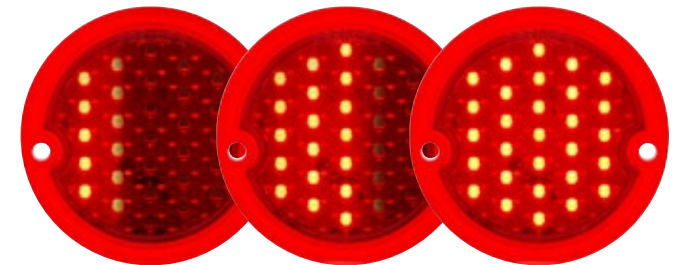

1954-59 Chevy & GMC 2nd Series Stepside Truck

29 LED SEQUENTIAL TAIL LIGHT

- 29 LED sequential tail light
- Sold individually

110405



1956-59 Chevy & GMC Panel Truck

TAIL LIGHT LENS

- Injection molded from high quality polycarbonate plastic
- Sold individually

C7008 | Red Lens

C7008-1 | Red Lens w/ Blue Dot

LED TAIL LIGHTS

1960-66 Chevy & GMC Fleetside Truck

TAIL LIGHT ASSEMBLY

- Includes housing, lens, gasket, socket, 1157 bulb & wiring
- Sold individually

- C606616 | Original Lens
- C606616BD | Red Lens w/ Blue Dot
- C606616C | Clear Lens w/ Red Bulb



1960-66 Chevy Fleetside Truck

LED TAIL LIGHT ASSEMBLY

- Complete with housing, lens gasket, socket & wiring
- Sold individually please specify LH/Driver or RH/Passenger

- CTL6066FSR | Red Lens
- CTL6066FSC | Clear Lens/Red LED



1960-66 Chevy & GMC Fleetside Truck

40 LED SEQUENTIAL TAIL LIGHT

- 40 super bright red LED with fully sealed epoxy coated electronics
- Features sequential operation with selector switch to select sequential left, sequential right, or sequential function off
- Features sequential once brake attention function
- Complete with zinc plated housing, lens, gasket, socket & wiring
- OE style wiring with bullet terminal connectors
- Requires use of United Pacific LED turn signal flasher, item number: 90652 or 90649
- SAE/DOT FMVSS108

110795

LED TAIL LIGHTS



1960-66 Chevy & GMC Fleetside Truck

40 LED SEQUENTIAL TAIL LIGHT

- 40 super bright red LED with fully sealed epoxy coated electronics
- Available with standard LED or sequential operation with selector switch to select sequential left, sequential right, or sequential function off
- Complete with polycarbonate lens and LEDs sealed inside
- Easy electrical connection with 1157 plug, 12 volt only
- Recommended Under Dash Flasher Is Item No. 90652 (2-Terminal) Or 90651 (3-Terminal)

110199



1960-66 Chevy Truck

40 LED TAIL LIGHT

- 40 super bright red LEDs, epoxy coated, fully sealed electronics
- Solid state circuit boards are designed for 7.7-14.0 VDC

- CTL6066FSLED | Red Lens
- CTL6066FC | Clear Lens



1960-66 Chevy & GMC Fleetside Truck

TAIL LIGHT LENS

- Injection molded from high quality polycarbonate plastic
- Sold individually

- C606617 | Red Lens
- C606618 | Red Lens w/ Blue Dot



1960-66 Chevy & GMC Fleetside Truck

TAIL LIGHT LENSES AND BULBS

- Injection molded from high quality polycarbonate plastic
- Fits LH/Driver and RH/Passenger
- Use 39014 clear with red lenses, 39006 red bulb with clear lenses

- C606609 | Red Lens
- C606611 | Red Lens w/ Blue Dot
- C60609C | Clear Lens
- 39014 | Clear 1157 Bulb 2 Pack
- 39006 | Red 1157 Bulb 10 Pack
- C606603 | Aluminum Bezel



LED TAIL LIGHT ASSEMBLIES

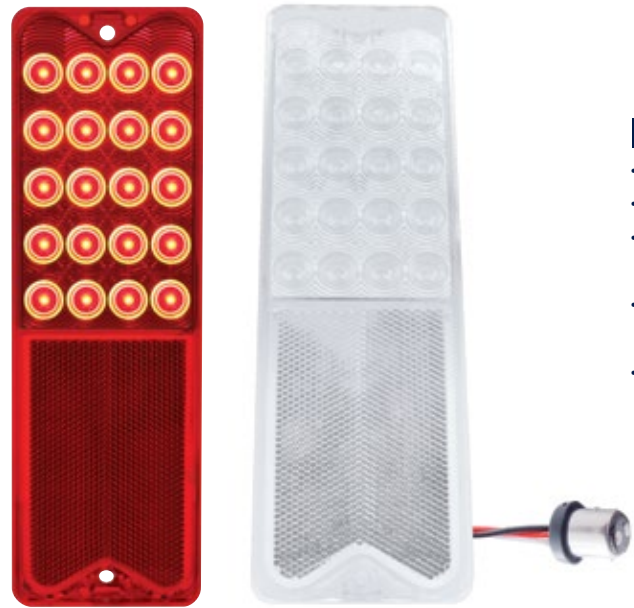

1967-72 Chevy Fleetside Truck

20 LED TAIL LIGHT

- 20 Super bright red LEDs
- Polycarbonate lens, epoxy coated, fully sealed electronics, 1157 plug
- Energy efficient solid state circuit board engineered for 7.7-14.0 VDC systems
- Recommended under dash flasher is item no. 90652 (2-Terminal) or 90651 (3-terminal)
- Sold individually

CTL6721LED | Red Lens
CTL6721C | Clear Lens

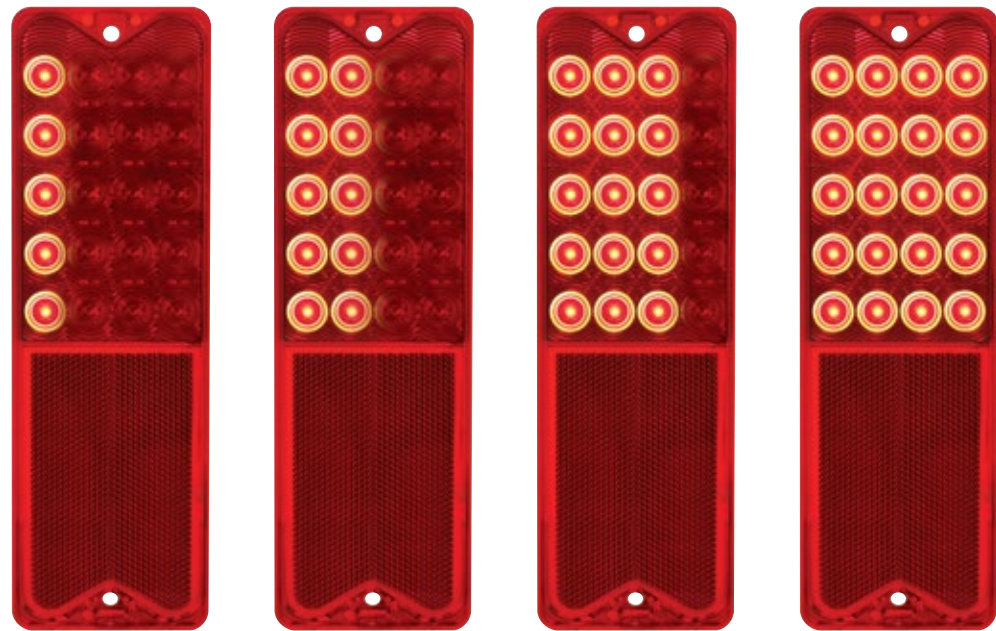

1967-72 Chevy & GMC Fleetside Truck

20 LED SEQUENTIAL TAIL LIGHT ASSEMBLY

- 20 Super bright red LEDs, complete with polycarbonate lens
- Available with standard LED or sequential operation with selector switch to select sequential left, sequential right, or sequential function off
- Features sequential-once brake attention function
- Complete with polycarbonate lens and LEDs sealed inside
- Easy electrical connection with 1157 plug, 12 volt only
- Recommended Under Dash Flasher Is Item No. 90652 (2-Terminal) Or 90651 (3-Terminal)
- Lifetime warranty

CTL6721SEQ

LED SEQUENTIAL TAIL LIGHTS



1967-72 Chevy & GMC Fleetside Truck

20 LED SEQUENTIAL TAIL LIGHT ASSEMBLY

- 20 Super bright red LEDs, complete with polycarbonate lens
- Includes steel tail light housing with socket and gasket
- Available with standard LED or sequential operation with selector switch to select sequential left, sequential right, or sequential function off
- Features sequential-once brake attention function
- Epoxy coated, fully sealed electronics, 1157 plug
- Solid state circuit boards are designed for 7.7-14.0 VDC
- Recommended under dash flasher is item no. 90652 (2-Terminal) or 90651 (3-terminal)

110213

110214



1967-72 Chevy & GMC Fleetside Truck

TAIL LIGHT LENS

- Sold individually

C677209

TAIL LIGHTS



1973-87 Chevy & GMC Truck

20 LED SEQUENTIAL TAIL LIGHT

- 20 Super bright red LEDs, with polycarbonate lens
- Mounting base plate included
- Features sequential operation with selector switch to select sequential left, sequential right, or sequential function off
- Features sequential-once brake attention function
- Epoxy coated, fully sealed electronics, 1157 plug
- Solid state circuit boards are designed for 7.7-14.0 VDC
- Recommended under dash flasher is item no. 90652 (2-Terminal) or 90651 (3-terminal)

CTL7387LED-L | LH/Driver

CTL7387LED-R | RH/Passenger



1973-87 Chevy & GMC Truck

TAIL LIGHT ASSEMBLY WITH TRIM

- Injection molded from high quality polycarbonate plastic
- Beautiful anodized aluminum trim
- Sold individually

C738705 | LH/Driver

C738704 | RH/Passenger



1988-02 Chevy & GMC Truck

TAIL LIGHT

- Injection molded from high quality polycarbonate plastic
- Fits 1988-98 Chevy C/K truck & 99-02 Chevy Silverado Classic
- 1992-99 Chevy Suburban / GMC Suburban
- 1995-99 Chevy Tahoe / GMC Yukon / GMC Denali (full-size)
- 1992-94 Chevy Blazer (full-size) & GMC Jimmy (full-size)
- Sold individually

110114 | LH/Driver

110115 | RH/Passenger

TAIL LIGHT BEZELS



1940-53 Chevy Truck

TAIL LIGHT BEZEL

- Sold individually

C4008-1 | Chrome

C4008-2 | Stainless Steel



1954-55 Chevy 1st Series Truck

STAINLESS STEEL TAIL LIGHT BEZEL

- Sold individually

C545506



1955-59 Chevy Truck

STAINLESS STEEL TAIL LIGHT BEZEL / GASKET

- Sold individually

C555909 | Bezel

C555911-3 | Gasket



1958-59 Chevy & GMC Fleetside Truck

TAIL LIGHT BEZEL

- Sold individually

C585902ALU | Aluminum

C585902SS | Stainless Steel



1960-66 Chevy & GMC Fleetside Truck

ANODIZED ALUMINUM TAIL LIGHT BEZEL

- Sold individually

C606603



1954-59 Chevy Truck

TAIL LIGHT RUBBER CONDUIT

- Universal tail light wiring boot for all restoration projects
- Total length: 21 1/2"
- Sold individually

C545504-2

T/L HOUSINGS / BRACKETS



1960-66 Chevy & GMC Fleetside Truck

TAIL LIGHT HOUSING, GASKET & PIGTAIL

- Zinc plated housing with socket
- Socket wiring pigtail sold separately: C606615
- Sold individually

C606614 | Tail Light Housing
C606651 | Lens Gasket
C606615 | Pigtail



1967-72 Chevy & GMC Fleetside Truck

TAIL LIGHT HOUSING

- Zinc plated housing with socket
- Socket wiring pigtail sold separately: C606615
- Sold individually

C677207 | Tail Light Housing
110215 | Lens Gasket Pair

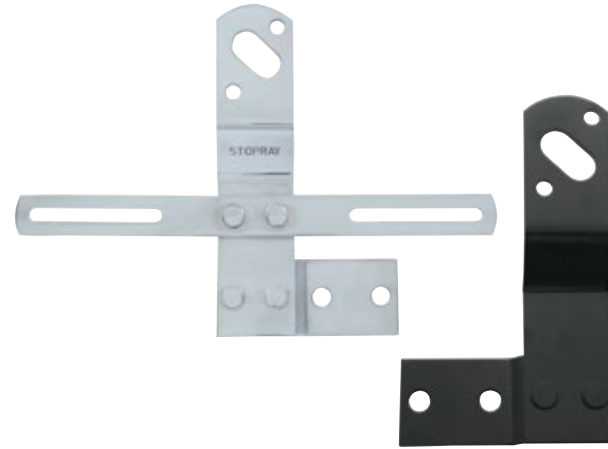

1947-53 Chevy & GMC 1st Truck

TAIL LIGHT BRACKET

- Sold individually

C7026RSS | Stainless Steel | RH/Passenger
C7026LSS | Stainless Steel | LH/Driver
C7003R | Black | RH/Passenger
C7003L | Black | LH/Driver
C7004R | Chrome | RH/Passenger
C7004L | Chrome | LH/Driver



1954-55 Chevy & GMC 1st Truck

TAIL LIGHT BRACKET

- Sold individually

C545502BK | Black | RH/Passenger
C545503BK | Black | LH/Driver
C545502CR | Chrome | RH/Passenger
C545503CR | Chrome | LH/Driver
C545502SS | Stainless Steel | RH/Passenger
C545503SS | Stainless Steel | LH/Driver



1955-66 Chevy & GMC 1st Truck

TAIL LIGHT BRACKET

- Sold individually

C556601BK | Black | RH/Passenger
C556602BK | Black | LH/Driver
C556601CR | Chrome | RH/Passenger
C556602CR | Chrome | LH/Driver
C556601SS | Stainless Steel | RH/Passenger
C556602SS | Stainless Steel | LH/Driver

TL GASKET / BACKUP LIGHTS

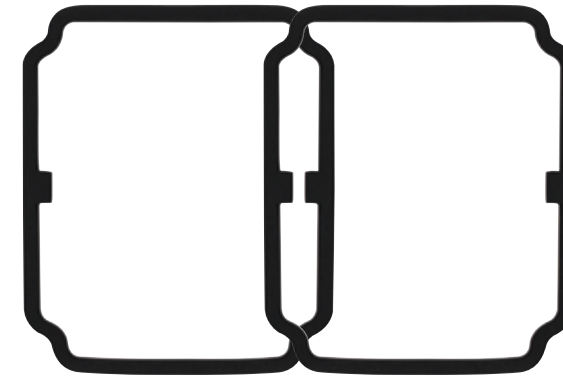

1973-87 Chevy & GMC Truck

TAIL LIGHT LENS GASKET

- Black EVA foam
- Precision die cut to OE specifications for a perfect fit
- Sold in pairs

C738703



1967-72 Chevy & GMC Truck

BULLSEYE STYLE BACKUP LIGHT LENS

- Rare 1967-68 bullseye style circular pattern
- Sold individually

110362



1967-72 Chevy & GMC Truck

BACKUP LIGHT LENS

- Injection molded high quality polycarbonate plastic
- Sold in pairs

110216



1967-72 Chevy & GMC Truck

30 LED BACKUP LIGHT

- 30 white super bright LEDs, with desirable bullseye lens
- Epoxy coated, fully sealed electronics, 1156 plug
- Solid state circuit boards are designed for 7.7-14.0 VDC

110200 | LH/Driver

110201 | RH/Passenger



1955-58 Chevy Cameo Truck

BACKUP LIGHT LENS

- Injection molded high quality polycarbonate plastic
- Sold in pairs

C7007

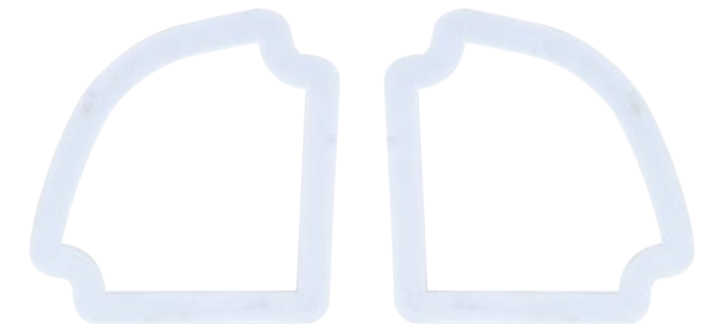

1967-72 Chevy & GMC Truck

BACKUP LIGHT GASKET

- White foam rubber like the original
- Fits between tail light housing and lens
- Sold in pairs

110202

LED PARKING LIGHTS



LED PARKING LIGHTS



1960-66 Chevy & GMC Truck

LED PARKING LIGHT

- 33 amber super bright LEDs, polycarbonate lens
 - Dual function with parking light and turn signal
 - Epoxy coated, fully sealed electronics, 1157 plug
- CPL6066A**

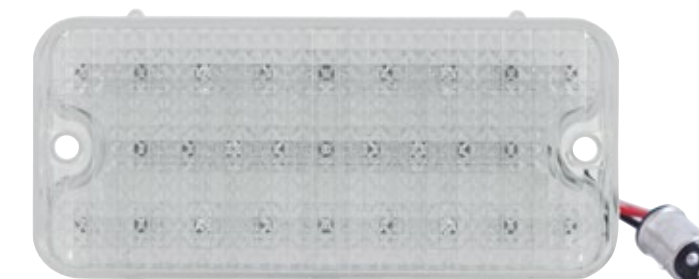
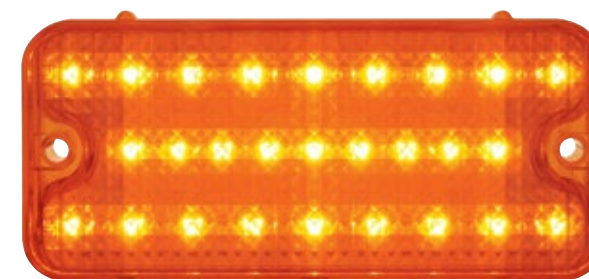

1967-68 Chevy & GMC Truck

LED PARKING LIGHT

- 27 amber super bright LEDs, polycarbonate lens
 - Dual function with parking light and turn signal
 - Epoxy coated, fully sealed electronics, 1157 plug
- CPL6768A | Amber**
CPL6768C | Clear

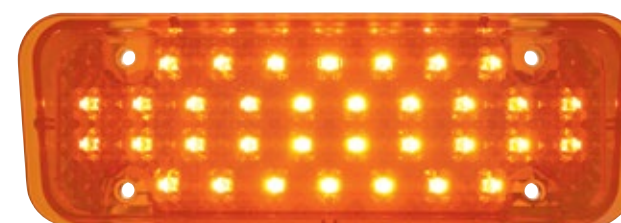

1971-72 Chevy & GMC Truck

LED PARKING LIGHT

- 34 super bright amber LEDs, polycarbonate lens
 - Dual function, epoxy coated, fully sealed electronics, 1157 plug
 - Fits LH/Driver and RH/Passenger
- CPL7172A | Amber**
CPL7172C | Clear



LED PARKING LIGHTS

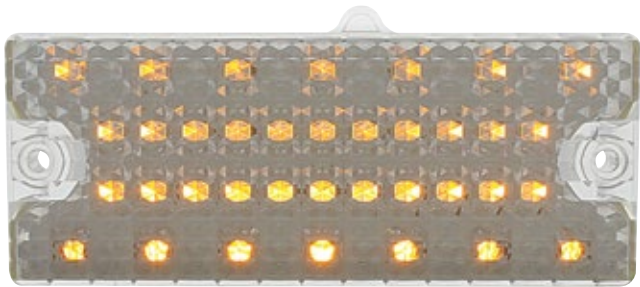
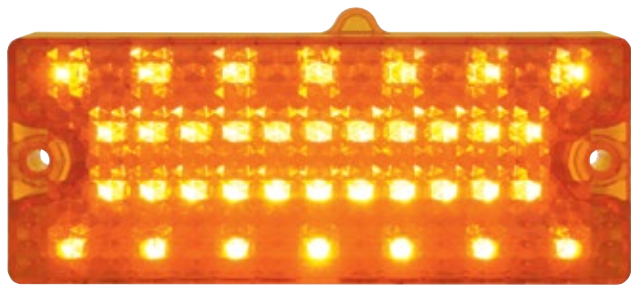
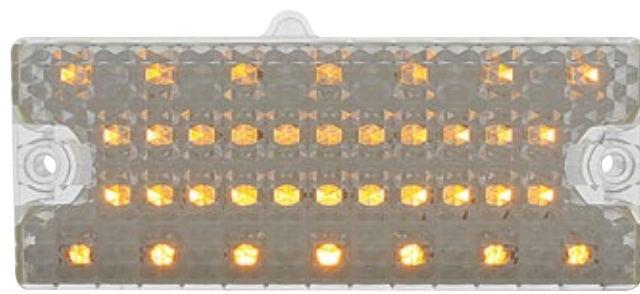
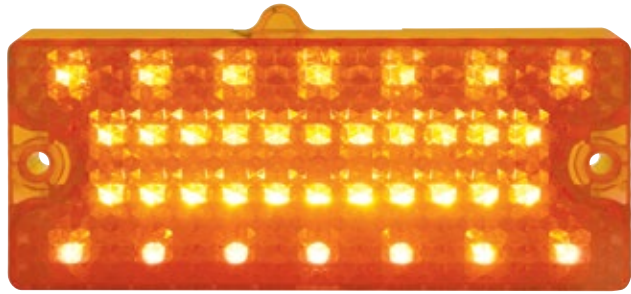

1969-70 Chevy & GMC Truck

LED PARKING LIGHT

- 36 amber super bright LEDs, with amber polycarbonate lens
- Dual function with parking light and turn signal
- Epoxy coated, fully sealed electronics, 1157 plug

CPL6970AL | LH/Driver

CPL6970AR | RH/Passenger

1969-70 Chevy & GMC Truck

LED PARKING LIGHT

- 36 amber super bright LEDs, with clear polycarbonate lens
- Dual function with parking light and turn signal
- Epoxy coated, fully sealed electronics, 1157 plug

CPL6970CL | LH/Driver

CPL6970CR | RH/Passenger

LED PARKING LIGHTS



1947-53 Chevy & GMC Truck

LED PARKING LIGHT ASSEMBLY

- Complete parking light assembly with LED lens installed
- Polished stainless steel bezel, black housing with socket and wires
- 24 amber super bright LEDs, polycarbonate lens
- Dual function with parking light and turn signal
- Epoxy coated, fully sealed electronics, 1157 plug

CPL4753A-AS | Amber

CPL4753C-AS | Clear



1951-53 GMC Truck

LED PARKING LIGHT

- Amber LEDs with clear lens

CPL5153C

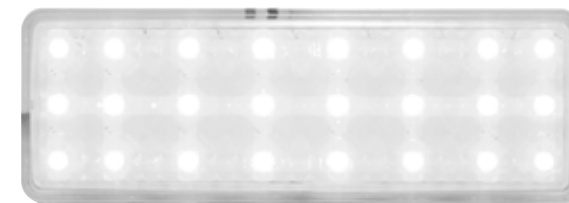
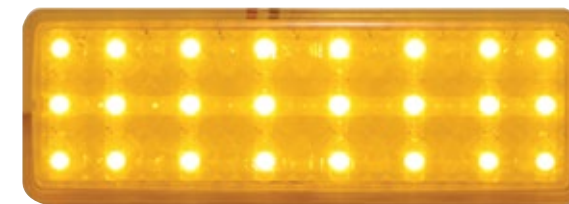

1947-53 Chevy & GMC Truck

LED PARKING LIGHT LENS

- 24 super bright LED parking light lens
- High quality injection molded polycarbonate lens
- Dual function with parking light and turn signal
- Epoxy coated, fully sealed electronics, 1157 plug

CPL4753A | Amber

CPL4753C | Clear



1955-57 Chevy & GMC Truck

LED PARKING LIGHT

- 39 super bright LED parking light
- Polycarbonate lens with LEDs sealed inside
- Dual function with parking light and turn signal
- Easy electrical connection with 1157 plug, 12 volt only

CPL5557A | Amber

CPL5557C | Clear

PARKING LIGHT LENS



1942-46 Chevy Truck
GLASS PARKING LIGHT LENS
 • Excellent quality all glass lens
 • Sold individually
C7010



1951-53 GMC Truck
PARKING LIGHT LENS
 • Injection molded from high quality polycarbonate plastic
 • Sold individually
C515301 | Clear



1955-57 Chevy Truck
PARKING LIGHT LENS
 • Injection molded from high quality polycarbonate plastic
 • Sold individually
C7014A | Amber
C7014C | Clear



1947-53 Chevy Truck
CLEAR GLASS PARKING LIGHT LENS
 • Fits LH/Driver or RH/Passenger
 • Sold individually
C7019



1955-57 Chevy Truck
PARKING LIGHT LENS
 • Great looking replacement with new lens pattern
 • Injection molded from high quality polycarbonate plastic
C555751A | Amber
C555751C | Clear



1958-59 Chevy Truck
PARKING LIGHT LENS
 • Fits LH/Driver or RH/Passenger
 • Injection molded from high quality polycarbonate plastic
 • Sold individually
C7009A | Amber
C7009C | Clear

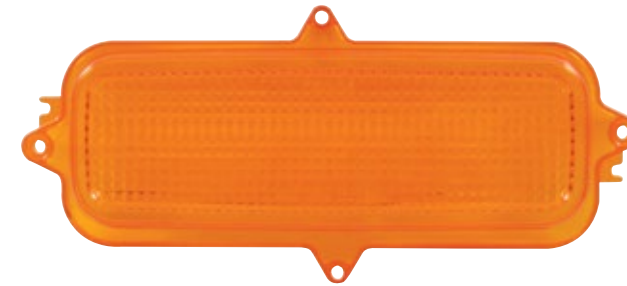

1960-66 Chevy Truck
PARKING LIGHT LENS
 • Injection molded from high quality polycarbonate plastic
 • Sold individually
C606621 | Amber

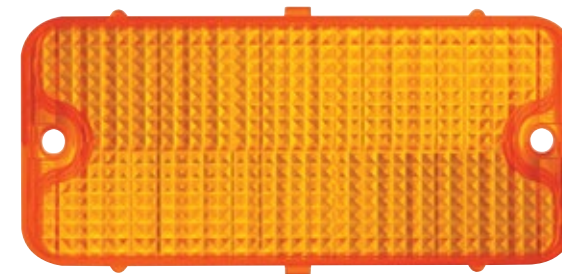

1967-68 Chevy Truck
PARKING LIGHT LENS
 • Injection molded from high quality polycarbonate plastic
 • Sold individually
C676811A | Amber
C676811C | Clear

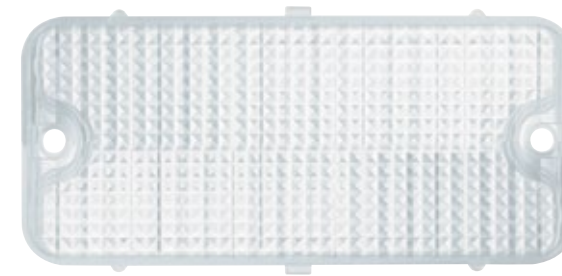

PARKING LIGHT LENS

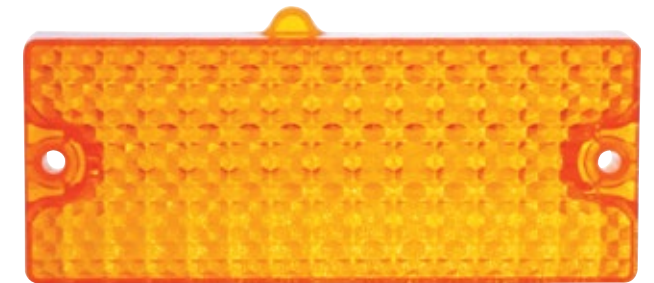
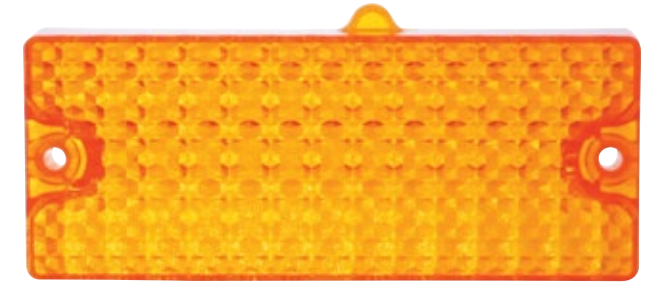

1969-70 Chevy Truck
PARKING LIGHT LENS
 • Injection molded from high quality polycarbonate plastic
 • Sold individually
C697020 | Amber LH/Driver
C697021 | Amber RH/Passenger

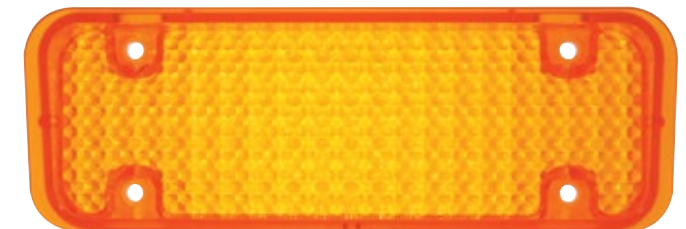

1971-72 Chevy Truck
PARKING LIGHT LENS
 • Injection molded from high quality polycarbonate plastic
 • Fits LH/Driver and RH/Passenger
 • Sold individually
C717221 | Amber

PARKING LIGHT BEZELS



1947-53 Chevy & GMC Truck

STAINLESS STEEL PARKING LIGHT BEZEL

- Polished stainless steel
- Sold individually

C475307



1947-53 Chevy & GMC Truck

CHROME PARKING LIGHT BEZEL

- Chrome plated
- Sold individually

C475307CR



1962-66 Chevy & GMC Truck

PARKING LIGHT BEZEL

- Sold individually

C626601



PARKING GASKETS



1960-66 Chevy Truck

FRONT PARKING LIGHT LENS GASKET

- Great looking OEM style replacement lens
- Injection molded from high quality polycarbonate plastic

C606612



1971-72 Chevy Truck

FRONT PARKING LIGHT LENS GASKET

- Sold in pairs

C717201



1967-68 Chevy & GMC Truck

FRONT PARKING LIGHT LENS GASKET

- Black foam rubber like the original
- Sold individually

C676812



1947-53 Chevy & GMC Truck

FRONT PARKING LIGHT LENS GASKET

- Black foam rubber like the original
- Sold individually

C475308



1951-53 GMC Truck

FRONT PARKING LIGHT LENS GASKET, LENS

- Black foam rubber like the original
- Sold in pairs

C515321 | Lens Gasket

C515301 | Lens

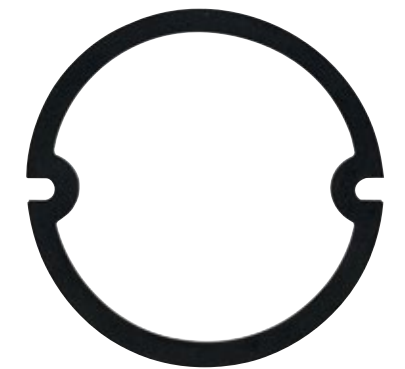

1955-57 Chevy & GMC Truck

FRONT PARKING LIGHT LENS GASKET

- Black foam rubber like the original
- Sold in pairs

C555755

SIDE MARKERS



SIDE MARKERS



1968-72 Chevy Truck

18 LED SIDE MARKER LIGHT W/ STEEL TRIM

- 18 super bright LEDs, complete with polycarbonate lens
- Epoxy coated fully sealed electronics
- Solid state circuit boards are designed for 7.7 - 14.0 VDC
- Dual function, parking light and turn signal

CML6872A | Front Amber

CML6872R | Rear Red

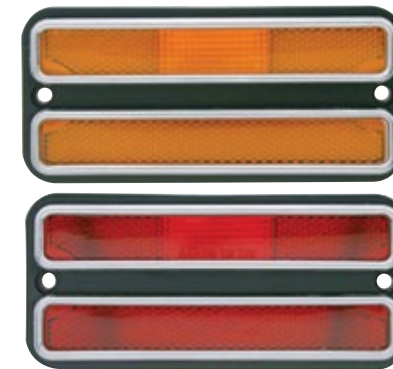

1968-72 Chevy & GMC Truck

SIDE MARKER LIGHT W/ STEEL TRIM

- Deluxe side marker lamp lens with stainless steel trim
- Also fits Blazer, Jimmy and Suburban
- Gasket included, sold individually

C687202 | Front Amber

C687203 | Rear Red

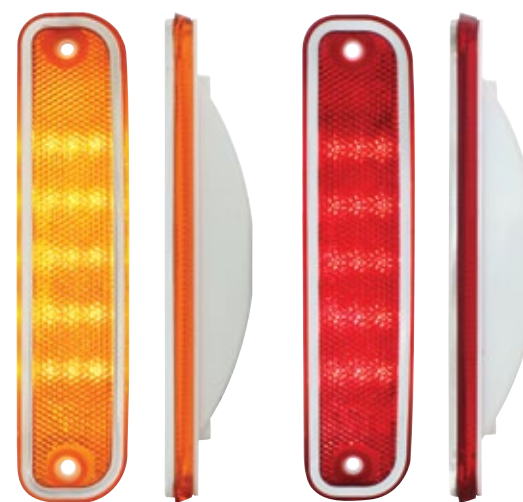

1973-80 Chevy & GMC Truck

LED FRONT SIDE MARKER LIGHT

- Polycarbonate lens with stainless steel trim
- Fits LH/Driver and RH/Passenger
- Sold individually

CML7380A | Amber

CML7380R | Red



1973-80 Chevy & GMC Truck

SIDE MARKER LIGHT W/ STAINLESS STEEL TRIM

- Polycarbonate lens with polished deluxe stainless steel trim
- Also fits 1973-91 Chevy & GMC Crew Cab Dually
- Fits LH/Driver and RH/Passenger side
- Sold individually

C738002 | Amber Side Marker Light

C738003 | Red Side Marker Light

C738001 | Clear Side Marker Light



1967-91 Chevy & GMC Truck

SIDE MARKER SOCKET

- Replaces damaged or missing OE sockets
- Includes butt connectors
- 194 bulb sold separately

C679101 | Side marker socket kit

39043 | Two 194 clear bulbs

MISC. LIGHTS / LENS



Universal

1004 DOME LIGHT BULB

- Single filament
- Sold individually

39065



1955-59 Chevy Truck

DOME LIGHT LENS

- Sold individually

C555901



1969-72 Chevy & GMC Truck

INCANDESCENT CARGO LIGHT ASSEMBLY

- Great looking OEM style replacement lens
- Injection molded from high quality polycarbonate plastic

110446



1969-72 Chevy & GMC Truck

CARGO LIGHT GASKET

- White foam rubber like the original
- Also fits 1969 Camaro backup light

110217

MISC. LIGHTS / LENS



1969-72 Chevy & GMC Truck

CARGO LIGHT LENS

- Great looking OEM style replacement lens
- Injection molded from high quality polycarbonate plastic

110168



1969-72 Chevy & GMC Truck

18 LED 3RD BRAKE & CARGO LIGHT

- 18 white LED cargo light with 9 red LED 3rd brake light feature
- Plug & play with 1004 double contact plug like the original
- Third brake light requires additional wiring, wiring instructions included
- Epoxy coated, fully sealed electronics
- Energy efficient solid state circuit board engineered for 12 VDC systems

110127



Universal

STAINLESS STEEL TAIL LIGHT WIRE CONDUIT

- Sold in pairs

C5025 | 12"

C5026 | 19"

CARGO / LICENSE LIGHT



1940-53 Chevy Truck

6 LED AUXILIARY/LICENSE LIGHT

- 6 super bright white LEDs
- Epoxy coated, fully sealed electronics
- Energy efficient solid state circuit board engineered for 7.7-14.0 VDC systems

CTL4053LL



1940-43 Chevy Truck

LICENSE LIGHT LENS GASKET

- Also fits 1937-38 Chevy car

C7001G



1940-53 Chevy & GMC Truck

CLEAR TAIL LIGHT LICENSE LENS

- Approximately 2 5/16" wide, 1 7/16" tall, 7/8" depth
- Sold individually

C7021



Universal

2 LED AUXILIARY/LICENSE LIGHT

- 2 super bright LED auxiliary/license light, water resistant with chrome housing
- 2 wires, (hard wired), hole distance 3 1/2" center to center

39994B



Universal

1 LED LICENSE PLATE FASTENER (2 PACK)

- Stainless steel fastener with super bright LED
- 8 1/2" wire lead, 2 wires (hard wired)
- Requires 5/16" diameter hole for installation

70300 | Amber

70301 | Blue

70302 | Red

70303 | White

LICENSE PLATE BRACKET W/ LIGHT



1954-59 Chevy & GMC Truck

REAR LICENSE PLATE BRACKET W/ LIGHT

- Die stamped with high quality 17 gauge sheet metal
- Original style license plate light with quality glass & metal enclosure, original style large riveted license plate bracket
- Single positive lead wire with quick connector pre-installed electrical hookup
- Black EDP coated

110770



1960-66 Chevy Truck

REAR LICENSE PLATE BRACKET W/ LIGHT

- Die stamped with high quality 17 gauge sheet metal
- Original style license plate light with quality glass enclosure, original style large riveted license plate bracket
- Single positive lead wire with quick connector pre-installed electrical hookup, black rubber insert to reduce rattling noise from license plate
- Black EDP coated

110771

FRONT BUMPERS



1947-72 Chevy Truck

CHROME FRONT BUMPERS

- Quality heavy stamped steel bumpers with all original detail and mounting holes
- Chrome plated

- 105471 | 1947-54
- 105551 | 1955-59
- 105601 | 1960-62
- 105631 | 1963-66
- 105671 | 1963-66
- 105672 | 1967-72
- 105711 | 1971-72



1938-46 Chevy Truck

STAINLESS STEEL BUMPER BOLT

- 1/2-13 thread
- C383901

REAR BUMPERS

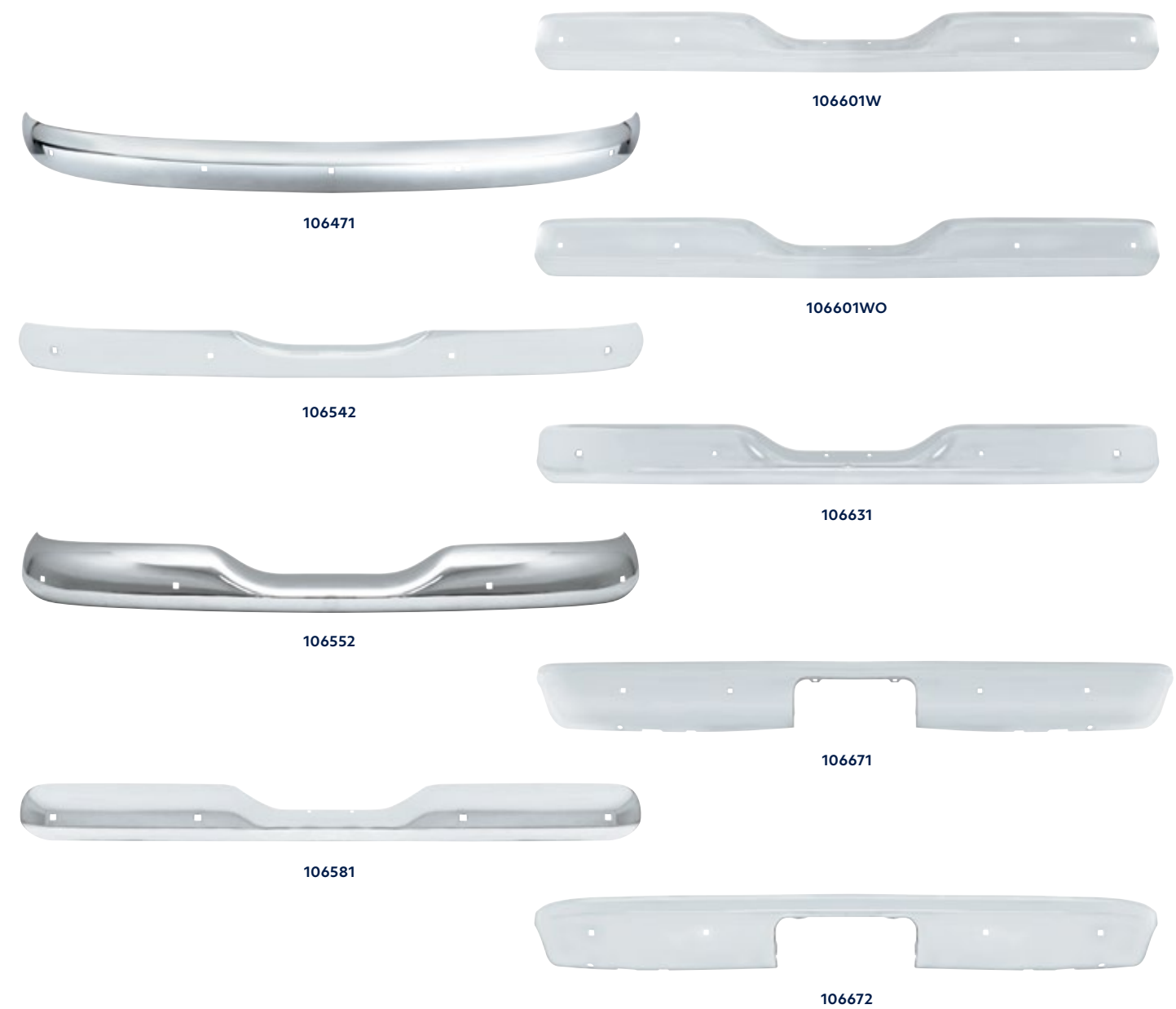

1947-72 Chevy Truck

CHROME REAR BUMPERS

- Quality heavy stamped steel bumpers with all original detail and mounting holes
- Chrome plated

- 106471 | 1947-53
- 106542 | 1954-55
- 106552 | 1955-59
- 106581 | 1958-59
- 106601W | 1960-62
- 106601WO | 1960-62
- 106631 | 1963-66
- 106671 | 1967-72
- 106672 | 1962-72



1947-72 Chevy Truck

CHROME BUMPER BOLT

- 1/2-13 thread
- 1 Piece, includes flat washer, lock washer and nut
- C477204

FRONT BUMPERS



1947-72 Chevy & GMC Trucks

BLACK EDP COATED FRONT BUMPERS

- Quality heavy stamped steel bumpers with all original detail and mounting holes
- Black EDP coated finish

110729 | 1947-55 Chevy & GMC Trucks

110728 | 1955-59 Chevy & GMC Trucks

110721 | 1960-62 Chevy & GMC Trucks

110722 | 1963-66 Chevy & GMC Trucks

110718 | 1967-70 Chevy, 1967-68 GMC

110719 | 1967-72 GMC Trucks

110720 | 1970-72 Chevy Trucks

REAR BUMPERS

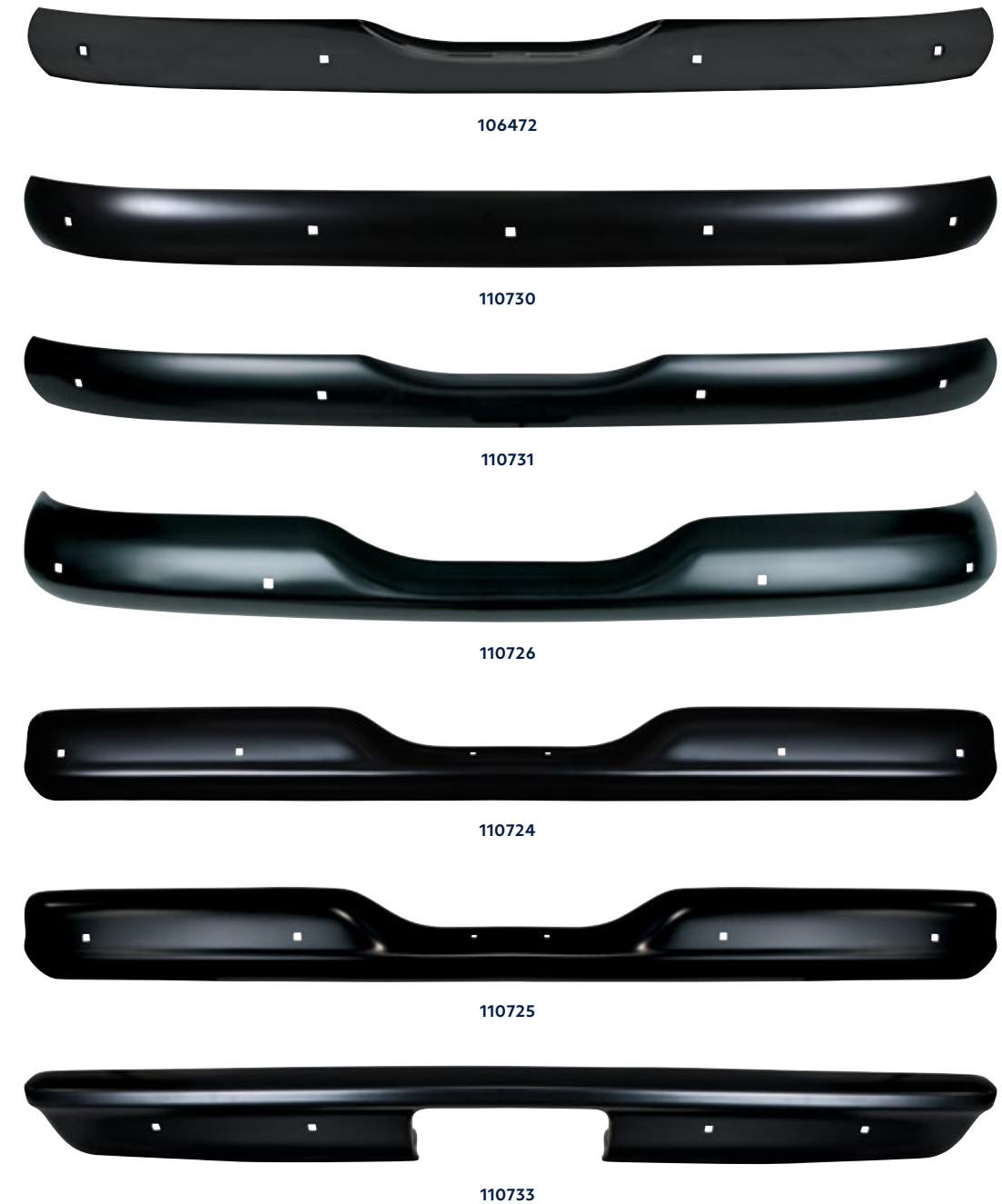

1947-72 Chevy & GMC Trucks

BLACK EDP COATED REAR BUMPERS

- Quality heavy stamped steel bumpers with all original detail and mounting holes
- Black EDP coated finish

106472 | 1947-53 Chevy & GMC Trucks

110730 | 1947-53 Chevy & GMC Trucks

110731 | 1954-55 Chevy & GMC Trucks

110726 | 1955-59 Chevy & GMC Stepside Trucks

110724 | 1960-62 Chevy & GMC Fleetside Trucks

110725 | 1963-66 Chevy & GMC Trucks

110733 | 1967-87 Chevy & GMC Stepside Trucks



1947-53 Chevy & GMC Truck

CHROME GRILLE GUARD

- Chrome grille guard with chrome hardware
 - Mounts behind front bumper, fits up to 6' wide bumpers
- C475313**



1955-56 Chevy Truck

CHROME GRILLE

- Steel reproduction of the original truck grille
 - Beautiful triple chrome plating
- 110387**



1955-56 Chevy Truck

BLACK PAINTED GRILLE

- Quality 19 gauge steel reproduction, black EDP finish
 - Has all original bar spacing and contour
 - Includes 5/16-18 square nuts for quick and easy installation
- 110388**



1957 Chevy Truck

CHROME GRILLE

- Steel reproduction of the original truck grille
 - Beautiful triple chrome plating
- 110389**



1957 Chevy Truck

WHITE POWDER COATED GRILLE

- Excellent steel reproduction of the original truck grille
 - Includes 5/16-18 nuts pre-welded to grille for quick and easy installation
 - Powder coated with original factory color look
- 110390**

HOOD PARTS



1947-54 Chevy Truck

CHROME HOOD LATCH PANEL

- Heavy duty triple chrome plated stamped steel
- Has radiator, fender, and grille bar mounting bolt holes
- Includes pre-installed hood latch

110340



1947-54 Chevy Truck

BLACK EDP COATED HOOD LATCH PANEL

- Die stamped 18 gauge steel
- Has radiator, fender, and grille bar mounting bolt holes
- Includes pre-installed hood latch

110339



1955-57 Chevy Truck

HOOD LATCH PANEL

- Made with high quality 20 gauge sheetmetal
- Features all original contour and detail
- Black EDP coated

110341



1958-59 Chevy Truck

HOOD LATCH PANEL

- Stamped steel reproduction of the original
- Has radiator, fender, and grille bar mounting bolt holes
- Black EDP coated

110342



1947-54 Chevy & GMC Truck

HOOD SAFETY CATCH

- Die stamped steel, spring loaded like the original
- Black EDP coated
- Also fits 1955 1st series

110279



1955-57 Chevy & GMC

HOOD LATCH ASSEMBLY

- Die stamped with heavy gauge sheetmetal
- Zinc plated
- Sold in pairs

110280

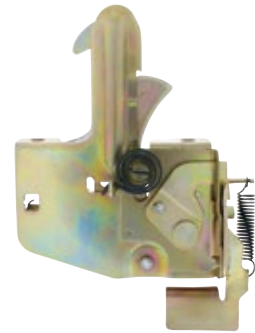

1958-59 Chevy & GMC

HOOD LATCH ASSEMBLY

- Die stamped with heavy gauge sheetmetal
- Features all the original mechanical design
- Pre-assembled for easy installation

110281



Chevy 327/350 Motor

CHROME 45 DEGREE WATER NECK

- Straight forward, 45 degree up chrome water neck
- Quality zinc die-cast with beautiful chrome plated finish
- Comes complete with thermostat housing, bolts and o-ring

110344

HOOD PARTS



1947-55 Chevy & GMC Truck

1st SERIES TRUCK HOOD HINGE AND SUPPORT

- Heavy duty steel reproduction of the original hood hinge
- Includes hood support arm with clock spring
- Black EDP coated
- Sold individually, please specify driver or RH/Passenger

110249 | L/H

110250 | R/H



Chevy Small Block Gen 1 & GM V6

CHROME 15 DEGREE WATER NECK

- Angled left 15 degree up chrome water neck
- Quality zinc die-cast with beautiful chrome plated finish
- Comes complete with thermostat housing, bolts and o-ring

110345

BATTERY HOLD DOWN FRAMES



1955-59 Chevy Truck

BATTERY HOLD DOWN BOLT SET

- Clear zinc plated hold down bolts with washers, and nuts
- Sold in pairs

110807



1958-66 Chevy & GMC Truck

BATTERY HOLD DOWN BRACKET

- High grade 304 stainless steel
- Identical design of the original

110473



1958-66 Chevy & GMC Truck

BATTERY HOLD DOWN BRACKET

- Excellent reproduction of the original design
- Die stamped steel
- Anti-Corrosive black powder coated finish

110472



1947-55 Chevy & GMC Truck

BATTERY TRAY HOLD DOWN FRAME

- Excellent reproduction of the original design
- Die stamped steel, painted black

110470



1955-57 Chevy & GMC Truck

BATTERY HOLD DOWN FRAME

- Excellent reproduction of the original design
- Die stamped steel, painted black
- Fits group-24 battery size

110471

BATTERY TRAYS



C475501



C555711



C585911



C606604



C677203



C677212



C738011

1967-72 Chevy & GMC Truck

BATTERY TRAYS

- Heavy duty stamped steel
- Black powder coated

C475501 | 1947-55

C555711 | 1955-57

C585911 | 1958-59

C606604 | 1960-66

C677203 | 1967-72

C677212 | 1967-72

C738011 | 1973-80

EXTERIOR MIRROR KITS



EXTERIOR MIRROR KITS

1970-72 Chevy & GMC Truck

EXTERIOR MIRROR WITH LED TURN SIGNAL

- Winner NSRA safety product of the year
- 9 red LED arrow hidden inside mirror glass
- Polished stainless steel mirror head & chrome plated arm
- Mounting hardware included
- Easy hookup, route wire through door jamb and connect to front turn signal wires under dash near steering column
- Can also be used on older 1967-69 trucks

110749 | Bundle LH and RH Included
C707201-LED | LH/Driver
C707202-LED | RH/Passenger



1973-87 Chevy & GMC Truck

CONVEX EXT. MIRROR W/ LED TURN SIGNAL RH

- LED turn signal arrow hidden inside mirror glass
- Beautiful die-cast & chrome plated mirror head and arm
- Convex mirror for wide angle visibility
- Easy hookup, route wire through door jamb and connect to front turn signal wires under dash near steering column
- Includes mounting pad, mounting bracket and screws

C738710-CVXLED | RH/Passenger Convex
C738710-LED | LH/Driver

EXTERIOR MIRROR KITS



1970-72 Chevy & GMC Truck

EXTERIOR MIRRORS

- Convex mirror with wide angle optics for RH side
 - Polished stainless steel mirror head & chrome plated arm
 - Mounting pads and hex wrench included
 - Bundle includes: C707201 & C707202 pre-packed in one box
- 110748** | Bundle LH and RH Included
C707201 | LH/Driver
C707202 | RH/Passenger



1973-87 Chevy & GMC Truck

CONVEX EXTERIOR MIRROR

- Chrome finish
 - Also fits 1951-52 Chevy passenger car
- C738710-CVX**



1973-87 Chevy & GMC Truck

EXTERIOR MIRROR KIT

- Hardware included
 - Fits LH/Driver or RH/Passenger, sold individually
- C738710**

EXTERIOR MIRROR KITS

Universal

4" PEEP MIRROR WITH LED TURN SIGNAL

- 7 red LED arrow hidden behind mirror glass
 - Wiring is discreetly routed through groove in arm
 - Polished stainless steel mirror head with chrome plated arm
 - Mounting pad and hex wrench included
 - 12V only, includes 48" of wire
 - Bundle includes: C5001-led & C5001-1CVXLED pre-packed in one box
- 110743** | Mirror Bundle
C5001-LED | LED Mirror
C5001-CVXLED | Convex LED Mirror



Universal

4" CURVED ARM PEEP MIRROR

- Polished stainless steel mirror head with chrome plated arm
 - Convex mirror has Improved wide angle vision on passenger side
 - Mounting pad and hex wrench included
 - Sold individually
- C5001**



Universal

4" CURVED ARM CONV. PEEP MIRROR BUNDLE

- Polished stainless steel mirror head with chrome plated arms
 - Convex mirror has Improved wide angle vision on passenger side
 - Mounting pad and hex wrench included
 - Bundle includes: C5001 & C5001-CVX pre-packed in one box
- 110742** | Mirror Bundle

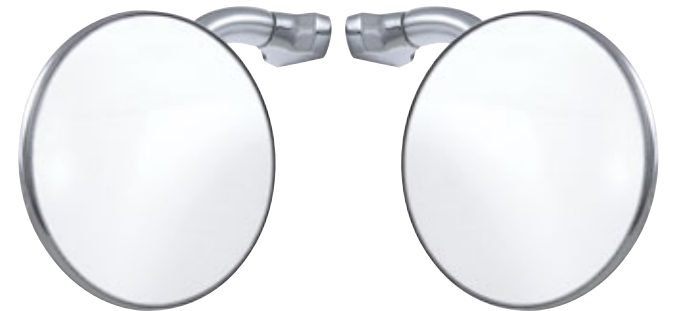

Universal

3" CURVED ARM CONV. PEEP MIRROR BUNDLE

- Polished stainless steel mirror head with chrome plated arms
 - Convex mirror has Improved wide angle vision on passenger side
 - Mounting pad and hex wrench included
 - Bundle includes: C5001-1 & C5001-1CVX pre-packed in one box
- 110741** | Mirror Bundle
C5001-1 | Standard Mirror
C5001-1CVX | Convex Mirror

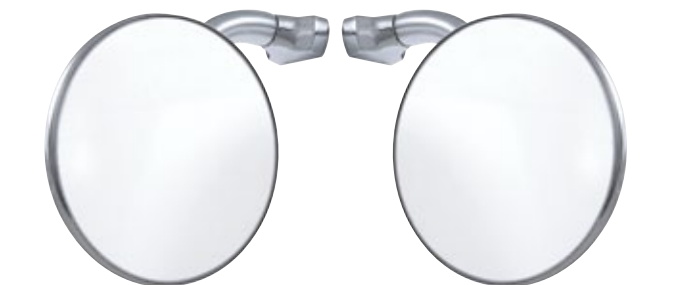

EXTERIOR MIRROR KITS



EXTERIOR MIRROR KITS



1973-91 Chevy & GMC Full Size Truck & Van

MIRROR

- Exterior rectangular rear view mirror with chrome housing
- Includes mounting pad and mounting hardware
- Sold individually

60050



Universal

STAINLESS SWING AWAY MIRROR

- Low mount stainless steel truck mirror housing, arms and yoke
- Fits most pickups, vans, smaller RVs and campers
- Extends to 15", double strength tubing reduces vibration
- Swing-away function helps vehicle fit into tight parking spots

60039

EXTERIOR MIRROR HEADS



1947-55 Chevy & GMC Truck 5" EXTERIOR MIRROR HEAD

- Gloss powder coated mirror, 1/4" male stud on back
- Sold individually

C477201 | Black, Ribbed
 C476901 | Chrome, Ribbed
 C476903B | Black, Smooth
 C477202 | Chrome, Smooth



1947-72 Chevy & GMC Truck EXTERIOR MIRROR HEAD

- 6"x8" mirror head, 1/4 - 20 male stud with nut
- Sold individually

C476902 | Stainless Steel
 C476904 | Black

EXTERIOR MIRROR ARMS



1947-55 Chevy & GMC Truck EXTERIOR MIRROR ARM

- Die-cast exactly like the original
- Chrome mirror heads available separately, C476901, C477202
- Black mirror heads available separately, C477201, C476903B

C475510 | RH/Passenger | Powder Coated Black
 C475511 | LH/Driver | Chrome
 C475512 | RH/Passenger | Powder Coated Black
 C475513 | LH/Driver | Chrome

1955-59 Chevy & GMC 2nd Series Truck EXTERIOR MIRROR ARM

- Die-cast exactly like the original
- Fits all 2nd series trucks, Panel truck, and Suburban
- Chrome mirror heads available separately, C476901, C477202
- Black mirror heads available separately, C477201, C476903B

C555941 | LH/Driver | Powder Coated Black
 C555942 | RH/Passenger | Powder Coated Black
 C555943 | LH/Driver | Chrome
 C555944 | RH/Passenger | Chrome

WIPER BLADES

Universal

ELECTRIC WIPER MOTOR SET

- Stainless steel wiper arm, 11" long blade and built-in switch on black motor cover
- Approximately 110 degree swing
- 1 3/4" center shaft to side hold mounting
- 3 1/4" long threaded shaft

A6235



Universal

ELECTRIC WIPER MOTOR SET

- Electric wiper motor set, stainless with wiper arm & blade
- 12 volt with self park, neoprene stem seal
- 1 3/4" center shaft to side hold mounting
- 3 1/4" long threaded shaft

A6236



Universal

WIPER BLADES

- Hook style, polished stainless steel wiper blades
- Sold individually

A7026 | 8"

A7037 | 9"

A7027 | 10"



Universal

WIPER BLADES

- Wrist style, polished stainless steel wiper blades
- Used with wiper arms with spoon shape ends
- Sold individually

110300 | 6"

110301 | 8"

110302 | 9"

110303 | 10"

110304 | 11"

110305 | 12"

110306 | 15"



WIPER ARMS / LINKAGE

1947-72 Chevy & GMC Truck

WIPER ARMS

- Polished stainless steel with die-cast chrome plated mounts
- Item #: 190671, and 190672 have bayonet end and use 15" wiper blade item #: 110306
- Sold individually

190471 | 1947-53 Truck | LH/Driver

190472 | 1947-53 Truck | RH/Passenger

190541 | 1954-59 Truck | LH/Driver

190542 | 1954-59 Truck | RH/Passenger

190601 | 1960-66 Truck | LH/Driver

190602 | 1960-66 Truck | RH/Passenger

190671 | 1967-72 Truck | LH/Driver or RH/Passenger Side



190541



190542



190601



190602



190671



190672

1960-66 Chevy & GMC

WIPER TOWER & LINKAGE SET

- Complete wiper linkage set with die-cast wiper shaft towers, pivots, and link arms
- Sold as a set

110243



REAR VIEW MIRRORS



Universal
INTERIOR REAR VIEW MIRROR
 • Rectangular stainless steel rear view mirror
 • Easy installation, simply glue onto windshield glass
 • Recommended adhesive: Loctite 37438, Permatex 81840, 3M 08752
M1003

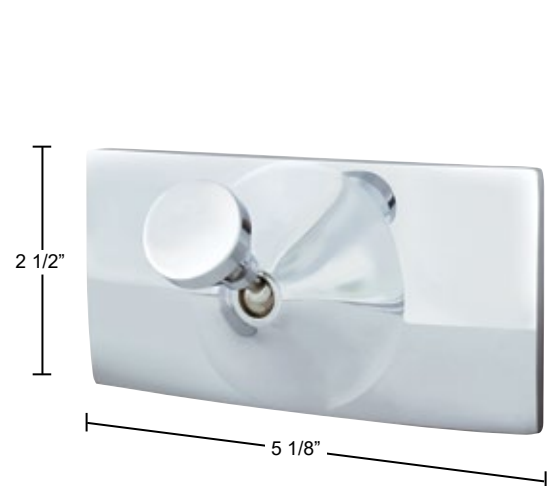

Universal
INTERIOR REAR VIEW MIRROR
 • Rectangular chrome plated aluminum rear view mirror
 • Easy installation, simply glue onto windshield glass
 • Recommended adhesive: Loctite 37438, Permatex 81840, 3M 08752
70801



Universal
INTERIOR REAR VIEW MIRROR
 • Rectangular chrome plated aluminum rear view mirror
 • Easy installation, simply glue onto windshield glass
 • Recommended adhesive: Loctite 37438, Permatex 81840, 3M 08752
70803



Universal
INTERIOR REAR VIEW MIRROR
 • Oval chrome plated aluminum rear view mirror
 • Easy installation, simply glue onto windshield glass
 • Recommended adhesive: Loctite 37438, Permatex 81840, 3M 08752
70804



Universal
INTERIOR REAR VIEW MIRROR
 • Oval chrome plated aluminum rear view mirror
 • Easy installation, simply glue onto windshield glass
 • Recommended adhesive: Loctite 37438, Permatex 81840, 3M 08752
70802

REAR VIEW MIRRORS



REAR VIEW MIRRORS



1947-53 Chevy & GMC Truck

INTERIOR REAR VIEW MIRROR

- Chrome finish
- Also fits 1951-52 Chevy passenger car

C475310CR



1947-59 Chevy & GMC Truck

INTERIOR REAR VIEW MIRROR

- Polished stainless steel housing, mirror glass installed in housing with smooth edges

C475902



1953-59 Chevy & GMC Truck

INTERIOR REAR VIEW MIRROR

- Chrome finish
- Also fits 1953-54 GM passenger car

C535910CR



1960-71 Chevy & GMC Truck

INTERIOR REAR VIEW MIRROR

- Polished stainless steel housing, mirror glass installed in housing with smooth edges
- Mirror arm sold separately, C607111

C607110



1960-71 Chevy & GMC Truck

REAR VIEW MIRROR BRACKET

- Chrome finish

C607111



1953-59 Chevy & GMC Truck

CHROME INSIDE MIRROR HOUSING

- Chrome finish
- Also fits 1953-54 GM passenger car

C475310



1947-53 Chevy & GMC Truck

INTERIOR MIRROR BRACKET

- Shaped exactly like the original, polished stainless steel
- Mounts on windshield division bar
- Use with United Pacific mirrors or C475310CR

C475351



1960-71 Chevy & GMC Truck

INTERIOR MIRROR BRACKET SCREW

- Polished stainless steel mirror Screw

C607112

GAUGE PACKAGES



GAUGE PACKAGES BY



1955-59 Chevy Truck

TACH FORCE STYLE GAUGE PACKAGE

- Six in one package (Fuel 0-30 OHM)

110019

1947-72 Chevy & GMC

SPEEDOMETER CABLE

- 68" speedometer cable

C477203



1967-72 Chevy

G-STOCK GAUGE PACKAGE

- 5" Speed/Tach, four 2 1/8" gauge (Fuel 0-90 OHM)

110020

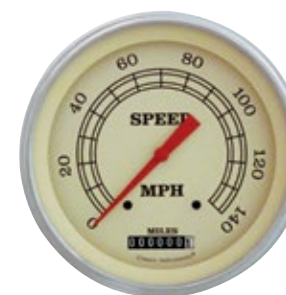

1947-53 Chevy & GMC

VINTAGE STYLE GAUGE PACKAGE

- 5" Speed/Quad (Fuel 240-330hm)

110017

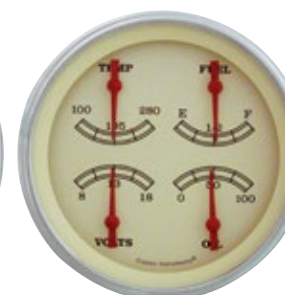

1954-55 Chevy & GMC

TRADITIONAL STYLE GAUGE PACKAGE

- 5" Speed/Tach/Quad (Fuel 240-330hm)

110018



DASH KNOBS



1947-54 Chevy & GMC Truck HEADLIGHT ROD & KNOBS

• Exact design as original

- C475321 | 1947-53 | Maroon
- C545521 | 1954-55 | Black
- C555921 | 1955-59 | Chrome
- C606321 | 1960-63 | Black
- C646621 | 1964-66 | Black



1947-66 Chevy & GMC Truck WIPER SWITCH KNOBS

• Original wiper switch design made of durable plastic with high quality chrome plating

- C475309C | 1947-53 | Chrome
- C475309M | 1947-53 | Maroon
- C555931 | 1955-59 | Chrome
- C606331 | 1960-63 | Black/Stainless Steel
- C646631 | 1964-66 | Black/Stainless Steel



1968-72 Chevy & GMC Truck WIPER SWITCH KNOBS

• High quality plastic injection molded with durable polypropylene plastic
• Deluxe style with stainless steel center insert
• Original style "D" profile mounting hole, set screw included
110700



1968-72 Chevy & GMC Truck WIPER SWITCH KNOBS

• High quality plastic injection molded with durable polypropylene plastic
• Deluxe style with stainless steel center insert
• Original style "D" profile mounting hole, set screw included
110701

KNOBS / CABLES / ETC.



1947-59 Chevy & GMC

CHOKE CABLE AND KNOB

• Stainless steel cable

- C475302 | 1947-53 | Stainless Steel w/ Maroon Knob
- C555905 | 1955-59 | Stainless Steel w/ Chrome Knob

1947-59 Chevy & GMC

THROTTLE CABLE AND KNOB

• Stainless steel cable

- C475301 | 1947-53 | Stainless Steel w/ Maroon Knob
- C555904 | 1955-59 | Stainless Steel w/ Chrome Knob



1947-72 Chevy & GMC SPEEDOMETER CABLE

• 68" speedometer cable
C477203



SWITCHES / FLASHER



Universal

CHROME TURN SIGNAL SWITCH

- 7 wire system, comes with adjustable clamp to hold onto the steering column, no drilling required
 - Indicator light at the end of the turn signal handle
 - Inline fuse and wiring diagram included, ready to use for 12V systems, also works for 6V if indicator bulb is changed to 6V
- A5007**



Universal

TURN SIGNAL SWITCH W/ 4 WAY HAZARD

- Chrome plated housing, clamps onto steering wheel
 - 4 way hazard switch
 - Lighted direction indicators
- 110307**



Universal

6 VOLT TURN SIGNAL FLASHER

- For all 6 volt positive and negative ground applications
 - 3 terminal, 535 type
 - Has "P" terminal for single dash indicator light
 - Use with turn signal switches 5007R or A5007 on 6 volt vehicles
 - Must use load resistor PN 34205 (need 2) when used with 6 volt LED lights
- 110252**



Universal

HEAVY DUTY TURN SIGNAL SWITCH

- All metal chrome plated heavy duty switch with 7 wires
 - Clamp onto hold steering column
 - Turn signal indicator lights, 4-way emergency hazard function with red light
 - Includes in-line fuse and wiring diagram
 - Ready to use for 12 volt systems, also works for 6 volt if indicator bulb is changed to 6 volt
- 5007R**

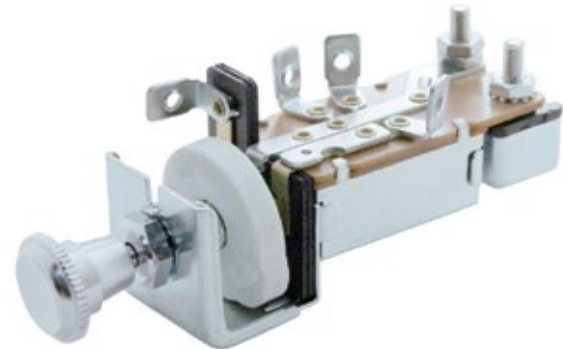

1947-59 Chevy & GMC Truck

HEADLIGHT SWITCH

- C475502 | 1947-55 | 6 Volt, 1st Series**
- C475901 | 1947-59 | 12 Volt**



Universal

IGNITION SWITCH W/ TWO KEYS

- Universal, 4 positions (ACC, OFF, IGN/ACC, IGN/START)
 - Knurled aluminum mounting nut, mounts in 3/4" hole
 - Stud terminal posts with nuts
- S1204**

SWITCHES / SHIFT KNOBS



Universal

BATTERY DISCONNECT SWITCH

- Prevents dead batteries, theft, and provides a safer work environment with the battery disconnected
 - Heavy duty metal housing with die-cast knob
- S1201 | 250A Continuous, 450A Momentary**
S1202 | 350A Continuous, 500A Momentary



Universal

CHROME DAGGER SHIFT KNOB

- High quality chrome finish with machined grip
 - Universal hex screw mount, includes mounting hardware
- 70677 | Dagger**
70679 | Skull



Universal

CHROME T-SHIFT KNOB

- Custom chrome t-shift knob, perfect for vintage Chevy, Ford, and Mopar
 - 5/16 - 24 thread adapter
- 110289**



Universal

DAGGER AIR VALVE KNOB

- Works as a dipstick handle with adapter removed
 - Universal hex screw mount, includes mounting hardware
- 23529 | Black**
23525 | Chrome

STEERING COLUMNS BY



1960-66 Chevy & GMC

MILL FINISH STEERING WHEEL COLUMN

- Design to fit the original dash mount
- Accepts the original rag joint flange or factory steering shaft
- The classic applications use our 2" diameter column to match the existing mounting holes
- Polished stainless steel

110052



1960-66 Chevy & GMC

TILT STEERING WHEEL COLUMN

- Design to fit the original dash mount
- Accepts the original rag joint flange or factory steering shaft
- The classic applications use our 2" diameter column to match the existing mounting holes
- Polished stainless steel

110050



1960-66 Chevy & GMC

MILL FINISH STEERING WHEEL COLUMN

- Mill finish steering column with late power steering
- Designed to fit the original dash mount
- Accepts the original rag joint flange or factory steering shaft
- The classic applications use our 2" diameter column to match the existing mounting holes

110051



1960-66 Chevy & GMC

MILL FINISH STEERING WHEEL COLUMN

- Design to fit the original dash mount
- Accepts the original rag joint flange or factory steering shaft
- The classic applications use our 2" diameter column to match the existing mounting holes

110049



1960-66 Chevy & GMC Truck

FLOOR SHIFT TILT COLUMN

- Use with late model power steering box
- Tilt column includes slip shaft and correct universal joint
- Polished stainless steel

110264

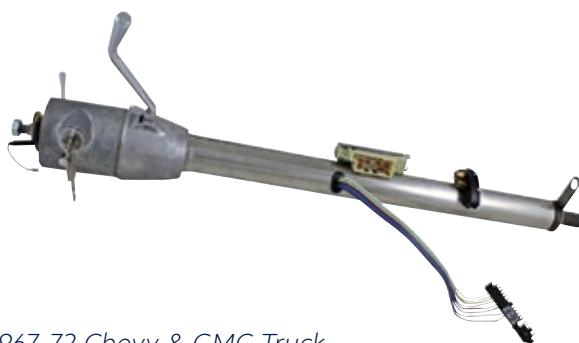

1967-72 Chevy & GMC Truck

30" TILT & SHIFT STEERING COLUMN

- GM 30" tilt column shift steering column with ignition key lock
- Ignition key switch is on the column, 2 keys included
- 30" Long, 3/4", 36 spline shaft accepts most GM original rag joint coupler flange
- 2" diameter column includes GM style ignition switch and turn signal switch, paintable mill finish stainless steel

110317

COLUMN / HUB ADAPTER / HORN



Early GM Models

30" MILL FINISH STEERING WHEEL COLUMN

- 30" column shift tilt column with neutral safety switch
- Complete with gearshift knob, billet dress up kit (tilt, turn signal levers and hazard knob)
- Illuminated gearshift indicator and GM wiring (4-14" connector) and removable 12-position linkage arm

110403



Universal

HORN BUTTON

- Satin finish with black button
- Two screw electrical terminals, mounting screws included

40028



1949-80 GMC

STEERING WHEEL HUB ADAPTER KIT

- Use with 3-bolt mount steering wheels
- Fits wide variety of GM vehicles 1949-80
- Includes splined hub, horn contact plate and hardware
- Horn button cap sold separately

110314



1967-72 Chevy Truck

CHROME HORN BUTTON CAP W/ BOWTIE

- Chrome horn button with bowtie logo

C677251



1967-68 Chevy Truck

CHROME HORN BUTTON CAP

- Chrome horn button cap with Chevrolet division markings

C676851

STEERING WHEELS



STEERING WHEELS



Universal

15" WOODGRAIN STEERING WHEEL

- 15" woodgrain steering wheel for 3-bolt hubs
- Wood grip with finger grooves and aluminum rivets
- 304 stainless steel spokes, dish depth 4"
- Compatible with all 3-bolt steering wheel hub kits on the market
- Hub adapter and horn button kit sold separately

110794

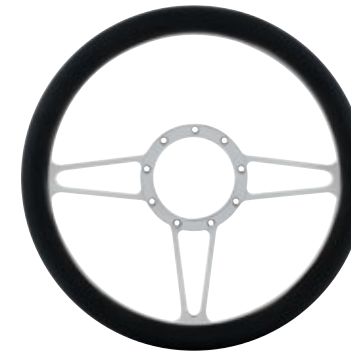

Universal

14" CHROME 3-SPOKE STEERING WHEEL

- 14" chrome aluminum 3-spoke style 9-screw mount steering wheel
- Comfortable black leather grip
- Requires standard 9-screw steering wheel hub adapter and horn button kit, sold separately

88300



Universal

14" CHROME 3-SPOKE STEERING WHEEL

- 14" chrome aluminum steering wheel
- Comfortable black leather grip
- Requires standard 9-screw steering wheel hub adapter and horn button kit, sold separately

88301



Universal

14" CHROME BLADE STEERING WHEEL

- 14" chrome aluminum blade style steering wheel
- Comfortable black leather grip
- Requires standard 9-screw steering wheel hub adapter and horn button kit, sold separately

88302



Universal

14" CHROME SCORPION STEERING WHEEL

- 14" chrome aluminum scorpion style steering wheel
- Comfortable black leather grip
- Requires standard 9-screw steering wheel hub adapter and horn button kit, sold separately

88304

GLOVE BOX / BRAKE COVER / ETC.



1955-59 Chevy & GMC Truck 2nd Series

GLOVE BOX DOOR KIT

- High quality 22 gauge steel sheet metal
- Heavy gauge arm brackets with 10-32 tapped holes
- 10-24 caged nuts for quick hinge mounting
- 10-32 & 10-24 screws included

110338



1960-66 Chevy & GMC Truck

GLOVE BOX HINGE BUSHING

- OD 0622", ID 0275", Thickness 0298"

110402



1967-68 Chevy & GMC Truck

CHROME HAND BRAKE COVER

- Original accessory fits below steering column to dress up the hand brake
- Stamped steel like the original and beautifully chrome plated

C676802



1947-55 Chevy 1st Series Truck

PEDAL PAD

- Identical size and shape as original

C7018



1967-72 Chevy Truck

BRAKE & CLUTCH PEDAL PAD & TRIM

- Rubber pad and stainless trim sold separately

C677210 | Rubber pad

C677211 | Stainless trim



A/C VENTS / DEFROST DUCTS

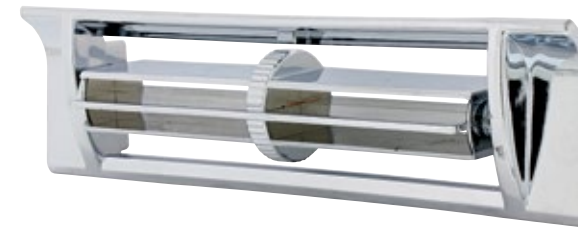

1967-72 Chevy & GMC Truck

A/C CENTER VENT

- High quality die-cast zinc and chrome plated
- Mounting hardware not included

110582



1967-72 Chevy & GMC Truck

DEFROSTER DUCTS

- Injection molded plastic same as the original

C677215 | LH/Driver | Black

C677216 | RH/Passenger | Black

C677217 | LH/Driver | Chrome

C677218 | RH/Passenger | Chrome



1967-72 Chevy & GMC Truck

A/C VENT BALL

- High quality die-cast zinc and chrome plated
- Sold individually, fits LH/Driver or RH/Passenger

C677214



VENT WINDOWS



1951-55 Chevy & GMC Truck

VENT WINDOW ASSEMBLY

- Complete assembled vent window, includes glass, chrome vent frame, chrome vent handles, rubber vent seal, division bar with felt, and brackets

- Sold individually, please specify LH/Driver or RH/Passenger

120511 | LH/Driver | No Tint

120512 | RH/Passenger | No Tint

120513 | LH/Driver | Tinted

120514 | RH/Passenger | Tinted

VENT FRAME / GLASS CHANNEL



1951-55 Chevy & GMC Truck

CHROME VENT WINDOW FRAME

- Beautiful show ready triple chrome plated finish
- Mounting stud with threaded end for easy installation
- Sold in pairs

122511

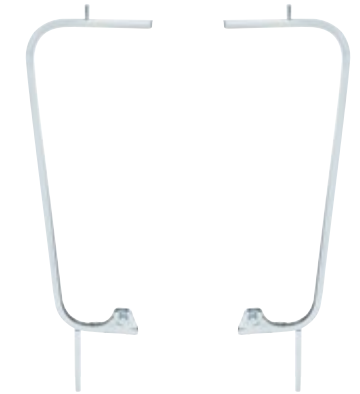

1960-63 Chevy & GMC Truck

CHROME VENT WINDOW FRAME

- Beautiful show ready triple chrome plated finish
- Mounting stud with threaded end for easy installation
- Sold in pairs

122601



1951-55 Chevy & GMC Truck

VENT WINDOW ASSEMBLY

- Complete assembled vent window, includes glass, chrome vent frame, chrome vent handles, rubber vent seal, division bar with felt, and brackets

- Sold individually, please specify LH/Driver or RH/Passenger

120641 | LH/Driver | No Tint

120642 | RH/Passenger | No Tint

120643 | LH/Driver | Tinted

120644 | RH/Passenger | Tinted



1967-72 Chevy & GMC Truck

VENT WINDOW ASSEMBLY

- Complete assembled vent window, includes glass, chrome vent frame, chrome vent handles, rubber vent seal, division bar with felt, and brackets

- Sold individually, please specify LH/Driver or RH/Passenger

120671 | LH/Driver | No Tint

120672 | RH/Passenger | No Tint

120673 | LH/Driver | Tinted

120674 | RH/Passenger | Tinted



1964-66 Chevy & GMC Truck

CHROME VENT WINDOW FRAME

- Beautiful show ready triple chrome plated finish
- Mounting stud with threaded end for easy installation
- Sold in pairs

122641

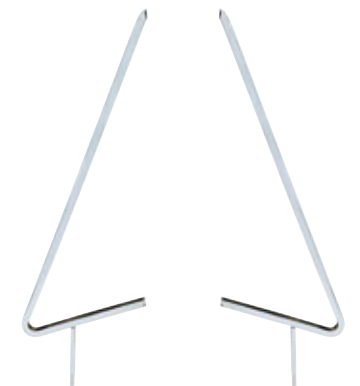

1967-72 Chevy & GMC Truck

CHROME VENT WINDOW FRAME

- Beautiful show ready triple chrome plated finish
- Mounting stud with threaded end for easy installation
- Sold in pairs

122671

1967-72 Chevy & GMC Truck

LOWER GLASS CHANNEL

- High tensile strength steel like the original
- Sold individually, please specify LH/Driver or RH/Passenger

110244 | LH/Driver

110245 | RH/Passenger



OUTSIDE DOOR HANDLES



1947-51 Chevy & GMC Truck

OUTSIDE CHROME DOOR HANDLE SET

- Die-cast and chrome plated
- Pads and mounting screws included
- Sold in pairs

C475001



1960-66 Chevy & GMC Truck

OUTSIDE CHROME DOOR HANDLE SET

- Die-cast and chrome plated
- RH/Passenger handle includes push button, LH/Driver requires locking push button, sold separately
- Pads and mounting screws included
- Sold in pairs

110313



1952-59 Chevy & GMC Truck

OUTSIDE CHROME DOOR HANDLE SET

- Die-cast and chrome plated
- RH/Passenger handle includes push button, LH/Driver requires locking push button, sold separately
- Pads and mounting screws included
- Sold in pairs

110312



1967-72 Chevy & GMC Truck

OUTSIDE CHROME DOOR HANDLE SET

- Die-cast and chrome plated
- Pads and mounting screws included
- Sold in pairs

115670

INSIDE DOOR / WINDOW HANDLES



1947-66 Chevy Truck

INSIDE DOOR HANDLE

- Die-cast and chrome plated
- Sold individually

C476601



1967-72 Chevy Truck

DOOR HANDLE CLIP REMOVER TOOL

- Zinc plated stamped steel
- Removes inside door handle clips

C496404



1967-72 Chevy Truck

INSIDE WINDOW CRANK HANDLE

- Die-cast and chrome plated with black knob
- Sold individually

C677601



1967-90 Chevy Truck

INSIDE WINDOW CRANK HANDLE

- Die-cast and chrome plated with clear knob
- Sold individually

C678101



1967-72 Chevy Truck

INSIDE DOOR HANDLE

- Die-cast and chrome plated
- Sold individually

C677602



1947-66 Chevy & GMC Truck

INSIDE WINDOW CRANK HANDLE

- Die-cast and chrome plated with black knob
- Sold individually

C476602



Universal

BILLET ALUMINUM WINDOW CRANK HANDLE

- Classic aircraft style brushed aluminum finish
- Universal application, 3 adapters included (circular, splined & square)
- Includes stainless steel set screws & hex wrench

24039



Universal

BILLET ALUMINUM WINDOW CRANK HANDLE

- Classic aircraft style brushed aluminum finish
- Universal application, 3 adapters included (circular, splined & square)
- Includes stainless steel set screws & hex wrench

24009

WINDOW REGULATORS



116471



116512



116472



116552



116511



116602



116551



116642



116601



116672



116641



1947-71 Chevy & GMC Truck

WINDOW REGULATORS

- Durable steel stamping, counter balance spring included
- Zinc plated or painted black for corrosion protection
- Sold individually

- 116471 | 1947-50 | LH/Driver
- 116472 | 1947-50 | RH/Passenger
- 116511 | 1951-55 | LH/Driver
- 116512 | 1951-55 | RH/Passenger
- 116551 | 1955-59 | LH/Driver
- 116552 | 1955-59 | RH/Passenger
- 116601 | 1960-63 | LH/Driver
- 116602 | 1960-63 | RH/Passenger
- 116641 | 1964-66 | LH/Driver
- 116642 | 1964-66 | RH/Passenger
- 116671 | 1967-71 | LH/Driver
- 116672 | 1967-71 | RH/Passenger

DOOR SILL / DOOR LATCH RELAY



1967-72 Chevy & GMC Truck

CHROME DOOR SILL PLATE

- Fits LH/Driver or RH/Passenger
 - Sold individually
- C677201**



1947-55 Chevy & GMC 1st Series Truck

INSIDE DOOR LATCH RELAY

- Zinc plated steel
 - Sold individually, please specify driver or RH/Passenger
- 110162 | RH/Passenger**
110163 | LH/Driver



1960-63 Chevy & GMC Truck

INSIDE DOOR LATCH RELAY

- Zinc plated steel
 - Sold in pairs
- 110164**
110165



1947-55 Chevy & GMC 1st Series Truck

INSIDE DOOR LATCH RELAY

- Zinc plated steel
 - Sold individually, please specify driver or RH/Passenger
- C555902 | RH/Passenger**
C555903 | LH/Driver

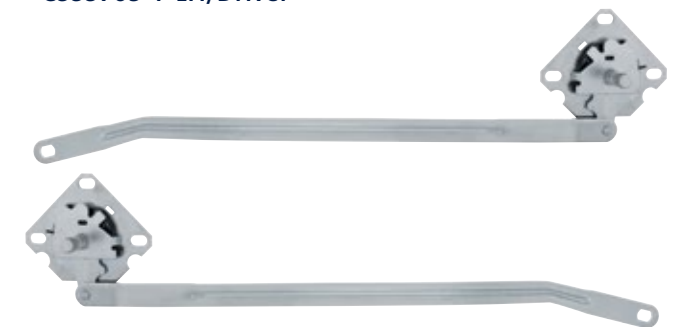

1964-66 Chevy & GMC Truck

INSIDE DOOR LATCH RELAY

- Zinc plated steel
 - Sold in pairs
- 110166 | RH/Passenger**
110167 | LH/Driver



1967-71 Chevy & GMC Truck

DOOR LATCH WITH REMOTE CONTROL RODS

- Zinc plated steel
 - Sold individually, please specify driver or RH/Passenger
- 110246 | RH/Passenger**
110247 | LH/Driver

DOOR LATCHES / STRIKER PLATES

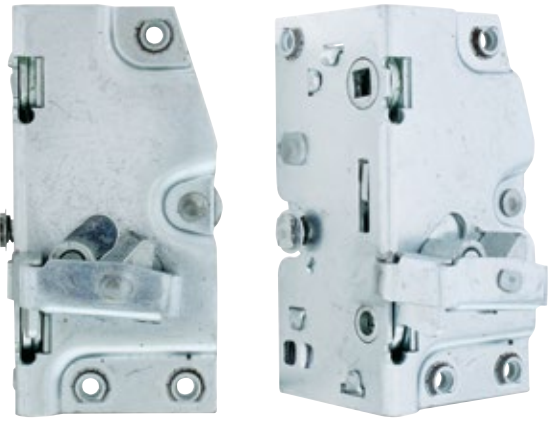

1947-51 Chevy & GMC Truck

DOOR LATCH

- Zinc plated, precision stamping with original design mechanism
- Mounting hardware not included
- Sold individually

110186 | RH/Passenger

110187 | LH/Driver



1947-51 Chevy & GMC Truck

DOOR LATCH STRIKER PLATE

- Zinc plated, excellent reproduction of the original
- Mounting hardware not included
- Sold in pairs

110192



1952-55 Chevy & GMC Truck

DOOR LATCH

- Zinc plated, precision stamping with original design mechanism
- Mounting hardware not included
- Sold individually

110188 | RH/Passenger

110189 | LH/Driver



1960-63 Chevy & GMC Truck

DOOR LATCH

- Zinc plated, precision stamping with original design mechanism
- Mounting hardware not included
- Sold individually

110258 | RH/Passenger

110259 | LH/Driver

DOOR LATCHES / STRIKER PLATES

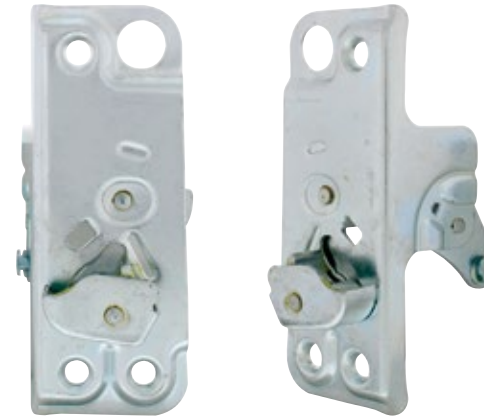

1955-59 Chevy & GMC 2nd Series Truck

DOOR LATCH

- Zinc plated, precision stamping with original design mechanism
- Mounting hardware not included
- Sold individually

110190 | RH/Passenger

110191 | LH/Driver



1952-59 Chevy & GMC Truck

DOOR LATCH STRIKER PLATE

- Zinc plated, excellent reproduction of the original
- Mounting hardware not included
- Sold in pairs

110193

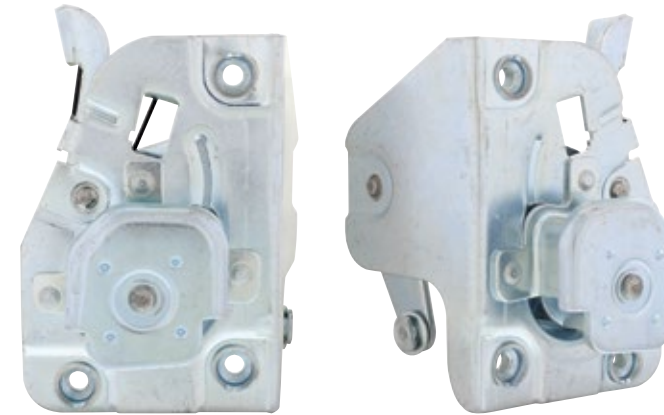

1964-66 Chevy & GMC Truck

DOOR LATCH

- Zinc plated, excellent reproduction of the original
- Mounting hardware not included
- Sold in pairs

110260 | RH/Passenger

110261 | LH/Driver

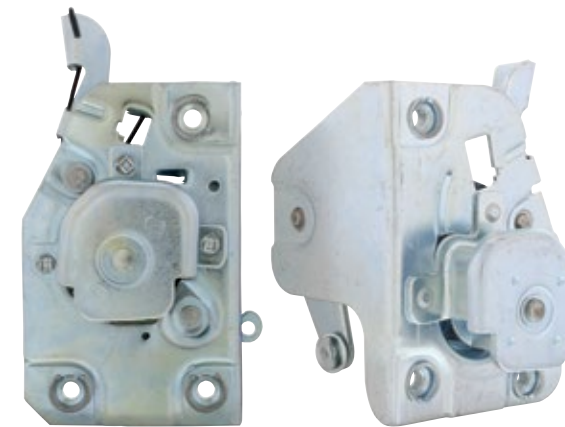

1967-72 Chevy & GMC

DOOR LATCH

- Zinc plated, precision stamping with original design mechanism
- Mounting hardware not included
- Sold individually

110262 | RH/Passenger

110263 | LH/Driver



1967-72 Chevy & GMC

DOOR LATCH STRIKER PLATE

- Zinc plated, excellent reproduction of the original
- Mounting hardware not included
- Sold in pairs

110223

RUNNING BOARDS / BEDSIDE STEPS

1947-54 Chevy & GMC Shortbed Truck

RUNNING BOARDS

- Black painted steel running boards
- Sold individually, please specify LH or RH side

170471 | LH/Driver

170472 | RH/Passenger



1947-54 Chevy & GMC Shortbed Truck

RUNNING BOARDS

- Chrome plated steel running boards
- Sold individually, please specify LH or RH side

170473 | LH/Driver

170474 | RH/Passenger



1955-59 Chevy & GMC Truck

SHORTBED BEDSIDE STEP

- Black painted steel running boards
- Sold individually, please specify LH or RH side

170551 | LH/Driver

170552 | RH/Passenger



1955-59 Chevy & GMC Truck

Longbed Bedside Step

- Black painted steel running boards for trucks with 7 1/2 foot bed
- Sold individually, please specify LH or RH side

170553 | LH/Driver

170554 | RH/Passenger



HANGERS / HARDWARE

1960-66 Chevy & GMC Truck

BEDSIDE STEP HANGERS

- Die stamped with heavy 14 gauge steel, black EDP coated
- Features all the original frame to step mounting patterns
- Sold individually, please specify LH or RH side

110400 | RH/Passenger

110401 | LH/Driver



1967-72 Chevy Truck

CAB MOUNT KIT

- Quality molded rubber cab mounts
- 38 piece kit
- Includes all mounting bolts, lock nuts, spacers and larger washers

C677204

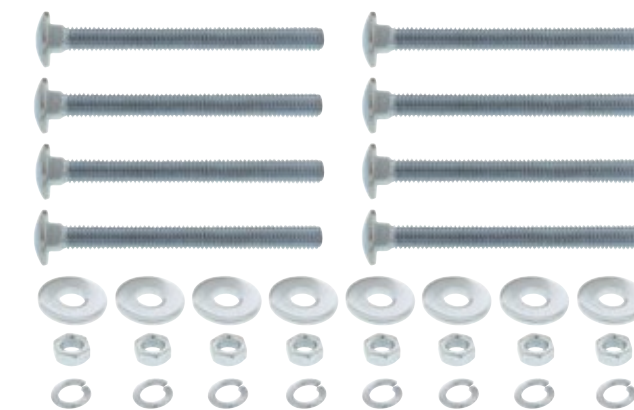

1967-72 Chevy & GMC Truck

PICKUP BED TO FRAME BOLT SET

- Special carriage bolts that mount the pickup bed to the frame
- Includes flat washers, lock washers, and hex nuts
- Zinc plated as original, sold as a set

110248



1941-53 Chevy & GMC Stepside Truck

TAILGATE HINGES

- Sold in pairs

C415301 | Black

C415301C | Chrome

GAS CAPS



1938-71 GM Passenger Car and Truck

VENTED LOCKING GAS CAP

- High quality chrome plated gas cap
 - Fits most early GM gas necks with 1.53" opening
 - Integrated lock, two keys included
 - For use only on vehicles originally equipped with vented gas cap
- 110319**



1938-71 GM Passenger Car and Truck

GM LOCKING GAS CAP

- High quality chrome plated gas cap
 - Fits most early GM gas necks with 1.53" opening
 - Integrated lock, two keys included
 - For use only on vehicles originally equipped with vented gas cap
- 110318**



1947-71 Chevy & GMC Truck

CHROME LOCKING GAS CAP

- High quality chrome plated, vented gas cap
 - Also fits 1958-63 Chevy car
 - Integrated lock, two keys included
- S1301**



FUEL TANKS



1949-55 Chevy & GMC 1st Series Truck

18 GALLON TIN SHEET FUEL TANK

- Die stamped with Ni-Terne treated steel sheet metal
 - Has all the original contour detail and mounting holes
 - Machine welded for an even and complete seal
- 110687**



1955-59 Chevy & GMC 2nd Series Truck

18 GALLON TIN SHEET FUEL TANK

- Die stamped with Ni-Terne treated steel sheet metal
 - Has all the original contour detail and mounting holes
 - Machine welded for an even and complete seal
- 110688**



1967-72 Chevy & GMC C/K Series Truck

20 GALLON TIN SHEET FUEL TANK W/O EVAP

- Die stamped with Ni-Terne treated steel sheet metal
 - Has all the original contour detail and mounting holes
 - Machine welded for an even and complete seal
 - For models without evap
- 110685**



1970-72 Chevy & GMC C/K Series Truck

20 GALLON TIN SHEET FUEL TANK W/ EVAP

- Die stamped with Ni-Terne treated steel sheet metal
 - Has all the original contour detail and mounting holes
 - Machine welded for an even and complete seal
 - For models with evap
- 110686**



1973-81 Chevy & GMC C/K Series Truck

16 GALLON STEEL ZINC PLATED FUEL TANK

- Die stamped with Ni-Terne treated steel sheet metal
 - Has all the original contour detail and mounting holes
 - Machine welded for an even and complete seal
- 110683**



1982-86 Chevy & GMC Shortbed Truck

16 GALLON STEEL ZINC PLATED FUEL TANK

- Die stamped with Ni-Terne treated steel sheet metal
 - Has all the original contour detail and mounting holes
 - Machine welded for an even and complete seal
 - Sending unit available separately, item number: 110675, 110671, and 110673
- 110684**

FUEL SENDING UNITS



1973-75 Chevy & GMC Truck

FUEL SENDING UNIT TANK - RH

- Made with corrosion resistant stainless steel sheet metal
 - Features a single outlet only design with brass float just like the original
 - Rubber seal, stainless steel lock ring, and strainer included
- 110676**



1973-79 Chevy & GMC 6 Cylinder Truck

FUEL SENDING UNIT TANK - RH

- Made with corrosion resistant stainless steel sheet metal
 - Features a single outlet only design with brass float just like the original
 - Rubber seal, stainless steel lock ring, and strainer included
- 110672**

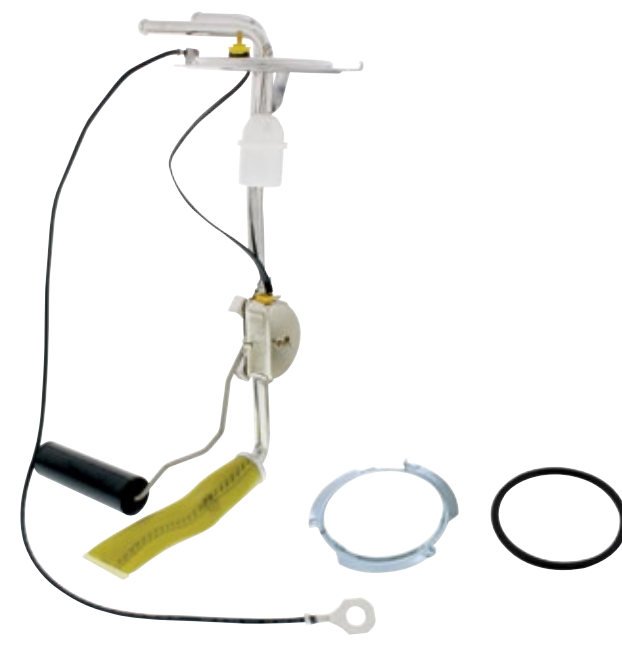

1973-79 Chevy & GMC Truck

FUEL SENDING UNIT TANK - LH

- Made with corrosion resistant stainless steel sheet metal
 - Features a 2 outlet design with brass float just like the original
 - Rubber seal, stainless steel lock ring, and strainer included
- 110674**



1973-79 Chevy & GMC Truck

FUEL SENDING UNIT TANK - RH

- Made with corrosion resistant stainless steel sheet metal
 - Features a 2 outlet design with brass float just like the original
 - Rubber seal, stainless steel lock ring, and strainer included
- 110670**



1980-84 Chevy & GMC Truck

FUEL SENDING UNIT TANK - LH

- Made with corrosion resistant stainless steel sheet metal
 - Features a 2 outlet design with brass float just like the original
 - Rubber seal, stainless steel lock ring, and strainer included
- 110673**



1980-89 Chevy & GMC Truck

FUEL SENDING UNIT TANK - RH

- Made with corrosion resistant stainless steel sheet metal
 - Features a 3 outlet design with brass float just like the original
 - Rubber seal, stainless steel lock ring, and strainer included
- 110671**

FUEL SENDING UNITS



1980-89 Chevy & GMC Truck

FUEL SENDING UNIT TANK - LH

- Made with corrosion resistant stainless steel sheet metal
 - Features a 3 outlet design with brass float just like the original
 - Rubber seal, stainless steel lock ring, and strainer included
- 110675**

EMBLEM

CHEVROLET

1967-68 Chevy & GMC Truck

CHROME HOOD LETTER EMBLEM SET

- Beautiful chrome plated die-cast
- Identical mounting stud location as original for easy replacement
- Speed nuts included
- OEM GM # 3892085, GM restoration licensed product

110057



HUB CAPS / EXHAUST DEFLECTORS



1947-53 Chevy 1/2 Ton Truck

CHROME HUBCAP

- Chrome hub cap with red Chevrolet script
- GM restoration parts, sold individually

C475303 | Stainless Steel

C475304 | Chrome



1968-70 Chevy Truck & Car

SS BULLET CENTER STYLE RALLY HUB CAP

- Set of 4 highly polished stainless steel
- Fits original rally wheels and aftermarket rally wheels

C687003



Universal

SMOOTH STAINLESS STEEL BEAUTY RIM

- Highly polished stainless steel, smooth plain style
- Round notch for valve stem clearance, sold individually

A6224-3 | 14" Beauty Rim

A6224-1 | 15" Beauty Rim

A6224-2 | 16" Beauty Rim



Universal

RIBBED STAINLESS STEEL BEAUTY RIM

- Highly polished stainless steel, smooth plain style
- Round notch for valve stem clearance, sold individually

A6224-4 | 14" Beauty Rim

A6224-5 | 15" Beauty Rim

A6224-6 | 16" Beauty Rim



Chevy & GMC Truck

EXHAUST DEFLECTOR

- 304 high grade stainless steel, rust free
- Fits most exhaust pipes, GM restoration parts

C2002 | With "Chevrolet" Script Bowtie

C2003 | With Bowtie



LICENSE PLATE FRAMES



1947-60 Chevy

CHROME LICENSE PLATE FRAMES

- Chrome zinc die-cast frame with white script and year on dark blue background
- GM restoration parts

C5041-47 1947	C5041-54 1954
C5041-48 1948	C5041-55 1955
C5041-49 1949	C5041-56 1956
C5041-50 1950	C5041-57 1957
C5041-52 1952	C5041-59 1959
C5041-53 1953	C5041-60 1960

LICENSE PLATE FRAMES



1962-72 Chevy

CHROME LICENSE PLATE FRAMES

- Chrome zinc die-cast frame with white script and year on dark blue background
- GM restoration parts

C5041-62 1962	C5041-68 1968
C5041-63 1963	C5041-69 1969
C5041-65 1965	C5041-70 1970
C5041-66 1966	C5041-71 1971
C5041-67 1967	C5041-72 1972

HORNS



Universal

ECONOMY TRAIN HORN

- Economy 3 & 4 trumpet air horns
- 46127 | Black 3 Trumpet
- 46129 | Chrome 3 Trumpet
- 46130 | Chrome 4 Trumpet



Universal

TRAIN WHISTLE

- Simulates the sound of a vintage train whistle
- Mounting hardware and 1/2" compression fitting included
- Powered by compressed air or live steam
- Operating range from 30 PSI to 120 PSI and up
- 5 1/2" L x 5" W x 13 1/8" H
- 46107 | Chrome
- 46108 | Brass



Universal

CHROME MINI TRAIN HORN

- Deluxe chrome 4 trumpet mini train horn
- Easy installation, approximate size: 6 1/2" x 12" x 6"
- 46123

Universal

CHROME DELUXE 4 TRUMPET TRAIN HORN

- Low rider style
- 150 + -10db sound output
- Width 15 3/4", length 15 1/4", height 9 3/4"
- 46143

HORNS / AIR COMPRESSOR



Universal

HIGH POWER DIXIE AIR HORN

- Air horn that imitates the howl of a wolf
- Hardware included
- 46153



Universal

RED ELECTRIC BULL HORN

- Air horn that imitates the sound of an angry bull
- Painted red housing, 12V systems
- 46103



Universal

ELECTRIC AH-OO-GAH HORN

- Chrome body, 12V systems
- -110 dB (A) sound pressure level, 490 Hz frequency
- 46138



Universal

WOLF SOUND HORN

- Air horn that imitates the howl of a wolf
- Hardware included
- 46128



Universal

TURBO COMPRESSOR AND TANK KIT

- Heavy duty compressor and tank system for high pressure air/train horns
- High volume turbo compressor with 5.5 liter extended tank
- On-board air system for all 12 volt vehicles
- 46140

PRODUCT INDEX

ITEM #	PAGE #
C5041-48	113
C5041-49	113
C5041-50	113
C5041-52	113
C5041-53	113
C5041-62	114
C5041-63	114
C5041-65	114
C5041-66	114
C5041-67	114
C515301	51
C515301	54
C515321	54
C535910CR	83
C545502BK	45
C545502CR	45
C545502SS	45
C545503BK	45
C545503CR	45
C545503SS	45
C545504-2	44
C545504BK	36
C545504SS	36
C545505	36
C545506	44
C545507	36
C545521	87
C555711	70
C555751A	51
C555751C	51
C555755	54
C555901	58
C555902	102
C555903	102
C555904	88
C555905	88
C555908	37
C555909	44
C555910	36
C555911	36
C555911-3	44
C555912	37
C555921	87
C555931	87
C555941	78
C555942	78
C555943	78
C555944	78
C556601BK	45
C556601CR	45

ITEM #	PAGE #
C556601SS	45
C556602BK	45
C556602CR	45
C556602SS	45
C585901	37
C585902	37
C585902ALU	44
C585902SS	44
C585911	70
C585981	27
C60609C	40
C606321	87
C606331	87
C606603	40
C606603	44
C606604	70
C606605	37
C606607	36
C606608	36
C606609	40
C606610	37
C606611	40
C606612	54
C606614	45
C606615	45
C606616	39
C606616BD	39
C606616C	39
C606617	40
C606618	40
C606621	52
C606651	45
C607110	84
C607111	84
C607112	84
C626601	53
C646621	87
C646631	87
C676802	95
C676811A	52
C676811C	52
C676812	54
C676851	92
C677201	102
C677203	70
C677204	106
C677207	45
C677209	42
C677210	95
C677211	95

ITEM #	PAGE #
C677212	70
C677214	96
C677215	96
C677216	96
C677217	96
C677218	96
C677251	92
C677601	100
C677602	100
C678101	100
C679101	56
C687003	112
C687202	56
C687203	56
C697020	52
C697021	52
C7001G	59
C7001L	33
C7001L-1	33
C7001R	33
C7001R-1	33
C7002R	33
C7003L	45
C7003R	45
C7004L	45
C7004R	45
C7006	38
C7006-1	38
C7007	46
C7008	38
C7008-1	38
C7009A	51
C7009C	51
C7010	51
C7011	27
C7011-KIT	27
C7012	27
C7013	27
C7014A	51
C7014C	51
C7018	95
C7019	51
C7021	59
C7026LSS	45
C7026RSS	45
C7028L	33
C7028L-1	33
C7028R	33
C7028R-1	33
C7031RL	33

PRODUCT INDEX

ITEM #	PAGE #
C7031RLBD	32
C7031RR	33
C7031RRBD	32
C7032RLBD	32
C7033RL	33
C7033RLBD	32
C7033RR	33
C7033RRBD	32
C707201	73
C707201	73
C707201-LED	72
C707202	73
C707202	73
C707202-LED	72
C717201	54
C717221	52
C738001	56
C738002	56
C738003	56
C738011	70
C738703	46
C738704	43
C738705	43
C738710	73
C738710-CVXLED	72
C738710-LED	72
CML6872A	56
CML6872R	56
CML7380A	56
CML7380R	56
CPL4753A	50
CPL4753A-AS	50
CPL4753C	50
CPL4753C-AS	50
CPL5153C	50
CPL5557A	50
CPL5557C	50
CPL6066A	48
CPL6768A	48
CPL6768C	48
CPL6970AL	49
CPL6970AR	49
CPL6970CL	49
CPL6970CR	49
CPL7172A	48
CPL7172C	48
CTL4053LED-CL	34
CTL4053LED-CR	34
CTL4053LED-L	34
CTL4053LED-LBD	34

ITEM #	PAGE #
CTL4053LED-R	34
CTL4053LED-RBD	34
CTL4053LL	59
CTL5459BC	35
CTL5459BR	35
CTL5459C	37
CTL5459LED	37
CTL5459SC	35
CTL5459SR	35
CTL5859C	37
CTL5859LED	37
CTL6066BC	36
CTL6066BR	36
CTL6066C	37
CTL6066FC	40
CTL6066FSC	39
CTL6066FSLED	40
CTL6066FSR	39
CTL6066LED	37
CTL6066SC	36
CTL6066SR	36
CTL6721C	41
CTL6721LED	41
CTL6721SEQ	41
CTL6722CL	38
CTL6772C	38
CTL6772LED	38
CTL7387LED-L	43
CTL7387LED-R	43
H5006	17
M1003	81
S1201	90
S1202	90
S1204	89
S1301	107