



United Pacific

# ANTIQUE

2019 *New Product Collection*





## QUALITY

With over 30 years of experience in the automotive aftermarket industry, United Pacific Industries understands the rigors and stresses that our products are subjected to on the road. It is our mission to provide our customers with products of superior quality and reliability. In achieving this goal, United Pacific only partners with manufacturing facilities that conforms to our quality control requirements and standards. Our manufacturing partners meet or exceed ISO-9001 requirements. In addition, United Pacific's manufacturing partners must be equipped on site to perform the following quality assurance tests and maintain a track record of consistent quality and low product failure rate.

- Aging Test
- Air Tight Test
- Dust Test
- Flux Test
- Photometric Test
- Pull Force Test
- Rain Test
- Salt Spray Test
- Shock Test
- Temperature Test
- Humidity Test
- Vibration Test

Furthermore, our internal quality control structure allows us to function as the final quality control station prior to shipping. With the assistance of 3D computer technology, United Pacific can adhere to strict quality control standards during prototype creation and the production process. Our engineers and technicians perform a battery of tests to ensure that our products meet the demands of today's drivers and our goal to be first in quality.

## INNOVATION

Known as the leader in innovation, United Pacific is dedicated to be the first to bring new and exciting products to the market. United Pacific's global expertise allows us to search the globe for new ideas and concepts. Not only do we search the globe for new products, United Pacific invest a significant amount of resources into our own research and development efforts. With the assistance of advance 3D scanning technology, our engineers and designers can acquire accurate and precise data in seconds. The 3D data allows United Pacific to verify designs, perform quality assurance tests, and reverse engineer with unprecedented speed and accuracy. Digital inspection contributes to the early detection of shape problems, provides rapid feedback on design, and eliminates unnecessary work in downstream processes. Our rapid prototyping facility permits us to have a concept-to-shelf time of less than 5 months. In addition, United Pacific's 3D printing capabilities permit our designers to have physical models of their design concepts in hours. The physical models allow our designers and marketing staff to evaluate and test the viability of different design ideas. Our rapid prototyping facility allow United Pacific to compress design cycles, improve manufacturing planning, shorten concept-to-shelf time, most importantly, generate new and innovative products.

## DESIGN

Located near some of the nation's most progressive automotive design centers, United Pacific established the UP Design Studio in 2002 to consolidate our position as the design leader in the automotive industry. UP Design Studio utilizes the latest generation of computer aided design (CAD) and studio/graphic software. The design studio is equipped with the newest computers and rapid prototyping systems. In addition, UP Design Studio is staffed by graduates from the nation's most prestigious design colleges. Unlike our competitors, United Pacific's design and manufacturing capabilities mean that we carry more new and original items than our competitors. The establishment of the design studio will enable us to generate even more new products with significant shorter concept-to-shelf time. The reduction in development cost mean that we can develop products utilizing design based development processes. Design based product development allows United Pacific to create new product concepts based on designs incorporating driver demands and needs instead of economic considerations. United Pacific's emphasis on design distinguishes and positions us ahead of our competitors.

## INVENTORY AND SHIPPING

United Pacific carries over 20,000 items in our California distribution center. No other company in the heavy duty trucking industry can match United Pacific in the variety and range of in-stock inventories. With an order fill rate of over 98.5%, United Pacific is the largest and most reliable supplier in the industry.



## HARD AT WORK FOR THE ENVIRONMENT



**United Pacific**  
132,000 sq ft

**100%** reduction in potable water used for landscaping

**40%** reduction in total energy use due to high-efficiency mechanical and lighting systems

**82%** of construction waste was diverted from landfills

## LEED ACCOMPLISHMENTS

### Sustainable Sites

- On-site bicycle storage, showers and changing areas for company employees.
- Preferred parking for low-emitting, fuel-efficient and carpool vehicles.
- Stormwater is infiltrated on-site and treated to remove contaminants to reduce environmental impact on local waterways.

### Water Efficiency

- In addition to using reclaimed water, drought-tolerant plants and a high-efficiency irrigation system were installed to reduce the use of potable water for irrigation by 100%.

### Energy and Atmosphere

- Efficient HVAC equipment and a lighting system with daylight controls reduces energy consumption by over 30%.
- Enhanced commission verifies that the building's energy and water-related systems are performing as intended by the initial design.

### Indoor Environmental Quality

- Building ventilation systems was designed to provide enhanced levels of fresh outside air to building occupants.
- Interior finishes (plants, sealants, adhesives, coatings, carpet systems and composite wood) were selected with low levels of volatile organic compounds (VOCs) to reduce indoor air contamination.



# NEW ITEMS

## Parts & Accessories for Ford, Chevy Truck & Mustang

For 1932-34 Ford

January 2019



### Front Fender for 1933-34 Ford Passenger Car

- Quality stamped steel, exactly as original Henry!
- Made of excellent 20 gauge sheetmetal
- Fender edge bead with steel inner wire as original
- Precision punched quarter panel mounting holes
- Includes mounting holes for frame horn cover
- Coated with black EDP
- Sold individually, please specify left or right hand side
- Oversize freight policy



**B24031** L/H - 1 Pc. / Box

**B24032** R/H - 1 Pc. / Box

### Rear Fender for 1933-34 Ford Passenger Car



**B24034**



**B24033**

**B24033** L/H - 1 Pc. / Box

**B24034** R/H - 1 Pc. / Box

### Rear Fender for 1932 Ford 5W Coupe & Roadster



**B20334**



**B20333**

**B20333** L/H - 1 Pc. / Box

**B20334** R/H - 1 Pc. / Box

### Rear Fender for 1932-34 Ford Truck



**B21032**

**B21031**



**B21034**

**B21033**

**B21031** 32 Truck L/H - 1 Pc. / Box

**B21032** 32 Truck R/H - 1 Pc. / Box

**B21033** 33-34 Truck L/H - 1 Pc. / Box

**B21034** 33-34 Truck R/H - 1 Pc. / Box

### For Ford Truck



### Roof Assembly for 1932 Ford Truck

- Desirable version without rib
- Also perfect fit on 1933-34 truck
- Exact replica of original die stamped roof assembly
- Includes visor with support, door header structure, structural ribs, and wiper mount
- United Pacific Classic-Coat® weldable primer

**B21052** 1 Pc. / Box

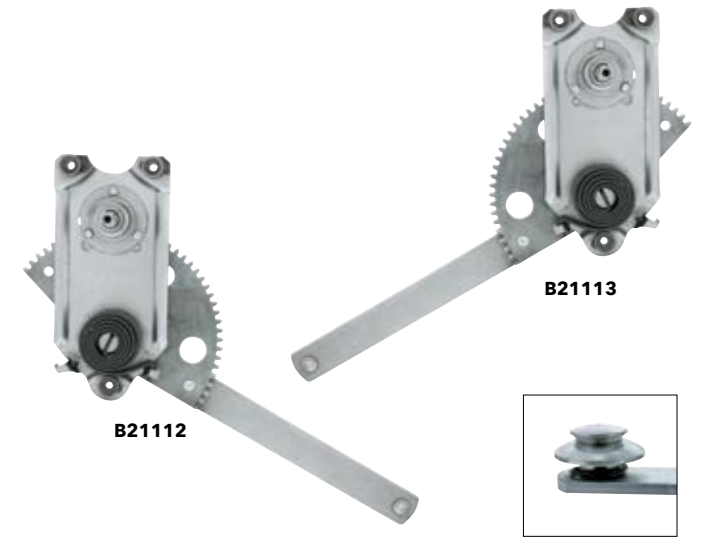

**B21112**

**B21113**

### Window Regulator for 1932-34 Ford Truck

- Original style regulator with correct spring loaded guide roller
- Also fits 1932 5-Window coupe back window

**B21112** R/H - 1 Pc. / Box

**B21113** L/H - 1 Pc. / Box

### Also Available



**B20147**

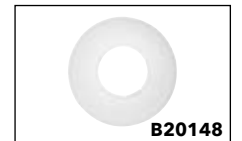

**B20148**



**B21124**

**B21123**

### B-Pillar Door Striker Jamb for 1932-34 Ford Truck

- Die stamped steel exactly as original
- Includes floating threaded nut plate for door striker mounting
- United Pacific Classic-Coat® weldable primer

**B21123** L/H - 1 Pc. / Box

**B21124** R/H - 1 Pc. / Box



### Inside Door Handle for 1932-34 Ford Truck

- Inside door handle for 1932-34 Ford Truck

**B20146** 1 Pc. / Bulk



**B21114**

**B21115**

### Lower Glass Mental Channels for 1932-34 Ford Truck

- High tensile strength steel just like original
- Regulator roller track has correct concave shape for smooth operation
- Use with original rubber seal or glass setting tape, no need to glue!
- Black EDP finish

**B21114** R/H - 1 Pc. / Box

**B21115** L/H - 1 Pc. / Box



### Chrome Rear Bumper for 1964.5-66 Ford Mustang

- Made of heavy duty 13 gauge steel
- Beautifully chrome plated with triple plating process
- Features all the original contour and detail
- Precision punched square carriage bolt holes for straight forward installation
- Show ready chrome plating finish

**110486** 1 Pc. / Box



### Chrome Center Hubcap for 1978-84 Ford F250/F350 Truck

- Quality die stamped steel and chrome plated
- Satin black painted accent as original
- Fits 3/4 & 1 ton Ford trucks and vans
- 12-5/16" dia.
- Sold each

**110751** 1 Pc. / Box



### 15" Woodgrain Steering Wheel for 3-Bolt Hubs

- Wood grip with finger grooves and aluminum rivets
- 304 stainless steel spokes
- Dish depth : 4"
- This steering wheel is compatible with ALL 3-bolt steering wheel hub kits on the market
- Hub adaptor and horn button kit sold separately

**110794** 1 Pc. / Box



### Bumper Bolt Set for 1966-77 Ford Bronco & 1964.5-70 Ford Mustang

- Highly Polished 1" Long 7/16-14 Carriage Bolt to Match that Beautifully Polished Front and Rear Bumper
- Includes Spring Wave Washers and Serrated 7/16-14 Flange Locknuts
- Two Extra 5/16-18 Polished Carriage Bolts and Nuts for the Mustang Front Bumper

**110536** 1 Set / Card



### 4 Pcs. Cowl Brace Set for 1966-77 Ford Bronco

- High quality 17 and 19 gauge stamped steel
- Finish with black EDP protective coating
- Fills the empty upper corner area between the windshield cowl mount and the A-pillar

**110590** 1 Set / Bulk



### Battery Hold Down Bolt Set for 1955-59 Chevy

- Clear zinc plating hold down bolts with washer

**110807** 1 Set / Bulk



### Chrome Plated Steel Running Board for 1947-54 Chevy & GMC Shortbed Truck

- Ribbed style just like original
- Underside retainer brackets pre-welded for easy installation
- Sold individually, please specify L/H or R/H side

**170473**

L/H - 1 Pc. / Box

**170474**

R/H - 1 Pc. / Box

**LED Work Light**



**COMPETITION SERIES** **1000 Lumens** **12v/24v** **IP68 WATERPROOF**

**5 LED High Power Mini Round Work Light**

- 5 high power LED lights with spot or flood function for powerful performance
- IP68 waterproof with die cast housing and sealed polycarbonate lens provide maximum protection & durability
- Solid state design resists shock and vibration

<b>36461</b>	<b>Flood</b> - 1 Pc. / Color Box
<b>36463</b>	<b>Spot</b> - 1 Pc. / Color Box



**COMPETITION SERIES** **1000 Lumens** **12v/24v** **IP68 WATERPROOF**

**5 LED High Power Mini Square Work Light**

- 5 high power LED lights with spot or flood function for powerful performance
- IP68 waterproof with die cast housing and sealed polycarbonate lens provide maximum protection & durability
- Solid state design resists shock and vibration

<b>36462</b>	<b>Flood</b> - 1 Pc. / Color Box
<b>36464</b>	<b>Spot</b> - 1 Pc. / Color Box

# NEW ITEMS

**Parts & Accessories for Ford, Chevy Truck & Mustang**

**For 1953-56 Ford**

**38 Red LED Tail Light for 1953-56 Ford Truck**

- Super bright LED with excellent quality red polycarbonate lens
- Additional white LED with clear lens for license plate light
- 1157 double connector with offset pins, plugs into existing socket
- Electronics completely sealed in epoxy to resist corrosion and moisture
- Energy efficient solid-state circuit board engineered for 12VDC systems
- Recommended under dash flasher United Pacific 90652 (2-terminal) or 90651 (3-terminal)
- Sold individually, please specify left or right hand side

<b>110142</b>	<b>L/H</b> - 1 Pc. / Card
<b>110143</b>	<b>R/H</b> - 1 Pc. / Card



**110142**

**110143**



**1000 Lumens**

**Magnetic Rechargeable LED Work Light**

- High power portable LED flood light with polycarbonate lens
- 3 brightness options: 30% / 70% / 100%
- 3 flashing options: Fast / Slow / S.O.S.
- Solid state design resists shock and vibration
- The ultra-strong magnetic base holds the light to most metallic surfaces
- USB port for recharging cell phones
- Rechargeable lithium battery provides 4 hours of run time

<b>36624</b>	1 Pc. / Color Box
--------------	-------------------

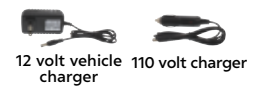
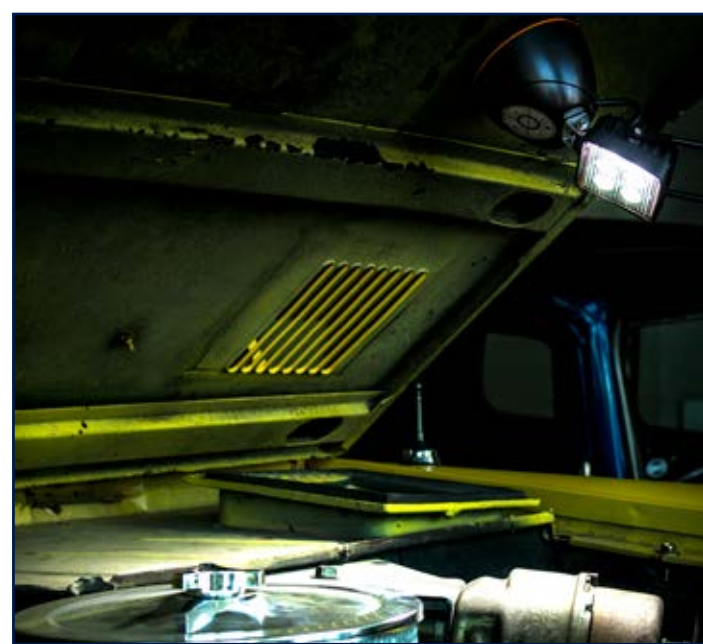

**110786**

**110789**

**Vent Window Assembly for 1968 Ford Mustang**

- Die cast chrome plated with highly polished stainless steel glass frame and division bar
- Factory assembled with high quality rubber seal
- Exact design as original for a straight forward replacement
- Period correct chrome vent window handle
- Includes door glass channel with felt
- Available with crystal clear non-tinted tempered window glass or original style green tinted tempered window glass
- Sold individually, please specify left or right hand side

<b>110786</b>	<b>R/H Clear</b> - 1 Pc. / Box
<b>110787</b>	<b>L/H Clear</b> - 1 Pc. / Box
<b>110788</b>	<b>R/H Tint</b> - 1 Pc. / Box
<b>110789</b>	<b>L/H Tint</b> - 1 Pc. / Box

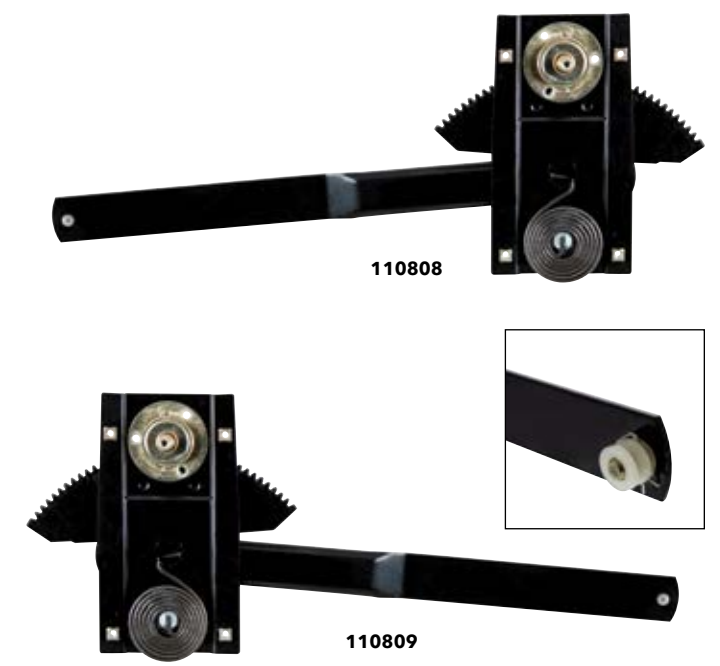

**110808**

**110809**

**Window Regulator for 1966-77 Ford Bronco**

- Excellent quality high strength steel stamping
- Original style counter balance spring design
- OEM specification for easy installation
- Window channel roller and retainer ring included
- Replace OEM number: 710270058501 (L/H) / 710270058518 (R/H)
- Sold individually, please specify left or right hand side

<b>110808</b>	<b>L/H</b> - 1 Pc. / Bulk
<b>110809</b>	<b>R/H</b> - 1 Pc. / Bulk

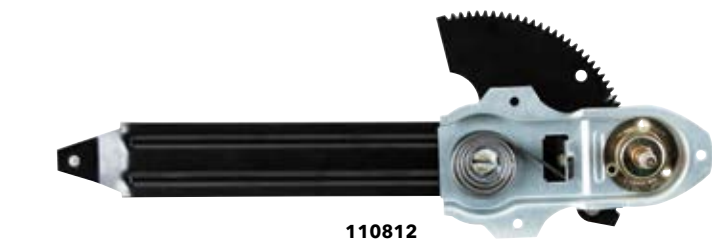

110812



110813

**Window Regulator for 1973-79 Ford Truck & 1978-79 Ford Bronco**

- Excellent quality high strength steel stamping
- Original style counter balance spring design
- OEM specification for easy installation
- Replace OEM number: 710270058549 (L/H) / 710270058556 (R/H)
- Sold individually, please specify left or right hand side

<b>110812</b>	<b>L/H</b> - 1 Pc. / Bulk
<b>110813</b>	<b>R/H</b> - 1 Pc. / Bulk

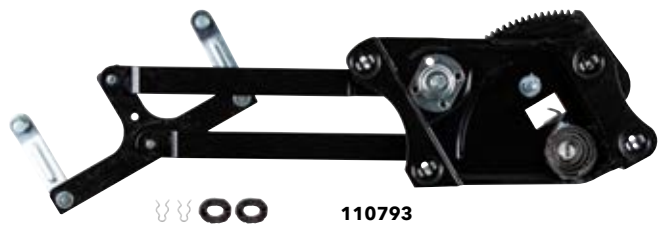

110793



110792

**Window Regulator for 1948-52 Ford Truck**

- Excellent quality high strength steel stamping
- Original style counter balance spring design
- OEM specification for easy installation
- Retainer clips and mounting hardware included
- Sold individually, please specify left or right hand side

<b>110792</b>	<b>R/H</b> - 1 Pc. / Box
<b>110793</b>	<b>L/H</b> - 1 Pc. / Box



2-1/2"

10"



**Interior Rear View Mirror with Day/Night Option for 1968-73 Ford Mustang**

- Premium quality mirror glass
- High quality black plastic mirror back housing
- Day/Night switch over function for safer night time driving
- Exact design as original for a straight forward replacement

<b>110711</b>	1 Pc. / Box
---------------	-------------



3/4"

3 1/4"

**Chrome Interior Rear View Mirror Bracket for 1968-69 Ford Mustang**

- Highly detailed die casting with chrome plating
- Includes mirror head mounting screw

<b>110710</b>	1 Pc. / Box
---------------	-------------

**NEW & IMPROVED**



22974



22975



22976



22977

**U.S. Military Adhesive Metal Medallion - 1 3/4"**

- 1 3/4" round U.S. military adhesive metal medallion
- Minted in a brass alloy and finished in bronze
- Officially licensed product

<b>22974</b>	<b>Air Force</b> - 1 Pc. / Bulk
<b>22975</b>	<b>Army</b> - 1 Pc. / Bulk
<b>22976</b>	<b>Navy</b> - 1 Pc. / Bulk
<b>22977</b>	<b>Marine</b> - 1 Pc. / Bulk



**COMPETITION SERIES**

**Heavy Duty 12V 140 PSI Air Compressor & Tank Kit**

- Heavy duty air compressor and tank system
- 140 psi for air horns, general on-board air applications & off-road use
- High volume reciprocating compressor with 1.5 gallon tank permits extended air horn operation
- Automatic on/off pressure switch
- Compressor & tank can be stacked together, or mounted separately to accommodate different mounting locations
- External screw thread hose connector: 1/4NPT & 1/8NPT
- Hose size: O.D. 1/4"
- Sold in set, includes 1 air compressor and 1 air tank
- Kit includes: 12 volt air compressor, steel air tank with safety valve, air pressure gauge, air hose and connector fittings to attach most air horns and mounting hardware & instructions

<b>46154</b>	1 Set / Color Box
--------------	-------------------

**10 Quarts Capacity**



**10qt Da Coolbox Thermoelectric Cooler / Warmer**

- Cools without ice, making more space for food and drinks
- Great for travel to keep your contents fresh and dry
- Shoulder strap for easy transportation
- USB charging port for mobile devices
- Selector switch for cool/heat
- Solid, strong exterior for added durability

<b>99121</b>	1 Pc. / Color Box
--------------	-------------------

**23 Quarts Capacity**



**23qt Da Coolbox Thermoelectric Cooler / Warmer**

- Cools without ice, making more space for food and drinks
- Great for travel to keep your contents fresh and dry
- Shoulder strap for easy transportation
- USB charging port for mobile devices
- Digital LCD display and temperature adjustment control
- Solid, strong exterior for added durability

<b>99122</b>	1 Pc. / Color Box
--------------	-------------------

# NEW ITEMS

March 2019

## Parts & Accessories for Ford & Chevy Truck



### For 1932-34 Ford Truck

#### Dash Inner Support Brace for 1932-34 Ford Truck

- Heavy 16 gauge sheet metal stamping
- Exact dash and cowl top inner support curvature as original
- 12-24 D-Nut pre-attached from factory for easy dash installation
- Pre-drilled rivet holes with original specification
- Black EDP coated finish



**B21072**

1 Pc. / Box

### For 1968-72 Chevy Truck



#### Headlight Switch Knob for 1968-72 Chevy & GMC Truck

- High quality plastic injection molded with durable polypropylene plastic
- Deluxe style with stainless steel center insert
- Original style triangular shape steel rod with notched tip
- Perfect for replacing that wore out and faded knob
- To install, simply push the release button at the top of the switch housing and pull the old knob out, then slide the new one in

**110701** 1 Pc. / Card



#### Windshield Wiper Knob for 1968-72 Chevy & GMC Truck

- High quality plastic injection molded with durable polypropylene plastic
- Deluxe style with stainless steel center insert
- Original style "D" profile mounting hole with included set-screw

**110700** 1 Pc. / Card

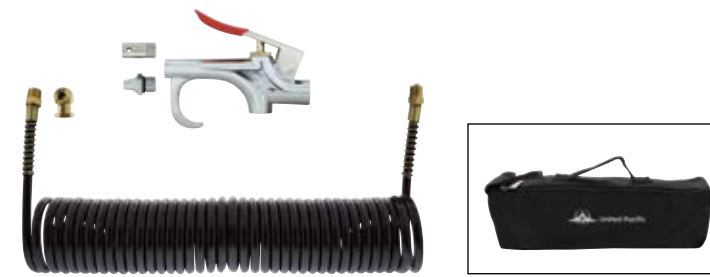

#### 30' Extension Hose with Air Chuck and Air Blow Gun Kit

- Includes air chuck and chrome plated air blow gun
- Quality black nylon bag included

**89997** 1 Set / Bag

#### ACC-OFF-ON-START Ignition Plate for 1968-72 Chevy & GMC Truck



#### ACC-OFF-ON-START Ignition Plate for 1968-72 Chevy & GMC Truck

- Quality plastic injection molded with durable black ABS plastic
- Raised lettering with chrome finish
- Perfect for replacing that wore out and faded plate
- Mount exactly like original for easy installation

**110694** 1 Pc. / Card

#### LED 3rd Brake Light



**33010**

4 HARD WIRE



**33009**

3 HARD WIRE



#### 10 LED 3rd Brake Light with Adjustable Pedestal Base

- Designed with adjustable base mount for inside rear window installation
- Available with split LED function for lefthand & righthand turn signal
- Available with running light and brake light
- Base swivels 180° for multiple application



#### COMPETITION SERIES

#### 12V 140 PSI Heavy Duty Air Compressor

- Excellent performance in a small form factor
- Design for general on-board air application such as air/train horns and off-road use
- Mounting brackets with vibration dampening brushing
- Kit includes air compressor, high pressure steel braided air hose, wiring harness with in-line fuse, air filter, and mounting hardware

**46156** 1 Set / Color Box

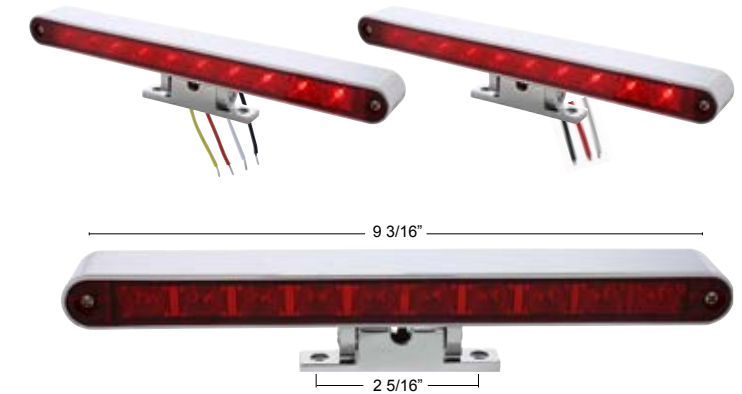

9 3/16"

2 5/16"



#### Split Dual Function Versions:

**33010** Split Function Red LED/Red Lens - 1 Pc. / Card

#### Regular Dual Function:

**33009** Dual Function Red LED/Red Lens - 1 Pc. / Card



# NEW ITEMS

## Parts & Accessories for Ford & Chevy Truck

April 2019

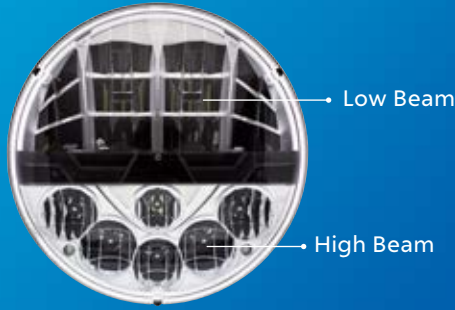

100%LED

DOT & SAE APPROVED

### High Power LED 7" Headlight with Polycarbonate Lens & Housing

- High power 12 LED headlight for powerful performance
- Durable corrosion resistant polycarbonate lens & housing
- Solid state design resists shock and vibration
- DOT/SAE headlight compliant
- Easy connection, fits OEM housing, plugs into existing wiring harness, position light requires additional wiring

31084 1 Pc. / Card

Technical Specification	
<b>Low Beam Application</b> 500 Lumens / 5700K 12V/24V Multiple Voltage	<b>High Beam Application</b> 950 Lumens / 5700K 12V/24V Multiple Voltage

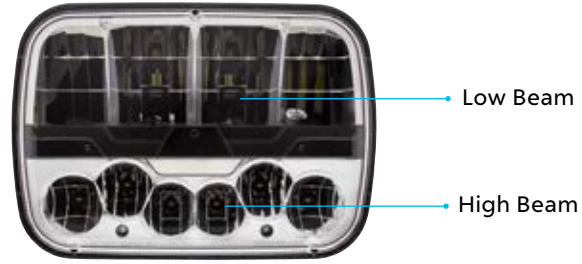

100%LED

DOT & SAE APPROVED

### High Power LED 5"x 7" Headlight with Polycarbonate Lens & Housing

- High power 12 LED headlight for powerful performance
- Durable corrosion resistant polycarbonate lens & housing
- Solid state design resists shock and vibration
- DOT/SAE headlight compliant
- Easy connection, fits OEM housing, plugs into existing wiring harness, position light requires additional wiring

31087 1 Pc. / Card



100%LED

DOT & SAE APPROVED

Technical Specification	
<b>Low Beam Application</b> 800 Lumens / 6500K 12V/24V Multiple Voltage	<b>High Beam Application</b> 1000 Lumens / 6500K 12V/24V Multiple Voltage

### High Power LED 4"x 6" Headlight with Polycarbonate Lens & Housing

- High power 5 LED low beam headlight for powerful performance
- Durable corrosion resistant polycarbonate lens & housing
- Solid state design resists shock and vibration
- DOT/SAE headlight compliant
- Easy connection, fits OEM housing, plugs into existing wiring harness, position light requires additional wiring

31088 Low Beam - 1 Pc. / Card  
31089 High Beam - 1 Pc. / Card



### Pool Ball Gearshift Knob

- Beautiful gloss pool ball gearshift knob
- Brushed aluminum mounting base adapter
- Hex screw mount design, includes nylon reducing bushings to fit smaller shifters

70661	#1 - 1 Pc. / Card
70662	#2 - 1 Pc. / Card
70663 (NEW)	#3 - 1 Pc. / Card
70754 (NEW)	#4 - 1 Pc. / Card
70755 (NEW)	#5 - 1 Pc. / Card
70756 (NEW)	#6 - 1 Pc. / Card
70757	#7 - 1 Pc. / Card
70025	#8 - 1 Pc. / Card

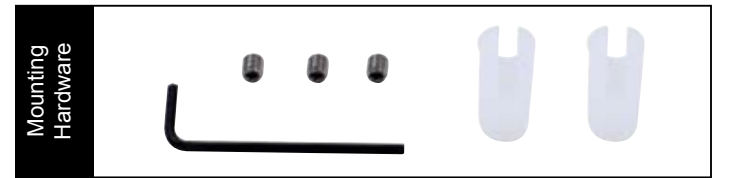

70758 (NEW)	#9 - 1 Pc. / Card
70759 (NEW)	#10 - 1 Pc. / Card
70760 (NEW)	#11 - 1 Pc. / Card
70761 (NEW)	#12 - 1 Pc. / Card
70762 (NEW)	#13 - 1 Pc. / Card
70763 (NEW)	#14 - 1 Pc. / Card
70764 (NEW)	#15 - 1 Pc. / Card



### Chrome Spike Nut Cover For 2001-14 Ford F-Series - Push-On

- Fits 1999-2004 Ford F-Series truck models with original steel wheel
- Spike is quality molded plastic with beautiful long lasting chrome plating
- 21mm x 3" push on

10353B 1 Pc. / Bulk



### LED Headlight PWM Anti Flicker Module & Adaptor

- Works With Most Vehicles Using Pulse Width Modulated Electrical System, Such as 2007-Present Jeep JK
- Eliminates Flicker on LED Headlamps
- Adapts Common H13 Plug to H4 Plug Used by Most LED Headlights

34217B 1 Pc. / Bulk



2018 New Item Flyer Collection  
Item # ANF1218

**Available Now!**

### New Item Flyer Collection

ANF1218 (NEW)	2018 New Items - 1 Pc. / Bulk
ANF1217	2017 New Items - 1 Pc. / Bulk

# NEW ITEMS

## Parts & Accessories for Ford & Chevy Truck

### Sequential Tail Light

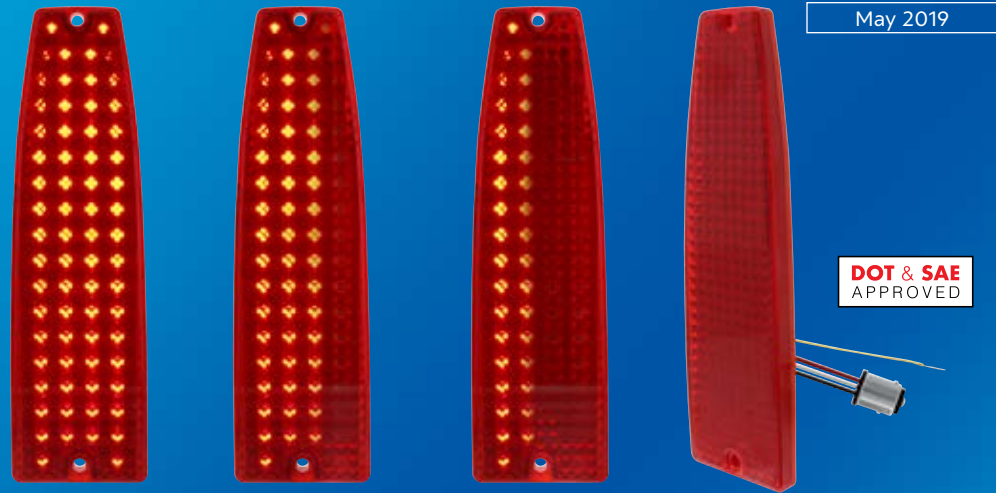

#### One-Piece Style Sequential LED Tail Light For 1966-67 Chevy II & Nova

- 68 SMD super bright LED with high quality all red polycarbonate lens
- Custom style one-piece design with backup light deleted
- Direct plug & play installation with 1157 type connector
- Electronics completely sealed in epoxy to resist corrosion and moisture
- Solid state circuit board engineered for any 12VDC system
- Lifetime warranty\* (see catalog or website for details)
- Recommend to upgrade under dash flasher to item no. 90649 or no. 90652 LED flasher
- Recommend license plate frame with LED back-up light, item no. 50187/50121



((( SEQUENTIAL )))  
F · L · A · S · H

((( BRAKE )))  
ATTENTION

110360

1 Pc. / Card



#### One-Piece Style LED Tail Light for 1966-67 Chevy II & Nova

- 68 SMD super bright LED with high quality all red polycarbonate lens
- Custom style one-piece design with backup light deleted
- Direct plug & play installation with 1157 type connector
- Electronics completely sealed in epoxy to resist corrosion and moisture
- Solid state circuit board engineered for any 12VDC system
- Lifetime warranty\* (see catalog or website for details)
- Recommend to upgrade under dash flasher to item no. 90649 or no. 90652 LED flasher
- Recommend license plate frame with LED back-up light, item no. 50187/50121

110359 1 Pc. / Card

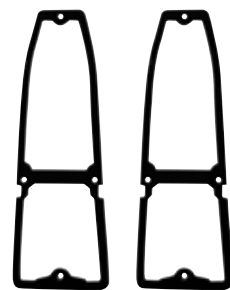

#### Tail Light Lens Gasket For 1966-67 Chevy Nova

- Quality thick black foam gasket

C666702 1 Pair / Bulk



#### LED Flasher w/Reverse Polarity Base & Extension Wires

- 12 Volt, 20 Amp maximum
- Solves turn signal problems, such as hyper flashing, no flashing, or burnt out bulb indication when using LED lights and bulbs
- Includes Polarity Reversing Base & Extension Wires

90649 1 Pc. / Card

### Sequential Tail Light



DOT & SAE APPROVED

#### 38 LED Sequential Tail Light with Black Housing for 1953-56 Ford Truck

- Super bright SMD LED with high quality all red polycarbonate lens
- Additional white LED with clear lens for license plate light
- Feature sequential function with selector switch to control sequential function off, direction left, or direction right
- Also features a brake attention option with a sequential-once function
- Fully assembled with glossy black die stamped metal housing with mounting studs
- Easy electrical connection with open ended wiring
- Recommended under dash flasher United Pacific 90652(2-terminal) or 90651 (3-terminal)



((( SEQUENTIAL )))  
F · L · A · S · H

((( BRAKE )))  
ATTENTION

110763

L/H - 1 Pc. / Card

110764

R/H - 1 Pc. / Card



DOT & SAE APPROVED

#### 38 LED Tail Light with Black Housing for 1953-56 Ford Truck

- Super bright SMD LED with high quality all red polycarbonate lens
- Additional white LED with clear lens for license plate light
- Fully assembled with glossy black die stamped metal housing with mounting studs
- Easy electrical connection with open ended wiring
- Electronics completely sealed in epoxy to resist corrosion and moisture
- Solid state circuit board engineered for any 12VDC system
- Recommended under dash flasher United Pacific 90652 (2-terminal) or 90651 (3-terminal)

110759

L/H - 1 Pc. / Card

110760

R/H - 1 Pc. / Card



#### Windshield A-Pillar Trim Covers for 1932-34 Ford Truck

- High quality 19 gauge stamped steel
- Feature all of the original contour detail
- Precision punched slide arm pivot bracket pass-thru hole
- Countersink mounting screw holes just like original
- Coated in black EDP for corrosion resistance

B21045 1 Pair / Box

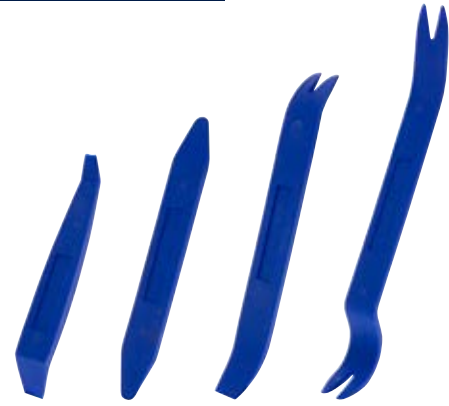

**Auto Trim Removal Pry Tool Kit - 4pcs/Kit**

- Four-piece kit with different ends to help remove many types of molding, door panels, trims, and dashboards with ease
- Constructed of durable nylon fiber that does not break or bend like ABS plastic
- Soft curve surface prevents accidental scratches or damage to the vehicle or trim

**99135** 1 Set / Box



**Chrome Spike Nut Cover for 2004 - 2014 Ford F-Series with OE Steel Wheel - Push-On**

- Molded with quality plastic material
- Beautiful long lasting chrome plating
- Will fit any 13/16" (21mm) wheel lug nuts
- 21mm x 3" push-on type fitting

**10352B** 1 Pc. / Bulk

For Harley Davidson

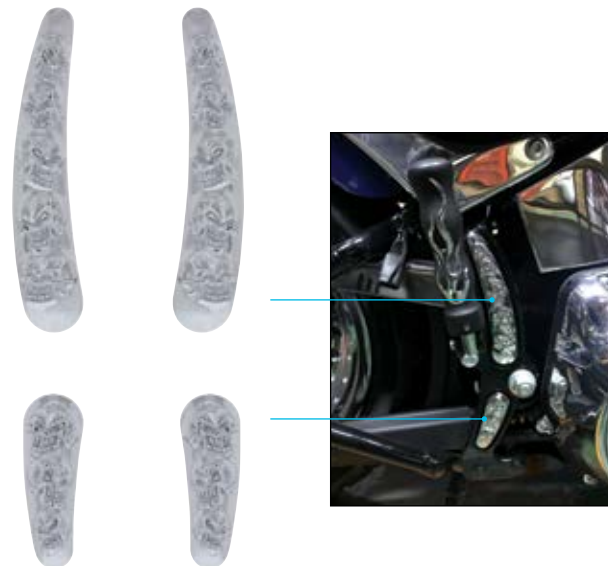

**Skull Swing Arm Accent Set**

- Fits 2008-17 Harley-Davidson Softail models (except FXCW, FXCWC, FXSB, and FXSBSE)
- Unique four-piece skull accent set to dress up the recessed area in the rear swing arm frame
- Easy to install with pressure sensitive adhesive mounting
- Beautifully chrome plated plastic injection molded
- Add a little attitude to your ride

**52010** 1 Set / Card



**Replacement Air Filter Element**

- Replacement air filter element for United Pacific item number 46154 & 46156 compressors

**46157** 2 Pcs. / Bag

**Recommended Item**



# NEW ITEMS

**Parts & Accessories for Ford & Chevy Trucks**  
**Sequential Tail Light**



**DOT & SAE**

**40 LED Sequential Tail Light Assembly With Red Lens For 1960-66 Chevy & GMC Fleetside Truck**

- Super bright red LED with fully sealed epoxy coated electronics
- Features sequential function with selector switch to control sequential function off, direction left, or direction right
- Features sequence-once brake attention function
- Complete with zinc plated housing, lens, gasket, socket & wiring
- OE style wiring with bullet terminal connectors
- Requires use of United Pacific LED turn signal flasher, item number: 90652 or 90649
- SAE/DOT FMVSS108

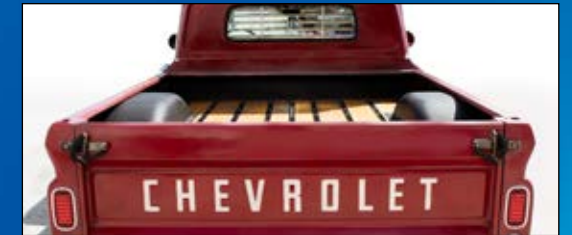

**110795**

1 Pc. / Card



**DOT & SAE**

**38 LED Sequential Tail Light With Housing For 1953-56 Ford Truck**

- Super bright SMD LED with high quality red polycarbonate lens
- L/H side includes additional white LED light with clear lens for license plate light
- Features sequential function with selector switch to control sequential function off, direction left, or direction right
- Features sequence-once brake attention function
- Fully assembled with chrome or gloss black die stamped metal housing, and mounting studs
- Recommended under dash flasher United Pacific 90652(2-terminal) or 90651 (3-terminal)



<b>110761</b>	Chrome (NEW)	L/H - 1 Pc. / Card
<b>110762</b>	Chrome (NEW)	R/H - 1 Pc. / Card
<b>110763</b>	Black	L/H - 1 Pc. / Card
<b>110764</b>	Black	R/H - 1 Pc. / Card



### LED Sequential Tail Light With Black Housing For 1940-53 Chevy & GMC Truck

- Super bright red LED with quality polycarbonate lens
- L/H side includes additional white LED light with clear lens for license plate light
- Features sequential operation with selector switch to select sequential left, sequential right, or sequential function off
- Features sequence-once brake attention function
- Fully assembled with gloss black powder coated housing with polished stainless steel bezel
- Electronics completely sealed in epoxy to resist corrosion and moisture
- Solid state circuit board engineered for any 12VDC system
- Recommended under dash flasher United Pacific 90652 (2-terminal) or 90651 (3-terminal)



<b>110415</b>	L/H - 1 Pc. / Box
<b>110416</b>	R/H - 1 Pc. / Box



### 22 LED Tail Light With LED Blue Dot and Black Housing For 1940-53 Chevy & GMC Truck

- Super bright red LED with quality polycarbonate lens
- Additional white LED with clear lens for license plate light
- Center mounted blue dot can be controlled independently with additional wiring
- Full assembled with gloss black die stamped metal housing with mounting studs and highly polished stainless steel bezel
- Electronics completely sealed in epoxy to resist corrosion and moisture
- Solid state circuit board engineered for any 12VDC system
- Recommended under dash flasher United Pacific 90652 (2-terminal) or 90651 (3-terminal)

<b>C7031RLBD</b>	L/H - 1 Pc. / Box
<b>C7031RRBD</b>	R/H - 1 Pc. / Box



### Tail Light With Black Housing For 1940-53 Chevy & GMC Truck

- Beautiful red original style glass lens
- Fully assembled with gloss black powder coated housing with highly polished stainless steel bezel
- Includes additional light with clear lens for license plate light
- Ready to install, 12 volt incandescent bulbs, wiring pigtailed, gaskets

<b>C7001L</b>	L/H - 1 Pc. / Box
<b>C7001R</b>	R/H - 1 Pc. / Box



DOT & SAE

### 38 LED Tail Light With Housing For 1953-56 Ford Truck

- Super bright SMD LED with high quality red polycarbonate lens
- L/H side includes additional white LED light with clear lens for license plate light
- Fully assembled with chrome or gloss black die stamped metal housing, and mounting studs
- Electronics completely sealed in epoxy to resist corrosion and moisture
- Solid state circuit board engineered for any 12VDC system
- Recommended under dash flasher United Pacific 90652 (2-terminal) or 90651 (3-terminal)

<b>110759</b>	Black	L/H - 1 Pc. / Card
<b>110760</b>	Black	R/H - 1 Pc. / Card



### 45 LED Tail Light With Black Housing For 1940-53 Chevy & GMC Truck

- Super bright SMD LED with high quality red polycarbonate lens
- L/H side includes additional white LED light with clear lens for license plate light
- Fully assembled with gloss black powder coated housing with polished stainless steel bezel
- Electronics completely sealed in epoxy to resist corrosion and moisture
- Solid state circuit board engineered for any 12VDC system
- Recommended under dash flasher United Pacific 90652 (2-terminal) or 90651 (3-terminal)

<b>C7031RL</b>	L/H - 1 Pc. / Box
<b>C7031RR</b>	R/H - 1 Pc. / Box



### Tail Light With Black Housing And Blue Dot For 1940-53 Chevy & GMC Truck

- Excellent quality red glass lens with beautiful center mounted blue dot
- Fully assembled with gloss black powder coated housing with highly polished stainless steel bezel
- Includes additional light with clear lens for license plate light
- Ready to install, 12 volt incandescent bulbs, wiring pigtailed, gaskets

<b>C7001L-1</b>	L/H - 1 Pc. / Box
<b>C7001R-1</b>	R/H - 1 Pc. / Box



### Chrome Outside Door Handle Set for 1966-77 Ford Bronco & 1965-70 Mustang

- Beautiful chrome plated finish with triple chrome plating process
- Excellent reproduction with original contour and size
- Original style inner linkage design for straight forward replacement
- Complete set includes pair of handles, mounting pads and hardware included

<b>110824</b>	1 Pair / Box
---------------	--------------



### Inner Header Support For 1932-34 Ford Truck

- Die stamped with high quality 16 gauge steel reproduction
- Features all of original contour detail with mounting holes for windshield frame and wiper vacuum line pass-through
- Inner channel reinforcements included for additional structural rigidity, just like Ford had it
- Finished with United Pacific Classic-Coat® weldable primer

**B21071** 1 Pc. / Box



### A-Pillar Assembly for 1932-34 Ford Truck

- High quality stamped steel with heavy 13 gauge inner structural reinforcements
- Features all of the original contour detail and spot welder pass-thru holes
- Lower triangular inner reinforcement features large ribbing and square carriage bolt holes
- Includes mounting flange with D-nuts for inner dash support
- Slide arm pivot bracket pre-installed with round head solid rivets
- Upper roof mounting flange with reinforcement plate
- Includes upper A-pillar to roof mounting reinforcement plate kit

**B21125-A** L/H - 1 Pc. / Box

**B21126-A** R/H - 1 Pc. / Box



### Stainless Steel Gas Cap for 1930-31 Ford Model A

- Highly polished quality stainless steel
- Exact shape and size as the original
- Knurled on the edge as original for easy grip while turning

**A8045** 1 Pc. / Box



### Chrome Bronco Key Chain/Bottle Opener

- Beautiful highly detailed life-like bucking bronco
- Quality chrome plated die cast with triple chrome plating process
- Heavy duty, quality you can feel
- Features a special designed cut out at the rear to work as a bottle opener
- Round split keychain ring included

**99102** 1 Pc. / Card

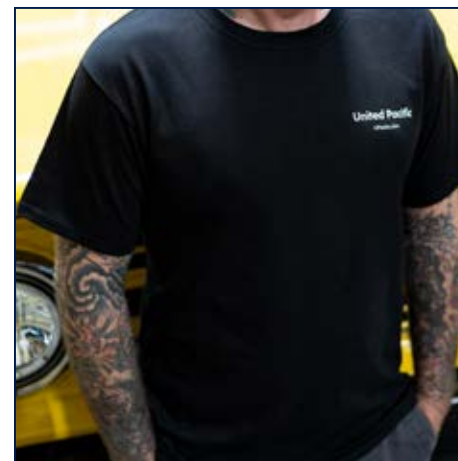

### United Pacific x Maxlider T-shirt with Ford Bronco

- Black T-Shirt

**99129M** Medium - 1 Pc. / Bulk

**99129L** Large - 1 Pc. / Bulk

**99129XL** X-Large - 1 Pc. / Bulk

**99129XXL** XX-Large - 1 Pc. / Bulk



### 4' x 3' United Pacific Banner

- United Pacific banner

**99053** 1 Pc. / Bulk

# NEW ITEMS

July 2019



Bedside exterior



Bedside interior

## Shortbed Bedside Panel For 1968-72 Chevy & GMC Fleetside Truck

- Reproduced exactly like the original with high quality 20-gauge steel, stamped with all the original contour and detail
- Complete bedside, Includes installed and spot welded 17 gauge inner liner
- Features 3/8-16 and 5/16-18 threads welded in between exterior steel panel and inner reinforcement
- Black EDP Coated
- Includes rubber tailgate bumpers
- Has side marker cutout for 1968-72, but can be used on 1967 if side marker is desired
- Packed in heavy-duty cardboard box

**110829** L/H - 1 Pc. / Box

**110830** R/H - 1 Pc. / Box

## UNITED PACIFIC BEDSIDES

United Pacific is the source for quality body panels for long bed to short bed conversions. By reverse engineering each panel with exact specifications and modern technology, we are able to create a complete replica of short bed C10 bedside panels. Our high quality 20-gauge steel panels are manufactured with pre-drilled mounting holes, and feature our exclusive welded threaded nut inserts for wheel well, tailgate pivot trunnion, tailgate support and striker.

United Pacific's goal is to ensure that our parts have the best possible fit and make sure installation is a breeze. We are here to help the C10 community restore and rebuild the truck of their dreams.



## For Ford Bronco



## Black Grille Without Logo For 1966-68 Ford Bronco

- Die Stamped with high quality 16 gauge sheet metal
- Features all the original contour and detail and mounting brackets for the early small round signal lights
- Smooth center bar design without FORD letters to keep that clean front end look
- Finish with black EDP protective coating to keep your new steel fresh and rust-free
- Headlight adjusters also included for easy headlight installation and adjustment

**110513** 1 Pc. / Box

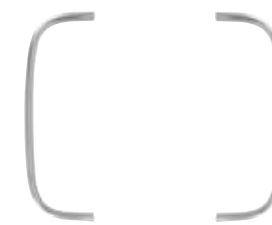

## Polished Aluminum Grille Trim Molding Kit For 1966-77 Ford Bronco

- Beautiful polished high quality aluminum extrusion with clear anodizing
- Overlapped connecting ends just like original
- Original type mounting hardware included

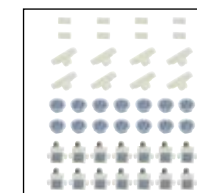

**110594** 1 Set / Box



## Front Fender Support Bracket, Front For 1966-77 Ford Bronco

- Heavy duty steel rod with flattened ends
- Same exact length as original for easy installation
- 5/16-18 threaded mounting holes
- Zinc plated

**110592** L/H - 1 Pc. / Bag

**110593** R/H - 1 Pc. / Bag



## Quarter Panel Support Brackets For 1966-77 Ford Bronco

- Heavy duty steel rod with flattened ends
- Same exact length as original for easy installation
- 1/4-20 threaded mounting holes
- Zinc plated

**110591** 1 Pc. / Bag



**Glove Box Door Hinge For 1964-66 Chevy & GMC Truck**

- Excellent quality steel stamping
- Exact design as original with mounting holes for easy installation
- Finish with black EDP protective coating

**110094** 1 Pc. / Box

**Universal Products**



**Chrome Wiper Shaft Cap For 0.55" Dia Shafts**

- Metal die cast zinc with quality chrome plating
- Dress up the wiper shaft when wiper arms are not in use
- Easy installation and removal with included set screw & allen wrench
- Sold in pairs

**110823** 1 Pair / Card



**Chrome Wiper Shaft Bullets**

- Beautiful chrome plated with triple chrome plating process
- Securely mounts onto wiper shaft via included set screws
- Matching hex key also included
- Please double check wiper shaft diameter before purchase

**C4041** 0.55 Dia. - 1 Pair / Card

**C4041L** 5/8" Dia. - 1 Pair / Card



# NEW ITEMS

**Parts & Accessories for Ford & Chevy Trucks**



**UNITED PACIFIC BODY PANELS**

United Pacific is the source for quality body panels for long bed to short bed conversions. By reverse engineering each panel with exact specifications and modern technology, we are able to create a complete replica of short bed C10 bedside, bed floor pan and tailgate panels. Our high-quality heavy steel panels are manufactured with mounting holes and feature our exclusive welded nut inserts for wheel well, tailgate pivot trunnion, tailgate support and striker.

United Pacific's goal is to ensure that our parts have the best possible fit and make sure installation is a breeze. We are here to help the C10 community restore and rebuild the truck of their dreams.



**6-1/2' Bed Floor Pan For 1967-72 Chevy & GMC Truck Fleetside Shortbed**

- Excellent stamped sheet metal reproduction with all of the original contour detail
- Quality 18 gauge floor panel with spot welded heavy 14 gauge crossmembers
- Features precision punched mounting holes for easy bed front, bed side, and wheel well installation
- Finished with black EDP protective coating

**110839** 1 Pc. / Box



**Tailgate With GMC Script For 1967-72 GMC Fleetside Truck**

- Die stamped quality 17 gauge steel with recessed GMC lettering
- Precision cut latch handle pocket with mounting holes
- Two welded 5/16-18 nuts on each side for latch mounting
- Includes tailgate linkage posts and tailgate trunnion pockets
- Finish with black EDP protective coating to keep your new steel fresh and rust-free

**110847** 1 Pc. / Box





### Glove Box Door For 1964-66 Chevy Truck

- Excellent stamped 20 gauge steel reproduction with all of the original contour detail
- Features precision cut lock cylinder pocket, rectangular front recess for OE Chevrolet emblem, and three OE style cup holder recesses on inner panel
- Includes welded 1/4-20 square nuts
- Finished with black EDP protective coating

**110092** 1 Pc. / Box

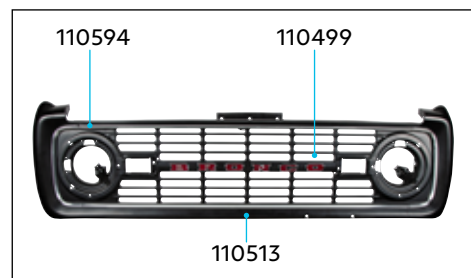

### Chrome "BRONCO" Grille Letter Set

- High quality die cast & chrome plated with gloss red inlay
- 12 speed nuts included
- Excellent upgrade for all 1966-77 Ford Broncos
- Drill template included for easy installation
- Unique design made for aftermarket smooth style grilles without FORD lettering
- Official licensed product by Ford Motor Company

**110499** 1 Set / Card

### For Ford 32 Car & Truck

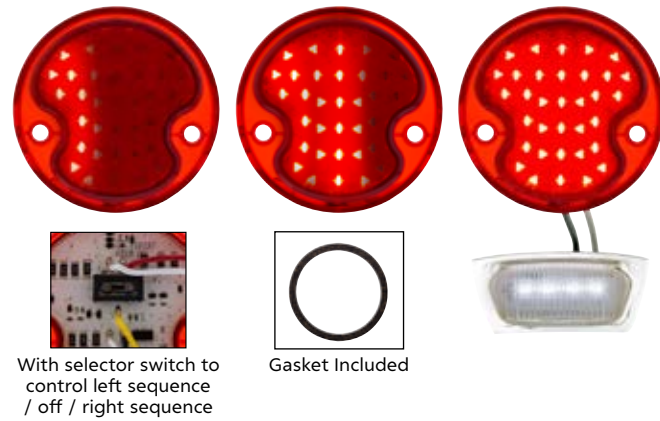

### LED Sequential Tail Light For 1932 Ford Car & Truck

- Super bright LED, complete with polycarbonate lens
- L/H Includes bright LED license plate illuminator lens on bottom
- Feature sequential function with selector switch to control sequential function off/on
- Also features brake attention option with sequence-once function
- Epoxy coated, fully sealed electronics
- Energy efficient solid-state circuit board engineered for 12VDC systems
- Recommend to upgrade under dash flasher to item no. 90652 or 90649 LED flasher

**110196** L/H - 1 Pc. / Card

**110197** R/H - 1 Pc. / Card

### For Volkswagen



### 15 3/4" Steering Wheel for 1962-71 Volkswagen Beetle, Karmann Ghia and Type 3

- OEM style 15-3/4" steering wheel
- Includes chrome horn ring, horn button with Wolfsburg crest, horn contact ring, mounting hardware kit and instructions

**110716** Black - 1 Pc. / Color Box

**110717** Gray Beige - 1 Pc. / Color Box



### P-40 "Warhawk" Shark Mouth 17" Tire Checking Bat

- Aluminum tire checker in military green with WWII P40 style shark mouth decal
- 17" long with comfortable anti-slip grip

**99136** 1 Pc. / Box



### High Power 8 LED 1156 Bulb

- 8 High Power SMD LED's
- Replaces most #1156 and #89 applications
- 12 Volt, single contact with straight-across pins

**38897** White / 250 lm - 2 Pcs. / Color Box

**38898** Red / 150 lm - 2 Pcs. / Color Box

**38899** Amber / 150 lm - 2 Pcs. / Color Box



Plug & Play



# NEW ITEMS

September 2019

## Parts & Accessories for Chevy Trucks and Camaro Backup Light



### Tailgate With CHEVROLET Script For 1967-72 Chevy Fleetside Truck

- Die stamped quality 16 gauge steel with recessed CHEVROLET lettering
- Precision cut latch handle pocket with mounting holes
- Two welded 5/16-18 nuts on each side for latch mounting
- Includes tailgate linkage posts and tailgate trunion pockets
- Finish with black EDP protective coating to keep your new steel fresh and rust-free
- Official GM licensed restoration product

**110846** 1 Pc. / Box



### Tailgate Without Script For 1967-72 Chevy & GMC Fleetside Truck

- Die stamped quality 16 gauge steel
- Precision cut latch handle pocket with mounting holes
- Two welded 5/16-18 nuts on each side for latch mounting
- Includes tailgate linkage posts and tailgate trunion pockets
- Finish with black EDP protective coating to keep your new steel fresh and rust-free

**110845** 1 Pc. / Box

### Lower Door Hinge For 1967-72 Chevy & GMC Truck

- High quality door hinge assembly with bronze bushing and high strength hinge pin
- Made to OE specifications for adjustability and door alignment
- Also fits 67-72 Suburban, 69-72 Chevy Blazer & GMC Jimmy

**110835** L/H - 1 Pc. / Box

**110836** R/H - 1 Pc. / Box



**110836**



**110835**

### Chrome Front Bumper Without Impact Strip Holes For 1973-80 Chevy & GMC Truck

- Heavy 14 gauge stamped steel with quality chrome plating
- Smooth clean style without the mounting holes for bumper impact strip
- Precision punched square carriage bolt holes for straight forward installation
- Features recessed license plate pocket with mounting holes



**110849** 1 Pc. / Box

### Chrome Rear Bumper Without Impact Strip Holes For 1973-80 Chevy & GMC Truck

- Heavy 14 gauge stamped steel with quality chrome plating
- Smooth clean style without the mounting holes for bumper impact strip
- Precision punched square carriage bolt holes for straight forward installation
- Features license plate clearance pocket



**110850** 1 Pc. / Box

### Chrome Front Bumper With Impact Strip Holes For 1983-87 Chevy & GMC Truck

- Heavy 14 gauge stamped steel with quality chrome plating finish
- Original style with impact strip mounting holes
- Precision punched square carriage bolt holes for straight forward installation
- Features recessed license plate pocket with mounting holes



**110852** 1 Pc. / Box

### Chrome Rear Bumper Without Impact Strip Holes For 1981-87 Chevy Truck

- Heavy 14 gauge stamped steel with quality chrome plating finish
- Smooth clean style without the mounting holes for bumper impact strip
- Precision punched square carriage bolt holes for straight forward installation
- Features license plate clearance pocket



**110853** 1 Pc. / Box

### 18 High Power 4"X 6" LED Rectangular Light With Position Light - Black

- LED dual function rectangular light with 10 white LED position lights
- Ultra slim housing design for easier installation
- High beam: 3500 Lumens/6500K; Low beam: 1500 lumens/6500K; Position light: 100 lumens
- Rugged anti-vibration construction. 12VDC - 24VDC
- Easy connection, fits OEM housing or fender, plugs into existing wiring harness, position light requires additional wiring
- Off-Road use only

**36449** 1 Pc. / Color Box



**100%LED**

**IP67**  
WATER RESISTANT



### 22 High Power 5"X 7" LED Rectangular Light With Position Light - Black

- LED dual function rectangular light with 12 white LED position lights
- Ultra slim housing design for easier installation
- High beam: 4000 lumens; Low beam: 2000 lumens; Position light: 100 lumens
- Rugged anti-vibration construction. 12VDC - 24VDC
- Easy connection, fits OEM housing or fender, plugs into existing wiring harness, position light requires additional wiring
- Off-Road use only

**36450** 1 Pc. / Color Box



**100%LED**

**IP67**  
WATER RESISTANT





### 30 LED Tail Light For 1970-73 Chevy Camaro

- Super bright red LED with high quality injection molded polycarbonate lens
- Includes original style polished stainless steel lens trim attached
- Includes polished stainless steel lens trim attached
- Dual function with tail light & bright stop/turn signal
- Epoxy coated, fully sealed electronics
- Easy wiring with hard wired 1157 double contact plug
- Direct plug-n-play with no vehicle modification required
- Recommend to upgrade under dash flasher to item # 90652 or 90649 LED flasher
- SEMA Global Media Award winner

<b>CTL7073LED-L</b>	<b>L/H</b> - 1 Pc. / Card
<b>CTL7073LED-R</b>	<b>R/H</b> - 1 Pc. / Card

### 30 LED Backup Light For 1970-73 Chevy Camaro

- Super bright white LED center backup light with 18 additional dual function red LED light
- Features polished stainless steel lens trim with quality polycarbonate lens
- Additional red LED are design for tail/stop/turn signal light use (quick splice connectors included)
- Fully sealed electronic solid state circuit boards are designed to operate at 12 VDC
- Easy electrical connection, direct plug-n-play to original wiring harness with hardwired 1156 plug
- Red LED wiring color code: White wire-ground, yellow wire-tail, red wire-stop/turn

<b>110375</b>	<b>L/H</b> - 1 Pc. / Card <b>(NEW)</b>
<b>110376</b>	<b>R/H</b> - 1 Pc. / Card <b>(NEW)</b>

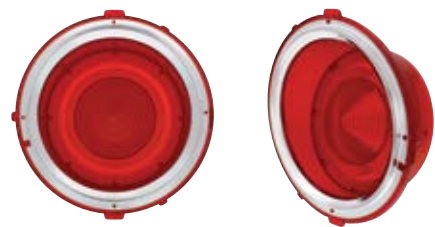

### Tail Light Lens Only For 1970-73 Chevy Camaro

- High quality injection molded polycarbonate lens
- Quality stainless steel outer bezel

<b>110099</b>	<b>L/H</b> - 1 Pc. / Card
<b>110100</b>	<b>R/H</b> - 1 Pc. / Card

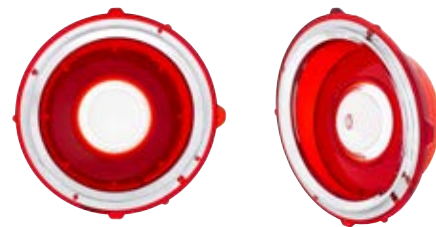

### Backup Light Lens Only For 1970-73 Chevy Camaro

- High quality injection molded polycarbonate lens
- Quality stainless steel outer bezel

<b>110377</b>	<b>L/H</b> - 1 Pc. / Card <b>(NEW)</b>
<b>110378</b>	<b>R/H</b> - 1 Pc. / Card <b>(NEW)</b>

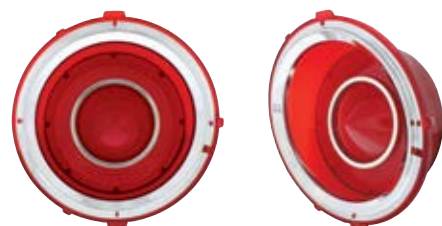

### Tail Light Lens For 1970-73 Chevy Camaro Rally Sport

- High quality injection molded polycarbonate lens
- Quality stainless steel inner and outer bezel

<b>110101</b>	<b>L/H</b> - 1 Pc. / Card
<b>110102</b>	<b>R/H</b> - 1 Pc. / Card

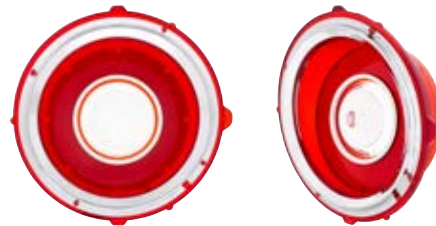

### Backup Light Lens For 1970-73 Camaro Rally Sport

- High quality injection molded polycarbonate lens
- Quality stainless steel inner and outer bezel

<b>110379</b>	<b>L/H</b> - 1 Pc. / Card <b>(NEW)</b>
<b>110380</b>	<b>R/H</b> - 1 Pc. / Card <b>(NEW)</b>



### LED Sequential Tail Light W/ Stainless Steel Housing For 1932 Ford Car & Truck

- Highly polished stainless steel housing & rim
- Pre-assembled with quality polycarbonate red LED lens
- L/H includes bright LED license plate illuminator lens on bottom
- Feature sequential function with selector switch to control sequential function off/on
- Also features brake attention option with sequence-once function
- Epoxy coated, energy efficient solid-state circuit board engineered for 12VDC systems
- Vintage style cloth braided green and black nylon coated wires for an authentic look
- Recommend to upgrade under dash flasher to item no. 90652 or 90649 LED flasher

<b>110872</b>	<b>R/H</b> - 1 Pc. / Card
<b>110873</b>	<b>L/H</b> - 1 Pc. / Card



### Front Fender Lower Brace With J-Nuts For 1966-77 Ford Bronco

- High quality die stamped 18 gauge sheet metal
- Features strengthening center rib just like original
- Includes 5/16-18 J-nuts for easy installation to fender and fender apron
- Zinc plated finish for better corrosion resistance

<b>110596</b>	1 Pc. / Bulk
---------------	--------------



### Slide Arm Pivot Bracket For 1932-34 Ford Truck

- Excellent quality steel reproduction with all of original contour detail
- Machine cut OE specification 5/16"-18 threads
- Precision punched rivet holes for straight forward installation to A-pillar
- Zinc plated finish for better corrosion resistance

<b>B21125-1</b>	1 Pc. / Bulk
-----------------	--------------



### Complete Tinted Door Glass Assembly For 1967-68 Mustang Convertible

- Heavy 16 gauge stamped channel with riveted track rollers
- Polished stainless steel upper glass frame
- Original style green tinted tempered window glass
- Fully assembled from factory for a quick and easy replacement

<b>110626</b>	<b>R/H</b> - 1 Pc. / Box
<b>110627</b>	<b>L/H</b> - 1 Pc. / Box



### Window Regulator For 1967-72 Ford Truck

- Excellent quality high strength steel stamping
- Original style counter balance spring design
- Features 1/4-20 square nuts for easy installation to door shell
- Includes window crank mounting screw
- Fits 1967 models, but require 68-72 window handle and escutcheon

<b>110810</b>	<b>L/H</b> - 1 Pc. / Bulk
<b>110811</b>	<b>R/H</b> - 1 Pc. / Bulk



### Spider Wheel Hub Cover (4/Set)

- Made of die-cast steel, not plastic
- Show quality chrome plating
- Comes Complete With Mounting Hardware
- These fit on most wheels to give your vehicles the cool look
- Set of four

<b>C8056</b>	<b>5 x 4 3/4"</b> - 1 Set / Box
<b>C8061</b>	<b>5 x 5"</b> - 1 Set / Box
<b>C8062</b>	<b>5 x 5 1/2"</b> - 1 Set / Box

**Back In Stock**

# NEW ITEMS

October 2019



## LED Sequential Tail Light With Trim For 1973-87 Chevy & GMC Truck

- 56 Super bright red LED tail light with 12 LED white back-up light
- Features sequential operation with brake attention feature, and selector switch to turn off if desired
- Special tail light mounting base plate included
- Electronics completely sealed in epoxy to resist corrosion and moisture
- Requires use of United Pacific LED turn signal flasher, item number 90652 or 90649



**110843** L/H - 1 Pc. / Card  
**110844** R/H - 1 Pc. / Card

Back In Stock



## Cab Mounting Kit For 1967-72 Chevy & GMC 1/2 Ton Truck

- Quality molded rubber cab mounts
- Includes all mounting bolts, lock nuts, spacers and large washers
- 38 piece kit

**C677204** 1 Set / Bulk

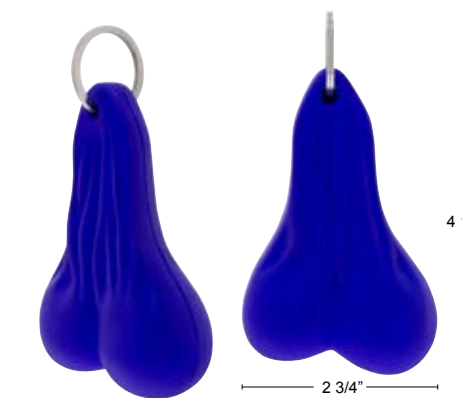

## 4-1/4" Stress Ballz Novelty Keychain - Blue

- Stress relieving novelty keychain made of squishy foam
- Great for relieving stress and anxiety on the go
- 1-1/4" stainless split key ring included

**78027** 1 Pc. / Card



## Tailgate Chain Cover For 1932 Ford Truck

- Engineered leather - long lasting look & feel of leather
- Easy Installation with high strength leather
- WARNING: Sharp objects may damage and cause tears
- CLEANING: Use vinyl interior cleaner

**B21521** 1 Pc. / Bulk



## Vintage Flashlight Holder With Roller-Action Grip, Grey

- Tightly holds flashlight within easy reach
- Secure roller-action grip
- Fits steering columns up to 1-7/8" diameter

**C5012G** Holder Only - 1 Pc. / Color Box  
**110587** Flashlight with Holder - 1 Set / Box  
**C5013** Flashlight Only - 1 Pc. / Box



## United Pacific Bar Stool

- United Pacific Bar Stool

**99041** 1 Pc. / Bulk



## United Pacific Store Slatwall Display

- Perfect way to display United Pacific products
- Size: 31.5" Wide x 14" Deep x 69" Tall
- Recommended display hooks: item# 99002 and 99002-1

**99142** 1 Pc. / Box

# NEW ITEMS

November 2019



## 31 LED Red Sequential Tail Light W/LED License Plate Light For 1928-31 Ford Car

- Super bright LED behind high quality red acrylic lens with fully sealed epoxy coated electronics
- Leftahnd includes bright white LED license plate illuminator lens
- Plug & play for 12 volt negative ground systems. Simply plugs into original tail light with two 1156 plugs
- Selector switch to control sequential function off, direction left, or direction right
- Also features a brake attention feature with a sequence - once function
- Recommended under dash 12V flasher United Pacific 90649 (2-terminal) or 90651 (3-terminal)
- DOT & SAE FMVSS108. Not for use with early 1928 "AR" drum tail lights



((( BRAKE ATTENTION )))

((( SEQUENTIAL F.L.A.S.H )))

<b>110194</b>	<b>L/H</b> - 1 Pc. / Card
<b>110195</b>	<b>R/H</b> - 1 Pc. / Card



((( BRAKE ATTENTION )))

((( SEQUENTIAL F.L.A.S.H )))

## 28 LED Sequential Tail Light For 1957 Chevy Passenger Car

- Super bright red LED with fully sealed epoxy coated electronics
- Selector switch to control sequential function off, direction left, or direction right
- Also features a brake attention feature with a sequence - once function
- 1157 double connector with offset pins, plugs into existing tail lamp socket
- Requires use of United Pacific LED turn signal flasher, item number: 90652 or 90649
- DOT & SAE Compliant

<b>110198</b>	1 Pcs. / Card
---------------	---------------



## Dual Color High Power 12V H11 LED Bulbs - White/Yellow (2 Pack)

- Special engineered 240 degree wide angle dual color LED design
- Primary 6500K white color temp. LED with 1400 lumen output
- Secondary 3000K bright yellow color temp. LED with 1150 lumen output
- Direct plug-n-play to H11 housing and socket
- White LED comes on by default. To switch over, simply turn off and on within 10 seconds
- Yellow LED is designated for fog light use only, not to be use as normal driving light

<b>36468</b>	1 Pc. / Color Box
--------------	-------------------



**110835**

**110834**

## Upper Door Hinge For 1967-72 Chevy & GMC Truck

- High quality door hinge assembly with bronze bushing and high strength hinge pin
- Made to OE specifications for adjustability and door alignment
- Upper includes door stop and tension brake to hold door in open position
- Also fits 67-72 Suburban, 69-72 Chevy Blazer & GMC Jimmy

<b>110833</b>	<b>Upper Door Hinge L/H</b> - 1 Pc. / Box
<b>110834</b>	<b>Upper Door Hinge R/H</b> - 1 Pc. / Box
<b>110835</b>	<b>Lower Door Hinge L/H</b> - 1 Pc. / Box
<b>110836</b>	<b>Lower Door Hinge R/H</b> - 1 Pc. / Box



## 4-1/4" Stress Ballz Novelty Keychain

- Stress relieving novelty keychain made of squishy foam
- Great for relieving stress and anxiety on the go
- 1-1/4" stainless split key ring included

<b>78028</b>	<b>Black</b> - 1 Pc. / Card <b>(NEW)</b>
<b>78029</b>	<b>Red</b> - 1 Pc. / Card <b>(NEW)</b>
<b>78027</b>	<b>Blue</b> - 1 Pc. / Card



## Red Bowtie Grille Emblem For 1967-68 Chevrolet Truck

- Excellent die-cast reproduction of the original
- Beautiful original style orange-red inner with vertical groove design
- Quality chrome plated outer housing with black front outline
- Mounting hardware included

<b>110859</b>	1 Pc. / Box
---------------	-------------



## Product Catalog for 1947-87 Chevy & GMC Trucks

- Perfect bound, 124 Page catalog

<b>ACPU01</b>	1 Pc. / Bulk
---------------	--------------



## Spider Wheel Hub Cover (4/Set)

- Made of die-cast metal, not plastic
- Show quality chrome plating
- Comes complete with mounting hardware
- These fit on most wheels to give your vehicles the cool look
- Set of four



**Back In Stock**

<b>C8056</b>	<b>5 x 4 3/4"</b> - 1 Set / Box
<b>C8057</b>	<b>5 x 4 1/2"</b> - 1 Set / Box
<b>C8061</b>	<b>5 x 5"</b> - 1 Set / Box
<b>C8062</b>	<b>5 x 5 1/2"</b> - 1 Set / Box



## SEMA 2019 C10 T-Shirt

- Dark navy t-shirt

<b>99179M</b>	<b>Medium</b> - 1 Pc. / Bulk
<b>99179L</b>	<b>Large</b> - 1 Pc. / Bulk
<b>99179XL</b>	<b>XLarge</b> - 1 Pc. / Bulk
<b>99179XXL</b>	<b>XXLarge</b> - 1 Pc. / Bulk

# NEW ITEMS

December 2019



## Rectangular Exterior Mirror For 1968-72 Chevy Passenger Car

- Exceptional quality die cast metal and beautifully chrome plated
- Available with LED turn signal arrow hidden inside mirror glass (hidden when off)
- Convex Mirror for Wide Angle Visibility for R/H side
- Includes mounting pad and mounting screws

<b>110294</b>	<b>L/H - 1 Pc. / Color Box</b>
<b>110295</b>	<b>R/H w/Convex Mirror - 1 Pc. / Color Box</b>
<b>110296</b>	<b>L/H w/LED Turn Signal - 1 Pc. / Color Box</b>
<b>110297</b>	<b>R/H w/Convex Mirror &amp; LED Turn Signal - 1 Pc. / Color Box</b>

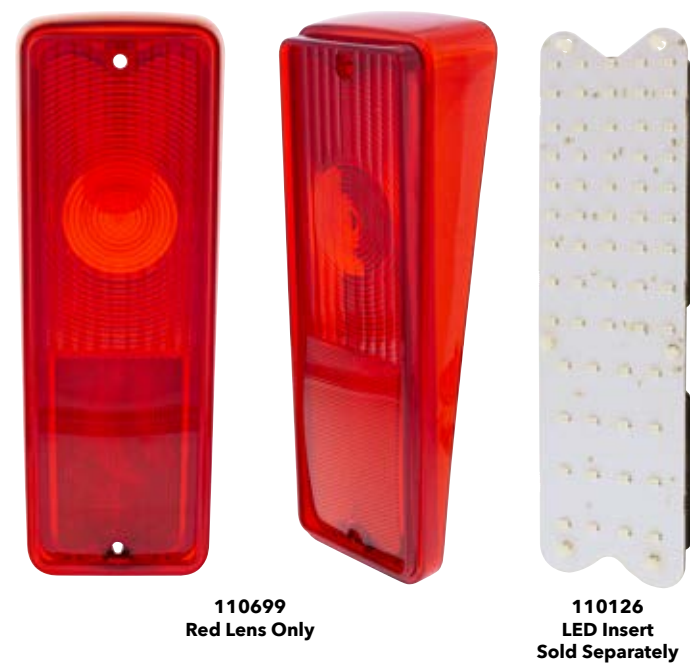

## Tail Light Lens For 1967-72 Chevy & GMC Panel Truck & Suburban

- Great looking replacement lens made specifically for Suburban
- Injection molded from high quality red polycarbonate plastic
- Fits both left and right hand side

**110699** 1 Pc. / Card

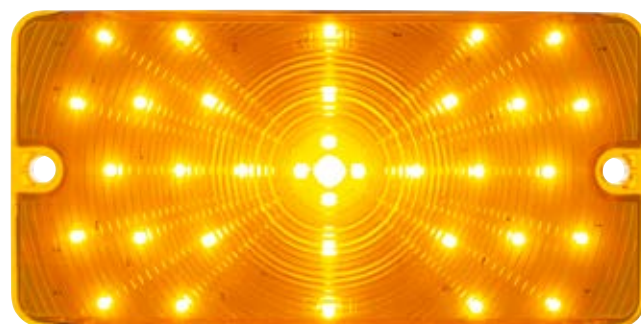

## LED Parking/Signal Light For 1969-77 Ford Bronco

- 35 LED Dual function, parking light and turn signal
- Super bright amber LED with amber acrylic lens
- Epoxy coated, fully sealed electronics, 1157 plug
- Fits left hand and right hand
- Also fits 1959-64 Ford F100, F250, F350, and 1968-74 Econoline

<b>110382</b>	<b>Parking Light - 1 Pc. / Card</b>
<b>110803</b>	<b>Gasket - 1 Pc. / Bulk</b>



## Front Inner Fender For 1967-72 Chevrolet & GMC Truck

- Also fits 1967-72 Chevy & GMC Suburban, and 1969-72 Chevy Blazer/ GMC Jimmy
- Finished with black EDP protective coating to keep your new steel fresh and rust-free

<b>110865</b>	<b>L/H - 1 Pc. / Bulk</b>
<b>110866</b>	<b>R/H - 1 Pc. / Bulk</b>



**110855**

**110854**

## Upper Door Hinge For 1973-87 Chevrolet Truck

- Die stamped with heavy duty steel with original contour detail
- Precision punched mounting holes for easy installation
- Features original style hinge spring to help keep the door open

<b>110854</b>	<b>L/H - 1 Pc. / Bulk</b>
<b>110855</b>	<b>R/H - 1 Pc. / Bulk</b>



**110857**

**110856**

## Lower Door Hinge For 1973-87 Chevrolet Truck

- Die stamped with heavy duty steel with original contour detail
- Precision punched mounting holes for easy installation

<b>110856</b>	<b>L/H - 1 Pc. / Bulk</b>
<b>110857</b>	<b>R/H - 1 Pc. / Bulk</b>



## Hood Hinge Spring For 1967-72 Chevrolet & GMC Truck

- Specially engineered to have the same yield and tensile strength as original
- Finish with black EDP protective coating
- Sold in pairs

**110879** 1 Pair / Bulk



## Inner Grille Insert For 1971-72 Chevrolet Truck

- Excellent reproduction of the original
- Made of high impact, corrosion resistant ABS plastic
- Silver gray finish just like GM made them

**110869** 1 Pc. / Bulk



### 31 LED Red Sequential Tail Light W/Housing & Rim For 1928-31 Ford Car

- Super bright LED behind high quality red acrylic lens with fully sealed epoxy coated electronics
- Left hand includes 4 additional white LED with clear lens for license plate light
- Selector switch to control sequential function off, direction left, or direction right
- Also features a brake attention feature with a sequence - once function
- Fully assembled with highly polished stainless steel housing and bezel
- Recommended under dash flasher United Pacific 90652 (2-terminal) or 90651 (3-terminal)



((( BRAKE ATTENTION ))) <<< SEQUENTIAL >>>  
F · L · A · S · H

<b>110890</b>	Stainless Housing / Stainless Rim	L/H - 1 Pc. / Box
<b>110891</b>	Stainless Housing / Stainless Rim	R/H - 1 Pc. / Box
<b>110892</b>	Black Housing / Black Rim	L/H - 1 Pc. / Box
<b>110893</b>	Black Housing / Black Rim	R/H - 1 Pc. / Box
<b>110894</b>	Black Housing / Stainless Rim	L/H - 1 Pc. / Box
<b>110895</b>	Black Housing / Stainless Rim	R/H - 1 Pc. / Box



Plug & Play

### High Power 8 LED 1157 Bulb

- 8 High Power SMD LED's, 80 lumens / 250 lumens
- Replaces most #1157 and #P21/5W applications
- 12 Volt, double contact with off-set pins

<b>36443</b>	<b>White</b> - 2 Pcs. / Color Box
<b>36444</b>	<b>Red</b> - 2 Pcs. / Color Box
<b>36445</b>	<b>Amber</b> - 2 Pcs. / Color Box



### United Pacific LED Bulb Display

- Display approximate size: 16-3/4" X 6-1/4"
  - Display includes item # 36543/36550/36920 /36931/36932/ 36934/ 36935/36918/38897/36443
- |              |             |
|--------------|-------------|
| <b>99159</b> | 1 Pc. / Box |
|--------------|-------------|



### Heavy Duty Steering Wheel Spinner

- Fits 1-1/8" to 1-5/16" diameter steering wheel grips
- Heavy duty chrome die cast clamp
- Classic design intended to reduce effort and fatigue
- Includes 2 rubber spacers to accommodate different grip diameters
- Matching color steering wheel bezels, shift knobs, and air valve knobs available
- Not recommended for padded steering wheels

<b>70362</b>	<b>Indigo Blue</b> - 1 Pc. / Card
<b>70363</b>	<b>Emerald Green</b> - 1 Pc. / Card
<b>70364</b>	<b>Cadmium Orange</b> - 1 Pc. / Card
<b>70365</b>	<b>Candy Red</b> - 1 Pc. / Card
<b>70366</b>	<b>Liquid Silver</b> - 1 Pc. / Card
<b>70367</b>	<b>Pearl White</b> - 1 Pc. / Card
<b>70368</b>	<b>Electric Yellow</b> - 1 Pc. / Card



### United Pacific, Long Beach Tee

- Great looking fatigue green color
- 100% preshrunk high-quality cotton
- TAGLESS for ultimate comfort
- Printed in the USA

<b>99180M</b>	<b>Medium</b> - 1 Pc. / Bulk
<b>99180L</b>	<b>Large</b> - 1 Pc. / Bulk
<b>99180XL</b>	<b>XLarge</b> - 1 Pc. / Bulk
<b>99180XXL</b>	<b>XXLarge</b> - 1 Pc. / Bulk



**99187**

**99188**



**99189**

**99190**

### United Pacific 7" LED Headlight Display

- Attractive counter top display with interactive push buttons
- Ready to use, requires 110V outlet

<b>99187</b>	<b>Display for 31459</b> - 1 Pc. / Box
<b>99188</b>	<b>Display for 31496</b> - 1 Pc. / Box
<b>99189</b>	<b>Display for 31513</b> - 1 Pc. / Box
<b>99190</b>	<b>Display for 31084</b> - 1 Pc. / Box

# PRODUCT INDEX

ITEM #	PAGE #	ITEM #	PAGE #	ITEM #	PAGE #	ITEM #	PAGE #	ITEM #	PAGE #
22974	12	99142	36	110760	18, 21	10352B	19	C8056	34, 38
22975	12	99159	41	110761	20	10353B	16	C8057	38
22976	12	99187	42	110762	20	34217B	16	C8061	34, 38
22977	12	99188	42	110763	18, 20	99129L	24	C8062	34, 38
31084	15	99189	42	110764	18, 20	99129M	24	CTL7073LED-L	33
31087	15	99190	42	110786	10	99129XL	24	CTL7073LED-R	33
31088	15	110092	29	110787	10	99129XXL	24		
31089	15	110094	27	110788	10	99179L	38		
33009	14	110099	33	110789	10	99179M	38		
33010	14	110100	33	110792	11	99179XL	38		
36443	41	110101	33	110793	11	99179XXL	38		
36444	41	110102	33	110794	8	99180L	42		
36445	41	110142	10	110795	20	99180M	42		
36449	32	110143	10	110803	39	99180XL	42		
36450	32	110194	37	110807	8	99180XXL	42		
36468	37	110195	37	110808	10	A8045	23		
36624	9	110196	29	110809	10	ACPU01	38		
38897	30	110197	29	110810	34	ANF1217	16		
38898	30	110198	37	110811	34	ANF1218	16		
38899	30	110294	39	110812	11	B20146	6		
46154	12	110295	39	110813	11	B20333	5		
46156	14	110296	39	110823	27	B20334	5		
46157	19	110297	39	110824	22	B21031	5		
52010	19	110359	17	110829	25	B21032	5		
70025	16	110360	17	110830	25	B21033	5		
70362	42	110375	33	110833	38	B21034	5		
70363	42	110376	33	110834	38	B21045	18		
70364	42	110377	33	110835	31, 38	B21052	6		
70365	42	110378	33	110836	31, 38	B21071	23		
70366	42	110379	33	110839	28	B21072	13		
70367	42	110380	33	110843	35	B21112	6		
70368	42	110382	39	110844	35	B21113	6		
70661	16	110415	21	110845	31	B21114	6		
70662	16	110416	21	110846	31	B21115	6		
70663	16	110486	7	110847	28	B21123	6		
70754	16	110499	29	110849	32	B21124	6		
70755	16	110513	26	110850	32	B21125-1	34		
70756	16	110536	7	110852	32	B21125-A	23		
70757	16	110587	35	110853	32	B21126-A	23		
70758	16	110590	7	110854	40	B21521	35		
70759	16	110591	26	110855	40	B24031	5		
70760	16	110592	26	110856	40	B24032	5		
70761	16	110593	26	110857	40	B24033	5		
70762	16	110594	26	110859	38	B24034	5		
70763	16	110596	34	110865	40	C4041	27		
70764	16	110626	34	110866	40	C4041L	27		
78027	36, 38	110627	34	110869	40	C5012G	35		
78028	38	110694	14	110872	34	C5013	35		
78029	38	110699	39	110873	34	C666702	17		
89997	14	110700	13	110879	40	C677204	36		
90649	17	110701	13	110890	41	C7001L	22		
99041	36	110710	11	110891	41	C7001L-1	22		
99053	24	110711	11	110892	41	C7001R	22		
99102	23	110716	30	110893	41	C7001R-1	22		
99121	12	110717	30	110894	41	C7031RL	21		
99122	12	110751	7	110895	41	C7031RLBD	22		
99135	19	110759	18	170473	8	C7031RR	21		
99136	29	110759	21	170474	8	C7031RRBD	22		

