



United Pacific

CLASSIC CAR & TRUCK

2020 New Product Collection



QUALITY

With over 30 years of experience in the automotive aftermarket industry, United Pacific Industries understands the rigors and stresses that our products are subjected to on the road. It is our mission to provide our customers with products of superior quality and reliability. In achieving this goal, United Pacific only partners with manufacturing facilities that conforms to our quality control requirements and standards. Our manufacturing partners meet or exceed ISO-9001 requirements. In addition, United Pacific's manufacturing partners must be equipped on site to perform the following quality assurance tests and maintain a track record of consistent quality and low product failure rate.

- Aging Test
- Air Tight Test
- Dust Test
- Flux Test
- Photometric Test
- Pull Force Test
- Rain Test
- Salt Spray Test
- Shock Test
- Temperature Test
- Humidity Test
- Vibration Test

Furthermore, our internal quality control structure allows us to function as the final quality control station prior to shipping. With the assistance of 3D computer technology, United Pacific can adhere to strict quality control standards during prototype creation and the production process. Our engineers and technicians perform a battery of tests to ensure that our products meet the demands of today's drivers and our goal to be first in quality.

INNOVATION

Known as the leader in innovation, United Pacific is dedicated to be the first to bring new and exciting products to the market. United Pacific's global expertise allows us to search the globe for new ideas and concepts. Not only do we search the globe for new products, United Pacific invest a significant amount of resources into our own research and development efforts. With the assistance of advance 3D scanning technology, our engineers and designers can acquire accurate and precise data in seconds.

The 3D data allows United Pacific to verify designs, perform quality assurance tests, and reverse engineer with unprecedented speed and accuracy. Digital inspection contributes to the early detection of shape problems, provides rapid feedback on design, and eliminates unnecessary work in downstream processes. Our rapid prototyping facility permits us to have a concept-to-shelf time of less than 5 months. In addition, United Pacific's 3D printing capabilities permit our designers to have physical models of their design concepts in hours. The physical models allow our designers and marketing staff to evaluate and test the viability of different design ideas. Our rapid prototyping facility allow United Pacific to compress design cycles, improve manufacturing planning, shorten concept-to-shelf time, most importantly, generate new and innovative products.

DESIGN

Located near some of the nation's most progressive automotive design centers, United Pacific established the UP Design Studio in 2002 to consolidate our position as the design leader in the automotive industry. UP Design Studio utilizes the latest generation of computer aided design (CAD) and studio/graphic software. The design studio is equipped with the newest computers and rapid prototyping systems. In addition, UP Design Studio is staffed by graduates from the nation's most prestigious design colleges. Unlike our competitors, United Pacific's design and manufacturing capabilities mean that we carry more new and original items than our competitors. The establishment of the design studio will enable us to generate even more new products with significant shorter concept-to-shelf time. The reduction in development cost mean that we can develop products utilizing design based development processes. Design based product development allows United Pacific to create new product concepts based on designs incorporating driver demands and needs instead of economic considerations. United Pacific's emphasis on design distinguishes and positions us ahead of our competitors.

HARD AT WORK FOR THE ENVIRONMENT



United Pacific
132,000 sq ft
Distribution Center
Long Beach, CA

100%

reduction in potable water used for landscaping

40%

reduction in total energy use due to high-efficiency mechanical and lighting systems

82%

of construction waste was diverted from landfills

LEED ACCOMPLISHMENTS

Sustainable Sites

- On-site bicycle storage, showers and changing areas for company employees.
- Preferred parking for low-emitting, fuel-efficient and carpool vehicles.
- Storm water is infiltrated on-site and treated to remove contaminants to reduce environmental impact on local waterways.

Water Efficiency

- In addition to using reclaimed water, drought-tolerant plants and a high-efficiency irrigation system were installed to reduce the use of potable water for irrigation by 100%.

Energy and Atmosphere

- Efficient HVAC equipment and a lighting system with daylight controls reduces energy consumption by over 30%.
- Enhanced commission verifies that the building's energy and water-related systems are performing as intended by the initial design.

Indoor Environmental Quality

- Building ventilation systems was designed to provide enhanced levels of fresh outside air to building occupants.
- Interior finishes (plants, sealants, adhesives, coatings, carpet systems and composite wood) were selected with low levels of volatile organic compounds (VOCs) to reduce indoor air contamination.



NEW ITEMS

January 2020



Chrome Exterior Mirror For 1966-77 Ford Bronco & 1967-79 Truck

- Exceptional quality die cast metal and beautifully chrome plated
- Available with special behind-the-mirror LED design, hidden when not in use
- Convex mirror for wide angle visibility for R/H side
- Includes mounting pad and screws

110735 Fits L/H or R/H - 1 Pc. / Color Box

110736 L/H w/LED Turn Signal - 1 Pc. / Color Box

110737 R/H w/Convex Mirror - 1 Pc. / Color Box

110738 R/H w/Convex Mirror &LED Turn Signal - 1 Pc. / Color Box



Chrome Plated Grille Without Lettering For 1969-77 Ford Bronco

- Die stamped with high quality 17 gauge sheet metal
- Features original contour, detail and mounting brackets for the larger turn signal lights
- Smooth center bar design without FORD letters to keep that clean front end look
- Beautiful show ready chrome plated finish
- Headlight adjusters also included for easy headlight installation and adjustment

110516 1 Pc. / Box





Aluminum Grille Shell Without Insert For 1971-72 Chevrolet Truck

- Stamped aluminum with highly polished and anodized finish
- Features all the original contour and headlight mounting holes
- Fits 1971-72 Chevy Truck,, Blazer, and Suburban
- Inner grille insert available separately, UP# 110869

110868 1 Pc. / Box



Hood Hinge & Support For 1947-55 Chevy & GMC Truck 1st Series

- Heavy duty steel reproduction of the original hood hinge style and design
- Fits 1947-55 Chevy & GMC 1st series truck
- Includes hood support arm with clock spring
- Zinc plated finish for better corrosion resistance
- Includes (3) OE style shoulder bolts for proper installation

110249 L/H - 1 Set / Box

110250 R/H - 1 Set / Box



Hood Hinge For 1967-72 Chevrolet & GMC Truck

- Heavy duty steel reproduction of the original hood hinge style and design
- Finish with black EDP protective coating to keep your new steel fresh and rust-free
- Springs available separately, UP#110879

110877 L/H - 1 Pc. / Bulk

110878 R/H - 1 Pc. / Bulk



Cab Mount Kit For 1955-59 Chevy Truck

- Quality molded rubber cab mounts
- Includes all mounting bolts, lock nuts, spacers and large washers
- 22 piece kit
- Includes installation diagram

110842 1 Set / Box

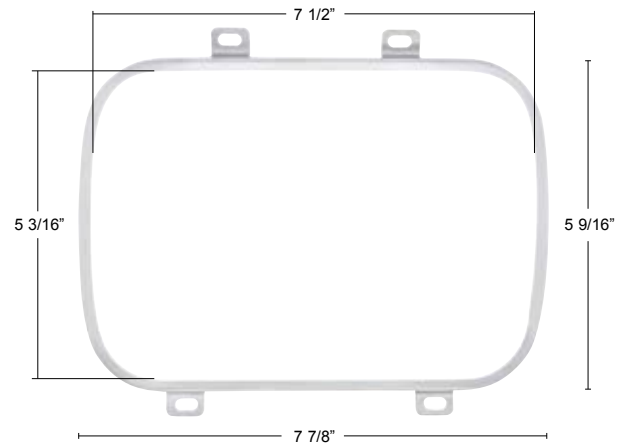

Stainless Steel 5" X 7" Headlight Retaining Ring

- 304 Stainless steel with 4 screw tabs
- Check measurements for your application
- Sold each

30610B 1 Pc. / Bulk



36454



36455



36456



36457

4.5" 24 High Power LED Work Light With "X" Light Guide

- High power SPOT & FLOOD beam combination work light with unique 15 LED "X" light guide design
- Water resistant die cast housing, polycarbonate lens provides maximum protection & durability
- Solid state design resists shock and vibration
- 5200 lumens, IP 67 water resistant
- 12VDC - 24VDC

36454 Amber - 1 Pc. / Color Box

36455 Blue - 1 Pc. / Color Box

36456 Red - 1 Pc. / Color Box

36457 White - 1 Pc. / Color Box

⊗ Light Guide High Power LED Front Spot Light



NEW ITEMS

February 2020



Round Exterior Mirror For 1966-72 Chevy Passenger Car

- Exceptional quality die cast metal and beautifully chrome plated with Chevy bowtie logo
- Available with special behind-the-mirror LED design, hidden when not in use
- Convex mirror for wide angle visibility for R/H side
- Includes mounting pad and screws
- Officially licensed GM restoration part

C687201 Fits L/H or R/H - 1 Pc. / Color Box

110826 R/H w/Convex Mirror &LED Turn Signal - 1 Pc. / Color Box

110827 R/H w/Convex Mirror - 1 Pc. / Color Box

110825 L/H w/LED Turn Signal - 1 Pc. / Color Box



One-Piece Style LED Tail Light For 1955 Chevy Car

- 48 SMD super bright LED with high quality all red polycarbonate lens
- Custom style one-piece design with backup light deleted
- Direct plug & play installation with 1157 type connector
- Electronics completely sealed in epoxy to resist corrosion and moisture
- Solid state circuit board engineered for any 12VDC system

110206 1 Pc. / Card



LED Side Marker For 1970-77 Ford Bronco

- 8 LED Dual function, parking light and turn signal
- Super bright amber LED with amber or red acrylic lens
- Epoxy coated, fully sealed electronics
- Fits left hand and right hand

110804 Front LED Side Marker - Amber - 1 Pc. / Card

110805 Rear LED Side Marker - Red - 1 Pc. / Card



289/302/351W Long Tube Headers For 1966-77 Bronco

- Fits all 1966-77 Broncos with a 289, 302, or 351W V8 engine
- Extra-thick 16 gauge 1 1/2" mandrel-bent tube
- 3/8" thick laser cut flanges resist warping
- Designed to provide ample clearance for tight areas
- Long tube design delivers maximum horsepower and torque

110588 Black - 1 Set / Box

110589 Silver Ceramic Coated - 1 Set / Box



Plain Style Tailgate Without Ford Letters For 1966-77 Ford Bronco

- High quality heavy 16 gauge steel aftermarket reproduction of the original Ford tailgate
- Precision cut latch handle pocket with 1/4"-20 welded nuts and recessed mounting holes on the inside panel
- Includes tailgate linkage posts, tailgate trunnion pockets, and latch pockets with 5/16"-18 threaded holes
- Features license plate light pocket, wiring holes, and small 0.087" diameter mounting holes
- Finished with black EDP protective coating to keep your new steel fresh and rust-free

110884 1 Pc. / Box



Chrome Interior Dome Light Assembly For 1960-72 Chevy/GMC Truck & Suburban

- Chrome plastic housing with lens, 12V light bulb, 143" OE style wiring harness and plug connector

110876 1 Pc. / Box



Rear Inner Wheelhouse For 1967-72 Chevrolet Fleetside Truck

- Excellent 18 gauge steel reproduction of the OE style wheelhouse
- Features all original curvature and mounting pattern
- Finished with black EDP protective coating to keep your new steel fresh and rust-free
- Fits lefthand or righthand side, two required for each truck
- Fits 1967-72 Chevrolet/GMC Fleetside Truck, 67-72 Chevrolet Blazer and 70-72 GMC Jimmy

110867 1 Pc. / Bulk



Sitting Pig Ornament

- Detailed die-casting with beautiful chrome plating
- Easy installation on any vehicle with three mounting studs
- Approximately 5-1/2" x 3-1/2" x 4-1/2"
- Mounting pad and hardware included
- Perfect decorator item for home, office and man cave

72046 Chrome - 1 Pc. / Color Box

72047 Black - 1 Pc. / Color Box



Cab Mount Kit For 1960-66 Chevy Truck

- Quality molded rubber cab mounts
- Includes all mounting bolts, lock nuts, spacers and large washers
- 28 piece kit

110860 1 Set / Box



110863



110864

Stainless Steel Flag Holder with Flags

- Stainless flag holder with flags
- Show your patriotism

110863 3 Flags - 1 Set / Card

110864 5 Flags - 1 Set / Card



110861

110862

Stainless Steel Flag Holder

- Stainless flag holder only
- Fits United Pacific U.S.A. flag item No. C9003

110861 3 Post - 1 Pc. / Bulk

110862 5 Post - 1 Pc. / Bulk

NEW ITEMS

March 2020



One-Piece Style Sequential LED Tail Light For 1955 Chevy Car

- 48 SMD super bright LED with high quality all red polycarbonate lens
- Custom style one-piece design with backup light deleted
- Features sequential function with selector switch to control sequential function off, direction left, or direction right
- Also features brake attention option with sequence-once function
- Direct plug & play installation with 1157 type connector
- Electronics completely sealed in epoxy to resist corrosion and moisture
- Solid state circuit board engineered for any 12VDC system
- Recommend to upgrade under dash flasher to item no. 90652 or 90649 LED flasher
- Recommend license plate with LED back-up light, item no. 50187



(((BRAKE ATTENTION)))

(((SEQUENTIAL)))
F · L · A · S · H



110207

1 Pc. / Card



Chrome 1929-39 California License Plate Frame

- For Vintage 1929-39 California license plates w/ sharper corners
- High quality stamped steel with chrome plating

50088

1 Pc. / Card



Chrome 1940-55 California License Plate Frame

- For Vintage 1940-55 California license plates w/ rounded corners
- High quality stamped steel with chrome plating

50089

1 Pc. / Card



Rear Fuel Tank Strap For 1966-76 Ford Bronco

- Made of high-quality galvanized stamped steel
- Black EDP coated to keep your new steel fresh and rust-free
- J-bolt included for proper installation

110806 1 Pc. / Bulk

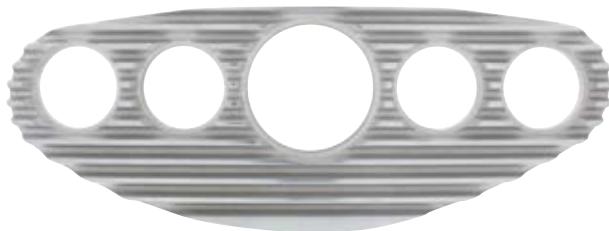

110480

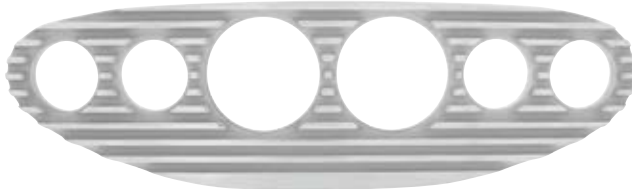

110481



Finned Style Aluminum Dash Panel

- Cast with aluminum and CNC finished faces
- Finned style design
- Four outer holes with 2-1/16" inside diameter
- Two pre-tapped #6-32 holes for straight forward installation

110480 Five Hole - 1 Pc. / Box

110481 Six Hole - 1 Pc. / Box



Chrome "Bel-Air" Script Emblem For 1955-56 Chevy Bel-Air

- Fits rear quarter panel, duplicate of original
- Beautiful chrome plated with triple chrome plating process
- Includes mounting clips
- GM restoration licensed product

C555601 1 Pc. / Bulk



COMPETITION
SERIES

2 White LED Chrome License Plate Light/Utility Light - Competition Series

- Super bright white LED utility/license light, 12 volt
- Chrome housing, water resistant
- Includes mounting pad & screws

39909 1 Pc. / Card



99193



99194



99195

United Pacific Work Light Display

- Polished stainless steel display base
- Completely assembled and wired
- 12 Volt power supply included

99193 36671/36672/36507/36965 - 1 Pc. / Box

99194 36461/36462/36506/36965 - 1 Pc. / Box

99195 36463/36464/36506/36965 - 1 Pc. / Box

NEW ITEMS

April 2020



Super bright white LED cargo bed floor illumination



Integrated LED 3rd Brake Light



LED Cargo Light Assembly For 1969-72 Chevy & GMC Truck

- Super bright LED cargo light assembly with integrated LED 3rd brake light
- High quality heavy chrome plated die-cast housing
- Includes large rubber mounting pad, socket, lens gasket, lens screws and housing to cab mounting spacers

110147 1 Pc. / Color Box



Incandescent Cargo Light Assembly For 1969-72 Chevy & GMC Truck

- Complete original style incandescent cargo light assembly with 1004 bulb
- High quality heavy chrome plated die-cast housing
- Includes large rubber mounting pad, socket, lens gasket, lens screws and housing to cab mounting spacers

110446 1 Pc. / Color Box



110149



110217



110168



39065



110148

110149 Mounting Pad - 1 Pc. / Bulk

110217 Lens Gasket - 1 Pc. / Bulk

110168 Lens - 1 Pc. / Card

39065 1004 Type Bulb - 1 Pc. / Bulk

110148 1004 Chrome Housing with Gasket - 1 Pc. / Color Box



24 High Power LED 7" Light With Dual Color Position Light

- 24 LED high power 7" light with 8 dual color LED position light
- LED white/amber position light bar changes from white to amber when sequential light is activated
- Sequential amber position light can be connected for lefthand or righthand operation
- High beam: 5000 Lumens; Low beam: 2000 lumens; Position light-white: 200 lumens; Position light-amber: 125 lumens
- Easy connection, plugs into existing wiring harness, position light requires additional wiring. Installation in some OE light housings may require modification
- For off-road use only

| Technical Specification | |
|-----------------------------|------------------------------|
| Low Beam Application | High Beam Application |
| 2000 Lumens | 5000 Lumens |
| 6000-6500K | 6000-6500K |
| 12VDC - 24VDC input | 12VDC - 24VDC input |

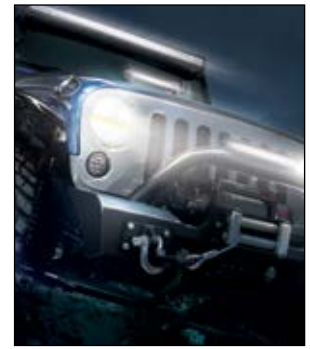

36452 1 Pc. / Color Box



Antique New Item Flyer Collection

- ANF1219** 2019 New IItem Flyer Collection - 48 pages, high gloss, 4 color, perfect bound catalog - 1 Pc. / Bulk
- ANF1218** 2018 New IItem Flyer Collection - 82 pages, high gloss, 4 color, perfect bound catalog - 1 Pc. / Bulk
- ANF1217** 2017 New IItem Flyer Collection - 62 pages, high gloss, 4 color, perfect bound catalog - 1 Pc. / Bulk
- ANF1216** 2016 New IItem Flyer Collection - 64 pages, high gloss, 4 color, perfect bound catalog - 1 Pc. / Bulk
- ANF1215** 2015 New IItem Flyer Collection - 174 pages, high gloss, 4 color, perfect bound catalog - 1 Pc. / Bulk

NEW ITEMS

May 2020



110837



110838

Anodized Billet Aluminum Turn Signal Bezel Set For 1969-77 Ford Bronco

- Beautifully CNC milled from billet aluminum
- Durable anodized finish to increase corrosion resistance while keeping the machined finished look
- Mounts between the front turn signal bucket and the grille
- Includes mounting gaskets
- Sold in pairs



Aluminum Bezel, Gasket Included

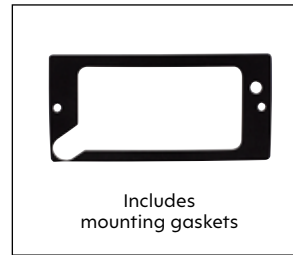

Includes mounting gaskets



110837 Clear Anodized Finish - 1 Set / Color Box

110838 Black Anodized Finish - 1 Set / Color Box



Bed Front Panel For 1967-72 Chevrolet & GMC Fleetside Truck With Steel Bed Floor

- Quality die stamped steel reproduction with 16 gauge steel
- Plain smooth style panel design
- OE style rolled over top flange with 1/4"-20 welded square nuts
- Precision punched bed side panel mounting holes
- Bottom flange made to match OE specification for use with steel bed floor

110896 1 Pc. / Box



23497



23498



23499

Chrome Thread-on Shift Knob

- High quality die-cast aluminum with triple chrome plating
- Inside thread 1/2"-13
- Made for vehicles with 1/2-13 threaded shifters. Great custom item for Rat Rods, Broncos & C10's. Adapters not included
- May also work for other vehicles with 1/2"-13 thread

23497 Skull - 1 Pc. / Card

23498 Ace of Spades - 1 Pc. / Card

23499 Eagle - 1 Pc. / Card



NEW & IMPROVED

NEW & IMPROVED

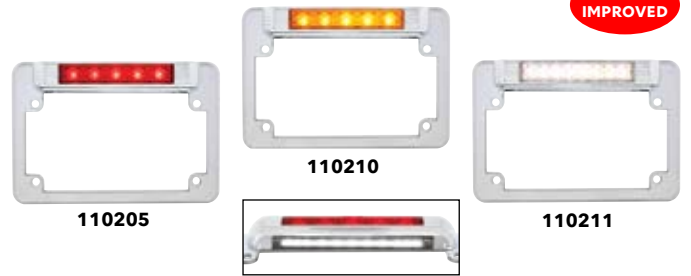

Chrome License Plate Light

- New and improved with SMD LED's for more lumen output, better heat dissipation, longer life
- Beautiful chrome die cast metal light housing with 5 LED light, and 11 LED license plate light
- Mounts to any surface with 2 mounting studs on back, 5-1/2" center-to-center
- Includes mounting pad with lip and mounting hardware.

- 110203** Red LED - 1 Pc. / Card
- 110204** White LED - 1 Pc. / Card
- 110265** Amber LED - 1 Pc. / Card

Chrome Motorcycle License Plate Frame w/ LED Light

- New and improved with SMD LED's for more lumen output, better heat dissipation, longer life
- Beautiful chrome die cast metal light housing with 5 LED light, and 11 LED license plate light
- Fits standard U.S. motorcycle license plates

- 110205** Red LED - 1 Pc. / Card
- 110210** Amber LED - 1 Pc. / Card
- 110211** White LED - 1 Pc. / Card

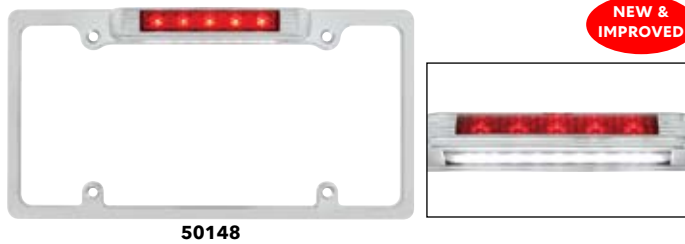

NEW & IMPROVED

NEW & IMPROVED

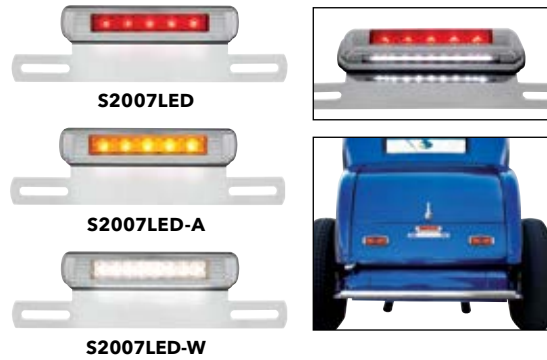

Chrome License Plate Frame w/ Auxiliary Light

- New and improved with SMD LED's for more lumen output, better heat dissipation, longer life
- Beautiful chrome die cast metal light housing with 5 LED light, and 11 LED license plate light
- Fits standard U.S. & Canadian 6" X 12" license plates
- Overall frame dimension 12-5/16" X 6-3/8"

- 50148** Red LED - 1 Pc. / Card
- 50149** Amber LED - 1 Pc. / Card
- 50187** White LED - 1 Pc. / Card

Chrome Motorcycle License Plate Frame w/ LED Light

- New and improved with SMD LED's for more lumen output, better heat dissipation, longer life
- Beautiful chrome die cast metal light housing with 5 LED light, and 11 LED license plate light
- Mounts to any surface with 2 mounting studs on back, 5-1/2" center-to-center

- S2007LED** Red LED - 1 Pc. / Card
- S2007LED-A** Amber LED - 1 Pc. / Card
- S2007LED-W** White LED - 1 Pc. / Card



United Pacific Light Display - 7", 5-3/4", 4"x6", 5"x7"

- Quality point-of-purchase display made of steel and gloss black powder coated
- Includes United Pacific items: 31084, 31267, 34125, 31087
- Includes 12V power supply unit & wall plug
- Completely assembled and wired
- Display approximate size: 33-3/4" L X 12-3/4" W X 4 -1/2" H

- 99196** 1 Pc. / Box

NEW ITEMS

June 2020



110772



110773



Anodized Billet Aluminum Side Marker Bezel w/ Raised Side Protection For 1970-77 Ford Bronco

- Beautifully CNC milled from billet aluminum
- Durable clear anodized finish to increase corrosion resistance while keeping the machined finished look
- Includes two stainless steel screws and mounting gasket
- Also fits 1970-74 Econoline, and rear only on 1970-72 F100, F150, & F250
- Sold each

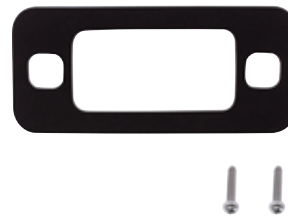

110772 Clear Anodized Finish - 1 Pc. / Color Box

110773 Black Anodized Finish - 1 Pc. / Color Box



110774



110775



Anodized Billet Aluminum Side Marker Light Bezel For 1970-77 Ford Bronco

- Beautifully CNC milled from billet aluminum
- Durable clear anodized finish to increase corrosion resistance while keeping the machined finished look
- Includes two stainless steel screws and mounting gasket
- Also fits 1970-74 Econoline, and rear only on 1970-72 F100, F150, & F250
- Sold each

110774 Clear Anodized Finish - 1 Pc. / Color Box

110775 Black Anodized Finish - 1 Pc. / Color Box

HOT ITEM

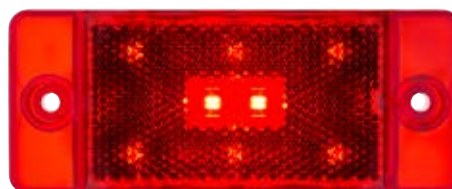
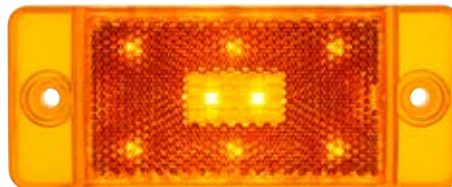

LED Side Marker For 1970-77 Ford Bronco

- 8 LED Dual function, parking light and turn signal
- Super bright amber LED with amber or red acrylic lens
- Epoxy coated, fully sealed electronics
- Fits left hand and right hand

110804 Front LED Side Marker - Amber - 1 Pc. / Card

110805 Rear LED Side Marker - Red - 1 Pc. / Card



110776



110777



Anodized Billet Aluminum Steering Column Cover For 1966-77 Ford Bronco

- Beautifully CNC milled from billet aluminum
- Upgrades the original plastic steering column cover to heavy duty billet aluminum
- Durable clear anodized finish to increase corrosion resistance while keeping the machined finished look
- Two-piece design for easy installation

110776 Clear Anodized Finish - 1 Pc. / Card

110777 Black Anodized Finish - 1 Pc. / Card

**New Upgraded
Slim Low Profile Design**



36446

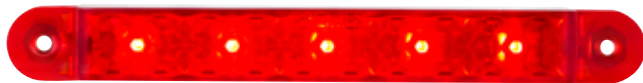

36447

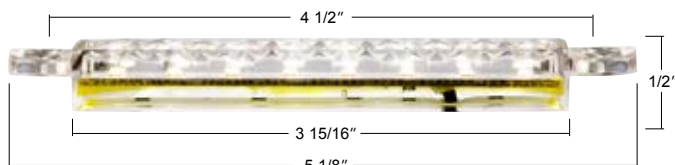

36448

5" SMD LED Light Strip With Hard Wire

- 5 Super bright SMD LED strip with fully sealed electronics
- 12VDC, available in dual function red or amber, or single function white
- Captive #6-32 nuts for rear flush mounted installation
- For clean and proper mounting, a 3-15/16 X 5/8" rectangular pocket is required
- See "Attachment-Line Art" for more dimensional details

36446 Amber LED - 1 Pc. / Card

36447 Red LED - 1 Pc. / Card

36448 White LED - 1 Pc. / Card



Tire Checker Bat

- United pacific 17" aluminum tire checker

99060 1 Pc. / Bulk

NEW ITEMS

July 2020



110871



110870



Anodized Aluminum Headlight Bezel For 1969-72

- Quality stamped 24 gauge aluminum with rolled edges
- Beautiful clear anodized finish

110870 L/H - 1 Pc. / Box

110871 R/H - 1 Pc. / Box



Stainless Steel Hood Spring For 1967-72 Chevrolet & GMC Truck (Pair)

- Specially engineered to have the same yield and tensile strength as original
- Corrosion resistant stainless steel, with a bright electropolished satin finish
- Sold in pairs

110899 1 Pair / Bulk



GM Restoration Parts

Glove Box Lock Cylinder w/Keys For 1947-53 Chevy/GMC Truck

- Quality reproduction of original style lock cylinder
- Includes 2 keys with GM marking
- Official GM licensed restoration product

110888 1 Pc. / Bulk



GM Restoration Parts

Door Lock Cylinder W/Keys For 1947-51 Chevy/GMC Truck

- Outside door lock cylinder with 2 keys
- Official GM licensed restoration product

110887 1 Pc. / Bulk



Stellar Pluto+ Duo Bundle Headset

- A Trucker's "best friend" headset offering battery life for longest talk time, best comfort, unique style and quality sound
- "Pluto" mode is single earpiece and 30 hours of talk time / 500 hours of stand-by time
- "Duo" mode adds a stereo earpiece for 60 hours of talk time / 900 hours stand-by time
- "Duo" earpiece is also a USB power bank to charge other devices on the go
- Noise Armor® technology offers the best noise cancellation for truckers. No more "I can't hear"
- Bluetooth 5.0 compatible, and has longer range and more connectivity for your devices
- Durable carrying case, dual USB car charger, and USB cable included

95002 1 Set / Box

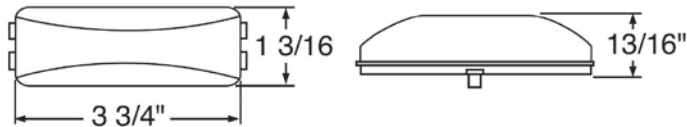

Incandescent Rectangular Fender Mount Clearance /Marker Light - Amber & Red Lens

- Functions as both front and rear clearance light for trailers over 80 inches wide
- High quality injection molded dual color, amber and red plastic lens
- Polycarbonate lens sonically sealed to housing to prevent moisture intrusion
- Grease filled terminals to prevent corrosion
- Recommend mounting/quick-connect base: item # 30919 (chrome) or item # 33006 (black)

31050 1 Pc. / Bulk



1966-77 Ford Bronco Catalog - 2nd Edition

- 54 pages, high gloss 4 color printing with UV coated cover
- 2nd Edition

ACBR02 1 Pc. / Bulk

NEW ITEMS

August 2020



34131



34132



34133



34134

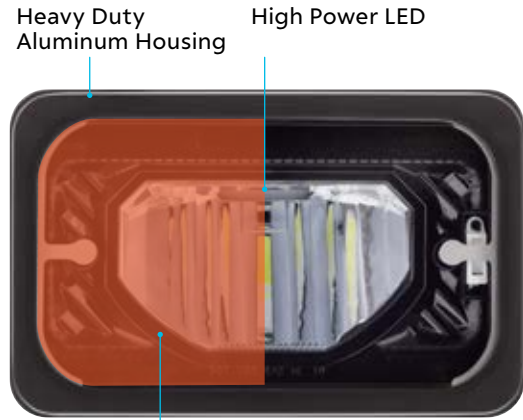

Heavy Duty Aluminum Housing

High Power LED

Electrical Heating System
Automatic De-ices the Headlight According to Ambient Temperature



100% LED

DOT

4" X 6" Heated LED Headlight

- Features a heating system that automatically de-ices the headlight according to ambient temperature
- Durable glass lens with heavy duty aluminum housing
- Plug & play with standard H4 style connector plug for ease of installation
- Available in high beam and low beam with choice of chrome or black inner liner
- Low beam: 1000 lumens, high beam: 1200 lumens, 12-24VDC, 20 watts

| | | |
|--------------|--------|--------------------------------------|
| 34131 | Chrome | Low Beam - 1 Pc. / Color Box |
| 34132 | Chrome | High Beam - 1 Pc. / Color Box |
| 34133 | Black | Low Beam - 1 Pc. / Color Box |
| 34134 | Black | High Beam - 1 Pc. / Color Box |

Technical Specification

Low Beam Application
1000 Lumens
12VDC - 24VDC Input
20 Watts

High Beam Application
1200 Lumens
12VDC - 24VDC Input
24 Watts



Dash Bezel For 1969-72 Chevy/GMC Truck With 7 Gauges - Black & Chrome

- High quality plastic injection molded reproduction of the original
- Beautiful chrome plated outer trim with black painted inner face
- Feature original mounting pattern with mounting posts for easy installation

110697 1 Pc. / Box



110897

110898



UP# 110899
Available Separately

Chrome Hood Hinge For 1967-72 Chevrolet & GMC Truck

- Heavy duty steel reproduction of the original hood hinge style and design
- Beautifully chrome plated with triple chrome plating process
- Stainless steel springs available separately, UP#110899

110897 L/H - 1 Pc. / Box

110898 R/H - 1 Pc. / Box



Bed Front Panel For 1932-37 Ford Truck

- Die stamped with high quality 16 gauge sheet metal
- Features original style stiffening ribs and square-shape top edge
- Finished with black EDP protective coating to keep your new steel fresh and rust-free

B21507 1 Pc. / Box



Black Arm Rest For 1968-77 Ford Bronco (Pair)

- Perfect for replacing that wore out arm rest on an early Bronco
- High quality synthetic leather in black finish
- Mounting pocket w/ original mounting pattern for easy replacement

110840 1 Pair / Box



Primer Finished Outside Sunvisor For 1955-59 Chevy Passenger Car

- Excellent reproduction with original detail
- Features precision punched mounting holes and center reinforcement brace
- Ready for paint with primer finished coating

C7016 1 Pc. / Bulk



Remote Exterior Mirror Kit For 1964.5 -66 Ford Mustang

- Beautiful die-cast and chrome plated exactly as original
- Features remote linkage with handle and mounting plate
- Includes mounting pad and screws

F646605 L/H - 1 Pc. / Box

F646606 R/H - 1 Pc. / Box



United Pacific Cap - Camo U.P. Cap

- 100% cotton twill cap

99086 1 Pc. / Bulk

NEW ITEMS

September 2020

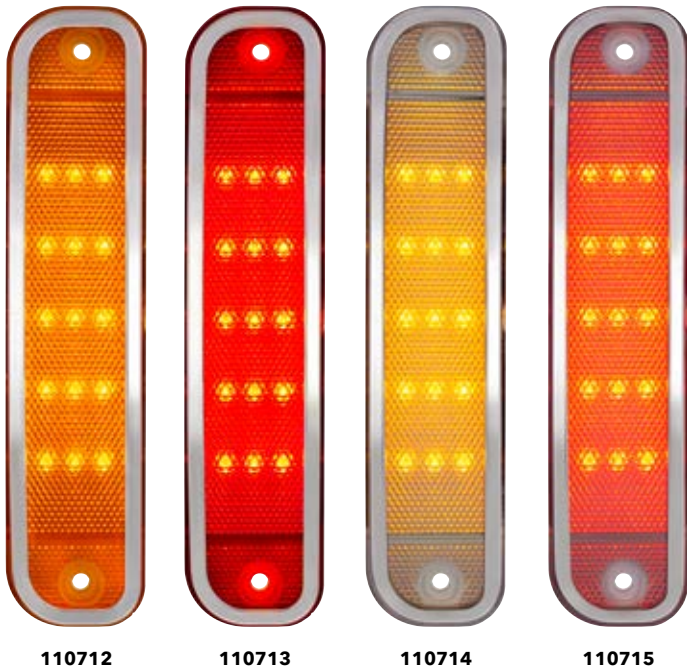

15 LED Side Marker Light With Stainless Steel Trim For 1973-80 Chevrolet Truck

- Super bright LED with high quality injection molded acrylic lens
- Dual function, parking light and turn signal
- Polished stainless steel deluxe style trim
- Epoxy coated, fully sealed electronics
- Also fits 1973-91 Chevy & GMC dually rear

| | |
|---------------|--|
| 110712 | Amber LED/Amber Lens - 1 Pc. / Card |
| 110713 | Red LED/Red Lens - 1 Pc. / Card |
| 110714 | Amber LED/Clear Lens - 1 Pc. / Card |
| 110715 | Red LED/Clear Lens - 1 Pc. / Card |



3 Candle Power 6V Parking Light Bulb For 1928-48 Ford Car & Truck

- #63 style, 6 volt, single contact with BA15s base
- Typically used on early Fords for cowl lights, parking lights, dash lights

A1068 1 Pc. / Bulk



Black Powder Coated Magnetic Pipe Holder With Felt Liner

- No-Scratch felt lining
- Strong magnetic securely sticks to any metal dashboard
- Keep pipe within easy reach

C5016 1 Pc. / Color Box

NEW ITEMS

October 2020



Titan Cap™

Locking Gas Cap for 1947-71 Chevy and Ford

- Top quality rugged all metal military style fuel cap design
- Fits 1947-71 Chevy & GMC trucks, 1949-70 Ford cars, 1957-70 Ford trucks & Bronco
- Great for off-road enthusiasts who value extreme-armor designs and fitments
- Available in chrome plated or matte black painted finish
- Vented gas cap for vented fuel systems only

110874 **Chrome** - 1 Pc. / Card

110875 **Black** - 1 Pc. / Card

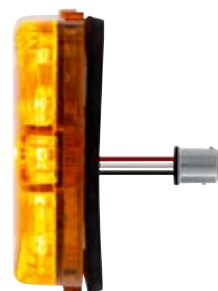
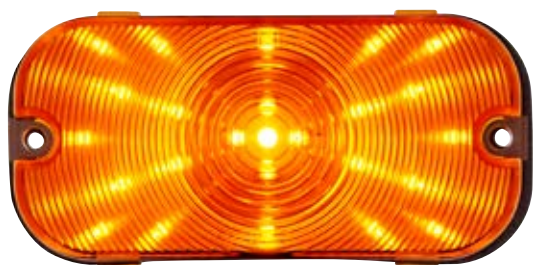

25 LED Parking/Signal Light For 1966-68 Ford Bronco

- LED Dual function, parking light and turn signal
- Super bright amber LED with amber acrylic lens
- Epoxy coated, fully sealed electronics, 1157 plug
- Fits left hand and right hand
- Gasket included

110858 1 Pc. / Card





Stainless Steel Fender Skirt Scuff Pads For 1956 Chevy Passenger Car (Pair)

- Made of top grade, rust free, T304 stainless steel
- Highly polished to a mirror like shine

C1007 1 Pair / Bulk



Stainless Steel Fender Skirt Scuff Pads For 1959 Chevy Passenger Car (Pair)

- Made of top grade, rust free, T304 stainless steel
- Highly polished to a mirror like shine

C1009 1 Pair / Bulk



Chrome Skull Shift Linkage For Harley

- Unique 3D skull design with triple chrome plating for a lasting show-bike shine
- High quality adjustable rod end ball joints to ensure smooth operation
- Includes a straight transmission lever cover and decorative acorn nuts and bolts. (Note: cover does not fit 2017+ Milwaukee-Eight with curved trans lever)
- Complete the look with Skull Swing Arm Insert Set, UP# 52010
- Fits 1986+Harley Softtail (except 18+ FXBB and FXLR), Touring and Trike models. (Does not fit 97- 99 FLSTS or models equipped with Softail Extended Reach Forward Controls.)

52009 1 Pc. / Card



Chrome Skull Swing Arm Accent Set For Harley

- Fits 2008-17 Harley-Davidson Softtail models (except FXCW, FXCWC, FXSB, and FXSBSE)
- Unique four-piece skull accent set to dress up the recessed area in the rear swing arm frame
- Easy to install with pressure sensitive adhesive mounting
- Beautifully chrome plated plastic injection molded
- Add a little attitude to your ride

52010 1 Set / Card

NEW ITEMS

November 2020



B20331



B20332



B20330 - Front Fender Brace

Steel Front Fender For 1932 Ford Car & Truck

- Quality stamped steel, exactly as original Henry!
- Fender edge bead with steel inner wire as original
- Finished with black EDP protective coating to keep your new steel fresh and rust-free
- Fits all 1932 Ford vehicles including 1932 Truck. However, fender does NOT have spare tire well.
- Available in left hand or right hand applications

B20331 L/H - 1 Pc. / Box

B20332 R/H - 1 Pc. / Box

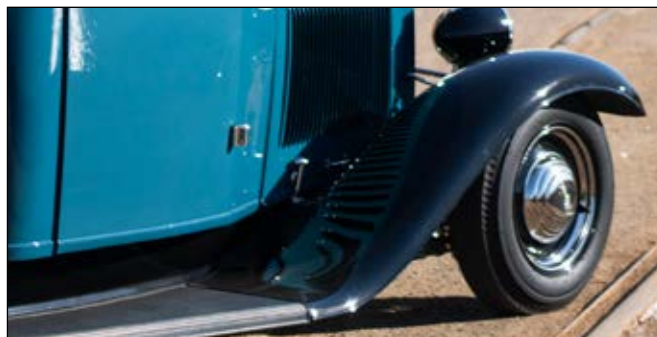

B20333



B20334

Rear Fender for 1932 Ford 5W Coupe & Roadster

- Quality stamped steel, exactly as original Henry!
- Made of excellent 20 gauge sheetmetal
- Fender edge bead with steel inner wire as original
- Precision punched quarter panel mounting holes
- Includes mounting holes for frame horn cover
- Coated with black EDP
- Sold individually, please specify left or right hand side

B20333 L/H - 1 Pc. / Box

B20334 R/H - 1 Pc. / Box





Stainless Steel Bumper End Bolts And Nuts For 1928-31 Ford Model A (Pair)

- Beautiful quality stainless steel
- Exact shape and size as the original
- 5-1/8" partial threaded with 1" long 7/16"-20 threads
- Feature original style anti-rotation key design under the head of the bolt

A6219 1 Pair / Bulk



Stainless Steel Bumper Bar Spacer For 1928-31 Ford Model A (Pair)

- Highly polished stainless steel
- A spacer between 2 bumper bars

A6220 1 Pair / Bulk



Highly Detailed Bassett Hound Ornament

- Detailed die-casting with beautiful chrome plating or matte black powder coated finish
- Easy installation on any vehicle with four mounting studs
- Approximately 7-5/8" x 4-1/8" x 7-1/4"
- Mounting hardware included
- Ideal for decorating small and personal space, home, office and garage

72003 Chrome - 1 Pc. / Color Box

72053 Black - 1 Pc. / Color Box



Cab Mount Kit For 1949-54 Chevy And GMC Truck

- Complete cab mounting kit with fasteners
- Features heavy duty reinforced rubber square pad and mounting fasteners for front cab installation
- Quality molded rubber bushing for the rear cab mount shackles
- 18 piece kit
- Includes installation diagram

110841 1 Set / Bulk



19" Double Contact Pigtail

- 18 AWG thermoplastic jacketed wires
- Tinned copper wires for better corrosion resistance
- Nylon insulation plate

A1060-4 1 Pc. / Bulk

Heated LED Headlights with Polycarbonate Lens & Housing

Available Mid-November





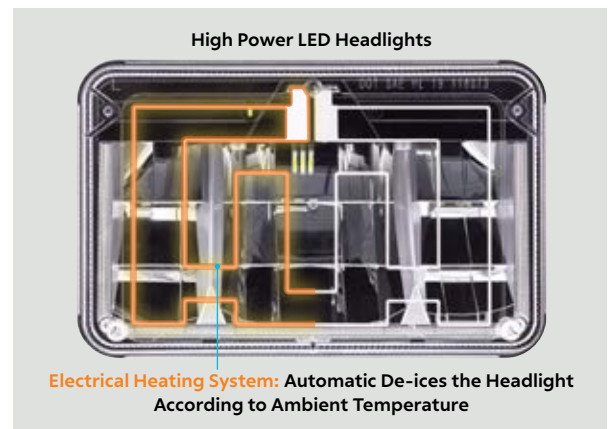

- Features a heating system that automatically de-ices and defrosts the headlight lens when outside temperature reaches 50 degrees Fahrenheit (10 Celsius) or below
- Integrated monitoring system to turn off heating when snow & ice has cleared from lens
- Durable corrosion resistant polycarbonate lens, housing & electronics resist shock and vibration
- Plug & play with standard H4 style connector plug for ease of installation



100%LED



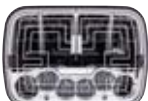

DOT

Technical Specs

| Item | Size | Beam | Lumens | Color Temp. | Voltage | Unit / Box |
|--|--|----------|----------|-------------|---------|--------------|
|  34135 |  34136 | | | | | |
| 34135 | 4" x 6" | Low | 750 | 6500 kelvin | 12v/24v | 1 Pc. / Card |
| 34136 | 4" x 6" | High | 1000 | 6500 kelvin | 12v/24v | 1 Pc. / Card |
|  34137 |  34138 | | | | | |
| 34137 | 5" x 7" | High/Low | 1100/600 | 6000 kelvin | 12v/24v | 1 Pc. / Card |
| 34138 | 7" | High/Low | 950/500 | 5700 kelvin | 12v/24v | 1 Pc. / Card |

Also Available:

Technical Specs

| Item | Size / Color | Beam | Lumens | Watts | Voltage | Unit / Box |
|--|--|------|--------|-------|---------|-------------------|
|  34131 |  34132 | | | | | |
| 34131 | 4" x 6" / Chrome | Low | 1000 | 20 | 12v/24v | 1 Pc. / Color Box |
| 34132 | 4" x 6" / Chrome | High | 1200 | 24 | 12v/24v | 1 Pc. / Color Box |
|  34133 |  34134 | | | | | |
| 34133 | 4" x 6" / Black | Low | 1000 | 20 | 12v/24v | 1 Pc. / Color Box |
| 34134 | 4" x 6" / Black | High | 1200 | 24 | 12v/24v | 1 Pc. / Color Box |

NEW ITEMS

December 2020



110093



110092



Glove Box Door For 1964-66 Chevy Truck

- Excellent stamped 20 gauge steel reproduction with all of the original contour detail
- Features precision cut lock cylinder pocket, rectangular front recess for OE Chevrolet emblem, and three OE style cup holder recesses on inner panel
- Includes door spring and welded 1/4-20 hinge nuts
- Available in beautiful chrome plated finish or black EDP coated finish

110093 Chrome - 1 Pc. / Box (New)

110092 Black - 1 Pc. / Box



Glove Box Door Hinge For 1964-66 Chevy Truck

- Excellent quality steel stamping
- Exact design as original with mounting holes for easy installation
- Finish with black EDP protective coating

110094 1 Pcs. / Box



Quarter Window Assembly w/Clear Glass For 1967-68 Ford Mustang Coupe

- Heavy 16 gauge stamped steel window track with mounting hardware
- Crystal clear non-tinted tempered window glass
- Beautiful polished stainless steel window frame w/ weather-strip
- Fully assembled from factory for a quick and straight forward replacement

110645 L/H - 1 Pc. / Box

110644 R/H - 1 Pc. / Box

PRODUCT INDEX

| ITEM# | PAGE# | ITEM# | PAGE# | ITEM# | PAGE# |
|--------|-------|--------|-------|------------|-------|
| 23497 | 14 | 110217 | 12 | 110899 | 18 |
| 23498 | 14 | 110249 | 5 | 30610B | 6 |
| 23499 | 14 | 110250 | 5 | A1060-4 | 26 |
| 31050 | 19 | 110265 | 15 | A1068 | 22 |
| 34131 | 20 | 110446 | 12 | A6219 | 26 |
| 34131 | 27 | 110480 | 11 | A6220 | 26 |
| 34132 | 20 | 110481 | 11 | ACBR02 | 19 |
| 34132 | 27 | 110516 | 4 | ANF1215 | 13 |
| 34133 | 20 | 110588 | 8 | ANF1216 | 13 |
| 34133 | 27 | 110589 | 8 | ANF1217 | 13 |
| 34134 | 20 | 110644 | 28 | ANF1218 | 13 |
| 34134 | 27 | 110645 | 28 | ANF1219 | 13 |
| 34135 | 27 | 110697 | 20 | B20331 | 25 |
| 34136 | 27 | 110712 | 22 | B20332 | 25 |
| 34137 | 27 | 110713 | 22 | B20333 | 25 |
| 34138 | 27 | 110714 | 22 | B20334 | 25 |
| 36446 | 17 | 110715 | 22 | B21507 | 21 |
| 36447 | 17 | 110735 | 4 | C1007 | 24 |
| 36448 | 17 | 110736 | 4 | C1009 | 24 |
| 36452 | 13 | 110737 | 4 | C5016 | 22 |
| 36454 | 6 | 110738 | 4 | C555601 | 11 |
| 36455 | 6 | 110772 | 16 | C687201 | 7 |
| 36456 | 6 | 110773 | 16 | C7016 | 21 |
| 36457 | 6 | 110774 | 16 | F646605 | 21 |
| 39065 | 12 | 110775 | 16 | F646606 | 21 |
| 39909 | 11 | 110776 | 17 | S2007LED | 15 |
| 50088 | 10 | 110777 | 17 | S2007LED-A | 15 |
| 50089 | 10 | 110804 | 7 | S2007LED-W | 15 |
| 50148 | 15 | 110804 | 16 | | |
| 50149 | 15 | 110805 | 7 | | |
| 50187 | 15 | 110805 | 16 | | |
| 52009 | 24 | 110806 | 11 | | |
| 52010 | 24 | 110825 | 7 | | |
| 72003 | 26 | 110826 | 7 | | |
| 72046 | 9 | 110827 | 7 | | |
| 72047 | 9 | 110837 | 14 | | |
| 72053 | 26 | 110838 | 14 | | |
| 95002 | 19 | 110840 | 21 | | |
| 99060 | 17 | 110841 | 26 | | |
| 99086 | 21 | 110842 | 6 | | |
| 99193 | 11 | 110858 | 23 | | |
| 99194 | 11 | 110860 | 9 | | |
| 99195 | 11 | 110861 | 9 | | |
| 99196 | 15 | 110862 | 9 | | |
| 110092 | 28 | 110863 | 9 | | |
| 110093 | 28 | 110864 | 9 | | |
| 110094 | 28 | 110867 | 8 | | |
| 110147 | 12 | 110868 | 5 | | |
| 110148 | 12 | 110870 | 18 | | |
| 110149 | 12 | 110871 | 18 | | |
| 110168 | 12 | 110874 | 23 | | |
| 110203 | 15 | 110875 | 23 | | |
| 110204 | 15 | 110876 | 8 | | |
| 110205 | 15 | 110877 | 5 | | |
| 110205 | 15 | 110878 | 5 | | |
| 110206 | 7 | 110884 | 8 | | |
| 110207 | 10 | 110887 | 18 | | |
| 110210 | 15 | 110888 | 18 | | |
| 110210 | 15 | 110896 | 14 | | |
| 110211 | 15 | 110897 | 20 | | |
| 110211 | 15 | 110898 | 20 | | |