



**PRODUCT GUIDE**

Revision 13

THE SOURCE FOR PROFESSIONAL FABRICATION COMPONENTS

LEARN. SHARE. GET KNOWN.

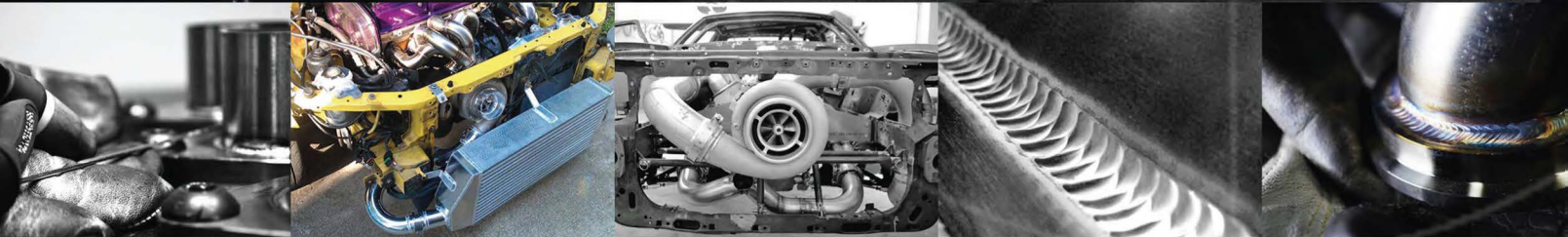

# FABRICATION **Life**

MAN VS METAL

# TABLE OF CONTENTS

## FABRICATION COMPONENTS

FUSE Wire	6-7
Aluminum Mandrel Bends / Straight Tubing / Transitions / Joiners / Cast Elbows	8-10
Air to Air Intercoolers	11
VANJEN Clamping System	12-13
Silicone Connectors / Heater Hose / Vacuum Hose	14-18, 20
Stainless Steel T-Bolt Clamps / Worm Gear Clamps	19
Mass Air Flow Sensor Adapters	21
Bellmouth Velocity Stacks	22
Performance Air Filters	22-23
Vacuum Manifold / Vacuum Fittings	24-25
Manual Boost Controller	26
BOV Flanges	27
Stainless Steel Schedule 10 Pipes (Elbows, T-Pipes, Straight Lengths)	28
Turbo Manifold Merge Collectors	29
Turbo Flanges and Wastegate Flanges	30-37
Oil Restrictor Fittings / Oil Feed Kits / Oil Drain Kits	38
Oil Feed and Oil Return Flanges	38-39
Braided Flex Hoses (Stainless Steel and Nylon) / Push-On Style Flex Hoses	40-41
Aluminum Hose End Fittings	42-43
Push-On Flex Hoses and Push-On Hose End Fittings	44
Aluminum Adapter Fittings	45-51
Small Diameter Hose Clamps / Fitting and Hose Tools and Accessories	52-53
Male and Female Weld Bungs (Aluminum and Steel)	54
Catch Cans	55
Heat Shields / Accousting Shields / Hose Protection Sleeves	56-58
Windshield Washer Bottle Replacement Kit	59
Exhaust Manifold Head Flanges	60
Stainless Steel Mandrel Bends (Round and Oval) / Straight Tubing / Reducers	61-65
TIG Weld Wire	65
Stainless Steel Merge Collectors / Stainless Steel Double Slip Joints	66-67
Stainless Steel Flex Couplings	68-69
High Flow Catalytic Converters	70-71
V-Band Flange Assemblies (Stainless Steel and Aluminum)	72-73
Stainless Steel Exhaust Flanges and Gaskets (2 Bolt and 3 Bolt)	74
Exhaust Clamps / Exhaust Sensor Fittings and Weld Bungs / Exhaust Accessories	75-78
Stainless Steel Universal Mufflers / Stainless Steel Resonators / Race Mufflers	79-83
Stainless Steel Exhaust Tips	84-85

## PERFORMANCE EXHAUST SYSTEMS

Headers and Cat-Back Exhaust Systems	86-87
--------------------------------------	-------

## MISCELLANEOUS

Timing Belt Tensioner / Carbon Fiber Shift Knob	88
Vibrant Merchandise / Dealer Kits	89

# PRIVATE LABEL PROGRAMS



# SAVE BIG

ON  
GO-TO-MARKET  
MATERIAL &  
LABOUR COSTS.

*- Ask us how -*

## FOCUS ON BUILDING YOUR BUSINESS, NOT PARTS.

Vibrant Performance is your one-stop supply chain solution. Let us focus on building your product needs to the highest quality standards, while you focus on building your brand and developing the industry's next big thing!

- Exhaust Systems & Components
- Intake & Turbo Kits
- Product Design Support
- Machined, Cast & Forged Parts
- Custom Components
- Packaging Design
- Logistics & Warehousing



# LARGE VOLUME SUPPLY PROGRAMS



VIBRANT CAN  
SUPPLY YOUR  
LARGE VOLUME  
COMPONENT  
REQUIREMENTS  
IN THE MOST  
COST EFFECTIVE  
AND TIMELY  
MANNER.

## WE'RE MORE THAN A SUPPLIER...VIBRANT POWER IS YOUR STRATEGIC PARTNER IN BUSINESS.

For over 25 years Vibrant Power has supplied key intake and exhaust components to original equipment manufacturers located in over 50 countries. These partnerships are built on the timely, and reliable supply of high quality products. We invite you to inquire about our volume related programs, and learn how you can benefit from a strategic partnership with Vibrant Power Inc.

- Quality Control
- Distribution & Logistics
- Parts Availability
- Time-to-Market Efficiencies
- Made-to-Order



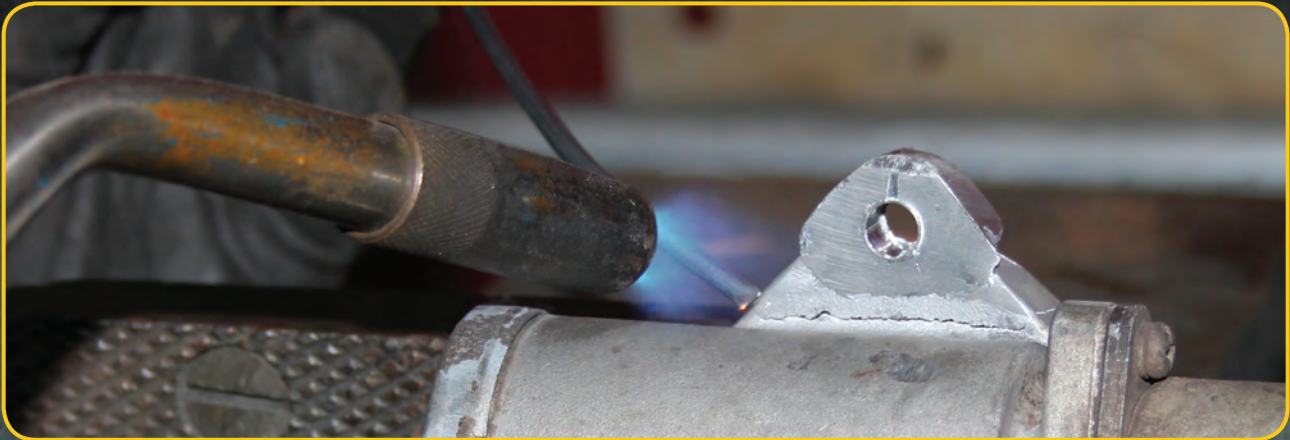

FUSE wire is an innovative product that allows users to achieve an incredibly strong, “weld-like” bond of Aluminum and its alloys. FUSE wire features a proprietary chemical composition that allows it to react at low temperature and which produces a bond that can withstand 1600psi of pressure and has a tensile strength of 13500psi. Whether you are trying to “fuse” aluminum tubing to a flange, fill a hole or do simple repairs, FUSE wire makes it easy.

FUSE wire works at low working temperatures (380°C or 715°F), which ensures there is little to no deformation of the material you are working with. A variety of heat sources (Propane or Butane Torch recommended) can be used to bring the repair area or base Aluminum to temperature. When the working temperature has been reached, simply apply FUSE to join or repair any Aluminum based material.

## HEAT IT

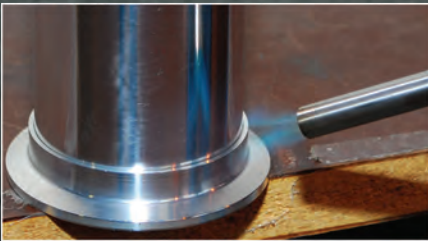

Heat it... The FUSE process begins with Heat! No special welding equipment is needed. Get started with a Propane or Butane Torch and heat your Aluminum based material to 380 deg C or 715 deg F.

## FUSE IT



Fuse it... The FUSE wire is easy to work with! Once your Aluminum material reaches temperature, FUSE wire can be easily applied to join or repair any Aluminum Alloy.

## USE IT



Use it... The FUSE wire is an ideal repair solution for any Aluminum based product. Ideal for use in Automotive, Industrial or Household situations! FUSE wire can be drilled, milled, turned or tapped!



## Construction

Lugging a welder around the job site to do Aluminum repairs is both time consuming and inefficient. A spool of FUSE and a butane torch can handle virtually any job that would otherwise require Aluminum welding and allows your crew much more mobility in getting the job done.



## Marine

If you are a boat owner, having some FUSE wire in your toolbox is a must. Boats and personal watercraft feature a lot of Aluminum parts and accessories. Replacing cracked or broken parts or getting them repaired by a professional can get awfully expensive. Instead, you can rely on FUSE wire to make broken parts good as new.



## Home & Garden / Repair

Broken mailboxes, cracked shelving or damaged lawn mower casing are all examples of household items that can be easily repaired with FUSE. The ravages of time and exposure to the elements can cause damage to many common tools and structures made of Aluminum. With FUSE, you can extend the life of those items, saving you money and aggravation.



## Automotive

Leaking Radiator? Cracked AC line? Broken Body Trim? You could buy new parts and pay someone to replace them for you OR you can just fix it yourself with FUSE. Why incur the cost of new parts when FUSE allows you to solve the problem with a quick, strong and inexpensive weld. Save time and money with FUSE!



Part No. 18960

Our 5 foot coil of FUSE wire is intended for commercial users. If you find yourself using FUSE wire every day on the jobsite or at your shop, it makes sense to step up to our 5 foot coil and take advantage of the reduced cost per inch vs. our 10 inch coil. 5 feet of material "fuses" 20 feet of sheet metal.



Part No. 18910

The 10 inch coil is ideal for anyone from a DIY handyman to a racer going to the track. Think of it as a low cost insurance policy. The last thing any racer wants to do is be forced to pack up their car and head home early from an event because of a simple crack or puncture that could be easily repaired by FUSE wire. Not everyone wants to lug a bulky welder to the track. Just keep a 10 inch length of FUSE wire in your toolbox and a butane torch in the trailer and you are ready for anything. 10 inches of material "fuses" 5 feet of sheet metal.

## ALUMINUM TUBING

Fabricate your own custom intercooler and intake assemblies using Vibrant Performance Aluminum Tubing. These mirror polished T6061 Aluminum Elbows and Straight Lengths measure 1.5mm thick and are available in sizes ranging from 1 1/2" to 4" O.D.

They require virtually no surface preparation for professional tig welding (see page 65 for our offering of Aluminum TIG Weld Wire). Also works flawlessly with Vibrant's FUSE wire (see pg 6-7).

### 180° ALUMINUM ELBOWS



Part No.	Tube O.D.	CLR	Leg Length
2863	1 1/2"	2 1/4"	4"
2864	1 3/4"	2 1/4"	4"
2865	2"	2 1/2"	4"
2867	2 1/2"	3 3/4"	3 1/2"
2868	2 3/4"	4 1/4"	3 1/2"
2869	3"	4 1/2"	2 1/2"

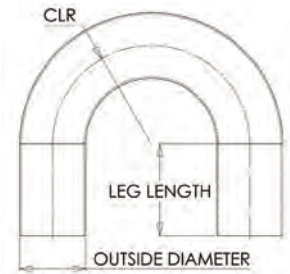

### 120° ALUMINUM ELBOWS



Part No.	Tube O.D.	CLR	Leg Length
2154	1 1/2"	2 1/4"	4"
2155	1 3/4"	2 1/4"	4"
2823	2"	2 1/2"	4"
2824	2 1/4"	3"	4"
2825	2 1/2"	3 3/4"	3"
2826	2 3/4"	4 1/4"	3"
2827	3"	4 1/2"	2 1/2"
2828	3 1/2"	4 3/4"	2 1/2"
2829	4"	6"	2 1/2"

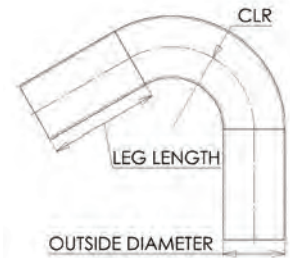

### 90° ALUMINUM ELBOWS



Part No.	Tube O.D.	CLR	Leg Length
2158	1 1/2"	2 1/4"	4"
2159	1 3/4"	2 1/4"	4"
2884	2"	2 1/2"	4 1/2"
2887	2 1/4"	3"	4 1/2"
2178	2 1/2"	3 3/4"	3"
2881	2 3/4"	4 1/4"	3"
2176	3"	4 1/2"	2 1/2"
2891	3 1/2"	4 1/2"	2 1/2"
2876	4"	5"	2 1/2"

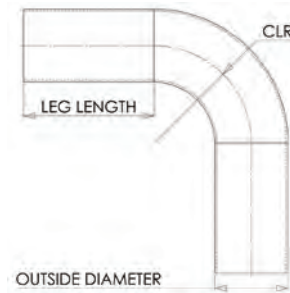

### 60° ALUMINUM ELBOWS



Part No.	Tube O.D.	CLR	Leg Length
2152	1 1/2"	2 1/4"	6"
2153	1 3/4"	2 1/4"	6"
2814	2"	2 1/2"	6"
2816	2 1/4"	3"	6"
2817	2 1/2"	3 3/4"	6"
2818	2 3/4"	4 1/4"	6"
2819	3"	4 1/2"	6"
2821	3 1/2"	4 1/2"	5 1/2"
2822	4"	5"	5 1/2"

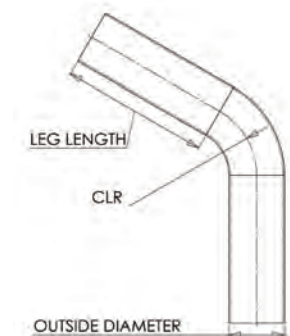



## 45° ALUMINUM ELBOWS



Part No.	Tube O.D.	CLR	Leg Length
2156	1 1/2"	2 1/4"	6"
2157	1 3/4"	2 1/4"	6"
2883	2"	2 1/2"	6"
2886	2 1/4"	3"	6"
2177	2 1/2"	3 3/4"	6"
2880	2 3/4"	4 1/4"	6"
2175	3"	4 1/2"	6"
2890	3 1/2"	4 1/2"	5 1/2"
2875	4"	5"	5 1/2"

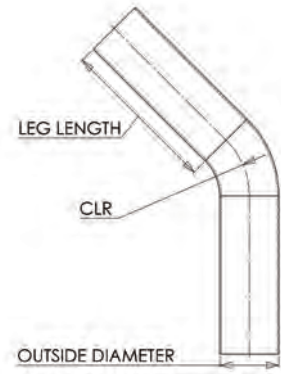

## 30° ALUMINUM ELBOWS



Part No.	Tube O.D.	CLR	Leg Length
2150	1 1/2"	2 1/4"	6 1/2"
2151	1 3/4"	2 1/4"	6 1/2"
2806	2"	2 1/2"	6 1/2"
2807	2 1/4"	3"	6 1/2"
2808	2 1/2"	3 3/4"	6 1/2"
2809	2 3/4"	4 1/4"	6"
2811	3"	4 1/2"	6"
2812	3 1/2"	4 1/2"	5 1/2"
2813	4"	5"	5 1/2"

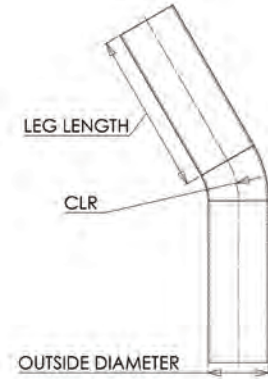

## ALUMINUM STRAIGHT TUBING

T6061 Aluminum Straight Lengths are available in both 18 inch and 5 foot lengths

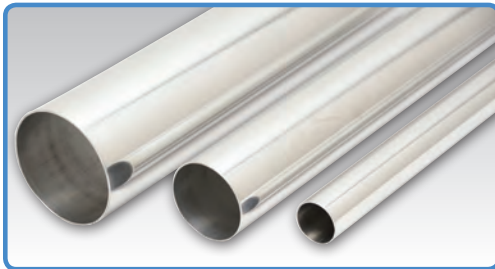

Please note: Overall length tolerance = +/- .2"

Tube O.D.	18" Long Part No.	5 foot Long Part No.
1 1/2"	2171	12171
1 3/4"	2172	12172
2"	2885	12885
2 1/4"	2888	12888
2 1/2"	2174	12174
2 3/4"	2882	12882
3"	2173	12173
3 1/2"	2892	12892
4"	2877	12877

## ALUMINUM TRANSITIONS

Vibrant Performance Aluminum Transitions allow for easy and cost effective reducing or expanding from one tubing size to another that will also look very professional. Ideal for applications where the fabricator prefers not to use silicone couplers. Requires minimal if any surface prep for TIG welding.



Part No.	Size	Overall Length
12061	2" x 2 1/2" Transition	3"
12064	2 1/2" x 2 3/4" Transition	3"
12065	2 1/2" x 3" Transition	3"
12067	3" x 3 1/2" Transition	3"
12069	3 1/2" x 4" Transition	3"

## MANUAL BEAD ROLLER

This sturdy and cost effective tool makes it easy to add a professional looking bead to all types of tubing.

Great for Aluminum up to 16 gauge wall thickness (0.065" or 1.65mm). Steel/Stainless Steel should be no thicker than 18 gauge (0.050" or 1.25mm).

Made from high quality steel and aluminum components, this assembly comes complete with everything you need straight out of the box, including a convenient carrying case. No extra tools are required.

Minimum tube diameter to use on this bead roller is 3/4" OD. It produces a bead that is approximately 2mm tall and 6.5mm wide.



Part No. 2990

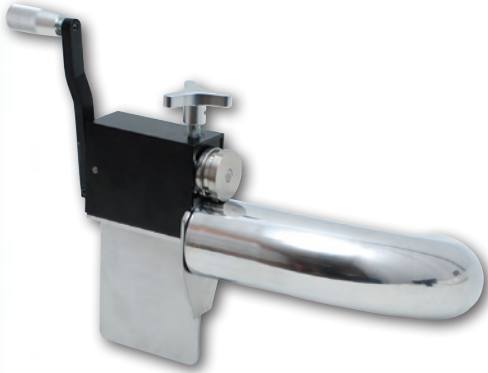

Makes bead rolling easy!

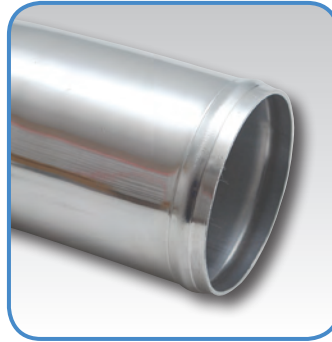

Produces a bead that is approx. 2mm tall and 6.5mm wide

## ALUMINUM JOINERS

Our T6061 Aluminum Joiners can come in handy in so many ways. They are especially useful for creating affordable custom silicone coupling combinations to suit your specific needs. Also commonly used for custom intercooler end tank fabrication or for welding hose inlets/outlets to aluminum radiators.



Part No.	Tube O.D.	Overall Length
12049	1 1/2"	3"
12048	1 3/4"	3"
12050	2"	3"
12051	2 1/4"	3"
12052	2 1/2"	3"
12053	2 3/4"	3"
12054	3"	3"
12055	3 1/2"	3"
12056	4"	3"



Create your own custom Silicone Couplers!

## TIGHT RADIUS 90° CAST ALUMINUM ELBOWS



Part No.	Elbow O.D.
2872	2"
2873	2 1/2"
2874	3"

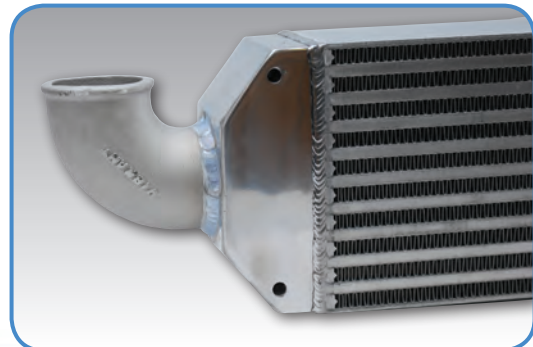

## AIR TO AIR INTERCOOLERS

Vibrant Air to Air Intercoolers feature heavy duty Bar and Plate construction that delivers maximum cooling efficiency while minimizing pressure drop. Their strength and durability make them capable of handling even the most extreme race applications. Traditional Tube and Fin intercoolers can have limited cooling capacity. Our Bar & Plate Intercoolers deliver significantly cooler, denser air to your engine, reducing the likelihood of detonation and maximizing your turbo's potential.

Vibrant Intercoolers are available with and without tig welded cast aluminum end tanks. All intercoolers with end tanks are pressure tested to ensure a leak free assembly.

### INTERCOOLERS - COMPLETE ASSEMBLY WITH END TANKS

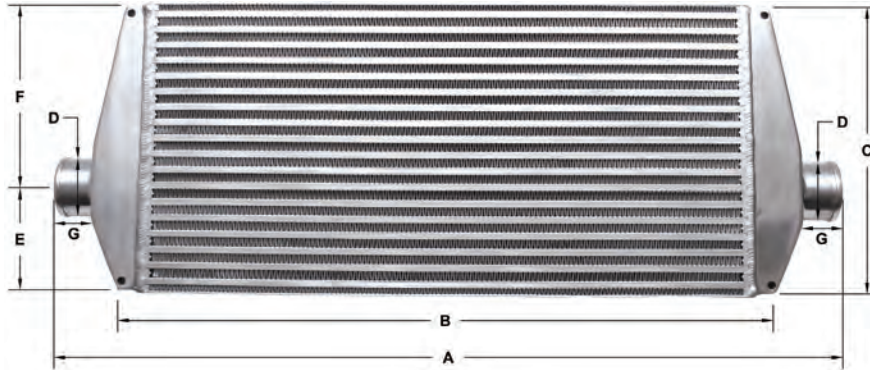

Our complete assemblies include a pair of Stainless Steel "Easy Mount" brackets (with required hardware), which bolt onto the end tanks to make mounting the intercooler easy.

Part No.	HP Rating	Core Thickness	Overall Width A	Core Width B	Height C	Inlet / Outlet D	E	F	G
12800	350 HP	3.25"	26.00"	20.00"	6.50"	2.50"	3.25"	3.25"	1.75"
12810	550 HP	3.25"	30.00"	24.00"	9.25"	2.50"	3.50"	5.75"	1.75"
12815	875 HP	3.50"	33.00"	27.00"	12.00"	3.00"	4.50"	7.50"	1.75"
12816	875 HP	3.50"	33.00"	27.00"	12.00"	2.50"	4.50"	7.50"	1.75"

### INTERCOOLERS - CORE ONLY (NO END TANKS)

Vibrant Performance now offers an expanded roster of Air to Air Intercooler Cores. Simply weld on your own custom end tanks and you are ready for the track!

Part No.	Core Width	Core Height	Core Thickness	HP Rating
12841	6.00"	11.80"	3.00"	200 HP
12830	17.75"	6.50"	3.25"	350 HP
12833	17.75"	9.85"	3.50"	515 HP
12834	17.75"	11.80"	4.50"	750 HP
12835	20.00"	11.00"	3.50"	600 HP
12836	22.00"	5.90"	3.50"	400 HP
12831	22.00"	9.25"	3.25"	550 HP
12837	22.00"	9.85"	4.00"	750 HP
12838	22.00"	11.80"	4.50"	900 HP
12839	24.00"	8.00"	3.50"	600 HP
12832	25.00"	11.80"	3.50"	875 HP
12840	27.50"	9.85"	4.50"	900 HP

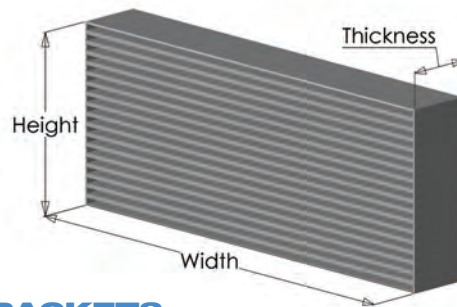
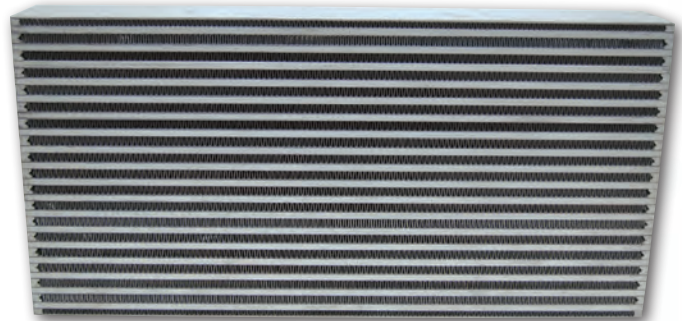

### STAINLESS STEEL "EASY MOUNT" BRACKETS



Part No.	Description
12827	Replacement "Easy Mount" Intercooler Brackets for Intercooler no. 12800
12828	Replacement "Easy Mount" Intercooler Brackets for Intercooler no. 12810
12829	Replacement "Easy Mount" Intercooler Brackets for Intercooler no. 12815

## VANJEN CLAMPING SYSTEM

The VanJen Clamping System is the ultimate in flexible, banded clamp connector solutions.

Constructed entirely from T6061 Aluminum, and featuring a unique Quick Release clamping mechanism, the Vibrant VanJen Clamp provides a leak-free, modular connection that is ideal for pressurized air applications. Capable of withstanding up to 110 psi. operating pressure and temperatures up to 400 deg. F, the VanJen Clamping System is ideal for turbo intake plumbing.

The VanJen Clamping System consists of 2 Weld Fittings (with O-Rings), one Union Sleeve, a safety pin and a spring loaded Clamp assembly designed specifically for automotive use. Once the fittings are welded to the tubing, the union sleeve houses the fittings and is held in place by the clamp assembly. Once assembled, the VanJen Clamping System provides a flexible connection that can withstand vibration, movements along its axis, lateral misalignment and angular deflection (up to 12 deg.).

Fittings, Union Sleeves and Clamps can also be purchased as separate components. Please refer to application charts on Page 13.



Photo courtesy of Javier Herrera



## VANJEN CLAMP - COMPLETE ASSEMBLY



- Each VANJEN Clamp Assembly includes:
- One (1), Quick Release Clamp (with safety pin)
  - One Pair, Aluminum Weld Fittings
  - One (1), Hard Anodized Aluminum Union Sleeve

Part No.	Description
12505	Full Assembly for 2-1/2" O.D. Tubing
12506	Full Assembly for 3" O.D. Tubing
12507	Full Assembly for 3-1/2" O.D. Tubing
12508	Full Assembly for 4" O.D. Tubing

## QUICK RELEASE CLAMP



Part No.	Description
12525	Quick Release Clamp for 2-1/2" O.D. Tubing
12526	Quick Release Clamp for 3" O.D. Tubing
12527	Quick Release Clamp for 3-1/2" O.D. Tubing
12528	Quick Release Clamp for 4" O.D. Tubing

## HARD ANODIZED ALUMINUM UNION SLEEVE



Part No.	Description
12565	Union Sleeve for 2-1/2" O.D. Tubing
12566	Union Sleeve for 3" O.D. Tubing
12567	Union Sleeve for 3-1/2" O.D. Tubing
12568	Union Sleeve for 4" O.D. Tubing

## ALUMINUM WELD FITTINGS



Part No.	Description	Matching O-Ring Part No.
12545	Aluminum Weld Fittings for 2-1/2" O.D. Tubing	12545R
12546	Aluminum Weld Fittings for 3" O.D. Tubing	12546R
12547	Aluminum Weld Fittings for 3-1/2" O.D. Tubing	12547R
12548	Aluminum Weld Fittings for 4" O.D. Tubing	12548R

## QUICK RELEASE BOOST BRACE

Vibrant Performance Quick Release Boost Brace eliminates the risk of having your pressurized pipe assemblies pulling apart from your silicone connectors under high boost.

This fully adjustable T6061 Aluminum brace is available with radiused mounts for simplified welding. The quick release feature allows you to easily disconnect the brace from the mounts when necessary.

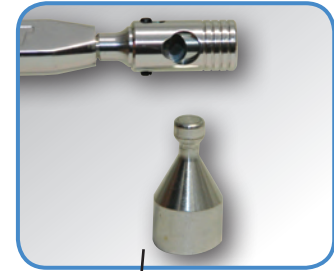

Boost Brace can be quick released from mounting tabs

Part No.	Description
12640	Quick Release Boost Brace Assembly with Aluminum Mounting Tabs - Polished
12642	Pair of Aluminum mounting tabs

## 4-PLY REINFORCED SILICONE CONNECTORS

Vibrant Performance Reinforced Silicone Connectors are hand wrapped and feature 4-ply reinforcement, which allows our hoses to be capable of withstanding extreme temperatures and heavy duty pressure conditions without swelling or bursting.

All Vibrant Performance reinforced hoses meet or exceed SAE J20 specifications, are suitable for coolant service and are UV and Ozone resistant. Not suitable for oil or fuel service, although custom hose solutions are available for such applications.

Available in 3", 12" and 36" long straight sections, transition hoses, hump hoses, 45 and 90 deg. elbows as well as transition elbows, and in a wide variety of Hose ID sizing.

Rated for temperatures ranging from -65 deg. F to 350 deg. F.

## 4-PLY SILICONE STRAIGHT HOSE COUPLINGS - 3 INCH LENGTHS

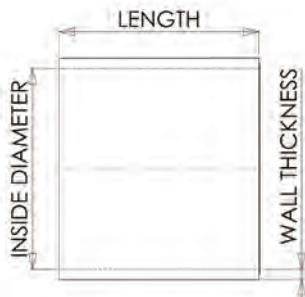

Hose Size (I.D.)	Overall Length	Wall Thickness +/- 0.02"	Burst Strength	Black Part No.	Blue Part No.	Red Part No.
1.00"	3"	0.18"	140 psi	2700	2700B	2700R
1.25"	3"	0.18"	130 psi	2726	2726B	2726R
1.50"	3"	0.18"	120 psi	2702	2702B	2702R
1.75"	3"	0.18"	110 psi	2704	2704B	2704R
2.00"	3"	0.18"	100 psi	2706	2706B	2706R
2.25"	3"	0.18"	90 psi	2708	2708B	2708R
2.50"	3"	0.18"	80 psi	2710	2710B	2710R
2.75"	3"	0.18"	70 psi	2712	2712B	2712R
3.00"	3"	0.18"	60 psi	2714	2714B	2714R
3.25"	3"	0.18"	40 psi	2720	2720B	2720R
3.50"	3"	0.18"	40 psi	2716	2716B	2716R
4.00"	3"	0.18"	40 psi	2718	2718B	2718R
4.50"	3"	0.18"	40 psi	2722	2722B	2722R
5.00"	3"	0.18"	40 psi	2724	2724B	2724R

## 4-PLY SILICONE STRAIGHT HOSE COUPLINGS - 12 INCH LENGTHS

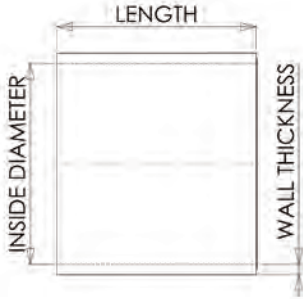

Hose Size (I.D.)	Overall Length	Wall Thickness +/- 0.02"	Burst Strength	Black Part No.	Blue Part No.	Red Part No.
1.00"	12"	0.18"	140 psi	27011	27011B	27011R
1.25"	12"	0.18"	130 psi	27271	27271B	27271R
1.50"	12"	0.18"	120 psi	27031	27031B	27031R
1.75"	12"	0.18"	110 psi	27051	27051B	27051R
2.00"	12"	0.18"	100 psi	27071	27071B	27071R
2.25"	12"	0.18"	90 psi	27091	27091B	27091R
2.50"	12"	0.18"	80 psi	27111	27111B	27111R
2.75"	12"	0.18"	70 psi	27131	27131B	27131R
3.00"	12"	0.18"	60 psi	27151	27151B	27151R
3.25"	12"	0.18"	40 psi	27211	27211B	27211R
3.50"	12"	0.18"	40 psi	27171	27171B	27171R
4.00"	12"	0.18"	40 psi	27191	27191B	27191R
4.50"	12"	0.18"	40 psi	27231	27231B	27231R
5.00"	12"	0.18"	40 psi	27251	27251B	27251R

## 4-PLY SILICONE STRAIGHT HOSE COUPLINGS - 36 INCH LENGTHS

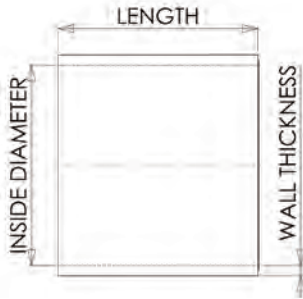
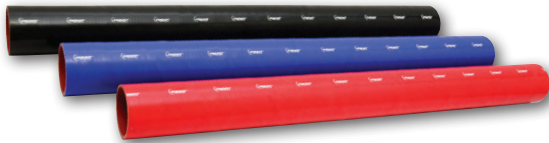

Hose Size (I.D.)	Overall Length	Wall Thickness +/- 0.02"	Burst Strength	Black Part No.	Blue Part No.	Red Part No.
1.00"	36"	0.18"	140 psi	2701	2701B	2701R
1.25"	36"	0.18"	130 psi	2727	2727B	2727R
1.50"	36"	0.18"	120 psi	2703	2703B	2703R
1.75"	36"	0.18"	110 psi	2705	2705B	2705R
2.00"	36"	0.18"	100 psi	2707	2707B	2707R
2.25"	36"	0.18"	90 psi	2709	2709B	2709R
2.50"	36"	0.18"	80 psi	2711	2711B	2711R
2.75"	36"	0.18"	70 psi	2713	2713B	2713R
3.00"	36"	0.18"	60 psi	2715	2715B	2715R
3.25"	36"	0.18"	40 psi	2721	2721B	2721R
3.50"	36"	0.18"	40 psi	2717	2717B	2717R
4.00"	36"	0.18"	40 psi	2719	2719B	2719R
4.50"	36"	0.18"	40 psi	2723	2723B	2723R
5.00"	36"	0.18"	40 psi	2725	2725B	2725R

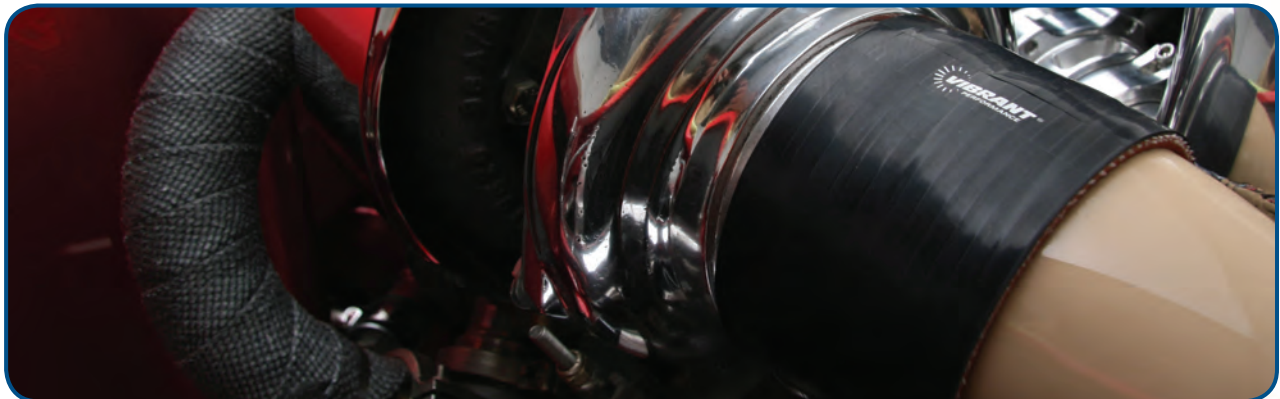

## 4-PLY SILICONE HUMP HOSE COUPLINGS

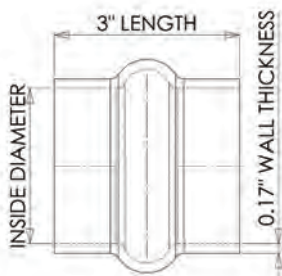

Hose Size (I.D.)	Burst Strength	Black Part No.	Blue Part No.	Red Part No.
1.50"	120 psi	2729	2729B	2729R
1.75"	110 psi	2728	2728B	2728R
2.00"	100 psi	2730	2730B	2730R
2.25"	90 psi	2731	2731B	2731R
2.50"	80 psi	2732	2732B	2732R
2.75"	70 psi	2733	2733B	2733R
3.00"	60 psi	2734	2734B	2734R
3.25"	40 psi	2737	2737B	2737R
3.50"	40 psi	2735	2735B	2735R
4.00"	40 psi	2736	2736B	2736R
4.50"	40 psi	2738	2738B	2738R
5.00"	40 psi	2739	2739B	2739R

## 4-PLY SILICONE TRANSITION HOSE COUPLINGS

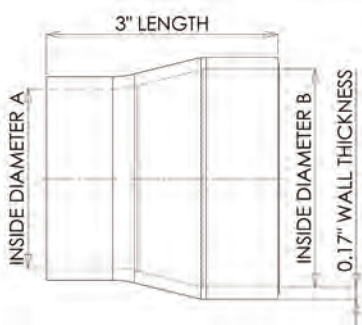

Hose Size (I.D.) "A"	Hose Size (I.D.) "B"	Burst Strength	Black Part No.	Blue Part No.	Red Part No.
1.50"	1.75"	110 psi	2762	2762B	2762R
1.50"	2.00"	100 psi	2763	2763B	2763R
1.75"	2.00"	100 psi	2767	2767B	2767R
1.75"	2.50"	80 psi	2838	2838B	2838R
2.00"	2.25"	90 psi	2765	2765B	2765R
2.00"	2.50"	80 psi	2766	2766B	2766R
2.00"	2.75"	70 psi	2778	2778B	2778R
2.00"	3.00"	60 psi	2779	2779B	2779R
2.25"	2.50"	80 psi	2768	2768B	2768R
2.25"	2.75"	70 psi	2769	2769B	2769R
2.25"	3.00"	60 psi	2770	2770B	2770R
2.50"	2.75"	70 psi	2771	2771B	2771R
2.50"	3.00"	60 psi	2772	2772B	2772R
2.50"	3.25"	40 psi	2761	2761B	2761R
2.50"	3.50"	40 psi	2764	2764B	2764R
2.75"	3.00"	60 psi	2773	2773B	2773R
3.00"	3.25"	40 psi	2760	2760B	2760R
3.00"	3.50"	40 psi	2774	2774B	2774R
3.00"	4.00"	40 psi	2775	2775B	2775R
3.25"	3.50"	40 psi	2835	2835B	2835R
3.25"	4.00"	40 psi	2839	2839B	2839R
3.50"	4.00"	40 psi	2776	2776B	2776R
3.50"	4.50"	40 psi	2836	2836B	2836R
4.00"	4.50"	40 psi	2837	2837B	2837R
4.00"	5.00"	40 psi	2777	2777B	2777R



## 4-PLY 90° SILICONE ELBOWS

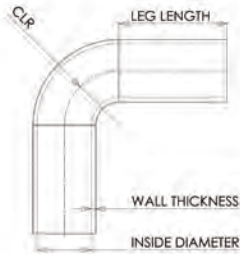

Hose Size (I.D.)	CLR	Leg Length +/- 0.25"	Wall Thickness +/- 0.02"	Burst Strength	Black Part No.	Blue Part No.	Red Part No.
1.50"	1.50"	4"	0.18"	120 psi	2749	2749B	2749R
1.75"	1.75"	4"	0.18"	110 psi	2843	2843B	2843R
2.00"	2.00"	4"	0.18"	100 psi	2740	2740B	2740R
2.25"	2.25"	4"	0.18"	90 psi	2741	2741B	2741R
2.50"	2.50"	4"	0.18"	80 psi	2742	2742B	2742R
2.75"	2.75"	4"	0.18"	70 psi	2743	2743B	2743R
3.00"	3.00"	4"	0.18"	60 psi	2744	2744B	2744R
3.25"	3.25"	3.5"	0.18"	40 psi	2747	2747B	2747R
3.50"	3.50"	3.5"	0.18"	40 psi	2745	2745B	2745R
4.00"	4.00"	3"	0.18"	40 psi	2746	2746B	2746R
4.50"	4.50"	3"	0.18"	40 psi	2748	2748B	2748R

## 4-PLY 45° SILICONE ELBOWS

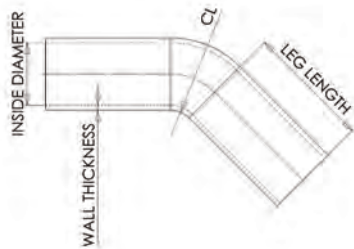

Hose Size (I.D.)	CLR	Leg Length +/- 0.25"	Wall Thickness +/- 0.02"	Burst Strength	Black Part No.	Blue Part No.	Red Part No.
1.50"	1.50"	5"	0.18"	120 psi	2759	2759B	2759R
1.75"	1.75"	5"	0.18"	110 psi	2854	2854B	2854R
2.00"	2.00"	5"	0.18"	100 psi	2750	2750B	2750R
2.25"	2.25"	5"	0.18"	90 psi	2751	2751B	2751R
2.50"	2.50"	5"	0.18"	80 psi	2752	2752B	2752R
2.75"	2.75"	5"	0.18"	70 psi	2753	2753B	2753R
3.00"	3.00"	4.5"	0.18"	60 psi	2754	2754B	2754R
3.25"	3.25"	4.5"	0.18"	40 psi	2757	2757B	2757R
3.50"	3.50"	4.5"	0.18"	40 psi	2755	2755B	2755R
4.00"	4.00"	4.25"	0.18"	40 psi	2756	2756B	2756R
4.50"	4.50"	4.25"	0.18"	40 psi	2758	2758B	2758R

## 4-PLY 90° SILICONE TRANSITION ELBOWS

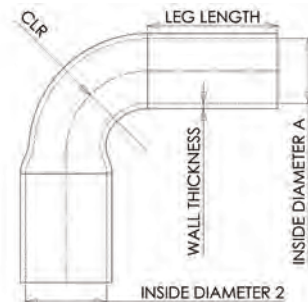

Hose Size (I.D.) "A"	Hose Size (I.D.) "B"	CLR	Leg Length +/- 0.25"	Wall Thickness +/- 0.02"	Burst Strength	Black Part No.	Blue Part No.	Red Part No.
2.00"	2.50"	2.50"	4.5"	0.18"	80 psi	2780	2780B	2780R
2.50"	2.75"	2.75"	3.5"	0.18"	70 psi	2781	2781B	2781R
2.50"	3.00"	3.00"	3.5"	0.18"	60 psi	2782	2782B	2782R
2.75"	3.00"	3.00"	3.5"	0.18"	60 psi	2783	2783B	2783R
3.00"	4.00"	4.00"	4"	0.18"	40 psi	2785	2785B	2785R

# ARAMID REINFORCED SILICONE CONNECTORS

Due to popular demand, Vibrant Performance offers a selection of Ultra High Performance multi-ply Aramid reinforced silicone connectors for use on high temperature and high pressure applications. Suitable for boost, air and water applications, these hoses are capable of withstanding temperatures ranging from -65 deg. F to 500 deg. F. **Available in Matte Black only.**

## 4-PLY STRAIGHT CONNECTORS



Hose Size (I.D.)	Overall Length	Wall Thickness +/- 0.02"	Burst Strength	Part No.
2.00"	3"	0.18"	100 psi	11805
2.25"	3"	0.18"	90 psi	11806
2.50"	3"	0.18"	80 psi	11808
2.75"	3"	0.18"	70 psi	11809
3.00"	3"	0.18"	60 psi	11810
3.50"	3"	0.18"	40 psi	11812
4.00"	3"	0.18"	40 psi	11814
5.00"	3"	0.18"	40 psi	11816
6.00"	3"	0.18"	40 psi	11817

## 4-PLY HUMP HOSE CONNECTORS WITH REINFORCEMENT RINGS



Hose Size (I.D.)	Overall Length	Wall Thickness +/- 0.02"	Burst Strength	Part No.
3.00"	6"	0.18"	100 psi	11820
3.50"	6"	0.18"	100 psi	11821
4.00"	6"	0.18"	100 psi	11822

# NON REINFORCED SILICONE COUPLINGS

Vibrant Performance Non Reinforced Silicone Couplings are ideal for low pressure applications (not recommended for use in pressurized applications). Two stainless steel hose clamps are included with each coupling. **Available in Black only.**

## STRAIGHT SLEEVES



Hose Size (I.D.)	Overall Length	Part No.
3.00"	3"	12700
3.50"	3"	12701
4.00"	3"	12702

## TRANSITIONS



Hose Size (I.D.)	Overall Length	Part No.
2.25" x 3.00"	3"	12710
2.50" x 3.00"	3"	12711
3.00" x 3.50"	3"	12712
3.00" x 4.00"	3"	12713

## 90 DEG ELBOWS



Hose Size (I.D.)	Center Line Radius	Leg Length	Part No.
3.00"	3.50"	5"	12720
3.50"	4.00"	5"	12721
4.00"	4.50"	5"	12722

## STAINLESS STEEL T-BOLT CLAMPS

Vibrant Stainless Steel T-Bolt Clamps provide reliable, leak-proof connections for hose and tube assemblies. They offer superior tensile strength and durability compared to worm gear clamps. Complete 300-series Stainless Steel construction (including bolt and lock-nut) offers outstanding corrosion resistance, making them the perfect choice for medium and heavy-duty applications.

- Ideally suited for high boost applications
- Always use T-Bolt Clamps when clamping Vibrant Reinforced Silicone Couplings
- 3/4" (19mm) wide Stainless Steel Band
- Now featuring upgraded, heavier duty Stainless Steel Hardware
- Sold in Pairs

### TECH TIP

If you intend to loosen and re-tighten your T-Bolt Clamps regularly, applying anti-seize lubricant to the threads will improve service life.



Part No.	Clamping Range	Application	Quantity
2787	1.25" - 1.60"	for use with 1" I.D. hose couplings	2 clamps/pack
2788	1.49" - 1.84"	for use with 1 1/4" I.D. hose couplings	2 clamps/pack
2789	1.75" - 2.10"	for use with 1 1/2" I.D. hose couplings	2 clamps/pack
2790	2.00" - 2.30"	for use with 1 3/4" I.D. hose couplings	2 clamps/pack
2791	2.27" - 2.63"	for use with 2" I.D. hose couplings	2 clamps/pack
2792	2.53" - 2.75"	for use with 2 1/4" I.D. hose couplings	2 clamps/pack
2793	2.75" - 3.10"	for use with 2 1/2" I.D. hose couplings	2 clamps/pack
2794	3.01" - 3.25"	for use with 2 3/4" I.D. hose couplings	2 clamps/pack
2795	3.28" - 3.60"	for use with 3" I.D. hose couplings	2 clamps/pack
2803	3.50" - 3.80"	for use with 3 1/4" I.D. hose couplings	2 clamps/pack
2796	3.76" - 4.05"	for use with 3 1/2" I.D. hose couplings	2 clamps/pack
2798	4.20" - 4.60"	for use with 4" I.D. hose couplings	2 clamps/pack
2797	4.75" - 5.10"	for use with 4 1/2" I.D. hose couplings	2 clamps/pack
2799	5.30" - 5.60"	for use with 5" I.D. hose couplings	2 clamps/pack
2804	6.28" - 6.59"	for use with 6" I.D. hose couplings	2 clamps/pack

## STAINLESS STEEL WORM GEAR CLAMPS

Vibrant Stainless Steel Worm Gear Clamps are ideal for a wide variety of light to medium duty fastening applications like air intake kits and vacuum hoses (not recommended for heavy duty, high pressure applications).

These clamps feature 300 series Stainless Steel construction for outstanding corrosion resistance.



Part No.	Clamping Range	Band Width	Quantity
12150	0.25" - 0.63" (6mm - 16mm)	5/16" (8mm)	10 clamps/pack
12151	0.44" - 0.90" (11mm - 23mm)	1/2" (12.7mm)	10 clamps/pack
12152	0.75" - 1.50" (19mm - 38mm)	1/2" (12.7mm)	10 clamps/pack
12153	1.30" - 2.16" (33mm - 55mm)	1/2" (12.7mm)	10 clamps/pack
12154	2.04" - 3.00" (52mm - 76mm)	1/2" (12.7mm)	10 clamps/pack
12155	2.79" - 3.74" (71mm - 95mm)	1/2" (12.7mm)	10 clamps/pack
12156	3.54" - 4.49" (90mm - 114mm)	1/2" (12.7mm)	10 clamps/pack
12157	4.05" - 5.00" (103mm - 127mm)	1/2" (12.7mm)	10 clamps/pack
12158	4.56" - 5.51" (116mm - 140mm)	1/2" (12.7mm)	10 clamps/pack

## SILICONE HEATER HOSES

Vibrant Performance Nylon reinforced Silicone Heater Hose is very flexible and designed to withstand elevated temperatures (Temperature Range: -65°F to +300°F). Suitable for oil and coolant fluid service. Exceeds SAE J20R3 requirements.

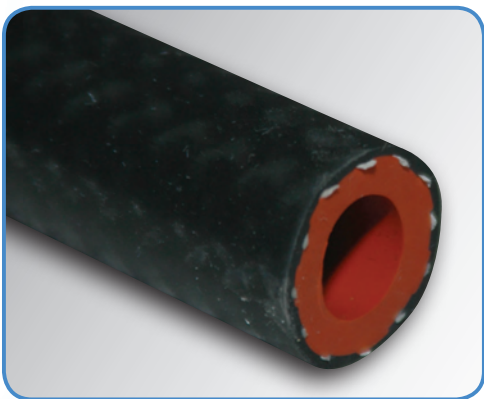

Hose Size (I.D.)	2 foot length Part No.	5 foot length Part No.	20 foot length Part No.	Color
1/4" (6mm)	20402	20405	2040	Gloss Black
5/16" (8mm)	20412	20415	2041	Gloss Black
3/8" (10mm)	20422	20425	2042	Gloss Black
1/2" (13mm)	20432	20435	2043	Gloss Black
5/8" (16mm)	20442	20445	2044	Gloss Black
3/4" (19mm)	20452	20455	2045	Gloss Black
7/8" (22mm)	20462	20465	2046	Gloss Black
1" (25mm)	20472	20475	2047	Gloss Black
1-1/4" (32mm)	20482	20485	2048	Gloss Black

## SILICONE VACUUM HOSES

Vibrant Performance Silicone Vacuum Hoses are designed to handle the extreme conditions found in high performance engines.

- Will not collapse under high vacuum operation
- Resists peeling, cracking and swelling, unlike inferior quality silicone vacuum hoses
- Meets SAE J20R3 specifications
- Available in convenient Pit Packs and Bulk Packs
- Offered in sizes ranging from 1/8" I.D. to 3/4" I.D.

### PIT PACKS

Vibrant Silicone Vacuum Hose Pit Packs include:

- 5 feet of 1/8" (3.2mm) hose
- 10 feet of 5/32" (3.75mm) hose
- 4 feet of 3/16" (4.5mm) hose
- 4 feet of 1/4" (6mm) hose
- 2 feet of 3/8" (10mm) hose

Part No.	Color
2104	Black
2104B	Blue
2104R	Red



2104B



2104R



2104



### BULK PACKS

Hose Diameter (I.D.)	Quantity	Black Part No.	Blue Part No.	Red Part No.
1/8" (3.2mm)	50 feet	2100	2100B	2100R
5/32" (3.75mm)	50 feet	2101	2101B	2101R
3/16" (4.5mm)	25 feet	2102	2102B	2102R
1/4" (6mm)	25 feet	2103	2103B	2103R
5/16" (8mm)	10 feet	2106	2106B	2106R
3/8" (10mm)	10 feet	2107	2107B	2107R
3/4" (19mm)	10 feet	2108	2108B	2108R

\*\* Please Note: Other colors are available by special order. Minimum order quantity for special orders is 500 feet per size. Contact us for more information.

# MASS AIR FLOW SENSOR ADAPTERS

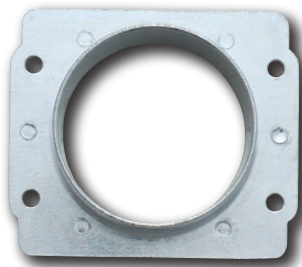

**Part No. 1994**  
**Application:** M.A.F. Adapter for Subaru vehicles

Dimensions				
A	B	C	D	E
4.33"	3.65"	3.73"	2.00"	3.00"
110.2mm	92.8mm	94.7mm	51mm	76.2mm

\* Accepts Vibrant Air Filter part no. 10923, 10930 or 2160C

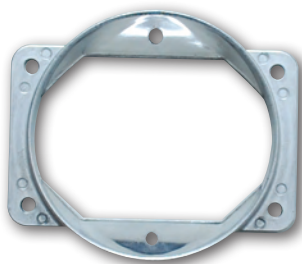
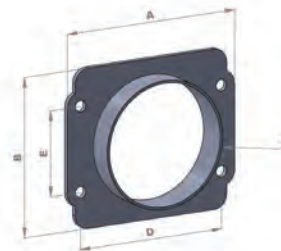

**Part No. 1995**  
**Application:** M.A.F. Adapter for Mitsubishi vehicles

Dimensions						
A	B	C	D	E	F	G
5.25"	3.32"	4.50"	4.43"	2.51"	2.65"	1.20"
133mm	84.5mm	115mm	112.7mm	63.9mm	67.4mm	30.6mm

\* Accepts Vibrant Air Filter part no. 10926 or 2161C

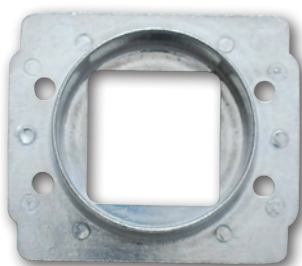
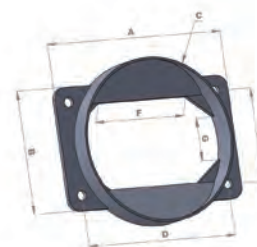

**Part No. 1996**  
**Application:** M.A.F. Adapter for Toyota vehicles and vehicles equipped with Bosch M.A.F. sensor.

Dimensions						
A	B	C	D	E	F	G
4.33"	3.73"	3.00"	3.27"	1.41"	1.95"	1.96"
110.2mm	94.7mm	76.2mm	83.1mm	35.9mm	49.6mm	49.8mm

\* Accepts Vibrant Air Filter part no. 10923, 10930 or 2160C

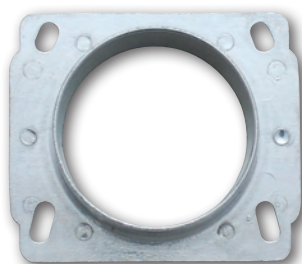
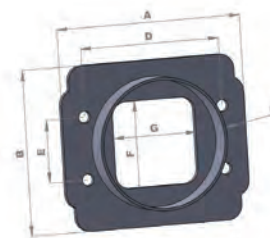

**Part No. 1997**  
**Application:** M.A.F. Adapter for Nissan vehicles.

Dimensions					
A	B	C	D	E	F
4.33"	3.73"	3.00"	3.41"	2.80"	3.20"
110.2mm	94.7mm	76.2mm	86.7mm	71.3mm	81.4mm

\* Accepts Vibrant Air Filter part no. 10923, 10930 or 2160C

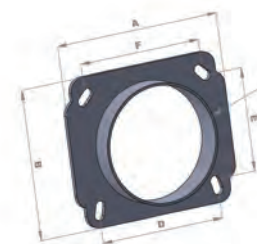

**Part No. 1998**  
**Application:** M.A.F. Adapter for the following vehicles:  
 1993-96 Nissan Altima, 1988-95 Nissan 240SX,  
 1991-94 Nissan Sentra SE-R,  
 1993-96 Nissan 200SX, 1993-98 Ford Probe SE,  
 1994-02 Ford Mustang V6, 1989-94 Suzuki Swift,  
 Audi 2.8L V6 (with AAH & AFC engine codes)

Dimensions					
A	B	C	D	E	F
4.00"	3.69"	3.00"	3.31"	2.63"	3.26"
101.6mm	93.7mm	76.2mm	84.1mm	66.8mm	82.9mm

\* Accepts Vibrant Air Filter part no. 10923, 10930 or 2160C

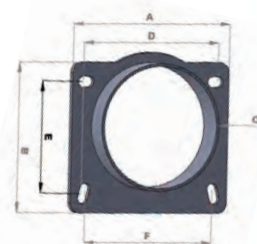

# ALUMINUM BELLMOUTH VELOCITY STACKS

Vibrant Performance high efficiency Bellmouth-style Velocity Stacks are ideal for All Motor and Forced Induction race applications. They allow for less turbulent air to enter your engine, resulting in dramatic airflow improvements and ultimately significant torque and horsepower gains. Also reduces turbo lag. Spun from 1/8" thick T6061 Aluminum Alloy.



Part No.	Inlet O.D.	Bellmouth O.D.	Matching Air Filter
10950	2 1/2"	6"	10960
10951	3"	6"	10960
10952	3 1/2"	6"	10960
10953	4"	7"	10961
10954	5"	8 3/4"	N/A

## CLASSIC AIR FILTERS FOR BELLMOUTH VELOCITY STACKS

Part No.	Inlet I.D.	Filter Cap O.D.	Filter Base O.D.	Overall Height	Filter Cap Color	Note
10960	6"	5"	7 1/2"	5 1/4"	Black	For use on Part No. 10950, 10951 and 10952 only
10961	7"	5"	8 1/4"	8 1/2"	Black	For use on Part No. 10953

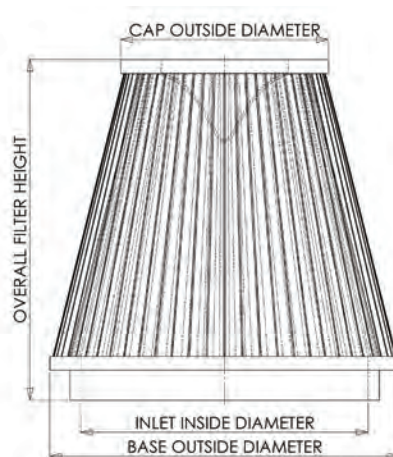

## “THE CLASSIC” PERFORMANCE AIR FILTERS

Vibrant Performance “Classic Filters” feature a 4 ply pleated cotton-gauze element that allows for significantly more airflow than a stock filter while providing excellent filtration of airborne particulate. Each filter is pre-oiled, and is washable and reusable. It is recommend that the filter element is cleaned every 10,000-15,000 miles (more frequent cleaning may be necessary depending on conditions). These filters are covered by a Limited Lifetime Warranty and are made in the USA.



### STANDARD CLASSIC FILTERS

Part No.	Inlet I.D.	Filter Cap O.D.	Filter Base O.D.	Overall Height	Filter Cap Color
10920	2 1/4"	5"	6"	6 1/4"	Black
10921	2 1/2"	5"	6"	6 1/4"	Black
10922	2 3/4"	5"	6"	6 1/4"	Black
10923	3"	5"	6"	6 1/4"	Black
10924	3 1/2"	5"	6"	6 1/4"	Black
10925	4"	5"	6"	6 1/4"	Black
10926	4 1/2"	5"	5 1/2"	6 1/4"	Black

### SHORTY CLASSIC FILTERS FOR TURBO INLETS

These compact filters are perfect for use on engine bays where space is limited. Actual filter Element Height (not including neck) is 3-5/8".

Part No.	Inlet I.D.	Filter Cap O.D.	Filter Base O.D.	Overall Height	Filter Cap Color
10930	3"	5"	5 1/2"	4-1/4"	Black
10931	4"	5"	5 1/2"	4-1/4"	Black
10932	5"	5"	5 1/2"	4-1/4"	Black



#### TECH TIP

Our Classic Series Air Filters feature an inverted cone end cap that permits more efficient airflow.

## “OPEN FUNNEL” PERFORMANCE AIR FILTERS

Vibrant Performance “Open Funnel” Air Filters feature an inverted cap design which increases the filter surface area for improved air flow and excellent filtration of airborne particulate. These filters are covered by a 50,000 mile Limited Warranty.

Please note: Open Funnel filters are not intended for turbo use.

Part No.	Inlet I.D.	Filter Cap O.D.	Filter Base O.D.	Overall Height	Filter Cap Color
1921C	2 1/2"	4 3/4"	6"	6 1/2"	Chrome
1923C	2 3/4"	4 3/4"	6"	6 1/2"	Chrome
2160C	3"	4 3/4"	6"	6 1/2"	Chrome
2161C	4 1/2"	4 3/4"	6"	6 1/2"	Chrome



## CRANKCASE BREATHER FILTERS (CLAMP ON)

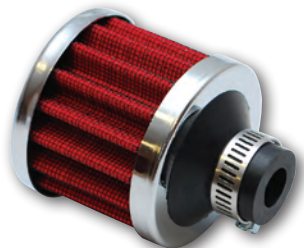

Part No.	Inlet I.D.	Filter Cap O.D.	Overall Height
2165	3/8" (9mm)	2 1/8" (55mm)	2 5/8" (68mm)
2167	1/2" (12mm)	2 1/8" (55mm)	2 5/8" (68mm)
2166	5/8" (15mm)	2 1/8" (55mm)	2 5/8" (68mm)
2164	3/4" (19mm)	2 1/8" (55mm)	2 5/8" (68mm)
2168	1" (25mm)	2 1/8" (55mm)	2 5/8" (68mm)

## ALUMINUM VACUUM MANIFOLD

Vibrant's popular Aluminum Vacuum Manifold allows for consistent vacuum from a single source to be distributed through up to 6 ports to support all your accessories.

We include all necessary mounting hardware for simplified installation.

All ports come with plugs pre-installed.

We recommend using Vibrant Pneumatic Fittings with this Vacuum Manifold (please refer to pg. 25)

**Manifold Dimensions:**  
5 1/2" long x 1 1/2" wide 1" tall

**Port Details:**  
6 ports threaded for 1/8" NPT fittings  
Center port threaded for 3/8" NPT fittings



Part No.	Description
2690	Vacuum Manifold - Anodized Silver
2691	Vacuum Manifold - Anodized Black

## ALUMINUM VACUUM LINE FITTINGS - SOFT MOUNT

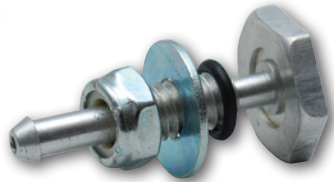

Part No. 12890

Vibrant Performance Soft Mount Vacuum Line fittings are designed to be inserted into a silicone connector and are guaranteed not to leak. Simply punch an 8mm hole into the silicone connector and install the fitting kit (as shown below). Quick and Easy!

Each kit includes a CNC machined aluminum fitting, lock nut, washer and O-Ring seal.

For use with Vibrant Performance 5/32" I.D. vacuum hoses. Please refer to page 20 for Silicone vacuum lines and page 25 for polyethylene vacuum lines.



## ALUMINUM VACUUM LINE FITTINGS - HARD MOUNT

Vibrant Performance makes it easy to add vacuum line fittings to your tubing.

Simply select the proper fitting for your application, drill an appropriately sized hole into your tubing and pop in the grommet and fitting. Requires no welding.

Use with Vibrant Performance Vacuum Hose. Please refer to page 20 for Silicone vacuum lines and page 25 for polyethylene vacuum lines.



Part No.	Description
2895	10mm O.D. Fitting with rubber grommet
2896	16mm O.D. Fitting with rubber grommet
2897	19mm O.D. Fitting with rubber grommet



# PNEUMATIC (ONE - TOUCH) VACUUM FITTINGS

Vibrant Performance "One Touch" fittings allow for simple and secure tubing connections. These fittings are suitable for both ambient and pressurized air, up to 150 psi and are virtually impossible to pull apart when inserted properly in the fitting. Your vacuum tubing quickly disconnects from the fitting by simply pushing down on the release collar. No need for hose clamps or zip ties to secure lines! All threads are PTFE coated.

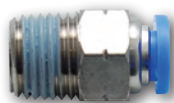

**MALE STRAIGHT**

Part No.	Tube Size (OD)	Thread
2660	5/32" (4mm)	1/8" NPT
2662	1/4" (6mm)	1/8" NPT
2664	1/4" (6mm)	1/4" NPT
2661	3/8" (9.5mm)	1/8" NPT
2663	3/8" (9.5mm)	1/4" NPT



**UNION Y**

Part No.	Tube Size (OD)
2680	5/32" (4mm)
2682	1/4" (6mm)
2681	3/8" (9.5mm)



**UNION STRAIGHT**

Part No.	Tube Size (OD)
16200	1/4" (6mm)

Nickel Plated Brass Construction



**MALE 90 DEG ELBOW**

Part No.	Tube Size (OD)	Thread
2665	5/32" (4mm)	1/8" NPT
2667	1/4" (6mm)	1/8" NPT
2669	1/4" (6mm)	1/4" NPT
2655	1/4" (6mm)	3/8" NPT
2653	1/4" (6mm)	1/2" NPT
2666	3/8" (9.5mm)	1/8" NPT
2668	3/8" (9.5mm)	1/4" NPT



**UNION STRAIGHT**

Part No.	Tube Size (OD)
2670	5/32" (4mm)
2672	1/4" (6mm)
2671	3/8" (9.5mm)



**UNION T**

Part No.	Tube Size (OD)
16203	1/4" (6mm)

Nickel Plated Brass Construction



**UNION T**

Part No.	Tube Size (OD)
2675	5/32" (4mm)
2677	1/4" (6mm)
2676	3/8" (9.5mm)



**FIREWALL FITTING**

Part No.	Tube Size (OD)
16204	1/4" (6mm)

Nickel Plated Brass Construction

## POLYETHYLENE TUBING

Perfect for air lines and instrumentation. Withstands up to 100 PSI and temperatures up to 140 deg. F.

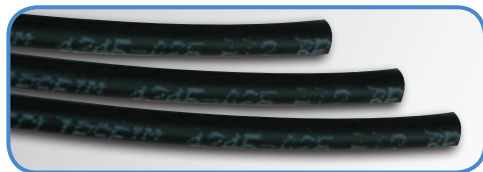

Part No.	O.D. Tube Size	Quantity	Color
2650	5/32" (4mm)	10 ft.	Black
2652	1/4" (6mm)	10 ft.	Black
2651	3/8" (9.5mm)	10 ft.	Black

## HIGH TEMP VACUUM LINE KITS

High temperature Vacuum Line Kits are ideal for use on forced induction and naturally aspirated applications

- All-metal Nickel-plated Pneumatic Brass Fittings
- PTFE hose designed to withstand extreme temperatures
- PTFE specs: -292°F to 500°F @ 100psi, withstands cryogenic to 700°F+

Part No.	Description
17400	All Purpose Kit (includes 10ft of 1/4" O.D. Polyurethane Hose, 10ft of 1/4" O.D. High Temp PTFE Hose and Pneumatic Fittings)
17402	High Temperature Vacuum Line Kit (includes 10ft of 1/4" O.D. White High Temp PTFE Hose and High Temp Pneumatic Fittings)
17431W	5 foot length of 1/4" O.D. High Temp PTFE Hose - White
17430W	10 foot length of 1/4" O.D. High Temp PTFE Hose - White



Part No. 17400

# MANUAL BOOST CONTROLLER

"Turning Up The Boost" has proven to be one of the easiest and most cost effective ways to squeeze more horsepower and torque from your turbocharged vehicle.

Vibrant Performance has developed a Manual Boost Controller that is lightweight, very compact and features a unique integrated dial that allows you to precisely set boost. It virtually eliminates the risk of "overboosting" which can occur with many other Manual Controllers.

These boost controllers are CNC machined from T6061 billet aluminum and premium grade brass. We include an adjustment key (which you can carry around on your keychain) to make it easy to turn the dial. We also include 18 inches of silicone vacuum hose, zip ties and installation instructions.



Part No.	Description
16900	Manual Boost Controller (Black Anodized)



Installation Diagram

### IMPORTANT TECHNICAL INFORMATION

The Vibrant Performance Manual Boost Controller is a "BLEED-OFF" style MBC. As such, it disperses excess pressure as needed to output your desired boost level, up to a maximum of 30% more than your factory wastegate spring setting.

Upgrade boost accuracy and prevent possible leaks with Vibrant pneumatic one-touch vacuum fittings (see page 25).

Keep your boost reference line reasonably short if using the supplied silicone hose to connect between reference points.

High heat and high boost environments can cause line expansion and false feedback, especially if reference lines are too long.

Keep supplied silicone hose away from heat sources. If it is impossible to locate these lines a safe distance from high heat sources, be sure to protect those hoses with Vibrant new "Heat Protect" Flexible Sleeving (page 58).

### CUT-AWAY VIEW



Our Manual Boost Controller includes a unique keyway for secure, end user only adjustment.

This feature eliminates a common issue that exists with most MBC's that utilize those bulky knobs that allow anyone to adjust your setting without your knowledge.

Fine threaded valve for very accurate boost adjustment

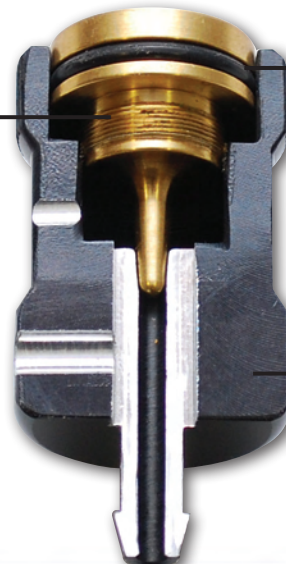

360 deg O-Ring Seal

Anodized finish to ensure little to no corrosion over time

## ALUMINUM BLOCK OFF PLATE FOR TD04 OEM TURBO

This T6061 Aluminum CNC Machined Block Off Plate will fit the following applications:

Mitsubishi MHI TD04HL1-12T /14T  
 Buick Regal 2.0t  
 Dodge Caliber - all years  
 Dodge Neon SRT-4 - all years  
 Chrysler PT Cruiser Turbo  
 Hyundai Genesis 2.0T  
 Renault Megane 225/230  
 Renault Megane RS 250  
 Volvo 850 T5  
 Volvo S40/V40 Turbo 1997-2004  
 Volvo S70/V70 Turbo

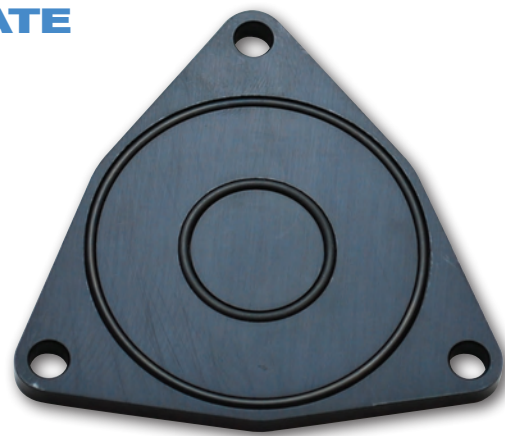

Part # 16120

## WELD-ON FLANGE ASSEMBLIES FOR BLOW OFF VALVES

Vibrant Performance makes it easy to weld Blow Off Valve Mating Flanges to your induction plumbing.

Each Blow Off Valve Flange Kit comes complete with a radiused weld fitting that is also threaded so that you can simply screw on the mating flange, which is very convenient if, down the road, you decide to switch BOVs. Simply thread off the old flange and thread on the appropriate flange to match your new BOV. These assemblies are also ideal for kit builders who offer their customers the option of choosing the BOV they want to use.

The Weld Fittings are available in your choice of T6061 Aluminum or Mild Steel construction. The Thread-On Fittings are made from T6061 Billet Aluminum. Each kit also includes an O-Ring for a leak free seal.



### WELD ON FLANGE KIT FOR HKS BOV

Part No. 1451 (Aluminum Weld Fitting / Aluminum Flange)  
 Part No. 1452 (Mild Steel Weld Fitting / Aluminum Flange)  
 Part No. 10127H (Aluminum Thread-On Replacement Flange)  
 Part No. 10127O (Replacement O-Ring)

### WELD ON FLANGE KIT FOR GREDDY BOV

Part No. 1453 (Aluminum Weld Fitting / Aluminum Flange)  
 Part No. 1454 (Mild Steel Weld Fitting / Aluminum Flange)  
 Part No. 10127G (Aluminum Thread-On Replacement Flange)  
 Part No. 10127O (Replacement O-Ring)

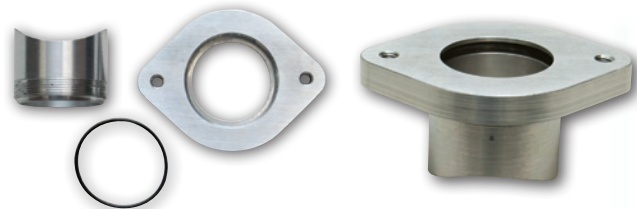

### WELD ON FLANGE KIT FOR TIAL STYLE BOV

Part No. 1477 (Aluminum Weld Fitting / Aluminum Flange)  
 Part No. 1478 (Mild Steel Weld Fitting / Aluminum Flange)  
 Part No. 10134 (Aluminum Thread-On Replacement Flange)  
 Part No. 10127O (Replacement O-Ring)

### WELD ON FLANGE KIT FOR SYNAPSE SYNCHRONIC BOV/DV

Part No. 1468 (Aluminum Weld Fitting / Aluminum Flange)  
 Part No. 1469 (Mild Steel Weld Fitting / Aluminum Flange)  
 Part No. 10135 (Aluminum Thread-On Replacement Flange)  
 Part No. 10127O (Replacement O-Ring)



## T304 STAINLESS STEEL SCHEDULE 10 PIPES

Vibrant Performance T304 Stainless Steel Schedule 10 Pipes are ideal for use in the construction of turbo exhaust manifolds and downpipe fabrication. The chamfered ends allow for easy butt welding.

We offer Long and Tight radius 90 degree elbows, 45 degree long radius elbows, T-pipes and 12" long straight sections.

**PLEASE NOTE:**

Pipes are normally identified by a Nominal Pipe Size (NPS) rather than Outside Diameter. Please refer to the "Actual I.D." and "Actual O.D." columns on the application list below to ensure you choose the correct pipes for your project.

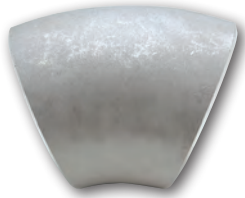

45° Elbow

Part No.	Nominal Pipe Size	Actual O.D.	Actual I.D.	C
2330	1 1/4"	42mm (1.65")	37mm (1.45")	1"
2331	1 1/2"	48mm (1.89")	42mm (1.65")	1.13"
2335	2 1/2"	76mm (3")	70mm (2.75")	1.75"
2336	3"	89mm (3.5")	83mm (3.25")	2"

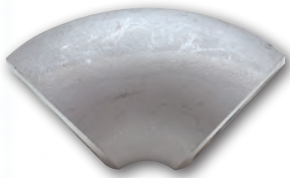
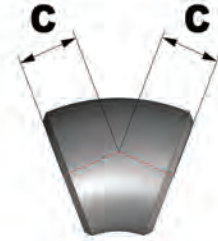

90° Tight radius elbow

Part No.	Nominal Pipe Size	Actual O.D.	Actual I.D.	A
2340	1 1/4"	42mm (1.65")	37mm (1.45")	1.25"
2341	1 1/2"	48mm (1.89")	42mm (1.65")	1.5"
2345	2 1/2"	76mm (3")	70mm (2.75")	2.5"
2346	3"	89mm (3.5")	83mm (3.25")	3"



90° Long radius elbow

Part No.	Nominal Pipe Size	Actual O.D.	Actual I.D.	B
2360	1 1/4"	42mm (1.65")	37mm (1.45")	1.88"
2361	1 1/2"	48mm (1.89")	42mm (1.65")	2.25"

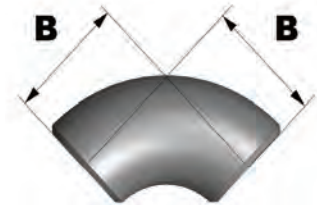

T-Pipe

Part No.	Nominal Pipe Size	Actual O.D.	Actual I.D.	D
2370	1 1/4"	42mm (1.65")	37mm (1.45")	1.88"
2371	1 1/2"	48mm (1.89")	42mm (1.65")	2.25"

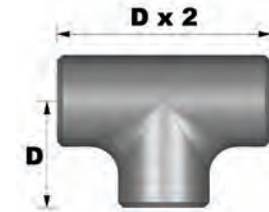

12" Straight Pipe

Part No.	Nominal Pipe Size	Actual O.D.	Actual I.D.	E
2350	1 1/4"	42mm (1.65")	37mm (1.45")	12"
2351	1 1/2"	48mm (1.89")	42mm (1.65")	12"



**TECH TIP**

Vibrant Performance now offers a large selection of Exhaust Manifold Flanges (Refer to page 60) with port dimensions that are optimized for use with Schedule 10 pipes, making it significantly easier to build your own turbo manifold.

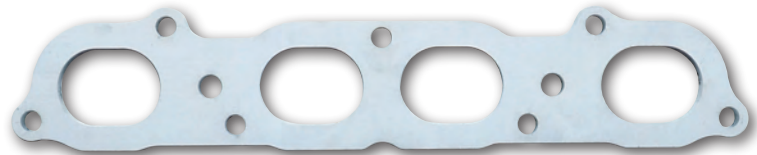

# TURBO MANIFOLD MERGE COLLECTORS

In many cases, the most time consuming part of fabricating a turbo manifold is building the merge collector. Vibrant Performance makes manifold fabrication easier and more cost effective with our large selection of Turbo Manifold Merge Collectors.

These collectors are made exclusively using T304 Stainless Steel Schedule 10 pipes for superior strength and durability and easy butt welding of primaries. Each pipe is precision 3D laser cut to create a proper merge for maximizing exhaust gas flow efficiency and minimizing turbulence. We tack weld each assembly so a fabricator can easily make adjustments if necessary.



## 4 INTO 1 COLLECTOR - SHORT



Part No.	Description	Pipe O.D.	Collector Height	Collector Outlet Size
2450	Designed to fit T25/T28 Inlet Flanges	1-5/8" 42mm	3" 76mm	2-1/4" x 1-3/4" 58mm x 45mm
2451	Designed to fit T3 and T3/T4 Inlet Flanges	1-7/8" 48mm	3" 76mm	2-7/8" x 1-7/8" 72mm x 48mm

## 4 INTO 1 COLLECTOR - TALL

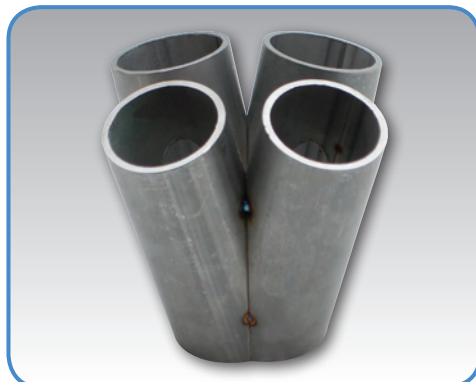

Part No.	Description	Pipe O.D.	Collector Height	Collector Outlet Size
2455	Designed to fit T25/T28 Inlet Flanges	1 7/8" 48mm	4-1/2" 115 mm	2-1/4" x 1-3/4" 58mm x 45mm
2454	Designed to fit T3 and T3/T4 Inlet Flanges	1 7/8" 48mm	4-1/2" 115 mm	2-7/8" x 1-7/8" 72mm x 48mm
2453	Designed to fit T4 Inlet Flanges	1 7/8" 48mm	4-3/4" 120 mm	3-1/16" x 2-1/2" 78mm x 64mm
2457	Designed to fit GT28/30/35 Tial Turbine Inlet Flanges	1 7/8" 48mm	4-1/2" 115 mm	2-1/8" dia. 54mm
2465	Designed to fit T3 Divided Inlet Flanges	1 7/8" 48mm	4-1/2" 115 mm	2-15/16" x 2-1/4" 74mm x 58mm
2466	Designed to fit T4 Divided Inlet Flanges	1 7/8" 48mm	4-1/2" 115 mm	2-15/16" x 2-1/4" 74mm x 58mm

## 6 INTO 1 COLLECTOR



Part No.	Description	Pipe O.D.	Collector Height	Collector Outlet Size
2456	Designed to fit T4 Inlet Flanges	1-7/8" 48mm	4-1/4" 110mm	2-15/16" x 2-1/4" 74mm x 58mm

### Outlet View

Each pipe is precision cut and assembled to produce a proper merge for maximum exhaust gas flow efficiency.



# TURBO FLANGES

Vibrant Performance offers a large assortment of Turbo Inlet and Discharge Flanges, Compressor Outlet Flanges, External Wastegate Flanges, Oil Feed and Oil Drain Flanges. Multi-layer metal gaskets are available for some of our flanges.

## TURBO INLET FLANGES



### T25 / T28 / GT25 Inlet Flange

- Also fits T2, GT28, GT25/40R
- 1/2" thick
- Tapped holes (M8 x 1.25)

T304SS Part No.	Mild Steel Part No.	Matching Gasket Part No.
1430	14300	1430G

Note: All dimensions listed in millimeters

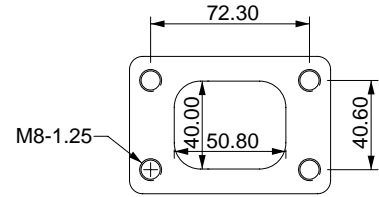

### T3 and T3/T4 Inlet Flange

- Also fits KKK K26/K27/K28 Turbos
- 1/2" thick
- Tapped holes (M10 x 1.5)

T304SS Part No.	Mild Steel Part No.	Matching Gasket Part No.
1431	14310	1431G

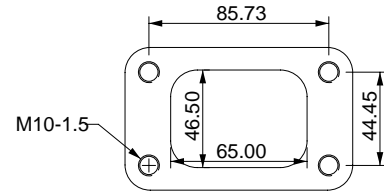

### GT30R/GT35R/GT40R Inlet Flange

- Designed to fit all Garrett T3 housings
- 1/2" thick
- Tapped holes (M10 x 1.5)

T304SS Part No.	Mild Steel Part No.	Matching Gasket Part No.
1400	14000	1400G

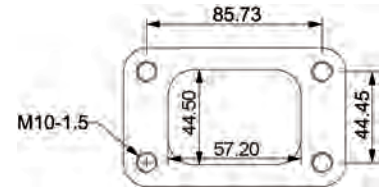

### T03 Inlet Flange - Divided

- 1/2" thick
- Tapped holes (M10 x 1.5)

T304SS Part No.	Mild Steel Part No.	Matching Gasket Part No.
1445	14450	1445G

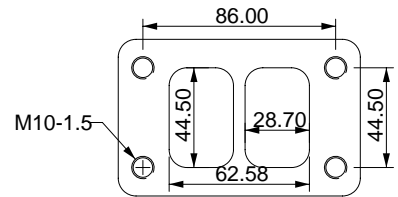

### T04 Inlet Flange

- 1/2" thick
- Drilled holes

T304SS Part No.	Mild Steel Part No.	Matching Gasket Part No.
1441	14410	1441G

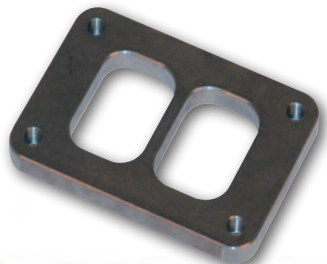
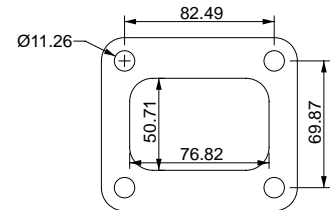

### T04 Inlet Flange - Divided

- 1/2" thick
- Tapped holes (M10 x 1.5)

T304SS Part No.	Mild Steel Part No.	Matching Gasket Part No.
1442	14420	1442G

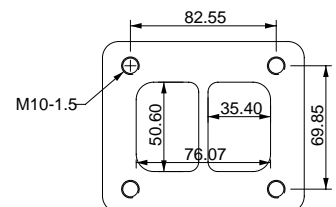



### **T06 Inlet Flange**

- 1/2" thick
- Tapped holes (M10 x 1.5)

T304SS Part No.	Mild Steel Part No.	Matching Gasket Part No.
1417	14170	1417G

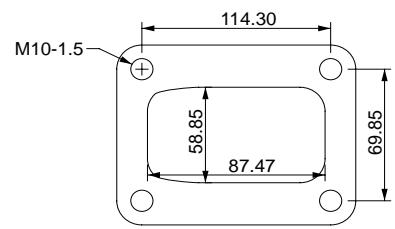

### **T06 Inlet Flange - Divided**

- 1/2" thick
- Tapped holes (M10 x 1.5)

T304SS Part No.	Mild Steel Part No.	Matching Gasket Part No.
1443	14430	1443G

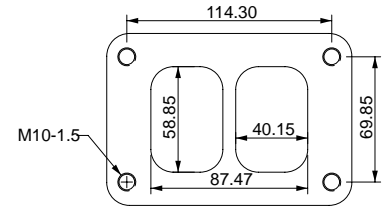

### **Tial GT28/GT30/GT35 Turbine Housing Inlet Flange**

- V-Band Style Flange

T304SS Part No.	Mild Steel Part No.	Matching V-Band Clamp Part No.
1416	N/A	1416C

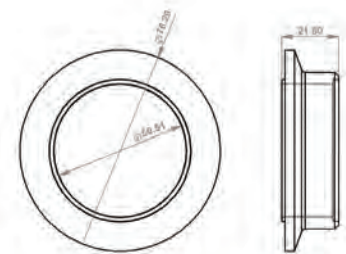

### **Precision Turbo 2" V-Band Inlet Flange**

- Fits many Precision CEA 5-series and 6-series turbochargers equipped with V-Band inlet on turbine housing.

T304SS Part No.	Mild Steel Part No.	Matching V-Band Clamp Part No.
1418	N/A	1416C

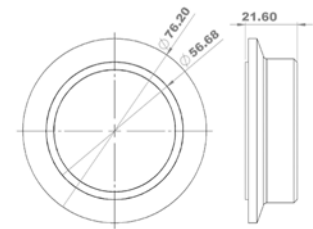

### **Garrett GT30 and GT35 Turbine Housing Inlet Flange - Divided / Twin Scroll**

- V-Band Style Flange

T304SS Part No.	Mild Steel Part No.	Matching V-Band Clamp Part No.
1391	N/A	1416C

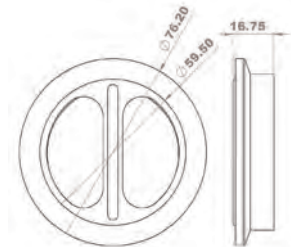

### **Garrett GT30 and GT35 Turbine Housing Inlet Flange**

- V-Band Style Flange

T304SS Part No.	Mild Steel Part No.	Matching V-Band Clamp Part No.
1390	N/A	1416C

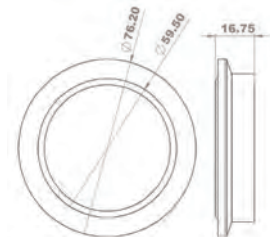

### **Mitsubishi EVO 7.8.9 and X Inlet Flange**

- 1/2" thick
- Drilled holes

T304SS Part No.	Mild Steel Part No.	Matching Gasket Part No.
N/A	14020	N/A

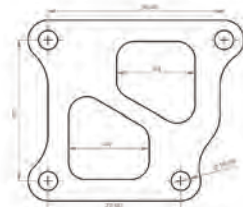

## EXTERNAL WASTEGATE FLANGES

Note: All dimensions listed in millimeters



### Tial MV-S Wastegate Outlet Flange

- Also fits Turbosmart Ultragate 40
- V-Band Style

T304SS Part No.	Mild Steel Part No.	Matching V-Band Clamp Part No.
1426	N/A	N/A

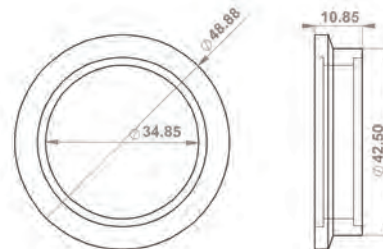

### Tial MV-S Wastegate Inlet Flange

- Also fits Turbosmart Ultragate 40
- V-Band Style.

T304SS Part No.	Mild Steel Part No.	Matching V-Band Clamp Part No.
1424	N/A	N/A

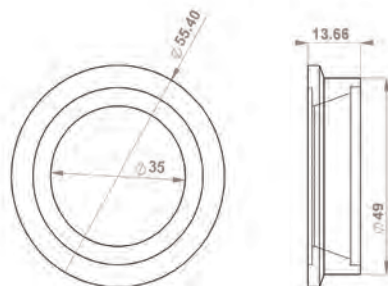

### Tial, Deltagate, Evolution and Turbosmart 35-38mm External Wastegate Flange

- 3/8" thick to prevent warping due to high heat.
- Available with Tapped Holes for Wastegate Inlet and Drilled holes for Dump Tube applications.



#### Flange with Drilled Holes

T304SS Part No.	Mild Steel Part No.	Matching Gasket Part No.
1436	14360	1436G

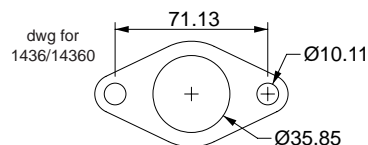

#### Flange with Tapped Holes

T304SS Part No.	Mild Steel Part No.	Matching Gasket Part No.
1437	14370	1436G

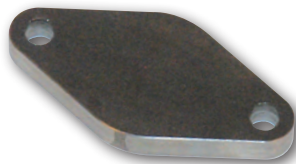
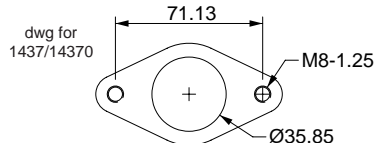

### 35-38mm External Wastegate Block Off Flange

T304SS Part No.	Mild Steel Part No.	Matching Gasket Part No.
N/A	14290	1436G

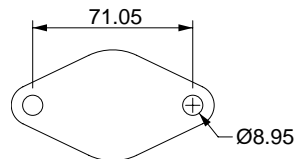

### 38mm to 44mm Wastegate Adapter Flange

- This adapter makes it easy to upgrade from a Tial 2 bolt 35-38mm WG to a Tial 44mm WG without cutting off the existing 2-bolt flange.
- Compatible with V-Band Clamp supplied with Tial 44mm WG

T304SS Part No.	Mild Steel Part No.	Matching Gasket Part No.
1427	N/A	1436G

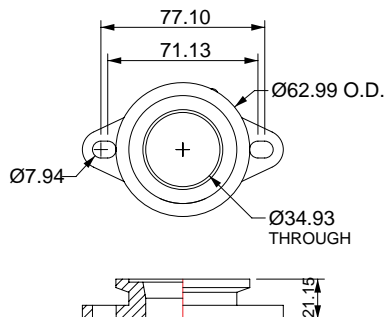





**Tial V44 and MV-R Wastegate Outlet Flange**

- V-Band Style

T304SS Part No.	Mild Steel Part No.	Matching V-Band Clamp Part No.
1410A	N/A	N/A

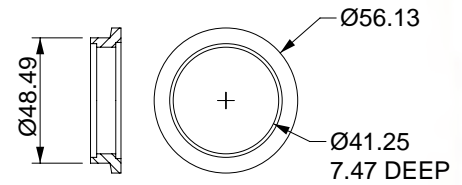

**Tial V44 and MV-R Wastegate Inlet Flange**

- V-Band Style

T304SS Part No.	Mild Steel Part No.	Matching V-Band Clamp Part No.
1411A	N/A	N/A

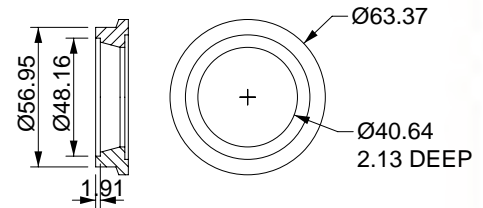

**Tial 41mm Wastegate Outlet Flange**

- This flange can also be used with Tial 40mm Wastegates

T304SS Part No.	Mild Steel Part No.	Matching Gasket Part No.
1412	N/A	N/A

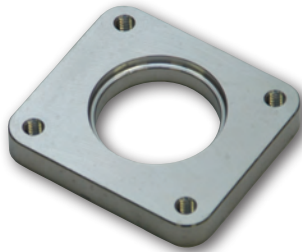
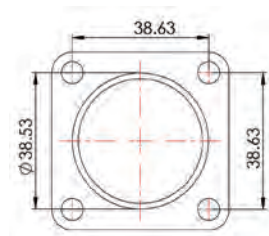

**Tial 41mm Wastegate Inlet Flange**

- Tapped Holes (12-24NC)

T304SS Part No.	Mild Steel Part No.	Matching Gasket Part No.
1413	N/A	N/A

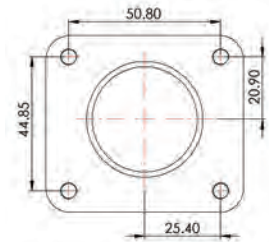

**Wastegate Flange Kit for 40mm Synapse Synchronic Wastegate**

- Includes both inlet and outlet flanges, 4 S.S. studs and 4 nuts

T304SS Part No.	Mild Steel Part No.	Matching Gasket Part No.
17001	N/A	N/A

**STAINLESS STEEL FLEXIBLE INTERLOCK HOSE (FOR DUMP TUBE USE)**

Stainless Steel Interlock Hose provides extra flexibility when fabricating a Wastegate Dump Tube in tight areas.

Part No.	Description
84027	1-1/2" I.D. (38mm) x 20" long S.S. Interlock Hose



# TURBO DISCHARGE (DOWNPIPE) FLANGES

Note: All dimensions listed in millimeters



### GT series / T3 Discharge Flange, 4 Bolt (3" Inlet I.D.)

- Use with new generation GT housings with 3" ID outlet
- 1/2" thick

T304SS Part No.	Mild Steel Part No.	Matching Gasket Part No.
1438	14380	1438G

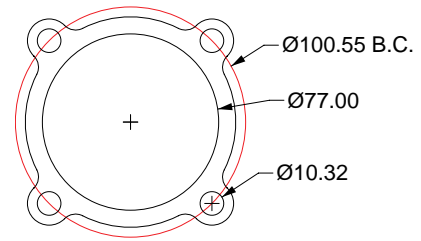

### GT series / T3 Discharge Flange, 4 Bolt (2.5" Inlet I.D.)

- Use with smaller T3 and GT housings with 2.5" ID outlet
- 1/2" thick

T304SS Part No.	Mild Steel Part No.	Matching Gasket Part No.
1439	14390	1439G

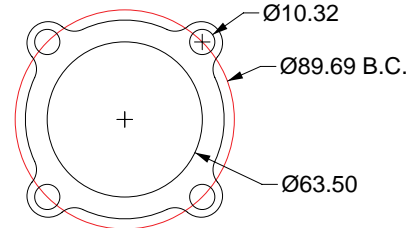

### T3 Discharge Flange, 5 Bolt (for External Wastegate)

- 1/2" thick

T304SS Part No.	Mild Steel Part No.	Matching Gasket Part No.
1433	14330	N/A

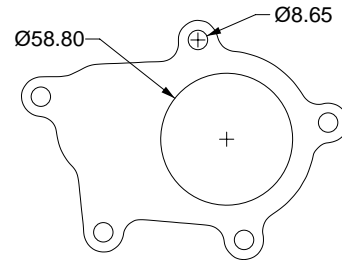

### Generation 2 T3 Discharge Flange, 5 Bolt with Divorced Ports Option

- A 7/8" I.D. hole is partially machined to allow for optional divorced ports.
- Designed to work with our transition adapter flange (Part #1447) to simplify fabrication of custom 3" O.D. Downpipes.
- 1/2" thick

T304SS Part No.	Mild Steel Part No.	Matching Gasket Part No.
N/A	14460	N/A

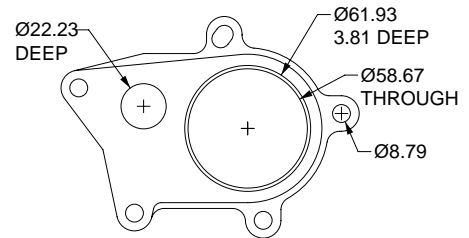

### Transition Adapter Flange for Generation 2 T3 Discharge Flange

- This flange makes it easier to fabricate custom 3" Downpipes for T3 Turbos with 5-bolt discharge.
- Flange outlet is designed for easy welding of either 3" O.D. Tubing or 3" O.D. Schedule 10 Elbow.
- Features unique offset to allow flange to be rotated for optimum clearance of potential obstructions.

T304SS Part No.	Mild Steel Part No.	Matching Gasket Part No.
N/A	14470	N/A

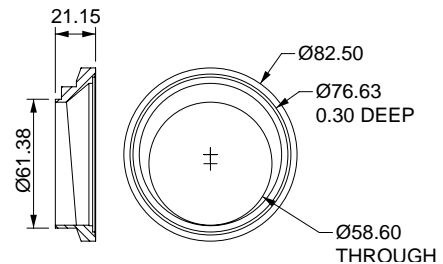



**Discharge Flange for Tial GT28, GT30 and GT35 Turbine housings**

- Also fits most Garrett medium frame turbine housings with V-band outlet
- V-Band style

T304SS Part No.	Mild Steel Part No.	Matching V-Band Clamp Part No.
1415	N/A	1415C

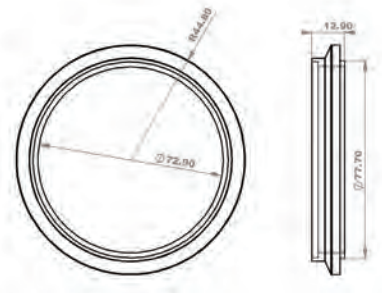

**GT25R / GT28R Discharge Flange, 5 Bolt**

- Features machined lip for easy welding of oval tubing
- 1/2" thick

T304SS Part No.	Mild Steel Part No.	Matching Gasket Part No.
1448	14480	N/A

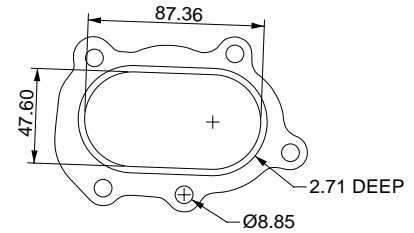

**Oval to Round Transition Adapter for GT25 / GT28 Discharge Flange**

- Quickly Transitions from 90mm x 55mm Oval to 76mm (3") Round
- Use with Vibrant Part #1448 or #14480

T304SS Part No.	Mild Steel Part No.	Matching Gasket Part No.
1448A	N/A	N/A

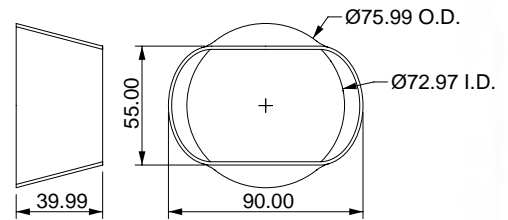

**GT25R / GT28R Discharge Flange, 5 Bolt with Divorced Ports**

- 1/2" thick

T304SS Part No.	Mild Steel Part No.	Matching Gasket Part No.
1449	14490	N/A

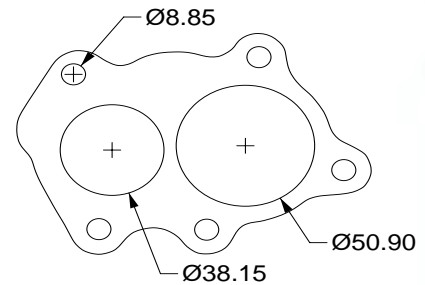

**Borg Warner EFR Discharge Flange**

- Fits all BW T25, T3 and T4 based turbine housings
- V-Band style

T304SS Part No.	Mild Steel Part No.	Matching V-Band Clamp Part No.
14901	N/A	N/A

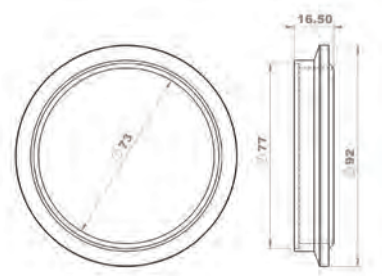

**TURBO DISCHARGE FLANGES (CONTINUED)**

Note: All dimensions listed in millimeters



**Precision Turbo 3" V-Band Discharge Flange**

- Fits many Precision CEA 5-series and 6-series turbochargers equipped with V-Band outlet on turbine housing.

T304SS Part No.	Mild Steel Part No.	Matching V-Band Clamp Part No.
1419	N/A	1415C

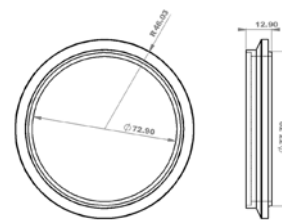

**T3 Discharge Flange, 3 Bolt**

- For use on Internally Wastegated T3 Turbos
- 1/2" thick

T304SS Part No.	Mild Steel Part No.	Matching Gasket Part No.
N/A	14340	N/A

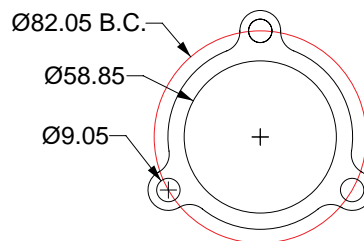

**T04 Oncenter Discharge Flange, 4 Bolt**

- 1/2" thick

T304SS Part No.	Mild Steel Part No.	Matching Gasket Part No.
N/A	14350	N/A

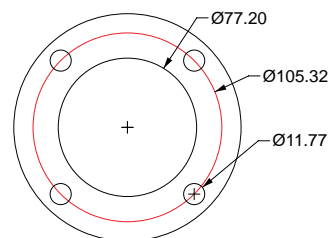

**VW 1.8T Discharge Flange**

- Bolts to K03/K04 OE Turbo on FWD VW Golf / Jetta / Beetle 1.8T
- 1/2" Thick

T304SS Part No.	Mild Steel Part No.	Matching Gasket Part No.
N/A	14440	1444G

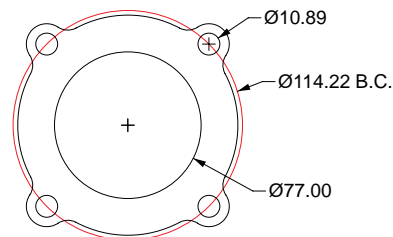

**GT32 Discharge Flange, 6 Bolt**

- Suitable for use on internally and externally wastegated versions of GT32 Turbo.
- 1/2" thick

T304SS Part No.	Mild Steel Part No.	Matching Gasket Part No.
N/A	14200	1420G

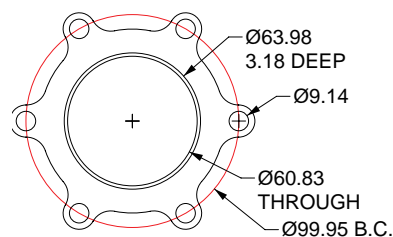



**Mitsubishi EVO 7,8,9 and X Discharge Flange**

- 1/2" thick

T304SS Part No.	Mild Steel Part No.	Matching Gasket Part No.
N/A	13960	N/A

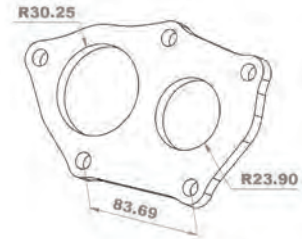

**TURBO COMPRESSOR FLANGES**



**GT42 Compressor Outlet Flange**

T304SS Part No.	T6061 Aluminum Part No.	Matching V-Band Clamp Part No.
14943	14942	14942C

Note: All dimensions listed in millimeters

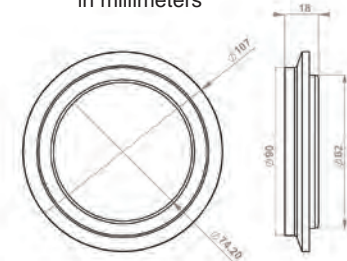

**Borg Warner EFR Compressor Outlet Flange**

T304SS Part No.	T6061 Aluminum Part No.	Matching V-Band Clamp Part No.
14902	14900	N/A

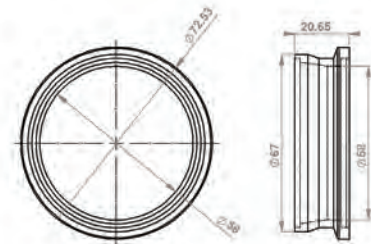

**Nissan SR20 OE Turbo Compressor Inlet Flange**

- Fits Many OEM Nissan turbos, including SR20, RB25 and RB26.
- Also fits Garrett GT2554R, GT2560R, GT2854R, GT2859R and GT2860R.

T304SS Part No.	T6061 Aluminum Part No.	Matching Gasket Part No.
14905	14904	N/A

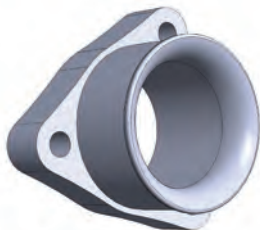
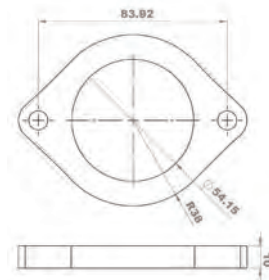

**Nissan SR20 OE Turbo Compressor Outlet Flange**

- Fits OEM SR20 turbos and Garrett GT2554R, GT2560R, GT2854R.

T304SS Part No.	T6061 Aluminum Part No.	Matching Gasket Part No.
N/A	14906	N/A

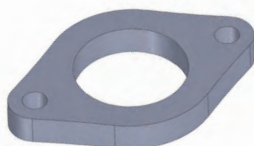
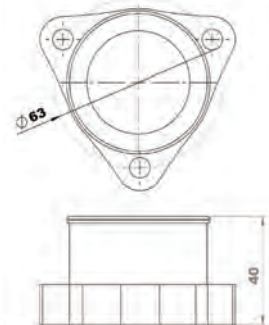

**Nissan RB25/RB26 OE Turbo Compressor Outlet Flange**

- Also fits Garrett GT2859R and GT2860R.

T304SS Part No.	T6061 Aluminum Part No.	Matching Gasket Part No.
14909	14908	N/A

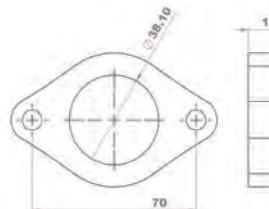

## OIL RESTRICTOR FITTING KITS



Vibrant Performance Oil Restrictor Fitting Kits allow you to effectively limit oil flow to your turbo, minimizing the potential for damaging the oil seals in your turbo.

Our unique Restrictor Fittings come with 2 Threaded Brass Jets of differing sizes to allow you to customize oil flow control. An Allen Key and Loctite are also included.

Part No.	Application
10287	-4 AN x 7/16-24 Oil Restrictor Fitting Kit for Garrett BB Turbos
10288	-3 AN x 1/8" NPT Oil Restrictor Fitting Kit
10289	-4 AN x 1/8" NPT Oil Restrictor Fitting Kit

## ALUMINUM WATER JACKET ADAPTER FITTINGS



Part No.	Application	Size
10229	For use on Garrett GT28, GT30 and GT35	-6 AN x M14 x 1.5
10298	For use on Garrett GT40, GT42 and GT45	-6 AN x M18 x 1.5

## UNIVERSAL OIL FEED KITS

All Vibrant Performance Oil Feed Kits include a PTFE lined Stainless Steel Flexible Hose and high quality AN Fittings.

Part No.	Description
10270	Oil Feed Kit - 2 ft. hose w/ -3 AN Female Fittings
10271	Oil Feed Kit - 3 ft. hose w/ -3 AN Female Fittings
10272	Oil Feed Kit - 4 ft. hose w/ -3 AN Female Fittings
10275	Oil Feed Kit - 2 ft. hose w/ -4 AN Female Fittings
10276	Oil Feed Kit - 3 ft. hose w/ -4 AN Female Fittings
10277	Oil Feed Kit - 4 ft. hose w/ -4 AN Female Fittings

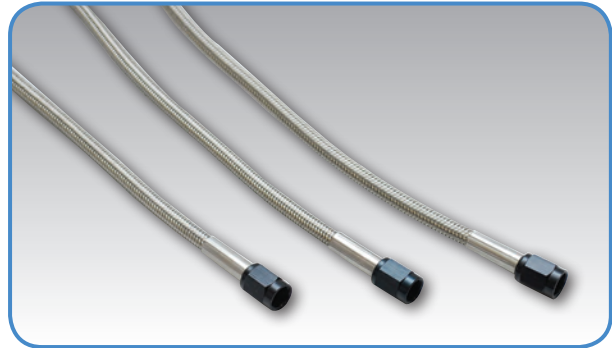

## ALUMINUM OIL FEED FLANGES



### Oil Feed Flange (T3, T3/T4 and T04)

- Also fits Garrett GT40, GT42, GT45 and GT47 turbos.
- Tapped - 1/8" NPT.
- Includes M8 x 1.25 Bolts.

Part No. 2899

Note: dimensions listed in inches

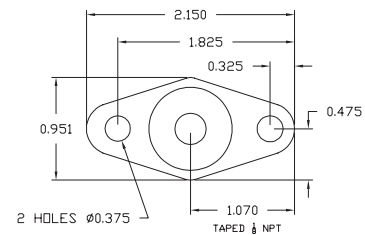

## UNIVERSAL OIL DRAIN / RETURN KITS

Vibrant Performance Universal Oil Drain Kits include a -10AN Stainless Steel Flexible Hose, -10 AN Aluminum Fittings, -10AN Oil Pan Weld Bungs (Steel and Aluminum Bungs are included) and an Aluminum Oil Drain Flange.

Part No.	Description
10280	Oil Drain Kit with 12" long Flex Hose and Oil Drain Flange for T3/T4 Turbos
10281	Oil Drain Kit with 12" long Flex Hose and Oil Drain Flange for GT Series Turbos
10282	Oil Drain Kit for Top Mount setups with 20" long Flex Hose and Oil Drain Flange for T3/T4 Turbos
10283	Oil Drain Kit for Top Mount setups with 20" long Flex Hose and Oil Drain Flange for GT Series Turbos



# ALUMINUM OIL DRAIN FLANGES

All Vibrant Performance Oil Drain Flanges feature T6061 Aluminum and include a pair of M8 x 1.25 Bolts for easy installation.

Note: dimensions listed in inches

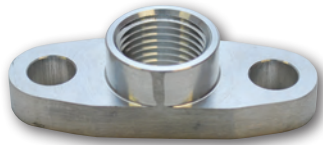

### Oil Drain Flange (T3, T3/T4 and T04)

- Tapped - 1/2" NPT
- Part No. 2898**

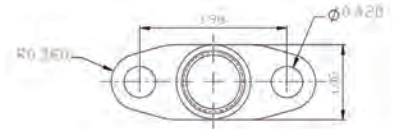

### Oil Drain Flange (GT series BB Turbochargers)

- Use with GT25R, GT28R, GT30R and GT35R Ball Bearing Turbos
  - Tapped - 1/2" NPT
- Part No. 2889**

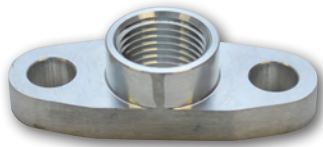
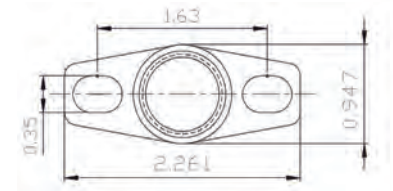

### Oil Drain Flange (GT series Turbochargers)

- Use with GT32, GT37, GT40, GT42, GT45R and GT55R Turbos
  - Tapped - 1/2" NPT
- Part No. 2853**

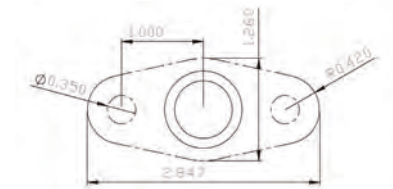

### Oil Drain Flange with integrated -10AN Fitting

- Fits GT15-GT35 series BB Turbos
- Part No. 2893**

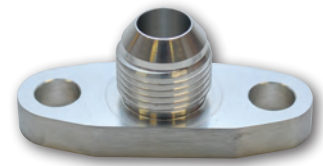
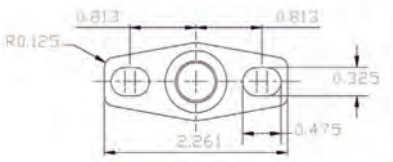

### Oil Drain Flange with integrated -10AN Fitting

- Fits T3, T3/T4, T04 and GT40-GT55 turbos
- Part No. 2849**

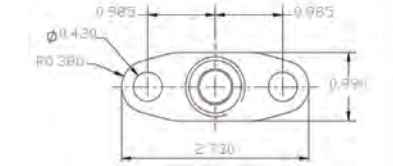

### Oil Drain Flange with integrated 5/8" Male Neck

- Fits GT15-GT35 series BB Turbo
- Part No. 2894**

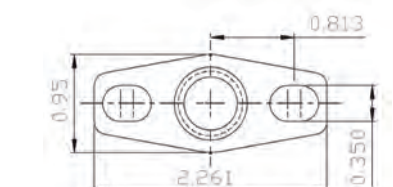

### Oil Drain Flange with integrated 5/8" Male Neck

- Fits T3, T3/T4, T04 and GT40-GT55 turbos
- Part No. 2850**

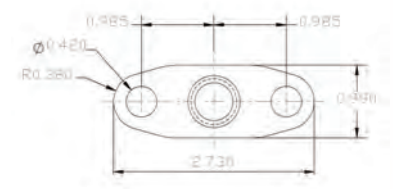

## BRAIDED FLEXIBLE RACE HOSES

Vibrant Performance offers a range of Braided Synthetic Rubber Hose manufactured to withstand the demands of the motorsports industry. These hoses are available in your choice of a 300 series Stainless Steel Braided Cover for ultimate protection from abrasion and corrosion or a Black Braided Nylon Cover that is lightweight and durable.

Vibrant Performance Braided Flex Hoses are suitable for use with Oil, Water, Fuel, Coolant and Vacuum and are capable of handling operating temperatures ranging from -40 deg F to 300 deg. F and elevated Operating Pressures.



### STAINLESS STEEL BRAIDED FLEX HOSES

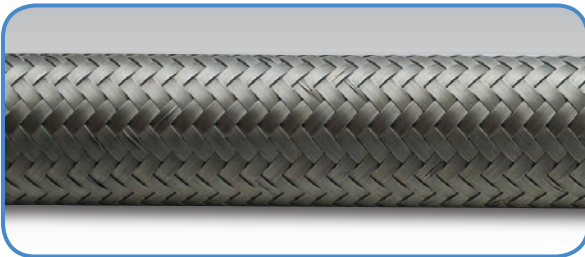

#### TECH TIP

Vibrant Performance Heat Protect Flexible Sleeving protects your Race Hoses from constant temperatures up to 500° deg F.

These sleeves are easy to install, will not melt, delaminate or become brittle under normal operating conditions and provides a professional solution to your thermal protection needs. See page 58 for more information.



AN Size	Hose ID	Hose OD	2ft Roll Part No.	5ft Roll Part No.	10ft Roll Part No.	20ft Roll Part No.	Operating Pressure
-4	0.22" (5.55mm)	0.44" (11.20mm)	11904	11934	11914	11924	1500 psi
-6	0.34" (8.70mm)	0.55" (13.80mm)	11906	11936	11916	11926	1500 psi
-8	0.44" (11.10mm)	0.625" (15.70mm)	11908	11938	11918	11928	1250 psi
-10	0.56" (14.30mm)	0.83" (20.80mm)	11910	11940	11920	11930	1250 psi
-12	0.68" (17.45mm)	0.95" (23.90mm)	11912	11942	11922	11932	1000 psi
-16	0.89" (22.20mm)	1.20" (30.50mm)	11913	11943	11923	11933	750 psi
-20	1.125" (28.55mm)	1.40" (35.80mm)	11915	11945	11925	11935	500 psi

### INNER SUPPORT SPRINGS

Our new Inner Support Spring offering provides your braided flex hoses with extra support to avoid collapse under extreme vacuum or if you are attempting very tight bends.



Part No.	Description	Spring Length
17306	Support Spring for -6AN Flex Hose	4 feet
17308	Support Spring for -8AN Flex Hose	4 feet
17310	Support Spring for -10AN Flex Hose	4 feet
17312	Support Spring for -12AN Flex Hose	4 feet
17316	Support Spring for -16AN Flex Hose	4 feet
17320	Support Spring for -20AN Flex Hose	4 feet

Note: Some lubrication may be needed for ease of installation



## NYLON BRAIDED FLEX HOSES

Vibrant Performance Nylon Braided Flex Hoses are now available in your choice of All-Black, Black/Blue or Black/Red Braid.

Available in 2 foot, 5 foot, 10 foot and 20 foot lengths.



All Black Nylon Braided Flex Hose



Black/Blue Nylon Braided Flex Hose



Black/Red Nylon Braided Flex Hose

### ALL BLACK NYLON BRAIDED FLEX HOSES

AN Size	Hose ID	Hose OD	2ft Roll Part No.	5ft Roll Part No.	10ft Roll Part No.	20ft Roll Part No.	Operating Pressure
-4	0.22" (5.55mm)	0.44" (11.20mm)	11954	11984	11964	11974	500 psi
-6	0.34" (8.70mm)	0.55" (13.80mm)	11956	11986	11966	11976	500 psi
-8	0.44" (11.10mm)	0.625" (15.70mm)	11958	11988	11968	11978	500 psi
-10	0.56" (14.30mm)	0.83" (20.80mm)	11960	11990	11970	11980	500 psi
-12	0.68" (17.45mm)	0.95" (23.90mm)	11962	11992	11972	11982	350 psi
-16	0.89" (22.20mm)	1.20" (30.50mm)	11963	11993	11973	11983	350 psi

### BLACK / BLUE NYLON BRAIDED FLEX HOSES

AN Size	Hose ID	Hose OD	2ft Roll Part No.	5ft Roll Part No.	10ft Roll Part No.	20ft Roll Part No.	Operating Pressure
-4	0.22" (5.55mm)	0.44" (11.20mm)	11954B	11984B	11964B	11974B	500 psi
-6	0.34" (8.70mm)	0.55" (13.80mm)	11956B	11986B	11966B	11976B	500 psi
-8	0.44" (11.10mm)	0.625" (15.70mm)	11958B	11988B	11968B	11978B	500 psi
-10	0.56" (14.30mm)	0.83" (20.80mm)	11960B	11990B	11970B	11980B	500 psi
-12	0.68" (17.45mm)	0.95" (23.90mm)	11962B	11992B	11972B	11982B	350 psi
-16	0.89" (22.20mm)	1.20" (30.50mm)	11963B	11993B	11973B	11983B	350 psi

### BLACK / RED NYLON BRAIDED FLEX HOSES

AN Size	Hose ID	Hose OD	2ft Roll Part No.	5ft Roll Part No.	10ft Roll Part No.	20ft Roll Part No.	Operating Pressure
-4	0.22" (5.55mm)	0.44" (11.20mm)	11954R	11984R	11964R	11974R	500 psi
-6	0.34" (8.70mm)	0.55" (13.80mm)	11956R	11986R	11966R	11976R	500 psi
-8	0.44" (11.10mm)	0.625" (15.70mm)	11958R	11988R	11968R	11978R	500 psi
-10	0.56" (14.30mm)	0.83" (20.80mm)	11960R	11990R	11970R	11980R	500 psi
-12	0.68" (17.45mm)	0.95" (23.90mm)	11962R	11992R	11972R	11982R	350 psi
-16	0.89" (22.20mm)	1.20" (30.50mm)	11963R	11993R	11973R	11983R	350 psi

# ALUMINUM HOSE END FITTINGS

Vibrant Performance Aluminum Swivel Style Hose End Fittings deliver the type of quality, reliability, smooth flow and ease of assembly that motorsport professionals demand. Made from T6061 Aluminum Alloy, these lightweight hose end fittings are suitable for use on a wide variety of applications. Available in Anodized Black finish only. Suitable for use with all Vibrant Braided Flex Hoses (Please refer to pages 40 & 41).

## STRAIGHT SWIVEL HOSE END FITTINGS



Part No.	Size
21004	-4 AN
21006	-6 AN
21008	-8 AN
21010	-10 AN
21012	-12 AN
21016	-16 AN
21020	-20 AN

## 30° SWIVEL HOSE END FITTINGS



Part No.	Size
21304	-4 AN
21306	-6 AN
21308	-8 AN
21310	-10 AN
21312	-12 AN
21316	-16 AN
21320	-20 AN

## 45° SWIVEL HOSE END FITTINGS



Part No.	Size
21404	-4 AN
21406	-6 AN
21408	-8 AN
21410	-10 AN
21412	-12 AN
21416	-16 AN
21420	-20 AN

## 60° SWIVEL HOSE END FITTINGS



Part No.	Size
21604	-4 AN
21606	-6 AN
21608	-8 AN
21610	-10 AN
21612	-12 AN
21616	-16 AN
21620	-20 AN

## 90° SWIVEL HOSE END FITTINGS



Part No.	Size
21904	-4 AN
21906	-6 AN
21908	-8 AN
21910	-10 AN
21912	-12 AN
21916	-16 AN
21920	-20 AN

## 120° SWIVEL HOSE END FITTINGS



Part No.	Size
21204	-4 AN
21206	-6 AN
21208	-8 AN
21210	-10 AN
21212	-12 AN
21216	-16 AN
21220	-20 AN

## 150° SWIVEL HOSE END FITTINGS



Part No.	Size
21504	-4 AN
21506	-6 AN
21508	-8 AN
21510	-10 AN
21512	-12 AN
21516	-16 AN
21520	-20 AN

## 180° SWIVEL HOSE END FITTINGS



Part No.	Size
21804	-4 AN
21806	-6 AN
21808	-8 AN
21810	-10 AN
21812	-12 AN
21816	-16 AN
21820	-20 AN

## REPLACEMENT HOSE END SOCKETS



Size	Black Part No.	Blue Part No.	Red Part No.	Chrome Part No.
-4AN	20954	20954B	20954R	20954S
-6AN	20956	20956B	20956R	20956S
-8AN	20958	20958B	20958R	20958S
-10AN	20960	20960B	20960R	20960S
-12AN	20962	20962B	20962R	20962S
-16AN	20966	20966B	20966R	20966S
-20AN	20970	20970B	20970R	20970S

## MALE AN HOSE END FITTINGS

### MALE AN FLARE STRAIGHT HOSE END FITTINGS



Part No.	Hose Size	Male Flare
24006	-6AN	-6AN
24008	-8AN	-8AN
24010	-10AN	-10AN
24012	-12AN	-12AN

### MALE AN 45° HOSE END FITTINGS



Part No.	Hose Size	Thread
24400	-6AN	7/16-20 Thread (4)
24402	-6AN	9/16-18 Thread (6)
24403	-6AN	3/4-16 Thread (8)
24404	-8AN	9/16-18 Thread (6)
24405	-8AN	3/4-16 Thread (8)
24406	-8AN	7/8-14 Thread (10)
24407	-10AN	3/4-16 Thread (8)
24408	-10AN	7/8-14 Thread (10)
24409	-10AN	1-1/6-12 Thread (12)
24410	-12AN	7/8-14 Thread (10)
24411	-12AN	1-1/6-12 Thread (12)

### MALE AN 90° HOSE END FITTINGS



Part No.	Hose Size	Thread
24900	-6AN	7/16-20 Thread (4)
24902	-6AN	9/16-18 Thread (6)
24903	-6AN	3/4-16 Thread (8)
24904	-8AN	9/16-18 Thread (6)
24905	-8AN	3/4-16 Thread (8)
24906	-8AN	7/8-14 Thread (10)

Part No.	Hose Size	Thread
24907	-10AN	3/4-16 Thread (8)
24908	-10AN	7/8-14 Thread (10)
24909	-10AN	1-1/6-12 Thread (12)
24910	-12AN	7/8-14 Thread (10)
24911	-12AN	1-1/6-12 Thread (12)

## MALE NPT HOSE END FITTINGS

### MALE NPT STRAIGHT HOSE END FITTINGS



Part No.	Hose Size	Pipe Thread
26000	-6AN	1/8 NPT
26001	-6AN	1/4 NPT
26002	-6AN	3/8 NPT
26003	-8AN	1/4 NPT
26004	-8AN	3/8 NPT
26005	-8AN	1/2 NPT
26006	-10AN	3/8 NPT
26007	-10AN	1/2 NPT
26008	-12AN	1/2 NPT
26009	-12AN	3/4 NPT

### MALE NPT 45° HOSE END FITTINGS



Part No.	Hose Size	Pipe Thread
26400	-6AN	1/8 NPT
26401	-6AN	1/4 NPT
26402	-6AN	3/8 NPT
26403	-8AN	1/4 NPT
26404	-8AN	3/8 NPT
26405	-8AN	1/2 NPT
26406	-10AN	3/8 NPT
26407	-10AN	1/2 NPT
26408	-12AN	1/2 NPT
26409	-12AN	3/4 NPT

### MALE NPT 90° HOSE END FITTINGS



Part No.	Hose Size	Pipe Thread
26900	-6AN	1/8 NPT
26901	-6AN	1/4 NPT
26902	-6AN	3/8 NPT
26903	-8AN	1/4 NPT
26904	-8AN	3/8 NPT
26905	-8AN	1/2 NPT
26906	-10AN	3/8 NPT
26907	-10AN	1/2 NPT
26908	-12AN	1/2 NPT
26909	-12AN	3/4 NPT



#### TECH TIP:

Vibrant Hose End Fittings and Adapters are now suitable for E85 service, as are all Vibrant Braided Flex Hoses.

## FLEX HOSE FOR PUSH-ON STYLE FITTINGS

For use with Vibrant Performance Push-On Style Hose End Fittings. Available only in black. These rubber hoses are suitable for use with Oil, Water, Coolant and Methanol and are capable of handling operating temperatures ranging from -40° F to 210° F and Operating Pressures up to 300psi. Use of a clamp to secure the hose to a fitting is recommended whenever consistent operating temperature exceeds 150° F.



### TECH TIP:

It is important to ensure all hoses are thoroughly cleaned before use.

AN Size	Hose ID	Hose OD	10ft Roll Part No.	20ft Roll Part No.	Operating Pressure
-4	0.25" (6.4mm)	0.47" (12mm)	16314	16324	300 psi
-6	0.375" (9.5mm)	0.625" (15.9mm)	16316	16326	300 psi
-8	0.50" (12.7mm)	0.75" (19.1mm)	16318	16328	300 psi
-10	0.625" (15.9mm)	0.90" (22.9mm)	16320	16330	300 psi
-12	0.75" (19.1mm)	1.03" (26.2mm)	16322	16332	300 psi

## PUSH-ON HOSE END FITTINGS

Push-On style Hose End Fittings are lightweight and allow for quick, easy and secure installation.

### STRAIGHT



Part No.	Size
22004	-4 AN
22006	-6 AN
22008	-8 AN
22010	-10 AN
22012	-12 AN

### 45° ELBOWS



Part No.	Size
22404	-4 AN
22406	-6 AN
22408	-8 AN
22410	-10 AN
22412	-12 AN

### 90° ELBOWS



Part No.	Size
22904	-4 AN
22906	-6 AN
22908	-8 AN
22910	-10 AN
22912	-12 AN

### 120° ELBOWS



Part No.	Size
22204	-4 AN
22206	-6 AN
22208	-8 AN
22210	-10 AN
22212	-12 AN

### 150° ELBOWS



Part No.	Size
22504	-4 AN
22506	-6 AN
22508	-8 AN
22510	-10 AN
22512	-12 AN

### 180° ELBOWS



Part No.	Size
22804	-4 AN
22806	-6 AN
22808	-8 AN
22810	-10 AN
22812	-12 AN

# ADAPTER FITTINGS

Vibrant Performance offers a comprehensive selection of Adapter Fittings to help complete almost any project. These adapters are suitable for use with any manufacturers hose end fitting. **All Aluminum Adapter Fittings are available in Anodized Black only.**

## ALUMINUM STRAIGHT ADAPTER FITTINGS (AN MALE TO NPT)

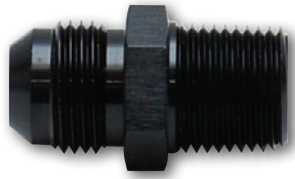

Aluminum



Steel

Part No.	Size	Material	Part No.	Size	Material
10290	-3 AN x 1/8" NPT	Steel	10221	-8 AN x 3/8" NPT	Aluminum
10291	-3 AN x 1/8" NPT	Aluminum	10225	-8 AN x 1/2" NPT	Aluminum
10292	-4 AN x 1/8" NPT	Steel	10223	-10 AN x 3/8" NPT	Aluminum
10293	-4 AN x 1/8" NPT	Aluminum	10294	-10 AN x 1/2" NPT	Aluminum
10216	-4 AN x 1/4" NPT	Aluminum	10226	-10 AN x 3/4" NPT	Aluminum
10213	-4AN to 3/8" NPT	Aluminum	10227	-12 AN x 1/2" NPT	Aluminum
10217	-6 AN x 1/8" NPT	Aluminum	10224	-12 AN x 3/4" NPT	Aluminum
10220	-6 AN x 1/4" NPT	Aluminum	10206	-16AN to 3/4" NPT	Aluminum
10222	-6 AN x 3/8" NPT	Aluminum	10228	-16 AN x 1" NPT	Aluminum
10218	-6 AN x 1/2" NPT	Aluminum	10207	-20AN to 1-1/4" NPT	Aluminum
10219	-8 AN x 1/4" NPT	Aluminum			

## 45° ADAPTERS (AN MALE TO NPT)



Part No.	Size	Part No.	Size
10240	-3 AN x 1/8" NPT	10243	-8 AN x 3/8" NPT
10241	-4 AN x 1/8" NPT	10297	-10 AN x 1/2" NPT
10242	-6 AN x 1/4" NPT	10244	-12 AN x 3/4" NPT
10245	-6 AN x 3/8" NPT	10246	-16 AN x 1" NPT

## 90° ADAPTERS (MALE AN TO NPT)



Part No.	Size	Part No.	Size
10250A	-3 AN x 1/8" NPT	10253	-8 AN x 3/8" NPT
10251A	-4 AN x 1/8" NPT	10268	-8 AN x 1/2" NPT
10256	-4 AN x 1/4" NPT	10259	-10 AN x 3/8" NPT
10286	-4 AN x 3/8" NPT	10254	-10 AN x 1/2" NPT
10257	-6 AN x 1/8" NPT	10299	-10 AN x 3/4" NPT
10252A	-6 AN x 1/4" NPT	10269	-12 AN x 1/2" NPT
10258	-6 AN x 3/8" NPT	10255	-12 AN x 3/4" NPT
10249	-6 AN x 1/2" NPT	10285	-16 AN x 3/4" NPT
10267	-8 AN x 1/4" NPT	10284	-16 AN x 1" NPT

## REDUCER ADAPTER FITTINGS (AN TO AN)

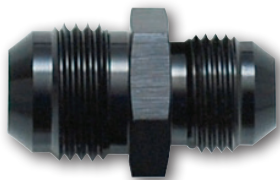

Part No.	Size
10430	-3 AN x -4 AN
10431	-4 AN x -6 AN
10432	-6 AN x -8 AN
10433	-6 AN x -10 AN
10438	-6 AN x -12 AN
10434	-8 AN x -10 AN
10435	-8 AN x -12 AN
10436	-10 AN x -12 AN
10439	-10 AN x -16 AN
10437	-12 AN x -16 AN
10429	-16 AN x -20 AN

## UNION ADAPTER FITTINGS (AN TO AN)



Part No.	Size
10230	-3 AN
10231	-4 AN
10232	-6 AN
10233	-8 AN
10234	-10 AN
10235	-12 AN
10236	-16 AN
10237	-20AN

**90° FLARE UNION ADAPTERS (MALE AN)**



Part No.	Size
10550	-3 AN
10551	-4 AN
10552	-6 AN
10553	-8 AN
10554	-10 AN
10555	-12 AN
10556	-16 AN

**TEE ADAPTERS (MALE AN)**



Part No.	Size
10480	-3 AN
10481	-4 AN
10482	-6 AN
10483	-8 AN
10484	-10 AN
10485	-12 AN
10486	-16 AN

**FLARE TO PIPE TEE ADAPTERS**



Part No.	Size
10460	-3 AN x 1/8" NPT
10461	-4 AN x 1/8" NPT
10462	-6 AN x 1/4" NPT
10463	-8 AN x 3/8" NPT
10464	-10 AN x 1/2" NPT
10465	-12 AN x 3/4" NPT
10466	-16 AN x 1" NPT

**FLARE TO PIPE ON RUN TEE ADAPTERS**



Part No.	Size
10470	-3 AN x 1/8" NPT
10471	-4 AN x 1/8" NPT
10472	-6 AN x 1/4" NPT
10473	-8 AN x 3/8" NPT
10474	-10 AN x 1/2" NPT
10475	-12 AN x 3/4" NPT
10476	-16 AN x 1" NPT

**STRAIGHT BULKHEAD ADAPTERS**



Part No.	Size
10680	-3 AN
10681	-4 AN
10682	-6 AN
10683	-8 AN
10684	-10 AN
10685	-12 AN
10686	-16 AN

**BULKHEAD ADAPTER 45° ELBOWS**



Part No.	Size
10600	-3AN
10601	-4AN
10602	-6AN
10603	-8AN
10604	-10AN
10605	-12AN

**BULKHEAD ADAPTER 90° ELBOWS**



Part No.	Size
10608	-3AN
10609	-4AN
10610	-6AN
10611	-8AN
10612	-10AN
10613	-12AN

**BULKHEAD ADAPTER TEE ON RUN FITTINGS**



Part No.	Size
10624	-3AN
10625	-4AN
10626	-6AN
10627	-8AN
10628	-10AN
10629	-12AN

**BULKHEAD ADAPTER TEE FITTINGS**



Part No.	Size
10616	-3AN
10617	-4AN
10618	-6AN
10619	-8AN
10620	-10AN
10621	-12AN

**BULKHEAD NUTS**

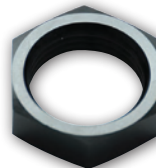

Part No.	Size
10690	-3 AN
10691	-4 AN
10692	-6 AN
10693	-8 AN
10694	-10 AN
10695	-12 AN
10696	-16 AN

## AN TO METRIC ADAPTERS



Part No.	AN	Metric	Part No.	AN	Metric	Part No.	AN	Metric
16602	-4AN	8mm x 1.0	16613	-6AN	10mm x 1.25	16632	-10AN	12mm x 1.5
16603	-4AN	8mm x 1.25	16614	-6AN	10mm x 1.5	16633	-10AN	14mm x 1.5
16604	-4AN	10mm x 1.0	16616	-6AN	12mm x 1.5	16634	-10AN	16mm x 1.5
16605	-4AN	10mm x 1.25	10229	-6AN	14mm x 1.5	16635	-10AN	18mm x 1.5
16606	-4AN	10mm x 1.5	16619	-6AN	16mm x 1.5	16636	-10AN	20mm x 1.5
16607	-4AN	12mm x 1.0	10298	-6AN	18mm x 1.5	16642	-12AN	14mm x 1.5
16608	-4AN	12mm x 1.25	16624	-8AN	12mm x 1.5	16643	-12AN	16mm x 1.5
16609	-4AN	12mm x 1.5	16625	-8AN	14mm x 1.5	16644	-12AN	18mm x 1.5
16611	-4AN	14mm x 1.5	16626	-8AN	16mm x 1.5	16645	-12AN	20mm x 1.5
16612	-6AN	10mm x 1.0	16627	-8AN	18mm x 1.5			

## AN FLARE TO AN STRAIGHT CUT (WITH O-RING) ADAPTER FITTINGS



Part No.	AN Flare	AN Straight Thread	Part No.	AN Flare	AN Straight Thread
16821	-4AN	7/16-20 Thread (4)	16835	-10AN	3/4-16 Thread (8)
16822	-4AN	9/16-18 Thread (6)	16836	-10AN	7/8-14 Thread (10)
16823	-4AN	3/4-16 Thread (8)	16837	-10AN	1-1/6-12 Thread (12)
16825	-6AN	7/16-20 Thread (4)	16838	-10AN	1-5/16-12 Thread (16)
16826	-6AN	9/16-18 Thread (6)	16839	-12AN	3/4-16 Thread (8)
16827	-6AN	3/4-16 Thread (8)	16840	-12AN	7/8-14 Thread (10)
16828	-6AN	7/8-14 Thread (10)	16841	-12AN	1-1/6-12 Thread (12)
16830	-8AN	9/16-18 Thread (6)	16842	-12AN	1-5/16-12 Thread (16)
16831	-8AN	3/4-16 Thread (8)	16844	-16AN	1-1/6-12 Thread (12)
16832	-8AN	7/8-14 Thread (10)	16845	-16AN	1-5/16-12 Thread (16)
16833	-8AN	1-1/6-12 Thread (12)	16847	-20AN	1-5/16-12 Thread (16)
16834	-10AN	9/16-18 Thread (6)	16848	-20AN	1-5/8-12 Thread (20)

## FEMALE UNION ADAPTERS (AN TO AN)



Part No.	Size
10700	-3AN
10701	-4AN
10702	-6AN
10703	-8AN
10704	-10AN
10705	-12AN
10706	-16AN
10708	-6AN x -8AN
10709	-8AN x -10AN

## FEMALE 45° UNION ADAPTERS (AN TO AN)



Part No.	Size
10711	-4 AN
10712	-6 AN
10713	-8 AN
10714	-10 AN
10715	-12 AN

## FEMALE 90° UNION ADAPTERS (AN TO AN)



Part No.	Size
10731	-4 AN
10732	-6 AN
10733	-8 AN
10734	-10 AN
10735	-12 AN



**FLARE CAPS**

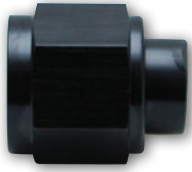

Part No.	Size
10450	-3 AN
10451	-4 AN
10452	-6 AN
10453	-8 AN
10454	-10 AN
10455	-12 AN
10456	-16 AN

**FLARE PLUGS**



Part No.	Size
10440	-3 AN
10441	-4 AN
10442	-6 AN
10443	-8 AN
10444	-10 AN
10445	-12 AN
10446	-16 AN

**FEMALE TO MALE REDUCER ADAPTERS AN**



Part No.	Female Size	Male Size
10830	-4AN	-3AN
10832	-6AN	-4AN
10833	-8AN	-6AN
10834	-10AN	-6AN
10835	-10AN	-8AN
10837	-12AN	-10AN

**FEMALE TO MALE EXPANDER ADAPTERS AN**



Part No.	Female Size	Male Size
10840	-3AN	-4AN
10841	-4AN	-6AN
10842	-6AN	-8AN
10843	-8AN	-10AN
10844	-10AN	-12AN
10845	-12AN	-16AN

**FEMALE FLARE TEE ADAPTERS**



Part No.	Size
10871	-4AN
10872	-6AN
10873	-8AN
10874	-10AN

**PIPE REDUCER ADAPTERS NPT**



Part No.	Female Size	Male Size
10850	1/8 NPT	1/4 NPT
10851	1/8 NPT	3/8 NPT
10852	1/4 NPT	3/8 NPT
10853	1/8 NPT	1/2 NPT
10854	1/4 NPT	1/2 NPT
10856	3/8 NPT	1/2 NPT
10855	1/4 NPT	3/4 NPT
10857	3/8 NPT	3/4 NPT
10858	1/2 NPT	3/4 NPT

**PIPE COUPLERS**

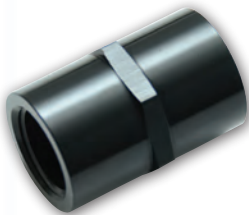

Part No.	Size
10380	1/8" NPT
10381	1/4" NPT
10382	3/8" NPT
10383	1/2" NPT
10384	3/4" NPT

**PIPE ADAPTERS**



Part No.	Size
10370	1/8" NPT
10371	1/4" NPT
10372	3/8" NPT
10373	1/2" NPT
10374	3/4" NPT

**SOCKET PIPE PLUGS**

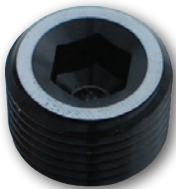

Part No.	Size
10490	1/8" NPT
10491	1/4" NPT
10492	3/8" NPT
10493	1/2" NPT
10494	3/4" NPT

**FEMALE PIPE TEE ADAPTERS NPT**



Part No.	Size
10860	1/8 NPT
10861	1/4 NPT
10862	3/8 NPT
10863	1/2 NPT



## BILLET ALUMINUM QUICK RELEASE FITTINGS

Vibrant Performance T6061 Billet Aluminum Quick Release Fittings are incredibly lightweight and allow for quick and easy disassembly by hand of any fluid related component without mess or spillage. Perfect for use on Oil, Coolant and Fuel line applications.



Part No.	Size
20804	-4 AN
20806	-6 AN
20808	-8 AN
20810	-10 AN
20812	-12 AN



## BILLET ALUMINUM ONE WAY CHECK VALVES

Vibrant Performance One-Way Check Valves are designed to prevent the flow back of all varieties of fuel, oil or coolant.

Manufactured from lightweight T6061 Billet Aluminum, our cost-effective Check Valves will stand up to the most rigorous operating environments. They are suitable for operating pressure up to 300psi, feature the ability to open under very low pressure (as low as 2psi) and have a functional operating temperature range of -30° F to 400° F

Part No.	Description
11187	-6AN
11190	-8AN
11191	-10AN
11192	-12AN



## HOSE BARB ADAPTER FITTINGS

### MALE AN TO HOSE BARB STRAIGHT ADAPTERS



Part No.	AN Size	Hose Size
11207	-6AN	3/8"
11208	-8AN	1/2"
11209	-10AN	1/2"

### MALE NPT TO HOSE BARB STRAIGHT ADAPTERS



Part No.	NPT Size	Hose Size
11200	1/8	1/4"
11201	1/4	3/8"
11202	3/8	1/2"
11203	1/2	5/8"
11204	3/4	3/4"

### MALE NPT TO HOSE BARB 45 DEG ADAPTERS



Part No.	NPT Size	Hose Size
11220	1/8	1/4"
11221	1/4	3/8"
11222	3/8	1/2"
11223	1/2	5/8"
11224	3/4	3/4"

### MALE NPT TO HOSE BARB 90 DEG ADAPTERS



Part No.	NPT Size	Hose Size
11230	1/8	1/4"
11231	1/4	3/8"
11232	3/8	1/2"
11233	1/2	5/8"
11234	3/4	3/4"

## HARD LINES AND TUBE ADAPTERS

Vibrant Performance Hard Lines are ideal for Nitrous, Fuel and Water service. Simply flare with a 37 degree flaring tool and these lines will be ready for use with our Tube Nuts and Tube Sleeves listed below.

Our new offering of Hard Line Adapter Fittings offers a convenient solution for transitioning from Hard Lines to AN thread. Assembly and alignment is made quick and easy.

### ALUMINUM AND STAINLESS STEEL HARD LINES



#### ALUMINUM HARD LINES

Part No.	Description
16410	5/16" OD (7.95mm) Aluminum Hard Line (25 foot spool)
16411	3/8" OD (9.5mm) Aluminum Hard Line (25 foot spool)
16412	1/2" OD (12.7mm) Aluminum Hard Line (25 foot spool)

#### STAINLESS STEEL HARD LINES

Part No.	Description
16401	3/8" OD (9.5mm) Stainless Steel Hard Line (25 foot spool)
16402	1/2" OD (12.7mm) Stainless Steel Hard Line (25 foot spool)

### TUBE TO FEMALE AN ADAPTERS



Part No.	AN Size	Tube Size
16445	-6AN Female	5/16"
16446	-6AN Female	3/8"
16448	-8AN Female	1/2"

### TUBE TO MALE AN ADAPTERS



Part No.	AN Size	Tube Size
16455	-6AN Male	5/16"
16456	-6AN Male	3/8"
16458	-8AN Male	1/2"

### TUBE SLEEVES

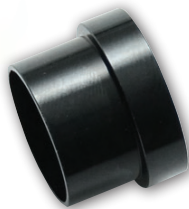

Part No.	AN Size	Use with Tube Size
10760	-3 AN	3/16"
10761	-4 AN	1/4"
10762	-6 AN	3/8"
10763	-8 AN	1/2"
10764	-10 AN	5/8"
10765	-12 AN	3/4"
10766	-16 AN	1"

### TUBE NUTS



Part No.	AN Size	Use with Tube Size
10750	-3 AN	3/16"
10751	-4 AN	1/4"
10752	-6 AN	3/8"
10753	-8 AN	1/2"
10754	-10 AN	5/8"
10755	-12 AN	3/4"
10756	-16 AN	1"

### BRASS OLIVE INSERTS



Part No.	Description
16465A	Pack of 5, Brass Olive Inserts for 5/16"
16466A	Pack of 5, Brass Olive Inserts for 3/8"
16468A	Pack of 5, Brass Olive Inserts for 1/2"

## FUEL CELL BULKHEAD ADAPTER FITTINGS (WITH WASHERS AND NUT)

Connect your fuel line to your fuel cell or tank with these high quality fuel cell bulkhead adapters. These double anodized and hand polished aluminum adapters won't restrict fuel flow and come complete with two PTFE washers.



Part No.	Size
16892	-6AN
16893	-8AN
16894	-10AN
16895	-12AN

## Y ADAPTERS



Part No.	Size
10803	-3 AN x dual -3 AN
10814	-4AN x dual -3 AN
10804	-4 AN x dual -4 AN
10805	-6 AN x dual -4 AN
10806	-6 AN x dual -6 AN
10807	-8 AN x dual -6 AN
10808	-8 AN x dual -8 AN

Part No.	Size
10809	-10 AN x dual -8 AN
10810	-10 AN x dual -10 AN
10813	-12 AN x dual -8 AN
10811	-12 AN x dual -10 AN
10812	-12 AN x dual -12 AN
10818	1/8" NPT x dual -3 AN

## BILLET ALUMINUM Y BLOCKS (WITH 1/8" NPT PORT)



Part No.	Size
10821	1/2" NPT x dual 3/8" NPT
10820	3/8" NPT x dual 3/8" NPT
10822	1/2" NPT x dual 1/2" NPT

## MALE AN TO MALE NPT UNION ADAPTERS WITH 1/8" NPT PORT



Part No.	AN Size	NPT Size
16495	-6AN	1/4" NPT
16496	-6AN	3/8" NPT
16497	-8AN	1/4" NPT
16498	-8AN	3/8" NPT

## MALE AN UNION ADAPTERS WITH 1/8" NPT PORT



Part No.	Size
16474	-4AN
16476	-6AN
16478	-8AN

## FEMALE TO MALE AN UNION ADAPTERS WITH 1/8" NPT PORT



Part No.	Male Size	Female Size
16484	-4AN	-4AN
16486	-6AN	-6AN
16488	-8AN	-8AN

## PUSH-ON EFI ADAPTER FITTINGS



Part No.	AN Size	Hose Size
16880	-6AN	5/16"
16881	-6AN	3/8"

## QUICK DISCONNECT EFI ADAPTER FITTINGS



Part No.	AN Size	Hose Size
16885	-6AN	5/16"
16886	-6AN	3/8"

## BILLET ALUMINUM LINE SEPARATORS

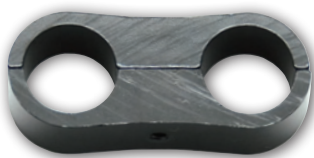

Part No.	Size (I.D.)	Part No.	Size (I.D.)
20605	4.8mm	20612	12.7mm
20606	6.4mm	20613	13.5mm
20608	7.9mm	20614	14.3mm
20609	9.5mm	20616	15.9mm
20611	11.1mm	20617	16.7mm

## HOSE CUTTING SHEARS

These heavy duty hose shears are ideal for achieving clean, easy cuts of Vibrant Braided and Non-Braided Flex Hoses.

For use on -3AN to -20AN hose



Part No. 2989

## STAINLESS STEEL CUSHIONED P-CLAMPS

Secure your hose lines with these lightweight Stainless Steel Clamps lined with Neoprene rubber cushioning.



15mm band width

Part No.	Size (I.D.)
17190	Pack of 10, Stainless Steel Cushion Clamps for 1/4" (-4AN) hose
17191	Pack of 10, Stainless Steel Cushion Clamps for 3/8" (-6AN) hose
17192	Pack of 10, Stainless Steel Cushion Clamps for 1/2" (-8AN) hose
17193	Pack of 10, Stainless Steel Cushion Clamps for 5/8" (-10AN) hose
17194	Pack of 10, Stainless Steel Cushion Clamps for 3/4" (-12AN) hose
17195	Pack of 10, Stainless Steel Cushion Clamps for 1" (-16AN) hose
17196	Pack of 10, Stainless Steel Cushion Clamps for 1-1/4" (-20AN) hose
17197	Pack of 10, Stainless Steel Cushion Clamps for 1-1/2" (-24AN) hose

## STAINLESS STEEL PINCH CLAMPS

Made from 300 series Stainless Steel. Provides 360 degree sealing without gaps. Smooth inner band avoids hose/tube damage.



Clamping Range	Pack of 2 Part No.	Pack of 10 Part No.	Clamping Range	Pack of 2 Part No.	Pack of 10 Part No.
6.0 - 7mm	12250	12270	14.5 - 17.0mm	12256	12276
7.0 - 8.7mm	12251	12271	16.0 - 19.2mm	12257	12277
7.8 - 9.5mm	12252	12272	17.8 - 21.0mm	12258	12278
9.4 - 11.9mm	12253	12273	20.3 - 23.5mm	12260	12280
11.3 - 13.8mm	12254	12274	22.4 - 25.6mm	12261	12281
12.8 - 15.3mm	12255	12275	25.4 - 28.6mm	12262	12282

## FUEL INJECTOR STYLE MINI HOSE CLAMPS

9mm wide clamp band. Made from Zinc Plated Mild Steel. Rounded edges ensure the clamp grips firmly without cutting the hose. Great for fuel, vacuum and windshield washer lines.



Clamping Range	Pack of 2 Part No.	Pack of 10 Part No.	Clamping Range	Pack of 2 Part No.	Pack of 10 Part No.
7mm - 9mm	12210	12230	12mm - 14mm	12215	12235
8mm - 10mm	12211	12231	13mm - 15mm	12216	12236
9mm - 11mm	12212	12232	14mm - 16mm	12217	12237
10mm - 12mm	12213	12233	15mm - 17mm	12218	12238
11mm - 13mm	12214	12234	16mm - 18mm	12219	12239

- Use 11-13mm Clamps for 1/4" ID Fuel Injector Hoses
- Use 13-15mm Clamps for 5/16" ID Fuel Injector Hoses
- Use 14-16mm Clamps for 3/8" ID Fuel Injector Hoses

## ALUMINUM AN WRENCHES



Part No.	Description
20904	Aluminum AN Wrench -4AN
20906	Aluminum AN Wrench -6AN
20908	Aluminum AN Wrench -8AN
20910	Aluminum AN Wrench -10AN
20912	Aluminum AN Wrench -12AN
20916	Aluminum AN Wrench -16AN
20989	Set of 6 Wrenches (AN4 TO AN16)

## ALUMINUM CRUSH WASHERS



Part No.	Description	Size
20923	Pack of 10 Aluminum Crush Washers	-3AN (10mm)
20924	Pack of 10 Aluminum Crush Washers	-4AN (11mm)
20926	Pack of 10 Aluminum Crush Washers	-6AN (14mm)
20928	Pack of 10 Aluminum Crush Washers	-8AN (18mm)
20930	Pack of 10 Aluminum Crush Washers	-10AN (22mm)
20932	Pack of 10 Aluminum Crush Washers	-12AN (27mm)
20936	Pack of 10 Aluminum Crush Washers	-16AN (33mm)
20998	Box Set, Aluminum Crush Washers Contains 10 of each washer	-3AN to -16AN

## CLEAN CUT ADHESIVE TAPE

Vibrant Performance Clean Cut Adhesive Tape makes it easier to professionally cut braided flex hose, with virtually no fraying.

Use only the White Adhesive Tape when cutting Stainless Steel Braided Hoses. When cutting Nylon Braided hose, you must first apply a wrap of clear tape, followed by an application of the White Tape.



Part No. 2970



Part No. 2971

Part No.	Description
2970	2 Meter (6-1/2 ft) Roll of White clean cut tape
2971	5 Meter (16-1/2 ft) Roll of Clear clean cut tape

## ADJUSTABLE AN WRENCH



Part No.	Description
20992	Adjustable AN Wrench, -3AN to -12AN

## BILLET ALUMINUM VISE JAWS



Part No. 20990

## FKM RUBBER O-RINGS



Part No.	Description	Size
20883	Pack of 10 Rubber O-Rings	-3AN
20884	Pack of 10 Rubber O-Rings	-4AN
20886	Pack of 10 Rubber O-Rings	-6AN
20888	Pack of 10 Rubber O-Rings	-8AN
20890	Pack of 10 Rubber O-Rings	-10AN
20892	Pack of 10 Rubber O-Rings	-12AN
20896	Pack of 10 Rubber O-Rings	-16AN
20999	Box Set, Rubber O-Rings Contains 10 of each washer	-3AN to -16AN

## ALUMINUM WELD ON RADIATOR FILLER NECKS AND RAD CAPS

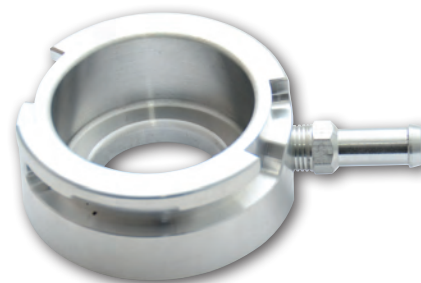

Part No.	Description
20980	Weld On Radiator Filler Neck - 32mm (1.25") ID
20981	Radiator Cap for Part #20980
20982	Weld On Radiator Filler Neck - 42mm (1.65") ID
20983	Radiator Cap for Part #20982

## WELD BUNGS

Vibrant Performance offers an extensive selection of Aluminum and Mild Steel Weld Bungs. Ideal for use with Aluminum Radiators, Oil Pans, custom tank fabrication and any other project that requires customized plumbing.

### MALE AN BUNGS

Bung Size/Thread	Aluminum Part No.	Mild Steel Part No.
Male -4 AN 7/16 - 20 SAE Thread, 3/4" Flange OD	11150	11250
Male -6 AN 9/16 - 18 SAE Thread, 7/8" Flange OD	11151	11251
Male -8 AN 3/4 - 16 SAE Thread, 1" Flange OD	11152	11252
Male -10 AN 7/8 - 14 SAE Thread, 1-1/8" Flange OD	11153	11253
Male -12 AN 1-1/16 - 12 SAE Thread, 1-3/8" Flange OD	11154	11254
Male -16 AN 1-5/16 - 12 SAE Thread, 1-5/8" Flange OD	11155	11255
Male -20 AN 1-5/8 - 12 SAE Thread, 1-3/4" Flange OD	11156	11256



### FEMALE AN BUNGS



Bung Size/Thread	Aluminum Part No.	Mild Steel Part No.
Female -4 AN, 7/16" -20 Thread, 3/4" OD	11160	11260
Female -6 AN, 9/16" -18 Thread, 7/8" OD	11161	11261
Female -8 AN, 3/4" -16 Thread, 1" OD	11162	11262
Female -10 AN, 7/8" -14 Thread, 1-1/8" OD	11163	11263
Female -12 AN, 1-1/16" -12 Thread, 1-3/8" OD	11164	11264
Female -16 AN, 1-5/16" -12 Thread, 1-5/8" OD	11165	11265

### FEMALE NPT BUNGS

Bung Size/Thread	Aluminum Part No.	Mild Steel Part No.
Female 1/8" - 27 NPT, 3/4" OD	11170	11270
Female 1/4" - 18 NPT, 7/8" OD	11171	11271
Female 3/8" - 18 NPT, 1" OD	11172	11272
Female 1/2" - 14 NPT, 1-1/4" OD	11173	11273
Female 3/4" - 14 NPT, 1-3/8" OD	11174	11274
Female 1" - 11 1/2 NPT, 1-5/8" OD	11175	N/A



### LARGE DIAMETER WELD BUNGS WITH ALUMINUM CAPS

- Weld Bungs available in Mild Steel and T6061 Aluminum
- Aluminum Thread-on Caps available in Polished or Anodized Black finish



Description	Part No.
2" OD Aluminum Weld Bung + Polished Aluminum Threaded Cap	11290
2" OD Aluminum Weld Bung + Black Aluminum Threaded Cap	11291
2" OD Steel Weld Bung + Polished Aluminum Threaded Cap	11292
2" OD Steel Weld Bung + Black Aluminum Threaded Cap	11293
2.75" OD Aluminum Weld Bung + Polished Aluminum Threaded Cap	11294
2.75" OD Aluminum Weld Bung + Black Aluminum Threaded Cap	11295
2.75" OD Steel Weld Bung + Polished Aluminum Threaded Cap	11296
2.75" OD Steel Weld Bung + Black Aluminum Threaded Cap	11297

## UNIVERSAL CATCH CANS

Vibrant Performance offers the most versatile Universal Catch Cans on the market. Made entirely from T6061 Aluminum, it is suitable for various types of service: Oil, Fluid (i.e. Coolant) and even Vacuum.

Measuring 3" OD x 8 1/4" long out of the box, Vibrant Catch Cans give users the option of being cut down to length to accommodate the available space in your engine bay. The top End Cap is pressure fit and can be removed in order to shorten the Cannister. The bottom End Cap threads on to the Cannister for added security. Both End Caps feature multiple tapped ports for ultimate flexibility (plugs are supplied for unused ports). A pair of threaded One-Touch Elbow Fittings and an 8" length of clear Polyethylene Tubing are also included in the kit to serve as a fluid level gauge.

Top End Cap is pressure fit

Each End Cap features 6 threaded ports, tapped for 1/2" NPT fittings.

Bottom End Cap now threads on for added security. O-ring is included to ensure a leak free seal.



Each End Cap also features a port tapped for 3/4" NPT fittings, perfect for running a breather filter off your Catch Can.

All Vibrant Performance Catch Cans include a unique mounting bracket that provides the installer enormous flexibility when trying to determine the best way to mount the Catch Can.

Part No.	Description
12688	3" O.D. Universal Catch Can - Anodized Silver
12689	3" O.D. Universal Catch Can - Anodized Black

## CATCH CAN FILTER KIT

This kit includes a 1" I.D. Crankcase Breather Filter and 1" O.D. Aluminum Male Fitting, tapped to thread into the 3/4" NPT port found on Vibrant Performance Catch Cans.

Part No. 12672

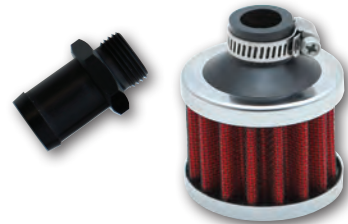

## ALUMINUM THREAD-ON VACUUM SCAVENGER

Vibrant's unique Thread-on Vacuum Scavenger is designed to allow you to pull excess vacuum from your motor without having to modify your valve cover. This can help in a variety of ways, including ensuring that unburned fuel vapours are removed from the motor to avoid oil contamination. It also helps with "blow by" on boosted motors.

The Adapter threads onto OE Honda / Acura oil filler necks. No welding is required. The low profile design provides excellent hood clearance. The outlet port is tapped for a 1/4" NPT Fitting (a 1/4" NPT x -8AN Adapter Fitting is included). We also include a threaded Aluminum Oil Cap but you can use your stock Honda / Acura oil cap if you prefer. Includes FKM Rubber O-Rings for a leak free seal.



Part No.	Application
12670	Aluminum Vacuum Scavenger for Honda / Acura Motors - Polished

Vibrant Performance has teamed up with DCI Performance Products™ of Australia to bring DCI's industry leading Heat and Acoustic Shielding products to the North American Automotive High Performance aftermarket. Over the past 15 years, DCI has been making a name for themselves as a respected Tier 1 and Tier 2 supplier of shielding solutions for many of the world's leading car makers. Their brand has also become a staple for many of the top race teams in Australia and North America. Their patented technology allows them to create superior heat and acoustic shields that are lightweight, recyclable, easy to install and cost effective.



## HEAT SHIELDS

Don't let heat affect the integrity of your car or the quality and comfort of your ride. SHEETHOT™ shielding products from DCI protect your car and its components from heat damage and prevents heat transfer to the interior.

### SHEETHOT™ TF-600 Heat Shield

TF-600 Heat Shields are ideal for use on underbody components where rigid and robust shielding is required. Suitable for up to 1100°F (600°C).

### SHEETHOT™ TF-400 Heat Shield

TF-400 Heat Shields are ideal when easy manipulation of the shielding is needed for proper installation on underbody components. Suitable up to 1100°F (600°C).

### SHEETHOT™ FLEX ADHESIVE

Ideal for shielding areas of your vehicle where mechanical fasteners can't be used (e.g. fuel tanks, certain engine bay components, etc.). The adhesive backing makes installation easy. Suitable up to 490°F (255°C).



Part No.	Description	Sheet Size
25400L	SHEETHOT™ TF-400 Heat Shield – Large Sheet	26 3/4" x 17" (680mm x 430mm)
25400S	SHEETHOT™ TF-400 Heat Shield – Small Sheet	11 3/4" x 9" (300mm x 230mm)
25600L	SHEETHOT™ TF-600 Heat Shield – Large Sheet	26 3/4" x 17" (680mm x 430mm)
25600S	SHEETHOT™ TF-600 Heat Shield – Small Sheet	11 3/4" x 9" (300mm x 230mm)
25200L	SHEETHOT™ FLEX ADHESIVE – Large Sheet	39 1/4" x 20" (1000mm x 500mm)



## XT-1000 AND XT-5000 HEAT SHIELDS

High Performance vehicles and High Temperatures go hand in hand. Unfortunately, extreme heat can affect your car's output as well as potentially causing serious damage to vehicle components. SHEETHOT EXTREME™ XT-1000 and XT-5000 Heat Shields deliver an effective solution, protecting your car from heat damage and allowing you to maximize performance and longevity. These are ideal for exhaust manifolds and turbo systems.



Part No.	Description	Sheet Size
25000L	XT-5000 Heat Shield (Suitable up to 1830°F)	31" x 11-1/2" (790mm x 290mm)
25000S	XT-5000 Heat Shield (Suitable up to 1830°F)	11 3/4" x 9" (300mm x 230mm)
25010L	XT-1000 Heat Shield (Suitable up to 1650°F)	31" x 11-1/2" (790mm x 290mm)

### TECH TIP

- Use a cardboard template to determine shape, size and form of the required shield.
- When cutting your template, be sure to add an extra 3/8" (approx 10mm) all around to allow for folded edges.
- These shielding materials can be easily cut using sharp scissors or tin snips.
- Fold edges over before forming/shaping the shield to prevent layer separation, increase shield strength and to avoid cuts.
- Mechanical fasteners such as screws, bolts, pop rivets and stainless steel clamps are recommended for attachment. Custom brackets may be required in some cases.
- Where possible, allow a 3/8"-3/4" (10mm-20mm) air gap between the shield and the component being shielded.
- When handling these materials, always wear gloves and safety glasses. Cover all skin that may come in contact with the material.
- Neither Vibrant Performance nor DCI Performance Products will accept responsibility for any harm incurred due to improper usage of these or other products.





## ACOUSTIC SHIELDS

Don't let irritating noises affect ride quality and comfort! DCI'S QUIETSHEET™ Acoustic Shields significantly reduce unwanted noise from making its way into your vehicle's cabin and will make driving a significantly more enjoyable experience.



### QUIETSHEET™ Diamond Acoustic Shields

Ideal for sound deadening / absorption and is intended for Direct-to-Surface application. Features an adhesive backing to provide hassle free installation. Suitable up to 390°F (200°C).

Part No.	Description	Sheet Size
25700L	QUIETSHEET™ Diamond Acoustic Shield	27-1/2" x 10-1/4" (70mm x 260mm)
25770L	QUIETSHEET™ Diamond Acoustic Shield	30" x 26-3/4" (760mm x 680mm)

#### TECH TIP

- It is recommended that this product is heated with a hair dryer / heat gun during installation.
- Ensure surfaces are clean and dry, free from grease and dirt.
- As this is a self-adhering shield, no fasteners are required. Suitable for interior or exterior use.



## PREFORMED HEAT SHIELDS

DCI offers SHEETHOT™ Pipe Shields for mounting directly to straight sections of tubing as well as to sections of tubing that are bent at 90 degrees. Made from the same material as the TF-600 SHEETHOT™ material (6 layer dimpled Aluminum). Suitable for temperatures up to 1100°F (600°C). Easy to install.

### Pipe Shields for straight tubing

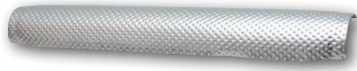

Part No.	Description
25312	SHEETHOT™ Preformed Pipe Shield for 2"-3" O.D. Straight Tubing (1 foot length)
25324	SHEETHOT™ Preformed Pipe Shield for 2"-3" O.D. Straight Tubing (2 foot length)
25526	SHEETHOT™ Preformed Pipe Shield for 5" O.D. Straight Tubing (26" length)

### Pipe Shields for 90 degree bends

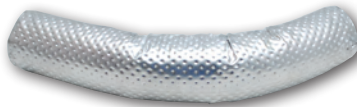

Part No.	Description
25390	SHEETHOT™ Preformed 90 degree Pipe Shield for 2"-3" O.D. tubing (8" radius bend, 18" long)
25590	SHEETHOT™ Preformed 90 degree Pipe Shield for 5" O.D. tubing (11" bend radius, 20" long)

## TURBO SHIELD

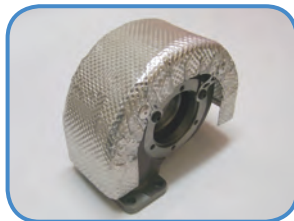

Part No. 25035

DCI's preformed Turbo Shield is designed to fit up to Garrett's GT30/35 Turbo Housing. Includes mounting hardware. Made from the same material as the XT-5000 material which is suitable for temperatures up to 1830°F (1000°C).

## STARTER MOTOR HEAT SHIELD KIT

These universal Heat Shield kit is designed to suit 63mm to 85mm starter motors. Made from the TF-600 SHEETHOT™ material. This kit includes Heat Shield, brackets, rivets and installation instructions. Some assembly required.

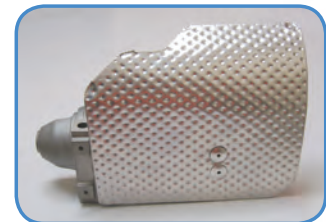

Part No. 25696

## ENGINE MOUNT HEAT SHIELD KIT

This universal Heat Shield kit is able to fit to a wide variety of engine mounts. Made from the TF-600 SHEETHOT™ material this kit includes Heat Shield, brackets, rivets and installation instructions. Some assembly required.



Part No. 25695

## ALUMINUM TAPE



Part No.	Description
25120	20ft roll of Aluminum Tape
25150	165ft (50 meter) roll of Aluminum Tape

# HOSE PROTECTION SOLUTIONS

## FLEXIBLE SPLIT SLEEVING



These lightweight, Flexible Braided Sleeves are easy to install due to the unique self-wrapping split braid that allows for the addition or removal of wires, hoses or cables without complete disassembly. As an added bonus, there is no need for fasteners like Velcro or tape, as these sleeves feature a 25% edge overlap and allow tight radius bending without distorting or splitting open.

It is recommended to cut this type of sleeving with a hot knife to prevent fraying.

Nominal Size	Sleeve Length	Part No.
1/4"	10ft	25800
1/2"	10ft	25801
3/4"	10ft	25802
1"	5ft	25804
1 1/2"	5ft	25806

Available in Black Only.

## HEAT PROTECT FLEXIBLE SLEEVING



These silicone wrapped fiberglass sleeves are ideal when you require protection from constant temperatures up to 500°F.

The Heat Protect sleeving is highly flexible and is engineered to protect hoses, cables and wire harnesses from damage caused by exposure to extreme heat, open flame and weld sparks. It will also contain radiant heat, saving nearby components from heat damage. This sleeving will resist automotive chemicals and solvents and provides protection from abrasions, punctures and moisture.

Nominal Size	2ft Length Part No.	5ft Length Part No.	Use with AN Hose
1/2"	25840	25810	-4
5/8"	25845	25815	-6
3/4"	25841	25811	-8
7/8"	25842	25812	-10
1"	25843	25813	-12
1 1/4"	25846	25816	-16
1 1/2"	25847	25817	-20

Available in Black Only.

## EXTREMESHIELD 1200 FLEXIBLE TUBING



ExtremeShield Flexible Tubing provides easy slip-on installation and outstanding protection for your wires, hoses and cables from temperatures up to 1200 deg F.

This product features an aluminized heat shield that is laminated to tightly braided fiberglass insulation which provides superior protection from radiant heat.

This tubing is not expandable so be sure to measure your application carefully.

Nominal Size	Sleeve Length	Part No.
1/2"	5ft	25820
3/4"	5ft	25821
1"	5ft	25822
1 1/4"	5ft	25823
1 1/2"	5ft	25824

Available in Silver Only.

## EXTREMESHIELD 1400 FLEXIBLE REFLECTIVE WRAP



Our popular EXTREMESHIELD 1400 Thermal Wrap is designed for easy installation on lines and hoses that are difficult to disassemble. Features an Aluminized outer layer that is bonded to insulating self-wrapping Fiberglass.

Simply wrap the pre-formed split tubing around your components and seal it with the high temperature adhesive strip included to provide protection from hot engine components. Tested to withstand and reflect temperatures (up to 1400 deg. F). Cuts cleanly with a simple pair of scissors

Nominal Size	Sleeve Length	Part No.
1/2"	4ft	25830
3/4"	4ft	25831
1"	4ft	25832
1 1/4"	4ft	25833
1 1/2"	4ft	25834

## SPARK PLUG BOOT INSULATOR



Protect your spark plug wires at the connection to the boot with these easy, slip on braided Fiberglass Insulation Sleeves. Protects up to 1200 deg F and requires no clearance from heat source

Part No.	Size	Quantity	Color
25890	3/4" dia	4 / pack	Natural
25891	3/4" dia	4 / pack	Black

## STAINLESS STEEL CABLE TIES



Our Stainless Steel Cable Ties are ideal for installing/securing heavy duty and high temp sleeving. Easy to install without special tools.

Size	Quantity	Part No.
7.5" long ties	10 / pack	25895
14.5" long ties	10 / pack	25898

# REPLACEMENT WINDSHIELD WASHER BOTTLE KITS

The factory windshield washer bottle installed on most vehicles is a major inconvenience because they are often very large and take up so much space. This is especially true for anyone who has ever installed a turbocharger or supercharger on their car, or simply needed to free up space in their engine bay. Many people simply remove the stock bottle and hope they will never need it. Vibrant Performance now offers a choice of two compact universal washer bottle kits that include everything you need to replace the OEM bottle.



Bottle dimension: 7 7/8" Tall x 5 1/4" Wide x 4 1/4" Deep

Part No.	Description
10400	Windshield Washer Bottle Replacement Kit (1.2L Bottle)
10405	Replacement Electric Pump for 1.2L bottle



Bottle dimension: 7 3/4" Tall x 6 1/4" Wide x 4 3/4" Deep

Part No.	Description
10402	Windshield Washer Bottle Replacement Kit (1.8L Bottle)
10406	Replacement Electric Pump for 1.8L bottle



Each kit includes a high quality plastic Washer Bottle, Electric Pump, Electric Plug with wire, Mounting Bracket and a Length of Hose to adapt to the factory system.

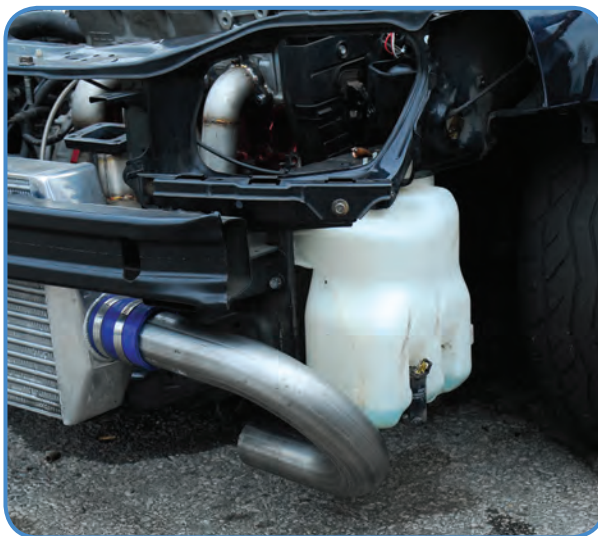

Huge OEM washer bottle can create significant clearance problems.



Vibrant Performance washer bottles are very compact allowing much more space for aftermarket add-ons.

# EXHAUST MANIFOLD FLANGES

## 3/8" Thick Stainless Steel Exhaust Manifold Flanges

- port sizing optimized for use with standard wall round tubing



Part No. 1460M



Part No. 14464

## 1/2" Thick Mild Steel Exhaust Manifold Flanges

- port sizing optimized for use with Sch. 10 or Sch. 40 pipe



Part No. 14610F

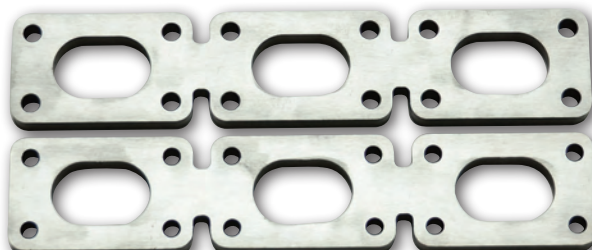

Part No. 14636

Part No.	Application
14227	Audi 2.7T motor (2 flanges per set)
14336	BMW E36/E46 motors (2 flanges per set)
14464	Ford 4.6L (32 valve) DOHC motors (2 flanges per set)
14462	Ford 4.6L (16 valve) SOHC motors (2 flanges per set)
14302	Ford 260-351W (2 flanges per set)
1460E	GM Ecotec motor
14331	GM LT1/L98/LB9 Small Block (2 flanges per set)
14332	GM LS1/LS2/LS3/LS6/L92 motor (2 flanges per set)
1460	Honda/Acura B-Series motor
1460D	Honda/Acura D-Series motor
1460F	Honda F20C motor
1460H	Honda H22 motor
1460K	Honda/Acura K-Series motor
14224	Honda K24 installed in 2012+ Honda Civic Si
1460M	Mitsubishi 4G63 motor
1460A	Nissan KA24 motor
1460R	Nissan RB25/RB26 motor
1460S	Nissan SR20 motor
14256	Nissan VK56 motor (2 flanges per set)
14296	Porsche 996/911 motor (2 flanges per set)
14930	Porsche 930/911 motor (6 flanges per set)
14220	Subaru EJ20 motor (4 flanges per set)
1460J	Toyota 2JZ motor
1460T	Toyota 2AZ-FE motor
1460V	VW/Audi 1.8T motor
14320V	VW/Audi 2.0FSI motor
14325	VW 2.5L 5cyl motor (Available 2005 and up)

Part No.	Application
14627	Audi 2.7T motor (2 flanges per set)
14636	BMW E36/E46 motors (2 flanges per set)
14630	GM Ecotec motor
14610	Honda/Acura B-Series motor
14610D	Honda/Acura D-Series motor
14610F	Honda F20C motor
14610H	Honda H22 motor
14610K	Honda/Acura K-Series motor
14724	Honda K24 motor installed in 2012+ Honda Civic Si
14634	Hyundai Theta 2.0L motor (Genesis 2.0T)
14611	Mitsubishi 4B11 motor
14663	Mitsubishi 4G63 motor
14624	Nissan KA24 motor
14625	Nissan RB25/RB26 motor
14620N	Nissan SR20 motor
14635	Nissan R35 GTR motor (2 flanges per set)
14696	Porsche 996/911 motor (2 flanges per set)
14610J	Toyota 2JZ motor
14633	Toyota 2AZ-FE motor
14618	VW/Audi 1.8T motor
14620V	VW/Audi 2.0FSI motor
14725	VW/Audi 2.5L 5cyl motor (Available 2005 and up)

# STAINLESS STEEL MANDREL BENDS

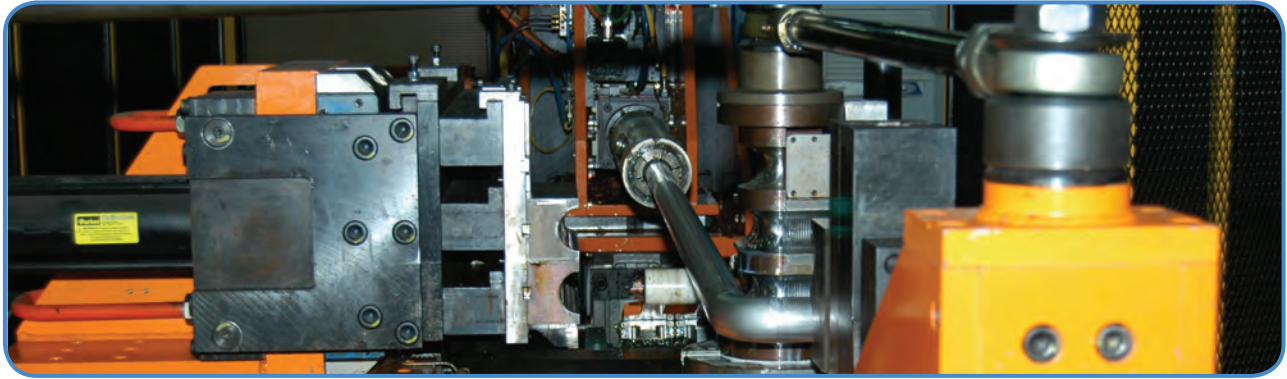

## T304 STAINLESS STEEL OVAL MANDREL BENDS



Part No.	Nominal Size	Bend Angle	Tube Thickness	Centerline Radius
13189	3"	45 deg. (horizontal)	16 gauge	4 1/2"
13191	3"	90 deg. (horizontal)	16 gauge	4 1/2"
13200	3"	45 deg. (vertical)	16 gauge	4 1/2"
13202	3"	90 deg. (vertical)	16 gauge	4 1/2"
13192	3 1/2"	45 deg. (horizontal)	16 gauge	5 1/4"
13194	3 1/2"	90 deg. (horizontal)	16 gauge	5 1/4"

All Oval Bends feature 6" leg lengths

## T304 S.S. OVAL TUBING, STRAIGHT LENGTHS

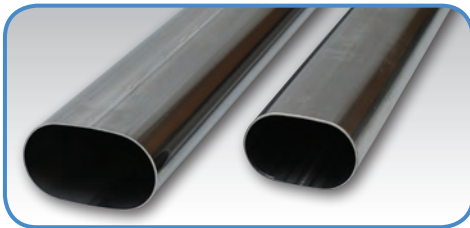

Part No.	Nominal Size	Tube Thickness	Overall Length
13182	3"	16 gauge	5 ft.
13183	3 1/2"	16 gauge	5 ft.
13184	4"	16 gauge	5 ft.

Please note: Overall length tolerance = +/- 2"

## T304 S.S. OVAL TO ROUND TRANSITIONS

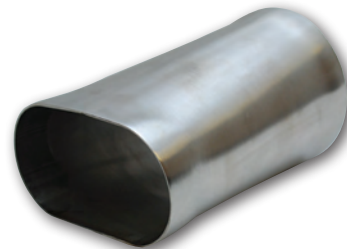

Part No.	Description	Overall Length
13170	3" Oval (nom.) to 3" Round	6"
13171	3 1/2" Oval (nom.) to 3 1/2" Round	6"
13172	4" Oval (nom.) to 4" Round	6"

### TECH TIP

The nominal size listed for oval tubing approx. equals the equivalent diameter for like-size round tubing.

Nominal Size	Actual Tube Size
3"	2.20" x 3.45"
3.5"	2.375" x 4.125"
4"	2.60" x 4.80"

## T304 S.S. OVAL FLANGES



Part No.	Description
13175S	Fits 3" Nom. Oval tubing
13176S	Fits 3 1/2" Nom. Oval tubing
13177S	Fits 4" Nom. Oval tubing

Please Note: Vibrant also offers Genuine Torca® Stainless Steel Easy Seal Exhaust Sleeve Clamps which permit effective clamping of our 3", 3 1/2" and 4" nominal oval tubing (please refer to pg. 75).

## U-J MANDREL BENDS

Vibrant U-J Mandrel Bends give you a 180° bend, a 45° bend and a straight leg, making them an economical option for custom fabricators because each piece can yield up to three separate bends and a straight section.

Ideal for custom fabricating exhaust systems, headers and intercooler pipes.

Available in T304 Stainless Steel and Aluminized (Mild) Steel.

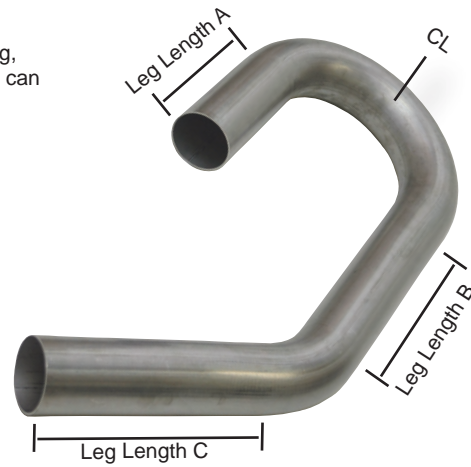

### T304 STAINLESS STEEL U-J MANDREL BENDS

Tube O.D.	Tube Thickness	Centerline Radius	Leg Length A	Leg Length B	Leg Length C	T304 Stainless Steel Part No.
1 1/2"	16 gauge	3"	4"	7"	10"	2601
1 5/8"	16 gauge	2 1/4"	4 1/2"	8"	9"	2602
1 3/4"	16 gauge	3 1/2"	4 1/2"	8"	8"	2603
1 7/8"	16 gauge	3"	6"	7"	12"	2604
2"	16 gauge	4"	4 1/2"	7"	7"	2605
2 1/4"	16 gauge	3 1/2"	4 1/2"	8"	8"	2607
2 1/2"	16 gauge	3 1/2"	5"	7"	8"	2609
2 3/4"	16 gauge	4 1/8"	6"	7"	11"	2615
3"	16 gauge	5"	6 1/2"	9"	12"	2611
3 1/2"	16 gauge	5 3/4"	7"	9"	9"	2612
4"	16 gauge	6"	7 1/2"	8 1/2"	10"	2613

### ALUMINIZED MILD STEEL U-J MANDREL BENDS

Tube O.D.	Tube Thickness	Centerline Radius	Leg Length A	Leg Length B	Leg Length C	Aluminized (Mild) Steel Part No.
1 1/2"	16 gauge	3"	5"	8"	8"	12601
1 3/4"	16 gauge	3 1/2"	5"	7"	7"	12603
2"	16 gauge	4"	4"	9"	12"	12605
2 1/4"	16 gauge	3 1/2"	4"	8"	12"	12607
2 1/2"	16 gauge	4 1/4"	5"	8"	12"	12609
3"	16 gauge	5"	8"	10"	23"	12611
3 1/2"	16 gauge	5"	7"	13"	21"	12612
4"	16 gauge	6"	7"	8"	8"	12613

### WALL MOUNT BRACKET

These powder coated Steel Brackets make it easy to organize your inventory of Vibrant Performance Mandrel Bends and Straight Tubing.

Part No. 2995



## T304 S.S. 180° BENDS

Part No.	Tube O.D.	Tube Thickness	Centerline Radius	Leg Length A	Leg Length B
2618	1 1/4"	16 gauge	2 3/4"	4"	4"
2619	1 3/8"	16 gauge	2 3/8"	4"	4"
2620	1 1/2"	16 gauge	1 1/2"	4"	4"
2694	1 1/2"	16 gauge	2 3/8"	4"	4"
2621	1 5/8"	16 gauge	1 5/8"	4"	4"
2695	1 5/8"	16 gauge	2 1/8"	4"	4"
2622	1 3/4"	16 gauge	1 3/4"	4"	4"
2696	1 3/4"	16 gauge	2 5/8"	4"	4"
2623	1 7/8"	16 gauge	2"	6"	6"
2697	1 7/8"	16 gauge	3"	5"	5"
2624	2"	16 gauge	2"	4"	4"
2698	2"	16 gauge	2 1/2"	4"	4"
2625	2 1/8"	16 gauge	3 1/8"	4"	4"
2626	2 1/4"	16 gauge	3 3/8"	5"	5"
2627	2 3/8"	16 gauge	3 1/2"	5"	5"
2628	2 1/2"	16 gauge	3 1/2"	5"	5"
2629	2 3/4"	16 gauge	4 1/8"	5"	5"
2656	3"	16 gauge	5"	5"	5"
2657	3 1/2"	16 gauge	5 1/2"	5"	5"
2658	4"	16 gauge	6"	5"	5"
2659	5"	14 gauge	7 1/2"	5"	5"

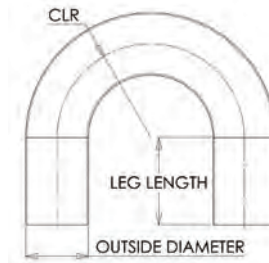

## T304 S.S. 120° BENDS

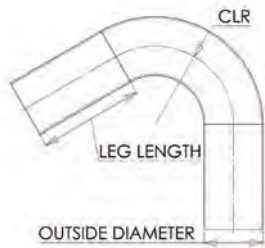

Part No.	Tube O.D.	Tube Thickness	Centerline Radius	Leg Length A	Leg Length B
13000	1 1/4"	16 gauge	2 3/4"	4"	12"
13001	1 3/8"	16 gauge	2 3/8"	4"	12"
13002	1 1/2"	16 gauge	1 1/2"	4"	12"
13003	1 5/8"	16 gauge	1 5/8"	4"	12"
13004	1 3/4"	16 gauge	1 3/4"	4"	12"
13005	1 7/8"	16 gauge	2"	6"	12"
13006	2"	16 gauge	2"	4"	12"
13007	2 1/8"	16 gauge	3 1/8"	4"	12"
13008	2 1/4"	16 gauge	3 3/8"	4"	12"
13009	2 3/8"	16 gauge	3 1/2"	4"	12"
13010	2 1/2"	16 gauge	3 1/2"	4"	12"
13012	3"	16 gauge	5"	4"	12"

### TECH TIP

Customers often ask us what type of filler rod should be used when welding all the different products we offer. The following is a quick reference guide for the most commonly asked questions:

For Welding 304 S.S. to 304 S.S. use 308 filler rod  
 For Welding 304 S.S. to 321 S.S. also use 308 filler rod  
 For Welding 304 S.S. to Mild Steel, use 309 filler rod

For welding 6061-T6 Aluminum, we suggest either 5356 or 4043 filler rod. 5356 is stronger, more ductile and most suitable if you intend to anodize the aluminum after welding. 4043 is more crack resistant, especially if you intend to heat treat the aluminum and it will perform better if the aluminum product you are welding is exposed to elevated temperatures (150 deg. F and up).

Please refer to page 65 of this catalog to view the full offering of Vibrant Performance TIG Weld Wires.

Part No.	Tube O.D.	Tube Thickness	Centerline Radius	Leg Length A	Leg Length B
13030	1 1/4"	16 gauge	2 3/4"	4"	12"
13031	1 3/8"	16 gauge	2 3/8"	4"	12"
13032	1 1/2"	16 gauge	1 1/2"	4"	12"
13033	1 5/8"	16 gauge	1 5/8"	4"	12"
13034	1 3/4"	16 gauge	1 3/4"	4"	12"
13035	1 7/8"	16 gauge	2"	6"	12"
13036	2"	16 gauge	2"	4"	12"
13050	2"	16 gauge	2 1/2"	4"	12"
13037	2 1/8"	16 gauge	3 1/8"	4"	12"
13038	2 1/4"	16 gauge	3 3/8"	4"	12"
13039	2 3/8"	16 gauge	3 1/2"	4"	12"
13051	2 1/2"	16 gauge	2 1/2"	4"	12"
13040	2 1/2"	16 gauge	3 1/2"	4"	12"
13052	2 3/4"	16 gauge	2 3/4"	4"	12"
13041	2 3/4"	16 gauge	4 1/8"	4"	12"
13053	3"	16 gauge	3"	4"	12"
13042	3"	16 gauge	5"	4"	12"
13043	3 1/2"	16 gauge	5 1/2"	6"	6"
13044	4"	16 gauge	6"	6"	6"
13045	5"	14 gauge	7 1/2"	6"	6"

### T304 S.S. 90° BENDS

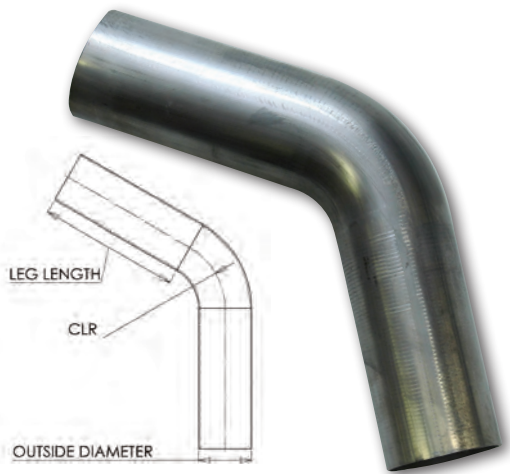

### T304 S.S. 60° BENDS

Part No.	Tube O.D.	Tube Thickness	Centerline Radius	Leg Length A	Leg Length B
13062	1 1/2"	16 gauge	1 1/2"	6"	6"
13064	1 3/4"	16 gauge	1 3/4"	6"	6"
13066	2"	16 gauge	2"	6"	6"
13068	2 1/4"	16 gauge	3 3/8"	6"	6"
13070	2 1/2"	16 gauge	3 1/2"	6"	6"
13071	2 3/4"	16 gauge	4 1/8"	6"	6"
13072	3"	16 gauge	5"	6"	6"
13073	3 1/2"	16 gauge	5 1/2"	6"	6"
13074	4"	16 gauge	6"	6"	6"

### T304 S.S. 45° BENDS

Part No.	Tube O.D.	Tube Thickness	Centerline Radius	Leg Length A	Leg Length B
13092	1 1/2"	16 gauge	1 1/2"	6"	6"
13094	1 3/4"	16 gauge	1 3/4"	6"	6"
13095	1 7/8"	16 gauge	2"	6"	6"
13096	2"	16 gauge	2"	6"	6"
13098	2 1/4"	16 gauge	3 3/8"	6"	6"
13100	2 1/2"	16 gauge	3 1/2"	6"	6"
13101	2 3/4"	16 gauge	4 1/8"	6"	6"
13102	3"	16 gauge	5"	6"	6"
13103	3 1/2"	16 gauge	5 1/2"	6"	6"
13104	4"	16 gauge	6"	6"	6"
13105	5"	14 gauge	7 1/2"	6"	6"





### T304 S.S. 15° BENDS

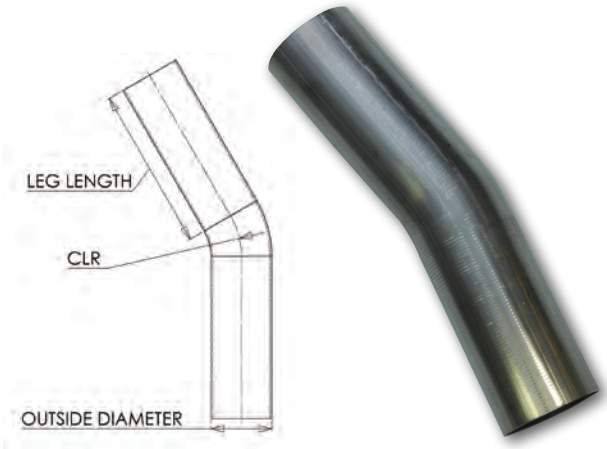

Part No.	Tube O.D.	Tube Thickness	CLR	Leg Length
13122	1 1/2"	16 gauge	1 1/2"	4"x4"
13124	1 3/4"	16 gauge	1 3/4"	4"x4"
13126	2"	16 gauge	2"	4"x4"
13127	2 1/8"	16 gauge	3 1/8"	5"x5"
13128	2 1/4"	16 gauge	3 3/8"	5"x5"
13130	2 1/2"	16 gauge	3 1/2"	5"x5"
13132	3"	16 gauge	5"	5"x5"

### T304 S.S. ROUND TUBING, STRAIGHT LENGTHS

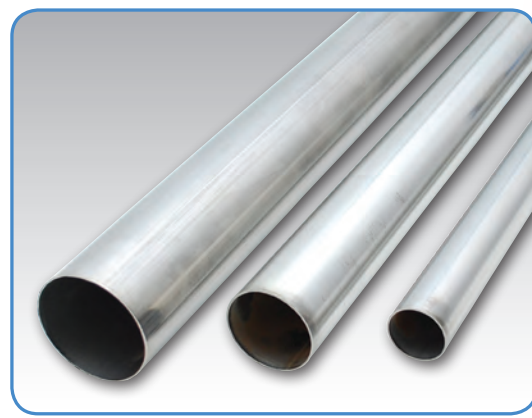

Part No.	Tube O.D.	Tube Thickness	Overall Length
2634	1 1/4"	16 gauge	5 ft.
2635	1 3/8"	16 gauge	5 ft.
2636	1 1/2"	16 gauge	5 ft.
2637	1 5/8"	16 gauge	5 ft.
2638	1 3/4"	16 gauge	5 ft.
2639	1 7/8"	16 gauge	5 ft.
2645	2"	16 gauge	5 ft.
2646	2 1/8"	16 gauge	5 ft.
2640	2 1/4"	16 gauge	5 ft.
2647	2 3/8"	16 gauge	5 ft.
2641	2 1/2"	16 gauge	5 ft.
2648	2 3/4"	16 gauge	5 ft.
2642	3"	16 gauge	5 ft.
2643	3 1/2"	16 gauge	5 ft.
2644	4"	16 gauge	5 ft.
2649	5"	16 gauge	5 ft.

### T304 S.S. CONCENTRIC REDUCERS



Part No.	Description
2685	1 1/2" x 2" Reducer, 2" overall length
2686	2" x 2 1/2" Reducer, 2" overall length
2630	2 1/2" x 3" Reducer, 2" overall length
2632	3" x 4" Reducer, 4" overall length

Please note: Overall length tolerance = +/- .2"

### TIG WELD WIRES

Vibrant Performance now offers a wide array of TIG Weld Wires in several popular material grades and thicknesses.

Vibrant Weld Wire offers outstanding weld properties so that you can lay down a top quality bead.

Sold in cost effective 1lb. and 3lb. pre-packs. Only buy what you need!

Call to inquire about Bulk Quantities.



Material Grade	Rod Thickness	Rod Length	1lb Box Part No.	3lb Box Part No.
Stainless - ER308L	0.035" (0.9mm)	36"	29131	29133
	0.045" (1.2mm)	36"	29141	29143
	0.062" (1.6mm)	36"	29161	29163
Stainless - ER309L	0.035" (0.9mm)	36"	29231	29233
	0.045" (1.2mm)	36"	29241	29243
	0.062" (1.6mm)	36"	29261	29263
Aluminum - ER4043	0.062" (1.6mm)	36"	29461	29463
	0.09" (2.3mm)	36"	29491	29493
Aluminum - ER5356	0.062" (1.6mm)	36"	29561	29563
	0.09" (2.3mm)	36"	29591	29593
Chromoly - ER70S-2	0.045" (1.2mm)	36"	29741	29743
	0.062" (1.6mm)	36"	29761	29763
Chromoly - ER80S-2	0.045" (1.2mm)	36"	29841	29843
	0.062" (1.6mm)	36"	29861	29863

# STAINLESS STEEL MERGE COLLECTORS

Vibrant Performance offers a comprehensive, high quality and affordably priced range of T304 Stainless Steel Merge Collectors to help free up maximum horsepower from your exhaust setup.

All Vibrant Performance Merge Collectors feature complete T304 Stainless Steel construction, precise fabrication, top quality TIG welds at every seam and hand porting inside the collector for smooth, unobstructed exhaust flow.

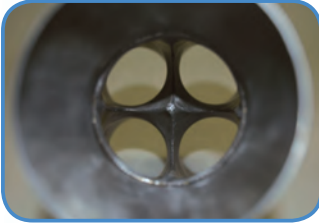

Close up view of inside of a Vibrant Performance Merge Collector.

## 4 INTO 1 MERGE COLLECTORS

Part No.	Inlet Slipover ID	Inlet Tubing Length	Outlet OD	Transition Cone Length	Cone Outlet OD
10302	1 3/4"	7"	2 1/2"	3 3/4"	3"
10303	1 3/4"	7"	3"	3 3/4"	3 1/2"
10305	1 7/8"	7 1/2"	2 1/2"	3 3/4"	3"
10306	1 7/8"	7 1/2"	3"	3 3/4"	3 1/2"
10307	1 7/8"	7 1/2"	3 1/2"	3 3/4"	4"
10308	2"	7 3/4"	3"	3 3/4"	3 1/2"
10309	2"	7 3/4"	3 1/2"	3 3/4"	4"
10312	2 1/8"	7 1/8"	3 1/2"	4"	4"
10313	2 1/8"	7 1/8"	4"	4"	4 1/2"
10316	2 1/4"	7 3/8"	3 1/2"	4"	4"
10317	2 1/4"	7 3/8"	4"	4"	4 1/2"

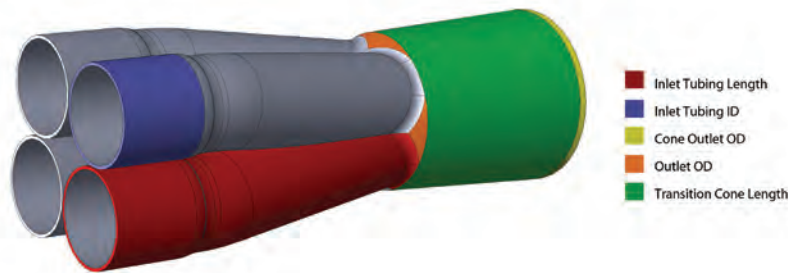

### HOW DO MERGE COLLECTORS WORK:

In order to maximize torque and horsepower, a vehicle's header and exhaust system must optimize exhaust gas velocity. Anything that reduces exhaust gas speed will negatively impact performance. A header featuring a conventional collector generally suffers from a significant reduction in exhaust gas velocity at the transition from the primaries into the collector. This drop in velocity will decrease volumetric efficiency and reduce scavenging ability. This is key because optimizing volumetric efficiency of an exhaust system allows for improved air/fuel mixture in the combustion chamber, thereby improving an engine's horsepower and torque production potential.

A properly fabricated Merge Collector significantly minimizes the exhaust gas velocity loss at the transition from primary tubes to the collector and as a result, the volumetric efficiency potential of an exhaust system is significantly improved.

To get maximum benefit from Merge Collectors, dyno testing is crucial to ensure your set up is able to realize its full potential.

## 2 INTO 1 MERGE COLLECTORS

Vibrant Performance 2 into 1 Merge Collectors are ideal for a variety of custom exhaust fabrication projects, including building X-pipes or creating a slip fit Tri-Y Merge Collector setup. You can expect to pick up some extra horsepower simply by swapping out your car's OEM 2 into 1 transition with one of these Vibrant Y-style Merge Collectors.

All Vibrant 2 into 1 Merge Collectors are precision manufactured entirely from T304 Stainless Steel and feature top quality TIG welds.

Part No.	Inlet Slipover ID	Outlet OD	A	B
10350	1 1/2"	1 3/4"	5.5"	7"
10351	1 5/8"	2"	5.5"	7"
10352	1 3/4"	2"	5.5"	7"
10353	1 3/4"	2 1/4"	6"	7.5"
10354	1 7/8"	2 1/4"	6.5"	7.5"
10355	2"	2 1/2"	5.5"	8"
10356	2 1/4"	3"	6.75"	8.75"
10357	2 1/2"	2 1/2"	7.75"	9.75"
10358	2 1/2"	3"	6.75"	9"
10359	2 1/2"	3 1/2"	6.5"	9.75"
10360	3"	3"	8.75"	10.75"
10361	3"	3 1/2"	8.5"	10.5"
10362	3"	4"	8"	10"

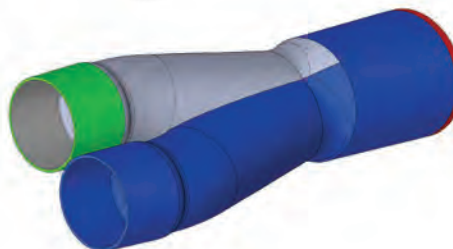

- Inlet Slipover ID
- Outlet OD
- Inlet Tubing Length "A"
- Overall Length "B"

## WELD ON COLLECTOR TAB SET

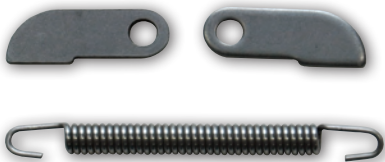

Spring length is 3 1/2"

Part No.	Description
10340	Set of S.S. collector tabs, (2 tabs, 1 spring)

## STAINLESS STEEL DOUBLE SLIP JOINT FITTINGS

- T304 Stainless Steel construction
- Three piece, leak free connection provides lowest possible profile exhaust connection on the market
- Eliminates any ground clearance issues
- Great for making tubular Turbo Manifolds and Dump Tubes as well as being popular for motorcycle exhaust fabrication
- Slip Fit tolerances will tighten after heat cycle and welding

Part No.	Description
13282	For use with 1 1/2" O.D. tubing
13284	For use with 1 3/4" O.D. tubing
13286	For use with 2" O.D. tubing
13290	For use with 2 1/2" O.D. tubing
13292	For use with 3" O.D. tubing

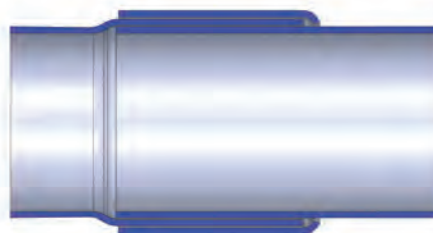

## STAINLESS STEEL FLEXIBLE COUPLINGS

Vibrant Power Inc. is a world leader in the design and production of Stainless Steel Flexible Couplings. Vibrant Flexible Couplings are engineered to isolate vibration generated by the engine, thereby relieving stress on your vehicle's exhaust system. They will reduce premature cracking of manifolds and downpipes and help extend the life of other components.

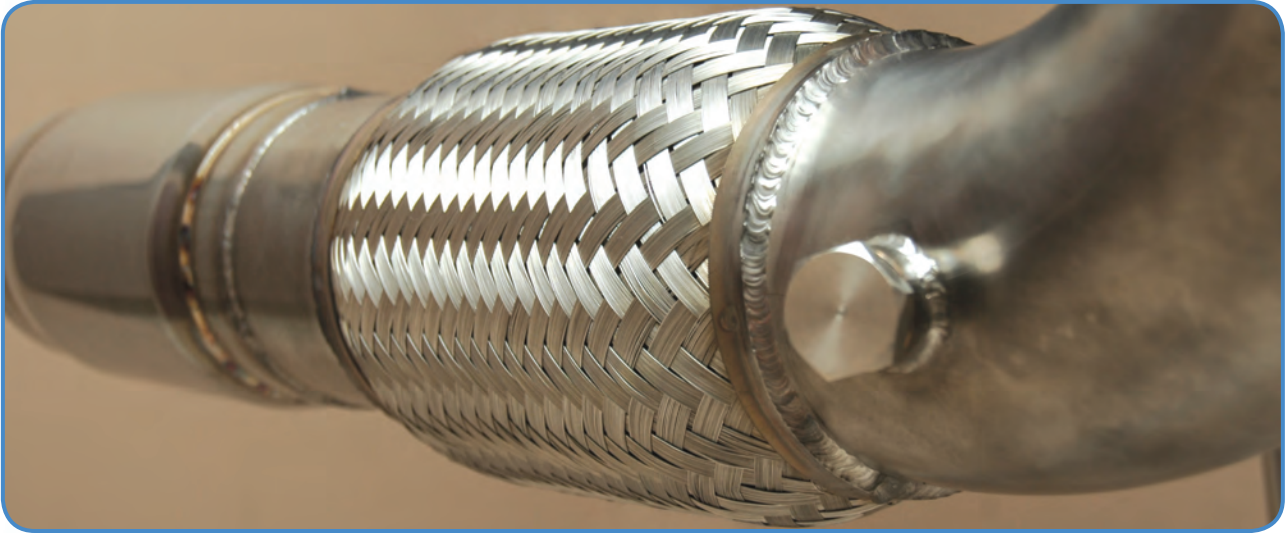

### STAINLESS STEEL BELLOWS ASSEMBLIES (WITH SOLID LINER)



- Features a directional, smooth flow solid liner.
- Full T304 Stainless Steel construction, including Weld Necks.

Part No.	Inlet / Outlet I.D.	Flex Length
67327	1 1/2" (38.1mm)	2 3/4" (63.5mm)
67425	1 3/4" (44.9mm)	2 1/2" (63.5mm)
67527	1 7/8" (47.6mm)	2 3/4" (63.5mm)
67632	2" (50.8mm)	3 1/4" (82.5mm)

### TURBO FLEX WITH INTERLOCK LINER

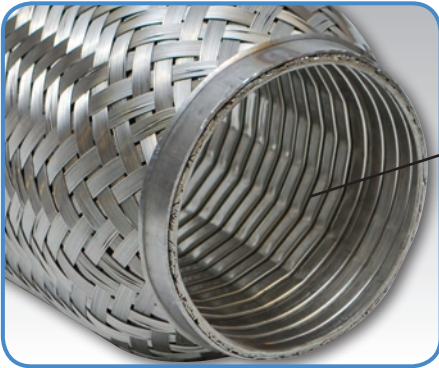

Vibrant's Turbo Flex Coupling features an internal Stainless Steel Interlock Liner to facilitate smooth flow of high temperature exhaust gases. Recommended for all high flowing, high temperature applications (e.g. forced induction).

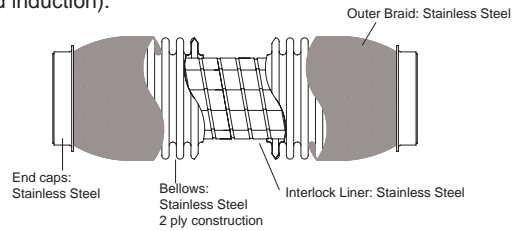

Part No.	Inlet/Outlet I.D.	Flex Length
60404	1 3/4" (44.9mm)	4" (102mm)
60604	2" (51.3mm)	4" (102mm)
60704	2 1/4" (57.1mm)	4" (102mm)
60804	2 1/2" (63.5mm)	4" (102mm)
60806	2 1/2" (63.5mm)	6" (152mm)
60808	2 1/2" (63.5mm)	8" (203mm)
60810	2 1/2" (63.5mm)	10" (254mm)
61004	3" (76.2mm)	4" (102mm)
61006	3" (76.2mm)	6" (152mm)

Part No.	Inlet/Outlet I.D.	Flex Length
61008	3" (76.2mm)	8" (203mm)
61010	3" (76.2mm)	10" (254mm)
61108	3 1/2" (89mm)	8" (203mm)
61110	3 1/2" (89mm)	10" (254mm)
61208	4" (101.6mm)	8" (203mm)
61210	4" (101.6mm)	10" (254mm)
61408	5" (127mm)	8" (203mm)
61410	5" (127mm)	10" (254mm)

## STANDARD FLEX COUPLINGS WITH INNER BRAID LINER

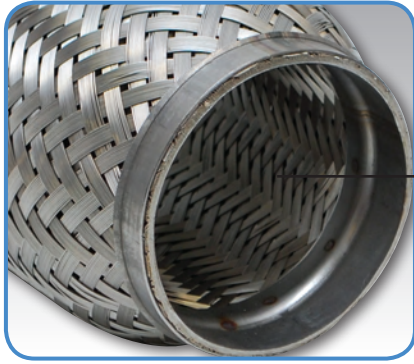

### TECH TIP

Best Suited for Naturally Aspirated applications. Not recommended for Forced Induction Applications.

Vibrant Flex Couplings with Inner Braid Liner provide laminar flow while retaining flexibility in the coupling itself. The Inner Braid protects the Bellows from premature failure, and is ideal for eliminating exhaust “whistle”.

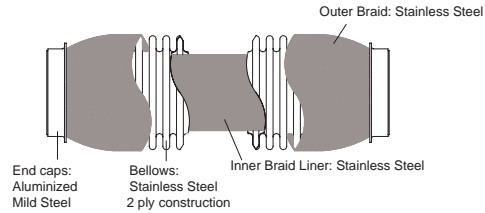

Part No.	Inlet/Outlet I.D.	Flex Length
62304	1 1/2" (38.6mm)	4" (102mm)
62306	1 1/2" (38.6mm)	6" (152mm)
62308	1 1/2" (38.6mm)	8" (203mm)
62404	1 3/4" (44.9mm)	4" (102mm)
62406	1 3/4" (44.9mm)	6" (152mm)
62408	1 3/4" (44.9mm)	8" (203mm)
62410	1 3/4" (44.9mm)	10 1/4" (260mm)
62604	2" (51.3mm)	4" (102mm)
62606	2" (51.3mm)	6" (152mm)
62608	2" (51.3mm)	8" (203mm)
62610	2" (51.3mm)	10" (254mm)

Part No.	Inlet/Outlet I.D.	Flex Length
62704	2 1/4" (57.1mm)	4" (102mm)
62706	2 1/4" (57.1mm)	6" (152mm)
62708	2 1/4" (57.1mm)	8" (203mm)
62804	2 1/2" (63.5mm)	4" (102mm)
62806	2 1/2" (63.5mm)	6" (152mm)
62808	2 1/2" (63.5mm)	8" (203mm)
62810	2 1/2" (63.5mm)	10" (254mm)
63004	3" (76.2mm)	4" (102mm)
63006	3" (76.2mm)	6" (152mm)
63008	3" (76.2mm)	8" (203mm)

## STANDARD FLEX COUPLINGS (WITHOUT INNER LINER)



Our Standard Flex Couplings (without Inner Liner) offer a cost effective solution for isolating vibration and protecting a vehicle's exhaust components from damage.

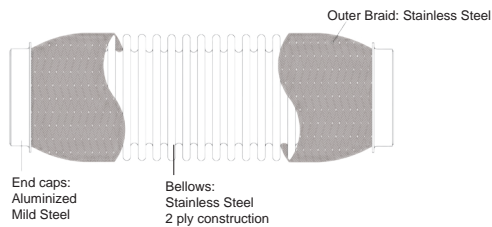

Part No.	Inlet/Outlet I.D.	Flex Length
64304	1 1/2" (38.6mm)	4" (102mm)
64404	1 3/4" (44.9mm)	4" (102mm)
64406	1 3/4" (44.9mm)	6" (152mm)
64408	1 3/4" (44.9mm)	8" (203mm)
64410	1 3/4" (44.9mm)	10" (254mm)
64604	2" (51.3mm)	4" (102mm)
64606	2" (51.3mm)	6" (152mm)
64608	2" (51.3mm)	8" (203mm)
64610	2" (51.3mm)	10" (254mm)

Part No.	Inlet/Outlet I.D.	Flex Length
64704	2 1/4" (57.1mm)	4" (102mm)
64708	2 1/4" (57.1mm)	8" (203mm)
64710	2 1/4" (57.1mm)	10" (254mm)
64806	2 1/2" (63.5mm)	6" (152mm)
64808	2 1/2" (63.5mm)	8" (203mm)
64810	2 1/2" (63.5mm)	10" (254mm)
65006	3" (76.2mm)	6" (152mm)
65008	3" (76.2mm)	8" (203mm)
65010	3" (76.2mm)	10" (254mm)

# OBD1 CATALYTIC CONVERTERS

The Catalytic Converters on this page are suitable for OBD1 vehicles only (1995 or older), excluding those registered in California.

## UNIVERSAL METAL CORE CATALYTIC CONVERTERS

Vibrant Performance Metal Core Catalytic Converters are made entirely of Stainless Steel and feature a Monolith that is far more durable and capable of withstanding higher operating temperatures than a traditional ceramic catalyst. Enjoy up to a 40% improvement in exhaust gas flow over a typical ceramic core converter.

These Converters are covered by a 5 year / 50,000 mile warranty (warranty applicable to outer shell only).

E.P.A. approved for OBD1 only (49 State only).

For use on engines up to 5.0L.

IMPORTANT: These Catalytic Converters are not for use on vehicles registered in California as a result of California Vehicle Code Sec. 27156 and 38391.



### TECH TIP

An overly rich Air/Fuel ratio (i.e. 11.5:1 or lower) or operating temperatures exceeding 1200 degrees can cause premature catalytic converter failure, voiding the warranty.



Vibrant Universal Metal Core Race Converters feature an ultra high flow, 200 cell per square inch catalyst flowing at 578 CFM.

Part No.	Inlet/Outlet	Converter Body O.D.	Overall Length
7100	2 1/4"	4"	10"
7101	2 1/2"	4"	10"
7102	3"	4"	10"

## UNIVERSAL CERAMIC CORE CATALYTIC CONVERTERS

Vibrant Performance Ceramic Core Catalytic Converters feature a substrate that flows more freely than a typical stock converter, thereby improving horsepower by reducing back pressure while still meeting E.P.A. requirements for OBD1 vehicles (49 State).

The shell is constructed from Stainless Steel and is covered by a 5 year / 50,000 mile warranty (warranty applicable to shell only).

IMPORTANT: These Catalytic Converters are not for use on vehicles registered in California as a result of California Vehicle Code Sec. 27156 and 38391.

### Round ceramic core converters

Part No.	Inlet / Outlet	Converter Body O.D.	Overall Length
7000	2"	5 1/4"	12"
7001	2 1/4"	5 1/4"	13"
7038	2 1/2"	5 1/4"	13"
7039	3"	5 1/4"	13"

### Oval ceramic core converters

Part No.	Inlet / Outlet	Converter Body Dimensions	Overall Length
7002	2"	6 1/4" x 4"	13"
7003	2 1/4"	6 1/4" x 4"	13"
7013	2 1/2"	6 1/4" x 4"	13"
7029	3"	6 1/4" x 4"	16"



**Please Note:** Aftermarket converters are only permitted if your vehicle does not have a converter or if a government emissions testing program has determined that the existing converter needs replacement. It is prohibited by law in the United States and Canada to remove a properly functioning catalytic converter.

Say goodbye to Converter Failures, Check Engine Lights and failed emissions tests on your high performance vehicle.

Vibrant Performance and Global Emissions Systems Inc. (GESi®) have teamed up to supply a series of OBD2 (1996 and newer) high flow Catalytic Converters that provide peace of mind and reliability under extreme conditions while providing highly effective long term emission control solutions.

GESi® is a recognized global leader in the design, engineering and production of emission control systems for all types of fuel burning engines, whether it be spark, rotary or compression. Their technology has been proven effective on engines that burn all varieties of commercial fuels, including gasoline, propane, natural gas, diesel and bio-diesel.



The GESi® sponsored Team Go Green Pro-Mod Camaro

For the automotive sector, GESi® possesses proprietary emissions reduction technology that sets their Catalytic Converters apart and offers a solution to owners of high performance vehicles who simply cannot find Catalytic Converters capable of consistently surviving the extreme conditions that those engines create.

## GESI® HIGH OUTPUT AND ULTRA HIGH OUTPUT UNIVERSAL OBD2 COMPLIANT CATALYTIC CONVERTERS

GESi® High Output (HO-series) and Ultra High Output (UHO-series) Universal Catalytic Converters provide a reliable solution to the most common Converter problems experienced by owners of high performance vehicles.

- EPA certified for use on OBD2 vehicles (1996 and newer) in jurisdictions where the installation of Universal Catalytic Converters is still permitted (check with local authorities before installation).
- Full stainless steel construction, including the Substrate which is furnace braised to the mantle for outstanding, unparalleled durability.
- Unique end-cap design locks substrate into place. No More Rattling!
- GESi® has proprietary precious metal loading technology that ensures greatly reduced emissions, eliminating almost all CEL issues.
- Capable of withstanding up to 1500° F.
- Ideal for forced induction applications, with virtually no loss of exhaust flow (less than 1% flow degradation).
- Covered by a 5 year / 50,000 mile warranty (on shell and tube ends only)
- These are the best high flow Catalytic Converters money can buy.



### HO-series Catalytic Converters (rated for 350-500HP)

Part No.	Inlet / Outlet	Converter Body O.D.	Overall Length
7525	2 1/2"	4"	7"
7530	3"	4"	7"

### UHO-series Catalytic Converters (rated for 500-850HP)

Part No.	Inlet / Outlet	Converter Body O.D.	Overall Length
7830	3"	4 1/2"	7 1/2"
7840	4"	4 1/2"	7 1/2"

### VEHICLE EMISSIONS INSPECTION REPORT

Overall Result	Emissions	Evaporative Systems	Equipment Inspection	Smoke	OBD Codes
<b>PASS</b>	<b>PASS</b>	<b>PASS</b>	<b>PASS</b>	<b>PASS</b>	<b>PASS</b>

### EMISSIONS TEST INFORMATION

	READINGS	LIMITS	RESULTS
HC GPM	0.0430	1.200	<b>PASS</b>
CO GPM	0.540	15.000	<b>PASS</b>
NOx GPM	0.059	1.5000	<b>PASS</b>
Check Engine Light			<b>PASS</b>

These are typical emissions test results enjoyed by owners of high performance vehicles who run GESi® Catalytic Converters

## GESI® UNIVERSAL CERAMIC CORE CATALYTIC CONVERTERS



Please note: These catalytic converters are not legal for use on vehicles registered in California as a result of California Vehicle Code Sec. 27156 and 38391.

GESi® Ceramic Core High Flow Catalytic Converters feature the same precious metal loading technology incorporated into the High Output Metal Core Converters and the large, high flowing Ceramic Honeycomb Catalyst performs significantly better than a typical stock Converter and will put an end to most "Check Engine Light" problems.

The external shell features full stainless steel construction, including a mirror polished heat shield. Covered by a 5 year / 50,000 mile warranty (on shell and tube ends only).

Part No.	Inlet/Outlet	Dimensions
7225	2 1/2"	7 1/4" x 3 3/4" oval, 12" Body Length (18" overall length)
7230	3"	7 1/4" x 3 3/4" oval, 12" Body Length (18" overall length)

## V-BAND FLANGE ASSEMBLIES

V-Band Flanges are an excellent alternative to traditional flanged or slip fit tube connections. Offering a low profile and modular connection, V-Band Flange Assemblies work especially well under operating conditions involving stress, vibration and significant temperature fluctuations. The V-Band clamp design allows for a quick release, gasket free seal as well as superior positive retention vs. other tube coupling methods.

Vibrant V-Band Flanges feature a unique "Male/Female" design to ensure proper alignment inside the clamp. Flanges are available in both T304 Stainless Steel or T6061 Billet Aluminum construction. V-Band Clamps are made from 300 series Stainless Steel.



Vibrant V-band Flanges feature a unique male/female locking design to ensure proper flange alignment

### STAINLESS STEEL V-BAND FLANGE ASSEMBLIES

(Includes 2 Stainless Steel V-Band Flanges and 1 V-Band Clamp).

Part No.	Description
1486	S.S. V-Band Flange Assembly for 1 1/2" O.D. Tubing
1487	S.S. V-Band Flange Assembly for 1 3/4" O.D. Tubing
1488	S.S. V-Band Flange Assembly for 2" O.D. Tubing
1489	S.S. V-Band Flange Assembly for 2 1/4" O.D. Tubing
1497	S.S. V-Band Flange Assembly for 2 3/8" O.D. Tubing
1490	S.S. V-Band Flange Assembly for 2 1/2" O.D. Tubing
1496	S.S. V-Band Flange Assembly for 2 3/4" O.D. Tubing
1491	S.S. V-Band Flange Assembly for 3" O.D. Tubing
1492	S.S. V-Band Flange Assembly for 3 1/2" O.D. Tubing
1493	S.S. V-Band Flange Assembly for 4" O.D. Tubing
1494	S.S. V-Band Flange Assembly for 5" O.D. Tubing

### STAINLESS STEEL V-BAND FLANGES, INDIVIDUAL

Description	Flange O.D.	Flange Thk.	T304 S.S. Flange Part No.
V-Band Flange for 1 1/2" O.D. Tubing	52mm	9/16"	1486S
V-Band Flange for 1 3/4" O.D. Tubing	59mm	9/16"	1487S
V-Band Flange for 2" O.D. Tubing	65mm	9/16"	1488S
V-Band Flange for 2 1/4" O.D. Tubing	71mm	9/16"	1489S
V-Band Flange for 2 3/8" O.D. Tubing	81mm	5/8"	1497S
V-Band Flange for 2 1/2" O.D. Tubing	81mm	5/8"	1490S
V-Band Flange for 2 3/4" O.D. Tubing	96mm	5/8"	1496S
V-Band Flange for 3" O.D. Tubing	96mm	5/8"	1491S
V-Band Flange for 3 1/2" O.D. Tubing	105mm	5/8"	1492S
V-Band Flange for 4" O.D. Tubing	117mm	5/8"	1493S
V-Band Flange for 5" O.D. Tubing	146mm	5/8"	1494S

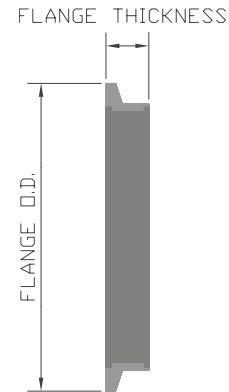





### ALUMINUM V-BAND FLANGE ASSEMBLIES

(Includes 2 Aluminum V-Band Flanges, 1 Stainless Steel V-Band Clamp and 1 FKM Rubber O-Ring)

Part No.	Description
11488	Aluminum V-Band Flange Assembly for 2" O.D. Tubing
11490	Aluminum V-Band Flange Assembly for 2 1/2" O.D. Tubing
11491	Aluminum V-Band Flange Assembly for 3" O.D. Tubing
11492	Aluminum V-Band Flange Assembly for 3 1/2" O.D. Tubing
11493	Aluminum V-Band Flange Assembly for 4" O.D. Tubing

Just like our Stainless Steel V-Band assemblies, Vibrant Aluminum V-band Flange Kits feature a unique male/female locking design to ensure proper flange alignment.

#### TECH TIP

- Aluminum V-Band Flanges are not recommended for:
- High heat applications (350°C max)
  - For exhaust applications before the Catalytic Converter

### ALUMINUM V-BAND FLANGES, INDIVIDUAL

Description	Flange O.D.	Flange Thk.	Aluminum Flange Part No.	Replacement O-Ring Part No.
V-Band Flange for 2" O.D. Tubing	65mm	9/16"	11488S	11488R
V-Band Flange for 2 1/2" O.D. Tubing	81mm	5/8"	11490S	11490R
V-Band Flange for 3" O.D. Tubing	96mm	5/8"	11491S	11491R
V-Band Flange for 3 1/2" O.D. Tubing	105mm	5/8"	11492S	11492R
V-Band Flange for 4" O.D. Tubing	117mm	5/8"	11493S	11493R



An FKM Rubber O-Ring is included with our Aluminum V-band Flange sets. Replacement O-Rings are also available for purchase.

### STAINLESS STEEL V-BAND CLAMPS (QUICK RELEASE)

- Features complete 300 series Stainless Steel Construction
- Hardware has been upgraded for added durability



Part No.	Description
1486C	S.S. V-Band Clamp Assembly for 1 1/2" V-Band Flanges
1487C	S.S. V-Band Clamp Assembly for 1 3/4" V-Band Flanges
1488C	S.S. V-Band Clamp Assembly for 2" V-Band Flanges
1489C	S.S. V-Band Clamp Assembly for 2 1/4" V-Band Flanges
1490C	S.S. V-Band Clamp Assembly for 2 3/8" & 2 1/2" V-Band Flanges
1491C	S.S. V-Band Clamp Assembly for 2 3/4" & 3" V-Band Flanges
1492C	S.S. V-Band Clamp Assembly for 3 1/2" V-Band Flanges
1493C	S.S. V-Band Clamp Assembly for 4" V-Band Flanges
1494C	S.S. V-Band Clamp Assembly for 5" V-Band Flanges

# STAINLESS STEEL EXHAUST FLANGES

Vibrant Performance Stainless Steel Exhaust Flanges are available in sizes ranging from 2" to 4" I.D. and a choice of 2 and 3 bolt configurations. All Flanges are 3/8" (10mm) thick. They can be purchased individually or in cost effective Boxes of 5.

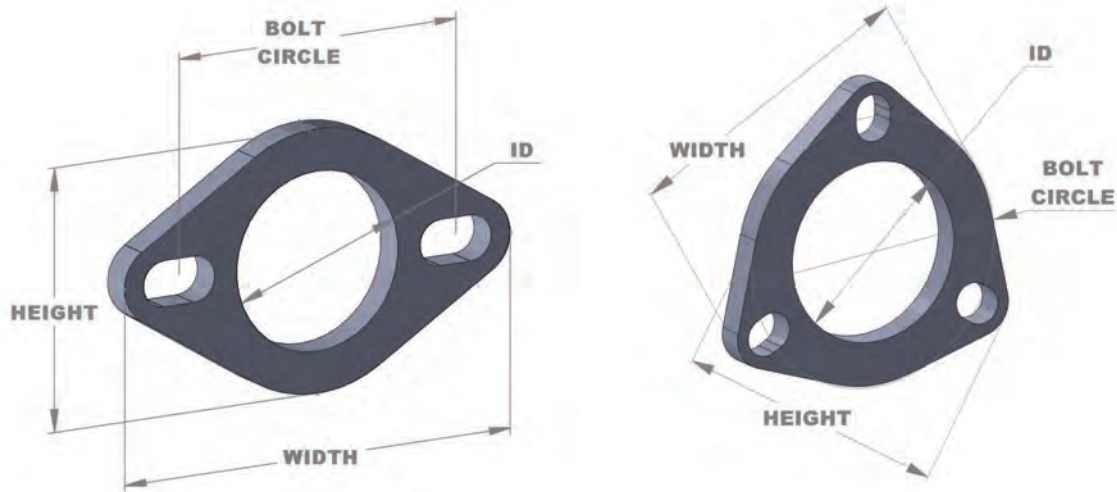

## 2 BOLT EXHAUST FLANGE APPLICATION LIST

Description	Box of 5 Part No.	Single Unit Part No.	Width	Height	Bolt Circle	Thickness	Matching Gasket Part No.
2 Bolt Flange (2" ID)	1470	1470S	4.90" (125mm)	3.00" (76mm)	3.50" (89mm)	3/8" (10mm)	1455
2 Bolt Flange (2.25" ID)	1471	1471S	5.25" (133mm)	3.50" (89mm)	4.00" (100mm)	3/8" (10mm)	1456
2 Bolt Flange (2.5" ID)	1472	1472S	5.25" (133mm)	3.50" (89mm)	4.00" (100mm)	3/8" (10mm)	1457
2 Bolt Flange (2.75" ID)	1474	1474S	5.25" (133mm)	3.66" (93mm)	3.89" (99mm)	3/8" (10mm)	1465
2 Bolt Flange (3" ID)	1473	1473S	5.05" (128mm)	3.70" (94mm)	4.15" (105mm)	3/8" (10mm)	1458
2 Bolt Flange (4" ID)	1475	1475S	6.00" (152mm)	4.40" (111mm)	5.00" (127mm)	3/8" (10mm)	1459

## 3 BOLT EXHAUST FLANGE APPLICATION LIST

Description	Box of 5 Part No.	Single Unit Part No.	Width	Height	Bolt Circle	Thickness	Matching Gasket Part No.
3 Bolt Flange (2.25" ID)	1481	1481S	3.90" (99mm)	3.90" (99mm)	3.25" (82mm)	3/8" (10mm)	1461
3 Bolt Flange (2.5" ID)	1482	1482S	3.90" (99mm)	3.90" (99mm)	3.42" (87mm)	3/8" (10mm)	1462
3 Bolt Flange (2.75" ID)	1485	1485S	4.15" (105mm)	4.15" (105mm)	3.42" (87mm)	3/8" (10mm)	1466
3 Bolt Flange (3" ID)	1483	1483S	4.37" (111mm)	4.31" (109mm)	3.88" (98mm)	3/8" (10mm)	1463
3 Bolt Flange (3.5" ID)	1484	1484S	4.82" (122mm)	4.69" (119mm)	4.46" (113mm)	3/8" (10mm)	1464

**Please Note:**

Vibrant Performance offers T304 Stainless Steel Flanges designed to match our Oval Tubing (please refer to page 61).



**Tech Tip:**

Double Slip Joints provide an effective solution when traditional flanges do not offer enough ground clearance.



## EXHAUST GASKETS (2 BOLT AND 3 BOLT)

Vibrant Performance multi-layer Graphite Gaskets help ensure a proper, leak-free seal for your 2 bolt and 3 bolt flanged connections. These gaskets are suitable for high temperature service and are available in sizes ranging from 2" to 4" ID.



### 2 BOLT GASKETS

Part No.	Description
1455	2" I.D. Gasket
1456	2 1/4" I.D. Gasket
1457	2 1/2" I.D. Gasket
1465	2 3/4" I.D. Gasket
1458	3" I.D. Gasket
1459	4" I.D. Gasket

### 3 BOLT GASKETS

Part No.	Description
1461	2 1/4" I.D. Gasket
1462	2 1/2" I.D. Gasket
1466	2 3/4" I.D. Gasket
1463	3" I.D. Gasket
1464	3 1/2" I.D. Gasket

# EXHAUST CLAMPS

## TC SERIES EXHAUST COUPLERS

Vibrant Performance is pleased to offer genuine Torca® Stainless Steel TC Series High Performance Exhaust Couplers. These heavy duty Clamps allow for very secure sealing of butt-joint connections.

Part No.	Description
1171	S.S. Sleeve Clamp for 2 1/2" O.D. Tubing
1176	S.S. Sleeve Clamp for 2 3/4" O.D. Tubing
1177	S.S. Sleeve Clamp for 3 1/2" O.D. Tubing



## EASY SEAL EXHAUST SLEEVE CLAMPS

Genuine Torca® Stainless Steel Easy Seal Exhaust Sleeve Clamps provide a simple, effective way to connect exhaust system components. Fast, easy and accurate installation - there's no need to separate pipes before clamping.

Part No.	Description
1179	S.S. Sleeve Clamp for 2" O.D. Tubing
1170	S.S. Sleeve Clamp for 2 1/4" O.D. Tubing
1172	S.S. Sleeve Clamp for 3" O.D. Tubing (works with 3" oval tubing)
1174	S.S. Seal Clamp for 3 1/2" O.D. Tubing (works with 3 1/2" oval tubing)
1178	S.S. Seal Clamp for 4" O.D. Tubing (works with 4" oval tubing)

Torca® Easy Seal Clamps also permit effective clamping of Vibrant Performance 3", 3 1/2" and 4" nominal oval tubing.

## EXHAUST SEAL CLAMPS

Vibrant Performance is pleased to offer genuine Torca® Stainless Steel Accuseal Exhaust Clamps, which provide for superior clamping and sealing of overlap joints without permanently distorting the exhaust tubing.

Part No.	Description
1163	S.S. Seal Clamp for 2" O.D. Tubing (1" wide band)
1164	S.S. Seal Clamp for 2 1/4" O.D. Tubing (1" wide band)
1166	S.S. Seal Clamp for 2 1/2" O.D. Tubing (1" wide band)
1169	S.S. Seal Clamp for 2 3/4" O.D. Tubing (1" wide band)
1167	S.S. Seal Clamp for 3" O.D. Tubing (1" wide band)
1162	S.S. Seal Clamp for 3 1/2" O.D. Tubing (1" wide band)
1168	S.S. Seal Clamp for 4" O.D. Tubing (1 1/4" wide band)



## DONUT STYLE EXHAUST GASKETS

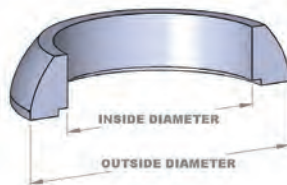

Part No.	Slipover I.D.	Gasket O.D.	Height
2599B	2.55"	3.29"	5/8"
10108G	2.53"	3.37"	1/2"
10530	2.30"	2.70"	5/8"
10531	2.03"	2.53"	5/8"
10532	2.03"	2.59"	1/2"
10533	1.78"	2.34"	1/2"

## EXHAUST SENSOR FITTINGS

### E-VAC SCAVENGER

Vibrant Performance E-Vac Scavenger Kits are designed to pull as much as 3 inch lbs. of vacuum from a typical race engine, improving horsepower and reducing crankcase pressure.

Each kit includes an E-Vac Fitting (available in either T304 Stainless Steel or Mild Steel) that includes an integrated Male -10AN, as well as an angled O2 Bung and a matching Threaded Plug.



Part No.	Description
1189	Stainless Steel E-Vac Scavenger Kit
11189	Mild Steel E-Vac Scavenger Kit

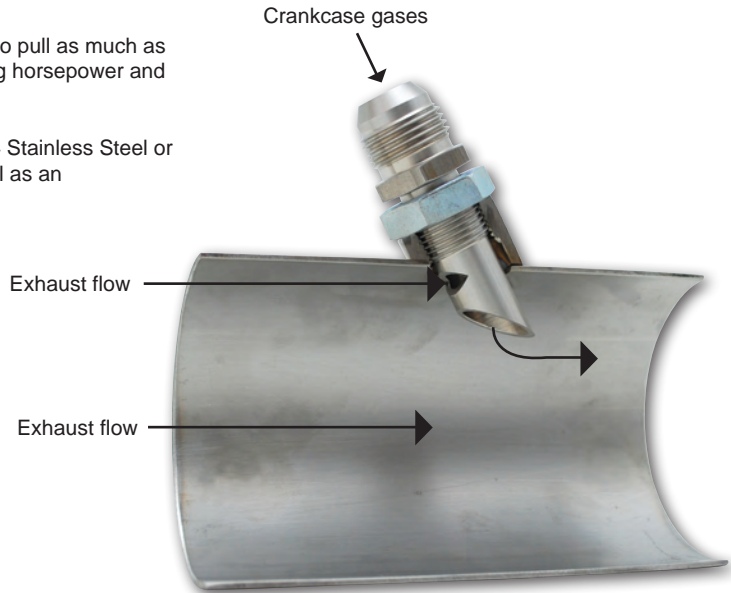

### BILLET ALUMINUM CHECK VALVES

Part No.	Size
11187	-6AN
11190	-8AN
11191	-10AN
11192	-12AN



### OXYGEN SENSOR RESTRICTOR FITTING WITH ADJUSTABLE GAS FLOW INSERTS

- This Fitting has proven to be effective in helping clear stubborn CEL and is simple to install.
- Male end of the Fitting threads into a standard M18 x 1.5 O2 Bung.
- A standard O2 Sensor threads into the female end of this fitting.
- Insert one of the three included inserts to restrict exhaust gas flow to the O2 Sensor and retain in place with included clip.
- Full T304 Stainless Steel Construction.



Part No. 11621



### J-STYLE OXYGEN SENSOR RESTRICTOR FITTING WITH ADJUSTABLE GAS FLOW INSERTS

- This J-Style Restrictor Fitting works just like our original design but allows for easier installation when clearance under the vehicle is an issue.
- Includes jam nut to allow for 360° indexing.
- Full T304 Stainless Steel Construction.

Part No. 11619



**OXYGEN SENSOR FITTINGS  
T304 STAINLESS STEEL  
AND MILD STEEL  
M18 X 1.5 THREAD**

Part No.	Material	Package Quantity
1194A	T304 Stainless Steel	Single Unit, Retail Pack
1194	T304 Stainless Steel	Box of 5, Bulk Pack
11194	T304 Stainless Steel	Box of 100, Bulk Pack
11105	Mild Steel	Single Unit, Retail Pack
11103	Mild Steel	Box of 5, Bulk Pack
11104	Mild Steel	Box of 100, Bulk Pack



**WELD ON "J" STYLE  
OXYGEN SENSOR FITTING  
T304 STAINLESS STEEL  
M18 X 1.5 THREAD**

- Helps Avoid Check Engine Lights



**THREAD-ON "J" STYLE  
OXYGEN SENSOR FITTING  
T304 STAINLESS STEEL  
M18 X 1.5 THREAD**

- Includes Jam Nut to allow for 360° indexing
- Threads into existing M18 x 1.5 O2 Bungs to help eliminate CEL

Part No.	Material	Package Quantity
1192	T304 Stainless Steel	Single Unit, Retail Pack

Part No.	Material	Package Quantity
11620	T304 Stainless Steel	Single Unit, Retail Pack

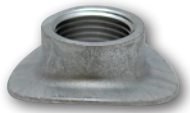

**SADDLE STYLE  
OXYGEN SENSOR FITTINGS  
T304 STAINLESS STEEL  
M18 X 1.5 THREAD**

- Radiused design allows for a cleaner weld to tubing



**45° ANGLED  
OXYGEN SENSOR FITTINGS  
T304 STAINLESS STEEL  
M18 X 1.5 THREAD**

Part No.	Material	Package Quantity
1188	T304 Stainless Steel	Single Unit, Retail Pack
11188	T304 Stainless Steel	Box of 5, Bulk Pack

Part No.	Material	Package Quantity
1193A	T304 Stainless Steel	Single Unit, Retail Pack
1193	T304 Stainless Steel	Box of 5, Bulk Pack



**THREADED HEX BOLTS  
ZINC PLATED MILD STEEL**

- Fits all M18 x 1.5 Threaded Bungs

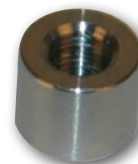

**EGT SENSOR FITTING,  
T304 STAINLESS STEEL  
1/8" NPT THREAD**

Please note:

A 1/8" NPT Threaded Plug is available for this Bung (Part No. 11147)

Part No.	Material	Package Quantity
1195A	Zinc Plated Mild Steel	Single Unit, Retail Pack
1195	Zinc Plated Mild Steel	Box of 5, Bulk Pack
11195	Zinc Plated Mild Steel	Box of 100, Bulk Pack

Part No.	Material	Package Quantity
1197	T304 Stainless Steel	Single Unit, Retail Pack

**OXYGEN SENSOR SOCKET TOOL**

This cut-away Socket Tool is designed to clear the O2 Sensor Wire and simplify removal or installation of O2 Sensors. This sturdy tool is manufactured to withstand the installation torque requirements.

Features a 3/8" drive receiver.



Part No. 11148

# CUSTOM EXHAUST ACCESSORIES

## STAINLESS STEEL HANGER RODS (O.E. STYLE)

Part No.	Description
1198	Box of 10, 400 Series Stainless Steel Hangers (3/8" dia. x 9" long)
1199	Box of 10, 400 Series Stainless Steel Hangers (1/2" dia. x 9" long)
11898	Box of 10, 300 Series Stainless Steel Hangers (3/8" dia. x 9" long)
11899	Box of 10, 300 Series Stainless Steel Hangers (1/2" dia. x 9" long)



## EXHAUST HANGER ROD CLIPS



A simple solution for a common problem.

Universal Hanger Rods often do not match the width of the Rubber Exhaust Hanger, allowing the exhaust to slide freely.

Vibrant's new Hanger Rod Clips, made from Delrin, help solve this problem by filling the gap.

Part No.	Description
1198C	Pack of 2, Hanger Rod Clips for 3/8" O.D. rod
1199C	Pack of 2, Hanger Rod Clips for 1/2" O.D. rod

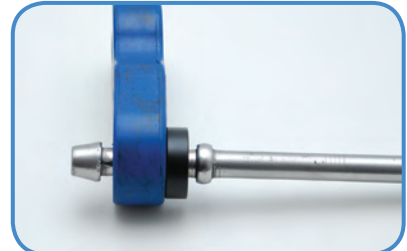

## INNER SILENCER



Part No.	Description
1184	3.90" O.D. Low Restriction Inner Silencer for all TPV Universal Mufflers (2 1/2" dia. tuning tube)

## STAINLESS STEEL FASTENERS



Part No.	Description
1450A	Package of 2 Fastener Sets (2 x M10 bolts, 2 x M10 nuts, & 4 washers)
1450B	Bulk Package of 25 Fastener Sets (25 x M10 bolts, 25 x M10 nuts, & 100 washers)

## SPRING BOLT KITS



10mm GM Style Spring Bolt Kit

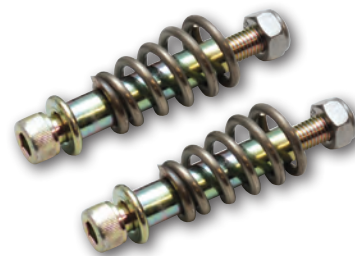

Part No.	Application
10112	2 bolt, 10mm GM style Spring Bolt Kit (2 bolts, 2 nuts & 2 springs)
10113	3 bolt, 10mm GM style Spring Bolt Kit (3 bolts, 3 nuts & 3 springs)

Part No.	Description
2599S	2 bolt, M10 x 1.5 Honda style Spring Bolt Kit (2 bolts, 2 nuts & 2 springs)

Vibrant Performance Stainless Steel Universal Performance Mufflers are made from T304 Stainless Steel. Our "True Straight Through" internals feature a Stainless Steel Perforated Tube that is wrapped in our premium quality, multi-layer sound suppression material that will produce a low, deep tone while allowing for unrestricted flow and maximum horsepower. These Mufflers are not flow directional, allowing the installer the flexibility needed for custom exhaust fabrication.



center - center



center - center



Part No.	Inlet / Outlet I.D.	Muffler Body Height x Width	Body Length	Overall Length
1101	2 1/4"	5" x 9"	15"	19"
1102	2 1/2"	5" x 9"	15"	19"
1132	2 3/4"	5" x 9"	15"	19"
1103	3"	5" x 9"	15"	19"
1135	3 1/2"	5" x 9"	15"	19"
1137	4"	5" x 9"	15"	19"

Part No.	Inlet / Outlet I.D.	Muffler Body O.D.	Body Length	Overall Length
1117	2 1/4"	6"	14"	18"
1118	2 1/2"	6"	14"	18"
1119	3"	6"	14"	18"
1124	3 1/2"	6"	14"	18"
1139	4"	7"	18"	22"



center - offset

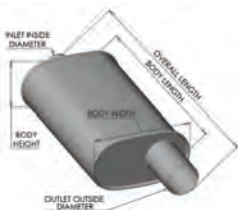

center - dual



Part No.	Inlet / Outlet I.D.	Muffler Body Height x Width	Body Length	Overall Length
1105	2 1/4"	5" x 9"	15"	19"
1106	2 1/2"	5" x 9"	15"	19"
1107	3"	5" x 9"	15"	19"

Part No.	Inlet I.D.	Outlet O.D.	Muffler Body Height x Width	Body Length	Overall Length
1110	2 1/2"	Dual 2 1/4"	5" x 9"	15"	19"
1111	3"	Dual 2 1/2"	5" x 9"	15"	19"

Outlet Center to Center Dimension = 4"



offset - offset

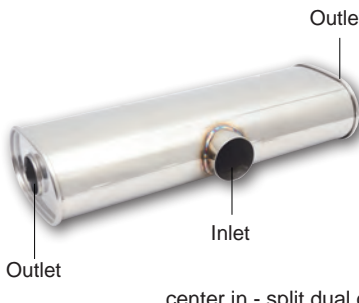

center in - split dual out

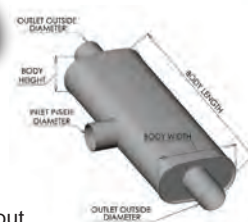

Part No.	Inlet / Outlet I.D.	Muffler Body Height x Width	Body Length	Overall Length
1126	2 1/2"	5" x 9"	15"	19"
1127	3"	5" x 9"	15"	19"

Part No.	Inlet I.D.	Outlet O.D.	Muffler Body Height x Width	Body Length	Overall Length
10632	3"	Dual 2 1/2"	6" x 10"	24"	24"
10633	2 1/2"	Dual 2 1/4"	6" x 10"	24"	24"
10635	3 1/2"	Dual 3"	6" x 10"	24"	24"

Vibrant Performance Flat Black Universal Mufflers feature 100% Stainless Steel construction and our "True Straight Through" internals for unrestricted exhaust gas flow. The perforated core is surrounded by our premium quality sound suppression material that helps produce a low, deep tone. These stealthy mufflers are very popular, especially for avoiding unwanted attention.

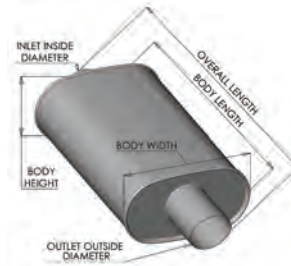

Part No.	Inlet I.D.	Outlet O.D.	Outlet Length	Muffler Body Height x Width	Body Length	Overall Length
1145	2 1/4"	3"	4 1/2"	5" x 9"	15"	21 1/2"
1146	2 1/2"	3"	4 1/2"	5" x 9"	15"	21 1/2"
1147	3"	3"	4 1/2"	5" x 9"	15"	21 1/2"
1153	3 1/2"	3 1/2"	4 1/2"	5" x 9"	15"	21 1/2"
1154	4"	4"	4 1/2"	5" x 9"	15"	21 1/2"

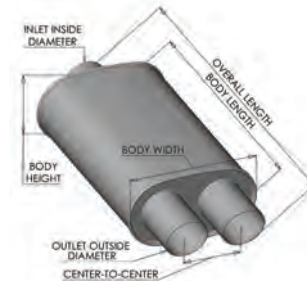

Part No.	Inlet I.D.	Outlet O.D.	Outlet Length	Center to Center	Muffler Body Height x Width	Body Length	Overall Length
1148	2 1/2"	Dual 3"	4 1/2"	4"	5" x 9"	15"	21 1/2"
1149	3"	Dual 3"	4 1/2"	4"	5" x 9"	15"	21 1/2"
1155	4"	Dual 3"	4 1/2"	4"	5" x 9"	15"	21 1/2"

**TPV UNIVERSAL MUFFLERS**

Vibrant Performance TPV Universal Mufflers are designed to withstand the extreme demands of high performance vehicles. They feature T304 Stainless Steel construction, are fully TIG welded for optimum durability and come with "True Straight Through" internals for unrestricted exhaust flow and maximum power gains. We densely pack all TPV mufflers with our premium multi-layer sound suppression materials to ensure a low, deep exhaust note. Suitable for both Naturally Aspirated and Forced Induction applications.



angle cut tip

Part No.	Inlet I.D.	Outlet O.D.	Muffler Body O.D.	Body Length	Overall Length
1056	2 1/2"	4"	6 1/4" O.D.	14"	21"
1061	3"	4"	6 1/4" O.D.	10"	17"
1058	3"	4"	6 1/4" O.D.	14"	21"
1090	4"	4"	6 1/4" O.D.	14"	21"



straight cut tip

Part No.	Inlet I.D.	Outlet O.D.	Muffler Body O.D.	Body Length	Overall Length
1057	2 1/2"	4"	6 1/4" O.D.	14"	21"
1062	3"	4"	6 1/4" O.D.	10"	17"
1059	3"	4"	6 1/4" O.D.	14"	21"
1091	4"	4"	6 1/4" O.D.	14"	21"

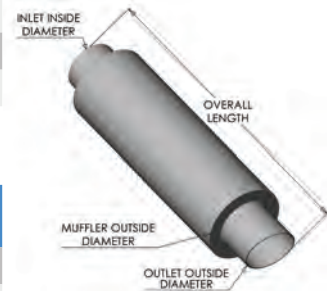



StreetPower Universal Performance Mufflers offer a perfect balance of subtle styling and all out power. These mufflers are constructed from T304 Stainless Steel for optimum durability and corrosion resistance. Each oval bodied muffler shell is densely packed with our premium multi-layer sound suppression material that produces a very distinctive deep exhaust note. Suitable for both Naturally Aspirated and Forced Induction applications.

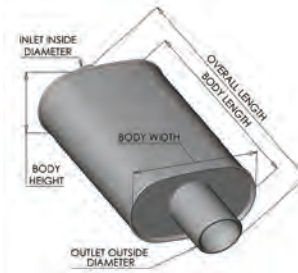
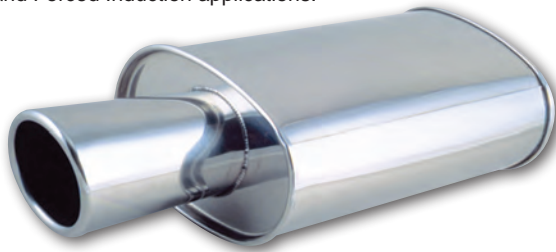

Exhaust Tip Detail: Single Wall, Angle Cut, Rolled Edge

Part No.	Inlet I.D.	Outlet O.D.	Muffler Body Height x Width	Body Length	Overall Length
1046	2 1/2"	4"	5" x 9"	15"	24"
1042	3"	4"	5" x 9"	15"	24"

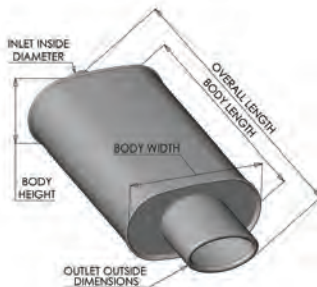

Exhaust Tip Detail: Single Wall, Angle Cut, Rolled Edge

Part No.	Inlet I.D.	Outlet Dim.	Muffler Body Height x Width	Body Length	Overall Length
1034	2 1/2"	4 1/2" x 3" Oval	5" x 9"	15"	24"
1045	3"	4 1/2" x 3" Oval	5" x 9"	15"	24"

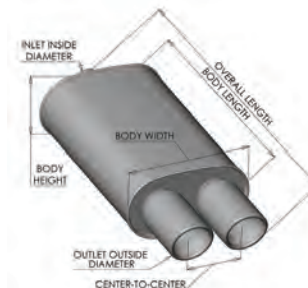

Exhaust Tip Detail: Double Wall, Angle Cut, Rolled Edge

Part No.	Inlet I.D.	Outlet O.D.	Center to Center	Muffler Body Height x Width	Body Length	Overall Length
1032	2 1/2"	Dual 3 1/2"	3 1/2"	5" x 9"	15"	24"
1043	3"	Dual 3 1/2"	3 1/2"	5" x 9"	15"	24"

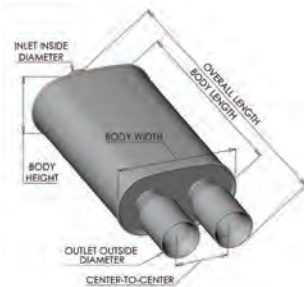

Exhaust Tip Detail: Double Wall, Straight Cut, Beveled Edge

Part No.	Inlet I.D.	Outlet O.D.	Center to Center	Muffler Body Height x Width	Body Length	Overall Length
1040	2 1/2"	Dual 3 1/2"	4 1/4"	5" x 9"	15"	24"
1047	3"	Dual 3 1/2"	4 1/4"	5" x 9"	15"	24"

# STAINLESS STEEL RESONATORS

## ULTRA QUIET DESIGN

Vibrant Performance Ultra Quiet Resonators are constructed from T304 Stainless Steel and features a “True Straight Through” perforated core that is surrounded by our premium multi-layer sound suppression materials. Ultra Quiet Resonators feature a larger sound chamber than our standard resonators to further reduce exhaust tone.



“True Straight Through”  
Stainless Steel perforated core



Part No.	Inlet / Outlet I.D.	Muffler Body Width x Height	Body Length	Overall Length
1140	2 1/4"	6 3/4" x 4 1/2"	10"	14"
1141	2 1/2"	6 3/4" x 4 1/2"	10"	14"
1142	3"	6 3/4" x 4 1/2"	10"	14"

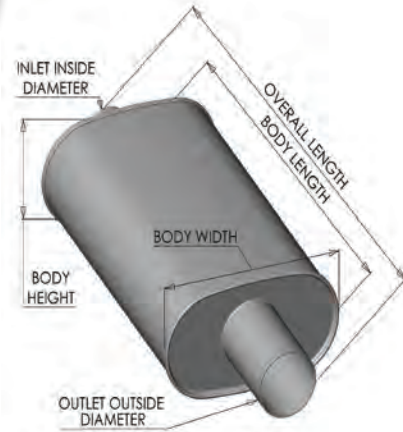

## STANDARD DESIGN

Vibrant Performance Resonators are constructed from T304 Stainless Steel and feature a “True Straight Through” perforated core for unrestricted exhaust flow while still noticeably reducing exhaust dB levels.



Part No.	Inlet / Outlet I.D.	Resonator O.D.	Overall Length
1790	2 1/4"	3 1/2"	12"
1791	2 1/4"	3 1/2"	18"
1792	2 1/2"	4"	12"
1793	2 1/2"	4"	18"
17930	2 1/2"	5"	18"
1794	3"	4"	12"
1795	3"	4"	18"
17950	3"	5"	18"
17970	3 1/2"	5"	18"
17960	4"	5"	18"

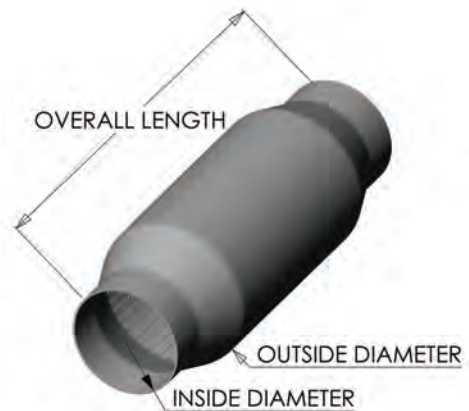

# STAINLESS STEEL RACE MUFFLERS

Vibrant Performance Race Mufflers are designed to comply with muffler requirement rules at race tracks throughout North America. Constructed from T304 Stainless Steel and fully tig welded, these mufflers are very lightweight, compact and offer excellent durability and corrosion resistance. These Race Mufflers feature a "True Straight Through" perforated core that is designed to reduce noise levels without performance loss.

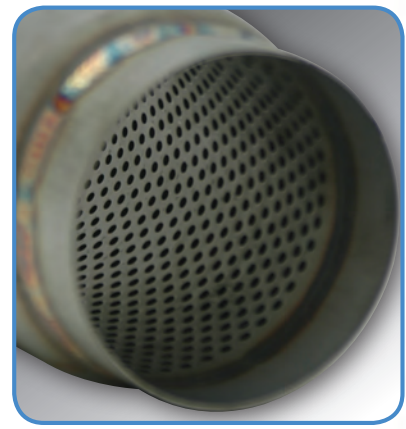

"True Straight Through"  
Stainless Steel perforated core



## 9" LONG RACE MUFFLERS

Part No.	Inlet/Outlet	Dimensions	Unit Weight
1769	3"	3 3/4" O.D. x 9" Long	1.7 lbs
1796	3 1/2"	4 1/4" O.D. x 9" Long	1.9 lbs
1797	4"	4 3/4" O.D. x 9" Long	2.2 lbs
1799	5"	5 3/4" O.D. x 9" Long	2.7 lbs

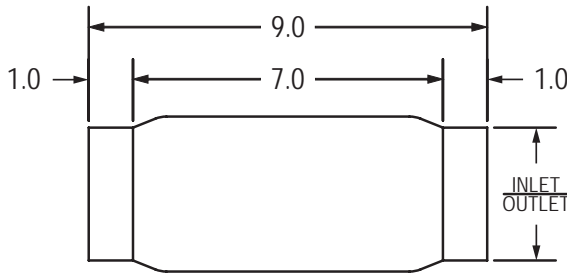

All dimensions in inches

## 5" LONG RACE MUFFLERS

Part No.	Inlet/Outlet	Dimensions	Unit Weight
17695	3"	3 1/2" O.D. x 5" Long	1.1 lbs
17965	3 1/2"	4 1/4" O.D. x 5" Long	1.2 lbs
17975	4"	4 3/4" O.D. x 5" Long	1.4 lbs
17985	4 1/2"	5 1/8" O.D. x 5" Long	1.6 lbs
17995	5"	5 3/4" O.D. x 5" Long	1.7 lbs

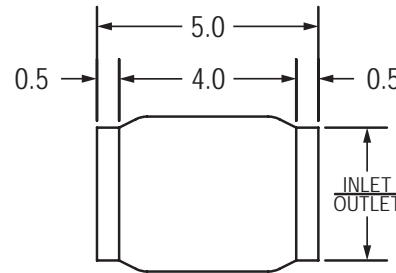

# LIGHTWEIGHT ALUMINUM MUFFLERS

Aluminum is quickly becoming the material of choice for Street Class racers and other performance enthusiasts who are looking to shave significant weight from their vehicle's exhaust system at a reasonable cost compared to other lightweight material options.

For those consumers, Vibrant offers our line of T6061 Aluminum Mufflers, with inlet/outlet sizes ranging from 2 1/2" to 4". These lightweight mufflers feature tig welded seams and our premium sound suppression packing materials wrapped around the large diameter "True Straight Through" internal perforated core.

Part No.	Inlet/Outlet	Dimensions	Unit Weight
12903	2 1/2"	5" O.D. x 14" Long	1.6 lbs
12900	3"	5" O.D. x 14" Long	1.7 lbs
12901	3 1/2"	5" O.D. x 14" Long	1.9 lbs
12902	4"	6" O.D. x 14" Long	2.4 lbs

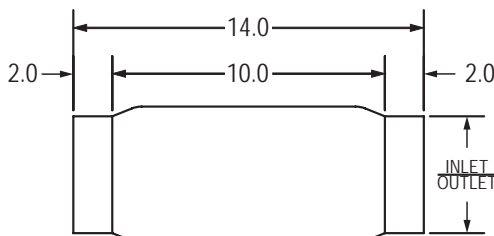

All dimensions in inches

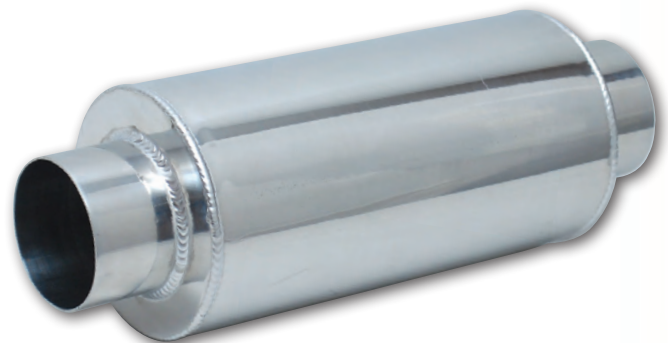

## STAINLESS STEEL EXHAUST TIPS

All Vibrant exhaust tips are made of T304 Stainless Steel for optimum corrosion resistance and then go through a three stage polishing process for a brilliant, mirror-like finish.

### ROUND EXHAUST TIPS (WELD-ON)

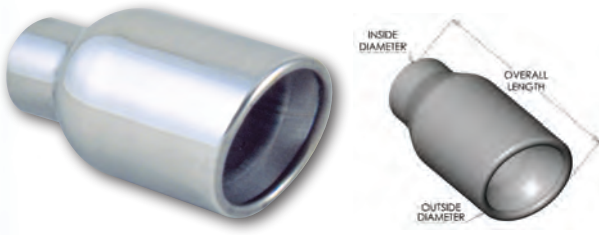

Part No.	Outlet O.D.	Inlet I.D.	Overall Length
1303	4"	2.25"	7.75"
1304	3.5"	2.25"	7.5"
1305	3"	2"	6.5"

Exhaust Tip Detail: Double Wall, Angle Cut, Rolled



Part No.	Outlet O.D.	Inlet I.D.	Overall Length
1207	4"	2.25"	7.75"
1226	3.5"	2.25"	7.5"
1209	3"	2"	6.5"

Exhaust Tip Detail: Double Wall, Angle Cut, Beveled

### OVAL EXHAUST TIPS (WELD-ON)

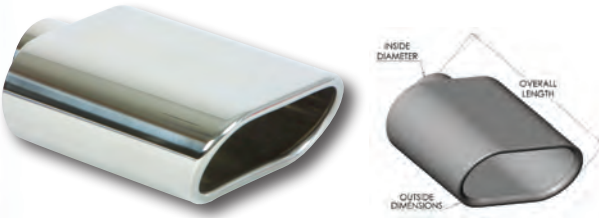

Part No.	Outlet Dim.	Inlet I.D.	Overall Length
1405	5.5" x 3"	2.25"	7.75"

Exhaust Tip Detail: Single Wall, Angle Cut, Rolled

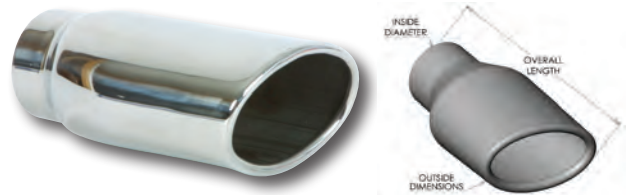

Part No.	Outlet Dim.	Inlet I.D.	Overall Length
1406	4.5" x 3"	2.5"	7.75"

Exhaust Tip Detail: Single Wall, Angle Cut, Rolled

### BOLT-ON EXHAUST TIPS

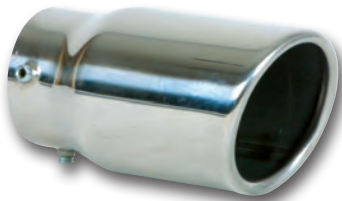

Part No.	Outlet O.D.	Inlet I.D.	Overall Length
1503	3"	Fits up to 2.25" O.D.	5.5"

Exhaust Tip Detail: Single Wall, Angle Cut, Rolled



Part No.	Outlet Dim.	Inlet I.D.	Overall Length
1504	3.25" x 2.75" (Oval)	Fits up to 2.25" O.D.	5"

Exhaust Tip Detail: Single Wall, Angle Cut, Rolled



Part No.	Outlet O.D.	Inlet I.D.	Overall Length
1505	2.5"	Fits up to 2" O.D.	5"

Exhaust Tip Detail: Single Wall, Angle Cut, Rolled

## DUAL OUTLET EXHAUST TIPS (WELD-ON)

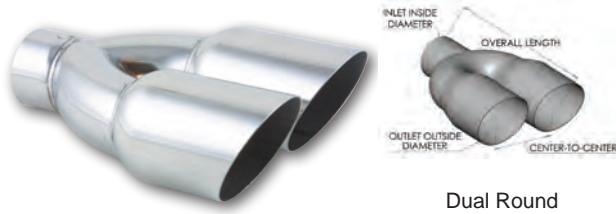

Dual Round

Part No.	Outlet O.D.	Center to Center	Inlet I.D.	Overall Length
1333	Dual 3.5"	4"	2.5"	10"

Exhaust Tip Detail: Single Wall, Angle Cut



Dual Round

Part No.	Outlet O.D.	Center to Center	Inlet I.D.	Overall Length
1329	Dual 3.5"	3.75"	2.25"	10"

Exhaust Tip Detail: Single Wall, Angle Cut, Rolled

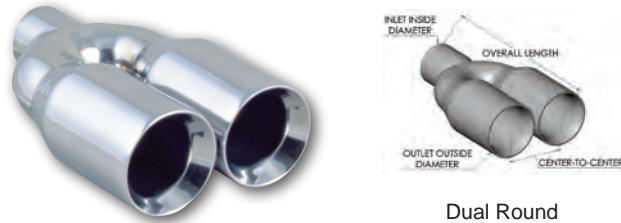

Dual Round

Part No.	Outlet O.D.	Center to Center	Inlet I.D.	Overall Length
1331	Dual 3.5"	3.75"	2.25"	10"

Exhaust Tip Detail: Double Wall, Straight Cut, Beveled

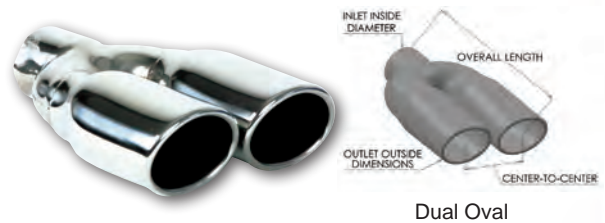

Dual Oval

Part No.	Outlet Dim.	Center to Center	Inlet I.D.	Overall Length
1335	Dual 3.25" x 2.25"	3.65"	2.25"	10"

Exhaust Tip Detail: Single Wall, Angle Cut, Rolled

## RECTANGULAR EXHAUST TIPS (WELD-ON)



Exhaust Tip Detail: Single Wall, Camaro Style

Part No.	Outlet Dim.	Inlet I.D.	Overall Length
1606	7.75" x 2"	2.5"	9.5"
1607	7.75" x 2"	2.25"	9.5"

## TRUCK / SUV EXHAUST TIPS (WELD -ON)



Part No.	Outlet O.D.	Inlet I.D.	Overall Length
1551	3"	2.5"	18"
1559	3"	2.5"	11"
1553	3"	2.25"	18"
1558	3"	2.25"	11"
1554	3.5"	2.5"	20"
1556	3.5"	3"	20"
1561	3.5"	3"	11"
1555	4"	2.5"	20"
1557	4"	3"	20"
1562	5"	4"	11"

Exhaust Tip Detail: Single Wall, 15° Angle Cut

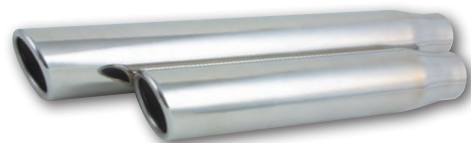

Part No.	Outlet O.D.	Inlet I.D.	Overall Length
1576	3"	2.5"	18"
1575	3"	2.5"	11"
1579	3.5"	2.5"	18"
1578	3.5"	3"	11"
1583	4"	2.5"	18"

Exhaust Tip Detail: Single Wall, 15° Angle Cut, Rolled

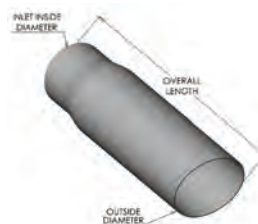

# STAINLESS STEEL HEADERS & CAT-BACK SYSTEMS



- Up to 20HP improvement vs. Stock
- Features a 2-1/2" outlet

Part No.	Application
2508	2006-2010 Honda Civic Si Coupe / Sedan



- Perfect for All-Motor race engines and supercharged applications
- Features 45mm O.D. equal length primaries that merge into a 4-1 Collector and exit through a 2-1/2" outlet

Part No.	Application
2509	J-SPEC 4-into-1 Race Header for Honda B-Series (B16 / B18 / B20)

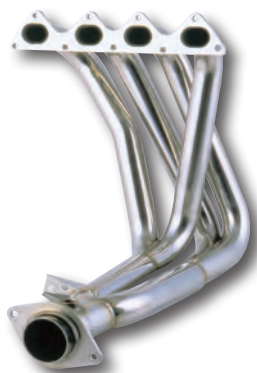

- Lightweight
- Produces superior low and mid-range power without sacrificing top end
- 45mm O.D. primaries merge into 2" Y-pipe and exits into a 2 1/2" outlet
- Outstanding Ground Clearance

Part No.	Application
2539	J-SPEC 4-2-1 Race Header for Honda B-Series (B16 / B18 / B20)

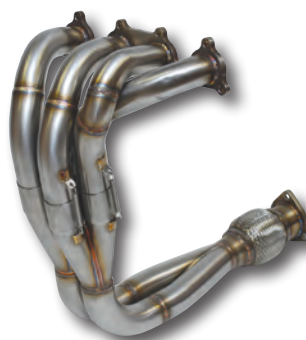

- Lightweight Two Piece Design
- Produces excellent power across RPM band
- 45mm O.D. primaries merge into 2" Y-pipe and exits through 2 1/2" outlet
- Outstanding Ground Clearance

Part No.	Application
2540	4-2-1 Race Header for Honda H22 Motors Bolts up to H22 equipped Honda Preludes and other vehicles with H22 swaps

PERFORMANCE EXHAUST SYSTEMS



## J-SPEC HEADER INSTALLATION KIT

The J-Spec Header Installation Kit simplified installing a Honda Header with a 2-1/2" diameter 2-bolt outlet.

This kit consists of a 2-bolt connecting flange (with a flared outlet neck) and a 2-1/2" I.D. Donut Style Graphite Gasket.

This flange kit will work with the OE Spring Bolts.

- Part #2599 – J-Spec Header Installation Kit (Flange and Gasket)**
- Part #2599B – Graphite Donut Gasket (2 1/2" I.D.), sold separately**

## SPRING BOLT SET FOR J-SPEC HEADER INSTALLATION KIT

**Part #2599S – 2-bolt Spring Bolt Kit for J-Spec Header installation kit.**

In the event of a Check Engine Light, consider using one of Vibrant's unique O2 sensor bungs (such as part #11620 and #11621), which may help eliminate this problem. Results may vary. Please refer to pages 76 for more information about these products.

- Features 45mm O.D. primaries that exit through a 2 1/2" outlet
- Bolts to stock exhaust with no modifications



Part No.	Application
12577	4-2-1 Race Header for 2002-2004 Acura RSX Type S

- Enjoy up to 10 HP improvement
- Comes with O2 Sensor Relocation Kit to avoid CEL

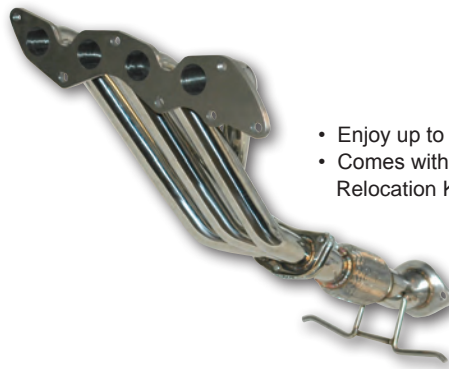

Part No.	Application
2541	4-2-1 Header for 2004-2008 Mazda 3 (2.0L)
2542	4-2-1 Header for 2004-2008 Mazda 3 (2.3L)



Part No.	Application	Tubing O.D.	Tip Size/Style
1622	2007-2010 Civic Si Sedan, 2.0L (Cat-Back Exhaust System)	63mm (2 1/2")	4" Round, angle cut
1626	2006-2010 Civic Si Coupe, 2.0L (Cat-Back Exhaust System)	63mm (2 1/2")	4" Round, angle cut

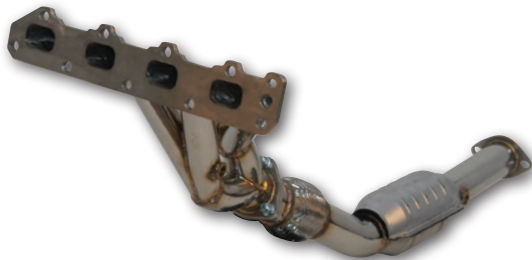

- Available with and without Catalytic Converter
- Features a large 2-1/2" diameter outlet
- Bolts up to stock exhaust without modification
- Combine with our STREETPOWER 3" Cat-Back Exhaust System to produce horsepower gains you can feel

Part No.	Application
2536	4-2-1 Header for 2005-2008 Chevrolet Cobalt SS/SC (includes Metal Catalytic Converter in Downpipe)
2543	4-2-1 Header for 2005-2008 Chevrolet Cobalt SS/SC (Cat Delete Version)

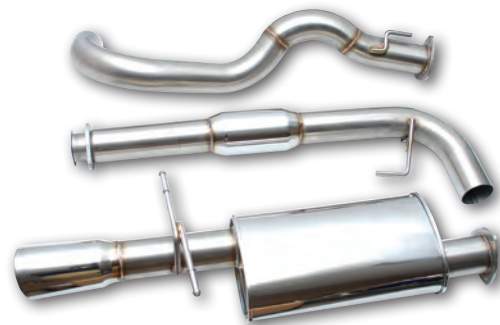

- Full 3" Cat-Back System
- Bolts up to OE Manifold and our Headers 2536 and 2543

Part No.	Application
1627	2005-2008 Cobalt SS Supercharged, 2.0L

#### TECH TIP

If installing header Part #2536, please ensure your vehicle's Air / Fuel ratio is no richer than 11.5:1. An overly rich Air / Fuel mixture can result in the premature failure of the Metallic Core Converter.

## ADJUSTABLE TIMING BELT TENSIONER

In the past, professional race teams have developed custom tensioner solutions to deal with excessive timing belt slack on B and H series Honda race motors. At high RPM, Honda timing belts will flap excessively, to the point where skipping one or more teeth on a cam gear is a definite possibility. This slight shift in cam gear positioning can cause just a simple loss in horsepower but the potential exists for major engine damage if it results in engine valves crashing into the pistons.

Protect your high revving Honda B or H series motor by installing a Vibrant Performance Timing Belt Tensioner. Vibrant Tensioners are CNC machined from T6061 Billet Aluminum, making them lightweight yet very durable. The pulleys feature a special coating to prevent premature wear and tear due to friction from the belt. Completely adjustable (both vertically and horizontally) and easy to install because they bolt up directly to the stock Honda block (requires the removal or relocation of the factory power steering pump).

Part No.	Application
12690	Fits Honda B-Series Block (Anodized Silver)
12690K	Fits Honda B-Series Block (Anodized Black)
12691K	Fits Honda H-Series Block (Anodized Black)

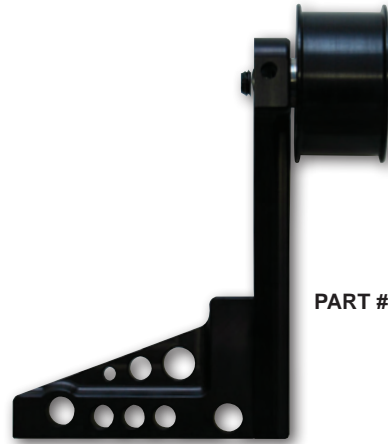
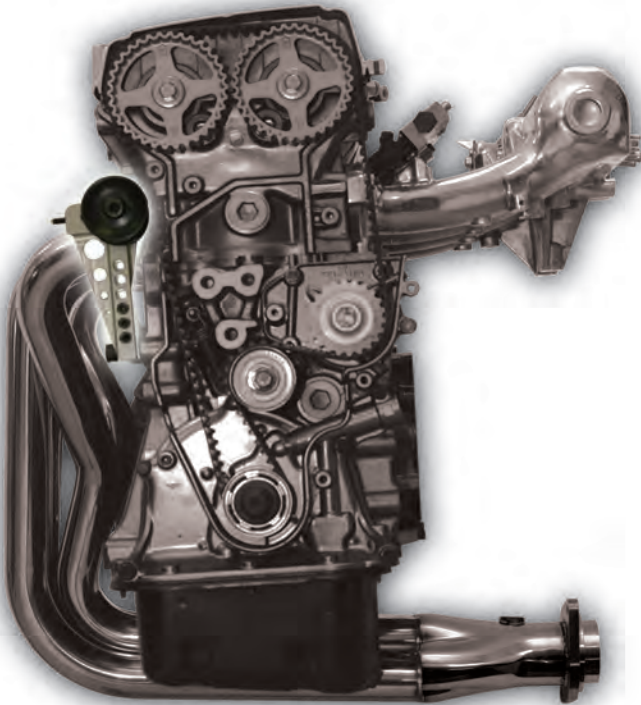

PART # 12690K

HONDA B-SERIES BLOCK



PART # 12691K

HONDA H-SERIES BLOCK

## CARBON FIBER SHIFT KNOB



- Real Carbon Fiber. Weighs 3oz
- Features a unique 3-stage thread pattern allowing it to securely thread onto all 8mm, 10mm and 12mm shifters
- For manual transmission only

Part No. 2032



# VIBRANT MERCHANDISE

## AUTHORIZED DEALER KIT

The Vibrant Performance Authorized Dealer Kit includes the following:

- 4ft x 2ft Store Banner
- 2014 Catalog (2 copies)
- Vibrant Performance T-shirt
- Authorized Dealer Vinyl Decal
- Vibrant Performance 4 Fold Brochure
- Fuse 4 Fold Brochure
- Vibrant Performance Brochure Holder
- Fuse Brochure Holder

Part No. 2959



4ft x 2ft Store Banner



Black T-Shirt



Vinyl Decal



2014 Catalog

## VIBRANT PERFORMANCE APPAREL

### VIBRANT T-SHIRT



- Item # 2931M (Medium)
- Item # 2931L (Large)
- Item # 2931X (Extra Large)
- Item # 2931Z (2XL)

### VIBRANT BASEBALL HAT



Item # 2938L

### LICENSE PLATE FRAME



Item # 2960

### STICKERS

Vibrant Performance Die Cut Vinyl Sticker  
Size: 6" w x 2 1/4" h  
Available in two colors: Black and White



MISCELLANEOUS

# INDEX

## A

Accuseal Exhaust Clamps by Torca® ...75  
Acoustic Shields by DCI ...57  
Adapter Fittings, AN and NPT ...45-51  
Adapters, Mass Airflow Sensor (MAF) ...21  
Adhesive Tape, Clean Cut, for Braided Hoses ...53  
Adjustable AN Wrench ...53  
Adjustable Timing Belt Tensioner ...88  
Air Filters, Performance ...22-23  
Air to Air Intercoolers ...11  
Aluminum AN Wrenches ...53  
Aluminum Bellmouth Velocity Stacks ...22  
Aluminum Block Off Plate ...27  
Aluminum Boost Brace ...14  
Aluminum Catch Cans ...55  
Aluminum Check Valves, One-Way ...49, 76  
Aluminum Crush Washers ...53  
Aluminum Elbows, Cast ...10  
Aluminum Hose End Fittings ...42-43  
Aluminum Joiners ...10  
Aluminum Mufflers ...83  
Aluminum Oil Drain Flanges ...39  
Aluminum Oil Feed Flanges ...38  
Aluminum Thread-On Vacuum Scavenger ...55  
Aluminum Mandrel Bent Tubing ...8-9  
Aluminum Radiator Filler Neck, Weld-On ...53  
Aluminum Straight Tubing ...9  
Aluminum Tape ...57  
Aluminum Transitions ...9  
Aluminum Vacuum Fittings ...24-25  
Aluminum Vacuum Manifolds ...24  
Aluminum V-Band Flange Assemblies ...73  
Aluminum Water Jacket Adapter Fittings ...38  
AN Weld Bungs, Male and Female, Mild Steel & Aluminum ...54  
AN Wrenches ...53  
Aramid, Multi-ply Reinforced Silicone Connectors ...18

## B

Bead Roller, Manual ...10  
Bellmouth Velocity Stacks, Aluminum ...22  
Bellows Assemblies, Stainless Steel ...68  
Bends, Mandrel, Aluminum ...8-9  
Bends, Mandrel, Stainless Steel, Oval Tubing ...61  
Bends, Mandrel, Stainless Steel, Round Tubing ...62-65  
Billet Aluminum Line Separators ...52  
Billet Aluminum One-Way Check Valves ...49  
Billet Aluminum Quick Release Fittings ...49  
Billet Aluminum Vice Jaws ...53  
Block Off Plate, Aluminum ...27  
Blow-Off Valve Flange Assemblies ...27  
Bolt-On Exhaust Tips ...84  
Bolt, Spring, Kits ...78  
Bolts, Stainless Steel, M10 ...78  
Boost Brace ...14  
Boost Controller, Manual ...26  
Brackets, Intercooler, Stainless Steel ...11  
Bracket, Wall Mount, Steel ...62  
Braided Flexible Race Hoses, Stainless Steel ...40  
Braided Flexible Race Hoses, Black Nylon ...41  
Brass Olive Inserts for Tube Adapters ...50  
Breather Filters, Crankcase ...23  
Bungs, Weld-On, Large Diameter, with Thread-On Caps ...54  
Bungs, Weld-On, Male and Female, AN & NPT ...54  
Bulk Hose Packs, Silicone Vacuum Lines ...20  
Bulkhead Adapter Fittings, Aluminum ...46  
Bulkhead Nuts, Aluminum ...46

## C

Cable Ties, Stainless Steel ...58  
Carbon Fiber Shift Knob, Manual Transmission ...88  
Cast Aluminum Elbows ... 10  
Cat-Back Exhaust Systems ...87  
Catalytic Converters, Ceramic Core, OBD1 ...70  
Catalytic Converters, Ceramic Core, OBD2 ...71  
Catalytic Converters, GESi High Output & Ultra High Output ...71  
Catalytic Converters, Metal Core, OBD1...70  
Catalytic Converters, Metal Core, OBD2 ...71  
Catch Can Filter Kit ...55  
Catch Cans, Universal ...55  
Check Valve, One Way, Aluminum ...49, 76  
Chevrolet, Header and Cat-Back System ...87  
Clamps, Exhaust ...75  
Clamps, Fuel Injector Style, Zinc Plated Mild Steel ...52  
Clamps, P-Style, Stainless Steel, Rubber Cushioned ...52  
Clamps, Pinch Style, Stainless Steel ...52  
Clamps, T-Bolt, Stainless Steel ...19  
Clamps, Torca®, Accuseal, Easy Seal & TC Series ...75  
Clamps, V-Band, Stainless Steel ...73  
Clamps, Worm Gear, Stainless Steel ...19  
Clamps, VANJEN ...12-13  
Classic Air Filters, for Bellmouth Velocity Stacks ...22  
Classic Air Filters, for Turbo Inlets ...23  
Classic Air Filters, Standard Design ...23  
Clean Cut Adhesive Tape for Flex Hoses ...53  
Clips, Exhaust Hanger Rod ...78  
Collector Tabs, Weld-On ...67  
Collectors, Merge, 4-into-1 and 2-into-1 ...29, 66-67  
Compressor Inlet and Outlet Flanges, Turbo ...37  
Concentric Reducers, Stainless Steel ...65  
Connectors, Aramid Reinforced Silicone ...18  
Connectors, Standard Reinforced Silicone ...14-17  
Couplings, Stainless Steel Flexible ...68-69  
Cushioned P-Clamps, Stainless Steel ...52  
Crankcase Breather Filters ...23  
Crush Washers, Aluminum ...53

## D

DCI Heat and Accoustic Shielding ...56-57  
Discharge / Downpipe Flanges, Turbo ...34-37  
Donut Style Exhaust Gaskets ...75  
Double Slip Joint Fittings, Stainless Steel ...67

## E

Easy Mount Intercooler Brackets, Stainless Steel ...11  
EFI Adapter Fittings ...51  
EGT Sensor Fitting, Stainless Steel ...77  
EGT Sensor Fitting Threaded Plug, Mild Steel ...77  
Elbows, Aluminum, Mandrel Bent ...8-9  
Elbows, Cast Aluminum ...10  
Elbows, Schedule 10, Stainless Steel ...28  
Elbows, Silicone, 90 deg, Non-Reinforced ...18  
Elbows, Silicone, 45 deg. and 90 deg, Reinforced ...17  
Elbows, Stainless Steel, Mandrel Bent ...61-65  
Electric Pumps for Windshield Washer Bottles ...59  
Engine Mount Heat Shield, Universal ...57  
E-Vac Scavenger Fittings ...76  
Exhaust Clamps by Torca® ...75  
Exhaust Flanges, 2-Bolt & 3-Bolt, Round, Stainless Steel ...74  
Exhaust Flanges, 4-bolt, Oval, Stainless Steel ...61  
Exhaust Flanges, Manifold, Stainless Steel & Mild Steel ...60  
Exhaust Gaskets, 2-Bolt & 3 Bolt, Graphite ...74  
Exhaust Gaskets, Donut Style ...75  
Exhaust Hanger Rod Clips ...78  
Exhaust Headers, Stainless Steel ...86-87  
Exhaust Manifolds ...86-87  
Exhaust Systems, Cat-Back ...87  
Exhaust Tips, Stainless Steel, Weld-On & Bolt-On ...84-85  
External Wastegate Flanges ...32-33  
ExtremeShield Flexible Tubing, Hose Protection ...58

## F

Fasteners, Stainless Steel ...78

Fittings, Adapter, Aluminum ...45-51

Fittings, Check Valve ...49, 76

Fittings, EGT Sensor ...77

Fittings, E-Vac Scavenger ...76

Fittings, Hose Barb Adapters ...49

Fittings, Hose End, Swivel, Aluminum ...42-43

Fittings, Oil Restrictor ...38

Fittings, Oxygen Sensor ...76-77

Fittings, Pneumatic One-Touch Vacuum ...25

Fitting, Push-On Hose End, Aluminum ...44

Fittings, Vacuum, Aluminum ...24-25

Filters, Air, High Performance ...22-23

Filters, Catch Can ...55

Filters, Crankcase Breather ...23

Flanges, Blow Off Valve ...27

Flanges, Compressor Inlet and Outlet ...37

Flanges, Exhaust, 2 Bolt & 3 Bolt, Stainless Steel ...74

Flanges, Exhaust Manifold, Stainless Steel & Mild Steel ...60

Flanges, External Wastegate ...32-33

Flanges, Oil Drain, Aluminum ...39

Flanges, Oil Feed, Aluminum ...38

Flanges, Turbo Discharge ...34-37

Flanges, Turbo Inlet ...30-31

Flanges, V-Band, Aluminum and Stainless Steel ...72-73

Flat Black Universal Mufflers, Stainless Steel ...80

Flexible Couplings, Stainless Steel ...68-69

Flexible Hose Sleeving, Heat Protect ...58

Flexible Interlock Hose, Stainless Steel ...33

Flexible Race Hoses, Braided, Stainless Steel & Nylon ...40-41

Flexible Race Hoses, Rubber Push-On Style ...44

Flexible Split Sleeving, Hose Protection ...58

Flexible Tubing, ExtremeShield 1200 & ExtremeShield 1400...58

FKM Rubber O-Rings for Aluminum Adapter Fittings ...53

FKM Rubber O-Rings for Aluminum V-Band Flanges ...73

Fuel Cell Bulkhead Adapter Fittings, Aluminum ...51

Fuel Injector Style Mini Hose Clamps ...52

FUSE Wire ...6-7

## G

GESI High Performance Catalytic Converters ...71

Graphite Gaskets, 2 Bolt and 3 Bolt style ...74

Graphite Gaskets, Donut Style ...75

## H

Hanger Rod Clips, Exhaust ...78

Hanger Rods, Stainless Steel ...78

Hard Lines, Aluminum and Stainless Steel ...50

Hard Line Tube Adapter Fittings ...50

Headers, Exhaust, Stainless Steel ...86-87

Heat Protect Flexible Sleeving ...58

Heat and Acoustic Shields by DCI ...56-57

Heater Hoses, Silicone ...20

Hex Bolts, Threaded Plug for O2 Sensors, Mild Steel ...77

High Performance Catalytic Converters by GESI ...71

High Temperature Vacuum Line Kits ...25

Honda, Headers and Cat-Back Systems ...86-87

Hoses, Flexible Braided Race, Stainless Steel & Nylon ...40-41

Hoses, Flexible Rubber, Push-On Style ...44

Hose, Interlock, Stainless Steel ...33

Hose, Polyethylene Vacuum ...25

Hose, PTFE Vacuum ...25

Hose, Silicone Vacuum ...20

Hose Barb Adapter Fittings ...49

Hose Clamps, Small Diameter ...52

Hose Clamps, T-Bolt, Stainless Steel ...19

Hose Clamps, Worm Gear, Stainless Steel ...19

Hose Cutting Shears ...52

Hose End Fittings, Male AN to Hose ...43

Hose End Fittings, Male NPT to Hose ...43

Hose End Fittings, Push-On Style, Aluminum ...44

Hose End Fittings, Swivel, Aluminum ...42

Hose End Sockets ...42

Hose Protection Solutions ...58

Hump Hose, Silicone, 4-Ply Reinforced ...16

Hump Hose, Silicone, with Reinforcement Rings ...18

## I

Inlet Flanges, Turbo ...30-31  
Inner Silencer, Stainless Steel ...78  
Inner Support Spring for Flexible Race Hoses ...40  
Intercoolers, Air to Air ...11  
Interlock Hose, Stainless Steel ...33

## J

J Style Oxygen Sensor Fitting ...76-77  
Joiners, Aluminum ...10

## L

Large Diameter Weld Bungs ...42  
Line Separators, Billet Aluminum ...52

## M

Mandrel Bends, Aluminum ...8-9  
Mandrel Bends, Stainless Steel ...61-65  
Manifold Flanges, Exhaust, Stainless and Mild Steel ...60  
Manifold, Vacuum, Aluminum ...24  
Manual Bead Roller ...10  
Manual Boost Controller ...26  
Manual Transmission Shift Knob, Carbon Fiber ...88  
Mass Air Flow Sensor Adapters ...21  
Merge Collectors, Stainless Steel ...29, 66-67  
Metal Core Catalytic Converter, OBD1 ...70  
Metric to AN Adapter Fittings, Aluminum ...47  
Mini Hose Clamps, Fuel Injector Style ...52  
Mufflers, Aluminum ...83  
Mufflers, Flat Black, Stainless Steel ...80  
Mufflers, Race, Stainless Steel ...83  
Mufflers, StreetPower Universal With Tips, Stainless Steel ...81  
Mufflers, StreetPower Universal Without Tips, Stainless Steel ...79  
Mufflers, TPV, Stainless Steel ...80

## N

Nickel Plated Brass One Touch Vacuum Fittings ...25  
Non Reinforced Silicone Couplings ...18  
NPT Weld Bungs, Female, Aluminum and Mild Steel ...54  
Nylon Braided Flexible Race Hoses ...41

## O

OBD1 High Flow Catalytic Converters ...70  
OBD2 High Flow Catalytic Converters by GESi...71  
Oil Drain Kits, Universal ...38  
Oil Drain Flanges, Aluminum ...38  
Oil Feed Flanges, Aluminum ...38  
Oil Feed Kits, Universal ...38  
Oil Restrictor Fittings ...38  
One-Touch Pneumatic Vacuum Fittings ...25  
O-Rings, FKM Rubber, for Aluminum Adapter Fittings ...53  
O-Rings, FKM Rubber, for Aluminum V-Band Flanges ...73  
Oval Mandrel Bends and Straight Tubing, Stainless Steel ...61  
Oval to Round Transitions, Stainless Steel ...61  
Oval Exhaust Flanges, Stainless Steel ...61  
Oxygen Sensor Fittings ...76-77  
Oxygen Sensor Restrictor Fitting ...76  
Oxygen Sensor Socket Tool ...77

## P

P-Clamps, Rubber Cushioned, Stainless Steel ...52  
Pinch Clamps, Stainless Steel ...52  
Pipe, Schedule 10 Stainless Steel ...28  
Pipe Adapters, NPT, Aluminum ...48  
Pit Packs, Silicone Vacuum Hose ...20  
Plug for EGT Sensor Fitting, Zinc Plated Mild Steel ...77  
Pneumatic One Touch Vacuum Fittings ...25  
Polyethylene Vacuum Hose Lines ...25  
Preformed Turbo Shields ...57  
PTFE Vacuum Hose Lines ...25  
Push On Hose End Fittings, Aluminum ...44  
Push On Style Rubber Flex Hoses ...44

## Q

Quick Release Boost Brace, Aluminum ...14  
Quick Release Fitting, Billet Aluminum ...49

## R

Race Hoses, Braided, Nylon ...41  
Race Hoses, Braided, Stainless Steel ...40  
Race Mufflers, Stainless Steel ...83  
Radiator Filler Necks, Weld-On, Aluminum ...53  
Reducers, Silicone, Reinforced ...16  
Reducers, Silicone, Non-Reinforced ...18  
Reducers, Stainless Steel ...65  
Reinforced Silicone Connectors, Aramid ...18  
Reinforced Silicone Connectors ...14-17  
Replacement Windshield Washer Bottle Kits ...59  
Resonators, Stainless Steel ...82  
Resonators, Ultra Quiet ...82  
Restrictor Fitting, Oxygen Sensor ...76  
Restrictor Fittings, Oil ...38  
Rods, Exhaust Hanger, Stainless Steel ...78  
Rubber O-Rings, FKM Material, for Aluminum Fittings ...53  
Rubber O-Rings, FKM Material, for Aluminum V-Band Flanges ...73

## S

Saddle Style Oxygen Sensor Fittings ...77  
Scavengers, E-Vac ...76  
Schedule 10 Stainless Steel Pipes ...28  
Sensor Adapter, MAF ...21  
Sensor Fitting, EGT ...77  
Sensor Fittings, Oxygen ...76-77  
Shears, Hose Cutting ...52  
Shields, Heat and Acoustic ...56-57  
Shield, Turbo ...57  
Shift Knob, Carbon Fiber, Manual Transmission ...88  
Silencer, Inner ...78  
Silicone Connectors, Non-Reinforced ...18  
Silicone Connectors, Reinforced ...14-18  
Silicone Elbows, 45 and 90 degree, reinforced ...17  
Silicone Heater Hoses ...20  
Silicone Hump Hose Connectors ...16  
Silicone Transition Hose Connectors, Non-Reinforced ...18  
Silicone Transition Hose Connectors, Reinforced ...16

Silicone Vacuum Hoses ...20  
Sleeve Clamps, Exhaust ...75  
Sleeving, Heat Protect, Flexible ...58  
Spark Plug Boot Insulator ...58  
Split Sleeving, Flexible ...58  
Spring Bolt Kits ...78  
Stainless Steel Bellows Assemblies ...68  
Stainless Steel Braided Flex Hoses ...40  
Stainless Steel Cable Ties ...58  
Stainless Steel Double Slip Joint Fittings ...67  
Stainless Steel Exhaust Flanges, 2 Bolt and 3 Bolt ...74  
Stainless Steel Exhaust Headers ...86-87  
Stainless Steel Exhaust Tips ...84-85  
Stainless Steel Fasteners ...78  
Stainless Steel Flexible Couplings ...68-69  
Stainless Steel Flexible Interlock Hose ...33  
Stainless Steel Hanger Rods ...75  
Stainless Steel Mandrel Bends ...61-65  
Stainless Steel Merge Collectors ...29, 66-67  
Stainless Steel Pinch Clamps ...52  
Stainless Steel Race Mufflers ...83  
Stainless Steel Reducers ...65  
Stainless Steel Resonators ...82  
Stainless Steel Straight Tubing ...65  
Stainless Steel T-Bolt Clamps ...19  
Stainless Steel TPV Mufflers ...80  
Stainless Steel StreetPower Universal Mufflers With Tips ...81  
Stainless Steel StreetPower Universal Mufflers W/O Tips ...79  
Stainless Steel V-Band Flange Sets ...72  
Stainless Steel Worm Gear Clamps ...19  
Starter Motor Heat Shield Kit ...57  
Straight Pipe, Schedule 10, Stainless Steel ...28  
Straight Tubing, Aluminum ...9  
Straight Tubing, Stainless Steel ...65  
Support Springs for Flexible Race Hoses ...40  
Swivel Style Hose End Fittings, Aluminum ...42

## T

Tape, Aluminum ...57  
T-Bolt Clamps, Stainless Steel ...19  
TC Series Exhaust Clamps by Torca® ...75  
TD04 Block Off Flange ...27  
Tee Fittings, Aluminum Adapter, AN and NPT ...46  
Tee Pipe, Schedule 10, Stainless Steel ...28  
Ties, Cable, Stainless Steel ...58  
TIG Weld Wire ...65  
Tight Radius Cast Aluminum Elbows ...10  
Timing Belt Tensioner, Adjustable ...88  
Tips, Exhaust ...84-85  
TPV Universal Mufflers, Stainless Steel ...80  
Transitions, Aluminum ...9  
Transition, Oval to Round, Stainless Steel ...61  
Tubing, Aluminum ...8-9  
Tubing, Polyethylene ...25  
Tubing, PTFE ...25  
Tubing, Stainless Steel Mandrel Bends ...61-65  
Tubing, Stainless Steel, Straight ...65  
Turbo Flanges, Compressor Inlet and Outlet ...37  
Turbo Flanges, Discharge ...34-37  
Turbo Flanges, Inlet ...30-31  
Turbo Flex Coupling with Interlock Liner, Stainless Steel ...68  
Turbo Manifold Merge Collectors ...29  
Turbo Heat Shield, Preformed ...57

## U

U-J Mandrel Bends, Stainless Steel and Mild Steel ...62  
Ultra Quiet Resonators ...82  
Universal Catch Cans ...55  
Universal Ceramic Core Catalytic Converter, OBD1 ...70  
Universal Ceramic Core Catalytic Converter, OBD2 ...71  
Universal Metal Core Catalytic Converter, OBD1 ...70  
Universal Metal Core Catalytic Converter, OBD2 ...71  
Universal Mufflers, Flat Black ...80  
Universal Mufflers, Stainless Steel With Tips ...81  
Universal Mufflers, Stainless Steel, Without Tips ...79  
Universal Oil Drain/Return Kits ...38  
Universal Oil Feed Kits ...38  
Universal TPV Mufflers, Stainless Steel ...80

## V

Vacuum Fittings, Pneumatic One -Touch ...25  
Vacuum Hoses, Silicone ...20  
Vacuum Hoses, Polyethylene and PTFE ...25  
Vacuum Line Fittings, Aluminum ...24  
Vacuum Line Kits, High Temperature ...25  
Vacuum Manifold, Aluminum ...24  
Vacuum Scavenger, Aluminum Thread On ...55  
Valves, One Way Check, Aluminum ...49, 76  
VANJEN Clamping System ...12-13  
V-Band Flange Assemblies, Aluminum ...73  
V-Band Flange Assemblies, Stainless Steel ...72  
V-Band Clamps, Stainless Steel ...73  
Velocity Stacks, Bellmouth, Aluminum ...22  
Vibrant Shift Knob, Manual Transmission ...88  
Vise Jaws, Billet Aluminum ...53

## W

Wall Mount Bracket ...62  
Washers, Aluminum Crush ...53  
Wastegate Flanges ...32-33  
Water Jacket Adapter Fittings, Aluminum ...38  
Weld Bungs, AN and NPT, Male and Female ...54  
Weld Bungs, Large Diameter ...54  
Weld On Collector Tab Set ...67  
Weld-On Flange Assemblies for Blow Off Valves ...27  
Weld Wire, TIG ...65  
Windshield Washer Bottle Replacement Kits ...59  
Wire, FUSE ...6-7  
Worm Gear Clamps, Stainless Steel ...19  
Wrenches, Aluminum AN ...53

## Y

Y-Fittings, Aluminum Adapters, AN and NPT ...51